



FCC RADIO TEST REPORT

FCC ID : PKRISGFX31001
Equipment : Indoor Router
Brand Name : Inseego
Model Name : FX3100-1
Marketing Name : FX3100
Applicant : Inseego Corp.
 9710 Scranton Road Suite 200, San Diego, CA 92121
Manufacturer : Inseego Corp.
 9710 Scranton Road Suite 200, San Diego, CA 92121
Standard : FCC 47 CFR Part 2, 22(H), 24(E), 27

The product was received on Mar. 03, 2023 and testing was performed from Mar. 03, 2023 to Apr. 06, 2023. We, Sporton International Inc. EMC & Wireless Communications Laboratory, would like to declare that the tested sample has been evaluated in accordance with the test procedures given in ANSI / TIA-603-E and has been in compliance with the applicable technical standards.

The test results in this partial report apply exclusively to the tested model / sample. Without written approval from Sporton International Inc. EMC & Wireless Communications Laboratory, the test report shall not be reproduced except in full.

Louis Wu

Approved by: Louis Wu
Sporton International Inc. EMC & Wireless Communications Laboratory
 No. 52, Huaya 1st Rd., Guishan Dist., Taoyuan City 333, Taiwan (R.O.C.)



Table of Contents

History of this test report..... 3

Summary of Test Result..... 4

1 General Description 6

 1.1 Product Feature of Equipment Under Test..... 6

 1.2 Modification of EUT 6

 1.3 Testing Location 7

 1.4 Applicable Standards..... 7

2 Test Configuration of Equipment Under Test 8

 2.1 Test Mode..... 8

 2.2 Connection Diagram of Test System..... 11

 2.3 Support Unit used in test configuration and system 11

 2.4 Measurement Results Explanation Example..... 11

 2.5 Frequency List of Low/Middle/High Channels 12

3 Conducted Test Items..... 18

 3.1 Measuring Instruments 18

 3.2 Conducted Output Power and ERP/EIRP 19

 3.3 Peak-to-Average Ratio 20

 3.4 Occupied Bandwidth..... 21

 3.5 Conducted Band Edge 22

 3.6 Conducted Spurious Emission 24

 3.7 Frequency Stability 25

4 Radiated Test Items 26

 4.1 Measuring Instruments 26

 4.2 Radiated Spurious Emission Measurement 28

5 List of Measuring Equipment..... 29

6 Uncertainty of Evaluation..... 30

Appendix A. Test Results of Conducted Test

Appendix B. Test Results of Radiated Test

Appendix C. Test Setup Photographs



History of this test report

Report No.	Version	Description	Issue Date
FG290606B	01	Initial issue of report	Apr. 18, 2023
FG290606B	02	<ol style="list-style-type: none">1. Revise Summary of Test Result, Section 1.1 and Section 2.5.2. This report is an updated version, replacing the report issued on Apr. 18, 2023.	Apr. 21, 2023
FG290606B	03	<ol style="list-style-type: none">1. Revise Summary of Test Result and Section 2.1.2. This report is an updated version, replacing the report issued on Apr. 21, 2023.	Apr. 24, 2023



Summary of Test Result

Report Clause	Ref Std. Clause	Test Items	Result (PASS/FAIL)	Remark
3.2	§2.1046	Conducted Output Power	Reporting only	-
	§22.913 (a)(5)	Effective Radiated Power (n5) (n26)	Pass	
	§27.50 (c)(10)	Effective Radiated Power (n12) (n71)		
	§24.232 (c) §27.50 (h)(2)	Equivalent Isotropic Radiated Power (n2) (n25) (n7) (n38) (n41)		
	§27.50 (d)(4)	Equivalent Isotropic Radiated Power (n66)		
3.3	§24.232 (d) §27.50 (d)(5)	Peak-to-Average Ratio	Pass	-
3.4	§2.1049	Occupied Bandwidth	Reporting only	-
3.5	§2.1051 §22.917 (a) §24.238 (a) §27.53 (g) §27.53 (h)	Conducted Band Edge Measurement (n12) (n25)	Pass	-
	§2.1051 §27.53 (m)(4)	Conducted Band Edge Measurement (n38)		
3.6	§2.1051 §22.917 (a) §24.238 (a) §27.53 (g) §27.53 (h)	Conducted Spurious Emission (n12) (n25)	Pass	-
	§2.1051 §27.53 (m)(4)	Conducted Spurious Emission (n38)		
3.7	§2.1055 §22.355 §24.235 §27.54	Frequency Stability Temperature & Voltage	Pass	-



Report Clause	Ref Std. Clause	Test Items	Result (PASS/FAIL)	Remark
4.2	§2.1053 §22.917 (a) §24.238 (a) §27.53 (g) §27.53 (h)	Radiated Spurious Emission (n2) (n5) (n12) (n25) (n26) (n66) (n71)	Pass	8.80 dB under the limit at 7752.000 MHz
	§2.1051 §27.53 (m)(4)	Radiated Spurious Emission (n7) (n38) (n41)		

Note: In FCC ID PKRISGM3000B and PKRISGFX31001, the RF circuit and output power level of the WWAN function are the same, except 5GNR operating in n12 and n38 frequency bands, and n25 operating in 25MHz bandwidth are full tested in this report are carrying out. The other frequency bands are verified through RF output power and spurious emission test data.

Conformity Assessment Condition:
1. The test results (PASS/FAIL) with all measurement uncertainty excluded are presented against the regulation limits or in accordance with the requirements stipulated by the applicant/manufacture who shall bear all the risks of non-compliance that may potentially occur if measurement uncertainty is taken into account.
2. Please refer to the section " Uncertainty of Evaluation " for measurement uncertainty.
Disclaimer:
The product specifications of the EUT presented in the test report that may affect the test assessments are declared by the manufacturer who shall take full responsibility for the authenticity.

Reviewed by: Lewis Ho

Report Producer: Michelle Chen



1 General Description

1.1 Product Feature of Equipment Under Test

Product Feature	
General Specs 4G-LTE, 5G-FR1, Wi-Fi 2.4GHz 802.11 b/g/n/ax, Wi-Fi 5GHz 802.11 a/n/ac/ax, and GNSS.	
Antenna Type WWAN: Fixed Internal Antenna WLAN: Fixed Internal Antenna GPS / Glonass / BDS / Galileo: Fixed Internal Antenna	
Antenna Gain	<p><Ant. 0>: 5G FR1 n2: 1.6 dBi 5G FR1 n5: 0.8 dBi 5G FR1 n7: 0.6 dBi 5G FR1 n12: -0.1 dBi 5G FR1 n25: 1.6 dBi 5G FR1 n26: 0.8 dBi 5G FR1 n38: 0.4 dBi 5G FR1 n41: 1.5 dBi 5G FR1 n66: 1.8 dBi 5G FR1 n71: 1.0 dBi</p> <p><Ant. 1>: 5G FR1 n5: 0.5 dBi</p> <p><Ant. 3>: 5G FR1 n41: 1.4 dBi</p> <p><Ant. 8>: 5G FR1 n2: 1.7 dBi 5G FR1 n25: 1.7 dBi 5G FR1 n38: 2.8 dBi 5G FR1 n41: 2.8 dBi 5G FR1 n66: 1.3 dBi</p>

Remark: The EUT's information above is declared by manufacturer. Please refer to Disclaimer in report summary.

1.2 Modification of EUT

No modifications made to the EUT during the testing.



1.3 Testing Location

Test Site	Sporton International Inc. EMC & Wireless Communications Laboratory	
Test Site Location	No.52, Huaya 1st Rd., Guishan Dist., Taoyuan City 333, Taiwan (R.O.C.) TEL: +886-3-327-3456 FAX: +886-3-328-4978	
Test Site No.	Sporton Site No.	
	TH03-HY	03CH07-HY
Test Engineer	Sherry Wu	Jesse Wang, Stan Hsieh and Ken Wu
Temperature (°C)	20.0~24.0	21.0~25.6
Relative Humidity (%)	50.0~58.0	54.7~66.2

Note: The test site complies with ANSI C63.4 2014 requirement.

FCC Designation No.: TW1190

1.4 Applicable Standards

According to the specifications declared by the manufacturer, the EUT must comply with the requirements of the following standards:

- ♦ ANSI C63.26-2015
- ♦ ANSI / TIA-603-E
- ♦ FCC 47 CFR Part 2, 22(H), 24(E), 27
- ♦ FCC KDB 971168 D01 Power Meas. License Digital Systems v03r01
- ♦ FCC KDB 412172 D01 Determining ERP and EIRP v01r01
- ♦ FCC KDB 662911 D01 Multiple Transmitter Output v02r01.
- ♦ FCC KDB 414788 D01 Radiated Test Site v01r01.

Remark:

1. All the test items were validated and recorded in accordance with the standards without any modification during the testing.
2. This EUT has also been tested and complied with the requirements of FCC Part 15, Subpart B, recorded in a separate test report.
3. The TAF code is not including all the FCC KDB listed without accreditation.



2 Test Configuration of Equipment Under Test

2.1 Test Mode

Antenna port conducted and radiated test items listed below are performed according to KDB 971168 D01 Power Meas. License Digital Systems v03r01 with maximum output power.

For radiated measurement, the measured emission level of the EUT was maximized by rotating the EUT on a turntable, adjusting the orientation of the EUT and EUT antenna in three orthogonal axis (X: flat, Y: portrait, Z: landscape), and adjusting the measurement antenna orientation, following C63.26 exploratory test procedures and only the worst case emissions were reported in this report.

Test Items	FR1 Band	Bandwidth (MHz)													Modulation				RB #			Test Channel			
		5	10	15	20	25	30	40	50	60	70	80	90	100	PI/2 BPSK	QPSK	16QAM	64QAM	256QAM	1	Half	Full	L	M	H
Max. Output Power	n2	v	v	v	v	-	-	-	-	-	-	-	-	-	v	v	v	v	v	v	v	v	v	v	v
	n5	v	v	v	v	-	-	-	-	-	-	-	-	-	v	v	v	v	v	v	v	v	v	v	v
	n7	v	v	v	v	v	v	v	-	-	-	-	-	-	v	v	v	v	v	v	v	v	v	v	v
	n12	v	v	v	-	-	-	-	-	-	-	-	-	-	v	v	v	v	v	v	v	v	v	v	v
	n25	v	v	v	v	v	v	v	-	-	-	-	-	-	v	v	v	v	v	v	v	v	v	v	v
	n26	v	v	v	v	-	-	-	-	-	-	-	-	-	v	v	v	v	v	v	v	v	v	v	v
	n38	-	v	v	v	-	v	v	-	-	-	-	-	-	v	v	v	v	v	v	v	v	v	v	v
	n41	-	-	-	v	-	v	v	v	v	v	v	v	v	v	v	v	v	v	v	v	v	v	v	v
	n66	v	v	v	v	-	v	v	-	-	-	-	-	-	v	v	v	v	v	v	v	v	v	v	v
	n71	v	v	v	v	-	-	-	-	-	-	-	-	-	v	v	v	v	v	v	v	v	v	v	v
Peak-to-Average Ratio	n12			v	-	-	-	-	-	-	-	-	-	v	v	v	v	v			v			v	
	n38	-	-	-	v	-	-	-	-	-	-	-	-	v	v	v	v	v			v			v	



Test Items	FR1 Band	Bandwidth (MHz)												Modulation				RB #			Test Channel				
		5	10	15	20	25	30	40	50	60	70	80	90	100	PI/2 BPSK	QPSK	16QAM	64QAM	256QAM	1	Half	Full	L	M	H
26dB and 99% Bandwidth	n12	v	v	v	-	-	-	-	-	-	-	-	-	-	v	v	v	v	v			v			v
	n25					v	-	-	-	-	-	-	-	-	v	v	v	v	v			v			v
	n38	-	v	v	v	-	v	v	-	-	-	-	-	-	v	v	v	v	v			v			v
Conducted Band Edge	n12	v	v	v	-	-	-	-	-	-	-	-	-	-	v	v	v	v	v	v		v	v	v	v
	n25				v	v	-	-	-	-	-	-	-	-	v	v	v	v	v			v	v	v	v
	n38	-	v	v	v	-	v	v	-	-	-	-	-	-	v	v	v	v	v	v		v	v	v	v
Conducted Spurious Emission	n12	v			-	-	-	-	-	-	-	-	-	-		v				v			v	v	v
	n38	-	v	-												v				v			v	v	v
Frequency Stability	n12			v	-	-	-	-	-	-	-	-	-	-	v							v			v
	n25				v										v							v			v
	n38	-	-	-	v	-	-	-	-	-	-	-	-	-	v							v			v
E.R.P / E.I.R.P	n2	v	v	v	v	-	-	-	-	-	-	-	-	-	v	v	v	v	v	Max Power					
	n5	v	v	v	v	-	-	-	-	-	-	-	-	-	v	v	v	v	v						
	n7	v	v	v	v	v	v	v	-	-	-	-	-	-	v	v	v	v	v						
	n12	v	v	v	-	-	-	-	-	-	-	-	-	-	v	v	v	v	v						
	n25	v	v	v	v	v	v	v	-	-	-	-	-	-	v	v	v	v	v						
	n26	v	v	v	v	-	-	-	-	-	-	-	-	-	v	v	v	v	v						
	n38	-	v	v	v	-	v	v	-	-	-	-	-	-	v	v	v	v	v						
	n41	-	-	-	v	-	v	v	v	v	v	v	v	v	v	v	v	v	v						
	n66	v	v	v	v	-	v	v	-	-	-	-	-	-	v	v	v	v	v						
	n71	v	v	v	v	-	-	-	-	-	-	-	-	-	v	v	v	v	v						



Test Items	FR1 Band	Bandwidth (MHz)												Modulation					RB #			Test Channel		
		5	10	15	20	30	40	50	60	70	80	90	100	PI/2 BPSK	QPSK	16QAM	64QAM	256QAM	1	Half	Full	L	M	H
Radiated Spurious Emission	n2	Covered by n25																						
	n5	Covered by n26																						
	n7	Worst Case																		v	v	v		
	n12	Worst Case																		v	v	v		
	n25	Worst Case																		v	v	v		
	n26	Worst Case																		v	v	v		
	n38	Worst Case																		v	v	v		
	n41	Worst Case																		v	v	v		
	n66	Worst Case																		v	v	v		
	n71	Worst Case																		v	v	v		
Remark	<ol style="list-style-type: none"> The mark "v" means that this configuration is chosen for testing The mark "-" means that this bandwidth is not supported. The device is investigated from 30MHz to 10 times of fundamental signal for radiated spurious emission test under different RB size/offset and modulations in exploratory test. Subsequently, only the worst case emissions are reported. For radiated measurement, pre-scanned in two modes, DFT-s OFDM and CP OFDM. The worst cases (DFT-s OFDM) were recorded in this report, and the worst modes of FR1 and LTE for simultaneous transmission were verified and compliant. Test combination are EN-DC 7A-n5A, EN-DC 2A-n5A, EN-DC 66A-n5A, EN-DC 48A-n5A, EN-DC 12A-n25A, EN-DC 66A-n25A, EN-DC 12A-n2A, EN-DC 4A-n2A, EN-DC 13A-n2A, EN-DC 66A-n2A, EN-DC 5A-n2A, EN-DC 2A-n12A, EN-DC 66A-n12A, EN-DC 48A-n12A, EN-DC 48A-n66A, EN-DC 2A-n66A, EN-DC 7A-n66A, EN-DC 12A-n66A, EN-DC 13A-n66A, EN-DC 5A-n66A, EN-DC 66A-n7A, EN-DC 2A-n41A, EN-DC 66A-n41A, EN-DC 2A-n71A, EN-DC 66A-n71A and EN-DC 48A-n71A. Wider operating range bandwidth covers narrower one when the power is higher or the same. One representative bandwidth is selected to perform PAR and frequency stability. 																							

2.2 Connection Diagram of Test System

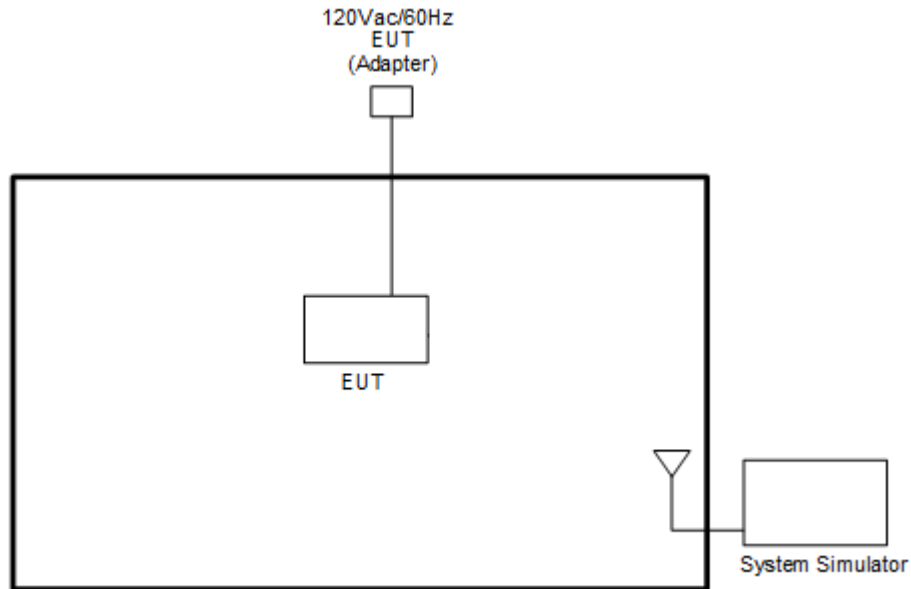

2.3 Support Unit used in test configuration and system

Item	Equipment	Brand Name	Model No.	FCC ID	Data Cable	Power Cord
1.	5G Wireless Test Platform	Anritsu	MT8000A	N/A	N/A	Unshielded, 1.8 m
2.	System Simulator	Anritsu	MT8821C	N/A	N/A	Unshielded, 1.8 m

2.4 Measurement Results Explanation Example

For all conducted test items:

The offset level is set in the spectrum analyzer to compensate the RF cable loss and attenuator factor between EUT conducted output port and spectrum analyzer. With the offset compensation, the spectrum analyzer reading level is exactly the EUT RF output level.

The spectrum analyzer offset is derived from RF cable loss and attenuator factor.

Offset = RF cable loss + attenuator factor.

Following shows an offset computation example with cable loss 4.2 dB and 10dB attenuator.

Example :

$$\begin{aligned} \text{Offset(dB)} &= \text{RF cable loss(dB)} + \text{attenuator factor(dB)} \\ &= 4.2 + 10 = 14.2 \text{ (dB)} \end{aligned}$$



2.5 Frequency List of Low/Middle/High Channels

5G FR1 n2 Channel and Frequency List				
BW [MHz]	Channel/Frequency(MHz)	Lowest	Middle	Highest
20	Channel	372000	376000	380000
	Frequency	1860	1880	1900
15	Channel	371500	376000	380500
	Frequency	1857.5	1880	1902.5
10	Channel	371000	376000	381000
	Frequency	1855	1880	1905
5	Channel	370500	376000	381500
	Frequency	1852.5	1880	1907.5

5G FR1 n5 Channel and Frequency List				
BW [MHz]	Channel/Frequency(MHz)	Lowest	Middle	Highest
20	Channel	166800	167300	167800
	Frequency	834	836.5	839
15	Channel	166300	167300	168300
	Frequency	831.5	836.5	841.5
10	Channel	165800	167300	168800
	Frequency	829	836.5	844
5	Channel	165300	167300	169300
	Frequency	826.5	836.5	846.5



5G FR1 n7 Channel and Frequency List				
BW [MHz]	Channel/Frequency(MHz)	Lowest	Middle	Highest
40	Channel	504000	507000	510000
	Frequency	2520	2535	2550
30	Channel	503000	507000	511000
	Frequency	2515	2535	2555
25	Channel	502000	507000	511550
	Frequency	2512.5	2535	2557.5
20	Channel	502000	507000	512000
	Frequency	2510	2535	2560
15	Channel	501500	507000	512500
	Frequency	2507.5	2535	2562.5
10	Channel	501000	507000	513000
	Frequency	2505	2535	2565
5	Channel	500500	507000	513500
	Frequency	2502.5	2535	2567.5



5G FR1 n12 Channel and Frequency List				
BW [MHz]	Channel/Frequency(MHz)	Lowest	Middle	Highest
15	Channel	141300	141500	141700
	Frequency	706.5	707.5	708.5
10	Channel	140800	141500	142200
	Frequency	704	707.5	711
5	Channel	140300	141500	142700
	Frequency	701.5	707.5	713.5

5G FR1 n25 Channel and Frequency List				
BW [MHz]	Channel/Frequency(MHz)	Lowest	Middle	Highest
40	Channel	374000	376500	379000
	Frequency	1870	1882.5	1895
30	Channel	373000	376500	380000
	Frequency	1865	1882.5	1900
25	Channel	372500	376500	380500
	Frequency	1862.5	1882.5	1902.5
20	Channel	372000	376500	381000
	Frequency	1860	1882.5	1905
15	Channel	371500	376500	381500
	Frequency	1857.5	1882.5	1907.5
10	Channel	371000	376500	382000
	Frequency	1855	1882.5	1910
5	Channel	370500	376500	382500
	Frequency	1852.5	1882.5	1912.5



5G FR1 n26 Channel and Frequency List				
BW [MHz]	Channel/Frequency(MHz)	Lowest	Middle	Highest
20	Channel	166800	167300	167800
	Frequency	834	836.5	839
15	Channel	166300	167300	168300
	Frequency	831.5	836.5	841.5
10	Channel	165800	167300	168800
	Frequency	829	836.5	844
5	Channel	165300	167300	169300
	Frequency	826.5	836.5	846.5

5G FR1 n38 Channel and Frequency List				
BW [MHz]	Channel/Frequency(MHz)	Lowest	Middle	Highest
40	Channel	518000	519000	520000
	Frequency	2590	2595	2600
30	Channel	517000	519000	521000
	Frequency	2585	2595	2605
20	Channel	516000	519000	522000
	Frequency	2580	2595	2610
15	Channel	515500	519000	522500
	Frequency	2577.5	2595	2612.5
10	Channel	515000	519000	523000
	Frequency	2575	2595	2615



5G FR1 n41 Channel and Frequency List				
BW [MHz]	Channel/Frequency(MHz)	Lowest	Middle	Highest
100	Channel	509202	518598	528000
	Frequency	2546.01	2592.99	2640
90	Channel	508200	518598	528996
	Frequency	2541	2592.99	2644.98
80	Channel	507204	518598	529998
	Frequency	2536.02	2592.99	2649.99
70	Channel	506202	518598	531000
	Frequency	2531.01	2592.99	2655
60	Channel	505200	518598	531996
	Frequency	2526	2592.99	2659.98
50	Channel	504204	518598	532998
	Frequency	2521.02	2592.99	2664.99
40	Channel	503202	518598	534000
	Frequency	2516.01	2592.99	2670
30	Channel	502200	518598	534996
	Frequency	2511	2592.99	2674.98
20	Channel	501204	518598	535998
	Frequency	2506.02	2592.99	2679.99

5G FR1 n66 Channel and Frequency List				
BW [MHz]	Channel/Frequency(MHz)	Lowest	Middle	Highest
40	Channel	346000	349000	352000
	Frequency	1730	1745	1760
30	Channel	345000	349000	353000
	Frequency	1725	1745	1765
20	Channel	344000	349000	354000
	Frequency	1720	1745	1770
15	Channel	343500	349000	354500
	Frequency	1717.5	1745	1772.5
10	Channel	343000	349000	355000
	Frequency	1715	1745	1775
5	Channel	342500	349000	355500
	Frequency	1712.5	1745	1777.5



5G FR1 n71 Channel and Frequency List				
BW [MHz]	Channel/Frequency(MHz)	Lowest	Middle	Highest
20	Channel	134600	136100	137600
	Frequency	673	680.5	688
15	Channel	134100	136100	138100
	Frequency	670.5	680.5	690.5
10	Channel	133600	136100	138600
	Frequency	668	680.5	693
5	Channel	133100	136100	139100
	Frequency	665.5	680.5	695.5

3 Conducted Test Items

3.1 Measuring Instruments

See list of measuring instruments of this test report.

3.1.1 Test Setup

3.1.2 Conducted Output Power



3.1.3 Peak-to-Average Ratio, Occupied Bandwidth ,Conducted Band-Edge and Conducted Spurious Emission

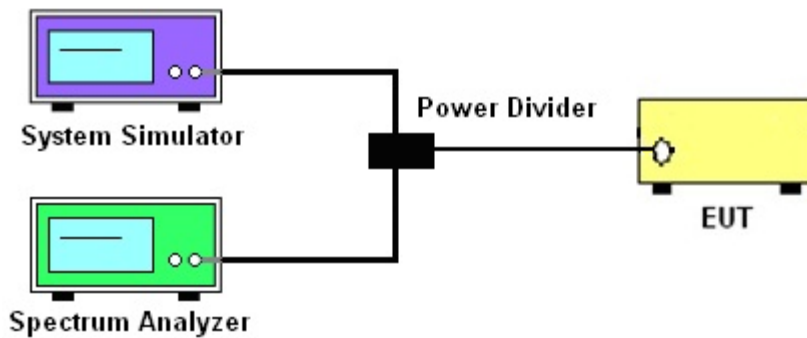

3.1.4 Frequency Stability



3.1.5 Test Result of Conducted Test

Please refer to Appendix A.



3.2 Conducted Output Power and ERP/EIRP

3.2.1 Description of the Conducted Output Power Measurement and ERP/EIRP Measurement

A system simulator was used to establish communication with the EUT. Its parameters were set to force the EUT transmitting at maximum output power. The measured power in the radio frequency on the transmitter output terminals shall be reported.

The ERP of mobile transmitters must not exceed 7 Watts for 5G FR1 n5 and n26

The ERP of mobile transmitters must not exceed 30 Watts for 5G FR1 n12 and n71

The EIRP of mobile transmitters must not exceed 2 Watts for 5G FR1 n2 and n25 and n7 and n38 and n41

The EIRP of mobile transmitters must not exceed 1 Watts for 5G FR1 n66

According to KDB 412172 D01 Power Approach,

$EIRP = PT + GT - LC$, $ERP = EIRP - 2.15$, where

PT = transmitter output power in dBm

GT = gain of the transmitting antenna in dBi

LC = signal attenuation in the connecting cable between the transmitter and antenna in dB

The MIMO mode is completely uncorrelated, so the directional gain is selected the maximum gain among all antennas.

3.2.2 Test Procedures

1. The transmitter output port was connected to the system simulator.
2. Set EUT at maximum power through the system simulator.
3. Select lowest, middle, and highest channels for each band and different modulation.
4. Measure and record the power level from the system simulator.



3.3 Peak-to-Average Ratio

3.3.1 Description of the PAR Measurement

Power Complementary Cumulative Distribution Function (CCDF) curves provide a means for characterizing the power peaks of a digitally modulated signal on a statistical basis. A CCDF curve depicts the probability of the peak signal amplitude exceeding the average power level. Most contemporary measurement instrumentation include the capability to produce CCDF curves for an input signal provided that the instrument's resolution bandwidth can be set wide enough to accommodate the entire input signal bandwidth. In measuring transmissions in this band using an average power technique, the peak-to-average ratio (PAR) of the transmission may not exceed 13 dB.

3.3.2 Test Procedures

The testing follows ANSI C63.26-2015 Section 5.2.6

1. The EUT was connected to spectrum and system simulator via a power divider.
2. Set the CCDF (Complementary Cumulative Distribution Function) option in spectrum analyzer.
3. The highest RF powers were measured and recorded the maximum PAPR level associated with a probability of 0.1 %.
4. Record the deviation as Peak to Average Ratio.



3.4 Occupied Bandwidth

3.4.1 Description of Occupied Bandwidth Measurement

The occupied bandwidth is the width of a frequency band such that, below the lower and above the upper frequency limits, the mean powers emitted are each equal to a specified percentage 0.5% of the total mean transmitted power.

The 26 dB emission bandwidth is defined as the frequency range between two points, one above and one below the carrier frequency, at which the spectral density of the emission is attenuated 26 dB below the maximum in-band spectral density of the modulated signal. Spectral density (power per unit bandwidth) is to be measured with a detector of resolution bandwidth equal to approximately 1.0% of the emission bandwidth.

3.4.2 Test Procedures

The testing follows ANSI C63.26-2015 Section 5.4.3 (26dB) and Section 5.4.4 (99OB)

1. The EUT was connected to spectrum analyzer and system simulator via a power divider.
2. The spectrum analyzer center frequency is set to the nominal EUT channel center frequency. The span range for the spectrum analyzer shall be between two and five times the anticipated OBW.
3. The nominal resolution bandwidth (RBW) shall be in the range of 1 to 5 % of the anticipated OBW, and the VBW shall be at least 3 times the RBW.
4. Set the detection mode to peak, and the trace mode to max hold.
5. Determine the reference value: Set the EUT to transmit a modulated signal. Allow the trace to stabilize. Set the spectrum analyzer marker to the highest level of the displayed trace.
(this is the reference value)
6. Determine the “-26 dB down amplitude” as equal to (Reference Value – X).
7. Place two markers, one at the lowest and the other at the highest frequency of the envelope of the spectral display such that each marker is at or slightly below the “-X dB down amplitude” determined in step 6. If a marker is below this “-X dB down amplitude” value it shall be placed as close as possible to this value. The OBW is the positive frequency difference between the two markers.
8. Use the 99 % power bandwidth function of the spectrum analyzer and report the measured bandwidth.



3.5 Conducted Band Edge

3.5.1 Description of Conducted Band Edge Measurement

22.917(a)

For operations in the 824 – 849 MHz band, the FCC limit is $43 + 10\log_{10}(P[\text{Watts}])$ dB below the transmitter power $P(\text{Watts})$ in a 100kHz bandwidth. However, in the 1MHz bands immediately outside and adjacent to the licensee's frequency block, a resolution bandwidth of at least one percent of the emission bandwidth of the fundamental emission of the transmitter may be employed.

24.238 (a)

For operations in the 1850-1910 and 1930-1990 MHz band, the FCC limit is $43 + 10\log_{10}(P[\text{Watts}])$ dB below the transmitter power $P(\text{Watts})$ in a 1MHz bandwidth. However, in the 1 MHz bands immediately outside and adjacent to the frequency block a resolution bandwidth of at least one percent of the emission bandwidth of the fundamental emission of the transmitter may be employed.

27.53 (g)

For operations in the 600MHz band and 698-746 MHz band, the FCC limit is $43 + 10\log_{10}(P[\text{Watts}])$ dB below the transmitter power $P(\text{Watts})$ in a 100 kHz bandwidth. However, in the 100 kilohertz bands immediately outside and adjacent to a licensee's frequency block, a resolution bandwidth of at least 30 kHz may be employed.

27.53 (h)

For operations in the 1710 – 1755 MHz band, 1755-1780 MHz, the FCC limit is $43 + 10\log_{10}(P[\text{Watts}])$ dB below the transmitter power $P(\text{Watts})$ in a 1 MHz bandwidth. However, in the 1MHz bands immediately outside and adjacent to the licensee's frequency block, a resolution bandwidth of at least one percent of the emission bandwidth of the fundamental emission of the transmitter may be employed.

**27.53(m)(4)**

For mobile digital stations, the attenuation factor shall be not less than $40 + 10 \log (P)$ dB on all frequencies between the channel edge and 5 megahertz from the channel edge, $43 + 10 \log (P)$ dB on all frequencies between 5 megahertz and X megahertz from the channel edge, and $55 + 10 \log (P)$ dB on all frequencies more than X megahertz from the channel edge, where X is the greater of 6 megahertz or the actual emission bandwidth as defined in paragraph (m)(6) of this section. In addition, the attenuation factor shall not be less that $43 + 10 \log (P)$ dB on all frequencies between 2490.5 MHz and 2496 MHz and $55 + 10 \log (P)$ dB at or below 2490.5 MHz. Mobile Satellite Service licensees operating on frequencies below 2495 MHz may also submit a documented interference complaint against BRS licensees operating on channel BRS Channel 1 on the same terms and conditions as adjacent channel BRS or EBS licensees.

3.5.2 Test Procedures

The testing follows FCC KDB 971168 D01 v03r01 Section 6.1.

1. The EUT was connected to spectrum analyzer and system simulator via a power divider.
2. The band edges of low and high channels for the highest RF powers were measured.
3. Set RBW \geq 1% EBW in the 1MHz band immediately outside and adjacent to the band edge.
4. Beyond the 1 MHz band from the band edge, RBW=1MHz was used.
5. Set spectrum analyzer with RMS detector.
6. The RF fundamental frequency should be excluded against the limit line in the operating frequency band.
7. Checked that all the results comply with the emission limit line.

The limit line is derived from $43 + 10\log(P)$ dB below the transmitter power P(Watts)

For 5G FR1 n7, n38, n41

The other 40 dB, and 55 dB have additionally applied same calculation above.

8. For MIMO mode, add additional MIMO factor $10\log(\text{NTX}=2) = 3.01\text{dB}$ into the spectrum analyzer offset.



3.6 Conducted Spurious Emission

3.6.1 Description of Conducted Spurious Emission Measurement

The power of any emission outside of the authorized operating frequency ranges must be lower than the transmitter power (P) by a factor of at least $43 + 10 \log (P)$ dB.

For 5G FR1 n7, n38, n41

The power of any emission outside of the authorized operating frequency ranges must be lower than the transmitter power (P) by a factor of at least $55 + 10 \log (P)$ dB.

It is measured by means of a calibrated spectrum analyzer and scanned from 30 MHz up to a frequency including its 10th harmonic.

3.6.2 Test Procedures

The testing follows FCC KDB 971168 D01 v03r01 Section 6.1.

1. The EUT was connected to spectrum analyzer and system simulator via a power divider.
2. The RF output of EUT was connected to the spectrum analyzer by RF cable and attenuator.
The path loss was compensated to the results for each measurement.
3. The middle channel for the highest RF power within the transmitting frequency was measured.
4. The conducted spurious emission for the whole frequency range was taken.
5. Make the measurement with the spectrum analyzer's RBW = 1MHz, VBW = 3MHz.
6. Set spectrum analyzer with RMS detector.
7. Taking the record of maximum spurious emission.
8. The RF fundamental frequency should be excluded against the limit line in the operating frequency band.
9. The limit line is derived from $43 + 10\log(P)$ dB below the transmitter power P(Watts)
For 5G FR1 n7, n38, n41
The limit line is derived from $55 + 10\log(P)$ dB below the transmitter power P(Watts)
10. For MIMO mode, add additional MIMO factor $10\log(\text{NTX}=2) = 3.01$ dB into the spectrum analyzer offset.



3.7 Frequency Stability

3.7.1 Description of Frequency Stability Measurement

22.355

The frequency stability shall be measured by variation of ambient temperature and variation of primary supply voltage to ensure that the fundamental emission stays within the authorized frequency block. The frequency stability of the transmitter shall be maintained within $\pm 0.00025\%$ ($\pm 2.5\text{ppm}$) of the center frequency.

24.235 & 27.54

The frequency stability shall be sufficient to ensure that the fundamental emission stays within the authorized frequency block.

3.7.2 Test Procedures for Temperature Variation

The testing follows FCC KDB 971168 D01 v03r01 Section 9.0.

1. The EUT was set up in the thermal chamber and connected with the system simulator.
2. With power OFF, the temperature was decreased to -30°C and the EUT was stabilized before testing. Power was applied and the maximum change in frequency was recorded within one minute.
3. With power OFF, the temperature was raised in 10°C step up to 50°C . The EUT was stabilized at each step for at least half an hour. Power was applied and the maximum frequency change was recorded within one minute.

3.7.3 Test Procedures for Voltage Variation

The testing follows FCC KDB 971168 D01 v03r01 Section 9.0.

1. The EUT was placed in a temperature chamber at $20\pm 5^{\circ}\text{C}$ and connected with the system simulator.
2. The power supply voltage to the EUT was varied from 85% to 115% of the nominal value measured at the input to the EUT.
3. The variation in frequency was measured for the worst case.

4 Radiated Test Items

4.1 Measuring Instruments

See list of measuring instruments of this test report.

4.1.1 Test Setup

For radiated test below 30MHz



For radiated test from 30MHz to 1GHz

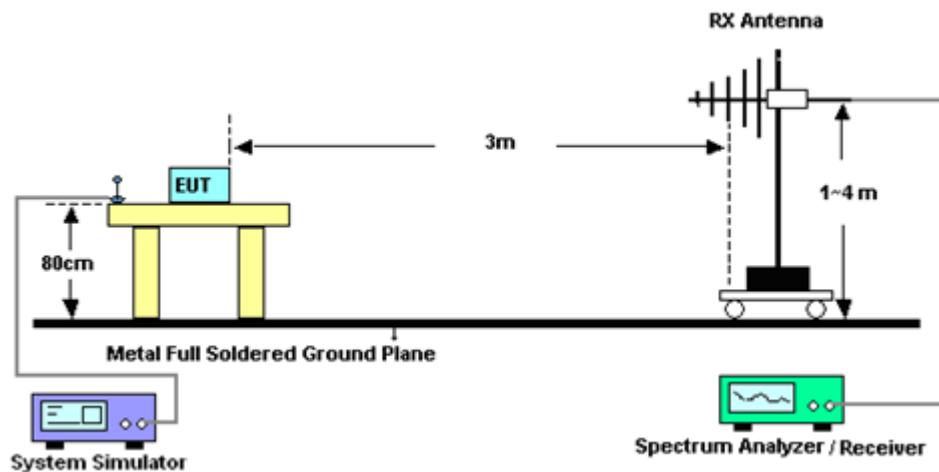

For radiated test from 1GHz to 18GHz



For radiated test above 18GHz

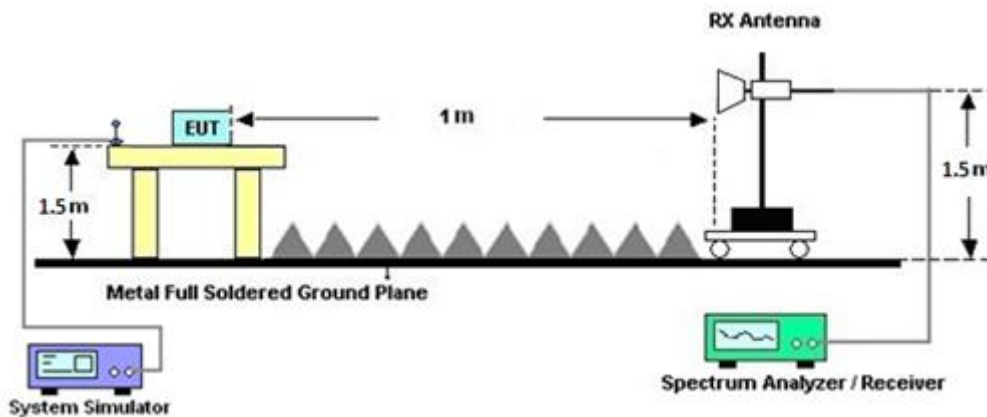

4.1.2 Test Result of Radiated Test

Please refer to Appendix B.

Note:

The low frequency, which started from 9 kHz to 30MHz, was pre-scanned and the result which was 20dB lower than the limit line was not reported.

There is adequate comparison measurement of both open-field test site and alternative test site - semi-Anechoic chamber according to 414788 D01 Radiated Test Site v01r01, and the result came out very similar.



4.2 Radiated Spurious Emission Measurement

4.2.1 Description of Radiated Spurious Emission Measurement

The radiated spurious emission was measured by substitution method according to ANSI / TIA-603-E. The power of any emission outside of the authorized operating frequency ranges must be attenuated below the transmitter power (P) by a factor of at least $43 + 10 \log (P)$ dB.

For 5G FR1 n7, n38, n41

The power of any emission outside of the authorized operating frequency ranges must be attenuated below the transmitter power (P) by a factor of at least $55 + 10 \log (P)$ dB.

The spectrum is scanned from 30 MHz up to a frequency including its 10th harmonic.

4.2.2 Test Procedures

The testing follows FCC KDB 971168 D01 v03r01 Section 7 and ANSI / TIA-603-E Section 2.2.12.

1. The EUT was placed on a turntable with 0.8 meter for frequency below 1GHz and 1.5 meter for frequency above 1GHz respectively above ground.
2. The EUT was set 3 meters from the receiving antenna, which was mounted on the antenna tower.
3. The table was rotated 360 degrees to determine the position of the highest spurious emission.
4. The height of the receiving antenna is varied between one meter and four meters to search the maximum spurious emission for both horizontal and vertical polarizations.
5. Make the measurement with the spectrum analyzer's RBW = 1MHz, VBW = 3MHz, taking the record of maximum spurious emission.
6. A horn antenna was substituted in place of the EUT and was driven by a signal generator.
7. Tune the output power of signal generator to the same emission level with EUT maximum spurious emission.
8. Taking the record of output power at antenna port.
9. Repeat step 7 to step 8 for another polarization.
10. The RF fundamental frequency should be excluded against the limit line in the operating frequency band.

The limit line is derived from $43 + 10\log(P)$ dB below the transmitter power P(Watts)

For 5G FR1 n7, n38, n41

The limit line is derived from $55 + 10\log(P)$ dB below the transmitter power P(Watts)

$EIRP \text{ (dBm)} = S.G. \text{ Power} - Tx \text{ Cable Loss} + Tx \text{ Antenna Gain}$

$ERP \text{ (dBm)} = EIRP - 2.15$



5 List of Measuring Equipment

Instrument	Brand Name	Model No.	Serial No.	Characteristics	Calibration Date	Test Date	Due Date	Remark
Programmable Power Supply	GW Instek	PSS-2005	EL890001	50Hz~60Hz	Sep. 29, 2022	Mar. 03, 2023~ Apr. 06, 2023	Sep. 28, 2023	Conducted (TH03-HY)
Signal Analyzer	Rohde & Schwarz	FSV3044	101049	10Hz~44GHz	Oct. 07, 2022	Mar. 03, 2023~ Apr. 06, 2023	Oct. 06, 2023	Conducted (TH03-HY)
Temperature Chamber	ESPEC	SH-641	92013720	-40℃ ~90℃	Sep,07,2022	Mar. 03, 2023~ Apr. 06, 2023	Sep. 06, 2023	Conducted (TH03-HY)
Base Station (Measure)	Anritsu	MT8821C	6262116730	LTE	Jun. 15, 2022	Mar. 03, 2023~ Apr. 06, 2023	Jun. 14, 2023	Conducted (TH03-HY)
Base Station (Measure)	Anritsu	MT8000A	6262134933	FR1	Jun. 13, 2022	Mar. 03, 2023~ Apr. 06, 2023	Jun. 12, 2023	Conducted (TH03-HY)
Bilog Antenna	TESEQ	CBL 6111D & 00800N1D01N-06	35419 & 03	30MHz~1GHz	Apr. 24, 2022	Mar. 24, 2023~ Apr. 01, 2023	Apr. 23, 2023	Radiation (03CH07-HY)
Double Ridge Horn Antenna	ESCO	3117	00075962	1GHz ~ 18GHz	Dec. 01, 2022	Mar. 24, 2023~ Apr. 01, 2023	Nov. 30, 2023	Radiation (03CH07-HY)
Loop Antenna	Rohde & Schwarz	HFH2-Z2	100488	9 kHz~30 MHz	Sep. 20, 2022	Mar. 24, 2023~ Apr. 01, 2023	Sep. 19, 2023	Radiation (03CH07-HY)
Preamplifier	MITEQ	AMF-7D-0010 1800-30-10P	1590075	1GHz~18GHz	Apr. 21, 2022	Mar. 24, 2023~ Apr. 01, 2023	Apr. 20, 2023	Radiation (03CH07-HY)
Preamplifier	COM-POWER	PA-103A	161241	10MHz~1GHz	Oct. 03, 2022	Mar. 24, 2023~ Apr. 01, 2023	Oct. 02, 2023	Radiation (03CH07-HY)
Preamplifier	Agilent	8449B	3008A02362	1GHz~26.5GHz	Mar. 24, 2023	Mar. 24, 2023~ Apr. 01, 2023	Mar. 23, 2024	Radiation (03CH07-HY)
RF Cable	HUBER + SUHNER	SUCOFLEX 104	MY15682/4	30MHz to 18GHz	Feb. 22, 2023	Mar. 24, 2023~ Apr. 01, 2023	Feb. 21, 2024	Radiation (03CH07-HY)
RF Cable	HUBER + SUHNER	SUCOFLEX 104	MY24971/4	9kHz to 18GHz	Feb. 22, 2023	Mar. 24, 2023~ Apr. 01, 2023	Feb. 21, 2024	Radiation (03CH07-HY)
RF Cable	HUBER + SUHNER	SUCOFLEX 104	MY28655/4	9kHz to 18GHz	Feb. 22, 2023	Mar. 24, 2023~ Apr. 01, 2023	Feb. 21, 2024	Radiation (03CH07-HY)
RF Cable	HUBER + SUHNER	SUCOFLEX 126	532078/126E	30MHz~18GHz	Sep. 16, 2022	Mar. 24, 2023~ Apr. 01, 2023	Sep. 15, 2023	Radiation (03CH07-HY)
RF Cable	HUBER + SUHNER	SUCOFLEX 102	MY2858/2	18GHz~40GHz	Feb. 22, 2023	Mar. 24, 2023~ Apr. 01, 2023	Feb. 21, 2024	Radiation (03CH07-HY)
RF Cable	HUBER + SUHNER	SUCOFLEX 102	801606/2	9KHz ~ 40GHz	Apr. 14, 2022	Mar. 24, 2023~ Apr. 01, 2023	Apr. 13, 2023	Radiation (03CH07-HY)
Controller	EMEC	EM1000	N/A	Control Ant Mast	N/A	Mar. 24, 2023~ Apr. 01, 2023	N/A	Radiation (03CH07-HY)
Controller	MF	MF-7802	N/A	Control Turn table	N/A	Mar. 24, 2023~ Apr. 01, 2023	N/A	Radiation (03CH07-HY)
Antenna Mast	EMEC	AM-BS-4500E	N/A	Boresight mast 1M~4M	N/A	Mar. 24, 2023~ Apr. 01, 2023	N/A	Radiation (03CH07-HY)
Turn Table	ChainTek	Chaintek 3000	N/A	0~360 Degree	N/A	Mar. 24, 2023~ Apr. 01, 2023	N/A	Radiation (03CH07-HY)
Software	Audix	E3	N/A	N/A	N/A	Mar. 24, 2023~ Apr. 01, 2023	N/A	Radiation (03CH07-HY)
USB Data Logger	TECPEL	TR-32	HE17XB2495	N/A	Mar. 14, 2023	Mar. 24, 2023~ Apr. 01, 2023	Mar. 13, 2024	Radiation (03CH07-HY)
Spectrum Analyzer	Keysight	N9010B	MY60241058	10Hz~44GHz	Jul. 07, 2022	Mar. 29, 2023~ Apr. 01, 2023	Jul. 06, 2023	Radiation (03CH07-HY)
Preamplifier	EMEC	EM18G40G	0600789	18GHz~40GHz	Jul. 21, 2022	Mar. 24, 2023~ Apr. 01, 2023	Jul. 20, 2023	Radiation (03CH07-HY)
SHF-EHF Horn Antenna	SCHWARZBECK	BBHA 9170	BBHA917025 1	18GHz~40GHz	Nov. 24, 2022	Mar. 24, 2023~ Apr. 01, 2023	Nov. 23, 2023	Radiation (03CH07-HY)
Double Ridge Horn Antenna	EMCO	3117	00227856	1 - 18 GHz	Sep. 27, 2022	Mar. 24, 2023~ Apr. 01, 2023	Sep. 26, 2023	Radiation (03CH07-HY)
Signal Generator	Rohde & Schwarz	SMF100A	101107	100kHz~40GHz	Jan. 11, 2023	Mar. 24, 2023~ Apr. 01, 2023	Jan. 10, 2024	Radiation (03CH07-HY)



6 Uncertainty of Evaluation

Uncertainty of Radiated Emission Measurement (30 MHz ~ 1000 MHz)

Measuring Uncertainty for a Level of Confidence of 95% ($U = 2Uc(y)$)	3.25 dB
---	---------

Uncertainty of Radiated Emission Measurement (1 GHz ~ 18 GHz)

Measuring Uncertainty for a Level of Confidence of 95% ($U = 2Uc(y)$)	3.50 dB
---	---------

Uncertainty of Radiated Emission Measurement (18 GHz ~ 40 GHz)

Measuring Uncertainty for a Level of Confidence of 95% ($U = 2Uc(y)$)	4.08 dB
---	---------



Appendix A. Test Results of Conducted Test

Conducted Output Power(Average power) and ERP/EIRP

<SISO Mode>

FR1 n2 Maximum Average Power [dBm] (GT - LC = 1.6 dB)										
BW [MHz]	RB Size	RB Offset	Mod	Lowest	Middle	Highest	EIRP (dBm)	EIRP(W)		
5	1	1	PI/2 BPSK	23.92	24.04	23.81	25.64	0.3664		
5	1	23		23.77	23.86	23.71				
5	12	6		23.86	24.01	23.82				
5	1	0		23.37	23.51	23.25				
5	1	24		23.26	23.50	23.18				
5	25	0		23.39	23.52	23.28				
5	1	1	QPSK	23.92	24.01	23.78			24.60	0.2884
5	1	23		23.74	23.95	23.68				
5	12	6		23.82	24.00	23.74				
5	1	0		22.86	23.06	22.81				
5	1	24		22.78	23.03	22.67				
5	25	0		22.88	23.00	22.82				
5	1	1	16-QAM	22.84	23.00	22.81	24.60	0.2884		
5	1	1	64-QAM	21.62	21.73	21.55				
5	1	1	256-QAM	18.82	19.07	18.82				
Limit	EIRP < 2W			Result			Pass			

FR1 n2 Maximum Average Power [dBm] (GT - LC = 1.6 dB)										
BW [MHz]	RB Size	RB Offset	Mod	Lowest	Middle	Highest	EIRP (dBm)	EIRP(W)		
10	1	1	PI/2 BPSK	23.98	23.96	23.91	25.65	0.3673		
10	1	50		23.85	24.00	23.78				
10	25	12		23.96	24.05	23.86				
10	1	0		23.39	23.55	23.41				
10	1	51		23.28	23.42	23.27				
10	50	0		23.43	23.58	23.36				
10	1	1	QPSK	23.97	24.01	23.91			24.54	0.2844
10	1	50		23.85	23.97	23.83				
10	25	12		23.92	24.01	23.86				
10	1	0		23.00	23.04	22.91				
10	1	51		22.85	22.95	22.81				
10	50	0		22.97	23.00	22.82				
10	1	1	16-QAM	22.94	22.91	22.87	24.54	0.2844		
10	1	1	64-QAM	21.64	21.66	21.57				
10	1	1	256-QAM	18.96	18.91	18.89				
Limit	EIRP < 2W			Result			Pass			



FR1 n2 Maximum Average Power [dBm] (GT - LC = 1.6 dB)								
BW [MHz]	RB Size	RB Offset	Mod	Lowest	Middle	Highest	EIRP (dBm)	EIRP(W)
15	1	1	PI/2 BPSK	24.00	24.10	24.02	25.89	0.3882
15	1	77		24.02	24.17	23.94		
15	36	18		24.02	24.29	24.01		
15	1	0		23.55	23.65	23.51		
15	1	78		23.50	23.62	23.41		
15	75	0		23.58	23.70	23.51		
15	1	1	QPSK	24.10	24.15	24.04		
15	1	77		24.05	24.14	23.94		
15	36	18		24.04	24.16	23.99		
15	1	0		23.09	23.19	23.03		
15	1	78		23.02	23.11	22.90		
15	75	0		23.10	23.12	22.95		
15	1	1	16-QAM	23.05	23.11	23.00	24.71	0.2958
15	1	1	64-QAM	21.76	21.86	21.73		
15	1	1	256-QAM	19.08	19.13	19.02		
Limit	EIRP < 2W			Result			Pass	

FR1 n2 Maximum Average Power [dBm] (GT - LC = 1.6 dB)								
BW [MHz]	RB Size	RB Offset	Mod	Lowest	Middle	Highest	EIRP (dBm)	EIRP(W)
20	1	1	PI/2 BPSK	24.08	24.15	24.05	25.77	0.3776
20	1	104		24.12	24.12	23.89		
20	50	25		23.97	24.10	23.97		
20	1	0		23.58	23.65	23.58		
20	1	105		23.58	23.59	23.46		
20	100	0		23.57	23.65	23.52		
20	1	1	QPSK	24.05	24.17	24.02		
20	1	104		24.11	24.10	23.91		
20	50	25		24.05	24.16	24.03		
20	1	0		23.09	23.17	23.05		
20	1	105		23.12	23.12	22.92		
20	100	0		23.05	23.19	23.04		
20	1	1	16-QAM	22.96	23.07	23.00	24.67	0.2931
20	1	1	64-QAM	21.78	21.78	21.74		
20	1	1	256-QAM	19.07	19.15	19.10		
Limit	EIRP < 2W			Result			Pass	



FR1 n5 Maximum Average Power [dBm] (GT - LC = 0.8 dB)										
BW [MHz]	RB Size	RB Offset	Mod	Lowest	Middle	Highest	ERP (dBm)	ERP(W)		
5	1	1	PI/2 BPSK	24.03	24.10	23.99	22.85	0.1928		
5	1	23		24.08	24.14	24.10				
5	12	6		24.04	24.12	24.09				
5	1	0		23.61	23.66	23.60				
5	1	24		23.50	23.64	23.55				
5	25	0		23.57	23.61	23.59				
5	1	1	QPSK	23.94	24.15	24.03			21.71	0.1483
5	1	23		23.98	24.20	24.10				
5	12	6		24.05	24.10	23.99				
5	1	0		23.09	23.21	23.18				
5	1	24		22.98	23.19	23.10				
5	25	0		23.01	23.12	22.98				
5	1	1	16-QAM	22.98	23.06	22.96	21.71	0.1483		
5	1	1	64-QAM	21.66	21.72	21.67				
5	1	1	256-QAM	19.05	19.07	19.04				
Limit	ERP < 7W			Result			Pass			

FR1 n5 Maximum Average Power [dBm] (GT - LC = 0.8 dB)										
BW [MHz]	RB Size	RB Offset	Mod	Lowest	Middle	Highest	ERP (dBm)	ERP(W)		
10	1	1	PI/2 BPSK	23.99	24.06	24.02	22.79	0.1901		
10	1	50		24.05	24.02	23.95				
10	25	12		24.00	24.10	23.98				
10	1	0		23.57	23.64	23.49				
10	1	51		23.54	23.57	23.43				
10	50	0		23.48	23.67	23.52				
10	1	1	QPSK	23.93	24.06	24.02			21.74	0.1493
10	1	50		24.03	24.05	24.01				
10	25	12		24.02	24.14	23.94				
10	1	0		23.01	23.16	23.05				
10	1	51		23.05	23.09	22.96				
10	50	0		23.06	23.12	22.94				
10	1	1	16-QAM	22.91	23.07	23.09	21.74	0.1493		
10	1	1	64-QAM	21.54	21.73	21.61				
10	1	1	256-QAM	18.96	19.07	19.01				
Limit	ERP < 7W			Result			Pass			



FR1 n5 Maximum Average Power [dBm] (GT - LC = 0.8 dB)										
BW [MHz]	RB Size	RB Offset	Mod	Lowest	Middle	Highest	ERP (dBm)	ERP(W)		
15	1	1	PI/2 BPSK	24.05	24.16	24.21	22.88	0.1941		
15	1	77		24.17	24.14	24.09				
15	36	18		24.15	24.23	24.14				
15	1	0		23.66	23.79	23.74				
15	1	78		23.63	23.61	23.53				
15	75	0		23.67	23.72	23.68				
15	1	1	QPSK	24.10	24.20	24.16			21.82	0.1521
15	1	77		24.14	24.02	24.05				
15	36	18		24.19	24.20	24.17				
15	1	0		23.28	23.28	23.24				
15	1	78		23.13	23.03	23.04				
15	75	0		23.26	23.20	23.14				
15	1	1	16-QAM	23.02	23.09	23.17	21.82	0.1521		
15	1	1	64-QAM	21.74	21.80	21.86				
15	1	1	256-QAM	19.20	19.26	19.29				
Limit	ERP < 7W			Result			Pass			

FR1 n5 Maximum Average Power [dBm] (GT - LC = 0.8 dB)										
BW [MHz]	RB Size	RB Offset	Mod	Lowest	Middle	Highest	ERP (dBm)	ERP(W)		
20	1	1	PI/2 BPSK	24.13	24.12	24.17	22.96	0.1977		
20	1	104		24.08	24.03	24.09				
20	50	25		24.22	24.31	24.21				
20	1	0		23.80	23.81	23.77				
20	1	105		23.50	23.60	23.54				
20	100	0		23.72	23.79	23.70				
20	1	1	QPSK	24.13	24.28	24.14			21.89	0.1545
20	1	104		24.04	24.05	24.03				
20	50	25		24.21	24.24	24.21				
20	1	0		23.29	23.29	23.21				
20	1	105		23.05	22.99	23.03				
20	100	0		23.26	23.31	23.20				
20	1	1	16-QAM	23.03	23.24	23.07	21.89	0.1545		
20	1	1	64-QAM	21.74	21.91	21.74				
20	1	1	256-QAM	19.14	19.25	19.20				
Limit	ERP < 7W			Result			Pass			



FR1 n7 Maximum Average Power [dBm] (GT - LC = 0.6 dB)										
BW [MHz]	RB Size	RB Offset	Mod	Lowest	Middle	Highest	EIRP (dBm)	EIRP(W)		
5	1	1	PI/2 BPSK	23.60	23.26	23.36	24.21	0.2636		
5	1	23		23.57	23.27	23.41				
5	12	6		23.52	23.24	23.34				
5	1	0		23.01	22.73	22.79				
5	1	24		23.02	22.85	22.87				
5	25	0		23.03	22.88	22.94				
5	1	1	QPSK	23.61	23.27	23.36			24.21	0.2636
5	1	23		23.53	23.36	23.41				
5	12	6		23.52	23.25	23.34				
5	1	0		22.50	22.31	22.41				
5	1	24		22.53	22.32	22.42				
5	25	0		22.56	22.29	22.44				
5	1	1	16-QAM	22.45	22.12	22.24	23.05	0.2018		
5	1	1	64-QAM	21.30	21.04	21.12				
5	1	1	256-QAM	18.65	18.27	18.38				
Limit	EIRP < 2W			Result			Pass			

FR1 n7 Maximum Average Power [dBm] (GT - LC = 0.6 dB)										
BW [MHz]	RB Size	RB Offset	Mod	Lowest	Middle	Highest	EIRP (dBm)	EIRP(W)		
10	1	1	PI/2 BPSK	23.52	23.01	23.12	24.25	0.2661		
10	1	50		23.47	23.20	23.21				
10	25	12		23.57	23.19	23.28				
10	1	0		22.92	23.65	22.69				
10	1	51		22.91	22.76	22.64				
10	50	0		23.06	22.67	22.80				
10	1	1	QPSK	23.53	23.06	23.17			24.25	0.2661
10	1	50		23.49	23.18	23.14				
10	25	12		23.56	23.20	23.23				
10	1	0		22.46	22.13	22.19				
10	1	51		22.45	22.18	22.26				
10	50	0		22.56	22.16	22.24				
10	1	1	16-QAM	22.49	22.94	22.04	23.54	0.2259		
10	1	1	64-QAM	21.23	20.75	21.03				
10	1	1	256-QAM	18.45	18.15	18.24				
Limit	EIRP < 2W			Result			Pass			



FR1 n7 Maximum Average Power [dBm] (GT - LC = 0.6 dB)										
BW [MHz]	RB Size	RB Offset	Mod	Lowest	Middle	Highest	EIRP (dBm)	EIRP(W)		
15	1	1	PI/2 BPSK	23.63	23.45	23.75	24.39	0.2748		
15	1	77		23.47	23.49	23.60				
15	36	18		23.69	23.46	23.75				
15	1	0		23.19	22.89	23.15				
15	1	78		22.93	22.98	23.12				
15	75	0		23.20	22.96	23.26				
15	1	1	QPSK	23.66	23.36	23.79			23.17	0.2075
15	1	77		23.62	23.54	23.63				
15	36	18		23.70	23.51	23.79				
15	1	0		22.65	22.45	22.78				
15	1	78		22.65	22.53	22.75				
15	75	0		22.75	22.54	22.82				
15	1	1	16-QAM	22.15	22.17	22.57	23.17	0.2075		
15	1	1	64-QAM	21.42	21.13	21.44				
15	1	1	256-QAM	18.69	18.45	18.78				
Limit	EIRP < 2W			Result			Pass			

FR1 n7 Maximum Average Power [dBm] (GT - LC = 0.6 dB)										
BW [MHz]	RB Size	RB Offset	Mod	Lowest	Middle	Highest	EIRP (dBm)	EIRP(W)		
20	1	1	PI/2 BPSK	23.57	23.34	23.42	24.19	0.2624		
20	1	104		23.31	23.51	23.24				
20	50	25		23.57	23.45	23.54				
20	1	0		23.14	22.89	22.84				
20	1	105		22.83	23.05	22.82				
20	100	0		23.03	22.96	22.98				
20	1	1	QPSK	23.57	23.36	23.44			23.03	0.2009
20	1	104		23.29	23.52	23.45				
20	50	25		23.59	23.49	23.56				
20	1	0		22.75	22.42	22.72				
20	1	105		22.29	22.54	22.72				
20	100	0		22.65	22.52	23.54				
20	1	1	16-QAM	22.43	22.18	22.33	23.03	0.2009		
20	1	1	64-QAM	21.24	21.16	21.19				
20	1	1	256-QAM	18.65	18.46	18.49				
Limit	EIRP < 2W			Result			Pass			



FR1 n7 Maximum Average Power [dBm] (GT - LC = 0.6 dB)								
BW [MHz]	RB Size	RB Offset	Mod	Lowest	Middle	Highest	EIRP (dBm)	EIRP(W)
25	1	1	PI/2 BPSK	23.78	23.33	23.55	24.40	0.2754
25	1	131		23.42	23.52	23.49		
25	64	32		23.71	23.49	23.67		
25	1	0		23.27	22.95	23.12		
25	1	132		22.98	23.02	23.04		
25	128	0		23.15	22.91	23.08		
25	1	1	QPSK	23.74	23.45	23.80		
25	1	131		22.55	23.57	23.59		
25	64	32		23.72	23.47	22.68		
25	1	0		22.74	22.45	22.62		
25	1	132		22.57	22.62	22.67		
25	128	0		22.70	22.42	22.68		
25	1	1	16-QAM	22.57	22.19	22.49	23.17	0.2075
25	1	1	64-QAM	21.52	21.12	21.32		
25	1	1	256-QAM	18.78	18.41	18.62		
Limit	EIRP < 2W			Result			Pass	

FR1 n7 Maximum Average Power [dBm] (GT - LC = 0.6 dB)								
BW [MHz]	RB Size	RB Offset	Mod	Lowest	Middle	Highest	EIRP (dBm)	EIRP(W)
30	1	1	PI/2 BPSK	23.56	23.42	23.35	24.17	0.2612
30	1	158		23.24	23.54	23.29		
30	80	40		23.41	23.44	23.35		
30	1	0		22.96	22.89	22.83		
30	1	159		22.78	23.04	22.76		
30	160	0		22.91	22.99	22.87		
30	1	1	QPSK	23.57	23.54	23.38		
30	1	158		23.33	23.57	23.35		
30	80	40		23.41	23.48	23.46		
30	1	0		22.48	22.46	22.34		
30	1	159		22.32	22.58	22.35		
30	160	0		22.45	22.49	22.42		
30	1	1	16-QAM	22.49	22.45	22.27	23.09	0.2037
30	1	1	64-QAM	21.32	21.27	21.04		
30	1	1	256-QAM	18.62	18.52	18.35		
Limit	EIRP < 2W			Result			Pass	



FR1 n7 Maximum Average Power [dBm] (GT - LC = 0.6 dB)								
BW [MHz]	RB Size	RB Offset	Mod	Lowest	Middle	Highest	EIRP (dBm)	EIRP(W)
40	1	1	PI/2 BPSK	23.73	23.54	23.36	24.35	0.2723
40	1	214		23.56	23.63	23.52		
40	108	54		23.61	23.35	22.63		
40	1	0		23.21	22.98	23.02		
40	1	215		23.01	23.06	23.12		
40	216	0		23.12	23.07	23.15		
40	1	1	QPSK	23.75	23.54	23.54		
40	1	214		23.52	23.52	23.53		
40	108	54		23.65	23.46	23.64		
40	1	0		22.74	22.97	22.35		
40	1	215		22.62	23.12	22.95		
40	216	0		22.62	23.05	22.68		
40	1	1	16-QAM	22.45	22.45	22.24	23.05	0.2018
40	1	1	64-QAM	21.38	21.29	21.18		
40	1	1	256-QAM	18.65	18.68	18.57		
Limit	EIRP < 2W			Result			Pass	



FR1 n12 Maximum Average Power [dBm] (GT - LC = -0.1 dB)								
BW [MHz]	RB Size	RB Offset	Mod	Lowest	Middle	Highest	ERP (dBm)	ERP(W)
5	1	1	PI/2 BPSK	23.73	23.72	23.66	21.55	0.1429
5	1	23		23.64	23.69	23.73		
5	12	6		23.67	23.73	23.65		
5	1	0		23.15	23.27	23.16		
5	1	24		23.10	23.17	23.23		
5	25	0		23.13	23.24	23.14		
5	1	1	QPSK	23.71	23.64	23.72		
5	1	23		23.64	23.64	23.80		
5	12	6		23.72	23.74	23.72		
5	1	0		22.69	22.74	22.71		
5	1	24		22.65	22.70	22.77		
5	25	0		22.71	22.74	22.70		
5	1	1	16-QAM	22.67	22.72	22.74	20.49	0.1119
5	1	1	64-QAM	21.33	21.32	21.35		
5	1	1	256-QAM	18.70	18.67	18.68		
Limit	ERP < 30W			Result			Pass	

FR1 n12 Maximum Average Power [dBm] (GT - LC = -0.1 dB)								
BW [MHz]	RB Size	RB Offset	Mod	Lowest	Middle	Highest	ERP (dBm)	ERP(W)
10	1	1	PI/2 BPSK	23.72	23.70	23.74	21.56	0.1432
10	1	50		23.64	23.65	23.70		
10	25	12		23.63	23.64	23.71		
10	1	0		23.33	23.20	23.33		
10	1	51		23.12	23.14	23.22		
10	50	0		23.09	23.11	23.27		
10	1	1	QPSK	23.70	23.71	23.81		
10	1	50		23.70	23.67	23.68		
10	25	12		23.64	23.62	23.78		
10	1	0		22.74	22.75	22.87		
10	1	51		22.71	22.61	22.68		
10	50	0		22.63	22.65	22.78		
10	1	1	16-QAM	22.80	22.71	22.80	20.55	0.1135
10	1	1	64-QAM	21.36	21.37	21.47		
10	1	1	256-QAM	18.61	18.61	18.67		
Limit	ERP < 30W			Result			Pass	



FR1 n12 Maximum Average Power [dBm] (GT - LC = -0.1 dB)										
BW [MHz]	RB Size	RB Offset	Mod	Lowest	Middle	Highest	ERP (dBm)	ERP(W)		
15	1	1	PI/2 BPSK	23.76	23.82	23.70	21.67	0.1469		
15	1	77		23.81	23.76	23.72				
15	36	18		23.92	23.85	23.78				
15	1	0		23.48	23.43	23.49				
15	1	78		23.29	23.26	23.15				
15	75	0		23.41	23.38	23.30				
15	1	1	QPSK	23.82	23.76	23.89			20.66	0.1164
15	1	77		23.84	23.77	23.76				
15	36	18		23.83	23.85	23.78				
15	1	0		23.02	22.97	23.04				
15	1	78		22.75	22.76	22.72				
15	75	0		22.93	22.85	22.81				
15	1	1	16-QAM	22.88	22.91	22.85	20.66	0.1164		
15	1	1	64-QAM	21.44	21.46	21.60				
15	1	1	256-QAM	18.82	18.77	18.71				
Limit	ERP < 30W			Result			Pass			



FR1 n25 Maximum Average Power [dBm] (GT - LC = 1.6 dB)										
BW [MHz]	RB Size	RB Offset	Mod	Lowest	Middle	Highest	EIRP (dBm)	EIRP(W)		
5	1	1	PI/2 BPSK	23.96	23.87	23.79	25.79	0.3793		
5	1	23		23.91	23.88	23.76				
5	12	6		23.86	23.89	23.70				
5	1	0		23.42	23.39	23.31				
5	1	24		23.46	23.31	23.22				
5	25	0		23.47	23.46	23.42				
5	1	1	QPSK	23.91	23.91	23.85			24.45	0.2786
5	1	23		24.19	24.01	23.80				
5	12	6		23.82	23.92	23.71				
5	1	0		23.11	23.02	22.83				
5	1	24		23.09	22.92	22.80				
5	25	0		22.91	22.99	22.81				
5	1	1	16-QAM	22.67	22.85	22.63	24.45	0.2786		
5	1	1	64-QAM	21.62	21.65	21.47				
5	1	1	256-QAM	18.95	18.94	18.91				
Limit	EIRP < 2W			Result			Pass			

FR1 n25 Maximum Average Power [dBm] (GT - LC = 1.6 dB)										
BW [MHz]	RB Size	RB Offset	Mod	Lowest	Middle	Highest	EIRP (dBm)	EIRP(W)		
10	1	1	PI/2 BPSK	23.96	24.00	23.84	25.64	0.3664		
10	1	50		23.90	23.94	23.82				
10	25	12		24.01	24.04	23.88				
10	1	0		23.39	23.47	23.30				
10	1	51		23.39	23.45	23.34				
10	50	0		23.52	23.55	23.34				
10	1	1	QPSK	23.98	23.99	23.79			24.45	0.2786
10	1	50		23.90	23.92	23.81				
10	25	12		24.04	24.02	23.82				
10	1	0		23.02	22.95	22.82				
10	1	51		22.97	22.95	22.83				
10	50	0		23.03	23.00	22.83				
10	1	1	16-QAM	22.83	22.85	22.65	24.45	0.2786		
10	1	1	64-QAM	21.67	21.60	21.51				
10	1	1	256-QAM	18.98	19.01	18.78				
Limit	EIRP < 2W			Result			Pass			



FR1 n25 Maximum Average Power [dBm] (GT - LC = 1.6 dB)								
BW [MHz]	RB Size	RB Offset	Mod	Lowest	Middle	Highest	EIRP (dBm)	EIRP(W)
15	1	1	PI/2 BPSK	24.20	24.03	23.97	25.87	0.3864
15	1	77		24.12	24.02	23.87		
15	36	18		24.16	24.05	24.03		
15	1	0		23.70	23.59	23.51		
15	1	78		23.64	23.63	23.36		
15	75	0		23.68	23.62	23.52		
15	1	1	QPSK	24.27	24.09	24.21		
15	1	77		24.13	24.14	24.17		
15	36	18		24.17	24.10	24.01		
15	1	0		23.24	23.11	22.97		
15	1	78		23.20	23.11	23.06		
15	75	0		23.21	23.16	22.97		
15	1	1	16-QAM	23.02	23.00	22.82	24.62	0.2897
15	1	1	64-QAM	21.93	21.82	21.60		
15	1	1	256-QAM	19.19	19.14	19.00		
Limit	EIRP < 2W			Result			Pass	

FR1 n25 Maximum Average Power [dBm] (GT - LC = 1.6 dB)								
BW [MHz]	RB Size	RB Offset	Mod	Lowest	Middle	Highest	EIRP (dBm)	EIRP(W)
20	1	1	PI/2 BPSK	24.13	23.97	24.02	25.81	0.3811
20	1	104		24.11	23.92	23.90		
20	50	25		24.17	24.11	24.01		
20	1	0		23.65	23.52	23.55		
20	1	105		23.59	23.44	23.35		
20	100	0		23.66	23.57	23.51		
20	1	1	QPSK	24.17	24.07	24.03		
20	1	104		24.14	24.00	23.92		
20	50	25		24.21	24.08	24.02		
20	1	0		23.13	23.05	23.07		
20	1	105		23.15	23.02	22.96		
20	100	0		23.20	23.11	23.05		
20	1	1	16-QAM	22.93	22.87	22.93	24.53	0.2838
20	1	1	64-QAM	21.90	21.69	21.71		
20	1	1	256-QAM	19.11	19.10	19.12		
Limit	EIRP < 2W			Result			Pass	



FR1 n25 Maximum Average Power [dBm] (GT - LC = 1.6 dB)										
BW [MHz]	RB Size	RB Offset	Mod	Lowest	Middle	Highest	EIRP (dBm)	EIRP(W)		
25	1	1	PI/2 BPSK	24.09	24.06	23.98	25.76	0.3767		
25	1	131		24.06	23.99	23.82				
25	64	32		24.09	24.14	23.95				
25	1	0		23.65	23.57	23.56				
25	1	132		23.58	23.52	23.31				
25	128	0		23.62	23.60	23.45				
25	1	1	QPSK	24.12	24.16	24.07			24.58	0.2871
25	1	131		24.14	24.01	23.88				
25	64	32		24.12	24.10	23.99				
25	1	0		23.16	23.16	23.06				
25	1	132		23.14	23.12	22.91				
25	128	0		23.14	23.09	22.96				
25	1	1	16-QAM	22.98	22.97	22.92	24.58	0.2871		
25	1	1	64-QAM	21.85	21.79	21.72				
25	1	1	256-QAM	19.16	19.16	19.11				
Limit	EIRP < 2W			Result			Pass			

FR1 n25 Maximum Average Power [dBm] (GT - LC = 1.6 dB)										
BW [MHz]	RB Size	RB Offset	Mod	Lowest	Middle	Highest	EIRP (dBm)	EIRP(W)		
30	1	1	PI/2 BPSK	24.16	23.99	24.10	25.85	0.3846		
30	1	158		24.12	24.00	23.96				
30	80	40		24.22	24.21	24.18				
30	1	0		23.72	23.64	23.69				
30	1	159		23.58	23.56	23.49				
30	160	0		23.76	23.71	23.68				
30	1	1	QPSK	24.25	23.99	24.15			24.68	0.2938
30	1	158		24.15	24.05	23.94				
30	80	40		24.24	24.24	24.20				
30	1	0		23.25	23.22	23.22				
30	1	159		23.19	23.06	23.01				
30	160	0		23.28	23.26	23.16				
30	1	1	16-QAM	23.08	22.97	22.99	24.68	0.2938		
30	1	1	64-QAM	21.86	21.67	21.76				
30	1	1	256-QAM	19.26	19.14	19.19				
Limit	EIRP < 2W			Result			Pass			



FR1 n25 Maximum Average Power [dBm] (GT - LC = 1.6 dB)										
BW [MHz]	RB Size	RB Offset	Mod	Lowest	Middle	Highest	EIRP (dBm)	EIRP(W)		
40	1	1	PI/2 BPSK	24.16	24.07	24.04	25.91	0.3899		
40	1	214		24.17	23.53	23.97				
40	108	54		24.15	24.25	24.24				
40	1	0		23.62	23.66	23.77				
40	1	215		23.67	23.58	23.53				
40	216	0		23.66	23.68	23.69				
40	1	1	QPSK	24.16	24.14	24.15			24.67	0.2931
40	1	214		24.19	24.08	24.06				
40	108	54		24.25	24.31	24.26				
40	1	0		23.15	23.14	23.22				
40	1	215		23.18	23.06	23.06				
40	216	0		23.17	23.22	23.26				
40	1	1	16-QAM	22.98	22.93	23.07	24.67	0.2931		
40	1	1	64-QAM	21.82	22.12	21.85				
40	1	1	256-QAM	19.19	19.21	19.30				
Limit	EIRP < 2W			Result			Pass			



FR1 n26 Maximum Average Power [dBm] (GT - LC = 0.8 dB)								
BW [MHz]	RB Size	RB Offset	Mod	Lowest	Middle	Highest	ERP (dBm)	ERP(W)
5	1	1	PI/2 BPSK	24.02	24.09	24.10	22.80	0.1905
5	1	23		24.00	24.06	23.96		
5	12	6		24.11	24.07	24.06		
5	1	0		23.60	23.56	23.56		
5	1	24		23.56	23.52	23.50		
5	25	0		23.62	23.65	23.55		
5	1	1	QPSK	24.06	24.15	24.06		
5	1	23		24.07	24.05	24.03		
5	12	6		24.07	24.09	24.02		
5	1	0		23.13	23.09	23.06		
5	1	24		23.07	23.09	22.97		
5	25	0		23.08	23.09	23.06		
5	1	1	16-QAM	23.06	23.13	23.17	21.82	0.1521
5	1	1	64-QAM	21.70	21.71	21.78		
5	1	1	256-QAM	19.07	19.06	19.14		
Limit	ERP < 7W			Result			Pass	

FR1 n26 Maximum Average Power [dBm] (GT - LC = 0.8 dB)								
BW [MHz]	RB Size	RB Offset	Mod	Lowest	Middle	Highest	ERP (dBm)	ERP(W)
10	1	1	PI/2 BPSK	23.97	24.03	23.94	22.80	0.1905
10	1	50		24.15	24.00	23.89		
10	25	12		24.03	24.11	24.07		
10	1	0		23.64	23.58	23.53		
10	1	51		23.56	23.50	23.39		
10	50	0		23.57	23.60	23.55		
10	1	1	QPSK	24.03	24.11	24.06		
10	1	50		24.06	24.06	24.01		
10	25	12		24.09	24.09	24.00		
10	1	0		23.16	23.12	23.09		
10	1	51		23.07	23.02	22.91		
10	50	0		23.10	23.12	22.98		
10	1	1	16-QAM	23.06	22.98	23.06	21.71	0.1483
10	1	1	64-QAM	21.64	21.74	21.63		
10	1	1	256-QAM	19.09	19.17	19.00		
Limit	ERP < 7W			Result			Pass	



FR1 n26 Maximum Average Power [dBm] (GT - LC = 0.8 dB)										
BW [MHz]	RB Size	RB Offset	Mod	Lowest	Middle	Highest	ERP (dBm)	ERP(W)		
15	1	1	PI/2 BPSK	24.15	24.32	24.11	22.97	0.1982		
15	1	77		24.11	24.09	24.12				
15	36	18		24.14	24.16	24.07				
15	1	0		23.71	23.73	23.63				
15	1	78		23.63	23.54	23.57				
15	75	0		23.75	23.67	23.69				
15	1	1	QPSK	24.15	24.25	24.16			21.99	0.1581
15	1	77		24.14	24.11	24.01				
15	36	18		24.15	24.16	24.05				
15	1	0		23.29	23.27	23.12				
15	1	78		23.11	23.09	23.06				
15	75	0		23.20	23.17	23.14				
15	1	1	16-QAM	23.19	23.34	23.17	21.99	0.1581		
15	1	1	64-QAM	21.86	21.89	21.82				
15	1	1	256-QAM	19.19	19.26	19.09				
Limit	ERP < 7W			Result			Pass			

FR1 n26 Maximum Average Power [dBm] (GT - LC = 0.8 dB)										
BW [MHz]	RB Size	RB Offset	Mod	Lowest	Middle	Highest	ERP (dBm)	ERP(W)		
20	1	1	PI/2 BPSK	24.16	24.10	24.16	22.85	0.1928		
20	1	104		23.96	24.07	24.06				
20	50	25		24.09	24.20	24.07				
20	1	0		23.67	23.70	23.65				
20	1	105		23.51	23.54	23.58				
20	100	0		23.62	23.71	23.67				
20	1	1	QPSK	24.09	24.16	24.16			21.93	0.1560
20	1	104		24.14	24.12	24.02				
20	50	25		24.14	24.14	24.11				
20	1	0		23.27	23.26	23.16				
20	1	105		23.09	23.07	23.04				
20	100	0		23.15	23.22	23.16				
20	1	1	16-QAM	23.14	23.21	23.28	21.93	0.1560		
20	1	1	64-QAM	21.69	21.76	21.89				
20	1	1	256-QAM	19.13	19.17	19.20				
Limit	ERP < 7W			Result			Pass			



FR1 n38 Maximum Average Power [dBm] (GT - LC = 2.8 dB)								
BW [MHz]	RB Size	RB Offset	Mod	Lowest	Middle	Highest	EIRP (dBm)	EIRP(W)
10	1	1	PI/2 BPSK	23.53	23.59	23.43	26.47	0.4436
10	1	22		23.63	23.56	23.48		
10	12	6		23.60	23.67	23.43		
10	1	0		23.06	23.13	22.86		
10	1	23		23.11	23.03	22.87		
10	24	0		23.18	23.14	22.93		
10	1	1	QPSK	23.46	23.57	23.39		
10	1	22		23.66	23.50	23.33		
10	12	6		23.59	23.64	23.46		
10	1	0		22.62	22.64	22.39		
10	1	23		22.59	22.56	22.36		
10	24	0		22.81	22.66	22.46		
10	1	1	16-QAM	22.36	22.50	22.24	25.30	0.3388
10	1	1	64-QAM	21.06	21.17	20.94		
10	1	1	256-QAM	19.06	19.18	18.86		
Limit	EIRP < 2W			Result			Pass	

FR1 n38 Maximum Average Power [dBm] (GT - LC = 2.8 dB)								
BW [MHz]	RB Size	RB Offset	Mod	Lowest	Middle	Highest	EIRP (dBm)	EIRP(W)
15	1	1	PI/2 BPSK	23.81	23.68	23.69	26.71	0.4688
15	1	36		23.90	23.57	23.64		
15	18	9		23.85	23.63	23.66		
15	1	0		23.28	23.15	23.17		
15	1	37		23.38	23.06	23.12		
15	36	0		23.38	23.13	23.18		
15	1	1	QPSK	23.75	23.62	23.65		
15	1	36		23.91	23.52	23.62		
15	18	9		23.87	23.66	23.73		
15	1	0		22.75	22.62	22.65		
15	1	37		22.86	22.53	22.62		
15	36	0		22.85	22.64	22.69		
15	1	1	16-QAM	22.63	22.47	22.56	25.43	0.3491
15	1	1	64-QAM	21.32	21.16	21.21		
15	1	1	256-QAM	19.26	19.19	19.18		
Limit	EIRP < 2W			Result			Pass	



FR1 n38 Maximum Average Power [dBm] (GT - LC = 2.8 dB)								
BW [MHz]	RB Size	RB Offset	Mod	Lowest	Middle	Highest	EIRP (dBm)	EIRP(W)
20	1	1	PI/2 BPSK	23.84	23.80	23.67	26.79	0.4775
20	1	49		23.89	23.49	23.57		
20	25	12		23.99	23.60	23.68		
20	1	0		23.30	23.19	23.15		
20	1	50		23.37	22.93	23.05		
20	50	0		23.46	23.10	23.16		
20	1	1	QPSK	23.82	23.73	23.69	25.43	0.3491
20	1	49		23.82	23.36	23.55		
20	25	12		23.93	23.64	23.63		
20	1	0		22.83	22.64	22.66		
20	1	50		22.85	22.40	22.59		
20	50	0		23.07	22.83	22.62		
20	1	1	16-QAM	22.59	22.63	22.41	25.43	0.3491
20	1	1	64-QAM	21.33	21.36	21.20		
20	1	1	256-QAM	19.34	19.40	19.15		
Limit	EIRP < 2W			Result			Pass	



FR1 n38 Maximum Average Power [dBm] (GT - LC = 2.8 dB)								
BW [MHz]	RB Size	RB Offset	Mod	Lowest	Middle	Highest	EIRP (dBm)	EIRP(W)
30	1	1	PI/2 BPSK	23.78	23.77	23.81	26.65	0.4624
30	1	76		23.69	23.54	23.49		
30	36	18		23.82	23.73	23.59		
30	1	0		23.38	23.37	23.30		
30	1	77		23.12	23.10	23.02		
30	75	0		23.36	23.26	23.13		
30	1	1	QPSK	23.74	23.76	23.75		
30	1	76		23.63	23.48	23.44		
30	36	18		23.85	23.73	23.58		
30	1	0		22.85	22.85	22.76		
30	1	77		22.62	22.49	22.47		
30	75	0		22.86	22.76	22.63		
30	1	1	16-QAM	22.65	22.71	22.63	25.51	0.3556
30	1	1	64-QAM	21.36	21.23	21.36		
30	1	1	256-QAM	19.23	19.33	19.36		
Limit	EIRP < 2W			Result			Pass	

FR1 n38 Maximum Average Power [dBm] (GT - LC = 2.8 dB)								
BW [MHz]	RB Size	RB Offset	Mod	Lowest	Middle	Highest	EIRP (dBm)	EIRP(W)
40	1	1	PI/2 BPSK	23.82	23.96	23.93	26.76	0.4742
40	1	104		23.60	23.54	23.66		
40	50	25		23.89	23.73	23.79		
40	1	0		23.36	23.36	23.46		
40	1	105		23.07	23.06	23.07		
40	100	0		23.37	23.20	23.23		
40	1	1	QPSK	23.78	23.75	23.92		
40	1	104		23.57	23.52	23.53		
40	50	25		23.86	23.73	23.74		
40	1	0		22.90	22.95	22.93		
40	1	105		22.59	22.47	22.59		
40	100	0		22.86	22.75	22.85		
40	1	1	16-QAM	22.62	22.64	22.85	25.65	0.3673
40	1	1	64-QAM	21.33	21.36	21.47		
40	1	1	256-QAM	19.30	19.29	19.46		
Limit	EIRP < 2W			Result			Pass	



FR1 n41 HPUE Maximum Average Power [dBm] (GT - LC = 2.8 dB)								
BW [MHz]	RB Size	RB Offset	Mod	Lowest	Middle	Highest	EIRP (dBm)	EIRP(W)
20	1	1	PI/2 BPSK	27.22	27.46	26.94	30.26	1.0617
20	1	49		27.34	27.31	27.07		
20	25	12		27.35	27.45	27.02		
20	1	0		23.82	24.00	23.41		
20	1	50		23.86	23.80	23.52		
20	50	0		26.85	26.97	26.55		
20	1	1	QPSK	27.12	27.41	26.83		
20	1	49		27.25	27.21	26.92		
20	25	12		27.32	27.45	27.01		
20	1	0		23.82	23.95	23.37		
20	1	50		23.87	23.71	23.49		
20	50	0		26.39	26.44	26.02		
20	1	1	16-QAM	26.11	26.31	25.76	29.11	0.8147
20	1	1	64-QAM	24.92	25.07	24.46		
20	1	1	256-QAM	22.86	23.01	22.49		
Limit	EIRP < 2W			Result			Pass	

FR1 n41 HPUE Maximum Average Power [dBm] (GT - LC = 2.8 dB)								
BW [MHz]	RB Size	RB Offset	Mod	Lowest	Middle	Highest	EIRP (dBm)	EIRP(W)
30	1	1	PI/2 BPSK	27.30	27.41	27.03	30.29	1.0691
30	1	76		27.49	27.18	27.27		
30	36	18		27.40	27.42	26.97		
30	1	0		23.90	23.99	23.44		
30	1	77		24.04	23.81	23.71		
30	75	0		26.97	26.92	26.52		
30	1	1	QPSK	27.22	27.35	26.99		
30	1	76		27.45	27.21	27.18		
30	36	18		27.41	27.42	26.94		
30	1	0		23.87	23.99	23.45		
30	1	77		24.04	23.79	23.72		
30	75	0		26.47	26.38	26.01		
30	1	1	16-QAM	26.12	26.23	25.89	29.03	0.7998
30	1	1	64-QAM	24.92	24.97	24.64		
30	1	1	256-QAM	22.83	22.87	22.56		
Limit	EIRP < 2W			Result			Pass	



FR1 n41 HPUE Maximum Average Power [dBm] (GT - LC = 2.8 dB)										
BW [MHz]	RB Size	RB Offset	Mod	Lowest	Middle	Highest	EIRP (dBm)	EIRP(W)		
40	1	1	PI/2 BPSK	27.33	27.41	27.12	30.25	1.0593		
40	1	104		27.41	27.24	27.15				
40	50	25		27.38	27.45	26.97				
40	1	0		23.91	24.06	23.67				
40	1	105		23.95	23.78	23.69				
40	100	0		26.90	26.92	26.52				
40	1	1	QPSK	27.25	27.41	27.15			29.15	0.8222
40	1	104		27.34	27.19	27.11				
40	50	25		27.41	27.44	26.95				
40	1	0		23.87	24.01	23.65				
40	1	105		23.85	23.71	23.65				
40	100	0		26.35	26.40	26.02				
40	1	1	16-QAM	26.12	26.35	26.06	29.15	0.8222		
40	1	1	64-QAM	24.76	24.91	24.61				
40	1	1	256-QAM	22.75	22.97	22.70				
Limit	EIRP < 2W			Result			Pass			

FR1 n41 HPUE Maximum Average Power [dBm] (GT - LC = 2.8 dB)										
BW [MHz]	RB Size	RB Offset	Mod	Lowest	Middle	Highest	EIRP (dBm)	EIRP(W)		
50	1	1	PI/2 BPSK	27.34	27.32	27.21	30.22	1.052		
50	1	131		27.36	27.17	27.16				
50	64	32		27.41	27.42	27.08				
50	1	0		23.88	23.99	23.67				
50	1	132		23.93	23.71	23.65				
50	128	0		26.93	26.94	26.61				
50	1	1	QPSK	27.26	27.27	27.25			29.01	0.7962
50	1	131		27.34	27.16	27.12				
50	64	32		27.42	27.42	27.02				
50	1	0		23.84	23.94	23.64				
50	1	132		23.88	23.71	23.64				
50	128	0		26.37	26.41	26.14				
50	1	1	16-QAM	26.21	26.14	26.08	29.01	0.7962		
50	1	1	64-QAM	24.91	24.83	24.72				
50	1	1	256-QAM	22.85	22.88	22.78				
Limit	EIRP < 2W			Result			Pass			



FR1 n41 HPUE Maximum Average Power [dBm] (GT - LC = 2.8 dB)										
BW [MHz]	RB Size	RB Offset	Mod	Lowest	Middle	Highest	EIRP (dBm)	EIRP(W)		
60	1	1	PI/2 BPSK	27.19	27.26	27.11	30.21	1.0495		
60	1	160		27.15	27.04	27.01				
60	81	40		27.37	27.41	27.04				
60	1	0		23.84	23.92	23.61				
60	1	161		23.65	23.57	23.52				
60	162	0		26.81	26.91	26.57				
60	1	1	QPSK	27.17	27.21	27.07			30.21	1.0495
60	1	160		27.09	27.01	26.93				
60	81	40		27.31	27.39	27.02				
60	1	0		23.78	23.87	23.55				
60	1	161		23.67	23.56	23.55				
60	162	0		26.31	26.39	26.13				
60	1	1	16-QAM	26.02	26.14	26.10	28.94	0.7834		
60	1	1	64-QAM	24.76	24.74	24.58				
60	1	1	256-QAM	22.81	22.85	22.72				
Limit	EIRP < 2W			Result			Pass			

FR1 n41 HPUE Maximum Average Power [dBm] (GT - LC = 2.8 dB)										
BW [MHz]	RB Size	RB Offset	Mod	Lowest	Middle	Highest	EIRP (dBm)	EIRP(W)		
70	1	1	PI/2 BPSK	27.07	27.00	26.85	30.06	1.0139		
70	1	187		27.02	26.92	26.76				
70	90	45		27.19	27.26	26.82				
70	1	0		23.72	23.76	23.31				
70	1	188		23.53	23.42	23.27				
70	180	0		26.71	26.64	26.37				
70	1	1	QPSK	27.11	26.96	26.84			30.06	1.0139
70	1	187		27.01	26.85	26.71				
70	90	45		27.21	27.23	26.81				
70	1	0		23.67	23.73	23.29				
70	1	188		23.48	23.44	23.22				
70	180	0		26.31	26.11	25.87				
70	1	1	16-QAM	26.04	25.84	25.72	28.84	0.7656		
70	1	1	64-QAM	24.69	24.59	24.47				
70	1	1	256-QAM	22.72	22.57	22.43				
Limit	EIRP < 2W			Result			Pass			



FR1 n41 HPUE Maximum Average Power [dBm] (GT - LC = 2.8 dB)								
BW [MHz]	RB Size	RB Offset	Mod	Lowest	Middle	Highest	EIRP (dBm)	EIRP(W)
80	1	1	PI/2 BPSK	27.06	27.00	26.92	30.05	1.0116
80	1	215		27.04	27.00	26.88		
80	108	54		27.24	27.25	26.94		
80	1	0		23.83	23.74	23.28		
80	1	216		23.65	23.55	23.37		
80	216	0		26.67	26.62	26.41		
80	1	1	QPSK	27.05	26.97	26.91		
80	1	215		27.00	26.96	26.81		
80	108	54		27.21	27.24	26.97		
80	1	0		23.76	23.71	23.22		
80	1	216		23.65	23.48	23.33		
80	216	0		26.15	26.14	25.91		
80	1	1	16-QAM	25.90	25.90	25.83	28.70	0.7413
80	1	1	64-QAM	24.54	24.51	24.52		
80	1	1	256-QAM	22.67	22.61	22.51		
Limit	EIRP < 2W			Result			Pass	

FR1 n41 HPUE Maximum Average Power [dBm] (GT - LC = 2.8 dB)								
BW [MHz]	RB Size	RB Offset	Mod	Lowest	Middle	Highest	EIRP (dBm)	EIRP(W)
90	1	1	PI/2 BPSK	27.06	27.05	27.04	30.07	1.0162
90	1	243		27.25	27.08	27.01		
90	120	60		27.27	27.26	27.14		
90	1	0		23.78	23.78	23.45		
90	1	244		23.76	23.63	23.48		
90	240	0		26.75	26.62	26.54		
90	1	1	QPSK	27.02	27.02	27.04		
90	1	243		27.24	27.10	26.95		
90	120	60		27.25	27.25	27.16		
90	1	0		23.76	23.75	23.35		
90	1	244		23.74	23.60	23.46		
90	240	0		26.26	26.16	26.07		
90	1	1	16-QAM	26.01	25.91	26.07	28.87	0.7709
90	1	1	64-QAM	24.62	24.50	24.67		
90	1	1	256-QAM	22.61	22.58	22.60		
Limit	EIRP < 2W			Result			Pass	



FR1 n41 HPUE Maximum Average Power [dBm] (GT - LC = 2.8 dB)										
BW [MHz]	RB Size	RB Offset	Mod	Lowest	Middle	Highest	EIRP (dBm)	EIRP(W)		
100	1	1	PI/2 BPSK	27.07	27.09	27.27	30.07	1.0162		
100	1	271		27.08	27.15	26.93				
100	135	67		27.18	27.24	27.08				
100	1	0		23.76	23.86	23.71				
100	1	272		23.61	23.69	23.47				
100	270	0		26.62	26.61	26.54				
100	1	1	QPSK	27.00	27.04	27.21			28.87	0.7709
100	1	271		27.04	27.11	26.87				
100	135	67		27.15	27.27	27.02				
100	1	0		23.80	23.80	23.70				
100	1	272		23.55	23.65	23.43				
100	270	0		26.17	26.14	26.04				
100	1	1	16-QAM	25.92	26.01	26.07	28.87	0.7709		
100	1	1	64-QAM	24.62	24.52	24.71				
100	1	1	256-QAM	22.67	22.62	22.78				
Limit	EIRP < 2W			Result			Pass			



FR1 n66 Maximum Average Power [dBm] (GT - LC = 1.8 dB)								
BW [MHz]	RB Size	RB Offset	Mod	Lowest	Middle	Highest	EIRP (dBm)	EIRP(W)
5	1	1	PI/2 BPSK	23.92	24.15	23.93	25.95	0.3936
5	1	23		24.01	24.08	23.82		
5	12	6		24.05	24.09	23.88		
5	1	0		23.54	23.63	23.42		
5	1	24		23.56	23.61	23.39		
5	25	0		23.57	23.68	23.45		
5	1	1	QPSK	23.93	24.07	23.91		
5	1	23		24.03	24.11	23.87		
5	12	6		24.04	24.11	23.93		
5	1	0		23.01	23.08	22.91		
5	1	24		23.01	23.13	22.85		
5	25	0		23.09	23.15	22.94		
5	1	1	16-QAM	22.91	23.05	22.81	24.85	0.3055
5	1	1	64-QAM	21.61	21.75	21.60		
5	1	1	256-QAM	18.90	19.09	18.89		
Limit	EIRP < 1W			Result			Pass	

FR1 n66 Maximum Average Power [dBm] (GT - LC = 1.8 dB)								
BW [MHz]	RB Size	RB Offset	Mod	Lowest	Middle	Highest	EIRP (dBm)	EIRP(W)
10	1	1	PI/2 BPSK	23.95	24.06	23.92	25.90	0.3890
10	1	50		24.07	24.03	23.90		
10	25	12		24.02	24.10	23.91		
10	1	0		23.55	23.52	23.41		
10	1	51		23.57	23.53	23.33		
10	50	0		23.59	23.52	23.38		
10	1	1	QPSK	23.92	24.02	23.88		
10	1	50		23.90	24.04	23.84		
10	25	12		24.06	24.03	23.90		
10	1	0		23.06	23.08	22.91		
10	1	51		22.91	23.04	22.97		
10	50	0		23.05	23.03	22.91		
10	1	1	16-QAM	22.81	22.89	22.82	24.69	0.2944
10	1	1	64-QAM	21.62	21.66	21.60		
10	1	1	256-QAM	18.90	18.99	18.86		
Limit	EIRP < 1W			Result			Pass	



FR1 n66 Maximum Average Power [dBm] (GT - LC = 1.8 dB)								
BW [MHz]	RB Size	RB Offset	Mod	Lowest	Middle	Highest	EIRP (dBm)	EIRP(W)
15	1	1	PI/2 BPSK	24.00	24.20	24.02	26.08	0.4055
15	1	77		24.16	24.14	23.89		
15	36	18		24.10	24.24	24.05		
15	1	0		23.57	23.77	23.57		
15	1	78		23.62	23.67	23.39		
15	75	0		23.62	23.80	23.56		
15	1	1	QPSK	23.98	24.18	24.08		
15	1	77		24.08	24.27	23.94		
15	36	18		24.07	24.28	24.07		
15	1	0		23.07	23.27	23.07		
15	1	78		23.13	23.18	22.89		
15	75	0		24.09	23.27	23.11		
15	1	1	16-QAM	22.92	23.10	22.98	24.90	0.309
15	1	1	64-QAM	21.68	21.89	21.71		
15	1	1	256-QAM	19.00	19.15	19.01		
Limit	EIRP < 1W			Result			Pass	

FR1 n66 Maximum Average Power [dBm] (GT - LC = 1.8 dB)								
BW [MHz]	RB Size	RB Offset	Mod	Lowest	Middle	Highest	EIRP (dBm)	EIRP(W)
20	1	1	PI/2 BPSK	23.97	24.11	24.11	26.10	0.4074
20	1	104		24.02	24.18	23.77		
20	50	25		24.04	24.30	24.13		
20	1	0		23.57	23.81	23.62		
20	1	105		23.69	23.67	23.36		
20	100	0		23.60	23.69	23.57		
20	1	1	QPSK	24.01	24.08	24.10		
20	1	104		24.19	24.22	23.96		
20	50	25		24.09	24.23	24.14		
20	1	0		23.12	23.30	23.16		
20	1	105		23.24	23.21	22.97		
20	100	0		23.07	23.22	23.17		
20	1	1	16-QAM	22.93	23.05	23.05	24.85	0.3055
20	1	1	64-QAM	21.67	21.77	21.72		
20	1	1	256-QAM	18.95	19.05	19.11		
Limit	EIRP < 1W			Result			Pass	



FR1 n66 Maximum Average Power [dBm] (GT - LC = 1.8 dB)										
BW [MHz]	RB Size	RB Offset	Mod	Lowest	Middle	Highest	EIRP (dBm)	EIRP(W)		
30	1	1	PI/2 BPSK	24.05	24.15	24.24	26.08	0.4055		
30	1	158		24.11	24.09	23.84				
30	80	40		24.10	24.18	24.13				
30	1	0		23.68	23.82	23.64				
30	1	159		23.60	23.55	23.38				
30	160	0		23.62	23.70	23.63				
30	1	1	QPSK	24.01	24.11	24.28			26.08	0.4055
30	1	158		24.13	24.13	23.92				
30	80	40		24.12	24.14	24.18				
30	1	0		23.30	23.30	23.17				
30	1	159		23.07	23.07	22.91				
30	160	0		23.14	23.24	23.18				
30	1	1	16-QAM	22.97	23.09	23.19	24.99	0.3155		
30	1	1	64-QAM	21.73	21.77	21.91				
30	1	1	256-QAM	19.01	19.16	19.22				
Limit	EIRP < 1W			Result			Pass			

FR1 n66 Maximum Average Power [dBm] (GT - LC = 1.8 dB)										
BW [MHz]	RB Size	RB Offset	Mod	Lowest	Middle	Highest	EIRP (dBm)	EIRP(W)		
40	1	1	PI/2 BPSK	23.91	24.07	24.09	26.01	0.399		
40	1	214		24.11	23.81	23.83				
40	108	54		24.07	24.11	24.14				
40	1	0		23.70	23.61	23.60				
40	1	215		23.63	23.29	23.34				
40	216	0		23.61	23.64	23.61				
40	1	1	QPSK	23.97	24.21	24.09			26.01	0.399
40	1	214		24.13	24.01	23.79				
40	108	54		24.15	24.12	24.12				
40	1	0		23.25	23.18	23.12				
40	1	215		23.18	22.95	22.88				
40	216	0		23.11	23.13	23.09				
40	1	1	16-QAM	22.90	23.04	23.05	24.85	0.3055		
40	1	1	64-QAM	21.54	21.76	21.78				
40	1	1	256-QAM	18.91	19.06	19.01				
Limit	EIRP < 1W			Result			Pass			



FR1 n71 Maximum Average Power [dBm] (GT - LC = 1 dB)								
BW [MHz]	RB Size	RB Offset	Mod	Lowest	Middle	Highest	ERP (dBm)	ERP(W)
5	1	1	PI/2 BPSK	23.74	23.37	23.68	22.59	0.1816
5	1	23		23.61	23.48	23.71		
5	12	6		23.60	23.52	23.71		
5	1	0		23.19	22.99	23.16		
5	1	24		23.08	22.89	23.18		
5	25	0		23.09	23.03	23.15		
5	1	1	QPSK	23.70	23.41	23.66		
5	1	23		23.55	23.52	23.68		
5	12	6		23.66	23.50	23.66		
5	1	0		22.69	22.49	22.62		
5	1	24		22.60	22.50	22.71		
5	25	0		22.57	22.52	22.61		
5	1	1	16-QAM	22.69	22.50	22.66	21.54	0.1426
5	1	1	64-QAM	21.32	21.08	21.33		
5	1	1	256-QAM	18.66	18.38	18.66		
Limit	ERP < 30W			Result			Pass	

FR1 n71 Maximum Average Power [dBm] (GT - LC = 1 dB)								
BW [MHz]	RB Size	RB Offset	Mod	Lowest	Middle	Highest	ERP (dBm)	ERP(W)
10	1	1	PI/2 BPSK	23.71	23.64	23.58	22.56	0.1803
10	1	50		23.55	23.60	23.69		
10	25	12		23.63	23.51	23.59		
10	1	0		23.19	23.10	23.26		
10	1	51		23.07	23.00	23.18		
10	50	0		23.02	22.97	23.03		
10	1	1	QPSK	23.69	23.56	23.53		
10	1	50		23.47	23.58	23.68		
10	25	12		23.52	23.56	23.52		
10	1	0		22.67	22.59	22.80		
10	1	51		22.49	22.52	22.70		
10	50	0		22.55	22.52	22.60		
10	1	1	16-QAM	22.67	22.58	22.61	21.52	0.1419
10	1	1	64-QAM	21.19	21.13	21.11		
10	1	1	256-QAM	18.66	18.46	18.46		
Limit	ERP < 30W			Result			Pass	



FR1 n71 Maximum Average Power [dBm] (GT - LC = 1 dB)										
BW [MHz]	RB Size	RB Offset	Mod	Lowest	Middle	Highest	ERP (dBm)	ERP(W)		
15	1	1	PI/2 BPSK	23.59	23.64	23.57	22.54	0.1795		
15	1	77		23.49	23.50	23.59				
15	36	18		23.55	23.59	23.57				
15	1	0		23.28	23.19	23.17				
15	1	78		23.17	23.11	23.08				
15	75	0		23.08	23.08	23.08				
15	1	1	QPSK	23.64	23.66	23.50			21.41	0.1384
15	1	77		23.49	23.51	23.69				
15	36	18		23.61	23.58	23.59				
15	1	0		22.82	22.72	22.78				
15	1	78		22.72	22.57	22.72				
15	75	0		22.55	22.56	22.60				
15	1	1	16-QAM	22.56	22.52	22.39	21.41	0.1384		
15	1	1	64-QAM	21.20	21.21	21.07				
15	1	1	256-QAM	18.63	18.68	18.49				
Limit	ERP < 30W			Result			Pass			

FR1 n71 Maximum Average Power [dBm] (GT - LC = 1 dB)										
BW [MHz]	RB Size	RB Offset	Mod	Lowest	Middle	Highest	ERP (dBm)	ERP(W)		
20	1	1	PI/2 BPSK	23.53	23.55	23.67	22.57	0.1807		
20	1	104		23.51	23.60	23.72				
20	50	25		23.52	23.58	23.59				
20	1	0		23.38	23.31	23.35				
20	1	105		22.96	23.10	23.19				
20	100	0		22.99	23.19	23.10				
20	1	1	QPSK	23.52	23.59	23.64			21.58	0.1439
20	1	104		23.55	23.60	23.65				
20	50	25		23.55	23.56	23.63				
20	1	0		22.83	22.82	22.96				
20	1	105		22.52	22.60	22.75				
20	100	0		22.58	22.61	22.66				
20	1	1	16-QAM	22.55	22.58	22.73	21.58	0.1439		
20	1	1	64-QAM	20.82	21.20	21.26				
20	1	1	256-QAM	18.49	18.52	18.59				
Limit	ERP < 30W			Result			Pass			



FR1 n41 Maximum Average Power [dBm] (GT - LC = 2.8 dB)								
BW [MHz]	RB Size	RB Offset	Mod	Lowest	Middle	Highest	EIRP (dBm)	EIRP(W)
20	1	1	PI/2 BPSK	23.87	24.26	23.63	27.06	0.5082
20	1	49		24.07	24.02	23.81		
20	25	12		24.07	24.16	23.77		
20	1	0		23.99	24.19	23.63		
20	1	50		24.05	23.96	23.74		
20	50	0		24.06	24.12	23.81		
20	1	1	QPSK	23.86	24.12	23.63		
20	1	49		24.00	23.89	23.70		
20	25	12		24.07	24.13	23.81		
20	1	0		23.97	24.11	23.58		
20	1	50		24.00	23.90	23.78		
20	50	0		24.11	24.17	23.80		
20	1	1	16-QAM	23.75	24.01	23.52	26.81	0.4797
20	1	1	64-QAM	23.73	23.95	23.46		
20	1	1	256-QAM	23.23	23.44	23.01		
Limit	EIRP < 2W			Result			Pass	

FR1 n41 Maximum Average Power [dBm] (GT - LC = 2.8 dB)								
BW [MHz]	RB Size	RB Offset	Mod	Lowest	Middle	Highest	EIRP (dBm)	EIRP(W)
30	1	1	PI/2 BPSK	23.99	24.06	23.76	27.06	0.5082
30	1	76		24.25	24.01	23.94		
30	36	18		24.13	24.15	23.82		
30	1	0		24.18	24.21	23.74		
30	1	77		24.26	23.98	23.91		
30	75	0		24.17	24.15	23.85		
30	1	1	QPSK	23.98	24.05	23.72		
30	1	76		24.24	23.97	23.92		
30	36	18		24.15	24.13	23.78		
30	1	0		24.03	24.18	23.69		
30	1	77		24.20	23.96	23.90		
30	75	0		24.18	24.15	23.83		
30	1	1	16-QAM	23.83	23.94	23.58	26.74	0.4721
30	1	1	64-QAM	23.80	23.92	23.51		
30	1	1	256-QAM	23.35	23.37	23.10		
Limit	EIRP < 2W			Result			Pass	



FR1 n41 Maximum Average Power [dBm] (GT - LC = 2.8 dB)										
BW [MHz]	RB Size	RB Offset	Mod	Lowest	Middle	Highest	EIRP (dBm)	EIRP(W)		
40	1	1	PI/2 BPSK	24.00	24.13	23.86	27.05	0.5070		
40	1	104		24.15	23.95	23.85				
40	50	25		24.18	24.17	23.70				
40	1	0		24.12	24.25	23.88				
40	1	105		24.21	23.99	23.90				
40	100	0		24.11	24.20	23.78				
40	1	1	QPSK	23.93	24.11	23.81			26.76	0.4742
40	1	104		24.19	23.92	23.84				
40	50	25		24.11	24.17	23.69				
40	1	0		24.03	24.23	23.90				
40	1	105		24.16	23.93	23.89				
40	100	0		24.10	24.17	23.81				
40	1	1	16-QAM	23.79	23.96	23.71	26.76	0.4742		
40	1	1	64-QAM	23.77	23.93	23.68				
40	1	1	256-QAM	23.32	23.44	23.20				
Limit	EIRP < 2W			Result			Pass			

FR1 n41 Maximum Average Power [dBm] (GT - LC = 2.8 dB)										
BW [MHz]	RB Size	RB Offset	Mod	Lowest	Middle	Highest	EIRP (dBm)	EIRP(W)		
50	1	1	PI/2 BPSK	24.00	24.01	24.01	27.09	0.5117		
50	1	131		24.08	23.83	23.93				
50	64	32		24.16	24.16	23.81				
50	1	0		24.04	24.08	23.90				
50	1	132		24.08	23.88	23.89				
50	128	0		24.29	24.08	23.83				
50	1	1	QPSK	24.04	23.93	23.96			26.61	0.4581
50	1	131		24.05	23.84	23.94				
50	64	32		24.15	24.09	23.78				
50	1	0		24.02	24.08	23.85				
50	1	132		24.04	23.84	23.93				
50	128	0		24.25	24.06	23.85				
50	1	1	16-QAM	23.81	23.81	23.79	26.61	0.4581		
50	1	1	64-QAM	23.77	23.77	23.78				
50	1	1	256-QAM	23.37	23.29	23.36				
Limit	EIRP < 2W			Result			Pass			



FR1 n41 Maximum Average Power [dBm] (GT - LC = 2.8 dB)										
BW [MHz]	RB Size	RB Offset	Mod	Lowest	Middle	Highest	EIRP (dBm)	EIRP(W)		
60	1	1	PI/2 BPSK	23.97	23.94	23.85	26.95	0.4955		
60	1	160		23.86	23.87	23.85				
60	81	40		24.15	24.12	23.86				
60	1	0		24.06	24.03	23.71				
60	1	161		23.83	23.87	23.81				
60	162	0		24.08	24.10	23.89				
60	1	1	QPSK	23.92	23.90	23.77			26.62	0.4592
60	1	160		23.83	23.86	23.76				
60	81	40		24.15	24.09	23.81				
60	1	0		24.07	24.00	23.66				
60	1	161		23.81	23.84	23.76				
60	162	0		24.10	24.07	23.86				
60	1	1	16-QAM	23.82	23.80	23.67	26.62	0.4592		
60	1	1	64-QAM	23.73	23.73	23.61				
60	1	1	256-QAM	23.33	23.25	23.23				
Limit	EIRP < 2W			Result			Pass			

FR1 n41 Maximum Average Power [dBm] (GT - LC = 2.8 dB)										
BW [MHz]	RB Size	RB Offset	Mod	Lowest	Middle	Highest	EIRP (dBm)	EIRP(W)		
70	1	1	PI/2 BPSK	23.86	23.76	23.67	26.81	0.4797		
70	1	187		23.77	23.71	23.52				
70	90	45		24.01	23.93	23.63				
70	1	0		23.91	23.86	23.52				
70	1	188		23.78	23.66	23.52				
70	180	0		23.97	23.89	23.60				
70	1	1	QPSK	23.84	23.71	23.58			26.44	0.4406
70	1	187		23.75	23.62	23.50				
70	90	45		24.00	23.92	23.64				
70	1	0		23.88	23.84	23.47				
70	1	188		23.70	23.66	23.48				
70	180	0		23.94	23.86	23.57				
70	1	1	16-QAM	23.64	23.59	23.57	26.44	0.4406		
70	1	1	64-QAM	23.59	23.52	23.53				
70	1	1	256-QAM	23.17	23.11	22.98				
Limit	EIRP < 2W			Result			Pass			



FR1 n41 Maximum Average Power [dBm] (GT - LC = 2.8 dB)										
BW [MHz]	RB Size	RB Offset	Mod	Lowest	Middle	Highest	EIRP (dBm)	EIRP(W)		
80	1	1	PI/2 BPSK	23.82	23.71	23.62	26.73	0.4710		
80	1	215		23.77	23.76	23.60				
80	108	54		23.90	23.93	23.75				
80	1	0		23.89	23.82	23.45				
80	1	216		23.75	23.74	23.63				
80	216	0		23.86	23.84	23.64				
80	1	1	QPSK	23.77	23.70	23.54			26.42	0.4385
80	1	215		23.76	23.70	23.64				
80	108	54		23.86	23.90	23.74				
80	1	0		23.91	23.78	23.45				
80	1	216		23.74	23.63	23.54				
80	216	0		23.82	23.88	23.64				
80	1	1	16-QAM	23.62	23.60	23.42	26.42	0.4385		
80	1	1	64-QAM	23.60	23.54	23.38				
80	1	1	256-QAM	23.19	23.08	22.88				
Limit	EIRP < 2W			Result			Pass			

FR1 n41 Maximum Average Power [dBm] (GT - LC = 2.8 dB)										
BW [MHz]	RB Size	RB Offset	Mod	Lowest	Middle	Highest	EIRP (dBm)	EIRP(W)		
90	1	1	PI/2 BPSK	23.84	23.79	23.80	26.76	0.4742		
90	1	243		23.91	23.78	23.71				
90	120	60		23.96	23.93	23.80				
90	1	0		23.91	23.78	23.62				
90	1	244		23.93	23.76	23.72				
90	240	0		23.91	23.85	23.75				
90	1	1	QPSK	23.77	23.74	23.70			26.44	0.4406
90	1	243		23.92	23.74	23.72				
90	120	60		23.95	23.89	23.81				
90	1	0		23.87	23.85	23.56				
90	1	244		23.87	23.75	23.71				
90	240	0		23.92	23.87	23.73				
90	1	1	16-QAM	23.64	23.61	23.55	26.44	0.4406		
90	1	1	64-QAM	23.61	23.58	23.51				
90	1	1	256-QAM	23.13	23.13	23.14				
Limit	EIRP < 2W			Result			Pass			



FR1 n41 Maximum Average Power [dBm] (GT - LC = 2.8 dB)										
BW [MHz]	RB Size	RB Offset	Mod	Lowest	Middle	Highest	EIRP (dBm)	EIRP(W)		
100	1	1	PI/2 BPSK	23.82	23.78	23.87	26.77	0.4753		
100	1	271		23.70	23.81	23.66				
100	135	67		23.77	23.97	23.74				
100	1	0		23.95	23.93	23.77				
100	1	272		23.71	23.79	23.69				
100	270	0		23.81	23.92	23.67				
100	1	1	QPSK	23.83	23.72	23.86			26.52	0.4487
100	1	271		23.71	23.77	23.66				
100	135	67		23.83	23.91	23.73				
100	1	0		23.89	23.90	23.70				
100	1	272		23.69	23.74	23.64				
100	270	0		23.82	23.92	23.68				
100	1	1	16-QAM	23.68	23.59	23.72	26.52	0.4487		
100	1	1	64-QAM	23.64	23.57	23.68				
100	1	1	256-QAM	23.23	23.06	23.20				
Limit	EIRP < 2W			Result			Pass			



<MIMO Mode>
MIMO <Ant. 8+3>

FR1 n41 Maximum Average Power [dBm], DG = 2.8 dBi														
BW (MHz)	RB Size	RB Offset	Mod	Antenna 8			Antenna 3			Combine			EIRP (dBm)	EIRP (W)
				Lowest	Middle	Highest	Lowest	Middle	Highest	Lowest	Middle	Highest		
20	1	1	QPSK	21.53	21.57	20.98	21.00	21.31	21.22	24.28	24.45	24.11	27.25	0.5309
20	1	49		21.51	21.33	21.15	21.06	21.31	21.07	24.30	24.33	24.12		
20	25	12		21.44	21.52	21.07	20.99	21.27	21.01	24.23	24.41	24.05		
20	1	0		19.44	19.56	18.96	18.96	19.34	19.20	22.22	22.46	22.09		
20	1	50		19.47	19.42	19.08	19.06	19.37	19.06	22.28	22.41	22.08		
20	51	0		19.97	19.99	19.61	19.40	19.79	19.55	22.70	22.90	22.59		
20	1	1	16-QAM	21.02	21.06	20.48	20.53	20.94	20.89	23.79	24.01	23.70	26.81	0.4797
20	1	1	64-QAM	19.40	19.53	18.92	18.73	19.06	18.99	22.09	22.31	21.97		
20	1	1	256-QAM	16.50	16.54	16.01	16.04	16.34	16.23	19.29	19.45	19.13		
Limit	EIRP < 2W			Result									Pass	

FR1 n41 Maximum Average Power [dBm], DG = 2.8 dBi														
BW (MHz)	RB Size	RB Offset	Mod	Antenna 8			Antenna 3			Combine			EIRP (dBm)	EIRP (W)
				Lowest	Middle	Highest	Lowest	Middle	Highest	Lowest	Middle	Highest		
30	1	1	QPSK	21.52	21.61	21.04	21.06	21.20	21.03	24.31	24.42	24.05	27.27	0.5333
30	1	76		21.75	21.36	21.12	21.15	21.51	21.08	24.47	24.45	24.11		
30	39	19		21.59	21.45	20.91	20.97	21.21	20.93	24.30	24.34	23.93		
30	1	0		19.56	19.61	19.02	19.10	19.27	19.07	22.35	22.45	22.06		
30	1	77		19.70	19.33	19.12	19.16	19.46	19.04	22.45	22.41	22.09		
30	78	0		20.12	20.01	19.52	19.50	19.77	19.47	22.83	22.90	22.51		
30	1	1	16-QAM	20.84	21.04	20.57	20.67	20.83	20.63	23.77	23.95	23.61	26.75	0.4732
30	1	1	64-QAM	19.44	19.34	18.92	18.82	19.01	18.79	22.15	22.19	21.87		
30	1	1	256-QAM	16.53	16.52	15.99	16.12	16.31	16.11	19.34	19.43	19.06		
Limit	EIRP < 2W			Result									Pass	



FR1 n41 Maximum Average Power [dBm], DG = 2.8 dBi														
BW (MHz)	RB Size	RB Offset	Mod	Antenna 8			Antenna 3			Combine			EIRP (dBm)	EIRP (W)
				Lowest	Middle	Highest	Lowest	Middle	Highest	Lowest	Middle	Highest		
40	1	1	QPSK	21.56	21.62	21.34	21.11	21.28	21.26	24.35	24.46	24.31	27.26	0.5321
40	1	104		21.61	21.40	21.45	21.16	21.50	21.28	24.40	24.46	24.38		
40	53	26		21.54	21.56	21.02	20.93	21.27	21.09	24.26	24.43	24.07		
40	1	0		19.52	19.37	19.25	19.09	19.64	19.21	22.32	22.52	22.24		
40	1	105		19.55	19.40	19.25	19.11	19.46	19.25	22.35	22.44	22.26		
40	106	0		20.06	20.07	19.65	19.47	19.87	19.68	22.79	22.98	22.68		
40	1	1	16-QAM	20.97	21.23	20.87	20.77	20.90	20.83	23.88	24.08	23.86	26.88	0.4875
40	1	1	64-QAM	19.33	19.51	19.16	18.86	19.06	18.97	22.11	22.30	22.08		
40	1	1	256-QAM	16.42	16.65	16.32	16.16	16.28	16.23	19.30	19.48	19.29		
Limit	EIRP < 2W			Result									Pass	

FR1 n41 Maximum Average Power [dBm], DG = 2.8 dBi														
BW (MHz)	RB Size	RB Offset	Mod	Antenna 8			Antenna 3			Combine			EIRP (dBm)	EIRP (W)
				Lowest	Middle	Highest	Lowest	Middle	Highest	Lowest	Middle	Highest		
50	1	1	QPSK	21.01	21.55	21.60	21.67	21.11	21.17	24.36	24.35	24.40	27.23	0.5284
50	1	131		21.59	21.47	21.25	21.24	21.32	21.25	24.43	24.41	24.26		
50	67	33		21.57	21.52	21.17	21.09	21.25	21.16	24.35	24.40	24.18		
50	1	0		19.52	19.61	19.31	19.20	19.21	19.19	22.37	22.42	22.26		
50	1	132		19.51	19.35	19.23	19.25	19.38	19.19	22.39	22.38	22.22		
50	133	0		20.12	20.04	19.74	19.55	19.78	19.66	22.85	22.92	22.71		
50	1	1	16-QAM	21.00	21.04	21.00	20.67	20.78	20.91	23.85	23.92	23.97	26.77	0.4753
50	1	1	64-QAM	19.39	19.45	19.36	18.82	18.97	19.07	22.12	22.23	22.23		
50	1	1	256-QAM	16.45	16.55	16.47	16.13	16.22	16.23	19.30	19.40	19.36		
Limit	EIRP < 2W			Result									Pass	



FR1 n41 Maximum Average Power [dBm], DG = 2.8 dBi														
BW (MHz)	RB Size	RB Offset	Mod	Antenna 8			Antenna 3			Combine			EIRP (dBm)	EIRP (W)
				Lowest	Middle	Highest	Lowest	Middle	Highest	Lowest	Middle	Highest		
60	1	1	QPSK	21.44	21.49	21.28	20.98	21.15	21.14	24.23	24.33	24.22	27.24	0.5297
60	1	160		21.40	21.32	21.30	21.12	21.36	21.04	24.27	24.35	24.18		
60	81	40		21.49	21.55	21.20	20.88	21.31	21.07	24.21	24.44	24.15		
60	1	0		19.49	19.53	19.24	18.93	19.22	19.13	22.23	22.39	22.20		
60	1	161		19.33	19.29	19.24	19.06	19.35	18.97	22.21	22.33	22.12		
60	162	0		19.93	19.92	19.73	19.47	19.77	19.57	22.72	22.86	22.66		
60	1	1	16-QAM	20.79	20.91	20.81	20.66	20.67	20.90	23.74	23.80	23.87	26.67	0.4645
60	1	1	64-QAM	19.34	19.36	19.24	18.77	18.92	18.87	22.07	22.16	22.07		
60	1	1	256-QAM	16.40	16.44	16.38	16.10	16.20	16.16	19.26	19.33	19.28		
Limit	EIRP < 2W			Result									Pass	

FR1 n41 Maximum Average Power [dBm], DG = 2.8 dBi														
BW (MHz)	RB Size	RB Offset	Mod	Antenna 8			Antenna 3			Combine			EIRP (dBm)	EIRP (W)
				Lowest	Middle	Highest	Lowest	Middle	Highest	Lowest	Middle	Highest		
70	1	1	QPSK	21.19	21.31	21.03	20.84	20.92	21.00	24.03	24.13	24.03	27.08	0.5105
70	1	187		21.30	21.18	21.25	20.91	21.14	20.79	24.12	24.17	24.04		
70	95	47		21.45	21.41	21.07	20.97	21.12	20.80	24.23	24.28	23.95		
70	1	0		19.25	19.41	18.92	19.02	19.14	18.95	22.15	22.29	21.95		
70	1	188		19.18	19.25	19.00	18.92	19.04	18.74	22.06	22.16	21.88		
70	189	0		19.82	19.75	19.46	19.42	19.50	19.35	22.63	22.64	22.42		
70	1	1	16-QAM	20.77	20.76	20.58	20.53	20.65	20.73	23.66	23.72	23.67	26.52	0.4487
70	1	1	64-QAM	19.21	19.19	19.00	18.60	18.77	18.82	21.93	22.00	21.92		
70	1	1	256-QAM	16.31	16.24	16.05	15.95	16.05	16.11	19.14	19.16	19.09		
Limit	EIRP < 2W			Result										



FR1 n41 Maximum Average Power [dBm], DG = 2.8 dBi														
BW (MHz)	RB Size	RB Offset	Mod	Antenna 8			Antenna 3			Combine			EIRP (dBm)	EIRP (W)
				Lowest	Middle	Highest	Lowest	Middle	Highest	Lowest	Middle	Highest		
80	1	1	QPSK	21.34	21.26	21.13	20.79	20.93	21.07	24.08	24.11	24.11	27.04	0.5058
80	1	215		21.26	21.34	21.04	20.73	21.04	20.92	24.01	24.20	23.99		
80	109	54		21.31	21.34	21.07	20.86	21.11	20.90	24.10	24.24	24.00		
80	1	0		19.35	19.36	18.92	18.86	19.04	19.01	22.12	22.21	21.98		
80	1	216		19.21	19.27	18.97	18.92	19.06	18.88	22.08	22.18	21.94		
80	217	0		19.76	19.81	19.52	19.35	19.47	19.41	22.57	22.65	22.48		
80	1	1	16-QAM	20.68	20.74	20.46	20.49	20.56	20.78	23.60	23.66	23.63	26.46	0.4426
80	1	1	64-QAM	19.21	19.15	18.95	18.55	18.64	18.86	21.90	21.91	21.92		
80	1	1	256-QAM	16.24	16.24	15.99	15.78	15.93	16.11	19.03	19.10	19.06		
Limit	EIRP < 2W			Result									Pass	

FR1 n41 Maximum Average Power [dBm], DG = 2.8 dBi														
BW (MHz)	RB Size	RB Offset	Mod	Antenna 8			Antenna 3			Combine			EIRP (dBm)	EIRP (W)
				Lowest	Middle	Highest	Lowest	Middle	Highest	Lowest	Middle	Highest		
90	1	1	QPSK	21.37	21.36	21.23	20.82	20.97	21.12	24.11	24.18	24.19	27.09	0.5117
90	1	243		21.49	21.46	20.95	21.00	21.10	20.82	24.26	24.29	23.90		
90	123	61		21.41	21.34	20.91	21.00	21.11	20.98	24.22	24.24	23.96		
90	1	0		19.36	19.52	19.05	18.89	19.11	18.97	22.14	22.33	22.02		
90	1	244		19.40	19.31	19.08	19.00	18.97	18.87	22.21	22.15	21.99		
90	245	0		19.93	19.81	19.58	19.44	19.51	19.35	22.70	22.67	22.48		
90	1	1	16-QAM	20.81	20.78	20.73	20.44	20.61	20.72	23.64	23.71	23.74	26.54	0.4508
90	1	1	64-QAM	19.17	19.25	19.14	18.55	18.62	18.84	21.88	21.96	22.00		
90	1	1	256-QAM	16.21	16.25	16.23	15.87	15.97	16.12	19.05	19.12	19.19		
Limit	EIRP < 2W			Result									Pass	



FR1 n41 Maximum Average Power [dBm], DG = 2.8 dBi														
BW (MHz)	RB Size	RB Offset	Mod	Antenna 8			Antenna 3			Combine			EIRP (dBm)	EIRP (W)
				Lowest	Middle	Highest	Lowest	Middle	Highest	Lowest	Middle	Highest		
100	1	1	QPSK	21.24	21.50	21.40	20.85	20.97	20.92	24.06	24.25	24.18	27.06	0.5082
100	1	271		21.40	21.37	21.14	21.10	20.94	20.85	24.26	24.17	24.01		
100	137	68		21.27	21.30	21.12	20.82	21.13	20.91	24.06	24.23	24.03		
100	1	0		19.41	19.51	19.23	18.94	19.12	18.95	22.19	22.33	22.10		
100	1	272		19.24	19.19	19.07	19.02	18.87	18.90	22.14	22.04	22.00		
100	273	0		19.81	19.77	19.57	19.40	19.46	19.47	22.62	22.63	22.53		
100	1	1	16-QAM	20.78	20.80	20.91	20.43	20.58	20.62	23.62	23.70	23.78	26.58	0.455
100	1	1	64-QAM	19.23	19.30	19.23	18.57	19.16	18.76	21.92	22.24	22.01		
100	1	1	256-QAM	16.29	16.28	16.33	15.84	16.03	16.08	19.08	19.17	19.22		
Limit	EIRP < 2W			Result									Pass	



FR1 n12

Peak-to-Average Ratio

Mode	FR1 n12 / 15MHz / DFT-S OFDM				
Mod.	PI/2 BPSK	QPSK	16QAM	64QAM	Limit: 13dB
RB Size	Full RB	Full RB	Full RB	Full RB	Result
Middle CH	4.58	5.62	6.54	6.68	PASS
Mode	FR1 n12 / 15MHz / DFT-S OFDM				
Mod.	256QAM				Limit: 13dB
RB Size	Full RB				Result
Middle CH	6.72				PASS



FR1 n12 / 15MHz / DFT-S OFDM / Middle Channel / Full RB

PI/2 BPSK

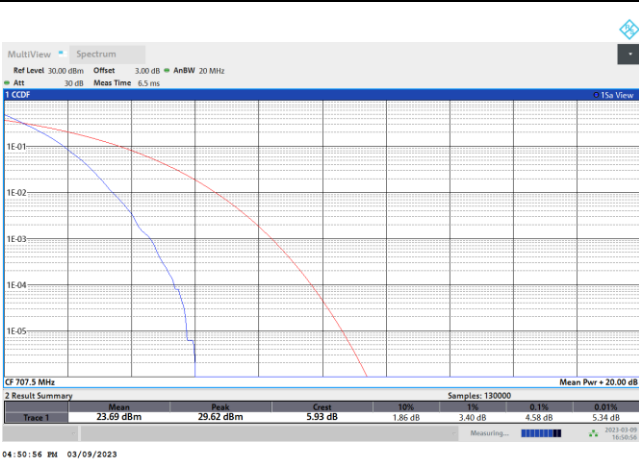

QPSK

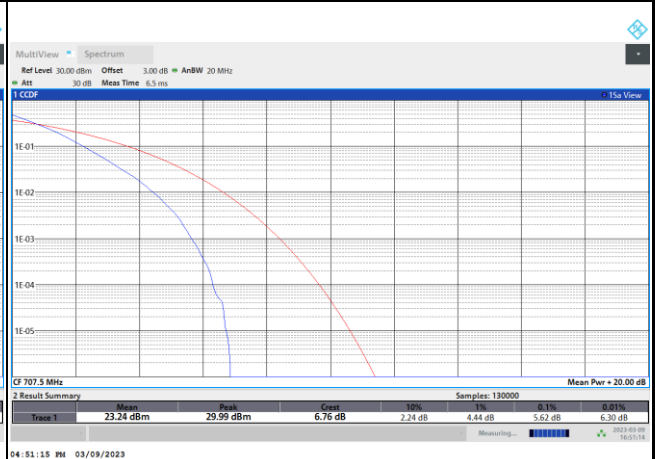

16QAM

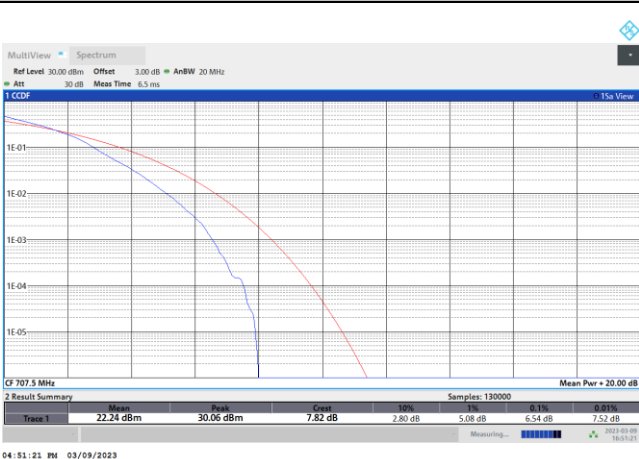

64QAM

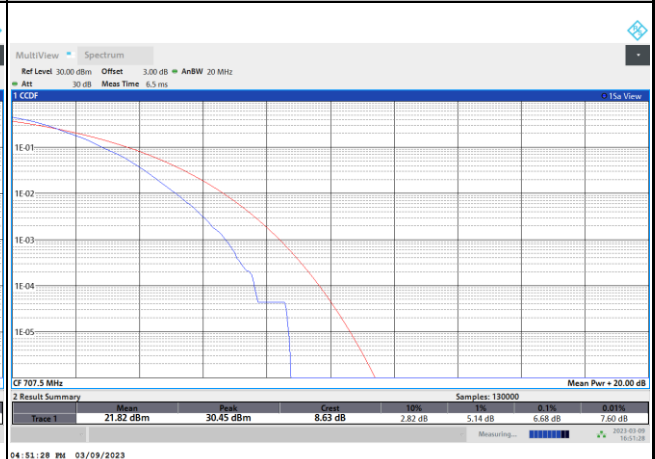

256QAM

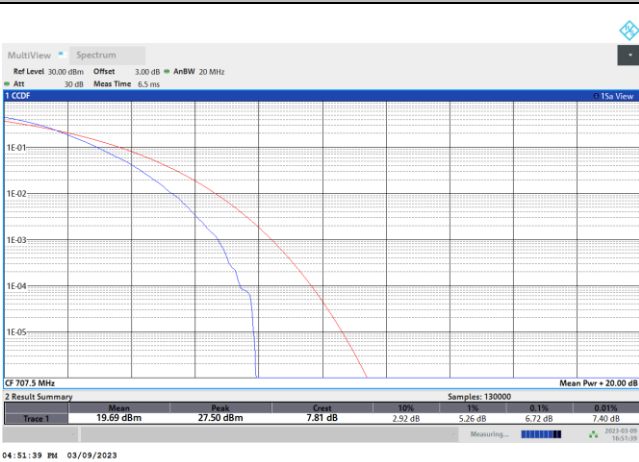



26dB Bandwidth

Mode	FR1 n12 : 26dB BW(MHz) / DFT-S OFDM							
BW	5MHz		10MHz		15MHz			
Mod.	PI/2 BPSK		PI/2 BPSK		PI/2 BPSK			
Middle CH	5.06		9.63		14.42			

Mode	FR1 n12 : 26dB BW(MHz) / CP OFDM							
BW	5MHz		10MHz		15MHz			
Mod.	QPSK	16QAM	QPSK	16QAM	QPSK	16QAM		
Middle CH	5.17	5.11	10.07	9.95	15.17	15.23		
Mod.	64QAM	256QAM	64QAM	256QAM	64QAM	256QAM		
Middle CH	5.16	5.23	10.09	10.05	15.05	15.11		



FR1 n12 / 5MHz / DFT-S OFDM / Middle Channel / Full RB

PI/2 BPSK

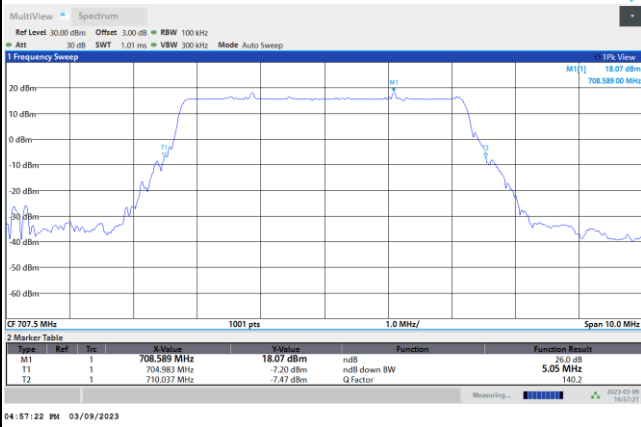

FR1 n12 / 5MHz / CP OFDM / Middle Channel / Full RB

QPSK

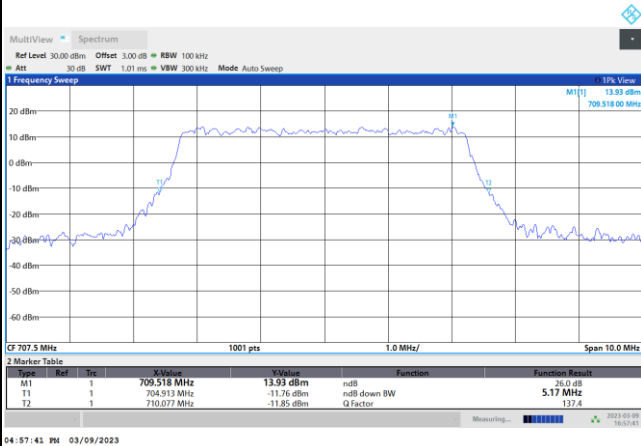

16QAM

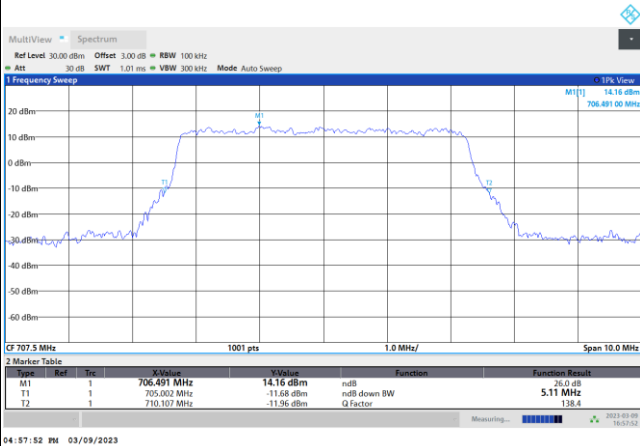

64QAM

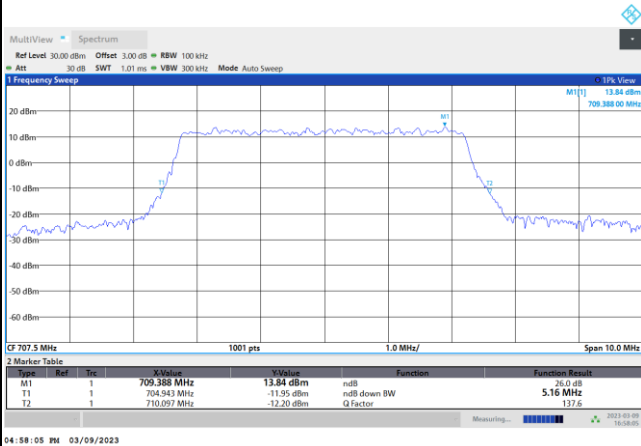

256QAM

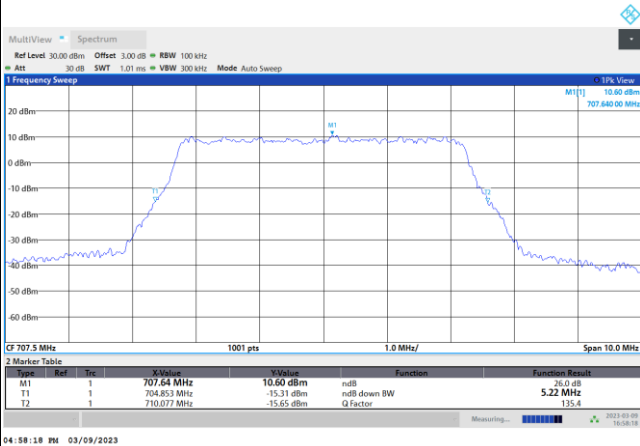



FR1 n12 / 10MHz / DFT-S OFDM / Middle Channel / Full RB

PI/2 BPSK

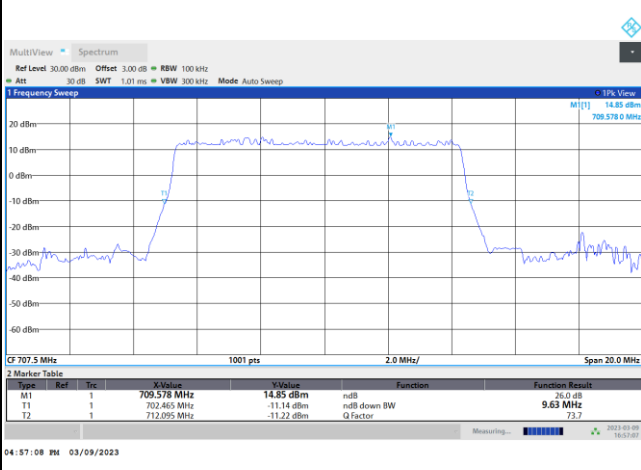

FR1 n12 / 10MHz / CP OFDM / Middle Channel / Full RB

QPSK

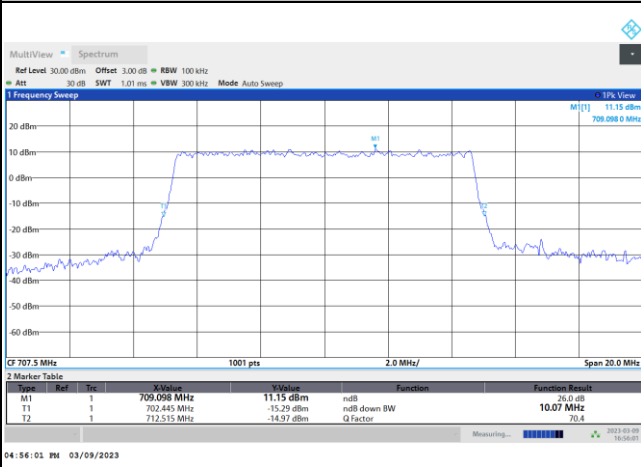

16QAM

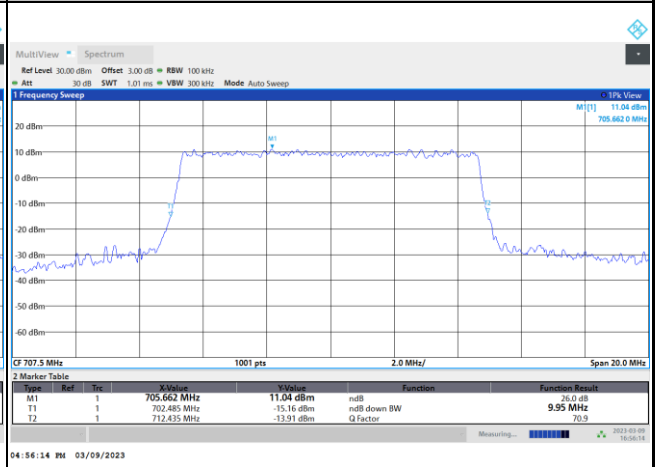

64QAM

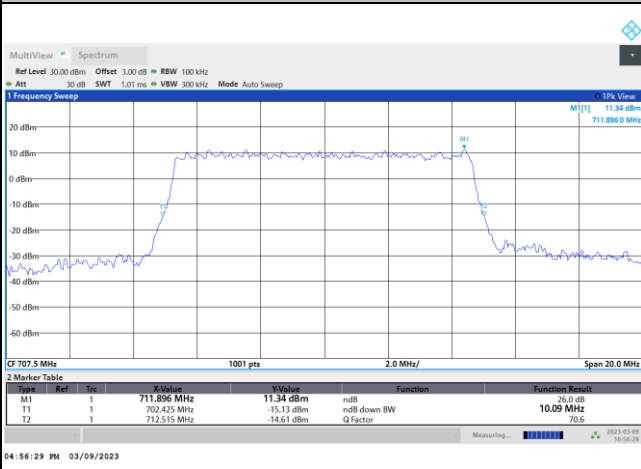

256QAM

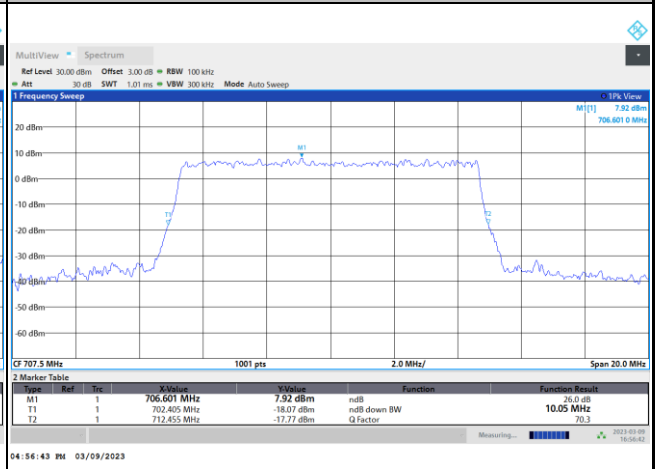



FR1 n12 / 15MHz / DFT-S OFDM / Middle Channel / Full RB

PI/2 BPSK

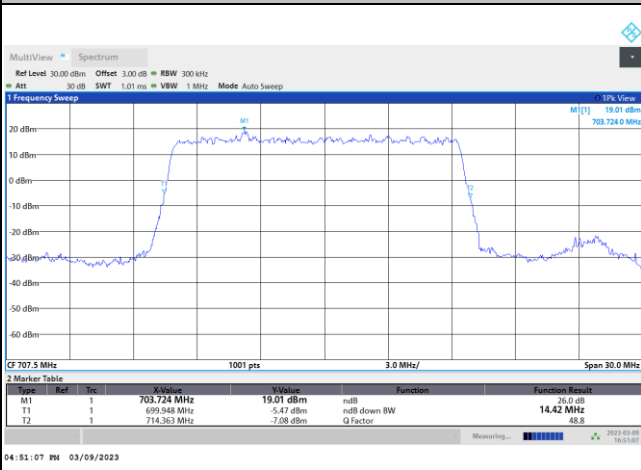

FR1 n12 / 15MHz / CP OFDM / Middle Channel / Full RB

QPSK

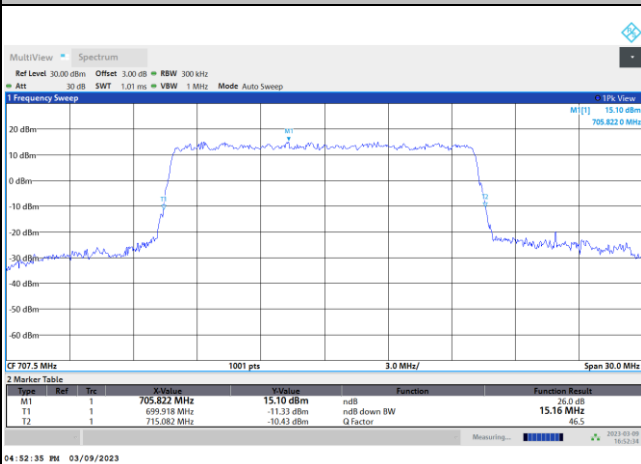

16QAM

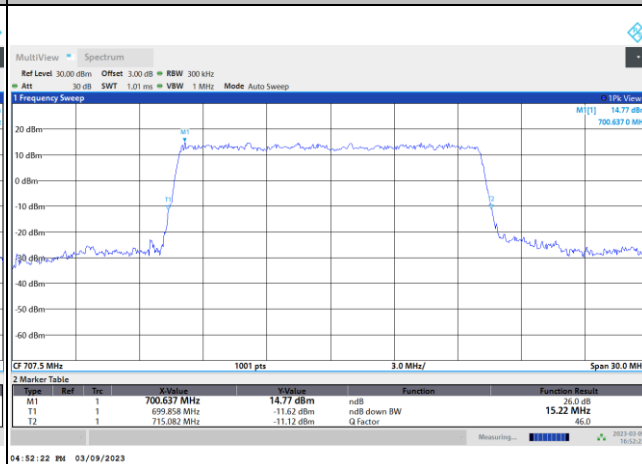

64QAM

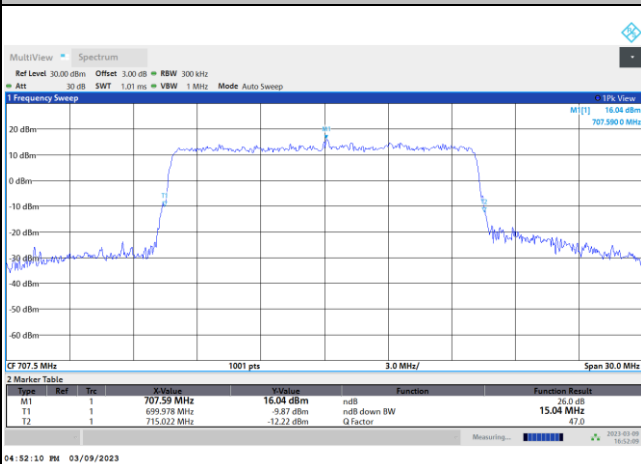

256QAM

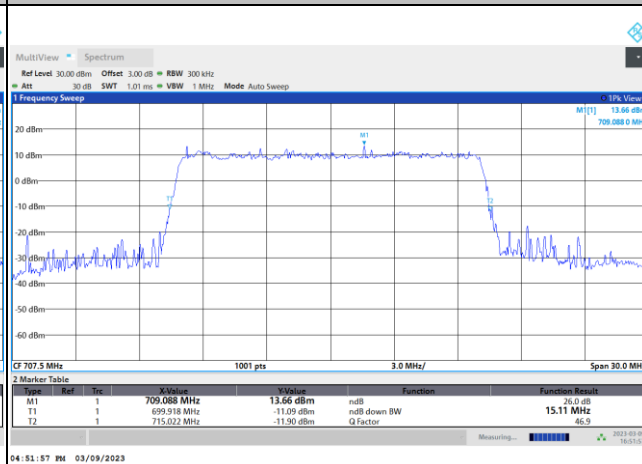



Occupied Bandwidth

Mode	FR1 n12 : 99%OBW(MHz) / DFT-S OFDM							
BW	5MHz		10MHz		15MHz			
Mod.	PI/2 BPSK		PI/2 BPSK		PI/2 BPSK			
Middle CH	4.48		8.92		13.44			

Mode	FR1 n12 : 99%OBW (MHz) / CP OFDM							
BW	5MHz		10MHz		15MHz			
Mod.	QPSK	16QAM	QPSK	16QAM	QPSK	16QAM		
Middle CH	4.51	4.50	9.28	9.28	14.15	14.12		
Mod.	64QAM	256QAM	64QAM	256QAM	64QAM	256QAM		
Middle CH	4.49	4.51	9.27	9.29	14.19	14.15		



FR1 n12 / 5MHz / DFT-S OFDM / Middle Channel / Full RB

PI/2 BPSK

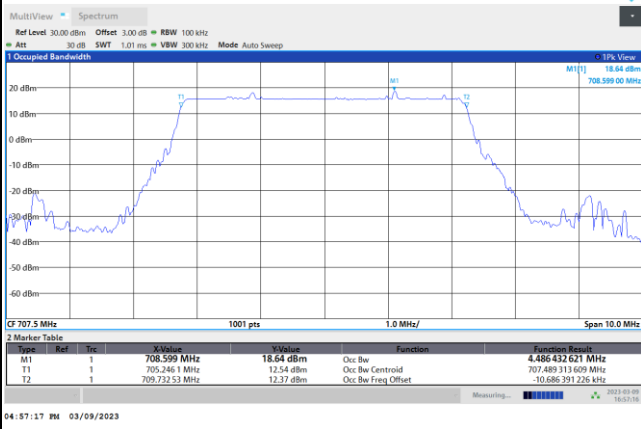

FR1 n12 / 5MHz / CP OFDM / Middle Channel / Full RB

QPSK

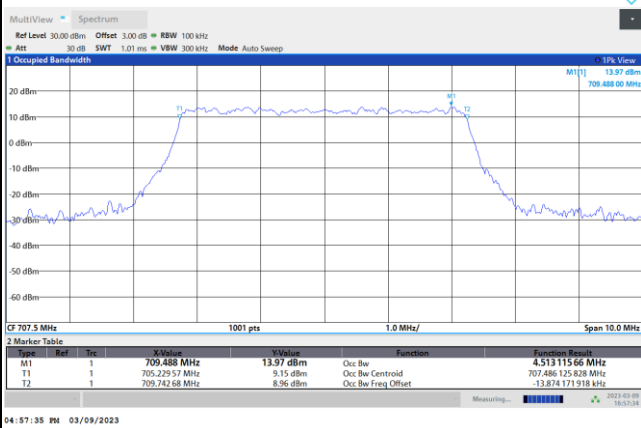

16QAM

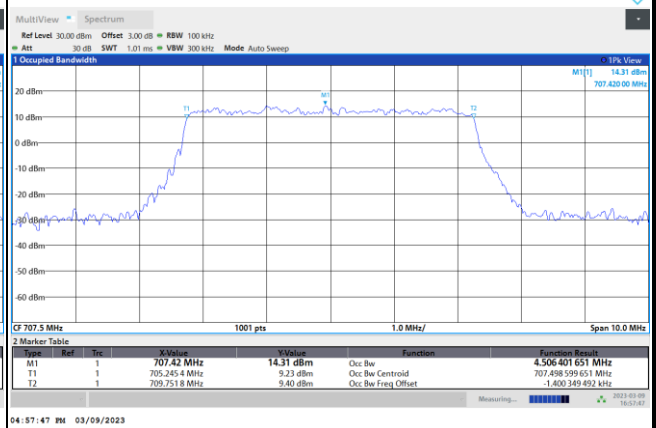

64QAM

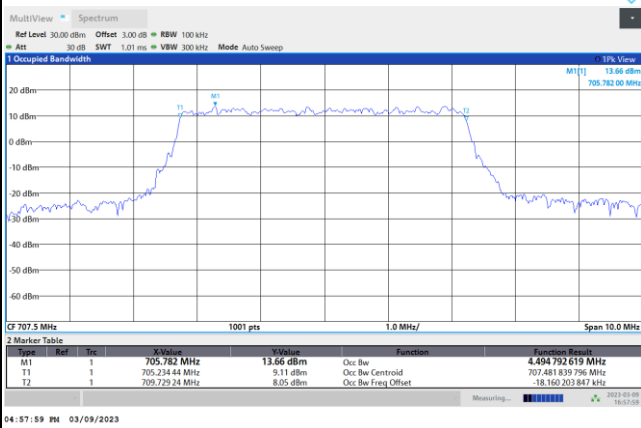

256QAM

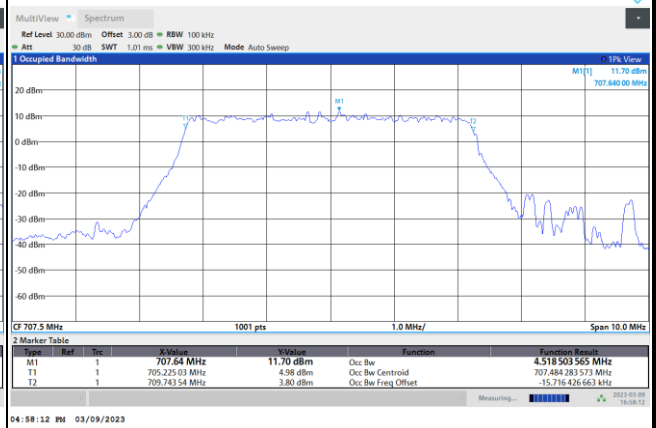



FR1 n12 / 10MHz / DFT-S OFDM / Middle Channel / Full RB

PI/2 BPSK

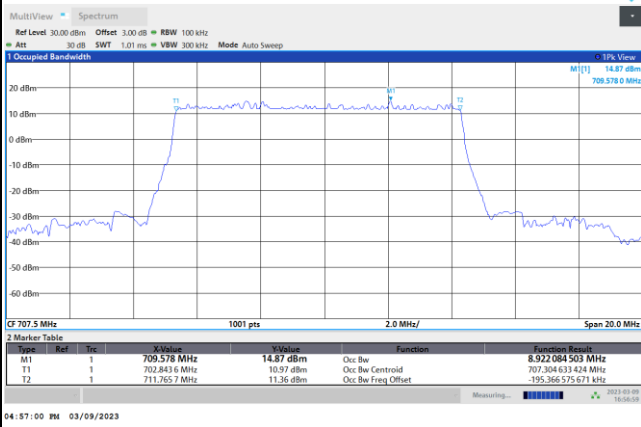

FR1 n12 / 10MHz / CP OFDM / Middle Channel / Full RB

QPSK

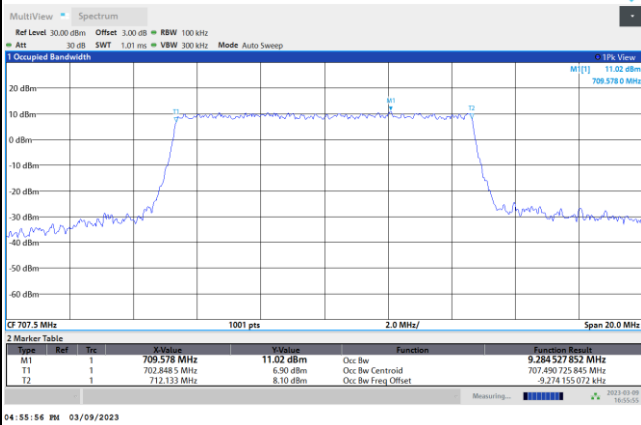

16QAM

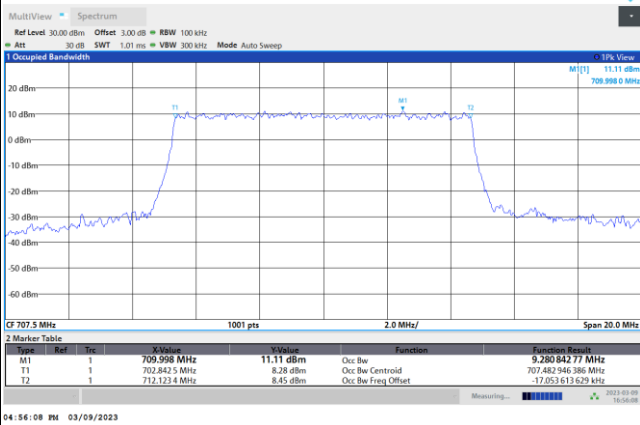

64QAM

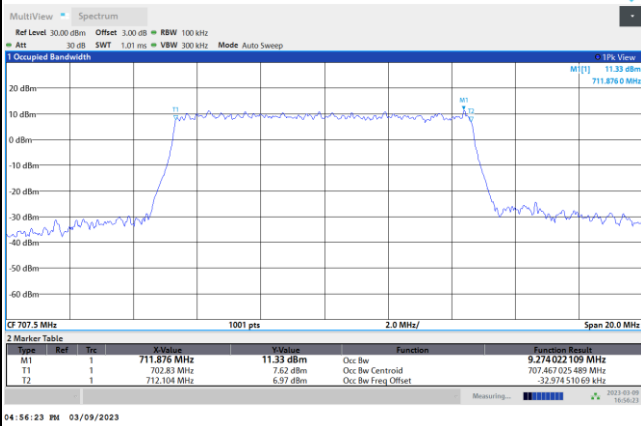

256QAM

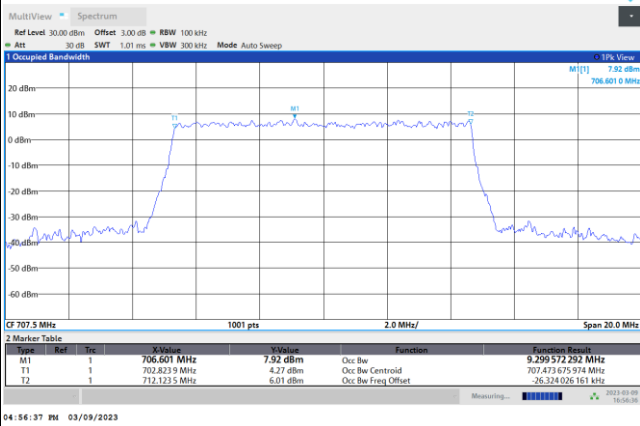



FR1 n12 / 15MHz / DFT-S OFDM / Middle Channel / Full RB

PI/2 BPSK

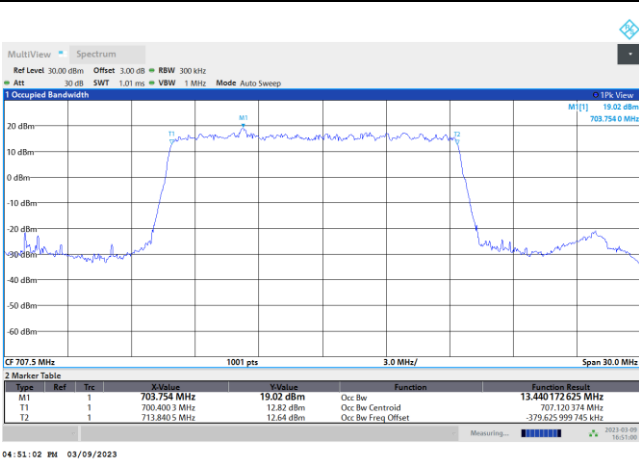

FR1 n12 / 15MHz / CP OFDM / Middle Channel / Full RB

QPSK

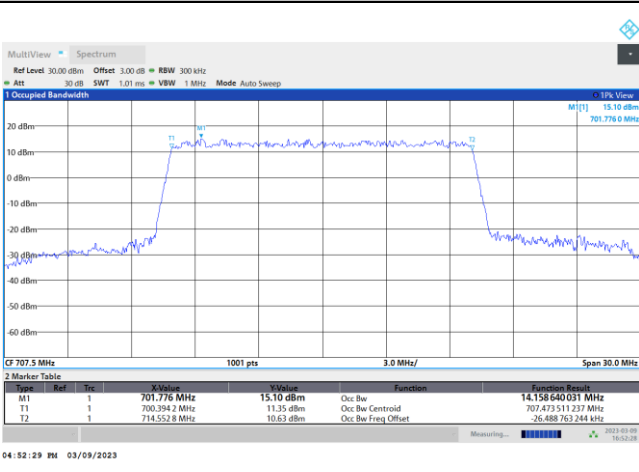

16QAM

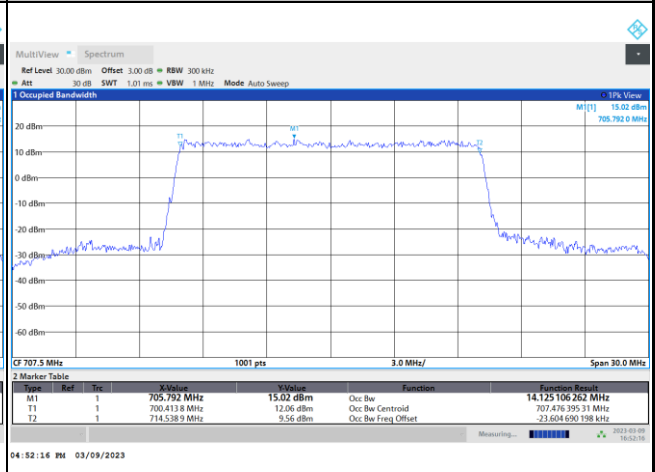

64QAM

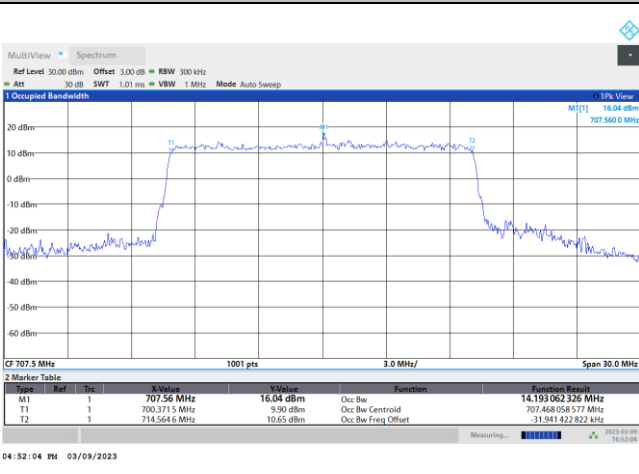

256QAM

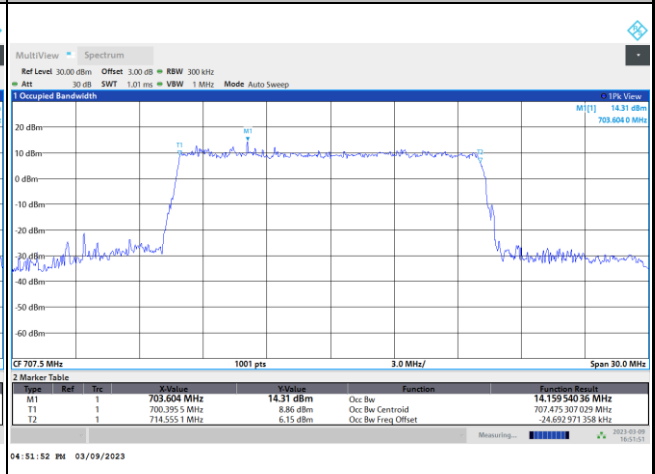



Conducted Band Edge

FR1 n12 / 5MHz / DFT-S OFDM / PI/2 BPSK

Lowest Band Edge / 1RB0

Highest Band Edge / 1RBmax

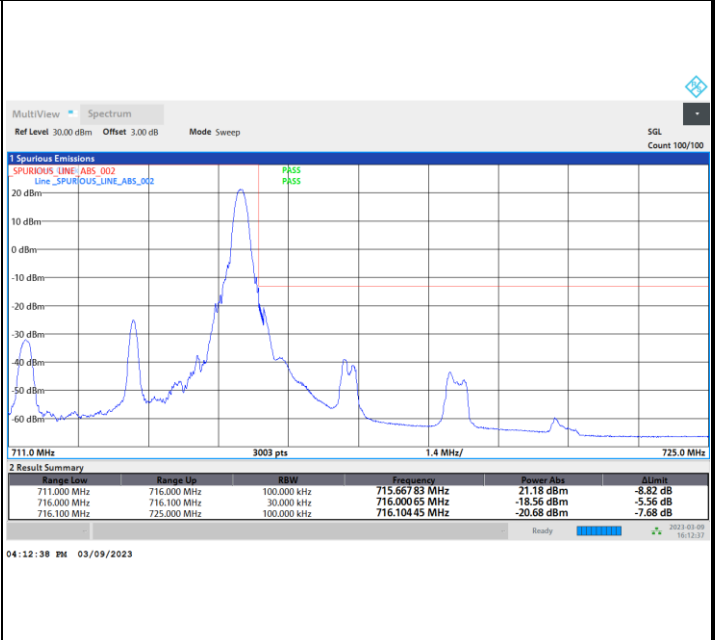
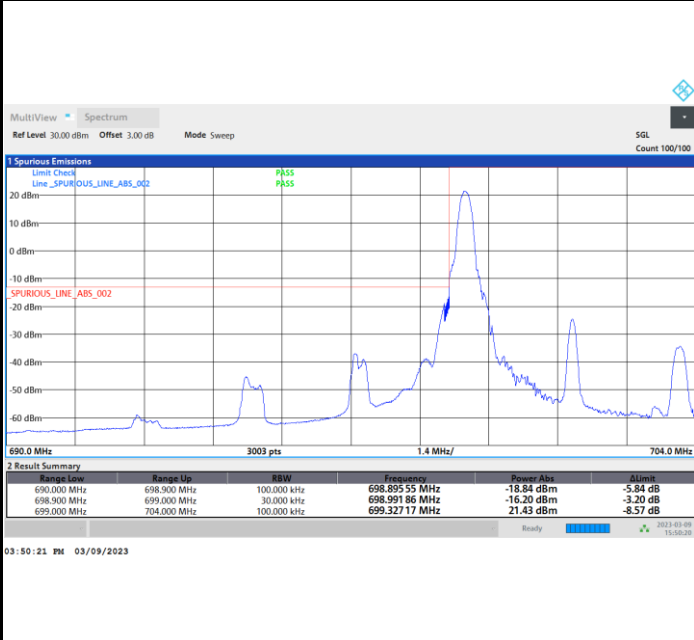

Lowest Band Edge / Full RB

Highest Band Edge / Full RB

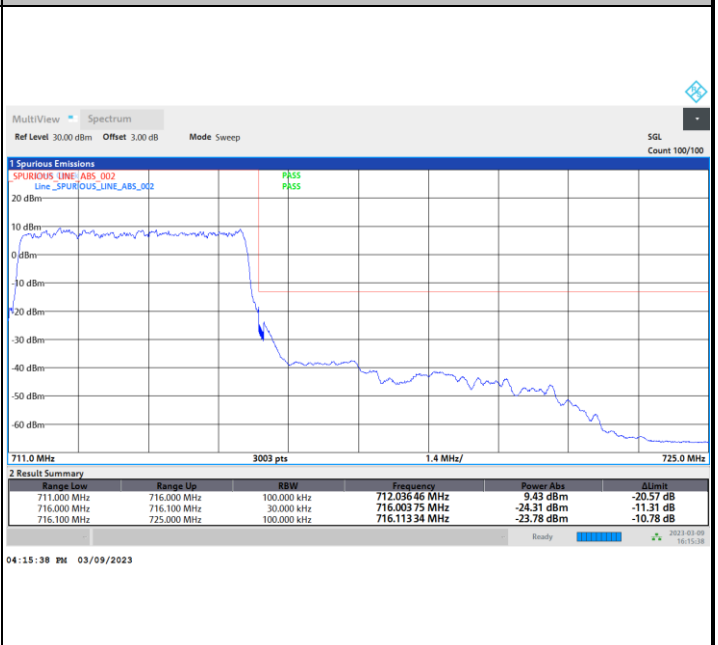



FR1 n12 / 5MHz / DFT-S OFDM / QPSK

Lowest Band Edge / 1RB0

Highest Band Edge / 1RBmax

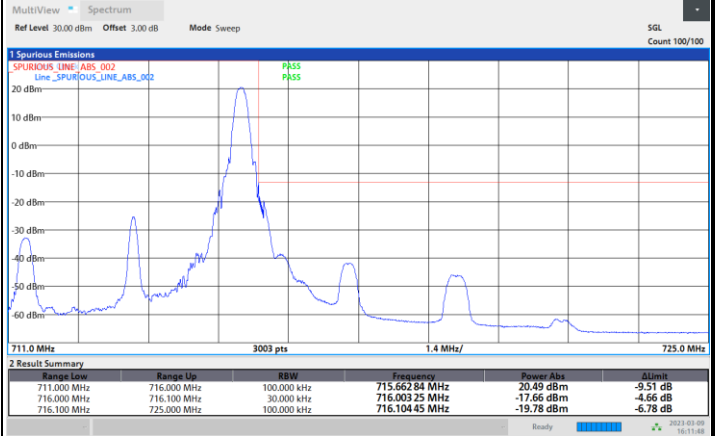
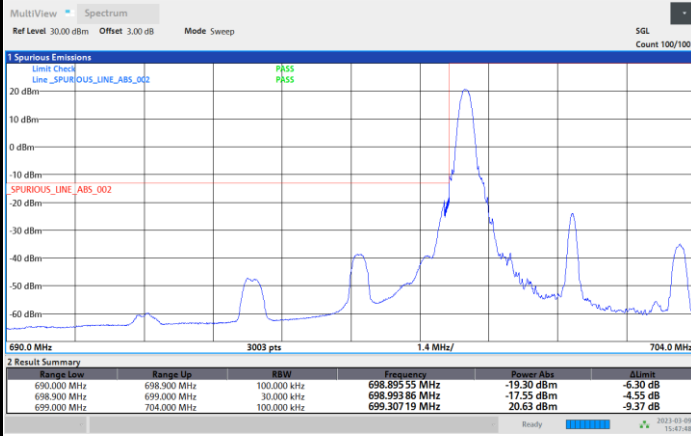

Lowest Band Edge / Full RB

Highest Band Edge / Full RB

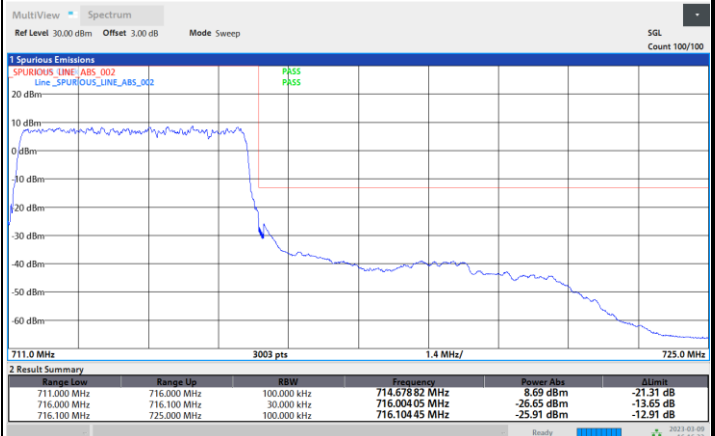
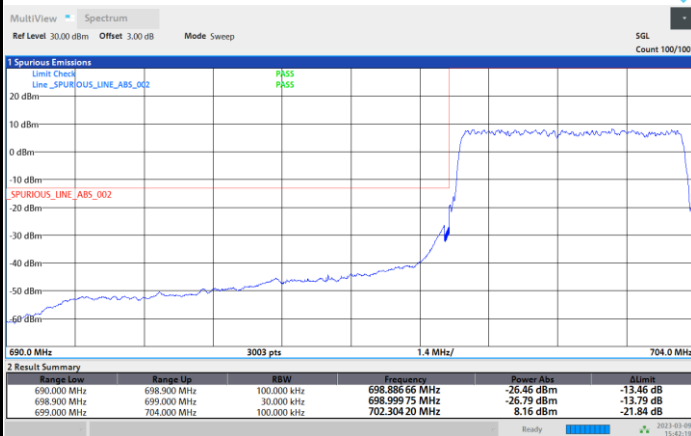



FR1 n12 / 5MHz / DFT-S OFDM / 16QAM

Lowest Band Edge / 1RB0

Highest Band Edge / 1RBmax

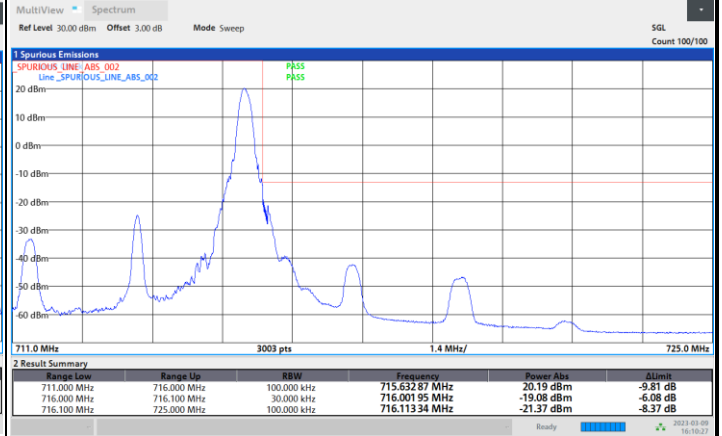
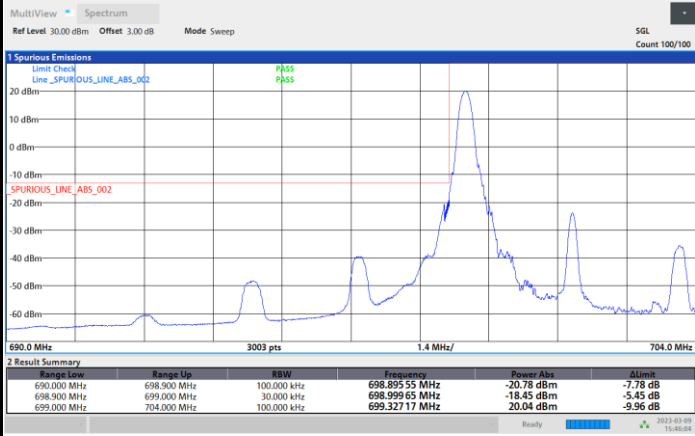

03:46:04 PM 03/09/2023

04:10:28 PM 03/09/2023

Lowest Band Edge / Full RB

Highest Band Edge / Full RB

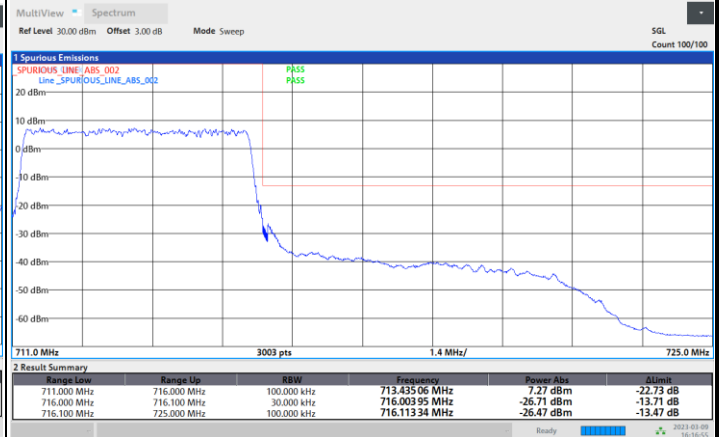
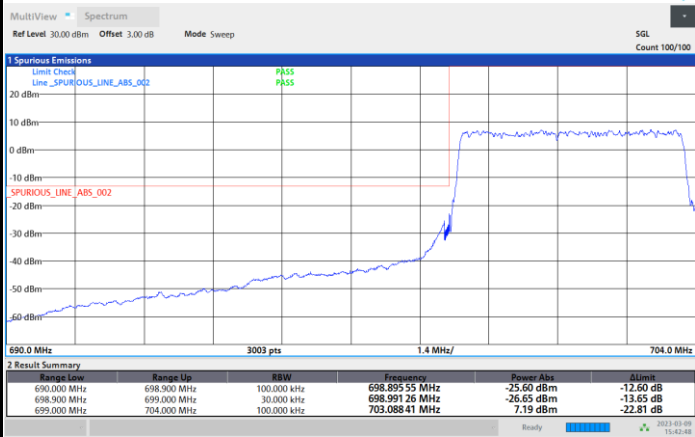

03:42:49 PM 03/09/2023

04:16:55 PM 03/09/2023



FR1 n12 / 5MHz / DFT-S OFDM / 64QAM

Lowest Band Edge / 1RB0

Highest Band Edge / 1RBmax

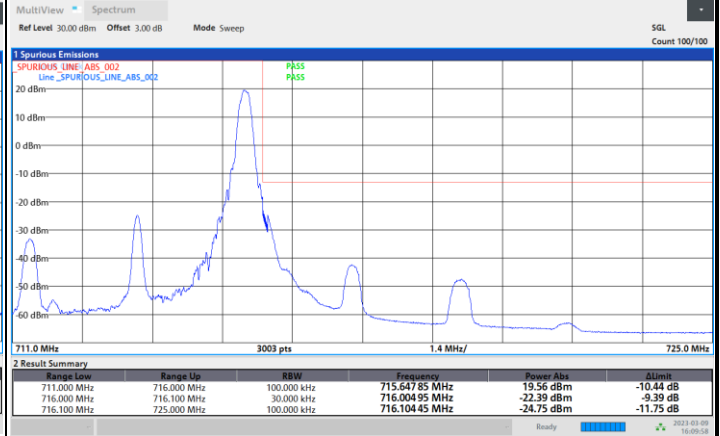
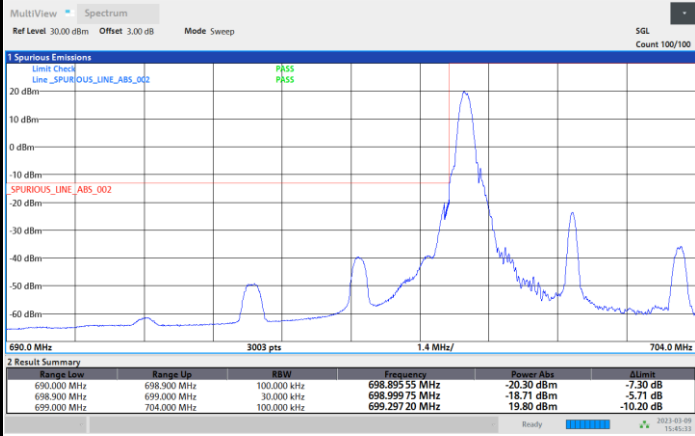

Lowest Band Edge / Full RB

Highest Band Edge / Full RB

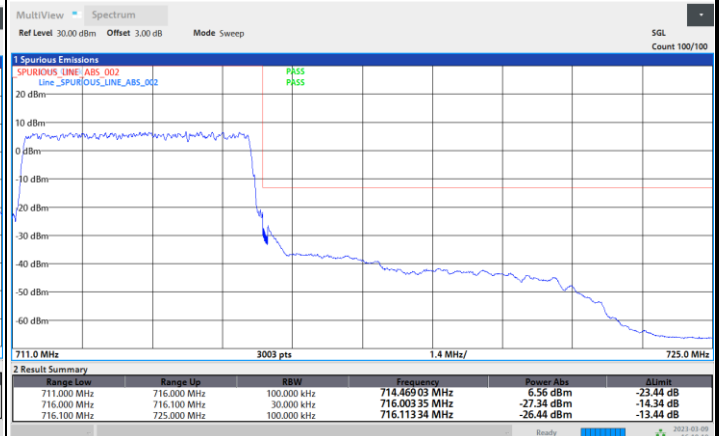
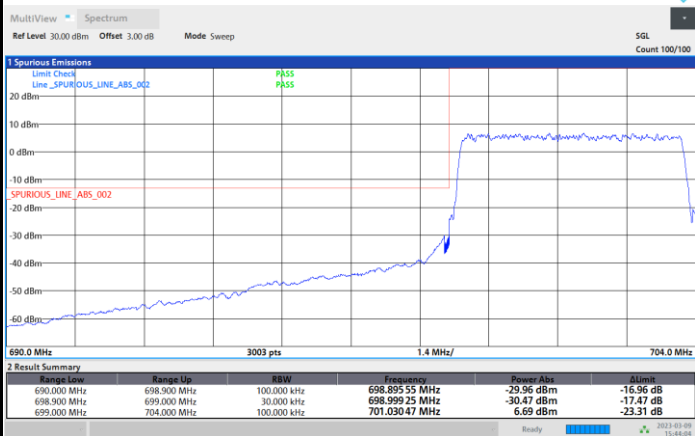



FR1 n12 / 5MHz / DFT-S OFDM / 256QAM

Lowest Band Edge / 1RB0

Highest Band Edge / 1RBmax

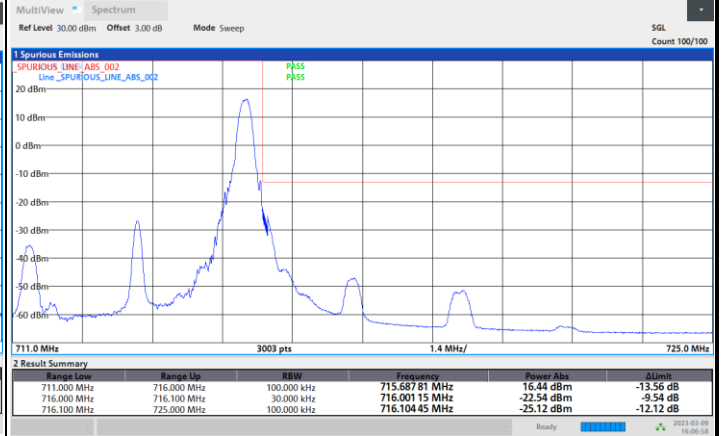
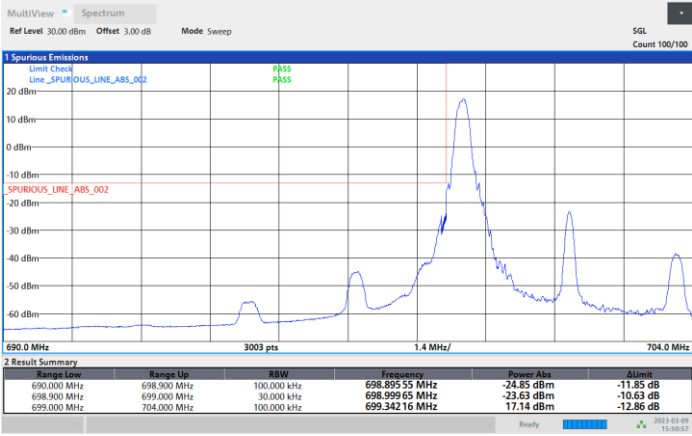

Lowest Band Edge / Full RB

Highest Band Edge / Full RB

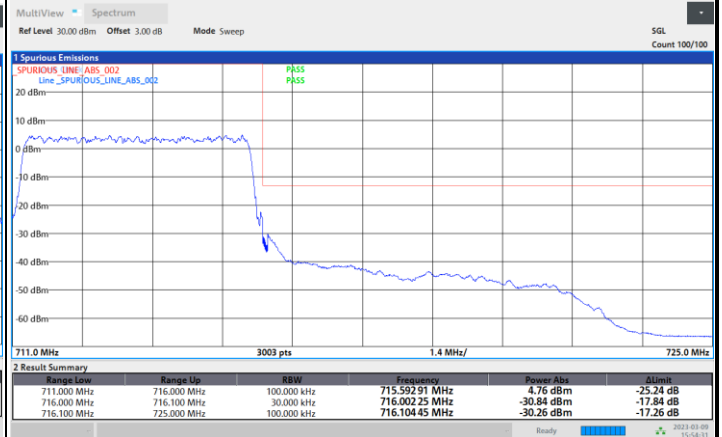
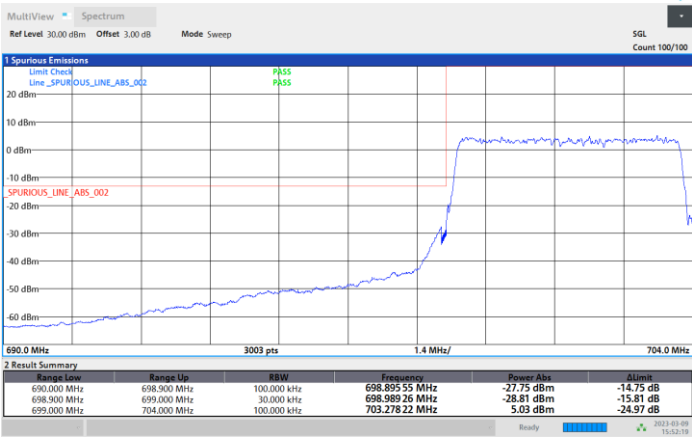



FR1 n12 / 5MHz / CP OFDM / QPSK / Full RB

Lowest Band Edge

Highest Band Edge

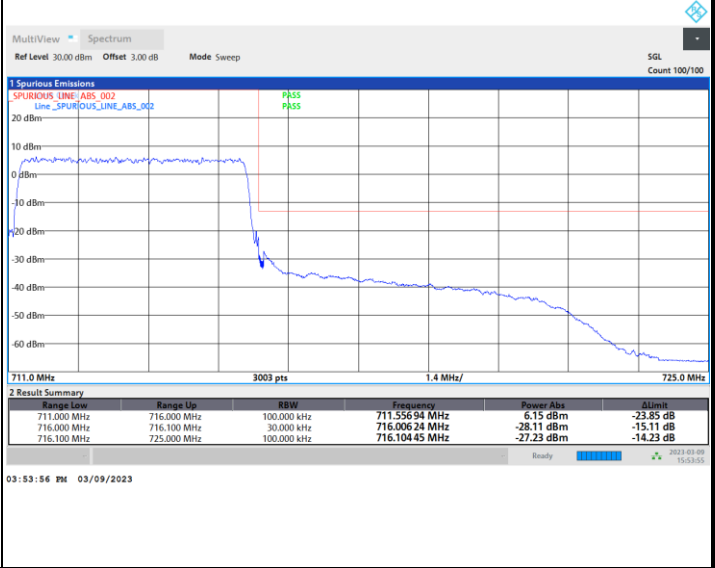
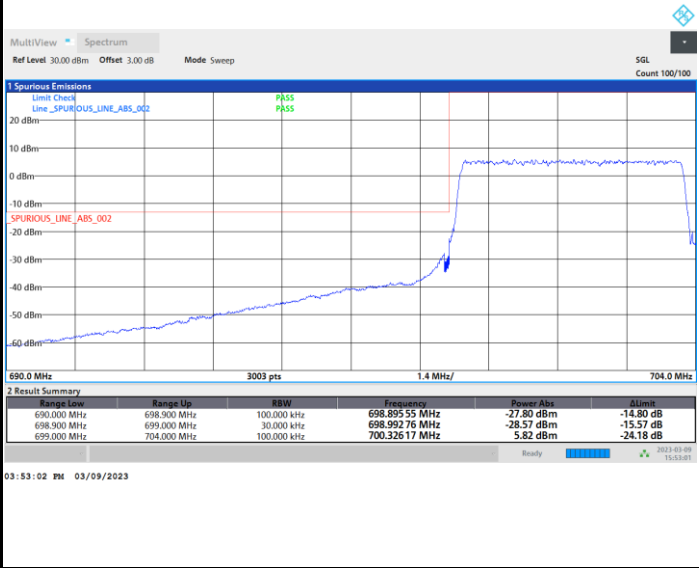



FR1 n12 / 10MHz / DFT-s-OFDM / PI/2 BPSK / Full RB

Lowest Band Edge

Highest Band Edge

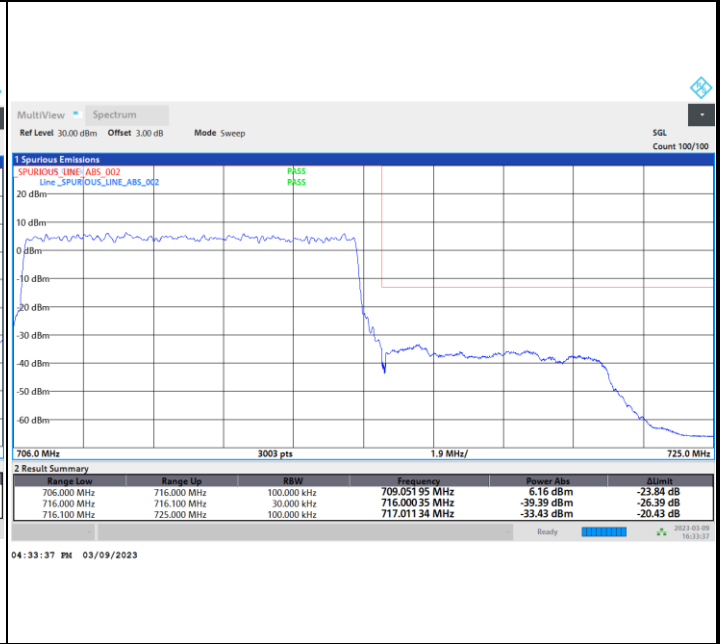
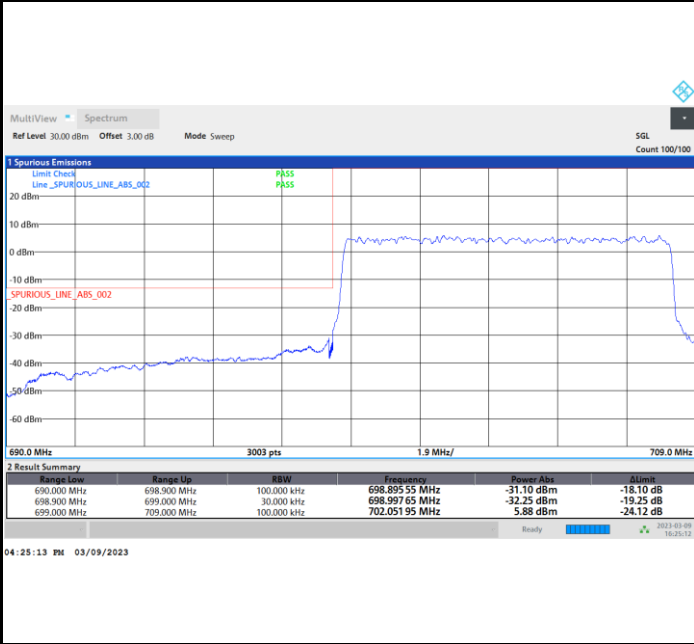

FR1 n12 / 10MHz / DFT-s-OFDM / QPSK / Full RB

Lowest Band Edge

Highest Band Edge

