



FCC RADIO TEST REPORT

FCC ID : PKRISGM3000B
Equipment : M3000B
Brand Name : Inseego
Model Name : M3000B
Marketing Name : M3000
Applicant : Inseego Corp.
9710 Scranton Road Suite 200, San Diego,, CA 92121
Manufacturer : Inseego Corp.
9710 Scranton Road Suite 200, San Diego,, CA 92121
Standard : FCC 47 CFR Part 2, and 90(S)

The product was received on Aug. 10, 2022 and testing was performed from Aug. 19, 2022 to Oct. 04, 2022. We, Sporton International Inc. EMC & Wireless Communications Laboratory, would like to declare that the tested sample has been evaluated in accordance with the test procedures given in ANSI / TIA-603-E and has been in compliance with the applicable technical standards.

The test results in this report apply exclusively to the tested model / sample. Without written approval from Sporton International Inc. EMC & Wireless Communications Laboratory, the test report shall not be reproduced except in full.

Approved by: Louis Wu

Sporton International Inc. EMC & Wireless Communications Laboratory

No. 52, Huaya 1st Rd., Guishan Dist., Taoyuan City 333, Taiwan (R.O.C.)



Table of Contents

History of this test report.....	3
Summary of Test Result.....	4
1 General Description	5
1.1 Feature of Equipment Under Test.....	5
1.2 Modification of EUT	5
1.3 Testing Site.....	5
1.4 Applied Standards	6
2 Test Configuration of Equipment Under Test	7
2.1 Test Mode.....	7
2.2 Connection Diagram of Test System	8
2.3 Support Unit used in test configuration and system	8
2.4 Measurement Results Explanation Example	8
2.5 Frequency List of Low/Middle/High Channels.....	9
3 Conducted Test Items.....	10
3.1 Measuring Instruments.....	10
3.2 Conducted Output Power Measurement and ERP Measurement	11
3.3 Peak-to-Average Ratio	12
3.4 99% Occupied Bandwidth and 26dB Bandwidth Measurement.....	13
3.5 Emissions Mask Measurement	14
3.6 Emissions Mask – Out Of Band Emissions Measurement.....	15
3.7 Frequency Stability Measurement.....	16
3.8 Field Strength of Spurious Radiation Measurement	17
4 List of Measuring Equipment.....	20
5 Uncertainty of Evaluation.....	22
Appendix A. Test Results of Conducted Test	
Appendix B. Test Results of Radiated Test	
Appendix C. Test Setup Photographs	



Summary of Test Result

Report Clause	Ref Std. Clause	Test Items	Result (PASS/FAIL)	Remark
3.2	§2.1046 §90.635	Conducted Output Power and Effective Radiated Power	Pass	-
3.3	-	Peak-to-Average Ratio	Reporting only	-
3.4	§2.1049 §90.209	Occupied Bandwidth and 26dB Bandwidth	Reporting only	-
3.5	§2.1051 §90.691	Emission masks – In-band emissions	Pass	-
3.6	§2.1051 §90.691	Emission masks – Out of band emissions	Pass	-
3.7	§2.1055 §90.213	Frequency Stability for Temperature & Voltage	Pass	-
3.8	§2.1053 §90.691	Field Strength of Spurious Radiation	Pass	44.13 dB under the limit at 3256.000 MHz

Declaration of Conformity:

- The test results (PASS/FAIL) with all measurement uncertainty excluded are presented in accordance with the regulation limits or requirements declared by manufacturers. It's means measurement values may risk exceeding the limit of regulation standards, if measurement uncertainty is include in test results.
- The measurement uncertainty please refer to report "Uncertainty of Evaluation".

Comments and Explanations:

The product specifications of the EUT presented in the report are declared by the manufacturer who shall take full responsibility for the authenticity.

Reviewed by: Avis Chuang

Report Producer: Cindy Liu



1 General Description

1.1 Feature of Equipment Under Test

3G-WCDMA, 4G-LTE, 5G-FR1, Wi-Fi 2.4GHz 802.11b/g/n/ax, Wi-Fi 5GHz 802.11a/n/ac/ax, and GNSS

Product Feature	
Antenna Type	WWAN: Internal Antenna WLAN <Ant. 0>: Internal Antenna <Ant. 1>: Internal Antenna GPS / Glonass / BDS / Galileo : Internal Antenna
Test Antenna Gain	LTE Band 26: 0.8 dBi

Remark: The EUT's information above is declared by manufacturer. Please refer to Comments and Explanations in report summary.

1.2 Modification of EUT

No modifications made to the EUT during the testing.

1.3 Testing Site

Test Site	Sporton International Inc. EMC & Wireless Communications Laboratory	
Test Site Location	No.52, Huaya 1st Rd., Guishan Dist., Taoyuan City 333, Taiwan (R.O.C.) TEL: +886-3-327-3456 FAX: +886-3-328-4978	
Test Site No.	Sporton Site No.	
	TH03-HY	03CH07-HY
Test Engineer	Luffy Lin and Sherry Wu	Jesse Wang, Stan Hsieh and Howard Huang
Temperature (°C)	23.8~24.1	22.6~25.5
Relative Humidity (%)	47~52	56.2~63.7

Note: The test site complies with ANSI C63.4 2014 requirement.

FCC Designation No.: TW1190



1.4 Applied Standards

According to the specifications declared by the manufacturer, the EUT must comply with the requirements of the following standards:

- ♦ FCC 47 CFR Part 2, 90
- ♦ ANSI / TIA-603-E
- ♦ ANSI C63.26-2015
- ♦ FCC KDB 971168 D01 Power Meas. License Digital Systems v03r01
- ♦ FCC KDB 412172 D01 Determining ERP and EIRP v01r01
- ♦ FCC KDB 414788 D01 Radiated Test Site v01r01
- ♦ Interim Guidance for Equipment Authorization of Devices with Channel Bandwidths Combined Across Two Contiguous Service Rule Allocations OET/Lab/EACB, June 6, 2013

Remark:

1. All the test items were validated and recorded in accordance with the standards without any modification during the testing.
2. This EUT has also been tested and complied with the requirements of FCC Part 15, Subpart B, recorded in a separate test report.
3. The TAF code is not including all the FCC KDB listed without accreditation.



2 Test Configuration of Equipment Under Test

2.1 Test Mode

During all testing, EUT is in link mode with base station emulator at maximum power level.

For radiated measurement, the measured emission level of the EUT was maximized by rotating the EUT on a turntable, adjusting the orientation of the EUT and EUT antenna in three orthogonal axis (X: flat, Y: portrait, Z: landscape), and adjusting the measurement antenna orientation, following C63.26 exploratory test procedures and only the worst case emissions were reported in this report.

Frequency range investigated for radiated emission is 30 MHz to 9000 MHz.

Conducted Test Cases	Band	Bandwidth (MHz)				Modulation					RB #			Test Channel		
		5	10	15	20	PI/2 BPSK	QPSK	16QAM	64QAM	256QAM	1	Half	Full	L	M	H
Max. Output Power	n26	v	v	v	v	v	v	v	v	v	v	v	v	v	v	v
Peak-to-Average Ratio	n26		v		v	v	v	v	v	v			v		v	
26dB and 99% Bandwidth	n26	v	v	v	v	v	v	v	v	v			v		v	
Emission masks In-band emissions	n26	v	v			v	v	v	v	v	v		v	v	v	v
Emission masks – Out of band emissions	n26	v					v					v		v	v	v
Frequency Stability	n26		v		v	v							v		v	
E.R.P.	n26	v	v	v	v	v	v	v	v	v	Max. Power					
Radiated Spurious Emission	n26	Worst Case											v	v	v	
Remark	<ol style="list-style-type: none"> The mark "v " means that this configuration is chosen for testing The mark "- " means that this bandwidth is not supported. 5G NR n26 transmit frequency for part22 rule is 824MHz-849MHz, for part90 rule is 814MHz-824MHz. ERP over 15MHz bandwidth complies the ERP limit line of part22 rule, therefore ERP of the partial frequency spectrum which falls within part 22 also complies. For radiated measurement, pre-scanned in two modes, DFT-s OFDM and CP OFDM. The worst cases (DFT-s OFDM) were recorded in this report. One representative bandwidth is selected to perform PAR and frequency stability. 															

2.2 Connection Diagram of Test System

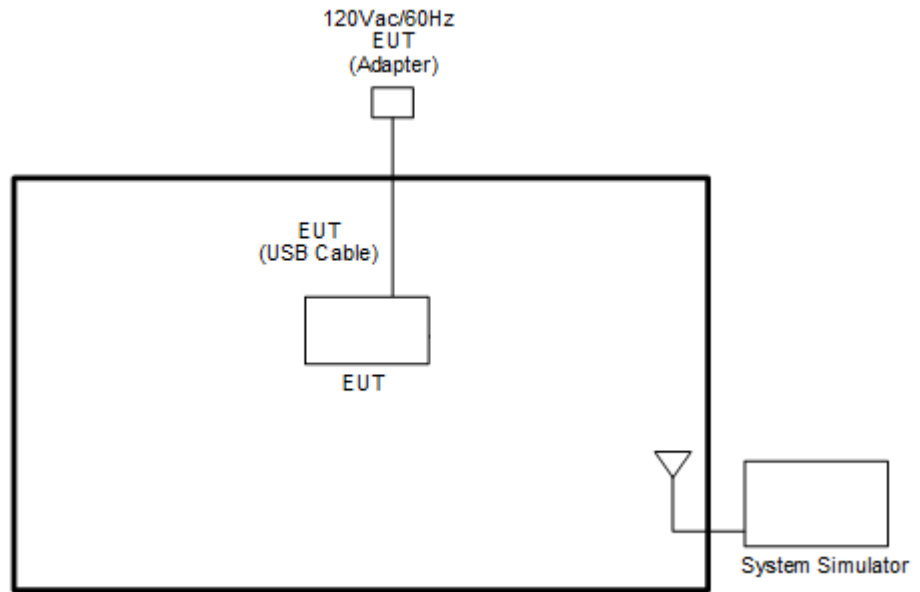

2.3 Support Unit used in test configuration and system

Item	Equipment	Brand Name	Model No.	FCC ID	Data Cable	Power Cord
1.	System Simulator	Anritsu	MT8000A	N/A	N/A	Unshielded, 1.8 m

2.4 Measurement Results Explanation Example

For all conducted test items:

The offset level is set in the spectrum analyzer to compensate the RF cable loss and attenuator factor between RF conducted output port and spectrum analyzer. With the offset compensation, the spectrum analyzer reading level will be exactly the RF output level.

The spectrum analyzer offset is derived from RF cable loss and attenuator factor.

Offset = RF cable loss + attenuator factor.

The following shows an offset computation example with RF cable loss 4.2 dB and a 10dB attenuator.

Example :

Offset(dB) = RF cable loss(dB) + attenuator factor(dB).

$$= 4.2 + 10 = 14.2 \text{ (dB)}$$



2.5 Frequency List of Low/Middle/High Channels

5G NR n26 Channel and Frequency List				
BW [MHz]	Channel/Frequency(MHz)	Lowest	Middle	Highest
10	Channel	-	163800	-
	Frequency	-	819	-
5	Channel	163300	163800	164300
	Frequency	816.5	819	821.5

5G NR n26 Channel and Frequency List				
BW [MHz]	Channel/Frequency(MHz)	-	cross-rule channels	-
20	Channel	-	164800	-
	Frequency	-	824	-
15	Channel	-	164800	-
	Frequency	-	824	-
10	Channel	-	164800	-
	Frequency	-	824	-
5	Channel	-	164800	-
	Frequency	-	824	-

3 Conducted Test Items

3.1 Measuring Instruments

See list of measuring instruments of this test report.

3.1.1 Test Setup

3.1.2 Conducted Output Power

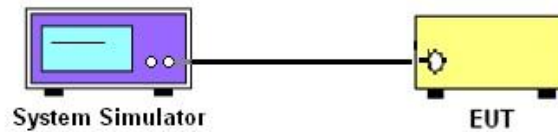

3.1.3 Peak-to-Average Ratio, Occupied Bandwidth, Conducted Band-Edge, Emission Mask, Emissions Mask – Out Of Band Emissions, and Conducted Spurious Emission

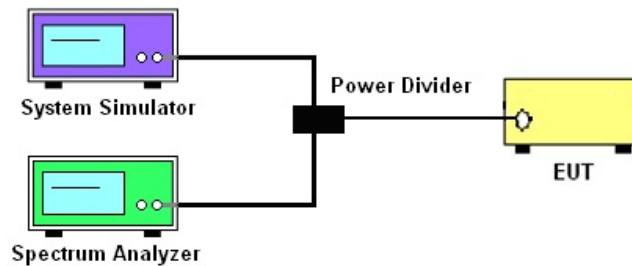

3.1.4 Frequency Stability

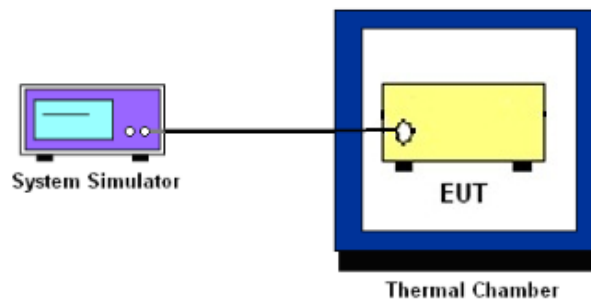

3.1.5 Test Result of Conducted Test

Please refer to Appendix A.



3.2 Conducted Output Power Measurement and ERP Measurement

3.2.1 Description of the Conducted Output Power Measurement and ERP Measurement

A system simulator was used to establish communication with the EUT. Its parameters were set to enforce EUT transmitting at the maximum power. The measured power in the radio frequency on the transmitter output terminals shall be reported.

The output power of mobile transmitters must not exceed 100 Watts for 5G NR n26.

According to KDB 412172 D01 Power Approach,

$EIRP = P_T + G_T - L_C$, where

P_T = transmitter output power in dBm

G_T = gain of the transmitting antenna in dBi

L_C = signal attenuation in the connecting cable between the transmitter and antenna in dB

3.2.2 Test Procedures

1. The transmitter output port was connected to the system simulator.
2. Set EUT at maximum power through system simulator.
3. Select lowest, middle, and highest channels for each band and different modulation.
4. Measure and record the power level from the system simulator.



3.3 Peak-to-Average Ratio

3.3.1 Description of the PAR Measurement

Reporting only

3.3.2 Test Procedures

1. The EUT was connected to spectrum and system simulator via a power divider.
2. Set the CCDF (Complementary Cumulative Distribution Function) option in spectrum analyzer.
3. The highest RF powers were measured and recorded the maximum PAPR level associated with a probability of 0.1 %.
4. Record the deviation as Peak to Average Ratio.



3.4 99% Occupied Bandwidth and 26dB Bandwidth Measurement

3.4.1 Description of (Occupied) Bandwidth Limitations Measurement

The 99% occupied bandwidth is the width of a frequency band such that, below the lower and above the upper frequency limits, the mean powers emitted are each equal to a specified percentage 0.5% of the total mean transmitted power.

The emission bandwidth is defined as the width of the signal between two points, located at the 2 sides of the carrier frequency, outside of which all emissions are attenuated at least 26 dB below the transmitter power.

3.4.2 Test Procedures

1. The EUT was connected to spectrum analyzer and system simulator via a power divider.
2. The 26dB and 99% occupied bandwidth (BW) of the middle channel for the highest RF power with full RB sizes were measured.



3.5 Emissions Mask Measurement

3.5.1 Description of Emissions Mask Measurement

Equipment used in this licensed to EA or non-EA systems shall comply with the emission mask provisions of FCC Part 90.691.(a)

(a) Out-of-band emission requirement shall apply only to the “outer” channels included in an EA license and to spectrum adjacent to interior channels used by incumbent licensees. The emission limits are as follows:

(1) For any frequency removed from the EA licensee's frequency block by up to and including 37.5 kHz, the power of any emission shall be attenuated below the transmitter power (P) in watts by at least $116 \text{ Log}_{10}(f/6.1)$ decibels or $50 + 10 \text{ Log}_{10}(P)$ decibels or 80 decibels, whichever is the lesser attenuation, where f is the frequency removed from the center of the outer channel in the block in kilohertz and where f is greater than 12.5 kHz.

(2) For any frequency removed from the EA licensee's frequency block greater than 37.5 kHz, the power of any emission shall be attenuated below the transmitter power (P) in watts by at least $43 + 10 \text{ Log}_{10}(P)$ decibels or 80 decibels, whichever is the lesser attenuation, where f is the frequency removed from the center of the outer channel in the block in kilohertz and where f is greater than 37.5 kHz.

3.5.2 Test Procedures

1. The EUT was connected to spectrum analyzer and base station via power divider.
2. The emissions mask of low and high channels for the highest RF powers were measured.
3. Set RBW and VBW 3 times of RBW to make the measurement with the spectrum analyzer's, and according to KDB 971168 D02 Misc Rev Approve License Devices v02r01 standards, set RBW = 300 Hz to make offsets less than 37.5 kHz from a channel edge , RBW = 100 kHz to make offsets greater than 37.5 kHz, that is allowed.
4. The test results were shown below plots with a correction offset factor including cable loss, insertion loss of power divider.



3.6 Emissions Mask – Out Of Band Emissions Measurement

3.6.1 Description of Conducted Emissions Out of band emissions measurement

The power of any emission FCC Part 90.691 (a)(2) on any frequency removed from the assigned frequency by out of the authorized bandwidth at least $43 + 10 \log (P)$ dB. It is measured by means of a calibrated spectrum analyzer and scanned from 30 MHz up to a frequency including its 10th harmonic.

3.6.2 Test Procedures

1. The EUT was connected to spectrum analyzer and system simulator via a power divider.
2. The RF output of EUT was connected to the spectrum analyzer by RF cable and attenuator. The path loss was compensated to the results for each measurement.
3. The middle channel for the highest RF power within the transmitting frequency was measured.
4. The conducted spurious emission for the whole frequency range was taken.
5. For testing below 1GHz, make the measurement with the spectrum analyzer's RBW = 100 kHz, VBW = 3MHz, taking the record of maximum spurious emission.
6. For testing above 1GHz, make the measurement with the spectrum analyzer's RBW = 1MHz, VBW = 3MHz, taking the record of maximum spurious emission.
7. The RF fundamental frequency should be excluded against the limit line in the operating frequency band.
8. The limit line is derived from $43 + 10\log(P)$ dB below the transmitter power P(Watts)



3.7 Frequency Stability Measurement

3.7.1 Description of Frequency Stability Measurement

The frequency stability shall be sufficient to ensure that the fundamental emission stays within the authorized frequency block.

3.7.2 Measuring Instruments

The measuring equipment is listed in the section 4 of this test report.

3.7.3 Test Procedures for Temperature Variation

1. The EUT was set up in the thermal chamber and connected with the base station.
2. With power OFF, the temperature was decreased to -30°C and the EUT was stabilized for three hours. Power was applied and the maximum change in frequency was recorded within one minute.
3. With power OFF, the temperature was raised in 10°C step up to 50°C. The EUT was stabilized at each step for at least half an hour. Power was applied and the maximum frequency change was recorded within one minute.

3.7.4 Test Procedures for Voltage Variation

1. The EUT was placed in a temperature chamber at 20±5° C and connected with the base station.
2. The power supply voltage to the EUT was varied from BEP to 115% of the nominal value measured at the input to the EUT.
3. The variation in frequency was measured for the worst case.



3.8 Field Strength of Spurious Radiation Measurement

3.8.1 Description of Field Strength of Spurious Radiated Measurement

The radiated spurious emission was measured by substitution method according to ANSI / TIA-603-E. The power of any emission FCC Part 90.691 on any frequency removed from the assigned frequency by more than 250 percent of the authorized bandwidth at least $43 + 10 \log (P)$ dB. The spectrum is scanned from 30 MHz up to a frequency including its 10th harmonic.

The power of any emission outside of the authorized operating frequency ranges must be attenuated below the transmitter power (P) by a factor of at least $43+10\log_{10}(P[\text{Watts}])$ dB. The spectrum is scanned from 30 MHz up to a frequency including its 10th harmonic.

3.8.2 Test Procedures

1. The EUT was placed on a turntable with 0.8 meter for frequency below 1GHz and 1.5 meter for frequency above 1GHz respectively above ground.
2. The EUT was set 3 meters from the receiving antenna, which was mounted on the antenna tower.
3. The table was rotated 360 degrees to determine the position of the highest spurious emission.
4. The height of the receiving antenna is varied between one meter and four meters to search the maximum spurious emission for both horizontal and vertical polarizations.
5. For testing below 1GHz, make the measurement with the spectrum analyzer's RBW = 100 kHz, VBW = 3MHz, Sweep = 500ms, Taking the record of maximum spurious emission.
6. For testing above 1GHz, make the measurement with the spectrum analyzer's RBW = 1MHz, VBW = 3MHz, Sweep = 500ms, Taking the record of maximum spurious emission.
7. Measure the burst average result by setting trace = max hold or trace = average with duty cycle factor when margin is not enough.
8. A horn antenna was substituted in place of the EUT and was driven by a signal generator.
9. Tune the output power of signal generator to the same emission level with EUT maximum spurious emission.
10. Taking the record of output power at antenna port.
11. Repeat step 7 to step 8 for another polarization.
12. $\text{EIRP (dBm)} = \text{S.G. Power} - \text{Tx Cable Loss} + \text{Tx Antenna Gain}$
13. $\text{ERP (dBm)} = \text{EIRP} - 2.15$
14. The RF fundamental frequency should be excluded against the limit line in the operating frequency band.
15. The limit line is derived from $43 + 10\log(P)$ dB below the transmitter power P(Watts)

3.8.3 Test Setup

For radiated test below 30MHz

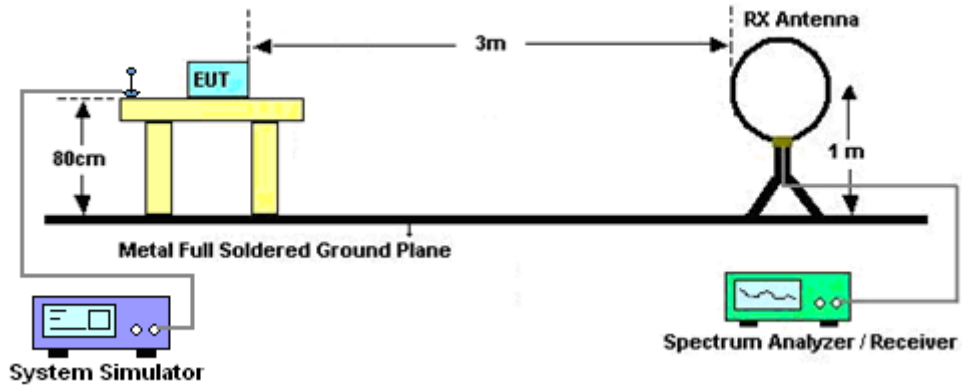

For radiated test from 30MHz to 1GHz

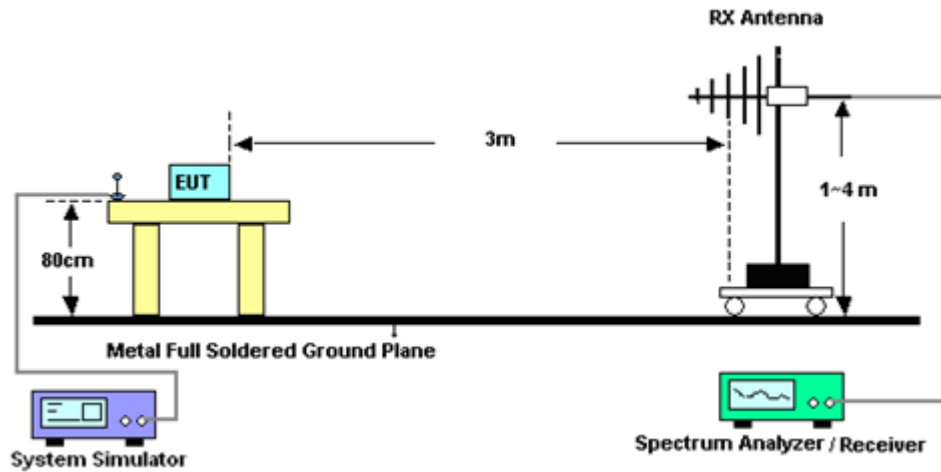

For radiated test above 1GHz

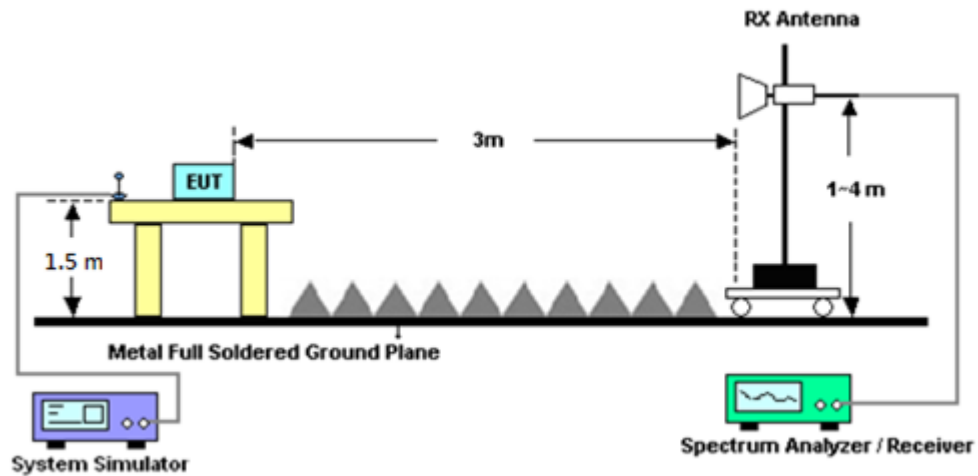

3.8.4 Test Result of Field Strength of Spurious Radiated

Please refer to Appendix B.

Note:

The low frequency, which started from 9 kHz to 30MHz, was pre-scanned and the result which was 20dB lower than the limit line was not reported.

There is adequate comparison measurement of both open-field test site and alternative test site - semi-Anechoic chamber according to 414788 D01 Radiated Test Site v01r01, and the result came out very similar.



4 List of Measuring Equipment

Instrument	Brand Name	Model No.	Serial No.	Characteristics	Calibration Date	Test Date	Due Date	Remark
Bilog Antenna	TESEQ	CBL 6111D & 00800N1D01 N-06	35419 & 03	30MHz~1GHz	Apr. 24, 2022	Sep. 05, 2022~ Sep. 24, 2022	Apr. 23, 2023	Radiation (03CH07-HY)
Double Ridge Horn Antenna	ESCO	3117	00075962	1GHz ~ 18GHz	Dec. 03, 2021	Sep. 05, 2022~ Sep. 24, 2022	Dec. 02, 2022	Radiation (03CH07-HY)
Preamplifier	COM-POWER	PA-103A	161241	10MHz~1GHz	Oct. 04, 2021	Sep. 05, 2022~ Sep. 24, 2022	Oct. 03, 2022	Radiation (03CH07-HY)
Preamplifier	Agilent	8449B	3008A02362	1GHz~26.5GHz	Oct. 04, 2021	Sep. 05, 2022~ Sep. 24, 2022	Oct. 03, 2022	Radiation (03CH07-HY)
Preamplifier	MITEQ	AMF-7D-0010 1800-30-10P	1590075	1GHz~18GHz	Apr. 21, 2022	Sep. 05, 2022~ Sep. 24, 2022	Apr. 20, 2023	Radiation (03CH07-HY)
Spectrum Analyzer	Agilent	N9030A	MY52350276	3Hz~44GHz	Jul. 22, 2022	Sep. 05, 2022~ Sep. 24, 2022	Jul. 21, 2023	Radiation (03CH07-HY)
RF Cable	HUBER + SUHNER	SUCOFLEX 104	MY15682/4	30MHz to 18GHz	Feb. 23, 2022	Sep. 05, 2022~ Sep. 24, 2022	Feb. 22, 2023	Radiation (03CH07-HY)
RF Cable	HUBER + SUHNER	SUCOFLEX 104	MY24971/4	9kHz to 18GHz	Feb. 23, 2022	Sep. 05, 2022~ Sep. 24, 2022	Feb. 22, 2023	Radiation (03CH07-HY)
RF Cable	HUBER + SUHNER	SUCOFLEX 104	MY28655/4	9kHz to 18GHz	Feb. 23, 2022	Sep. 05, 2022~ Sep. 24, 2022	Feb. 22, 2023	Radiation (03CH07-HY)
RF Cable	HUBER + SUHNER	SUCOFLEX 102	801606/2	9KHz ~ 40GHz	Apr. 14, 2022	Sep. 05, 2022~ Sep. 24, 2022	Apr. 13, 2023	Radiation (03CH07-HY)
Controller	EMEC	EM1000	N/A	Control Ant Mast	N/A	Sep. 05, 2022~ Sep. 24, 2022	N/A	Radiation (03CH07-HY)
Controller	MF	MF-7802	N/A	Control Turn table	N/A	Sep. 05, 2022~ Sep. 24, 2022	N/A	Radiation (03CH07-HY)
Antenna Mast	EMEC	AM-BS-4500E	N/A	Boresight mast 1M~4M	N/A	Sep. 05, 2022~ Sep. 24, 2022	N/A	Radiation (03CH07-HY)
Turn Table	ChainTek	Chaintek 3000	N/A	0~360 Degree	N/A	Sep. 05, 2022~ Sep. 24, 2022	N/A	Radiation (03CH07-HY)
Software	Audix	E3	N/A	N/A	N/A	Sep. 05, 2022~ Sep. 24, 2022	N/A	Radiation (03CH07-HY)
USB Data Logger	TECPEL	TR-32	HE17XB2495	N/A	Mar. 07, 2022	Sep. 05, 2022~ Sep. 24, 2022	Mar. 06, 2023	Radiation (03CH07-HY)
Horn Antenna	EMCO	3117	00143261	1GHz~18GHz	Feb. 11, 2022	Sep. 05, 2022~ Sep. 24, 2022	Feb. 10, 2023	Radiation (03CH07-HY)
Signal Generator	Rohde & Schwarz	SMF100A	101107	100kHz~40GHz	Dec. 08, 2021	Sep. 05, 2022~ Sep. 24, 2022	Dec. 07, 2022	Radiation (03CH07-HY)
Loop Antenna	TESEQ	HLA 6120	31244	9 kHz~30 MHz	Mar. 18, 2022	Sep. 05, 2022~ Sep. 24, 2022	Mar. 17, 2023	Radiation (03CH07-HY)



Instrument	Brand Name	Model No.	Serial No.	Characteristics	Calibration Date	Test Date	Due Date	Remark
Programmable Power Supply	GW Instek	PSS-2005	EL890001	50Hz~60Hz	Oct. 06, 2021	Aug. 19, 2022~ Oct. 04, 2022	Oct. 05, 2022	Conducted (TH03-HY)
Hygrometer	Testo	608-H11	34893240	NA	Nov. 17, 2021	Aug. 19, 2022~ Oct. 04, 2022	Nov. 16, 2022	Conducted (TH03-HY)
Signal Analyzer	Rohde & Schwarz	FSV3044	101048	10Hz~44GHz	May 05, 2022	Aug. 19, 2022~ Oct. 04, 2022	May 04, 2023	Conducted (TH03-HY)
Temperature Chamber	ESPEC	LHU-113	1012005860	-20℃ ~85℃	Dec. 09, 2021	Aug. 19, 2022~ Sep. 07, 2022	Dec. 08, 2022	Conducted (TH03-HY)
Temperature Chamber	ESPEC	SH-641	92013720	-40℃ ~90℃	Sep. 07, 2022	Sep. 08, 2022~ Oct. 04, 2022	Sep. 06, 2023	Conducted (TH03-HY)
Base Station (Measure)	Anritsu	MT8821C	6261849015	LTE	Oct. 06, 2021	Aug. 19, 2022~ Oct. 04, 2022	Oct. 05, 2022	Conducted (TH03-HY)
Base Station (Measure)	Anritsu	MT8000A	6261940327	FR1	Oct. 29, 2021	Aug. 19, 2022~ Oct. 04, 2022	Oct. 28, 2022	Conducted (TH03-HY)



5 Uncertainty of Evaluation

Uncertainty of Radiated Emission Measurement (30 MHz ~ 1000 MHz)

Measuring Uncertainty for a Level of Confidence of 95% ($U = 2Uc(y)$)	3.25 dB
---	---------

Uncertainty of Radiated Emission Measurement (1 GHz ~ 18 GHz)

Measuring Uncertainty for a Level of Confidence of 95% ($U = 2Uc(y)$)	3.50 dB
---	---------



Appendix A. Test Results of Conducted Test

Conducted Output Power(Average power) and ERP

Part90s NR n26 Maximum Average Power [dBm] (GT - LC = 0.8 dB)								
BW [MHz]	RB Size	RB Offset	Mod	Lowest	Middle	Highest	ERP (dBm)	ERP
5	1	1	PI/2 BPSK	23.91	23.80	23.81	22.59	0.1816
5	1	23		23.87	23.76	23.72		
5	12	6		23.83	23.87	23.73		
5	1	0		23.32	23.30	23.25		
5	1	24		23.27	23.20	23.16		
5	25	0		23.30	23.24	23.24		
5	1	1	QPSK	23.94	23.82	23.73		
5	1	23		23.82	23.71	23.72		
5	12	6		23.86	23.83	23.78		
5	1	0		22.85	22.82	22.74		
5	1	24		22.77	22.75	22.69		
5	25	0		22.87	22.78	22.71		
5	1	1	16-QAM	22.90	22.85	22.80	21.55	0.1429
5	1	1	64-QAM	21.52	21.51	21.36		
5	1	1	256-QAM	18.89	18.82	18.74		
Limit	Output power < 100W			Result			Pass	

Part90s NR n26 Maximum Average Power [dBm] (GT - LC = 0.8 dB)								
BW [MHz]	RB Size	RB Offset	Mod	Lowest	Middle	Highest	ERP (dBm)	ERP
10	1	1	PI/2 BPSK	-	23.87	-	22.53	0.1791
10	1	50		-	23.70	-		
10	25	12		-	23.75	-		
10	1	0		-	23.33	-		
10	1	51		-	23.22	-		
10	50	0		-	23.22	-		
10	1	1	QPSK	-	23.88	-		
10	1	50		-	23.72	-		
10	25	12		-	23.80	-		
10	1	0		-	22.75	-		
10	1	51		-	22.67	-		
10	50	0		-	22.81	-		
10	1	1	16-QAM	-	22.71	-	21.36	0.1368
10	1	1	64-QAM	-	21.55	-		
10	1	1	256-QAM	-	18.75	-		
Limit	Output power < 100W			Result			Pass	



NR n26 Straddle Channel Maximum Average Power [dBm] (GT - LC = 0.8 dB)								
BW [MHz]	RB Size	RB Offset	Mod	Lowest	Middle	Highest	ERP (dBm)	ERP
5	1	1	PI/2 BPSK	-	23.91	-	22.62	0.1828
5	1	23		-	23.97	-		
5	12	6		-	23.86	-		
5	1	0		-	23.36	-		
5	1	24		-	23.40	-		
5	25	0		-	23.35	-		
5	1	1	QPSK	-	23.94	-	21.58	0.1439
5	1	23		-	23.95	-		
5	12	6		-	23.93	-		
5	1	0		-	22.90	-		
5	1	24		-	22.92	-		
5	25	0		-	22.84	-		
5	1	1	16-QAM	-	22.93	-	21.58	0.1439
5	1	1	64-QAM	-	21.54	-		
5	1	1	256-QAM	-	18.92	-		
Limit	ERP < 7W			Result			Pass	

NR n26 Straddle Channel Maximum Average Power [dBm] (GT - LC = 0.8 dB)								
BW [MHz]	RB Size	RB Offset	Mod	Lowest	Middle	Highest	ERP (dBm)	ERP
10	1	1	PI/2 BPSK	-	23.96	-	22.64	0.1837
10	1	50		-	23.91	-		
10	25	12		-	23.92	-		
10	1	0		-	23.44	-		
10	1	51		-	23.38	-		
10	50	0		-	23.41	-		
10	1	1	QPSK	-	23.99	-	21.58	0.1439
10	1	50		-	23.93	-		
10	25	12		-	23.92	-		
10	1	0		-	22.97	-		
10	1	51		-	22.93	-		
10	50	0		-	22.91	-		
10	1	1	16-QAM	-	22.93	-	21.58	0.1439
10	1	1	64-QAM	-	21.60	-		
10	1	1	256-QAM	-	18.90	-		
Limit	ERP < 7W			Result			Pass	



NR n26 Straddle Channel Maximum Average Power [dBm] (GT - LC = 0.8 dB)								
BW [MHz]	RB Size	RB Offset	Mod	Lowest	Middle	Highest	ERP (dBm)	ERP
15	1	1	PI/2 BPSK	-	23.90	-	22.64	0.1837
15	1	77		-	23.88	-		
15	36	18		-	23.98	-		
15	1	0		-	23.50	-		
15	1	78		-	23.55	-		
15	75	0		-	23.63	-		
15	1	1	QPSK	-	23.99	-		
15	1	77		-	23.91	-		
15	36	18		-	23.95	-		
15	1	0		-	23.06	-		
15	1	78		-	23.09	-		
15	75	0		-	23.10	-		
15	1	1	16-QAM	-	23.08	-	21.73	0.1489
15	1	1	64-QAM	-	21.78	-		
15	1	1	256-QAM	-	19.07	-		
Limit	ERP < 7W			Result			Pass	

NR n26 Straddle Channel Maximum Average Power [dBm] (GT - LC = 0.8 dB)								
BW [MHz]	RB Size	RB Offset	Mod	Lowest	Middle	Highest	ERP (dBm)	ERP
20	1	1	PI/2 BPSK	-	23.79	-	22.57	0.1807
20	1	104		-	23.91	-		
20	50	25		-	23.90	-		
20	1	0		-	23.26	-		
20	1	105		-	23.38	-		
20	100	0		-	23.42	-		
20	1	1	QPSK	-	23.81	-		
20	1	104		-	23.86	-		
20	50	25		-	23.92	-		
20	1	0		-	22.77	-		
20	1	105		-	22.91	-		
20	100	0		-	22.85	-		
20	1	1	16-QAM	-	22.76	-	21.41	0.1384
20	1	1	64-QAM	-	21.52	-		
20	1	1	256-QAM	-	18.77	-		
Limit	ERP < 7W			Result			Pass	



FR1 n26

Peak-to-Average Ratio

Mode	FR1 n26 / 10MHz / DFT-S OFDM				
Mod.	PI/2 BPSK	QPSK	16QAM	64QAM	Limit: 13dB
RB Size	Full RB	Full RB	Full RB	Full RB	Result
Middle CH	4.64	5.72	6.46	6.48	PASS
Mode	FR1 n26 / 10MHz / DFT-S OFDM				
Mod.	256QAM				Limit: 13dB
RB Size	Full RB				Result
Middle CH	6.58				PASS



FR1 n26 / 10MHz / DFT-S OFDM / Middle Channel / Full RB

PI/2 BPSK

QPSK

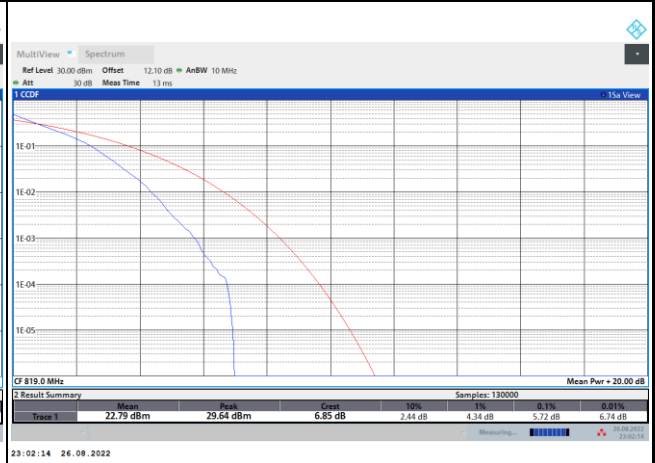
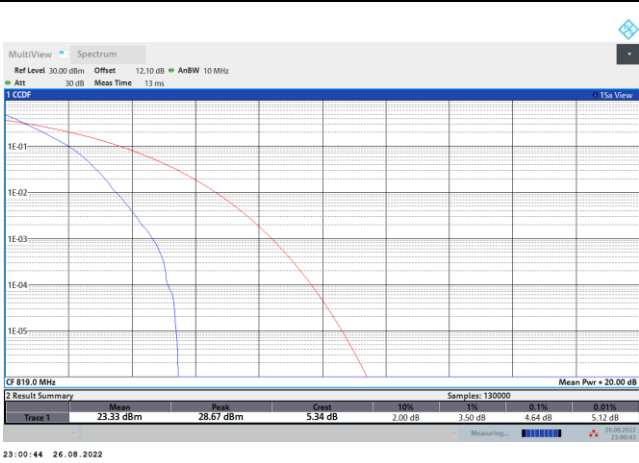

16QAM

64QAM

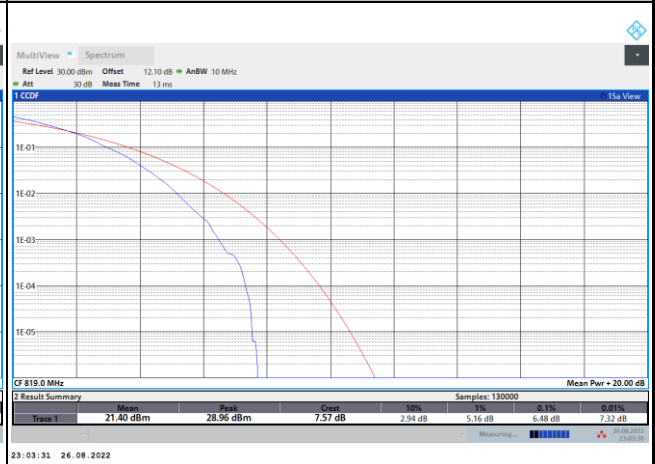
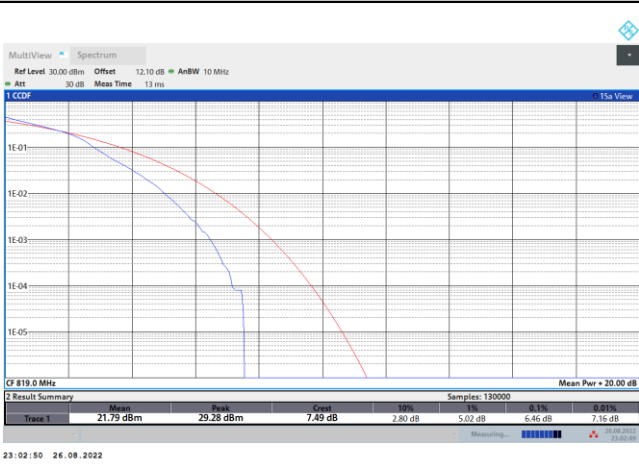

256QAM

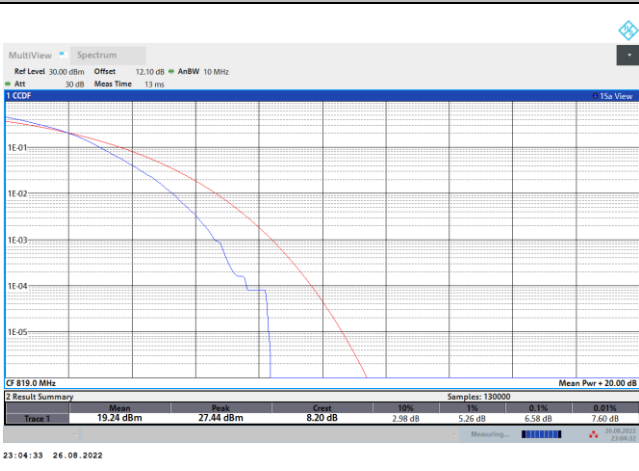



26dB Bandwidth

Mode	FR1 n26 : 26dB BW(MHz) / DFT-S OFDM							
BW	5MHz		10MHz					
Mod.	PI/2 BPSK		PI/2 BPSK					
Middle CH	5.00		9.55					

Mode	FR1 n26 : 26dB BW(MHz) / CP OFDM							
BW	5MHz		10MHz					
Mod.	QPSK	16QAM	QPSK	16QAM				
Middle CH	4.96	5.17	9.91	9.77				
Mod.	64QAM	256QAM	64QAM	256QAM				
Middle CH	5.15	5.09	9.97	9.95				



FR1 n26 / 5MHz / DFT-S OFDM / Middle Channel / Full RB

PI/2 BPSK

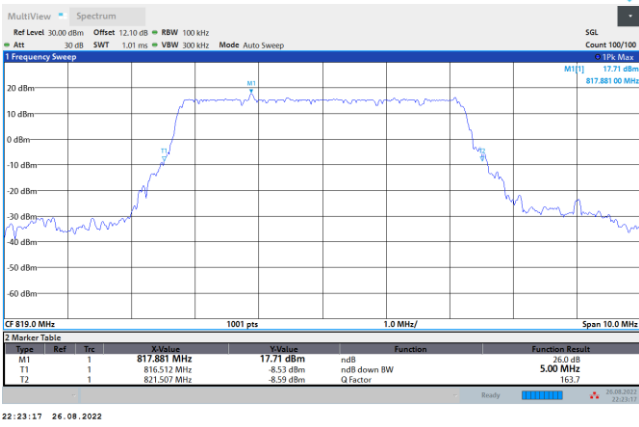

FR1 n26 / 5MHz / CP OFDM / Middle Channel / Full RB

QPSK

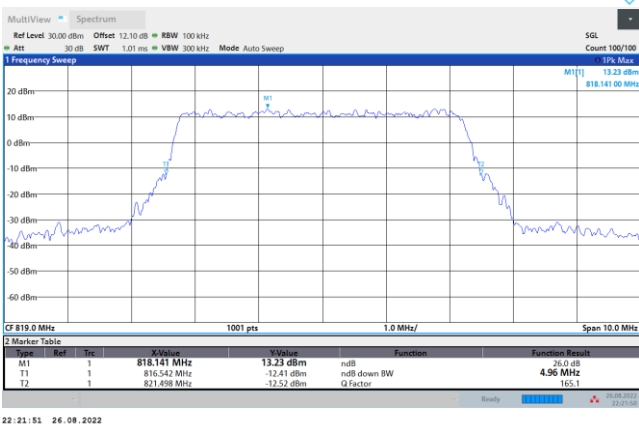

16QAM

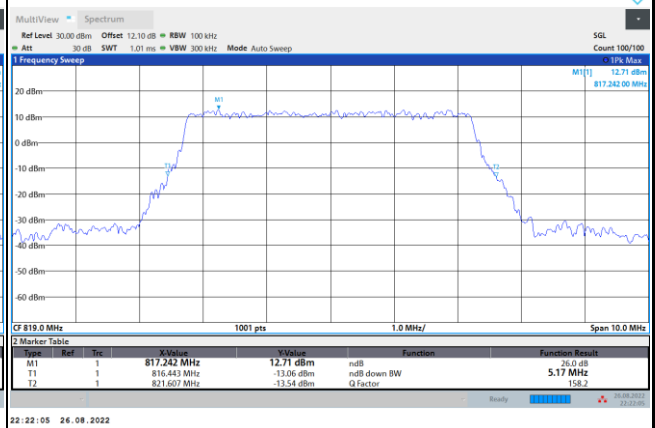

64QAM

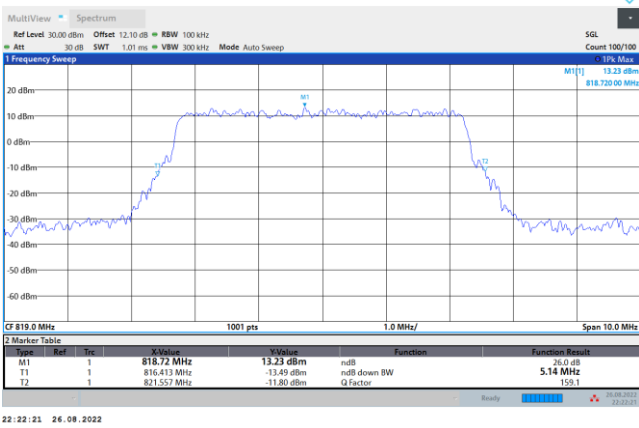

256QAM

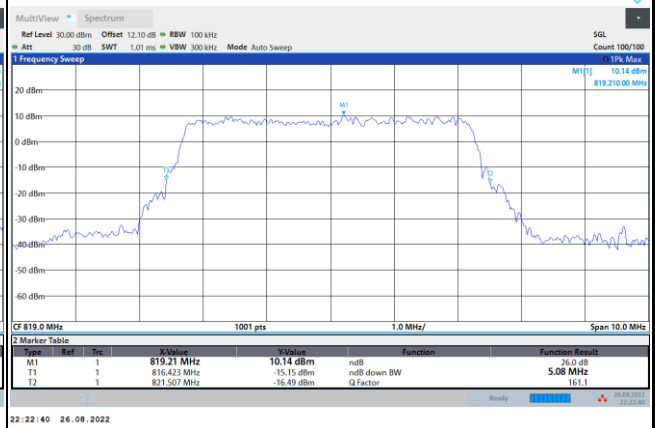



FR1 n26 / 10MHz / DFT-S OFDM / Middle Channel / Full RB

PI/2 BPSK

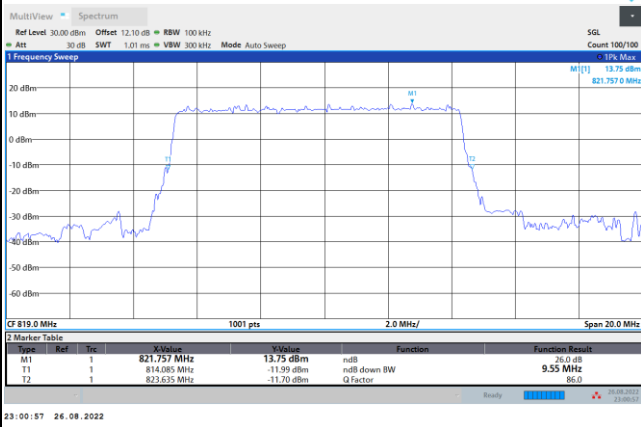

FR1 n26 / 10MHz / CP OFDM / Middle Channel / Full RB

QPSK



16QAM

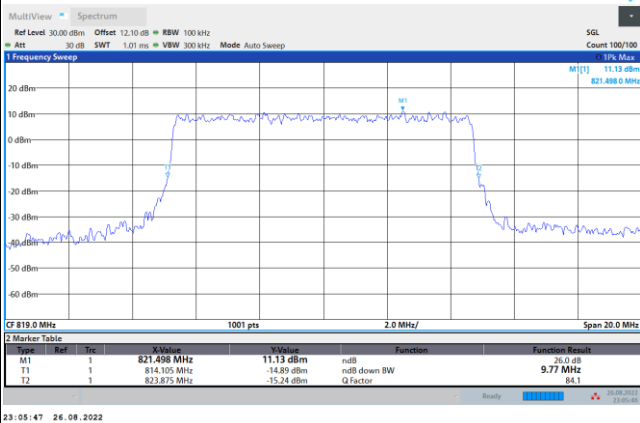

64QAM

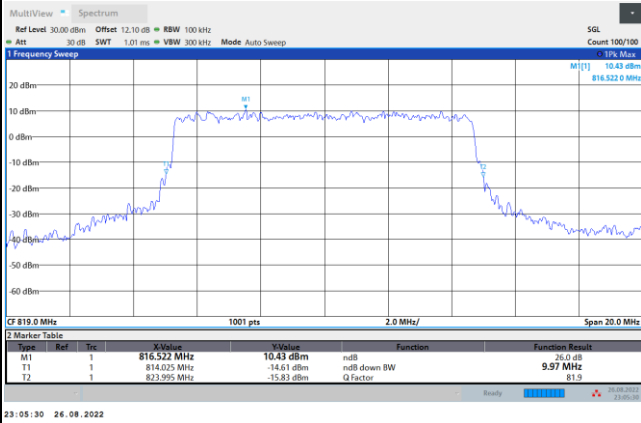

256QAM

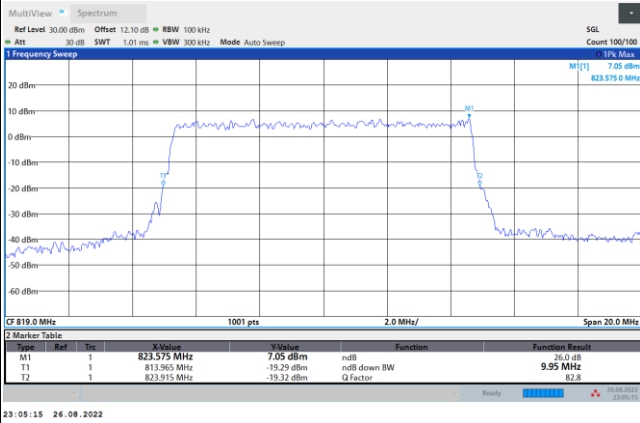



Occupied Bandwidth

Mode	FR1 n26 : 99%OBW(MHz) / DFT-S OFDM							
BW	5MHz		10MHz					
Mod.	PI/2 BPSK		PI/2 BPSK					
Middle CH	4.46		8.91					

Mode	FR1 n26 : 99%OBW (MHz) / CP OFDM							
BW	5MHz		10MHz					
Mod.	QPSK	16QAM	QPSK	16QAM				
Middle CH	4.48	4.47	9.28	9.28				
Mod.	64QAM	256QAM	64QAM	256QAM				
Middle CH	4.49	4.50	9.26	9.28				



FR1 n26 / 5MHz / DFT-S OFDM / Middle Channel / Full RB

PI/2 BPSK

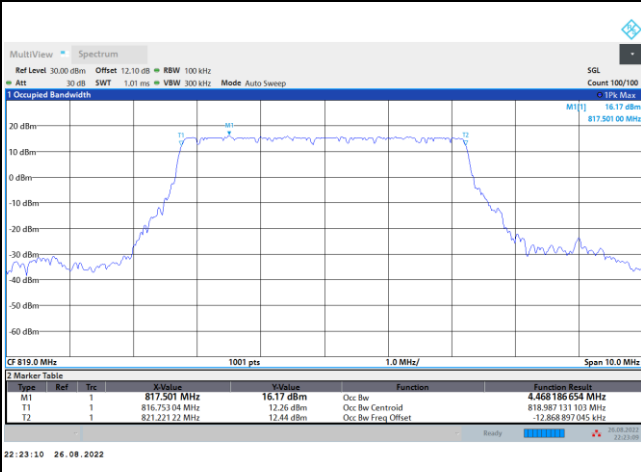

FR1 n26 / 5MHz / CP OFDM / Middle Channel / Full RB

QPSK

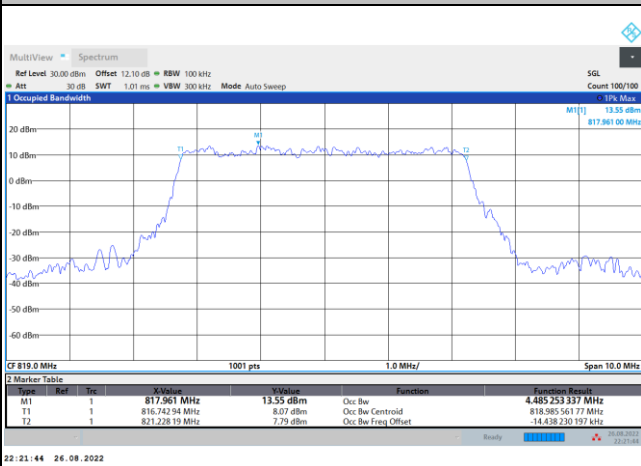

16QAM

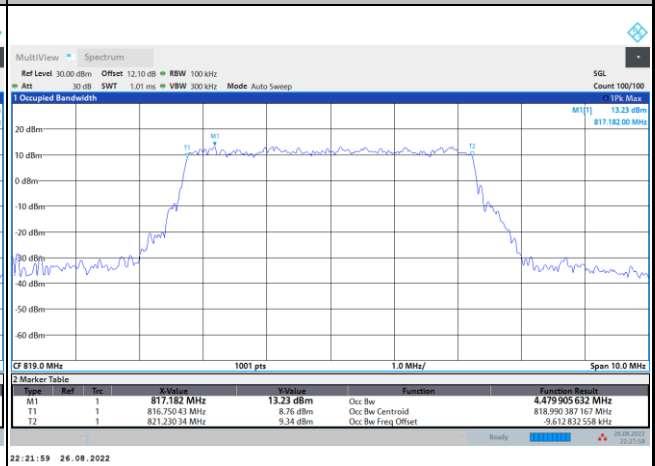

64QAM

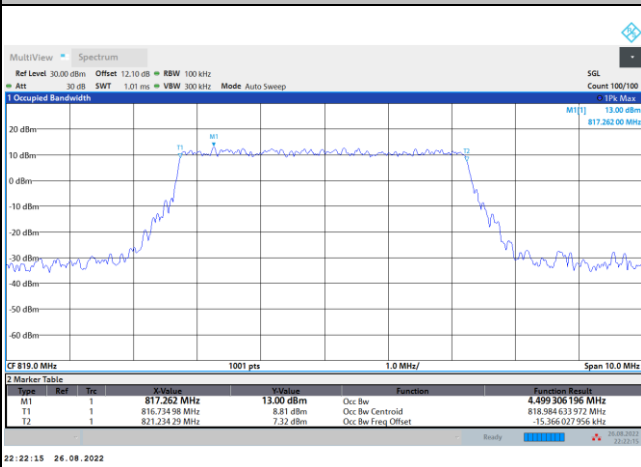

256QAM

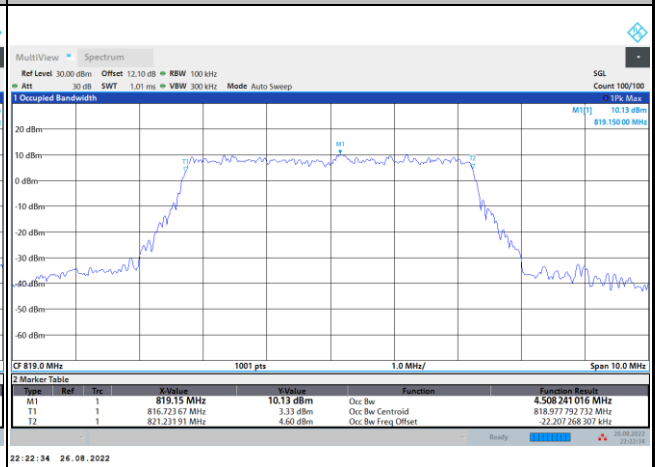



FR1 n26 / 10MHz / DFT-S OFDM / Middle Channel / Full RB

PI/2 BPSK

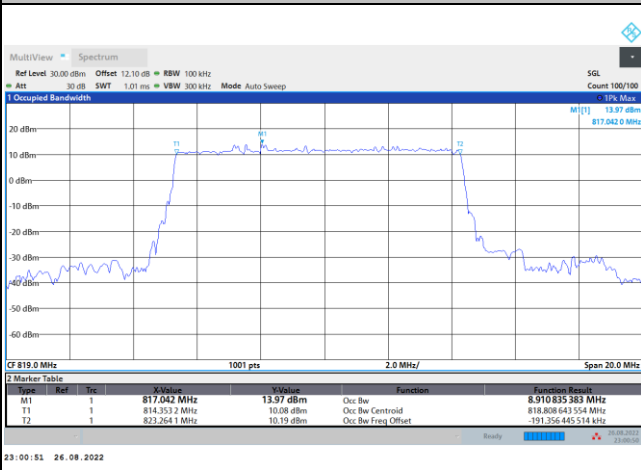

FR1 n26 / 10MHz / CP OFDM / Middle Channel / Full RB

QPSK

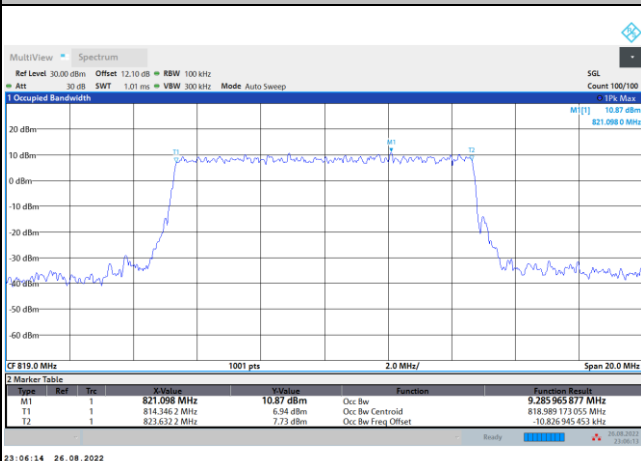

16QAM

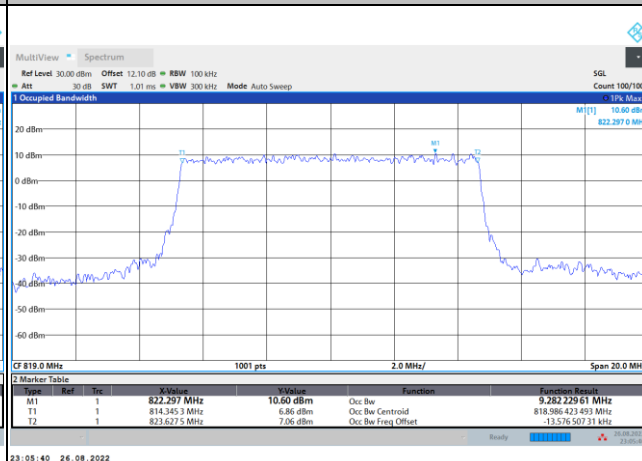

64QAM

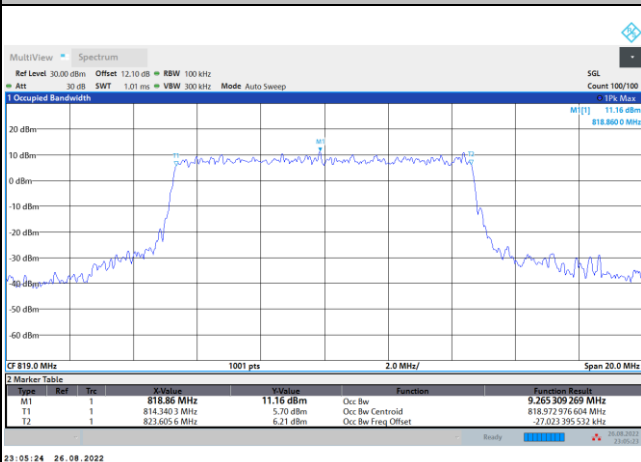

256QAM

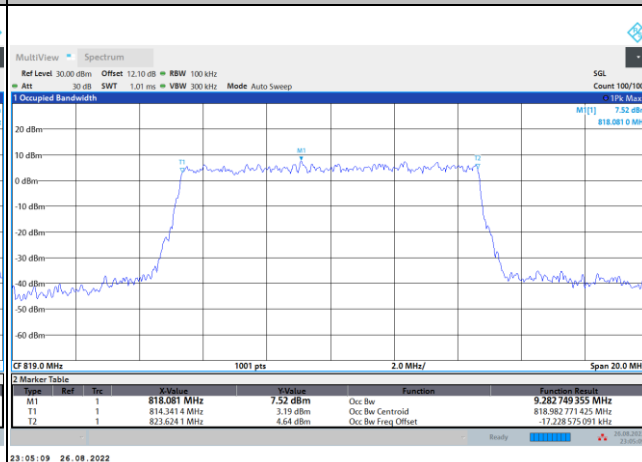



Emission masks – In-band emissions

FR1 n26 / 5MHz / DFT-S OFDM / PI/2 BPSK

Lowest MASK / 1RB0

Highest MASK / 1RBmax

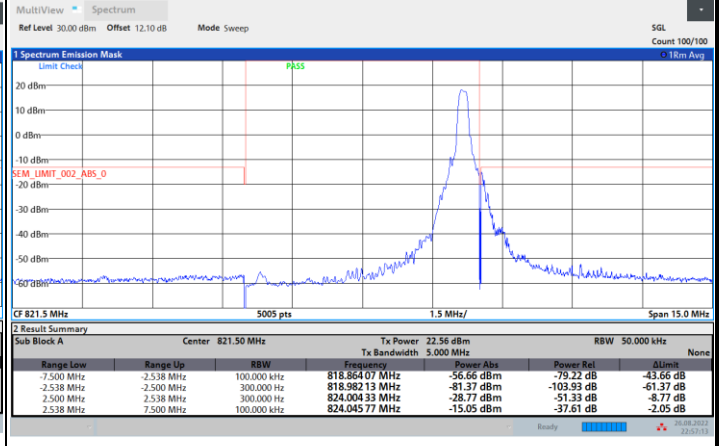
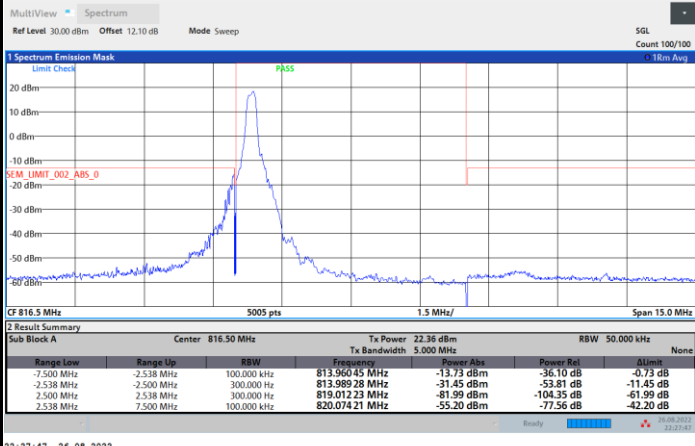

Lowest MASK / Full RB

Highest MASK / Full RB

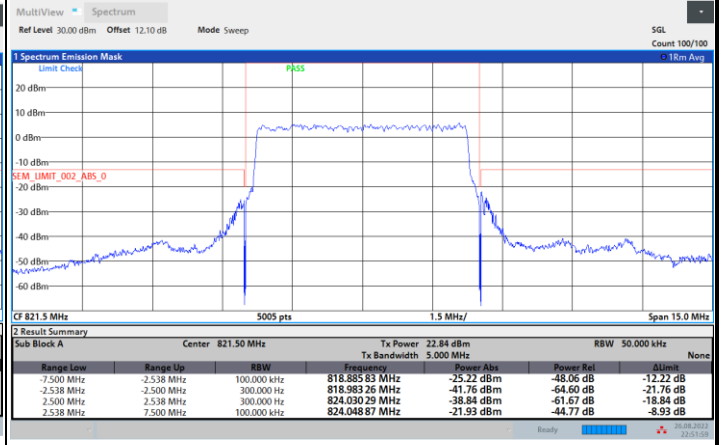
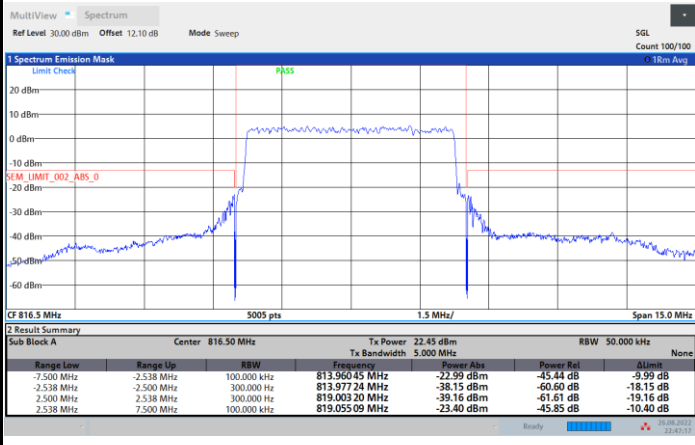



FR1 n26 / 5MHz / DFT-S OFDM / QPSK

Lowest MASK / 1RB0

Highest MASK / 1RBmax

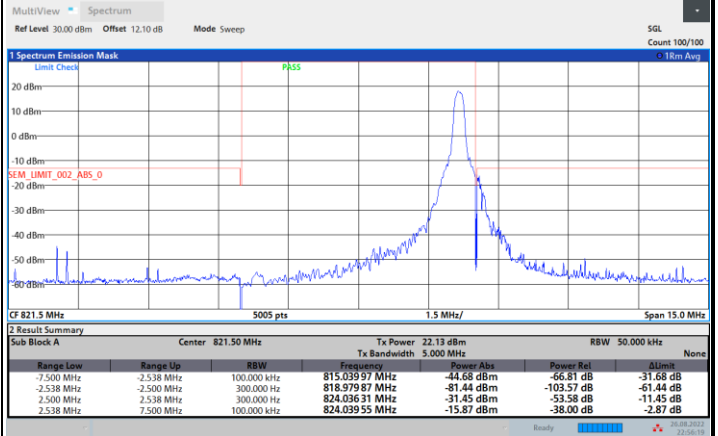
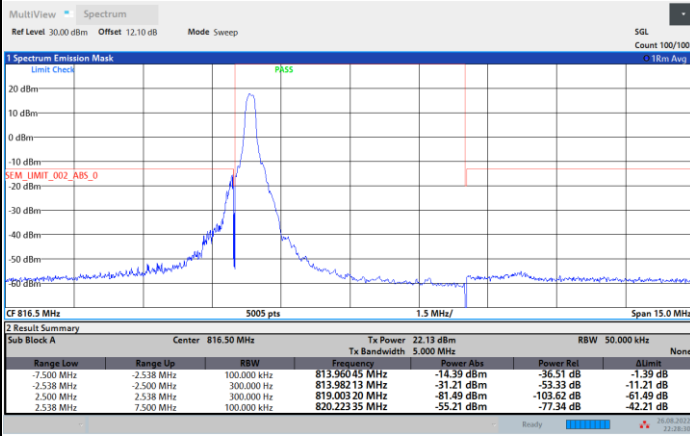

22:28:31 26.08.2022

22:56:19 26.08.2022

Lowest MASK / Full RB

Highest MASK / Full RB

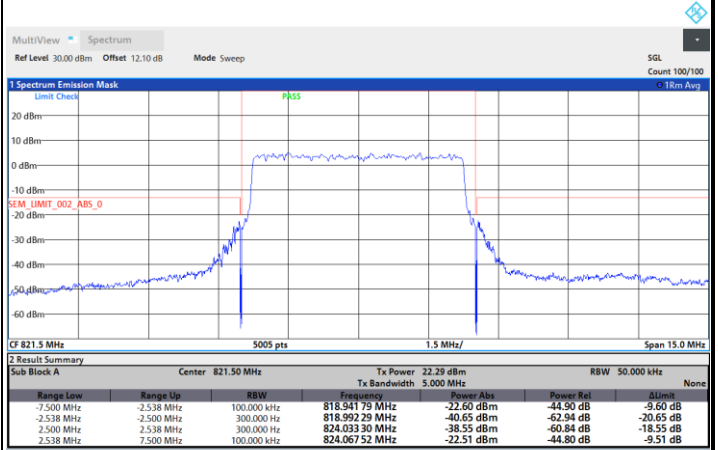
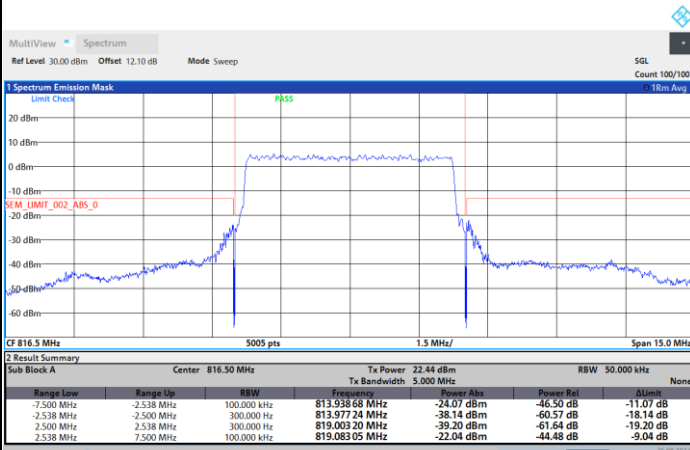

22:48:39 26.08.2022

22:52:32 26.08.2022



FR1 n26 / 5MHz / DFT-S OFDM / 16QAM

Lowest MASK / 1RB0

Highest MASK / 1RBmax

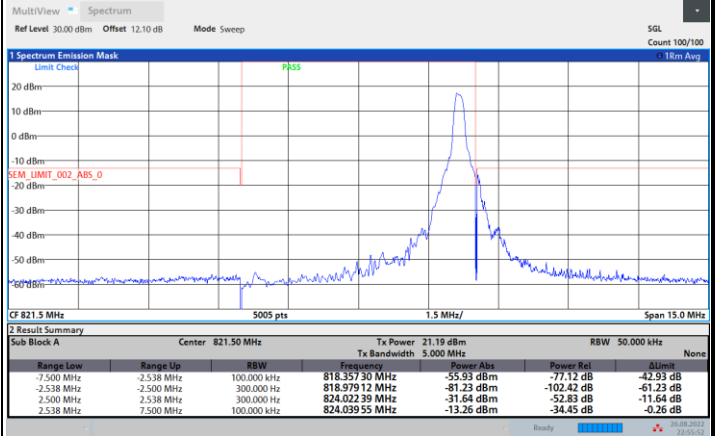
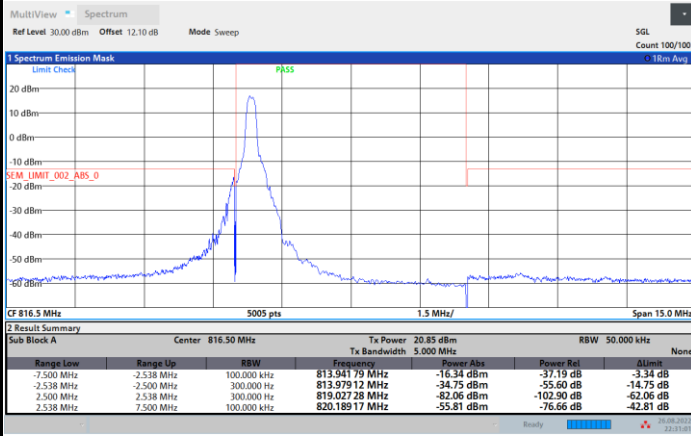

22:31:01 26.08.2022

22:55:53 26.08.2022

Lowest MASK / Full RB

Highest MASK / Full RB

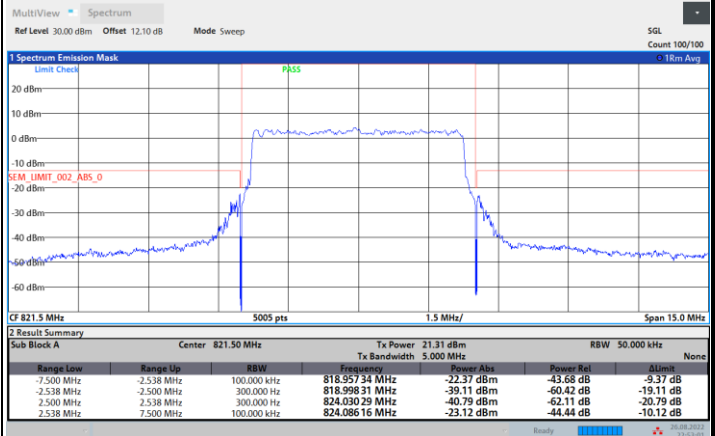
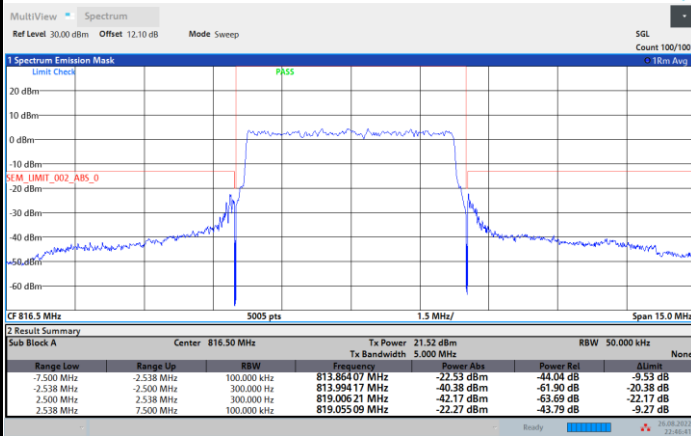

22:46:41 26.08.2022

22:53:01 26.08.2022



FR1 n26 / 5MHz / DFT-S OFDM / 64QAM

Lowest MASK / 1RB0

Highest MASK / 1RBmax

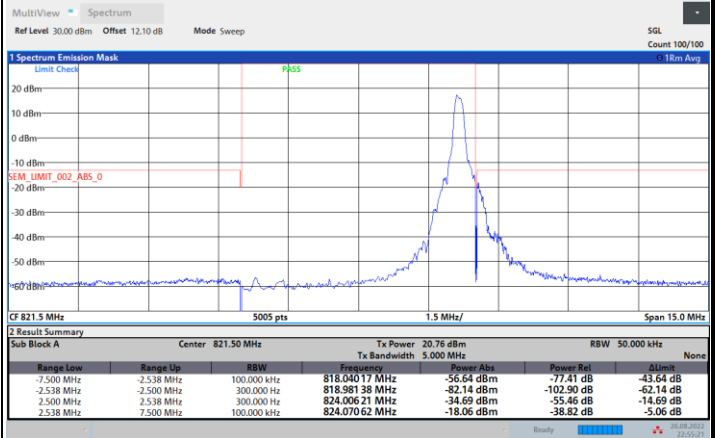
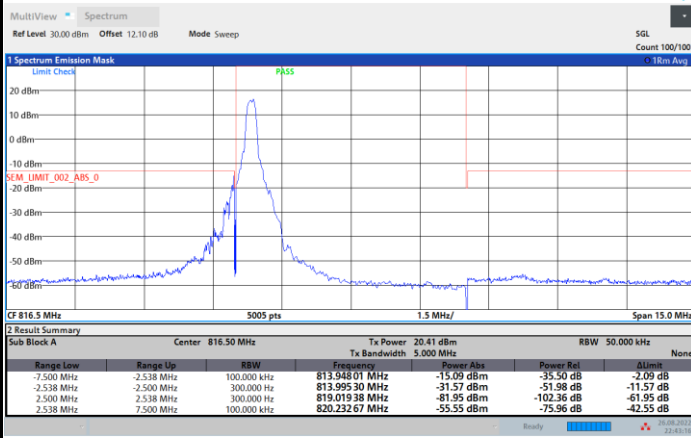

22:43:17 26.08.2022

22:55:21 26.08.2022

Lowest MASK / Full RB

Highest MASK / Full RB

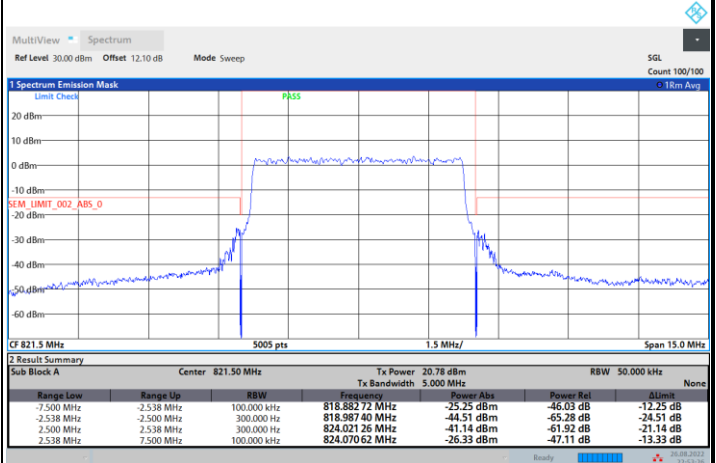
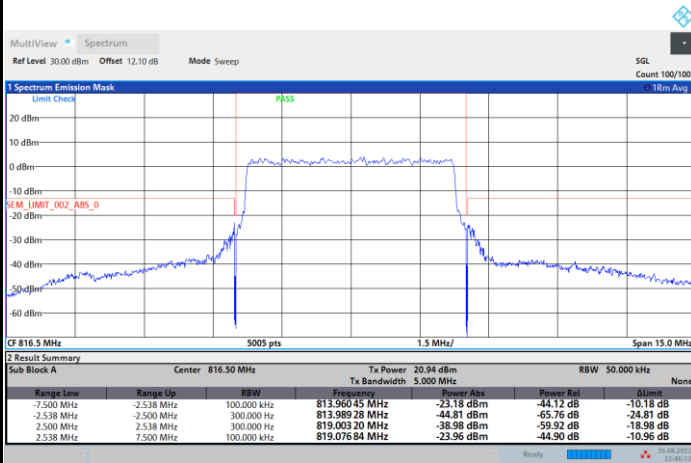

22:46:14 26.08.2022

22:53:26 26.08.2022



FR1 n26 / 5MHz / DFT-S OFDM / 256QAM

Lowest MASK / 1RB0

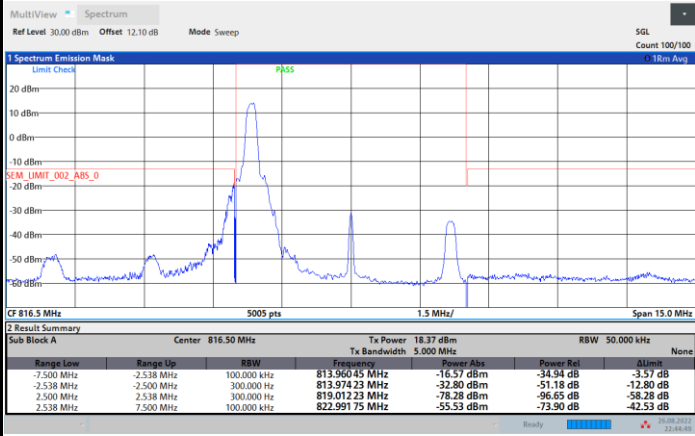

22:44:49 26.08.2022

Highest MASK / 1RBmax

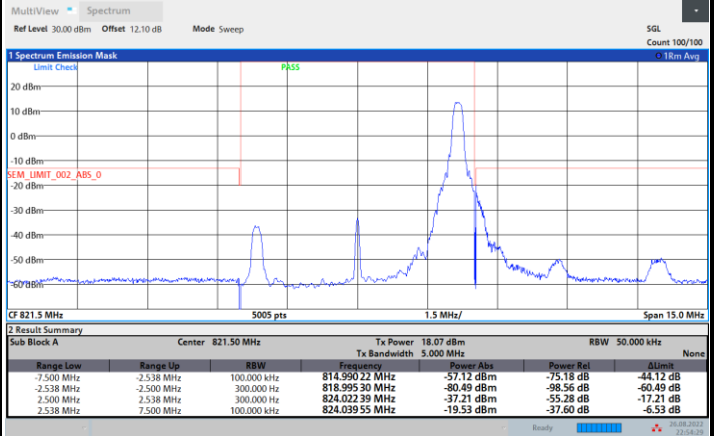

22:54:30 26.08.2022

Lowest MASK / Full RB

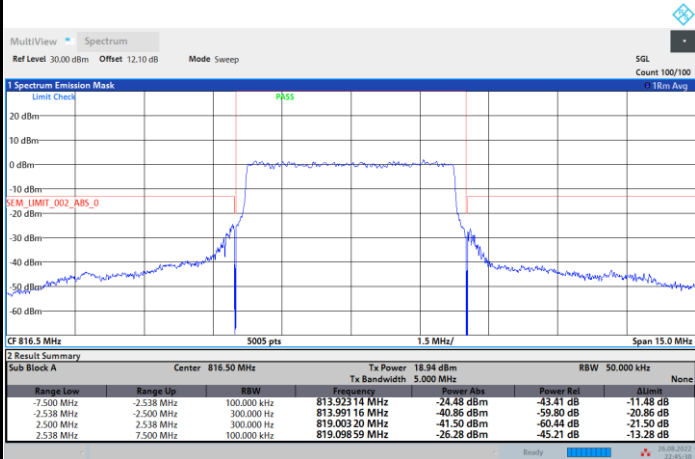

22:45:30 26.08.2022

Highest MASK / Full RB

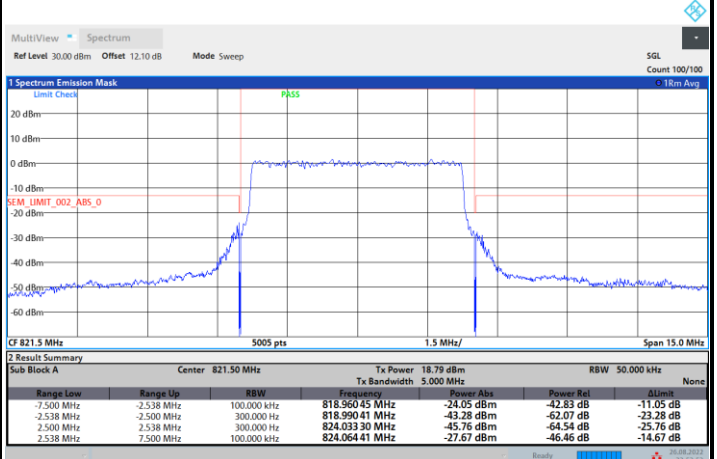

22:53:53 26.08.2022

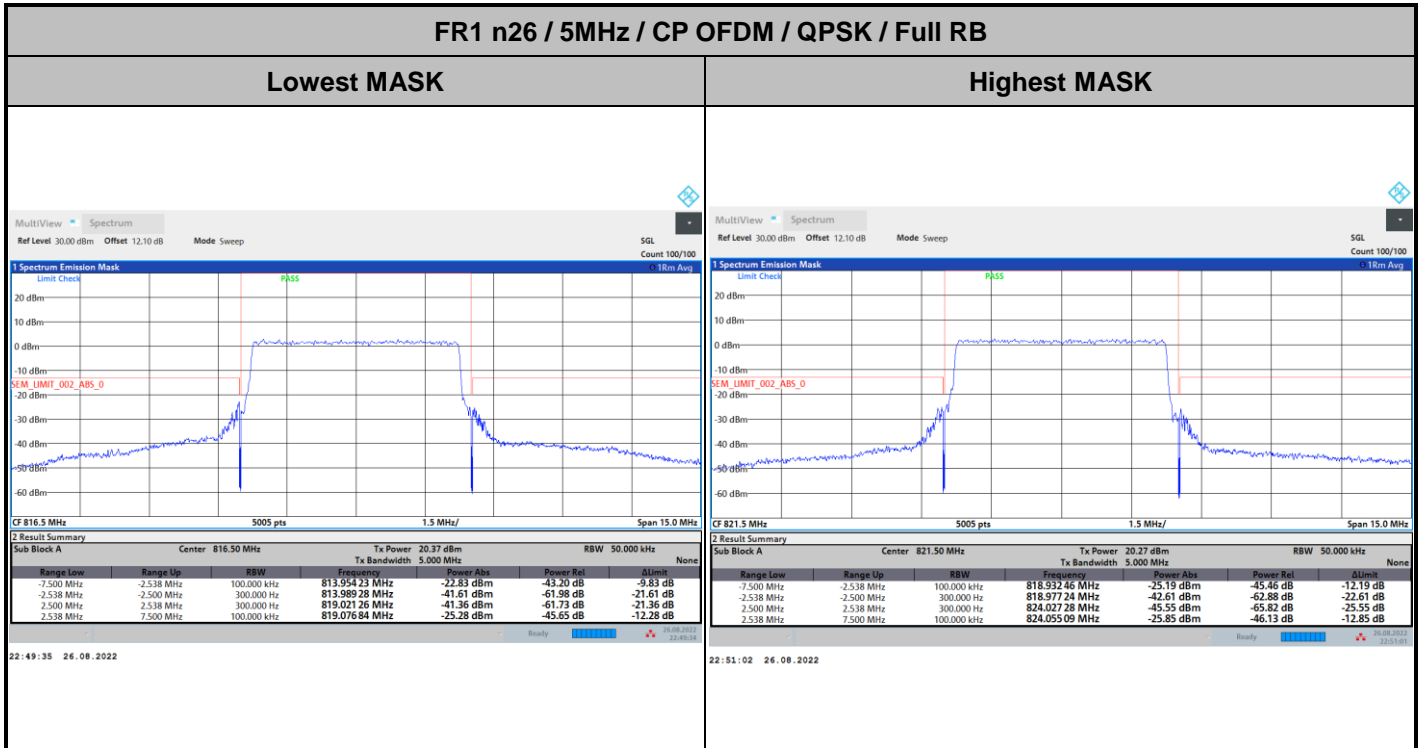



FR1 n26 / 10MHz / DFT-s-OFDM / PI/2 BPSK

Middle MASK / Full RB

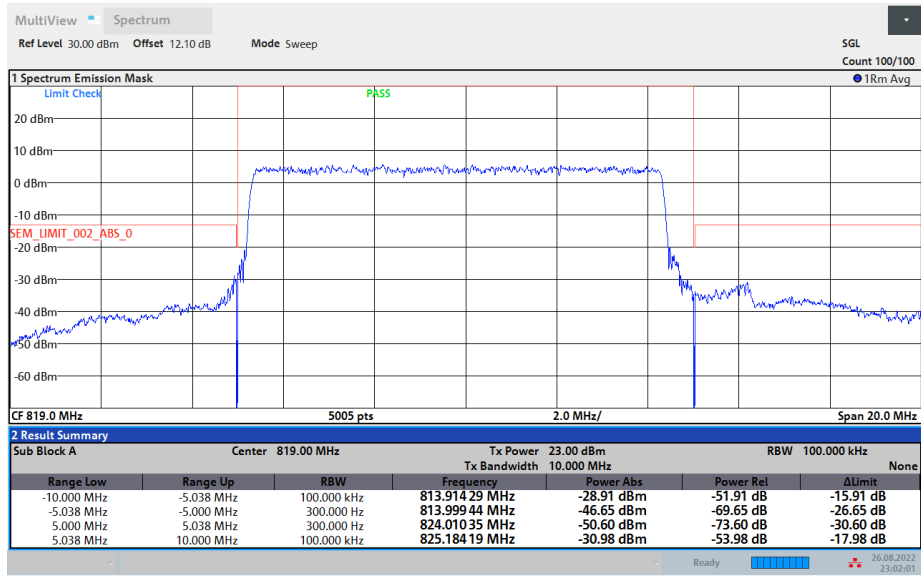

23:02:02 26.08.2022

FR1 n26 / 10MHz / DFT-s-OFDM / QPSK

Lowest MASK / Full RB

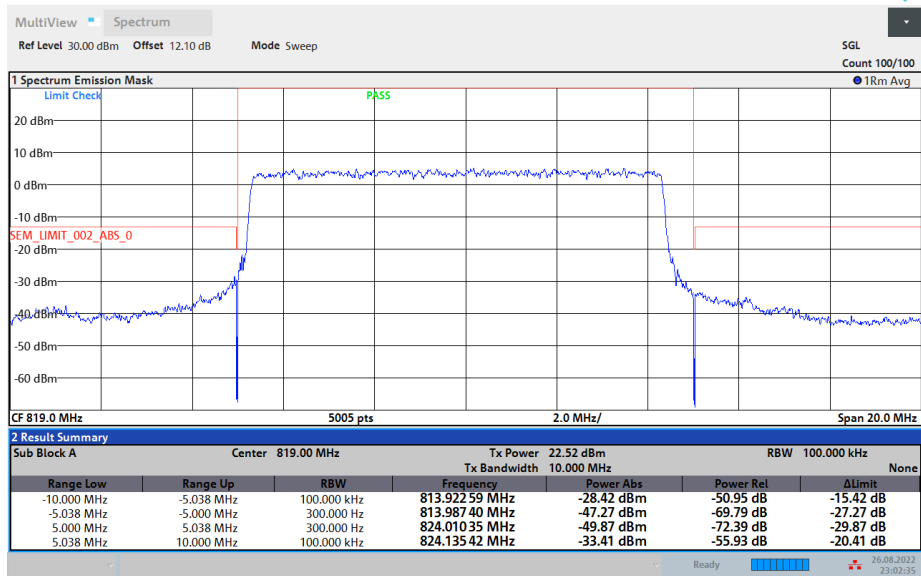

23:02:35 26.08.2022



FR1 n26 / 10MHz / DFT-s-OFDM / 16QAM

Middle MASK / Full RB

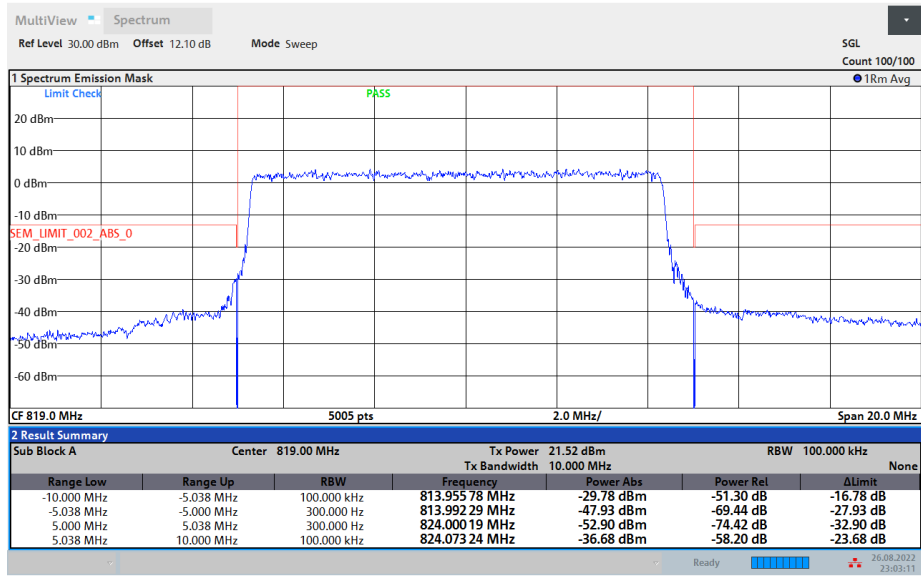

FR1 n26 / 10MHz / DFT-s-OFDM / 64QAM

Middle MASK / Full RB

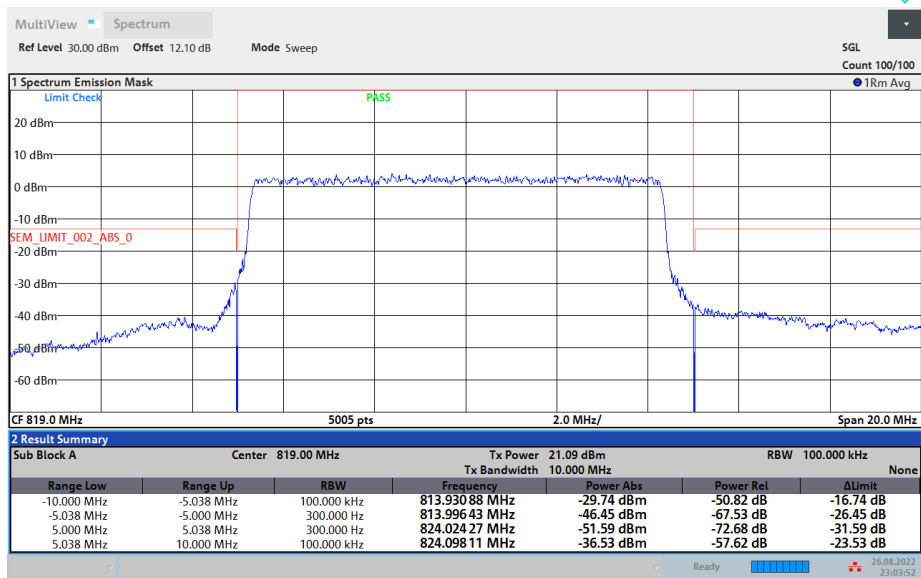



FR1 n26 / 10MHz / DFT-s-OFDM / 256QAM

Middle MASK / Full RB

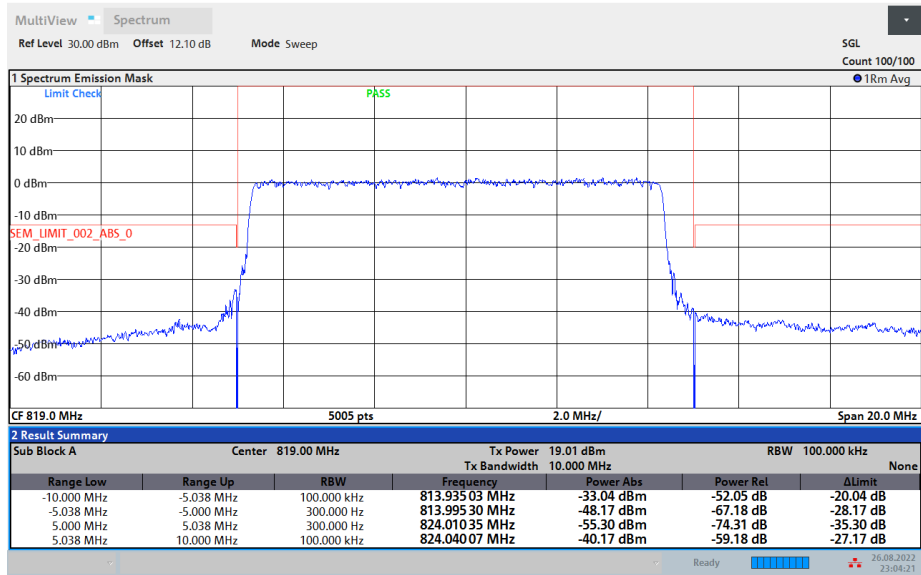

23:04:22 26.08.2022

FR1 n26 / 10MHz / CP OFDM / QPSK / Full RB

Middle MASK

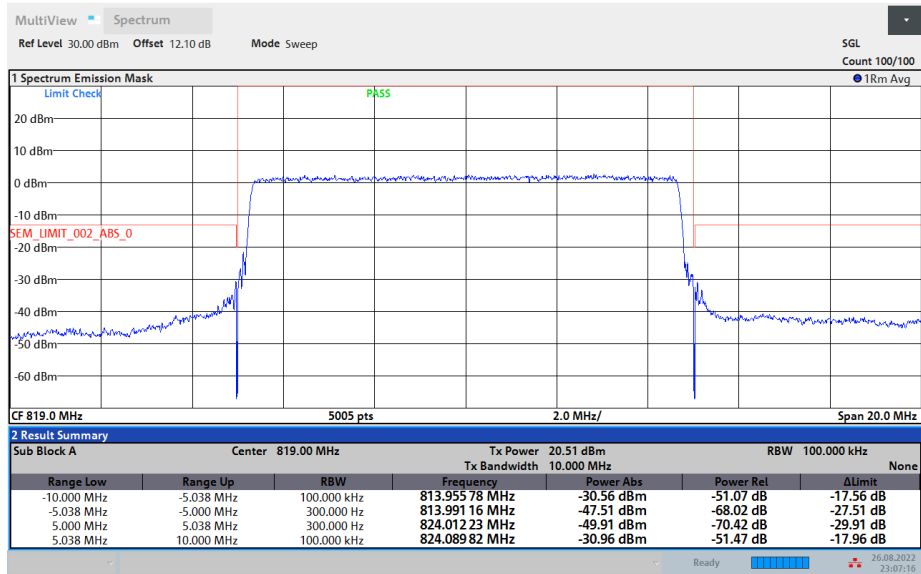

23:07:16 26.08.2022



Emission masks – Out of band emissions

FR1 n26 / 5MHz / DFT-S OFDM / QPSK / 1RB1

Lowest Channel

Middle Channel

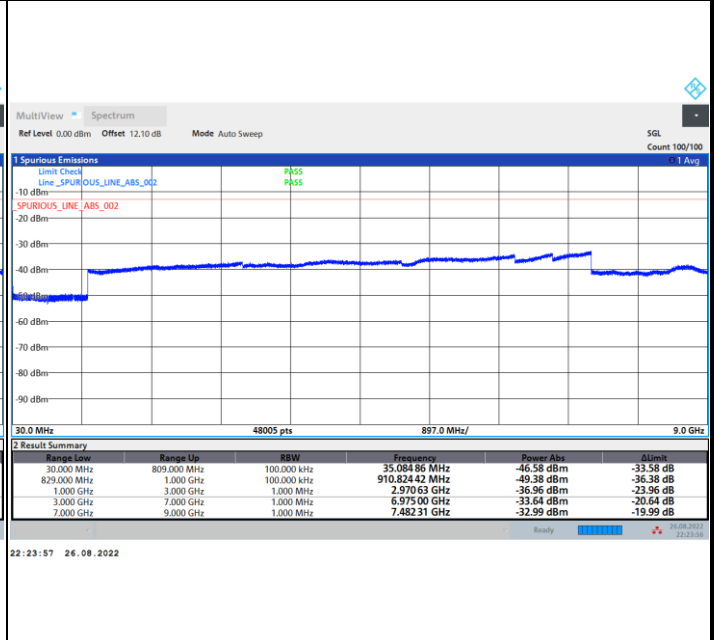
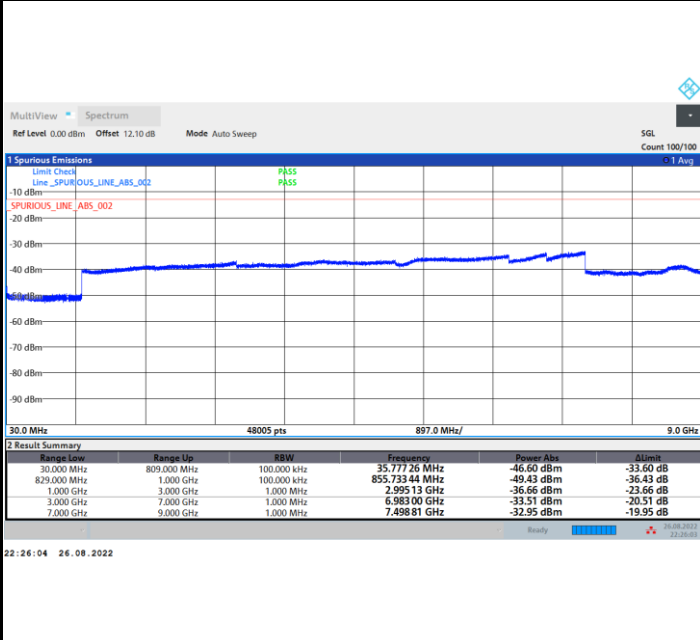

Highest Channel

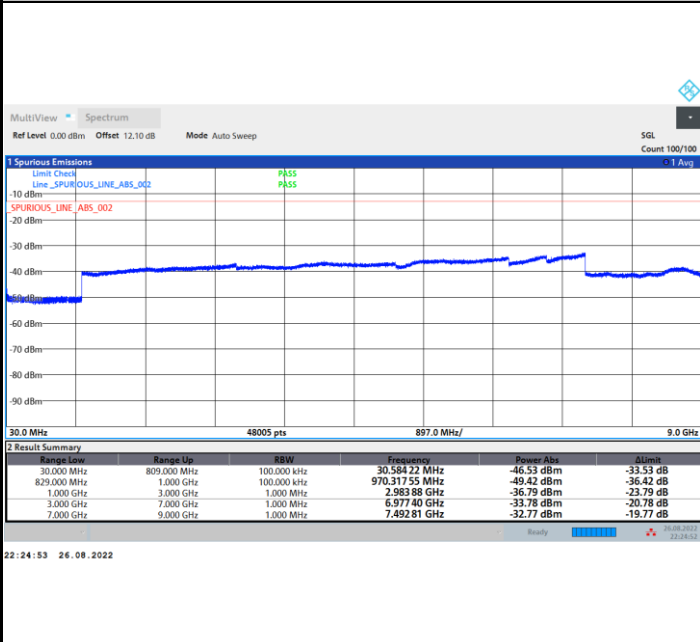



Frequency Stability

Test Conditions		FR1 n26 (BPSK) / Middle Channel	Limit
Temperature (°C)	Voltage (Volt)	BW 10MHz	Note 2.
		Deviation (ppm)	Result
50	Normal Voltage	0.0057	PASS
40	Normal Voltage	0.0109	
30	Normal Voltage	0.0055	
20(Ref.)	Normal Voltage	0.0000	
10	Normal Voltage	0.0065	
0	Normal Voltage	0.0071	
-10	Normal Voltage	0.0122	
-20	Normal Voltage	0.0023	
-30	Normal Voltage	0.0082	
20	Maximum Voltage	0.0020	
20	Normal Voltage	0.0000	
20	Battery End Point	0.0121	

Note:

- 1. Normal Voltage = 3.85 V. ; Battery End Point (BEP) = 3.3 V. ; Maximum Voltage = 4.25 V.
- 2. The frequency fundamental emissions stay within the authorized frequency block.



FR1 n26_Straddle Channel

Peak-to-Average Ratio

Mode	FR1 n26 / 20MHz / DFT-S OFDM				
Mod.	PI/2 BPSK	QPSK	16QAM	64QAM	Limit: 13dB
RB Size	Full RB	Full RB	Full RB	Full RB	Result
Middle CH	4.38	5.68	6.44	6.58	PASS
Mode	FR1 n26 / 20MHz / DFT-S OFDM				
Mod.	256QAM				Limit: 13dB
RB Size	Full RB				Result
Middle CH	8.44				PASS



FR1 n26 / 20MHz / DFT-S OFDM / Middle Channel / Full RB

PI/2 BPSK

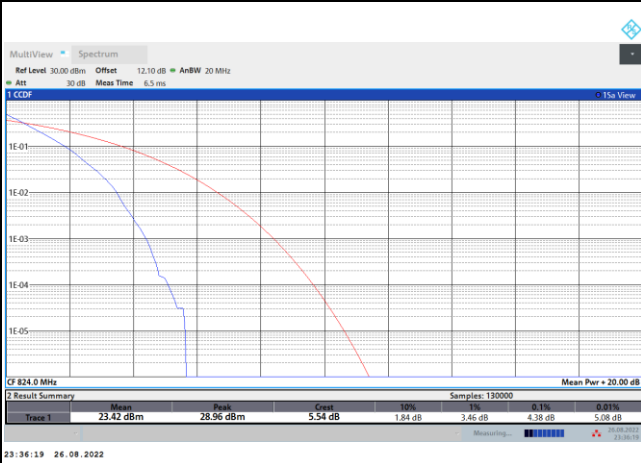

QPSK

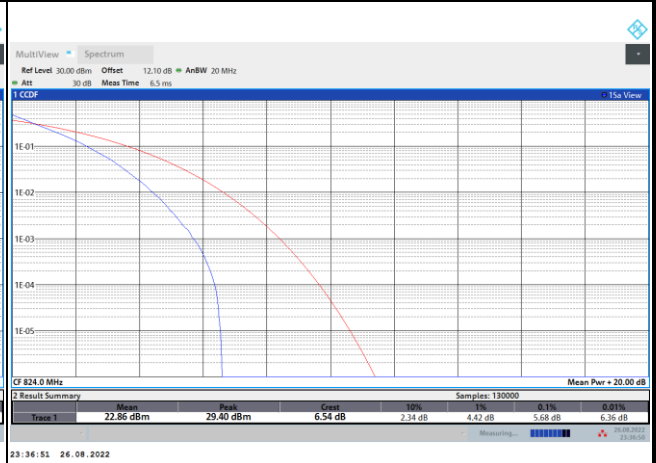

16QAM

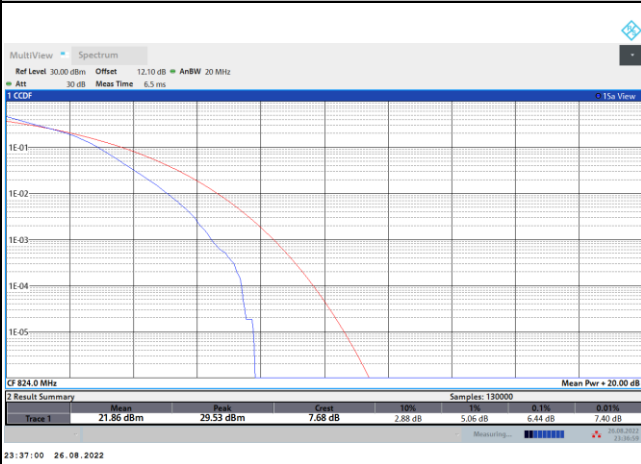

64QAM

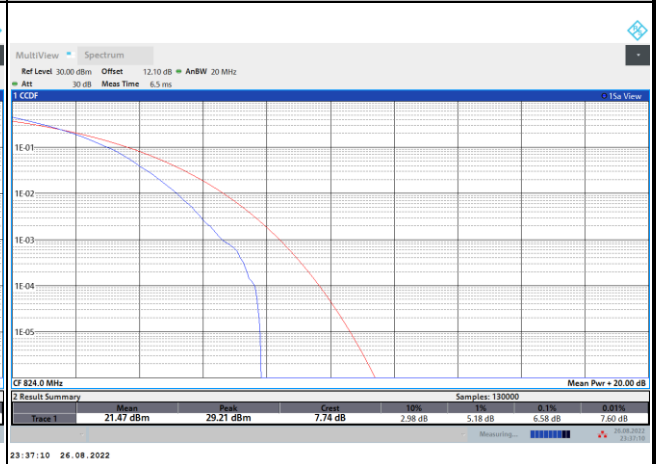

256QAM

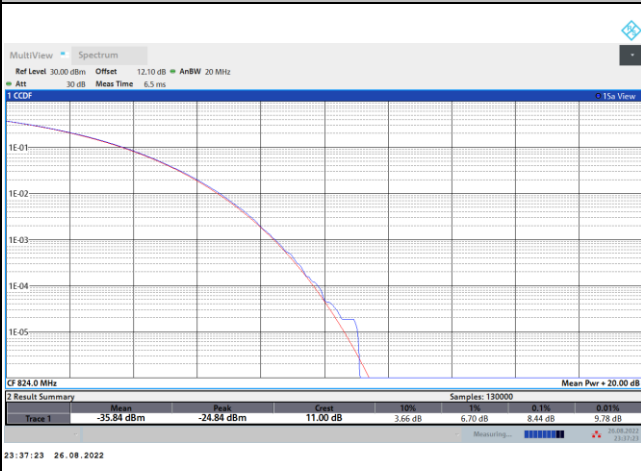



26dB Bandwidth

Mode	FR1 n26 : 26dB BW(MHz) / DFT-S OFDM							
BW	5MHz		10MHz		15MHz		20MHz	
Mod.	PI/2 BPSK		PI/2 BPSK		PI/2 BPSK		PI/2 BPSK	
Middle CH	4.91		9.43		14.27		18.90	

Mode	FR1 n26 : 26dB BW(MHz) / CP OFDM							
BW	5MHz		10MHz		15MHz		20MHz	
Mod.	QPSK	16QAM	QPSK	16QAM	QPSK	16QAM	QPSK	16QAM
Middle CH	5.00	5.12	9.95	9.93	15.20	14.99	19.94	19.90
Mod.	64QAM	256QAM	64QAM	256QAM	64QAM	256QAM	64QAM	256QAM
Middle CH	5.09	5.06	9.97	10.03	14.90	15.08	19.82	19.90



FR1 n26 / 5MHz / DFT-S OFDM / Middle Channel / Full RB

PI/2 BPSK

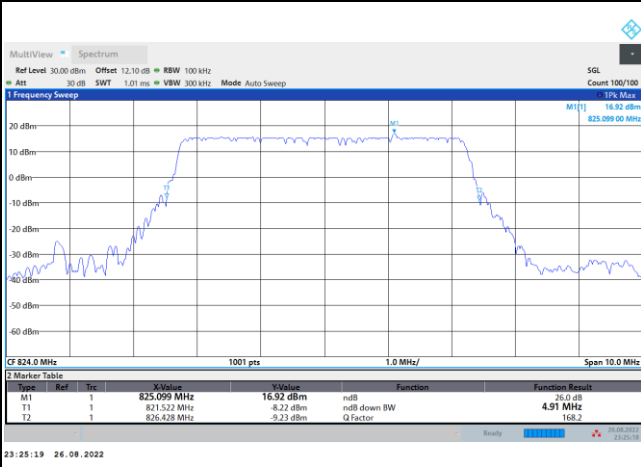

FR1 n26 / 5MHz / CP OFDM / Middle Channel / Full RB

QPSK

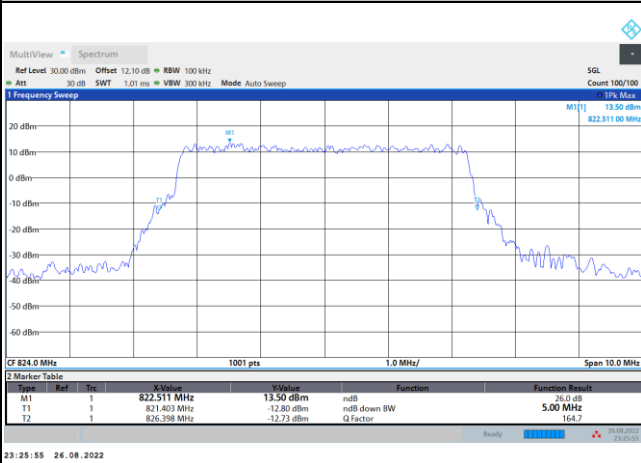

16QAM

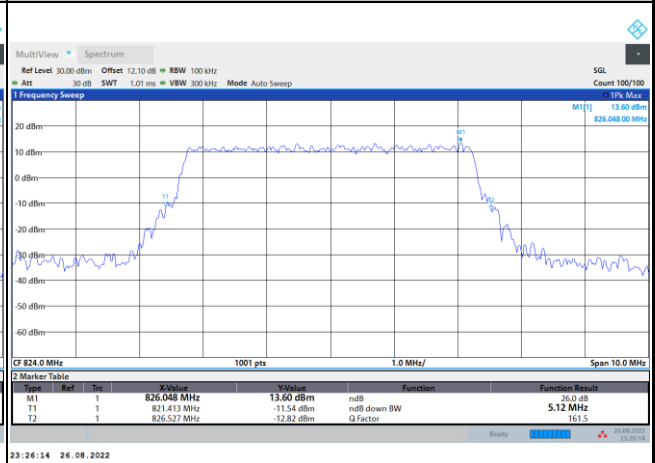

64QAM

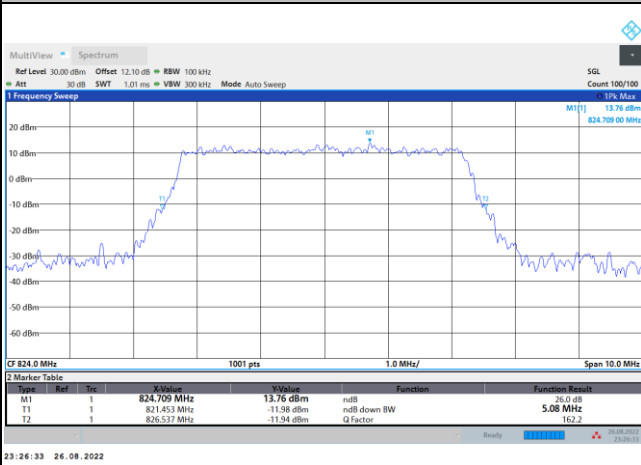

256QAM

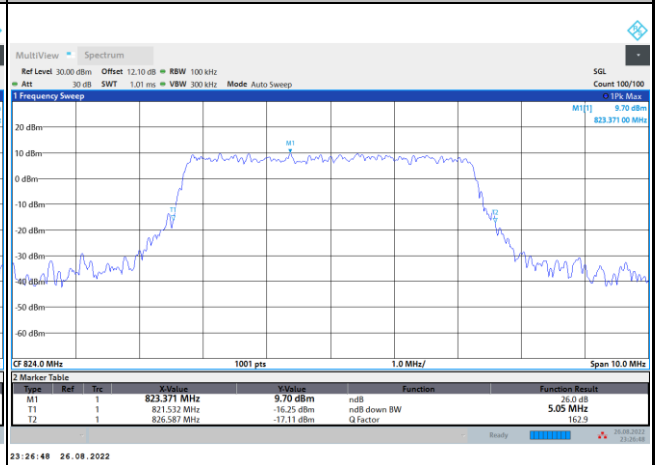



FR1 n26 / 10MHz / DFT-S OFDM / Middle Channel / Full RB

PI/2 BPSK

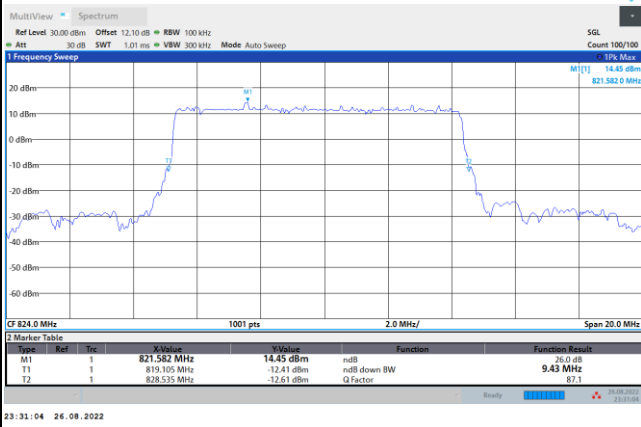

FR1 n26 / 10MHz / CP OFDM / Middle Channel / Full RB

QPSK

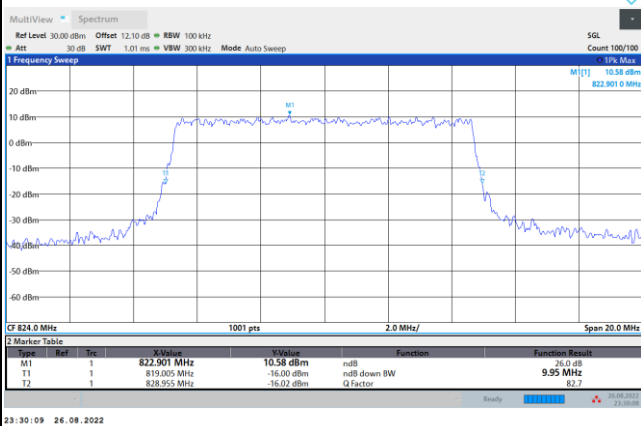

16QAM

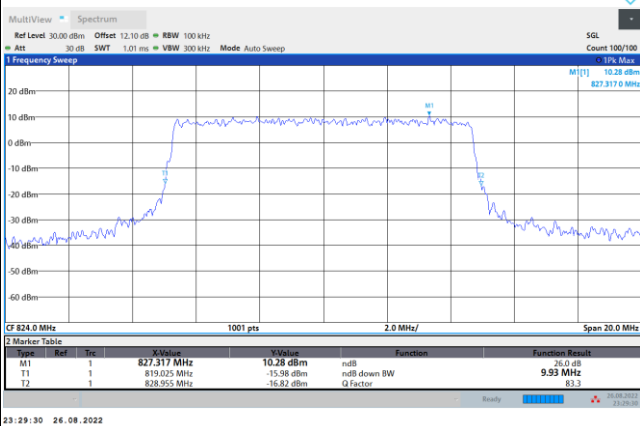

64QAM

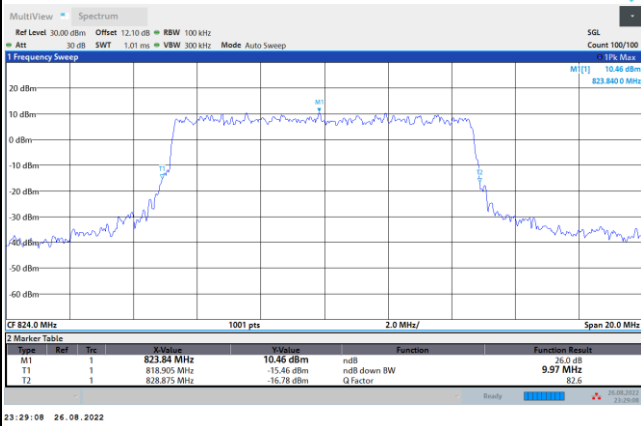

256QAM

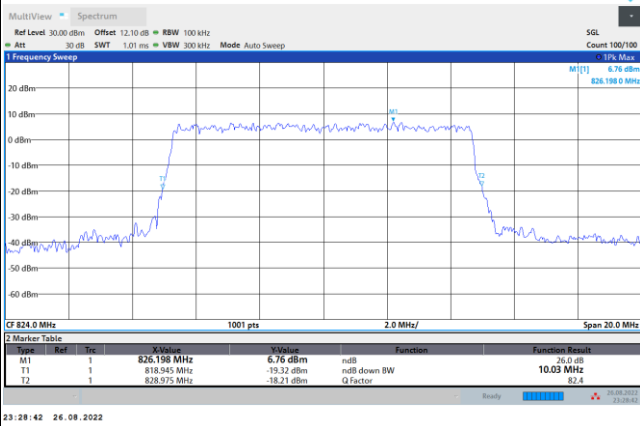



FR1 n26 / 15MHz / DFT-S OFDM / Middle Channel / Full RB

PI/2 BPSK

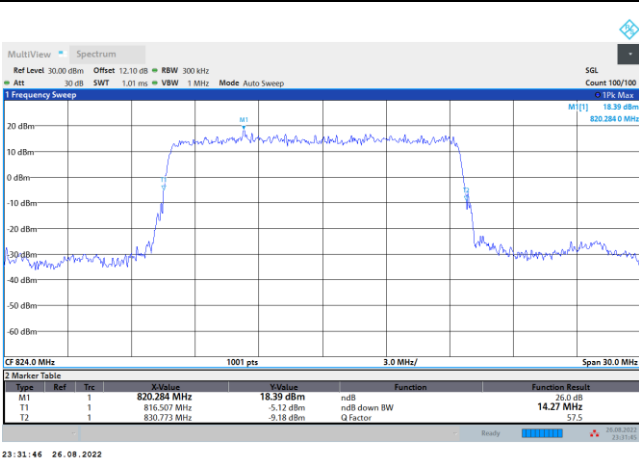

FR1 n26 / 15MHz / CP OFDM / Middle Channel / Full RB

QPSK

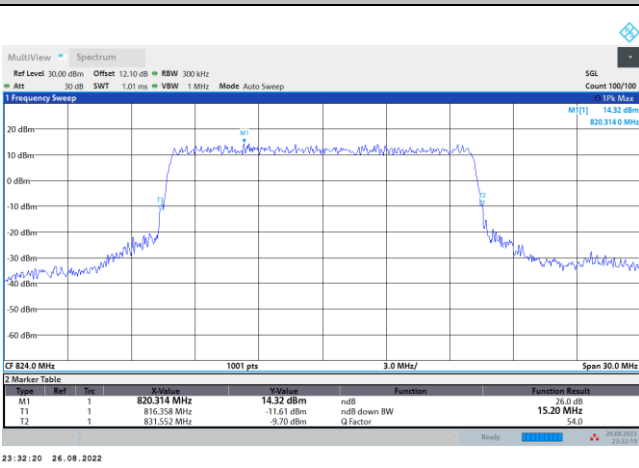

16QAM

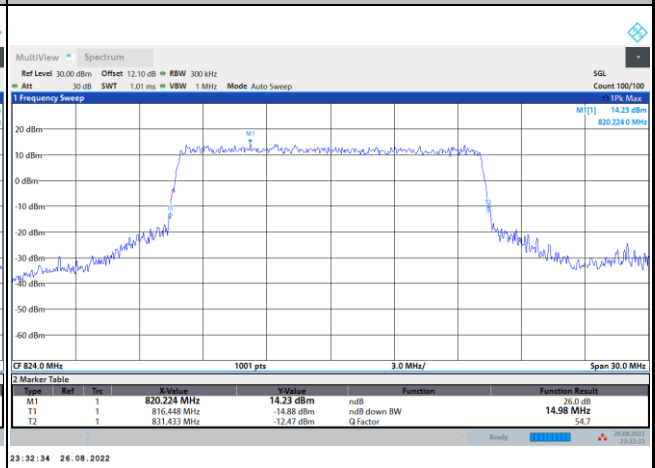

64QAM

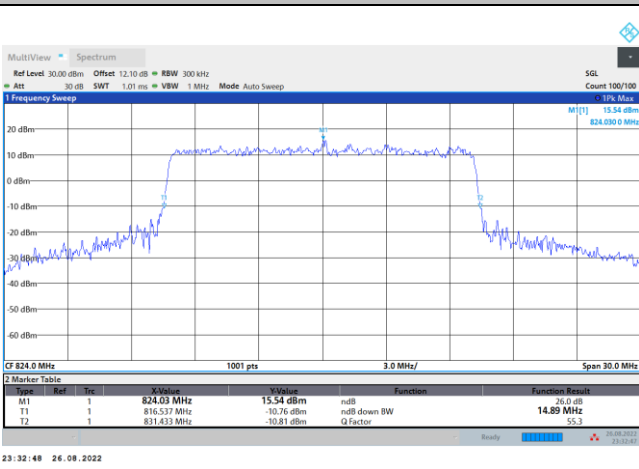

256QAM

