



FCC RADIO TEST REPORT

FCC ID : PKRISGMD2000
Equipment : Wireless Module
Brand Name : Inseego
Model Name : MD2000
Applicant : Inseego Corporation
9710 Scranton Road Suite 200, San Diego, CA 92121
Manufacturer : Inseego Corporation
9710 Scranton Road Suite 200, San Diego, CA 92121
Standard : FCC 47 CFR Part 2, 96

The product was received on Sep. 11, 2020 and testing was started from Sep. 24, 2020 and completed on Nov. 01, 2020. We, SPORTON INTERNATIONAL INC. EMC & Wireless Communications Laboratory, would like to declare that the tested sample has been evaluated in accordance with the test procedures given in ANSI / TIA-603-E and has been in compliance with the applicable technical standards.

The test results in this variant report apply exclusively to the tested model / sample. Without written approval of SPORTON INTERNATIONAL INC. EMC & Wireless Communications Laboratory, the test report shall not be reproduced except in full.

Louis Wu

Approved by: Louis Wu

SPORTON INTERNATIONAL INC. EMC & Wireless Communications Laboratory
No. 52, Huaya 1st Rd., Guishan Dist., Taoyuan City, Taiwan (R.O.C.)



Table of Contents

History of this test report.....	3
Summary of Test Result.....	4
1 General Description	5
1.1 Product Feature of Equipment Under Test	5
1.2 Modification of EUT	5
1.3 Testing Location	5
1.4 Applied Standards	6
2 Test Configuration of Equipment Under Test	7
2.1 Test Mode.....	7
2.2 Connection Diagram of Test System	8
2.3 Support Unit used in test configuration	8
2.4 Measurement Results Explanation Example	8
2.5 Frequency List of Low/Middle/High Channels.....	9
3 Conducted Test Items.....	10
3.1 Measuring Instruments.....	10
3.2 Test Setup	10
3.3 Conducted Output Power	11
3.4 EIRP	12
3.5 Occupied Bandwidth	13
3.6 Conducted Band Edge	14
3.7 Conducted Spurious Emission	15
3.8 Frequency Stability.....	16
4 Radiated Test Items	17
4.1 Measuring Instruments.....	17
4.2 Test Setup	17
4.3 Test Result of Radiated Test.....	18
4.4 Radiated Spurious Emission	19
5 List of Measuring Equipment.....	20
6 Uncertainty of Evaluation.....	21
Appendix A. Test Results of Conducted Test	
Appendix B. Test Results of EIRP and Radiated Test	
Appendix C. Test Setup Photographs	



History of this test report

Report No.	Version	Description	Issued Date
FG090125-01C	01	Initial issue of report	Nov. 03, 2020



Summary of Test Result

Report Clause	Ref Std. Clause	Test Items	Result (PASS/FAIL)	Remark
3.3	§2.1046	Conducted Output Power	Reporting only	-
3.4	§96.41	Effective Isotropic Radiated Power	Pass	-
3.5	§2.1049 §96.41	Occupied Bandwidth	Reporting only	-
3.6	§2.1051 §96.41	Conducted Band Edge Measurement	Pass	-
3.7	§2.1051 §96.41	Conducted Spurious Emission	Pass	
3.8	§2.1055	Frequency Stability for Temperature & Voltage	Pass	-
4.4	§2.1051 §96.41	Radiated Spurious Emission	Pass	Under limit 5.06 dB at 22074.000 MHz

Remark: This is a variant report by enable LTE CA Band via SW. All the test cases were performed on original report which can be referred to Sporton Report Number FG090125G.

Declaration of Conformity:

The test results with all measurement uncertainty excluded are presented in accordance with the regulation limits or requirements declared by manufacturers.

Comments and Explanations:

The declared of product specification for EUT presented in the report are provided by the manufacturer, and the manufacturer takes all the responsibilities for the accuracy of product specification.

Reviewed by: Wii Chang

Report Producer: Dara Chiu



1 General Description

1.1 Product Feature of Equipment Under Test

WCDMA/LTE/5G NR, Wi-Fi 2.4GHz 802.11b/g/n/ac/ax, Wi-Fi 5GHz 802.11a/n/ac/ax, and GNSS.

Product Specification subjective to this standard	
Antenna Type	WWAN: Monopole Antenna WLAN <Ant. 0>: Monopole Antenna <Ant. 1>: Monopole Antenna GPS / Glonass / BDS / Galileo: Monopole Antenna

1.2 Modification of EUT

No modifications are made to the EUT during all test items.

1.3 Testing Location

Test Site	SPORTON INTERNATIONAL INC. EMC & Wireless Communications Laboratory
Test Site Location	No.52, Huaya 1st Rd., Guishan Dist., Taoyuan City, Taiwan (R.O.C.) TEL: +886-3-327-3456 FAX: +886-3-328-4978
Test Site No.	Sporton Site No. TH05-HY
Test Engineer	Benjamin Lin and Sherry Wu
Temperature	22.3 ~ 24.5°C
Relative Humidity	48.9 ~ 50.2%

Test Site	SPORTON INTERNATIONAL INC. EMC & Wireless Communications Laboratory
Test Site Location	No.58, Aly. 75, Ln. 564, Wenhua 3rd, Rd., Guishan Dist., Taoyuan City, Taiwan (R.O.C.) TEL: +886-3-327-0868 FAX: +886-3-327-0855
Test Site No.	Sporton Site No. 03CH12-HY
Test Engineer	Jack Cheng, Lance Chiang and Chuan Chu
Temperature	24.3 ~ 26.4°C
Relative Humidity	58 ~ 66%

Note: The test site complies with ANSI C63.4 2014 requirement.

FCC Designation No.: TW1190 and TW0007



1.4 Applied Standards

According to the specifications of the manufacturer, the EUT must comply with the requirements of the following standards:

- ♦ ANSI C63.26-2015
- ♦ ANSI / TIA-603-E
- ♦ FCC 47 CFR Part 2, 96
- ♦ FCC KDB 971168 D01 Power Meas. License Digital Systems v03r01
- ♦ FCC KDB 940660 D01 Part 96 CBRS Eqpt v02
- ♦ FCC KDB 412172 D01 Determining ERP and EIRP v01r01
- ♦ FCC KDB 414788 D01 Radiated Test Site v01r01

Remark:

1. All test items were verified and recorded according to the standards and without any deviation during the test.
2. This EUT has also been tested and complied with the requirements of FCC Part 15, Subpart B, recorded in a separate test report.
3. The TAF code is not including all the FCC KDB listed without accreditation.



2 Test Configuration of Equipment Under Test

2.1 Test Mode

Antenna port conducted and radiated test items listed below are performed according to KDB 971168 D01 Power Meas. License Digital Systems v03r01 with maximum output power.

For radiated measurement, pre-scanned in two angles antenna (Ant. Horizontal and Ant. Vertical), the worst cases (Ant. Horizontal) were recorded in this report.

Test Items	Band	Bandwidth (MHz)										Modulation			RB #			Test Channel		
		20+20	20+15	15+20	20+10	10+20	20+5	5+20	15+15	15+10	10+15	QPSK	16QAM	64QAM	1	Half	Full	L	M	H
Max. Output Power	48_CA	v	v	v	v	v	v	v	-	-	-	v	v	v	v	v	v	v	v	v
26dB and 99% Bandwidth	48_CA	v	v	v	v	v	v	v	-	-	-	v	v	v			v	v	v	v
Conducted Band Edge	48_CA	v	v	v	v	v	v	v	-	-	-	v	v	v	v		v	v		v
Conducted Spurious Emission	48_CA	v	v	v	v	v	v	v	-	-	-	v	v	v	v			v	v	v
E.I.R.P.	48_CA	v	v	v	v	v	v	v	-	-	-	v	v	v	v			v	v	v
Radiated Spurious Emission	48_CA	Worst Case															v	v	v	
Remark	1. The mark "v " means that this configuration is chosen for testing 2. The mark "- " means that this bandwidth is not supported. 3. The device is investigated from 30MHz to 10 times of fundamental signal for radiated spurious emission test under different RB size/offset and modulations in exploratory test. Subsequently, only the worst case emissions are reported.																			

2.2 Connection Diagram of Test System

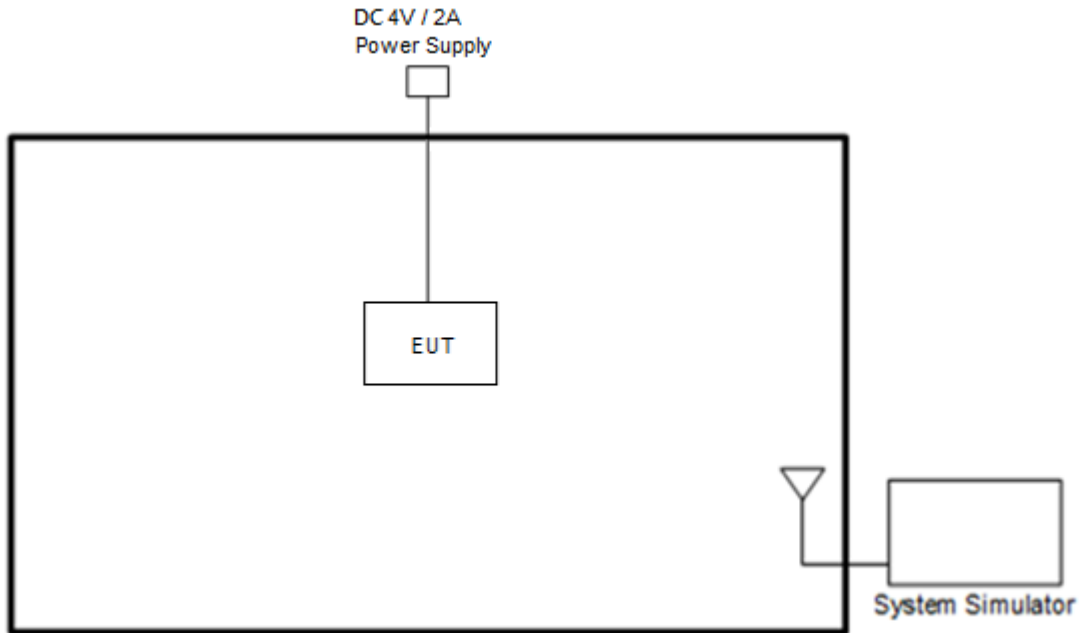

2.3 Support Unit used in test configuration

Item	Equipment	Brand Name	Model No.	FCC ID	Data Cable	Power Cord
1.	System Simulator	Anritsu	MT8821C	N/A	N/A	Unshielded, 1.8 m
2.	Power Supply	GW Instek	GPE-2323	N/A	N/A	Unshielded, 1.8 m

2.4 Measurement Results Explanation Example

For all conducted test items:

The offset level is set in the spectrum analyzer to compensate the RF cable loss and attenuator factor between EUT conducted output port and spectrum analyzer. With the offset compensation, the spectrum analyzer reading level is exactly the EUT RF output level.

The spectrum analyzer offset is derived from RF cable loss and attenuator factor.

Offset = RF cable loss + attenuator factor.

Following shows an offset computation example with cable loss 4.2 dB and 10dB attenuator.

Example :

$$\begin{aligned} \text{Offset(dB)} &= \text{RF cable loss(dB)} + \text{attenuator factor(dB)} \\ &= 4.2 + 10 = 14.2 \text{ (dB)} \end{aligned}$$



2.5 Frequency List of Low/Middle/High Channels

LTE Band 48_CA Channel and Frequency List					
BW [MHz]	Channel/Frequency(MHz)		Lowest	Middle	Highest
20 + 20	PCC	Channel	3560	3615.1	3670.2
		Frequency	55340	55891	56442
	SCC	Channel	3579.8	3634.9	3690
		Frequency	55538	56089	56640
20 + 15	PCC	Channel	3560	3617.6	3675.1
		Frequency	55340	55916	56491
	SCC	Channel	3577.1	3634.7	3692.2
		Frequency	55511	56087	56662
15 + 20	PCC	Channel	3557.8	3615.3	3672.9
		Frequency	55318	55893	56469
	SCC	Channel	3574.9	3632.4	3690
		Frequency	55489	56064	56640
20 + 10	PCC	Channel	3560	3620.1	3680.1
		Frequency	55340	55941	56541
	SCC	Channel	3574.4	3634.5	3694.5
		Frequency	55484	56085	56685
10 + 20	PCC	Channel	3555.5	3615.6	3675.6
		Frequency	55295	55896	56496
	SCC	Channel	3569.9	3630	3690
		Frequency	55439	56040	56640
20 + 5	PCC	Channel	3560	3622.5	3685
		Frequency	55340	55965	56590
	SCC	Channel	3571.7	3634.2	3696.7
		Frequency	55457	56082	56707
5 + 20	PCC	Channel	3553.3	3615.8	3678.3
		Frequency	55273	55898	56523
	SCC	Channel	3565	3627.5	3690
		Frequency	55390	56015	56640

3 Conducted Test Items

3.1 Measuring Instruments

See list of measuring instruments of this test report.

3.2 Test Setup

3.2.1 Conducted Output Power

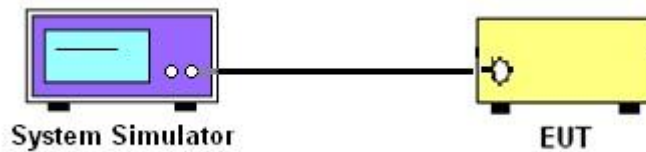

3.2.2 EIRP, Occupied Bandwidth, Conducted Band-Edge and Conducted Spurious Emission

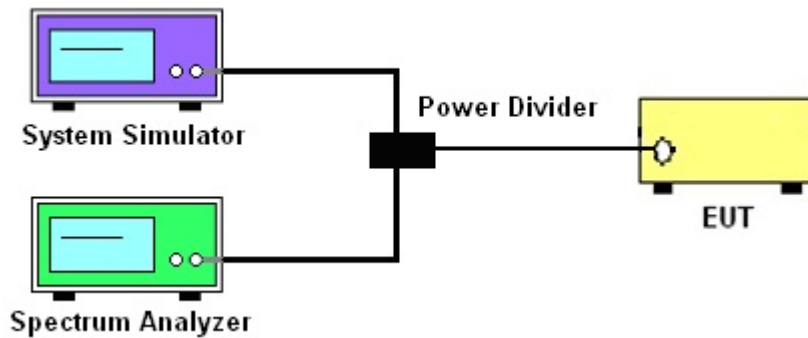

3.2.3 Test Result of Conducted Test

Please refer to Appendix A.



3.3 Conducted Output Power

3.3.1 Description of the Conducted Output Power Measurement

A system simulator was used to establish communication with the EUT. Its parameters were set to force the EUT transmitting at maximum output power. The measured power in the radio frequency on the transmitter output terminals shall be reported.

3.3.2 Test Procedures

1. The transmitter output port was connected to the system simulator.
2. Set EUT at maximum power through the system simulator.
3. Select lowest, middle, and highest channels for each band and different modulation.
4. Measure and record the power level from the system simulator.



3.4 EIRP

3.4.1 Description of the EIRP Measurement

The EIRP of mobile transmitters must not exceed 23 dBm /10 megahertz for LTE Band 48.

The testing follows ANSI C63.26-2015 Section 5.2.5.5

According to KDB 412172 D01 Power Approach,

$EIRP = P_T + G_T - L_C$, where

P_T = transmitter output power in dBm

G_T = gain of the transmitting antenna in dBi

L_C = signal attenuation in the connecting cable between the transmitter and antenna in dB

Device	Maximum EIRP (dBm/10 MHz)
End User Device	23

3.4.2 Test Procedures

The testing follows procedure in Section 5.2 of ANSI C63.26-2015 and KDB 940660 D01 Part 96 Eqpt v02 Section 3.2(b)(2)

Determine the EIRP by adding the effective antenna gain to the measured average conducted power level.



3.5 Occupied Bandwidth

3.5.1 Description of Occupied Bandwidth Measurement

The occupied bandwidth is the width of a frequency band such that, below the lower and above the upper frequency limits, the mean powers emitted are each equal to a specified percentage 0.5% of the total mean transmitted power.

The 26 dB emission bandwidth is defined as the frequency range between two points, one above and one below the carrier frequency, at which the spectral density of the emission is attenuated 26 dB below the maximum in-band spectral density of the modulated signal. Spectral density (power per unit bandwidth) is to be measured with a detector of resolution bandwidth equal to approximately 1.0% of the emission bandwidth.

3.5.2 Test Procedures

The testing follows ANSI C63.26-2015 Section 5.4.3 (26dB) and Section 5.4.4 (99OB)

1. The EUT was connected to spectrum analyzer and system simulator via a power divider.
2. The spectrum analyzer center frequency is set to the nominal EUT channel center frequency. The span range for the spectrum analyzer shall be between two and five times the anticipated OBW.
3. The nominal resolution bandwidth (RBW) shall be in the range of 1 to 5 % of the anticipated OBW, and the VBW shall be at least 3 times the RBW.
4. Set the detection mode to peak, and the trace mode to max hold.
5. Determine the reference value: Set the EUT to transmit a modulated signal. Allow the trace to stabilize. Set the spectrum analyzer marker to the highest level of the displayed trace.
(this is the reference value)
6. Determine the “-26 dB down amplitude” as equal to (Reference Value – X).
7. Place two markers, one at the lowest and the other at the highest frequency of the envelope of the spectral display such that each marker is at or slightly below the “-X dB down amplitude” determined in step 6. If a marker is below this “-X dB down amplitude” value it shall be placed as close as possible to this value. The OBW is the positive frequency difference between the two markers.
8. Use the 99 % power bandwidth function of the spectrum analyzer and report the measured bandwidth.



3.6 Conducted Band Edge

3.6.1 Description of Conducted Band Edge Measurement

The conducted power of any End User Device emission outside the fundamental emission (whether in or outside of the authorized band) shall not exceed -13 dBm/MHz within 0 to B megahertz (where B is the bandwidth in megahertz of the assigned channel or multiple contiguous channels of the End User Device) above the upper CBSD-assigned channel edge and within 0 to B megahertz below the lower CBSD-assigned channel edge. At all frequencies greater than B megahertz above the upper CBSD assigned channel edge and less than B megahertz below the lower CBSD-assigned channel edge, the conducted power of any End User Device emission shall not exceed -25 dBm/MHz. Notwithstanding the emission limits in this paragraph, the Adjacent Channel Leakage Ratio for End User Devices shall be at least 30 dB.

3.6.2 Test Procedures

The testing follows FCC KDB 971168 D01 v03r01 Section 6.1.

1. The EUT was connected to spectrum analyzer and system simulator via a power divider.
2. The band edges of low and high channels for the highest RF powers were measured.
3. Set RBW $\geq 1\%$ EBW in the 1MHz band immediately outside and adjacent to the band edge.
4. Beyond the 1 MHz band from the band edge, RBW=1MHz was used
5. Set spectrum analyzer with RMS detector.
6. The RF fundamental frequency should be excluded against the limit line in the operating frequency band.

For Adjacent Channel Leakage Ratio (ACLR) measurement,

1. The Adjacent Channel Leakage Ratio (ACLR) is the ratio of the average power in the assigned aggregated channel bandwidth to the average power over the equivalent adjacent channel bandwidth.
2. The option ACLR of spectrum analyzer is used and measures the ACLR ratio by setting equivalent channel bandwidth.
3. The measured ACLR ratio shall be at least 30 dB.



3.7 Conducted Spurious Emission

3.7.1 Description of Conducted Spurious Emission Measurement

Emission and interference limits: the device satisfies the emission limits specified in Section FCC Part 96.41 e) 1) ii) & e) 2) at the lowest and highest edges of the band, and in the middle of the band.

3.7.2 Test Procedures

The testing follows FCC KDB 971168 D01 v03r01 Section 6.1.

1. The EUT was connected to spectrum analyzer and system simulator via a power divider.
2. The RF output of EUT was connected to the spectrum analyzer by RF cable and attenuator. The path loss was compensated to the results for each measurement.
3. The middle channel for the highest RF power within the transmitting frequency was measured.
4. The conducted spurious emission for the whole frequency range was taken.
5. Make the measurement with the spectrum analyzer's RBW = 1MHz, VBW = 3MHz.
6. Set spectrum analyzer with RMS detector.
7. Taking the record of maximum spurious emission.
8. The RF fundamental frequency should be excluded against the limit line in the operating frequency band.
9. The limit line is -40dBm/MHz.



3.8 Frequency Stability

3.8.1 Description of Frequency Stability Measurement

The frequency stability shall be measured by variation of ambient temperature and variation of primary supply voltage to ensure that the fundamental emission stays within the authorized frequency block. The frequency stability of the transmitter shall be maintained within $\pm 0.00025\%$ ($\pm 2.5\text{ppm}$) of the center frequency

3.8.2 Test Procedures for Temperature Variation

The testing follows FCC KDB 971168 D01 v03r01 Section 9.0.

1. The EUT was set up in the thermal chamber and connected with the system simulator.
2. With power OFF, the temperature was decreased to -30°C and the EUT was stabilized before testing. Power was applied and the maximum change in frequency was recorded within one minute.
3. With power OFF, the temperature was raised in 10°C step up to 50°C . The EUT was stabilized at each step for at least half an hour. Power was applied and the maximum frequency change was recorded within one minute.

3.8.3 Test Procedures for Voltage Variation

The testing follows FCC KDB 971168 D01 v03r01 Section 9.0.

1. The EUT was placed in a temperature chamber at $25\pm 5^{\circ}\text{C}$ and connected with the system simulator.
2. The power supply voltage to the EUT was varied from 85% to 115% of the nominal value measured at the input to the EUT.
3. The variation in frequency was measured for the worst case.

4 Radiated Test Items

4.1 Measuring Instruments

See list of measuring instruments of this test report.

4.2 Test Setup

For radiated emissions below 30MHz

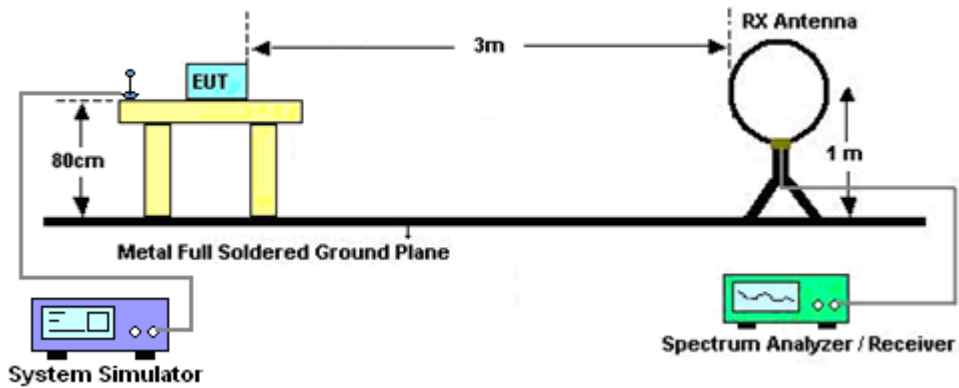

For radiated emissions from 30MHz to 1GHz

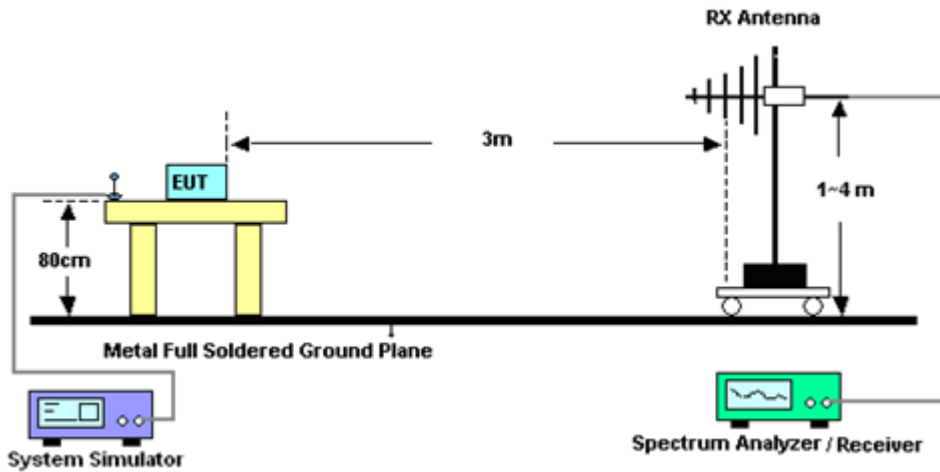

For radiated emissions from 1GHz to 18GHz

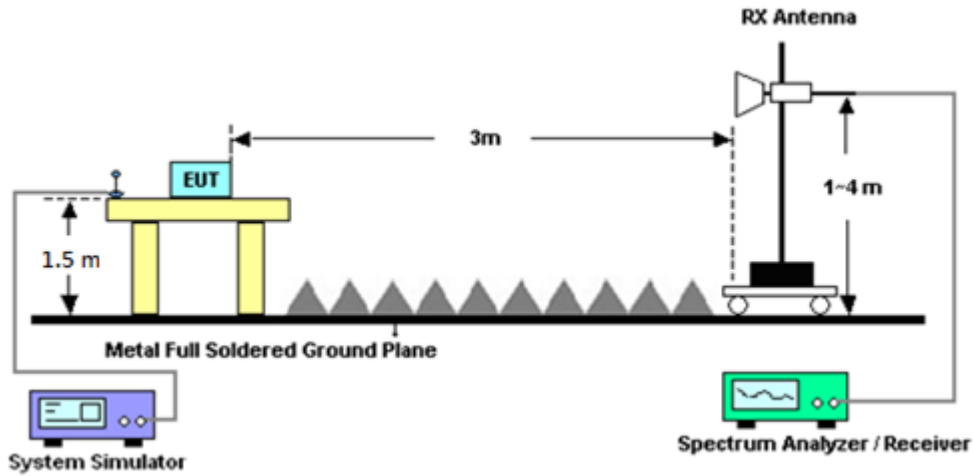

For radiated emissions above 18GHz

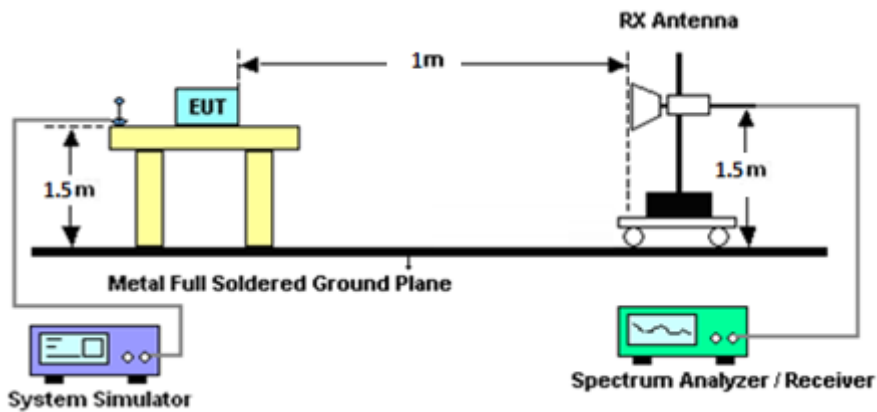

4.3 Test Result of Radiated Test

Please refer to Appendix B.

Note:

The low frequency, which started from 9 kHz to 30MHz, was pre-scanned and the result which was 20dB lower than the limit line was not reported.

There is a comparison data of both open-field test site and alternative test site - semi-Anechoic chamber according to 414788 D01 Radiated Test Site v01r01, and the result came out very similar.



4.4 Radiated Spurious Emission

4.4.1 Description of Radiated Spurious Emission Measurement

The radiated spurious emission was measured by substitution method according to ANSI / TIA-603-E. The power of any emission outside of the authorized operating frequency ranges must be attenuated below the transmitter power (P) by a factor of at least -40dBm / MHz. The spectrum is scanned from 30 MHz up to a frequency including its 10th harmonic.

4.4.2 Test Procedures

The testing follows FCC KDB 971168 D01 v03r01 Section 7 and ANSI / TIA-603-E Section 2.2.12.

1. The EUT was placed on a turntable with 0.8 meter height for frequency below 1GHz and 1.5 meter height for frequency above 1GHz respectively above ground.
2. The EUT was set 3 meters from the receiving antenna mounted on the antenna tower.
3. The table was rotated 360 degrees to determine the position of the highest spurious emission.
4. The height of the receiving antenna is varied between 1m to 4m to search the maximum spurious emission for both horizontal and vertical polarizations.
5. During the measurement, the system simulator parameters were set to force the EUT transmitting at maximum output power.
6. Make the measurement with the spectrum analyzer's RBW = 1MHz, VBW = 3MHz, taking the record of maximum spurious emission.
7. A horn antenna was substituted in place of the EUT and was driven by a signal generator. Tune the output power of signal generator to the same emission level with EUT maximum spurious emission.
EIRP (dBm) = S.G. Power – Tx Cable Loss + Tx Antenna Gain
ERP (dBm) = EIRP - 2.15
8. The RF fundamental frequency should be excluded against the limit line in the operating frequency band.
The limit line is -40dBm/MHz



5 List of Measuring Equipment

Instrument	Brand Name	Model No.	Serial No.	Characteristics	Calibration Date	Test Date	Due Date	Remark
Base Station (Measure)	Anritsu	MT8821C	6262025280	GSM / GPRS /WCDMA / LTE FDD/TDD with 44) /LTE-3CC DLCA,2CC ULCA	Oct. 05, 2020	Oct. 28, 2020 ~ Nov. 01, 2020	Oct. 04, 2021	Conducted (TH05-HY)
Spectrum Analyzer	Rohde & Schwarz	FSV40	101908	10Hz~40GHz	May 13, 2020	Oct. 28, 2020 ~ Nov. 01, 2020	May 12, 2021	Conducted (TH05-HY)
Coupler	Warison	20dB 25W SMA Directional Coupler	#A	1-18GHz	Jan. 13, 2020	Oct. 28, 2020 ~ Nov. 01, 2020	Jan. 12, 2021	Conducted (TH05-HY)
Loop Antenna	Rohde & Schwarz	HFH2-Z2	100315	9 kHz~30 MHz	Dec. 26, 2019	Sep. 24, 2020 ~ Oct. 15, 2020	Dec. 25, 2020	Radiation (03CH12-HY)
Bilog Antenna	TESEQ	CBL 6111D & 00800N1D01N-06	40103 & 07	30MHz~1GHz	Apr. 29, 2020	Sep. 24, 2020 ~ Oct. 15, 2020	Apr. 28, 2021	Radiation (03CH12-HY)
Horn Antenna	SCHWARZBECK	BBHA 9120 D	9120D-1328	1GHz~18GHz	Nov. 14, 2019	Sep. 24, 2020 ~ Oct. 15, 2020	Nov. 13, 2020	Radiation (03CH12-HY)
Horn Antenna	SCHWARZBECK	BBHA 9120D	9120D-1241	1GHz ~ 18GHz	Jul. 15, 2020	Sep. 24, 2020 ~ Oct. 15, 2020	Jul. 14, 2021	Radiation (03CH12-HY)
SHF-EHF Horn Antenna	SCHWARZBECK	BBHA 9170	BBHA9170584	18GHz~40GHz	Dec. 10, 2019	Sep. 24, 2020 ~ Oct. 15, 2020	Dec. 09, 2020	Radiation (03CH12-HY)
SHF-EHF Horn Antenna	SCHWARZBECK	BBHA 9170	BBHA9170980	18GHz ~ 40GHz	Jan. 10, 2019	Sep. 24, 2020 ~ Oct. 15, 2020	Jan. 09, 2021	Radiation (03CH12-HY)
Preamplifier	COM-POWER	PA-103	161075	10MHz~1GHz	Mar. 25, 2020	Sep. 24, 2020 ~ Oct. 15, 2020	Mar. 24, 2021	Radiation (03CH12-HY)
Preamplifier	Keysight	83017A	MY57280120	1GHz~26.5GHz	Jul. 20, 2020	Sep. 24, 2020 ~ Oct. 15, 2020	Jul. 19, 2021	Radiation (03CH12-HY)
Preamplifier	Jet-Power	JPA0118-55-303K	1710001800054002	1GHz~18GHz	Feb. 07, 2020	Sep. 24, 2020 ~ Oct. 15, 2020	Feb. 06, 2021	Radiation (03CH12-HY)
Preamplifier	EMEC	EM18G40G	060715	18GHz~40GHz	Dec. 13, 2019	Sep. 24, 2020 ~ Oct. 15, 2020	Dec. 12, 2020	Radiation (03CH12-HY)
Spectrum Analyzer	Agilent	N9010A	MY54200485	10Hz~44GHz	Feb. 10, 2020	Sep. 24, 2020 ~ Oct. 15, 2020	Feb. 09, 2021	Radiation (03CH12-HY)
Signal Generator	Anritsu	MG3694C	163401	0.1Hz~40GHz	Feb. 15, 2020	Sep. 24, 2020 ~ Oct. 15, 2020	Feb. 14, 2021	Radiation (03CH12-HY)
RF Cable	HUBER + SUHNER	SUCOFLEX 104	MY9837/4PE	9kHz~30MHz	Mar. 12, 2020	Sep. 24, 2020 ~ Oct. 15, 2020	Mar. 11, 2021	Radiation (03CH12-HY)
RF Cable	HUBER + SUHNER	SUCOFLEX 126E	0058/126E	30MHz~18GHz	Dec. 12, 2019	Sep. 24, 2020 ~ Oct. 15, 2020	Dec. 11, 2020	Radiation (03CH12-HY)
RF Cable	HUBER + SUHNER	SUCOFLEX 102	505134/2	30MHz~40GHz	Feb. 25, 2020	Sep. 24, 2020 ~ Oct. 15, 2020	Feb. 24, 2021	Radiation (03CH12-HY)
RF Cable	HUBER + SUHNER	SUCOFLEX 102	800740/2	30MHz~40GHz	Feb. 25, 2020	Sep. 24, 2020 ~ Oct. 15, 2020	Feb. 24, 2021	Radiation (03CH12-HY)
Hygrometer	TECPEL	DTM-303B	TP140349	N/A	Oct. 25, 2019	Sep. 24, 2020 ~ Oct. 15, 2020	Oct. 24, 2020	Radiation (03CH12-HY)
Controller	EMEC	EM1000	N/A	Control Turn table & Ant Mast	N/A	Sep. 24, 2020 ~ Oct. 15, 2020	N/A	Radiation (03CH12-HY)
Antenna Mast	EMEC	AM-BS-4500-B	N/A	1m~4m	N/A	Sep. 24, 2020 ~ Oct. 15, 2020	N/A	Radiation (03CH12-HY)
Turn Table	EMEC	TT2000	N/A	0~360 Degree	N/A	Sep. 24, 2020 ~ Oct. 15, 2020	N/A	Radiation (03CH12-HY)
Software	Audix	E3 6.2009-8-24	RK-000989	N/A	N/A	Sep. 24, 2020 ~ Oct. 15, 2020	N/A	Radiation (03CH12-HY)



6 Uncertainty of Evaluation

Uncertainty of Radiated Emission Measurement (30 MHz ~ 1000 MHz)

Measuring Uncertainty for a Level of Confidence of 95% (U = 2Uc(y))	3.07
---	------

Uncertainty of Radiated Emission Measurement (1 GHz ~ 18 GHz)

Measuring Uncertainty for a Level of Confidence of 95% (U = 2Uc(y))	3.21
---	------

Uncertainty of Radiated Emission Measurement (18 GHz ~ 40 GHz)

Measuring Uncertainty for a Level of Confidence of 95% (U = 2Uc(y))	3.80
---	------



Appendix A. Test Results of Conducted Test

Conducted Output Power(Average power)

LTE Band 48C_CA Maximum Average Power [dBm]								
BW [MHz]	PCC		SCC		Mod	Lowest	Middle	Highest
	RB Size	RB Offset	RB Size	RB Offset				
20+20	100	0	100	0	QPSK	12.32	11.98	12.38
20+20	1	0	1	99		5.32	5.06	5.31
20+20	1	99	1	0		18.95	18.67	19.07
20+20	100	0	100	0	16-QAM	12.33	12.00	12.38
20+20	1	0	1	99		5.41	5.21	5.44
20+20	1	99	1	0		18.34	17.91	18.27
20+20	100	0	100	0	64-QAM	12.34	12.04	12.38
20+20	1	0	1	99		5.08	4.79	5.07
20+20	1	99	1	0		16.86	16.44	16.87
20+20	100	0	100	0	256-QAM	12.38	12.04	12.40
20+20	1	0	1	99		5.30	5.05	5.30
20+20	1	99	1	0		14.03	13.67	14.11
20+15	100	0	75	0	QPSK	12.68	12.10	12.36
20+15	1	0	1	74		5.84	5.17	5.34
20+15	1	74	1	0		19.38	18.81	19.18
20+15	100	0	75	0	16-QAM	12.74	12.06	12.35
20+15	1	0	1	74		6.38	5.69	5.87
20+15	1	74	1	0		18.95	18.34	18.72
20+15	100	0	75	0	64-QAM	12.74	12.12	12.36
20+15	1	0	1	74		6.00	5.34	5.55
20+15	1	74	1	0		17.56	17.00	17.30
20+15	100	0	75	0	256-QAM	12.73	12.11	12.40
20+15	1	0	1	74		6.08	5.39	5.56
20+15	1	74	1	0		14.61	14.05	14.36
15+20	75	0	100	0	QPSK	12.69	11.58	11.90
15+20	1	0	1	99		5.70	4.56	4.84
15+20	1	74	1	0		19.31	18.21	18.57
15+20	75	0	100	0	16-QAM	12.67	11.60	11.92
15+20	1	0	1	99		6.18	5.22	5.37
15+20	1	74	1	0		18.88	17.87	18.17
15+20	75	0	100	0	64-QAM	12.69	11.60	11.92
15+20	1	0	1	99		5.88	4.85	5.02
15+20	1	74	1	0		17.55	16.50	16.85
15+20	75	0	100	0	256-QAM	12.71	11.64	11.95
15+20	1	0	1	99		5.96	4.81	5.06
15+20	1	74	1	0		14.62	13.48	13.82



LTE Band 48C_CA Maximum Average Power [dBm]								
BW [MHz]	PCC		SCC		Mod	Lowest	Middle	Highest
	RB Size	RB Offset	RB Size	RB Offset				
20+10	100	0	50	0	QPSK	12.19	11.65	11.86
20+10	1	0	1	49		5.26	4.70	4.83
20+10	1	99	1	0		18.84	18.36	18.64
20+10	100	0	50	0	16-QAM	12.17	11.63	11.85
20+10	1	0	1	49		5.80	5.29	5.38
20+10	1	99	1	0		18.45	17.96	18.24
20+10	100	0	50	0	64-QAM	12.23	11.70	11.92
20+10	1	0	1	49		5.50	4.93	5.12
20+10	1	99	1	0		17.11	16.60	16.87
20+10	100	0	50	0	256-QAM	12.24	11.71	11.94
20+10	1	0	1	49		5.54	4.96	5.10
20+10	1	99	1	0		14.15	13.63	13.95
10+20	50	0	100	0	QPSK	12.28	11.74	11.94
10+20	1	0	1	99		5.27	4.76	4.91
10+20	1	49	1	0		18.99	18.46	18.70
10+20	50	0	100	0	16-QAM	12.31	11.77	11.98
10+20	1	0	1	99		5.79	5.33	5.41
10+20	1	49	1	0		18.64	18.07	18.36
10+20	50	0	100	0	64-QAM	12.34	11.82	12.05
10+20	1	0	1	99		5.48	4.98	5.09
10+20	1	49	1	0		17.28	16.67	16.96
10+20	50	0	100	0	256-QAM	12.33	11.85	12.06
10+20	1	0	1	99		5.52	4.98	5.18
10+20	1	49	1	0		14.27	13.73	13.97
20+5	100	0	25	0	QPSK	12.34	11.68	11.84
20+5	1	0	1	24		5.40	4.73	4.83
20+5	1	99	1	0		18.96	18.42	18.66
20+5	100	0	25	0	16-QAM	12.34	11.73	11.87
20+5	1	0	1	24		5.98	5.32	5.43
20+5	1	99	1	0		18.63	18.01	18.28
20+5	100	0	25	0	64-QAM	12.36	11.74	11.91
20+5	1	0	1	24		5.64	5.01	5.10
20+5	1	99	1	0		17.23	16.71	16.94
20+5	100	0	25	0	256-QAM	12.41	11.75	11.89
20+5	1	0	1	24		5.70	5.00	5.11
20+5	1	99	1	0		14.32	13.74	13.94



LTE Band 48C_CA Maximum Average Power [dBm]								
BW [MHz]	PCC		SCC		Mod	Lowest	Middle	Highest
	RB Size	RB Offset	RB Size	RB Offset				
5+20	25	0	100	0	QPSK	12.28	11.71	11.95
5+20	1	0	1	99		5.16	4.62	4.83
5+20	1	24	1	0		19.04	18.39	18.73
5+20	25	0	100	0	16-QAM	12.36	11.75	11.99
5+20	1	0	1	99		5.81	5.14	5.40
5+20	1	24	1	0		18.75	18.07	18.36
5+20	25	0	100	0	64-QAM	12.35	11.73	11.96
5+20	1	0	1	99		5.43	4.90	5.08
5+20	1	24	1	0		17.40	16.82	17.00
5+20	25	0	100	0	256-QAM	12.42	11.77	12.02
5+20	1	0	1	99		5.51	4.92	5.17
5+20	1	24	1	0		14.39	13.77	14.03



LTE Band 48C

26dB Bandwidth

Mode	LTE Band 48C : 26dB BW(MHz)			
QPSK				
BW	5MHz+20MHz	10MHz+20MHz	15MHz+20MHz	20MHz+5MHz
Lowest CH	24.73	29.79	34.90	24.98
Middle CH	24.73	29.85	34.90	24.88
Highest CH	24.63	29.91	34.90	24.98
BW	20MHz+10MHz	20MHz+15MHz	20MHz+20MHz	N/A
Lowest CH	30.03	34.97	39.80	-
Middle CH	29.91	34.90	39.88	-
Highest CH	30.09	34.97	39.88	-

Mode	LTE Band 48C : 26dB BW(MHz)			
16QAM				
BW	5MHz+20MHz	10MHz+20MHz	15MHz+20MHz	20MHz+5MHz
Lowest CH	24.83	29.79	34.76	24.88
Middle CH	24.78	30.09	34.76	24.93
Highest CH	24.73	29.85	34.76	24.88
BW	20MHz+10MHz	20MHz+15MHz	20MHz+20MHz	N/A
Lowest CH	29.97	34.90	39.88	-
Middle CH	30.09	34.83	39.88	-
Highest CH	30.03	34.83	39.96	-

Mode	LTE Band 48C : 26dB BW(MHz)			
64QAM				
BW	5MHz+20MHz	10MHz+20MHz	15MHz+20MHz	20MHz+5MHz
Lowest CH	24.73	29.79	34.83	24.93
Middle CH	24.88	29.85	34.90	24.98
Highest CH	24.78	29.85	34.83	24.93
BW	20MHz+10MHz	20MHz+15MHz	20MHz+20MHz	N/A
Lowest CH	30.09	34.97	39.96	-
Middle CH	30.15	34.76	39.80	-
Highest CH	29.91	34.83	39.88	-



Mode	LTE Band 48C : 26dB BW(MHz)			
256QAM				
BW	5MHz+20MHz	10MHz+20MHz	15MHz+20MHz	20MHz+5MHz
Lowest CH	24.68	29.85	34.90	24.83
Middle CH	24.58	29.79	34.83	24.88
Highest CH	24.78	29.85	34.83	24.78
BW	20MHz+10MHz	20MHz+15MHz	20MHz+20MHz	N/A
Lowest CH	30.03	34.83	39.88	-
Middle CH	29.91	34.83	39.88	-
Highest CH	29.97	34.97	39.88	-



LTE Band 48C

QPSK

Lowest Channel / 5MHz+20MHz

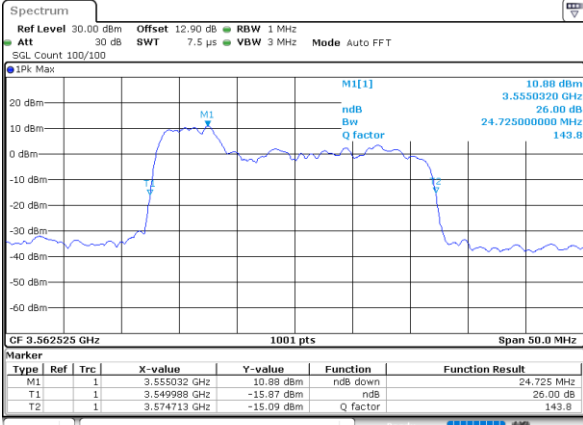

Date: 30.OCT.2020 23:32:02

Lowest Channel / 10MHz+20MHz

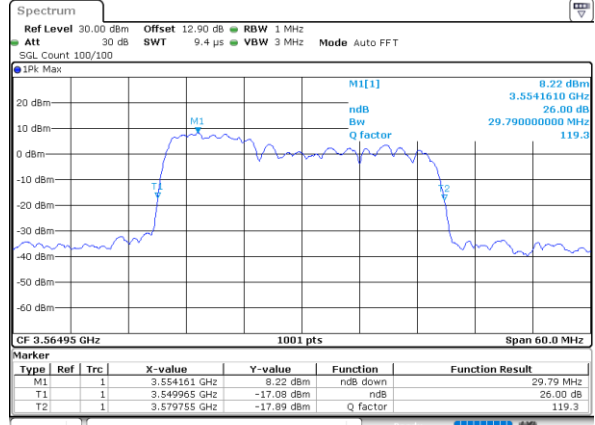

Date: 30.OCT.2020 15:44:43

Middle Channel / 5MHz+20MHz

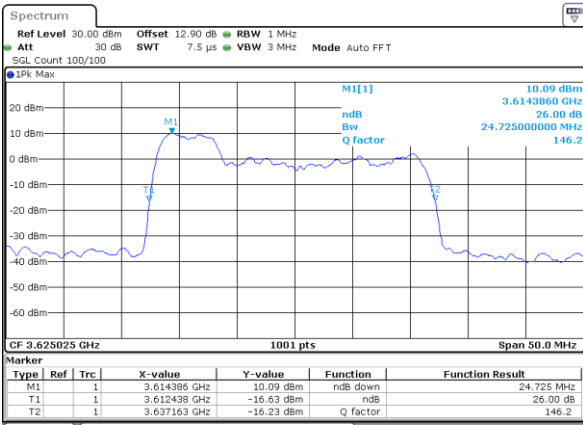

Date: 31.OCT.2020 00:28:36

Middle Channel / 10MHz+20MHz

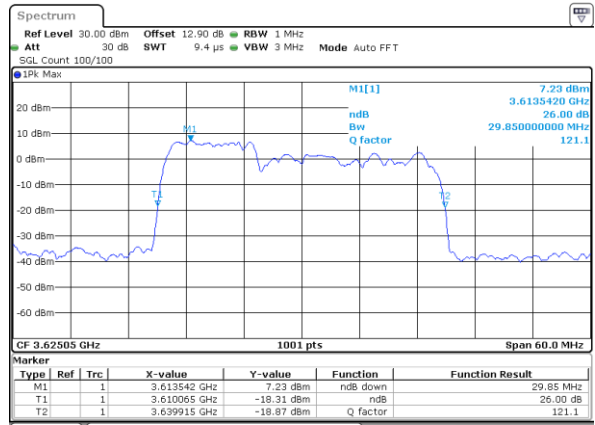

Date: 30.OCT.2020 17:30:25

Highest Channel / 5MHz+20MHz

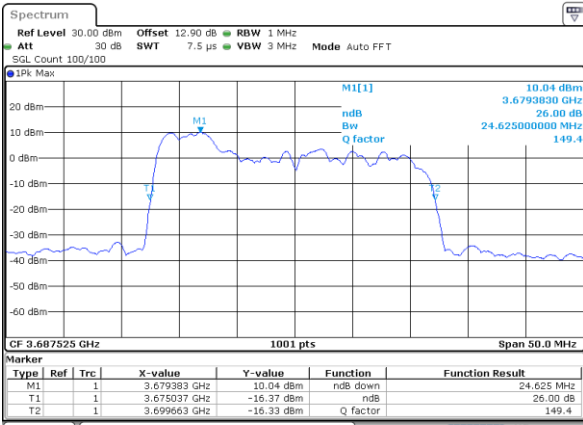

Date: 31.OCT.2020 00:35:04

Highest Channel / 10MHz+20MHz

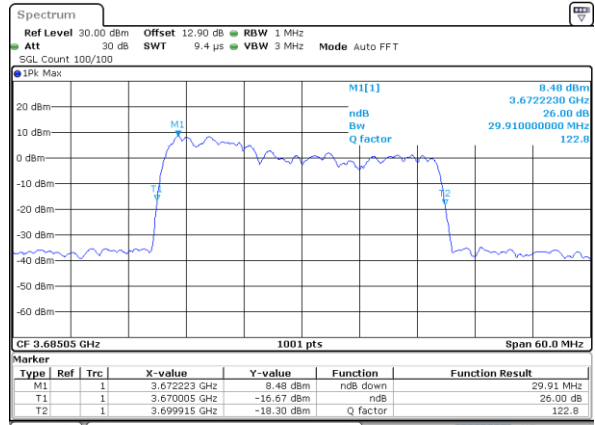

Date: 30.OCT.2020 17:41:37



LTE Band 48C

QPSK

Lowest Channel / 15MHz+20MHz

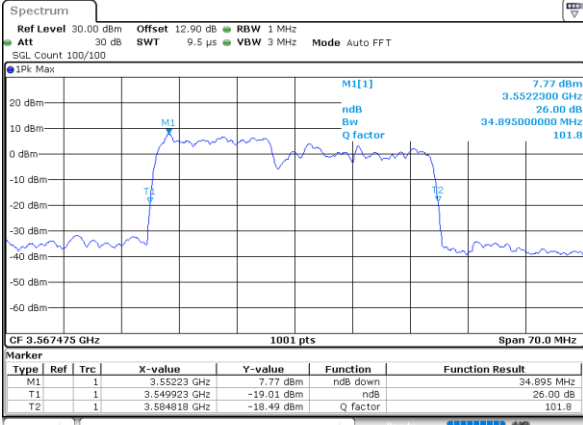

Date: 30.OCT.2020 01:37:48

Lowest Channel / 20MHz+5MHz

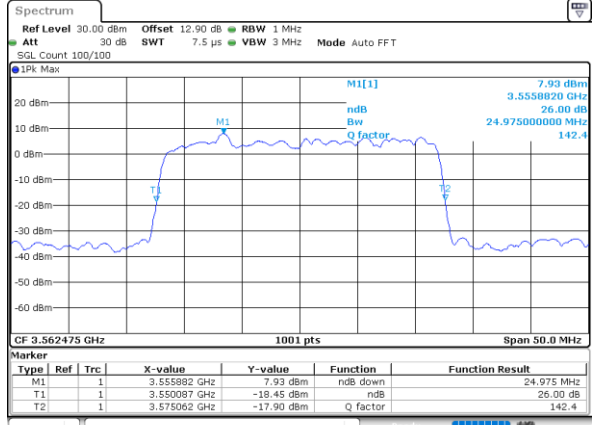

Date: 30.OCT.2020 19:43:35

Middle Channel / 15MHz+20MHz

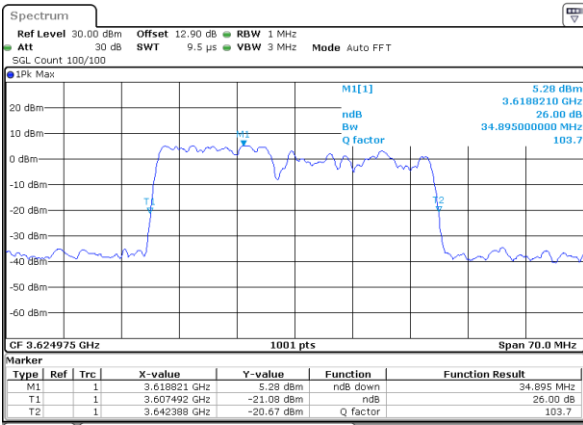

Date: 30.OCT.2020 09:59:26

Middle Channel / 20MHz+5MHz

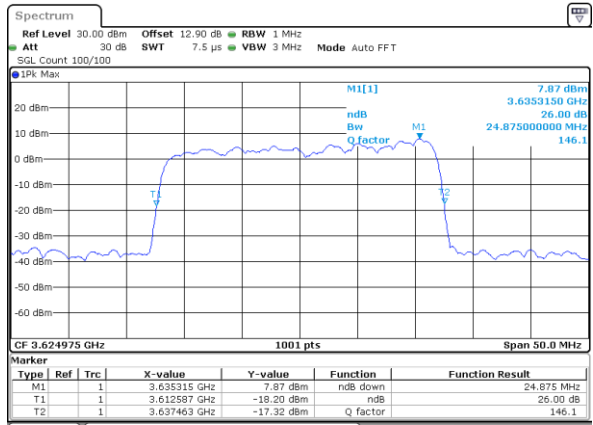

Date: 30.OCT.2020 21:04:14

Highest Channel / 15MHz+20MHz



Date: 30.OCT.2020 10:24:39

Highest Channel / 20MHz+5MHz

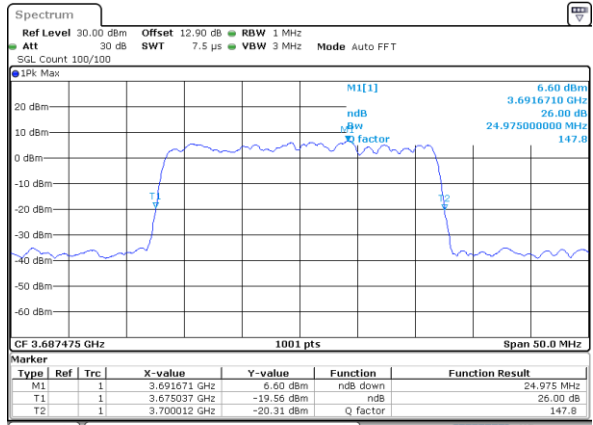

Date: 30.OCT.2020 22:02:07



LTE Band 48C

QPSK

Lowest Channel / 20MHz+10MHz

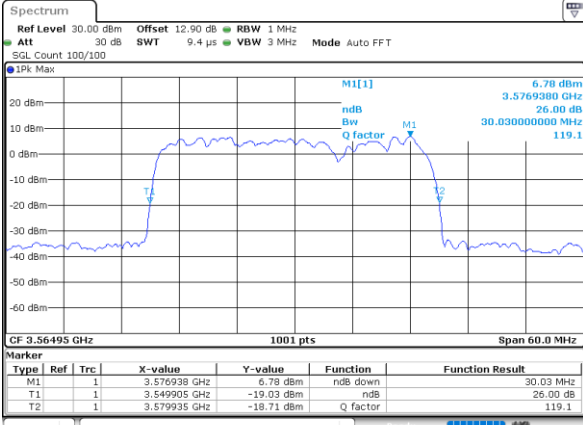

Date: 30.OCT.2020 13:45:30

Lowest Channel / 20MHz+15MHz

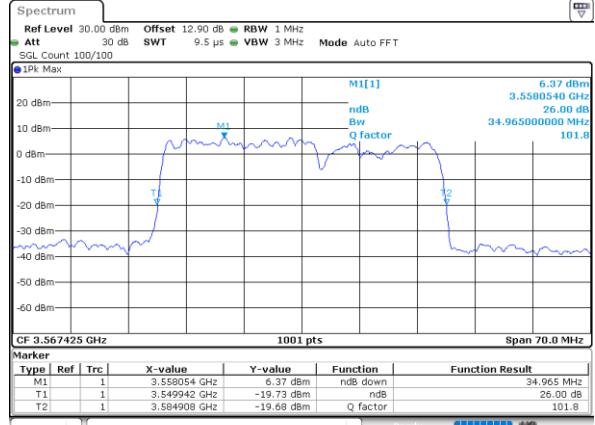

Date: 29.OCT.2020 22:27:58

Middle Channel / 20MHz+10MHz

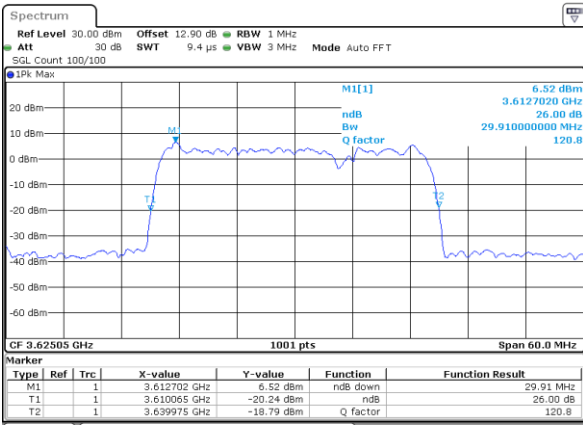

Date: 30.OCT.2020 13:54:57

Middle Channel / 20MHz+15MHz

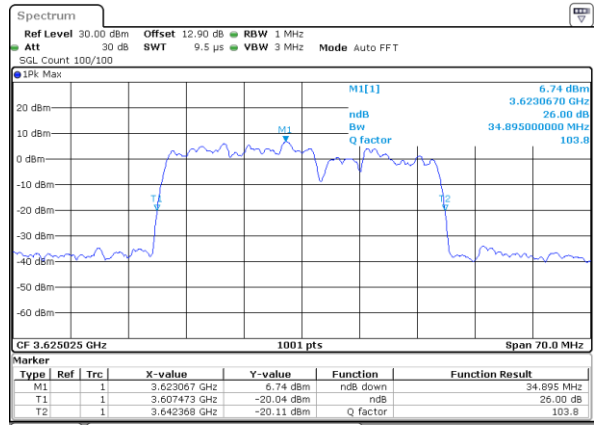

Date: 29.OCT.2020 23:30:38

Highest Channel / 20MHz+10MHz

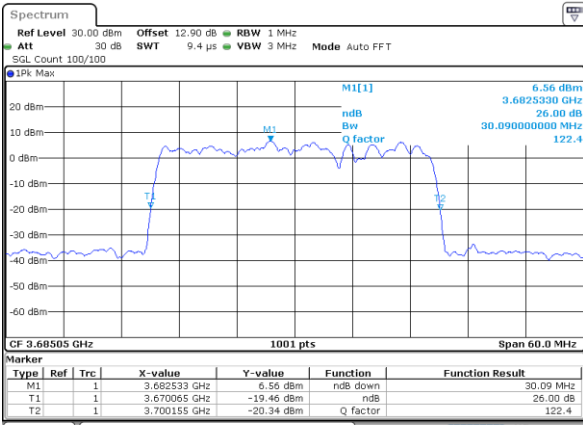

Date: 30.OCT.2020 15:31:18

Highest Channel / 20MHz+15MHz

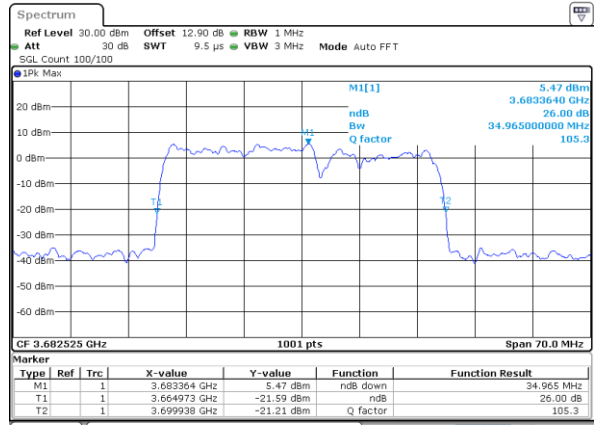

Date: 30.OCT.2020 00:25:30



LTE Band 48C

QPSK

Lowest Channel / 20MHz+20MHz

N/A

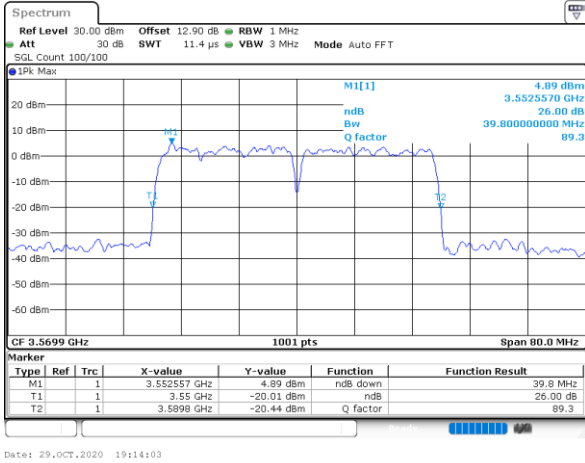

Middle Channel / 20MHz+20MHz

N/A

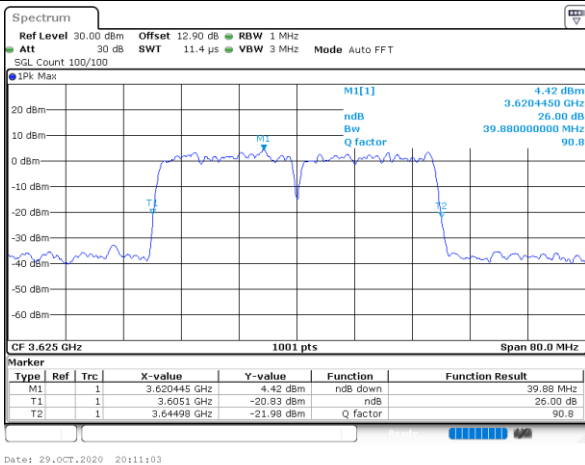

Highest Channel / 20MHz+20MHz

N/A

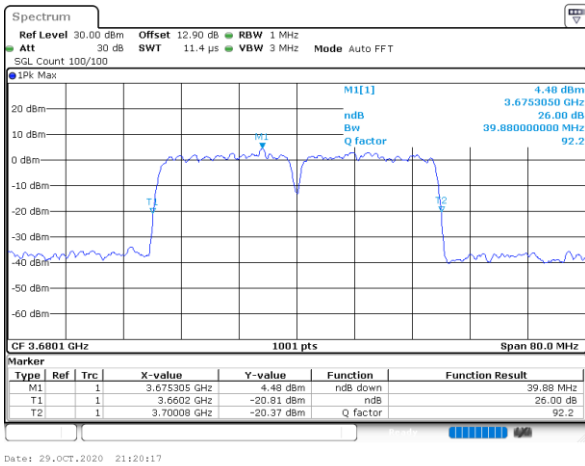



LTE Band 48C

16QAM

Lowest Channel / 5MHz+20MHz

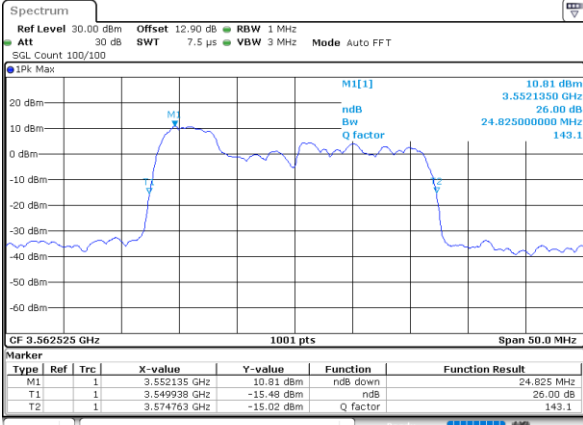

Date: 30.OCT.2020 23:31:39

Lowest Channel / 10MHz+20MHz

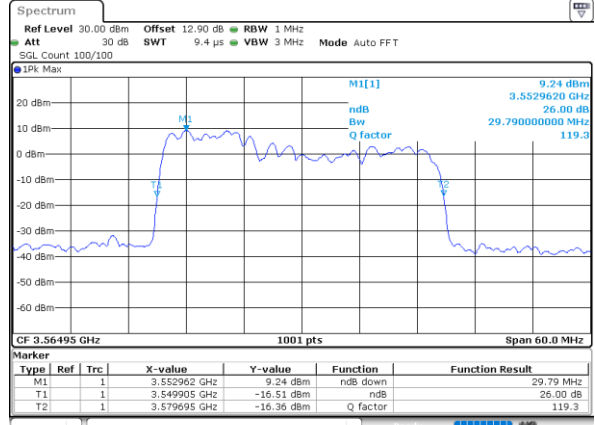

Date: 30.OCT.2020 15:44:21

Middle Channel / 5MHz+20MHz

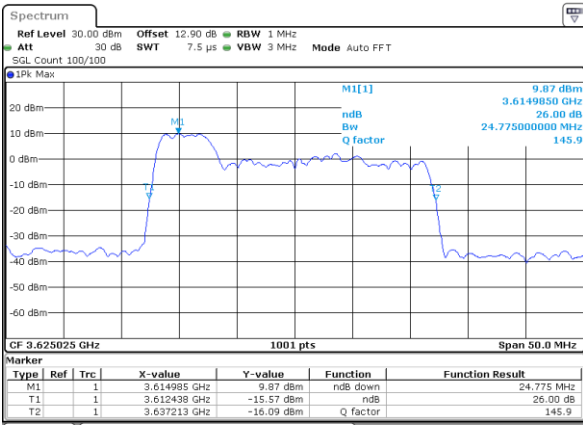

Date: 31.OCT.2020 00:28:14

Middle Channel / 10MHz+20MHz

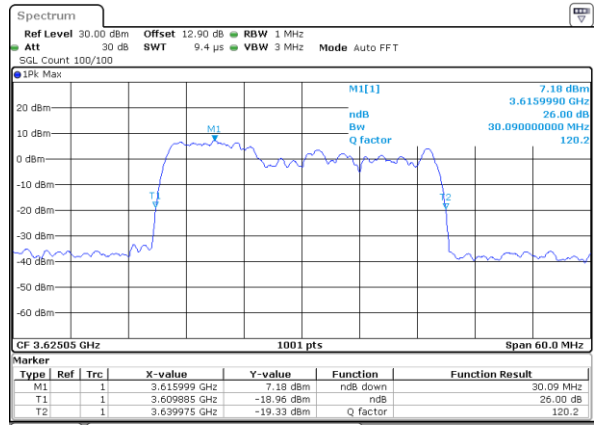

Date: 30.OCT.2020 17:30:02

Highest Channel / 5MHz+20MHz

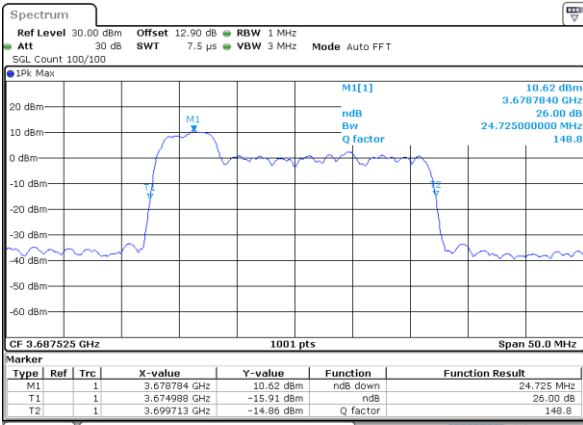

Date: 31.OCT.2020 00:35:26

Highest Channel / 10MHz+20MHz

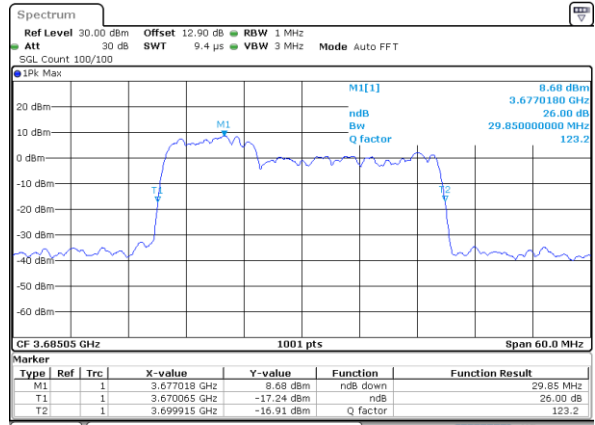

Date: 30.OCT.2020 17:41:59



LTE Band 48C

16QAM

Lowest Channel / 15MHz+20MHz

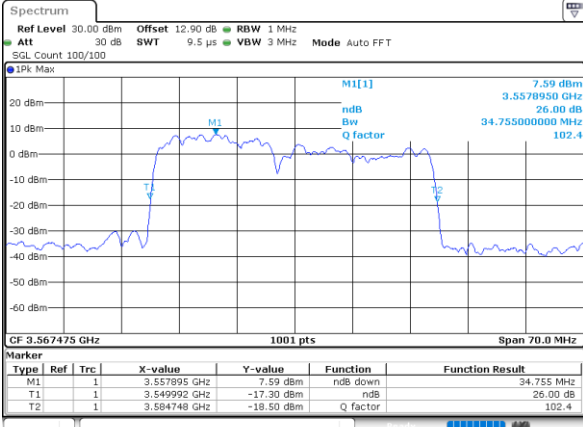

Date: 30.OCT.2020 01:37:26

Lowest Channel / 20MHz+5MHz



Date: 30.OCT.2020 19:43:13

Middle Channel / 15MHz+20MHz

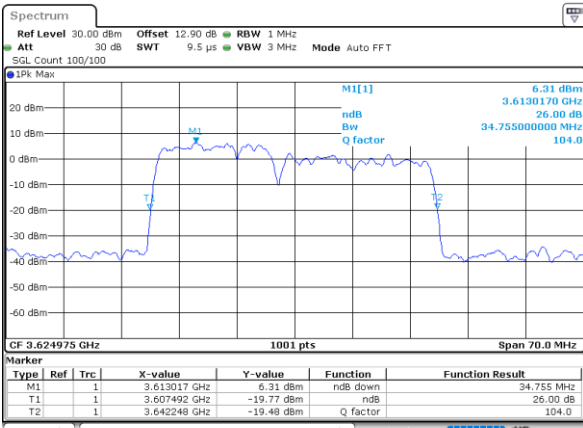

Date: 30.OCT.2020 09:59:04

Middle Channel / 20MHz+5MHz

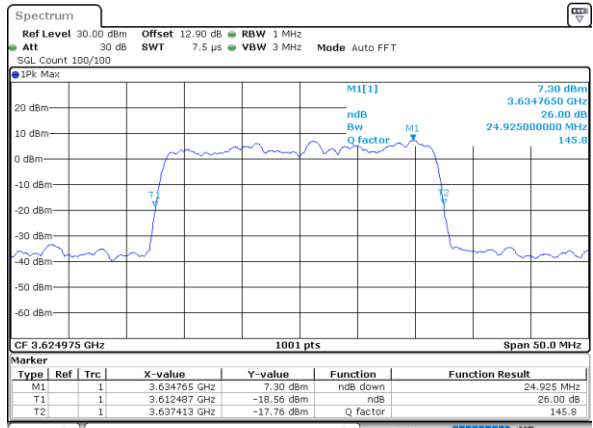

Date: 30.OCT.2020 21:03:51

Highest Channel / 15MHz+20MHz

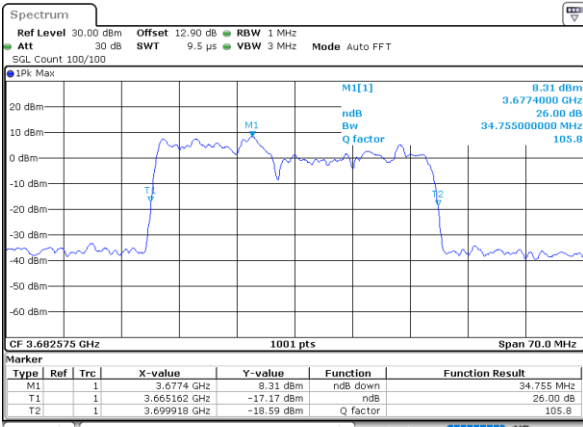

Date: 30.OCT.2020 10:25:02

Highest Channel / 20MHz+5MHz

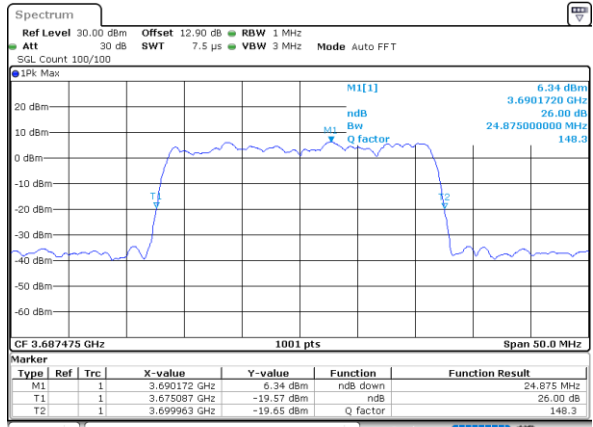

Date: 30.OCT.2020 22:02:30



LTE Band 48C

16QAM

Lowest Channel / 20MHz+10MHz

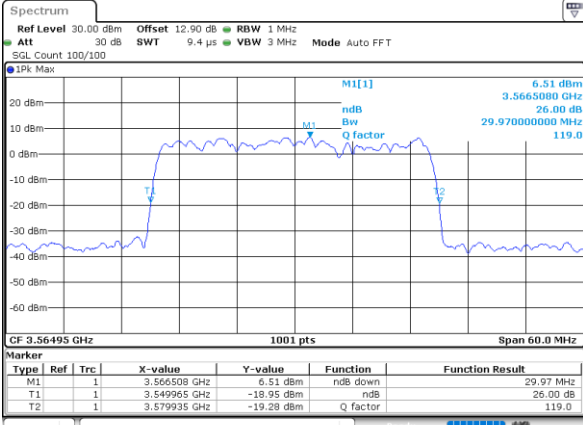

Date: 30.OCT.2020 13:45:08

Lowest Channel / 20MHz+15MHz

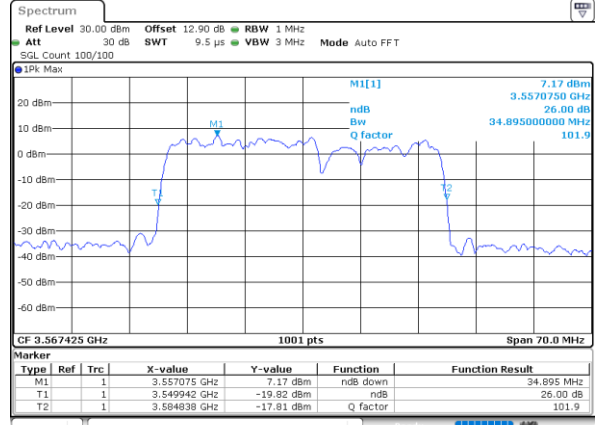

Date: 29.OCT.2020 22:27:36

Middle Channel / 20MHz+10MHz

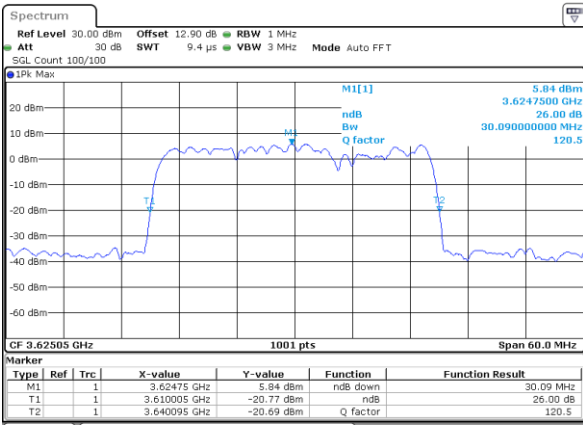

Date: 30.OCT.2020 13:54:35

Middle Channel / 20MHz+15MHz

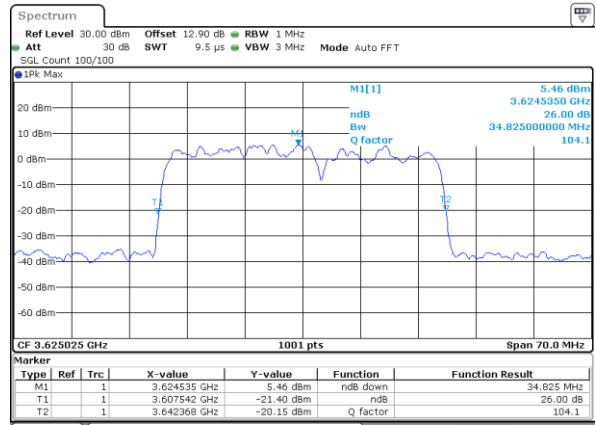

Date: 29.OCT.2020 23:30:15

Highest Channel / 20MHz+10MHz

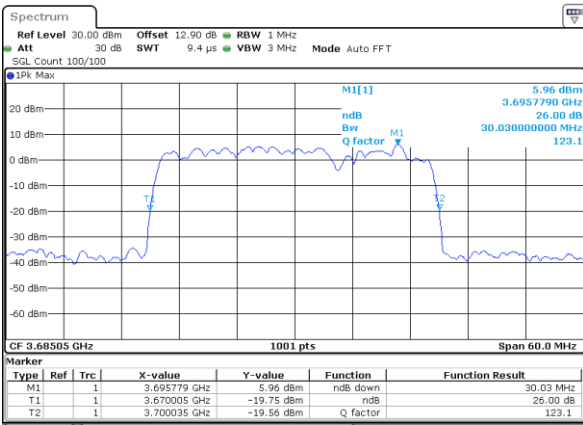

Date: 30.OCT.2020 15:31:40

Highest Channel / 20MHz+15MHz

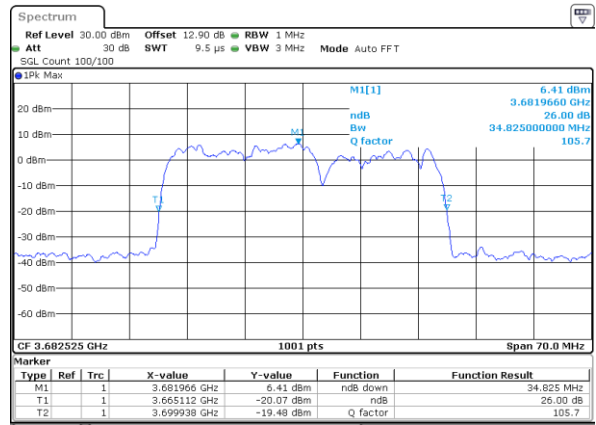

Date: 30.OCT.2020 00:25:52



LTE Band 48C

16QAM

Lowest Channel / 20MHz+20MHz

N/A

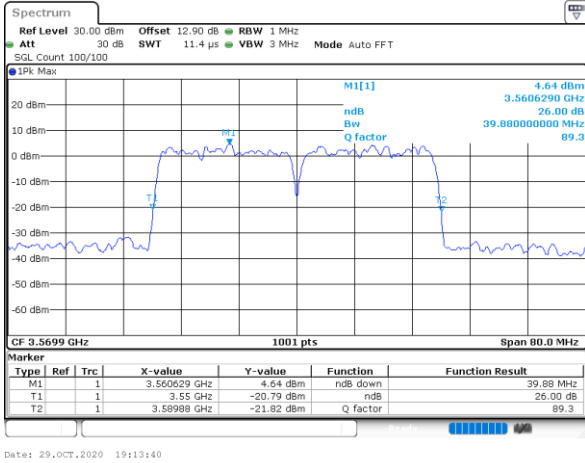

Date: 29.OCT.2020 19:13:40

Middle Channel / 20MHz+20MHz

N/A

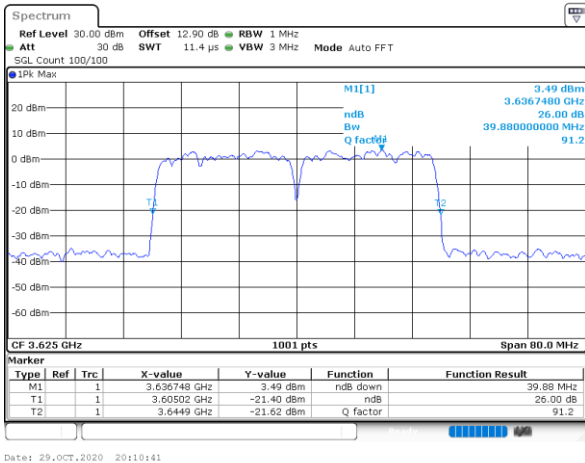

Date: 29.OCT.2020 20:10:41

Highest Channel / 20MHz+20MHz

N/A

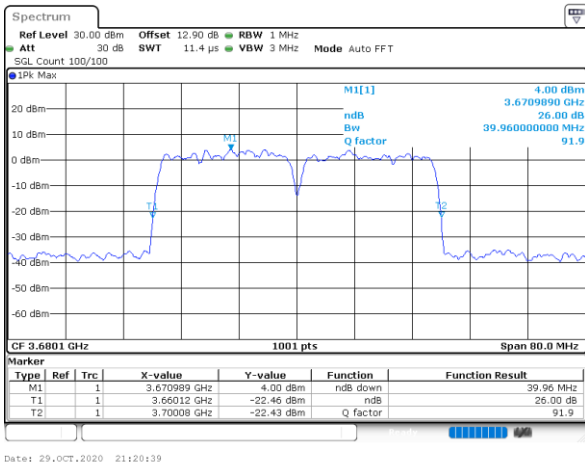

Date: 29.OCT.2020 21:20:39



LTE Band 48C

64QAM

Lowest Channel / 5MHz+20MHz

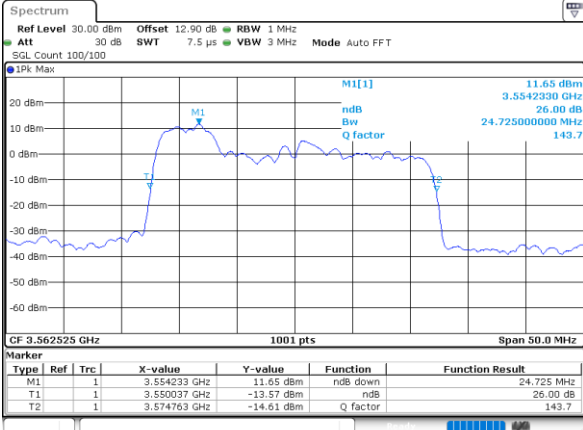

Date: 30.OCT.2020 23:27:02

Lowest Channel / 10MHz+20MHz

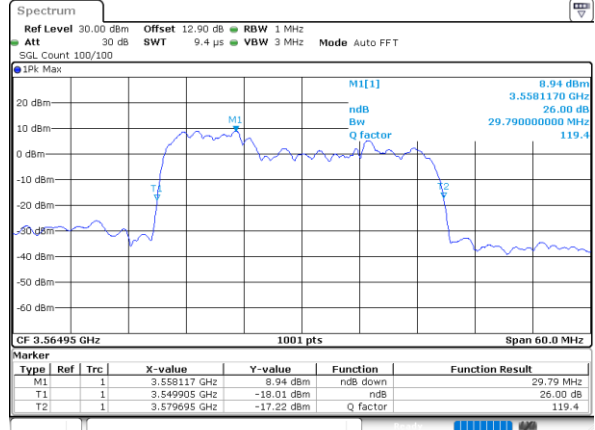

Date: 30.OCT.2020 15:43:59

Middle Channel / 5MHz+20MHz

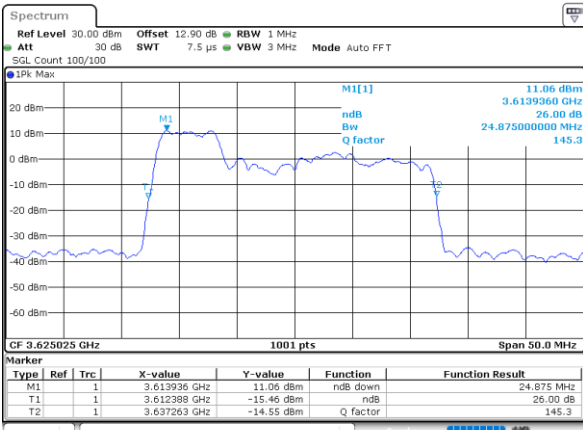

Date: 31.OCT.2020 00:27:51

Middle Channel / 10MHz+20MHz

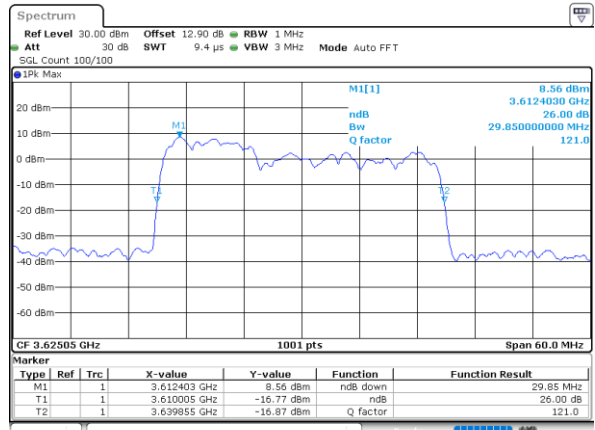

Date: 30.OCT.2020 17:29:40

Highest Channel / 5MHz+20MHz

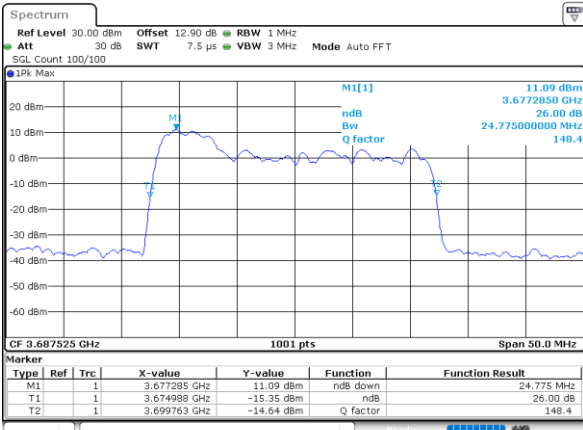

Date: 31.OCT.2020 00:35:48

Highest Channel / 10MHz+20MHz

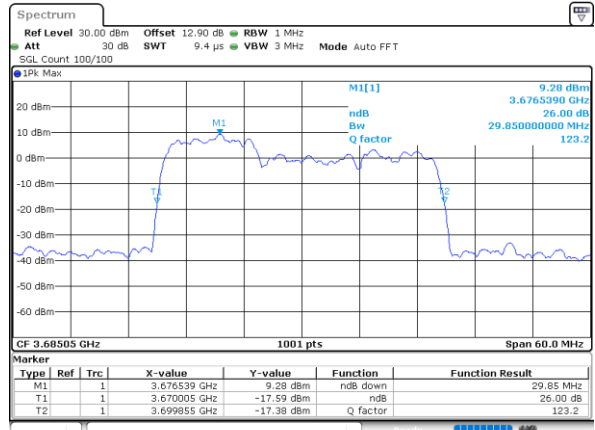

Date: 30.OCT.2020 17:42:22



LTE Band 48C

64QAM

Lowest Channel / 15MHz+20MHz

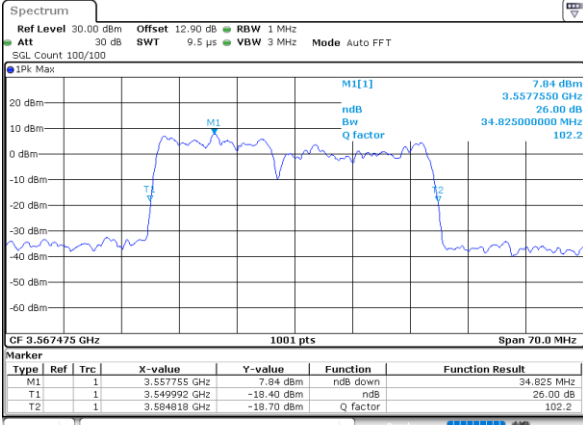

Date: 30.OCT.2020 01:37:04

Lowest Channel / 20MHz+5MHz

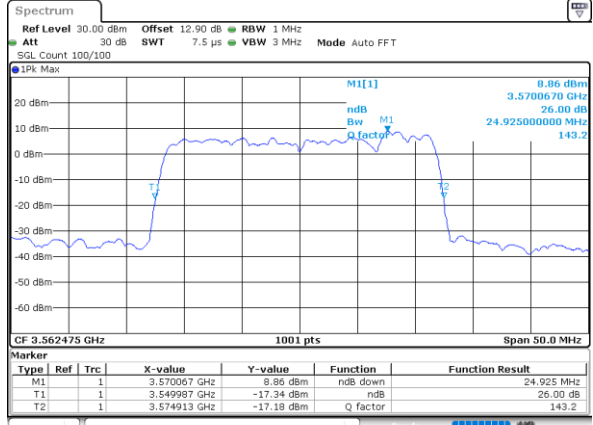

Date: 30.OCT.2020 19:42:50

Middle Channel / 15MHz+20MHz

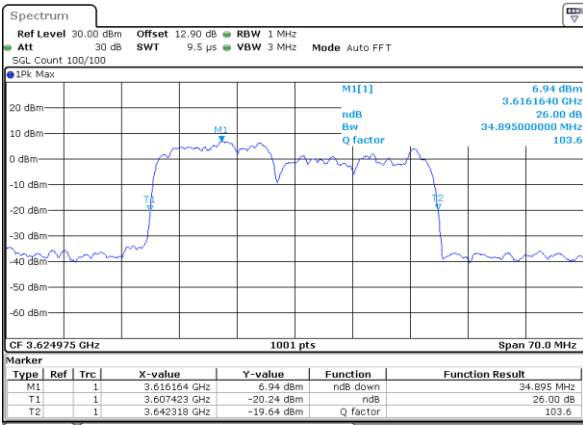

Date: 30.OCT.2020 09:58:42

Middle Channel / 20MHz+5MHz

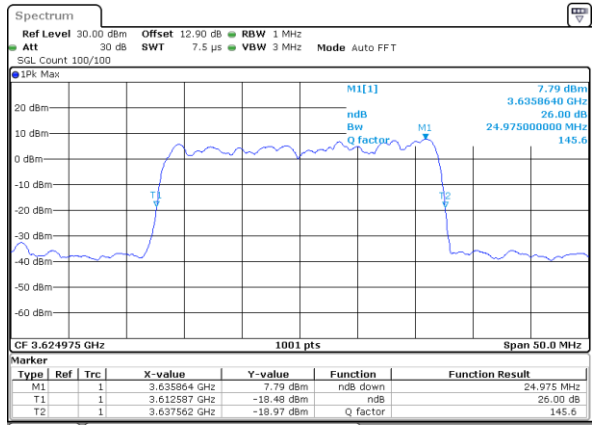

Date: 30.OCT.2020 21:03:29

Highest Channel / 15MHz+20MHz

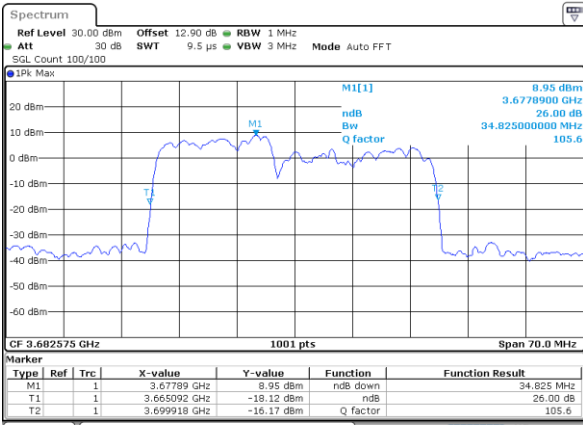

Date: 30.OCT.2020 10:25:24

Highest Channel / 20MHz+5MHz

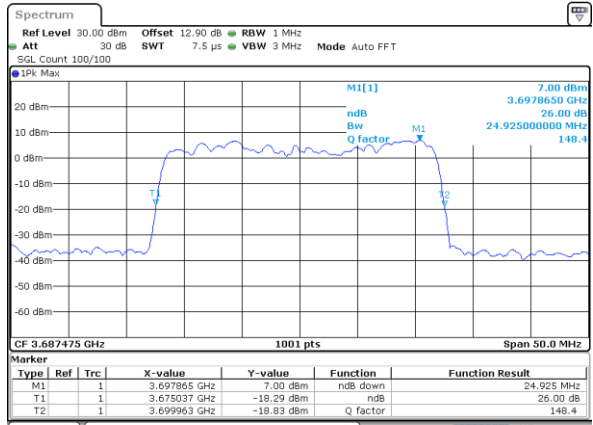

Date: 30.OCT.2020 22:02:52



LTE Band 48C

64QAM

Lowest Channel / 20MHz+10MHz

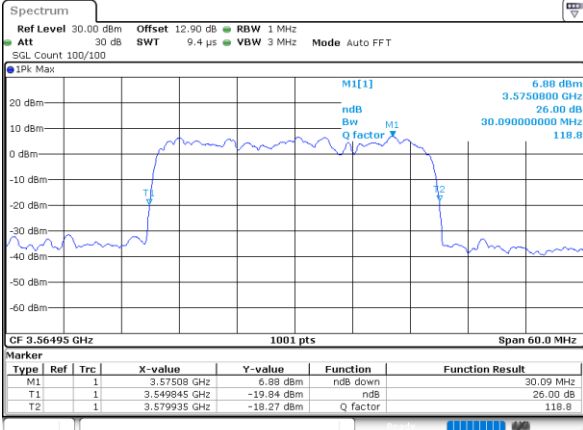

Date: 30.OCT.2020 13:44:46

Lowest Channel / 20MHz+15MHz

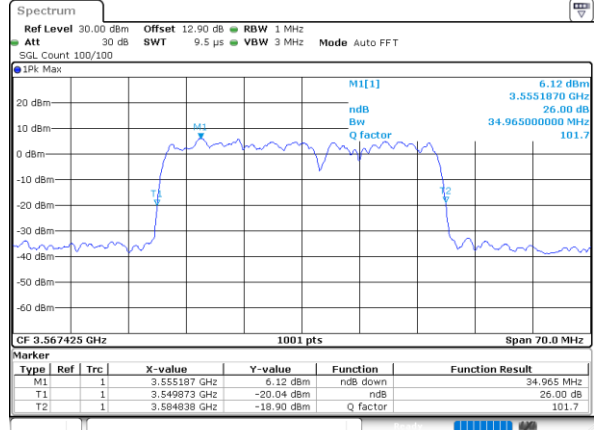

Date: 29.OCT.2020 22:27:14

Middle Channel / 20MHz+10MHz

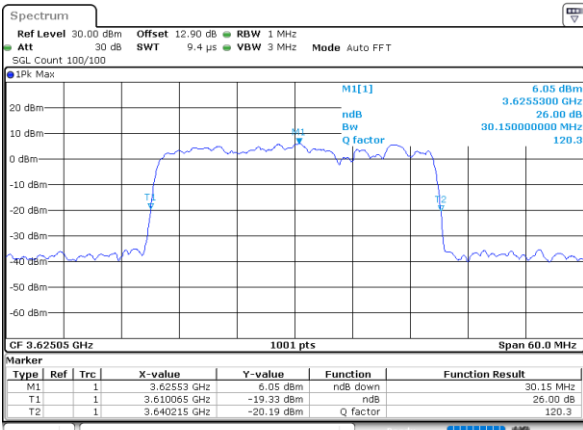

Date: 30.OCT.2020 13:54:13

Middle Channel / 20MHz+15MHz

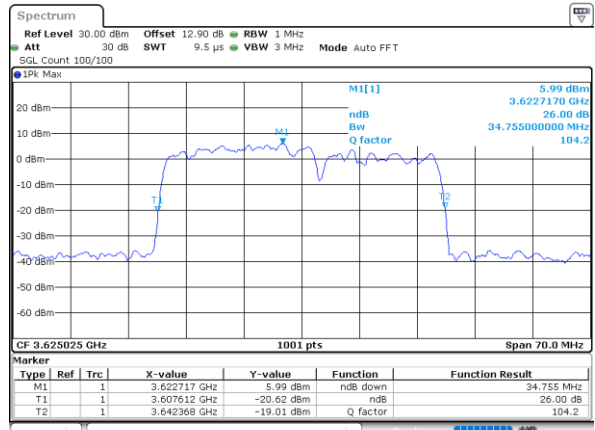

Date: 29.OCT.2020 23:29:53

Highest Channel / 20MHz+10MHz

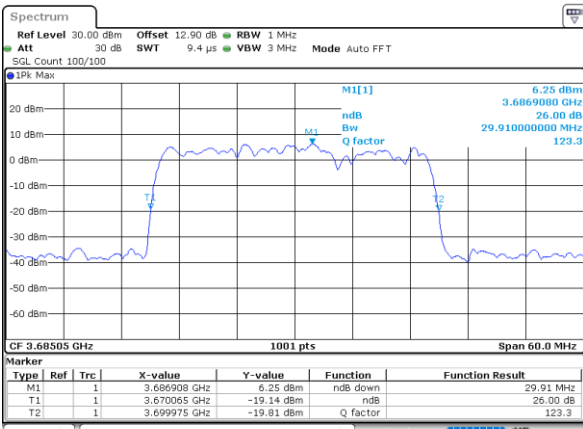

Date: 30.OCT.2020 15:32:03

Highest Channel / 20MHz+15MHz

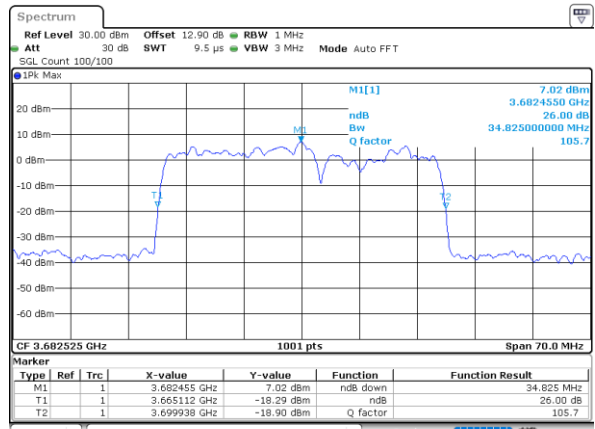

Date: 30.OCT.2020 00:26:15



LTE Band 48C

64QAM

Lowest Channel / 20MHz+20MHz

N/A

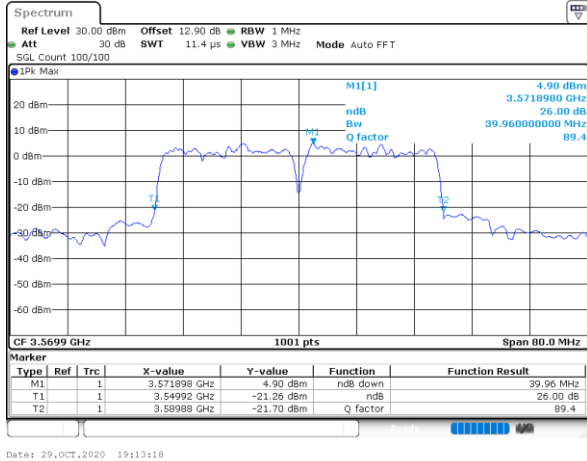

Date: 29.OCT.2020 19:13:18

Middle Channel / 20MHz+20MHz

N/A

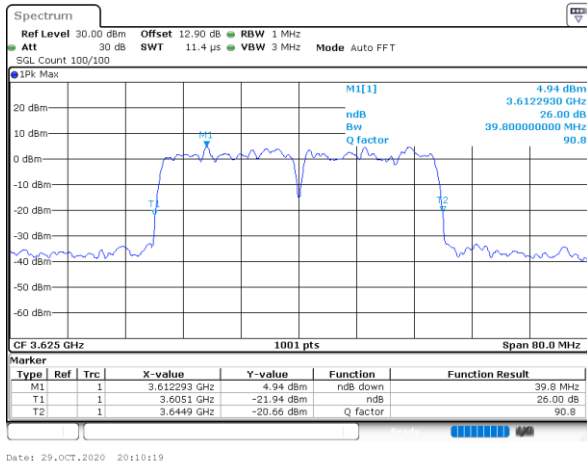

Date: 29.OCT.2020 20:10:19

Highest Channel / 20MHz+20MHz

N/A

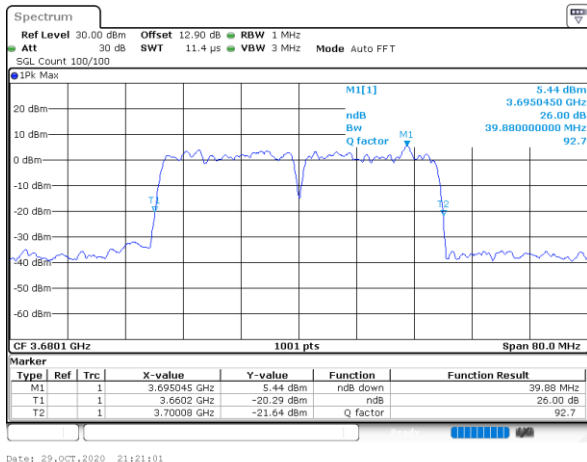

Date: 29.OCT.2020 21:21:01



LTE Band 48C

256QAM

Lowest Channel / 5MHz+20MHz

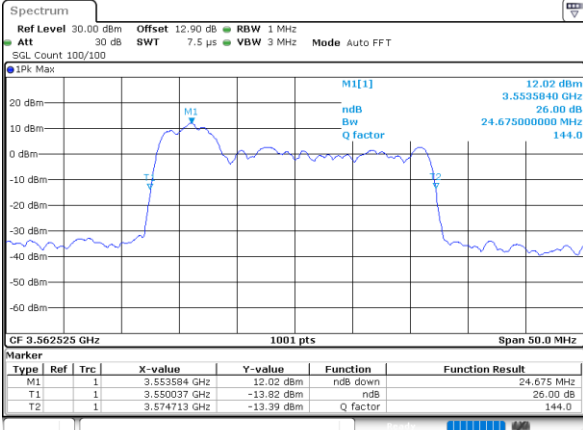

Date: 30.OCT.2020 23:26:39

Lowest Channel / 10MHz+20MHz

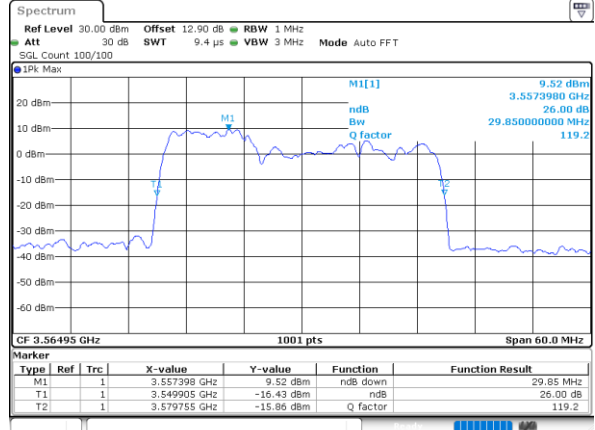

Date: 30.OCT.2020 15:43:36

Middle Channel / 5MHz+20MHz

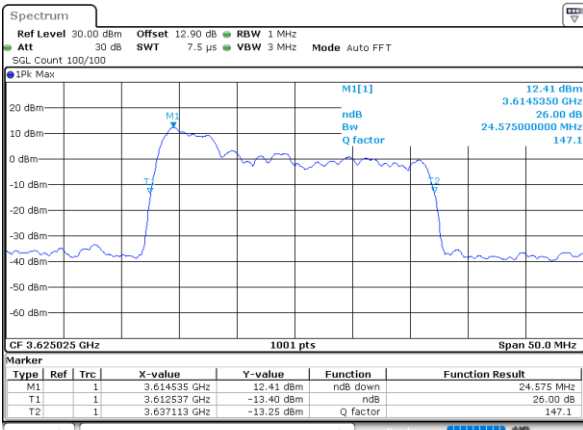

Date: 31.OCT.2020 00:27:29

Middle Channel / 10MHz+20MHz

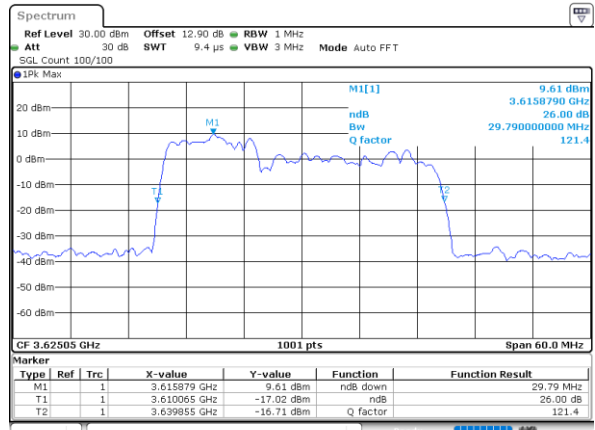

Date: 30.OCT.2020 17:29:18

Highest Channel / 5MHz+20MHz

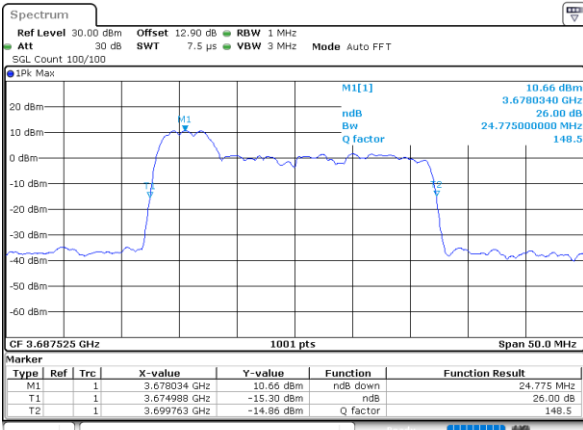

Date: 31.OCT.2020 00:36:11

Highest Channel / 10MHz+20MHz

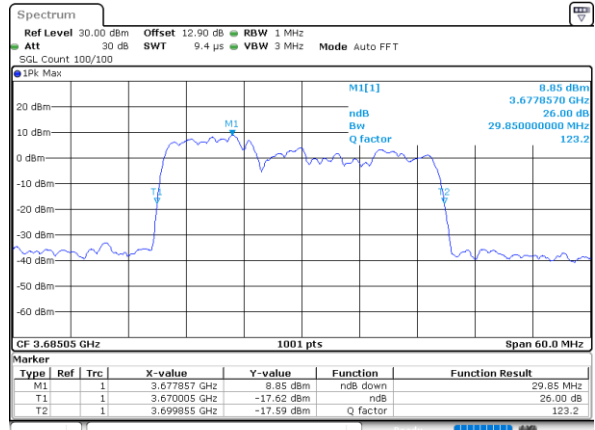

Date: 30.OCT.2020 17:42:44



LTE Band 48C

256QAM

Lowest Channel / 15MHz+20MHz

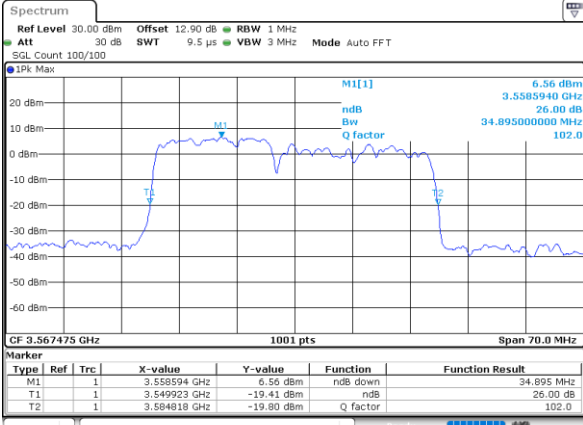

Date: 30.OCT.2020 01:36:41

Lowest Channel / 20MHz+5MHz

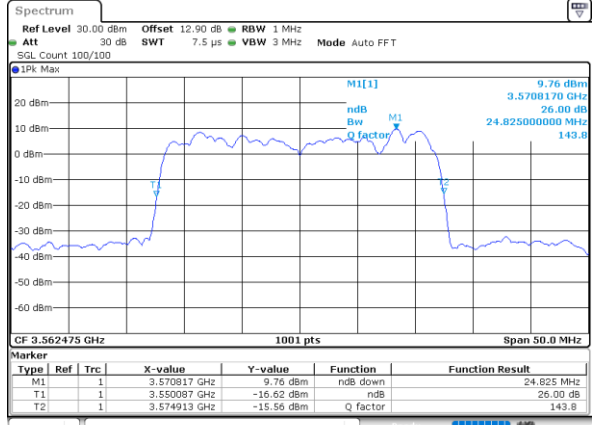

Date: 30.OCT.2020 19:42:28

Middle Channel / 15MHz+20MHz

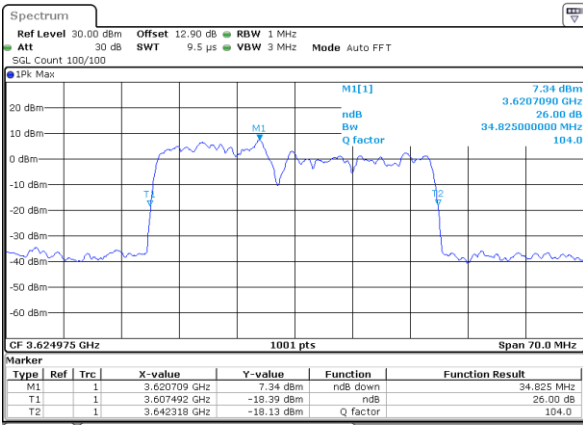

Date: 30.OCT.2020 09:58:20

Middle Channel / 20MHz+5MHz

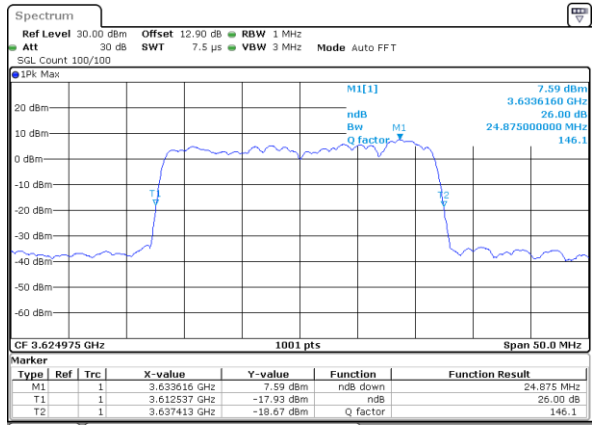

Date: 30.OCT.2020 21:03:07

Highest Channel / 15MHz+20MHz

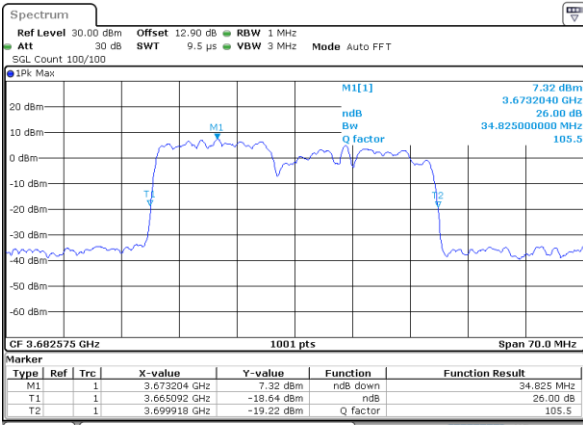

Date: 30.OCT.2020 10:25:46

Highest Channel / 20MHz+5MHz

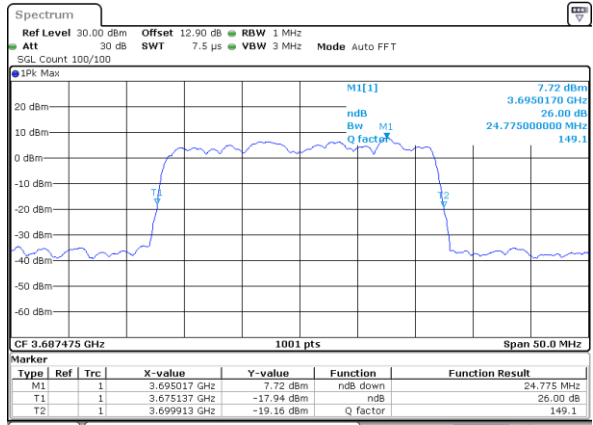

Date: 30.OCT.2020 22:03:14



LTE Band 48C

256QAM

Lowest Channel / 20MHz+10MHz

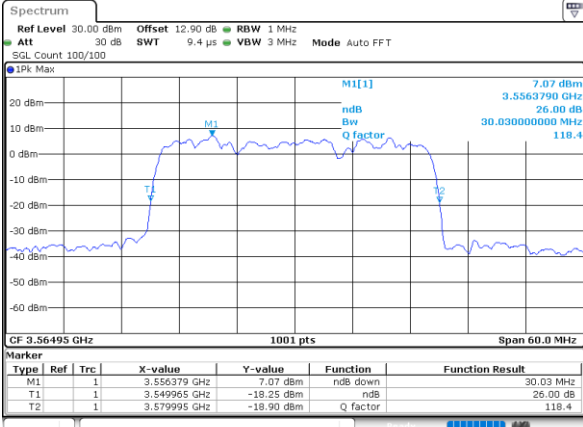

Date: 30.OCT.2020 13:44:23

Lowest Channel / 20MHz+15MHz

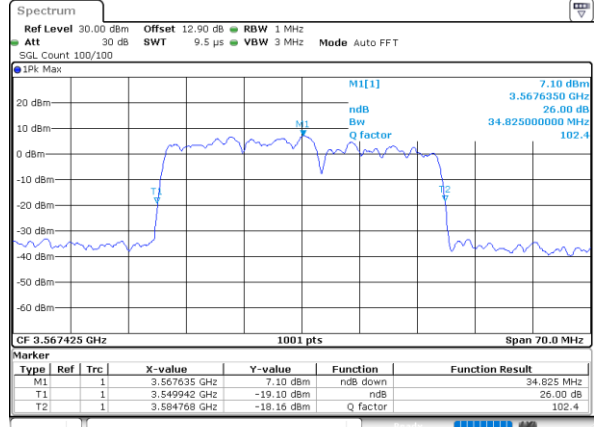

Date: 29.OCT.2020 22:26:51

Middle Channel / 20MHz+10MHz

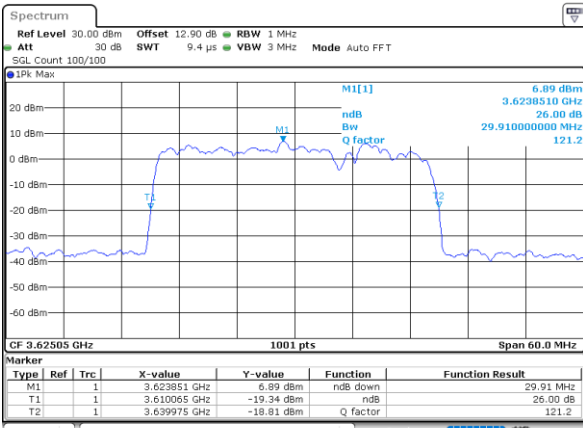

Date: 30.OCT.2020 13:53:50

Middle Channel / 20MHz+15MHz

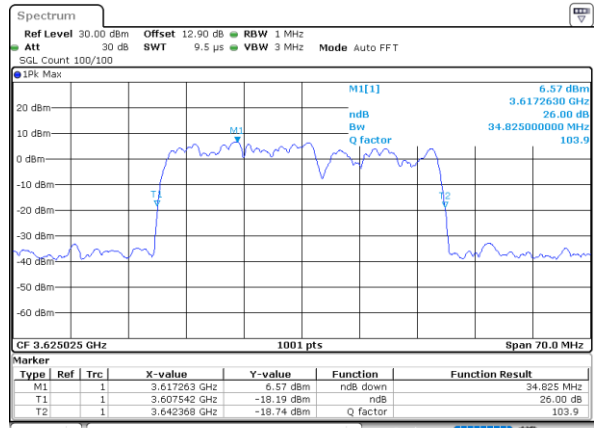

Date: 29.OCT.2020 23:29:30

Highest Channel / 20MHz+10MHz

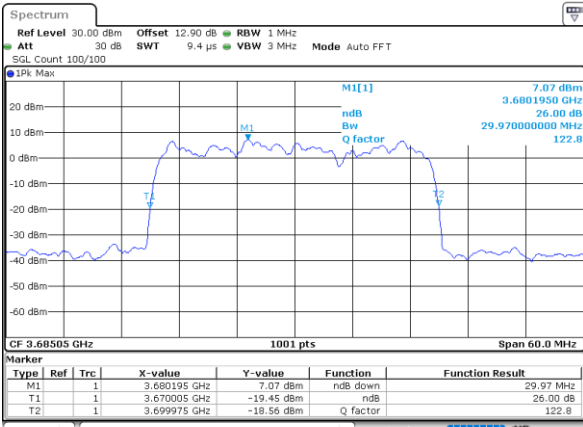

Date: 30.OCT.2020 15:32:25

Highest Channel / 20MHz+15MHz

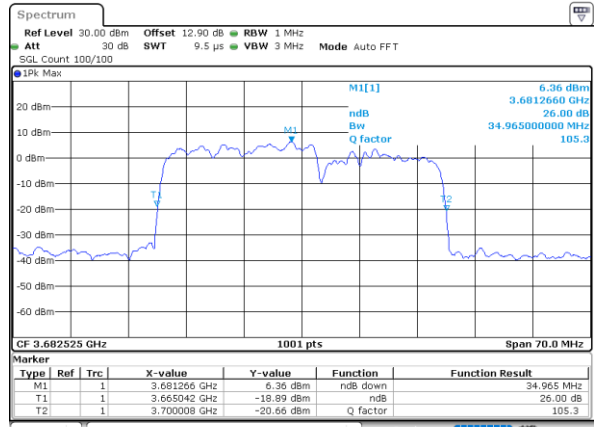

Date: 30.OCT.2020 00:26:37



LTE Band 48C

256QAM

Lowest Channel / 20MHz+20MHz

N/A

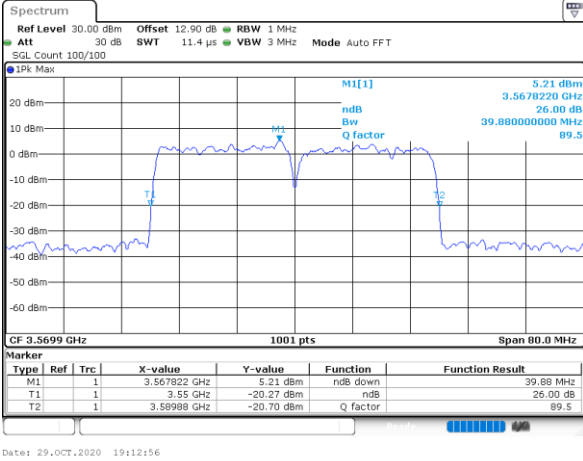

Date: 29.OCT.2020 19:12:56

Middle Channel / 20MHz+20MHz

N/A

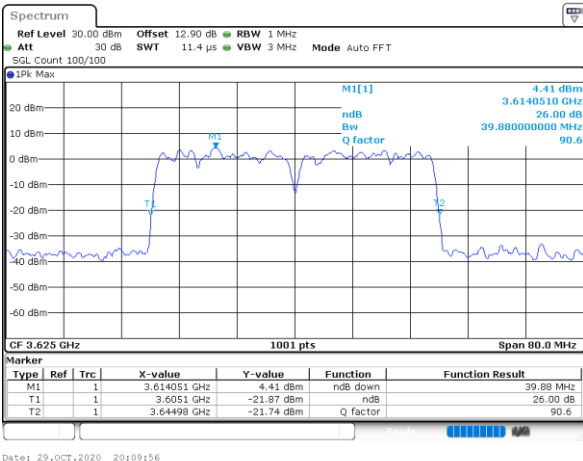

Date: 29.OCT.2020 20:09:56

Highest Channel / 20MHz+20MHz

N/A

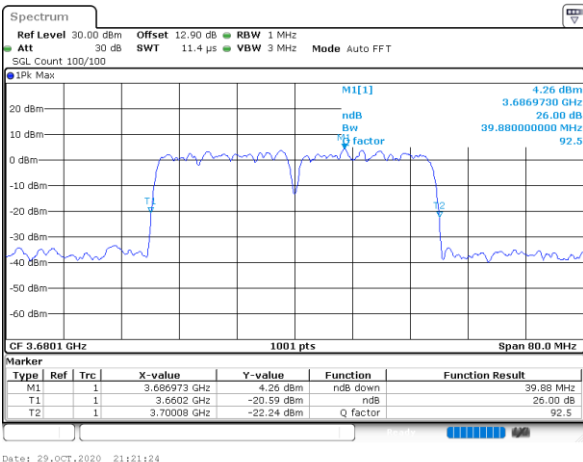

Date: 29.OCT.2020 21:21:24



Occupied Bandwidth

Mode	LTE Band 48C : 99%OBW(MHz)			
QPSK				
BW	5MHz+20MHz	10MHz+20MHz	15MHz+20MHz	20MHz+5MHz
Lowest CH	23.08	27.93	32.80	23.08
Middle CH	23.28	27.99	32.73	23.28
Highest CH	23.18	27.69	32.73	23.13
BW	20MHz+10MHz	20MHz+15MHz	20MHz+20MHz	N/A
Lowest CH	28.05	32.94	37.88	-
Middle CH	27.63	32.59	37.64	-
Highest CH	27.99	32.94	37.80	-

Mode	LTE Band 48C : 99%OBW(MHz)			
16QAM				
BW	5MHz+20MHz	10MHz+20MHz	15MHz+20MHz	20MHz+5MHz
Lowest CH	22.88	27.57	32.59	23.28
Middle CH	23.33	28.05	32.73	23.38
Highest CH	23.38	27.93	32.31	23.28
BW	20MHz+10MHz	20MHz+15MHz	20MHz+20MHz	N/A
Lowest CH	28.05	32.73	37.72	-
Middle CH	27.75	32.94	37.56	-
Highest CH	27.81	32.66	37.80	-

Mode	LTE Band 48C : 99%OBW(MHz)			
64QAM				
BW	5MHz+20MHz	10MHz+20MHz	15MHz+20MHz	20MHz+5MHz
Lowest CH	22.98	27.81	32.94	23.08
Middle CH	23.18	27.75	32.59	23.28
Highest CH	22.98	27.45	32.66	23.13
BW	20MHz+10MHz	20MHz+15MHz	20MHz+20MHz	N/A
Lowest CH	27.87	32.73	37.56	-
Middle CH	27.99	32.59	37.72	-
Highest CH	28.05	32.87	37.88	-



Mode	LTE Band 48C : 99%OBW(MHz)			
256QAM				
BW	5MHz+20MHz	10MHz+20MHz	15MHz+20MHz	20MHz+5MHz
Lowest CH	23.23	27.93	32.80	23.03
Middle CH	22.93	27.87	32.94	23.08
Highest CH	23.08	28.29	32.94	22.98
BW	20MHz+10MHz	20MHz+15MHz	20MHz+20MHz	N/A
Lowest CH	27.87	32.52	37.88	-
Middle CH	27.81	32.80	37.64	-
Highest CH	27.75	33.01	37.72	-



LTE Band 48C

QPSK

Lowest Channel / 5MHz+20MHz

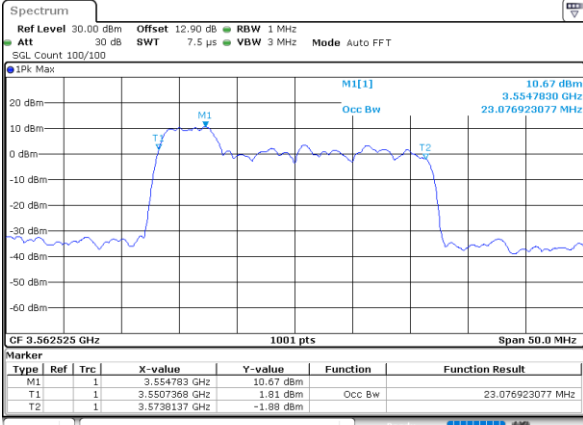

Date: 30.OCT.2020 23:25:10

Lowest Channel / 10MHz+20MHz

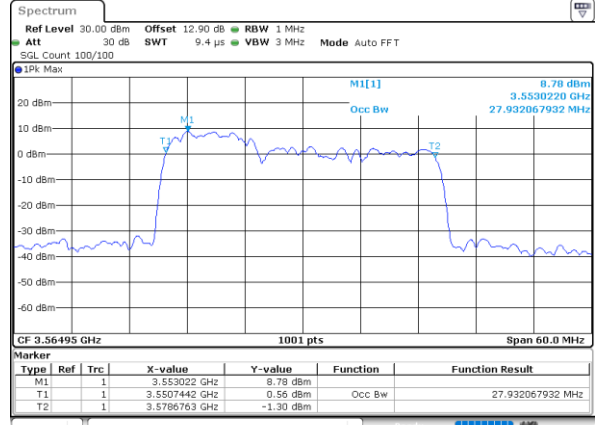

Date: 30.OCT.2020 15:42:07

Middle Channel / 5MHz+20MHz

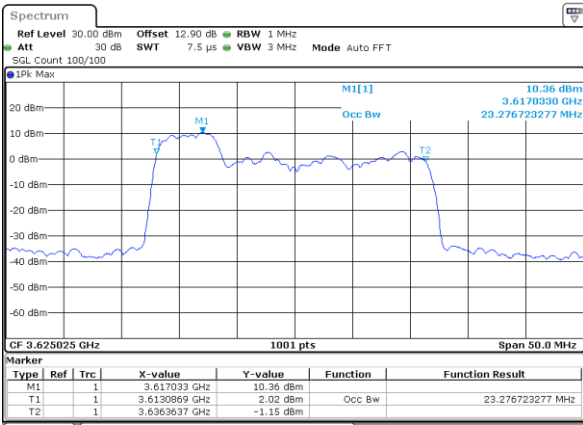

Date: 31.OCT.2020 00:26:00

Middle Channel / 10MHz+20MHz

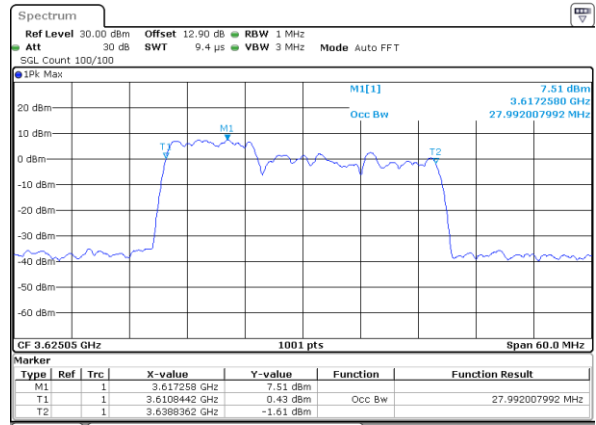

Date: 30.OCT.2020 17:27:48

Highest Channel / 5MHz+20MHz

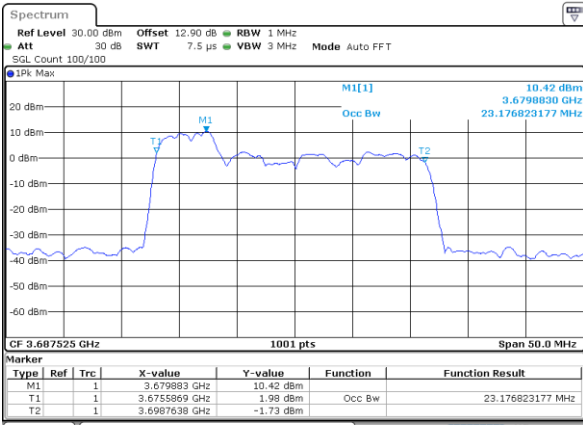

Date: 31.OCT.2020 00:34:19

Highest Channel / 10MHz+20MHz

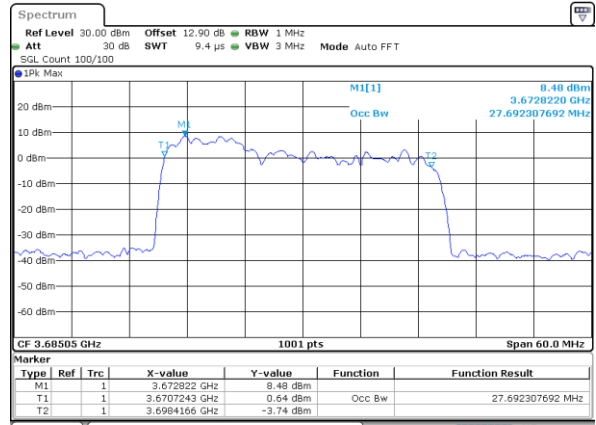

Date: 30.OCT.2020 17:40:53



LTE Band 48C

QPSK

Lowest Channel / 15MHz+20MHz

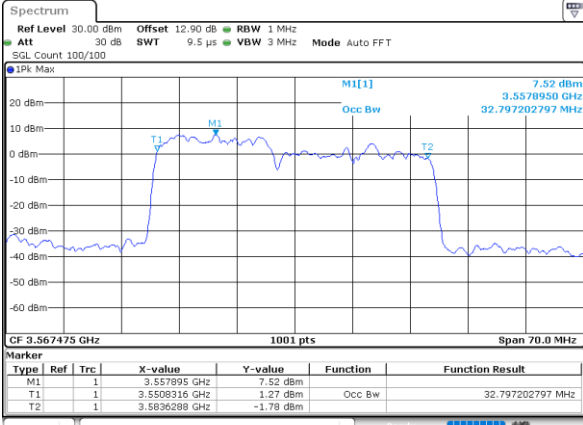

Date: 30.OCT.2020 01:35:12

Lowest Channel / 20MHz+5MHz

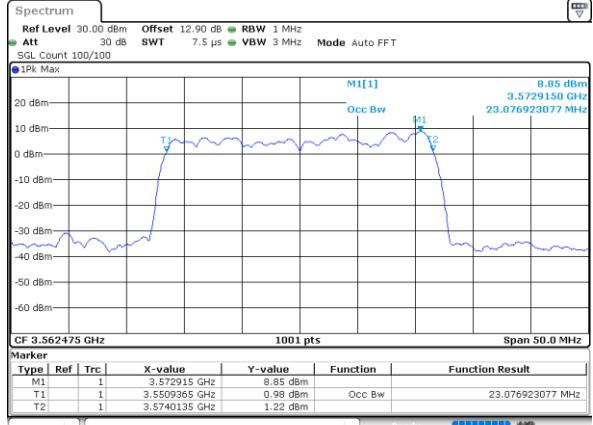

Date: 30.OCT.2020 19:40:59

Middle Channel / 15MHz+20MHz

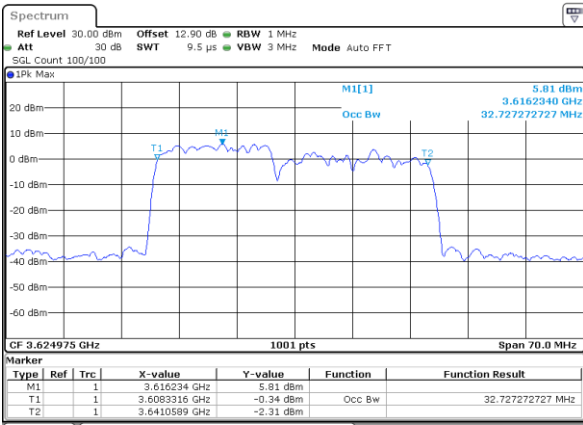

Date: 30.OCT.2020 09:56:50

Middle Channel / 20MHz+5MHz

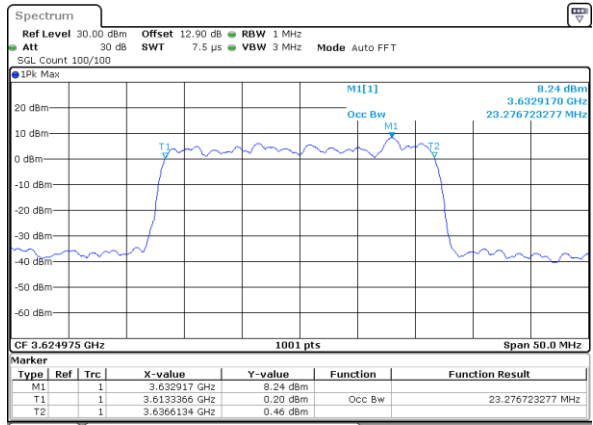

Date: 30.OCT.2020 21:01:37

Highest Channel / 15MHz+20MHz

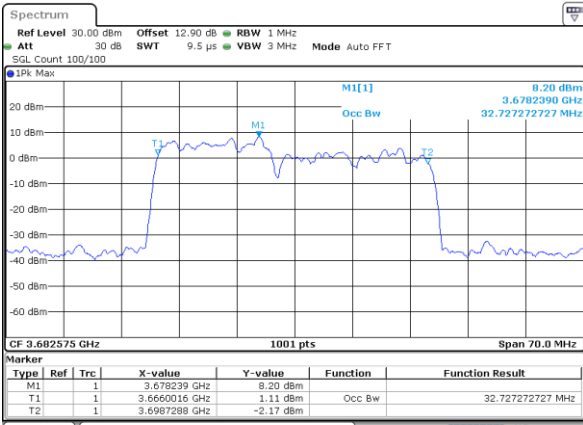

Date: 30.OCT.2020 10:23:54

Highest Channel / 20MHz+5MHz

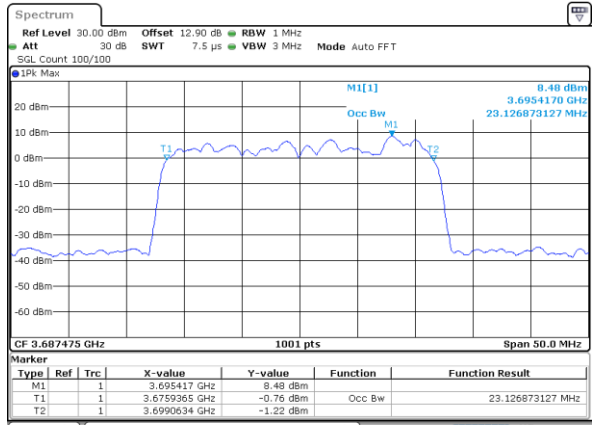

Date: 30.OCT.2020 22:01:22



LTE Band 48C

QPSK

Lowest Channel / 20MHz+10MHz

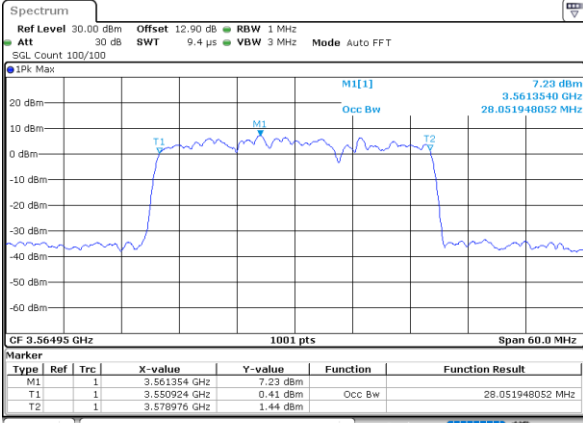

Date: 30.OCT.2020 13:42:54

Lowest Channel / 20MHz+15MHz

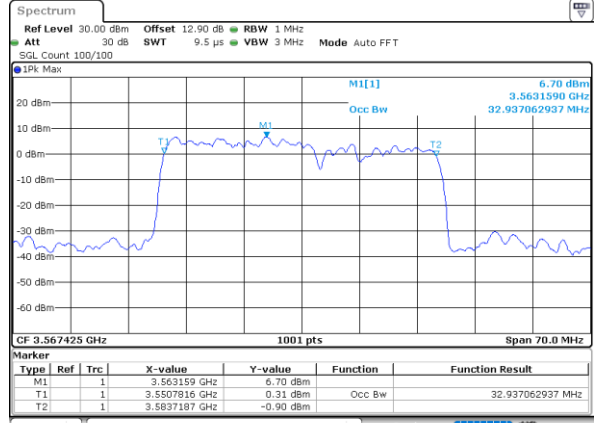

Date: 29.OCT.2020 22:25:22

Middle Channel / 20MHz+10MHz

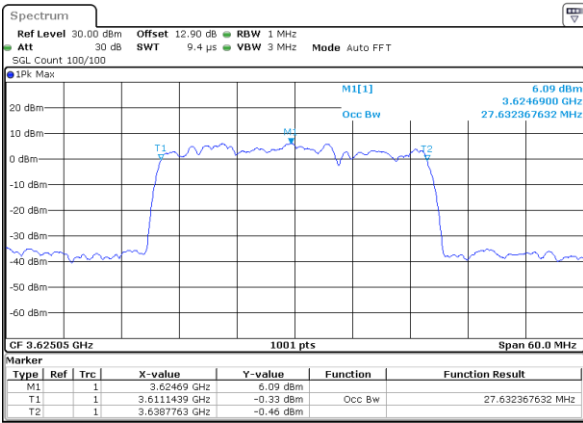

Date: 30.OCT.2020 13:52:21

Middle Channel / 20MHz+15MHz

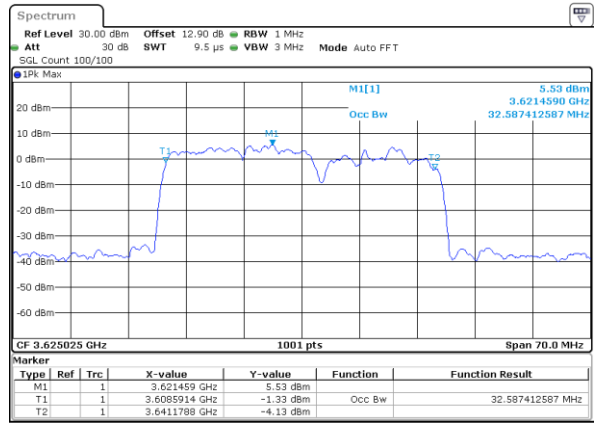

Date: 29.OCT.2020 23:28:01

Highest Channel / 20MHz+10MHz

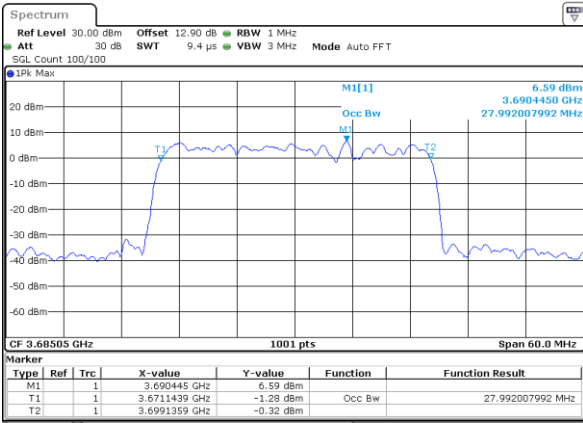

Date: 30.OCT.2020 15:30:33

Highest Channel / 20MHz+15MHz

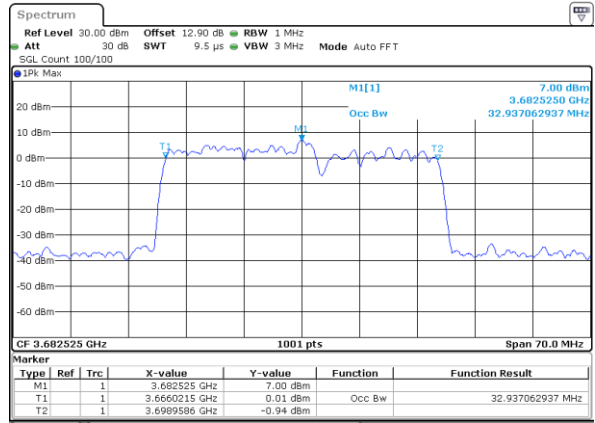

Date: 30.OCT.2020 00:24:45



LTE Band 48C

QPSK

Lowest Channel / 20MHz+20MHz

N/A

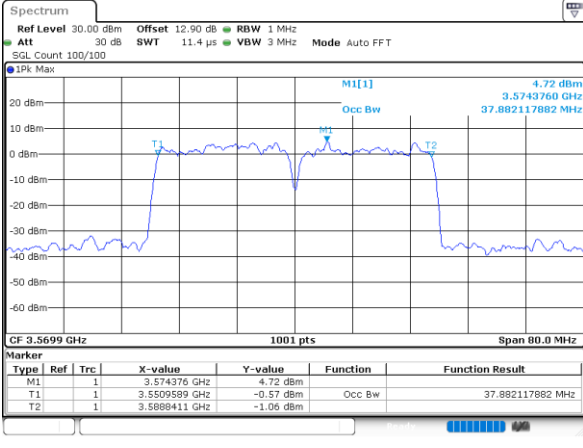

Date: 29.OCT.2020 19:11:26

Middle Channel / 20MHz+20MHz

N/A

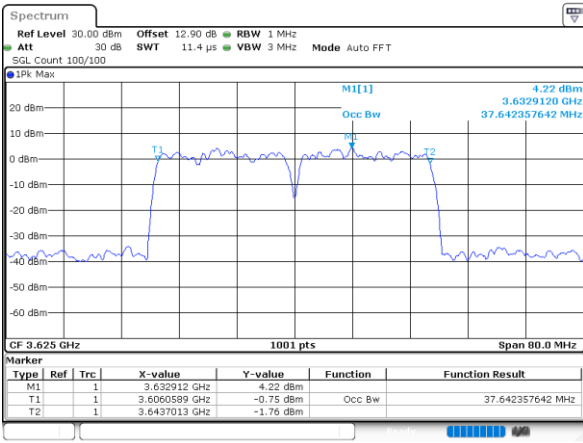

Date: 29.OCT.2020 20:08:27

Highest Channel / 20MHz+20MHz

N/A

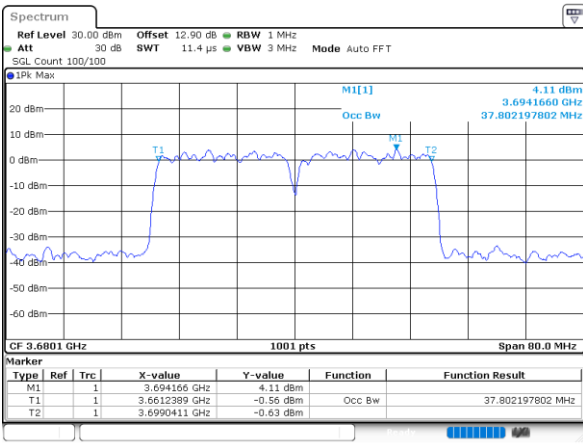

Date: 29.OCT.2020 21:19:32



LTE Band 48C

16QAM

Lowest Channel / 5MHz+20MHz

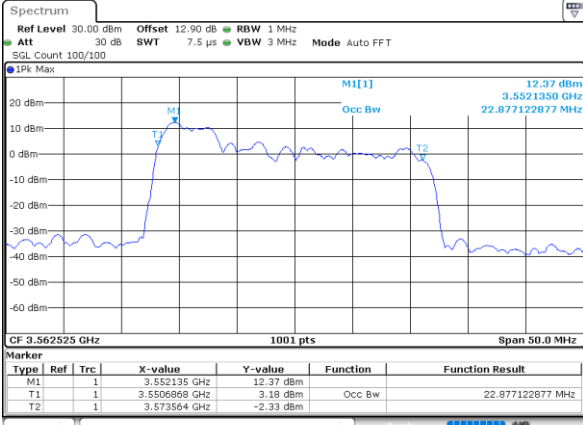

Date: 30.OCT.2020 23:25:32

Lowest Channel / 10MHz+20MHz

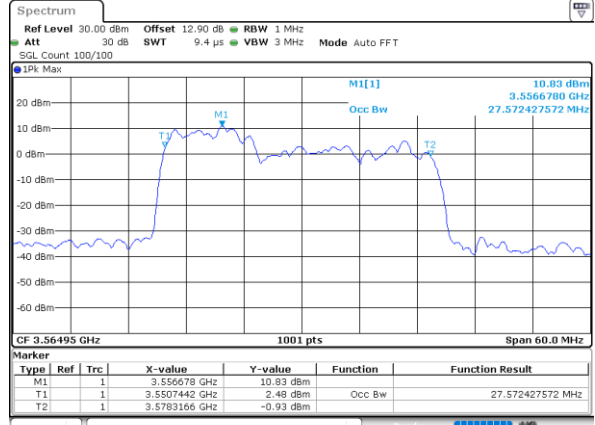

Date: 30.OCT.2020 15:42:30

Middle Channel / 5MHz+20MHz

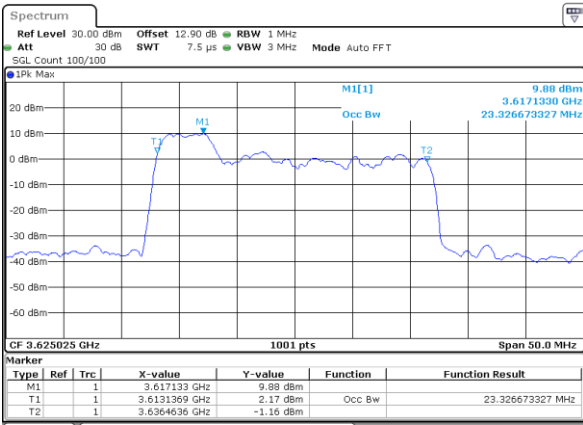

Date: 31.OCT.2020 00:26:22

Middle Channel / 10MHz+20MHz

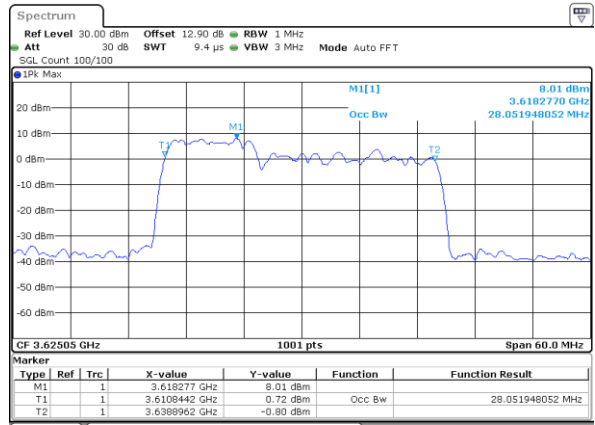

Date: 30.OCT.2020 17:28:11

Highest Channel / 5MHz+20MHz

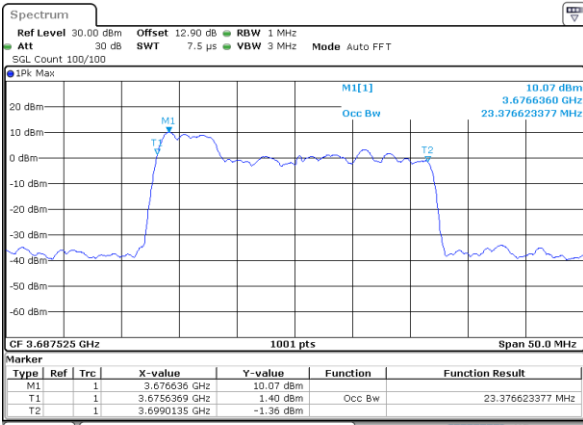

Date: 31.OCT.2020 00:33:57

Highest Channel / 10MHz+20MHz

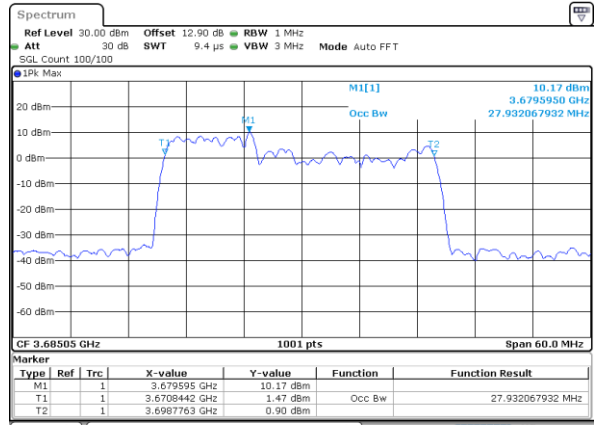

Date: 30.OCT.2020 17:48:30



LTE Band 48C

16QAM

Lowest Channel / 15MHz+20MHz

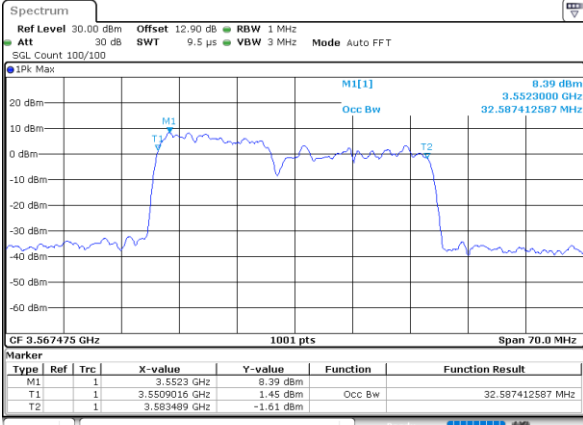

Date: 30.OCT.2020 01:35:34

Lowest Channel / 20MHz+5MHz

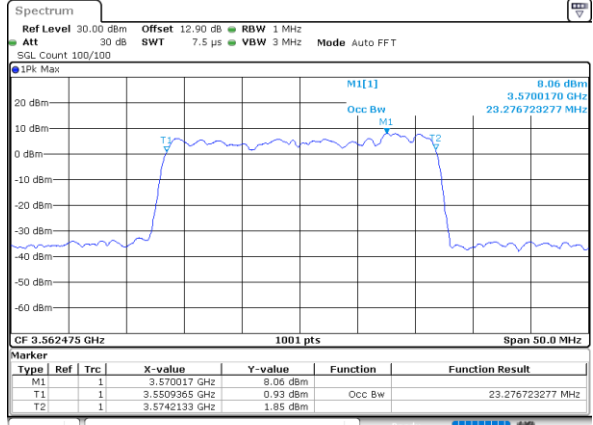

Date: 30.OCT.2020 19:41:21

Middle Channel / 15MHz+20MHz

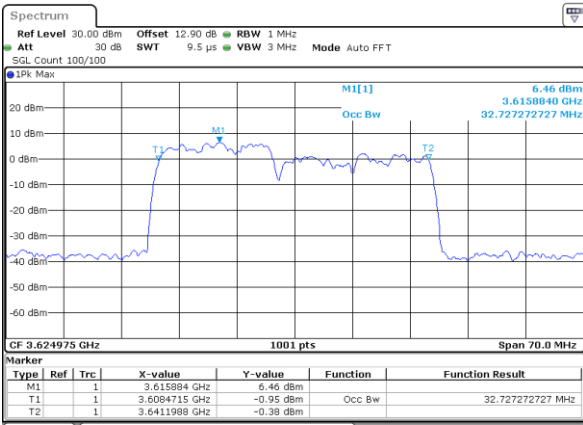

Date: 30.OCT.2020 09:57:13

Middle Channel / 20MHz+5MHz

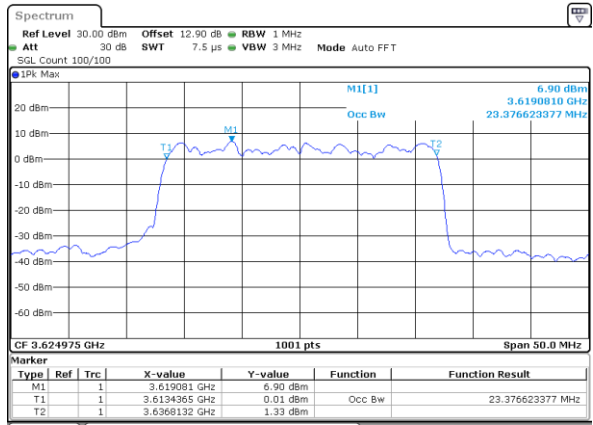

Date: 30.OCT.2020 21:02:00

Highest Channel / 15MHz+20MHz

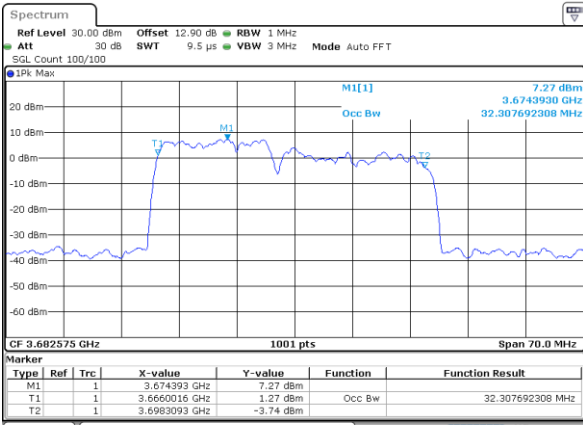

Date: 30.OCT.2020 10:23:32

Highest Channel / 20MHz+5MHz

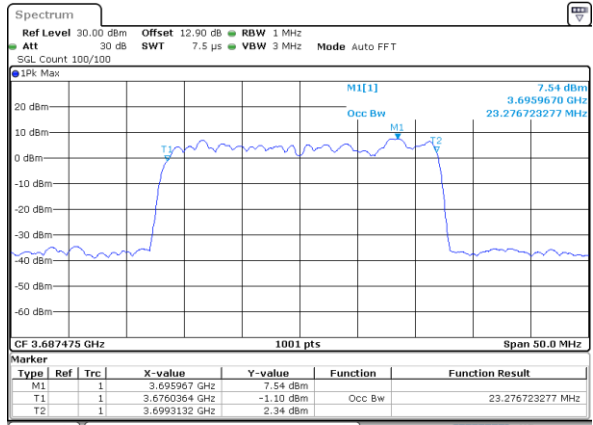

Date: 30.OCT.2020 22:01:00



LTE Band 48C

16QAM

Lowest Channel / 20MHz+10MHz

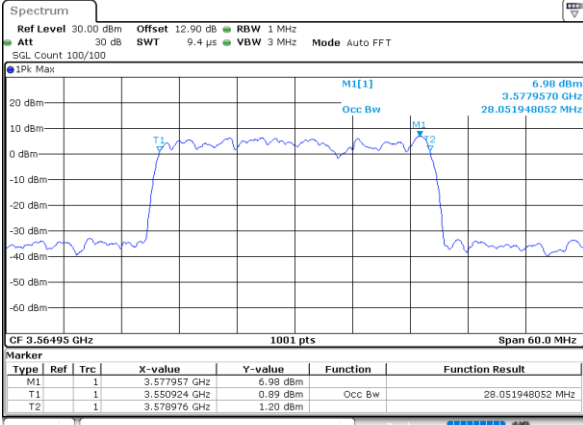

Date: 30.OCT.2020 13:43:17

Lowest Channel / 20MHz+15MHz

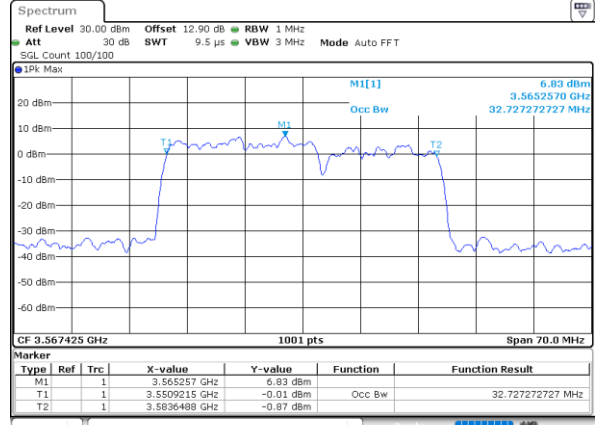

Date: 29.OCT.2020 22:25:44

Middle Channel / 20MHz+10MHz

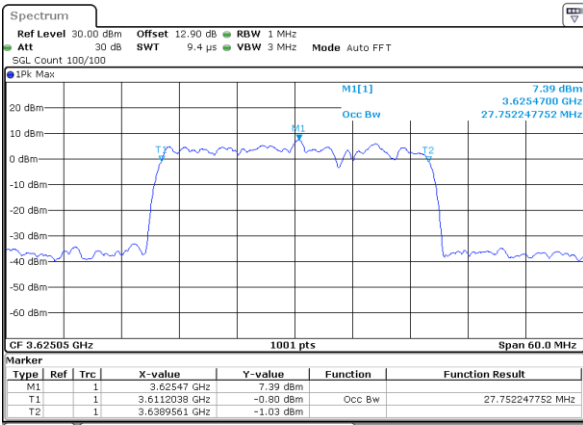

Date: 30.OCT.2020 13:52:44

Middle Channel / 20MHz+15MHz

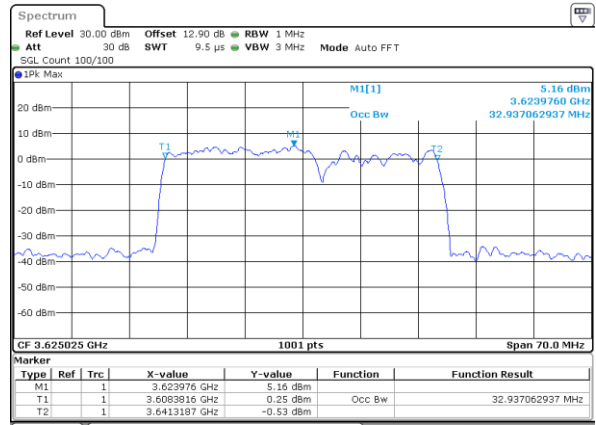

Date: 29.OCT.2020 23:28:24

Highest Channel / 20MHz+10MHz

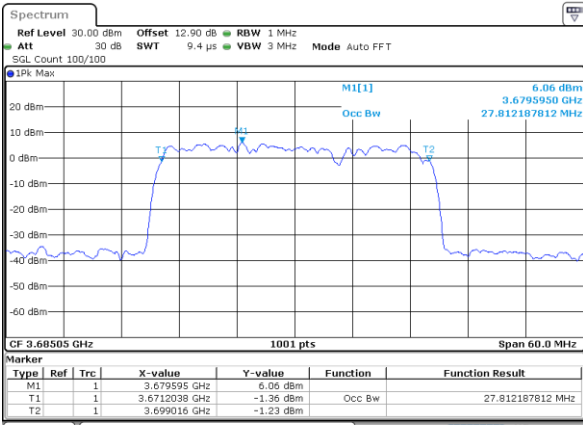

Date: 30.OCT.2020 15:30:11

Highest Channel / 20MHz+15MHz

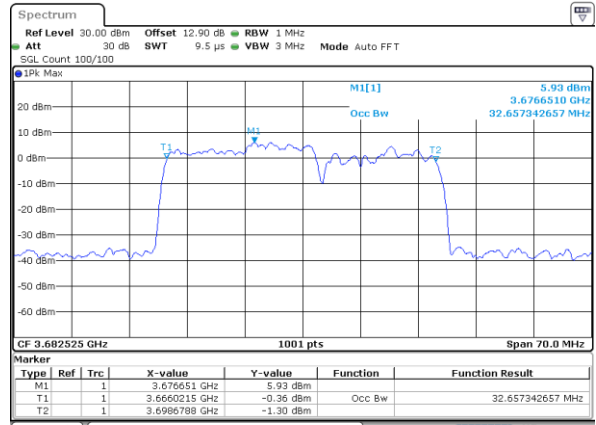

Date: 30.OCT.2020 00:24:23



LTE Band 48C

16QAM

Lowest Channel / 20MHz+20MHz

N/A

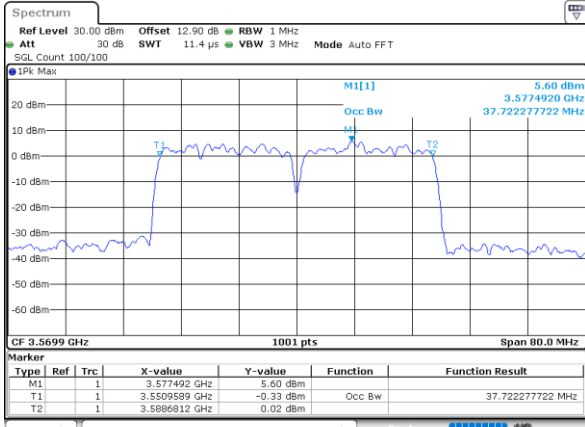

Date: 29.OCT.2020 19:11:49

Middle Channel / 20MHz+20MHz

N/A

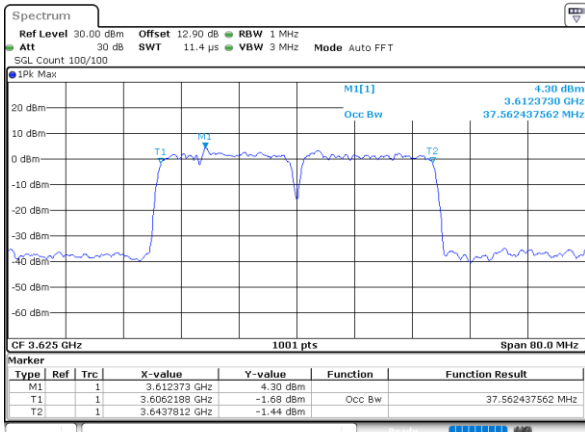

Date: 29.OCT.2020 20:08:50

Highest Channel / 20MHz+20MHz

N/A

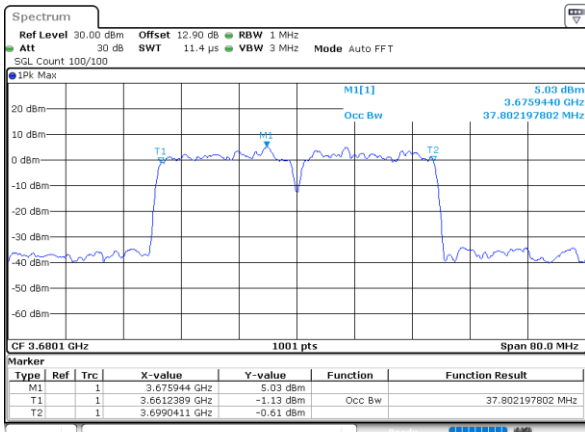

Date: 29.OCT.2020 21:19:09