



FCC RADIO TEST REPORT

FCC ID : PKRISGFW3000
Equipment : Outdoor Fixed CPE
Brand Name : Inseego
Model Name : FW3000
Marketing Name : FW3000
Applicant : Inseego Corp.
9710 Scranton Road Suite 200, San Diego, CA 92121
Manufacturer : Inseego Corp.
9710 Scranton Road Suite 200, San Diego, CA 92121
Standard : FCC 47 CFR Part 2, 22(H), 24(E), 27

The product was received on Jul. 24, 2023 and testing was performed from Jul. 25, 2023 to Sep. 23, 2023. We, Sporton International Inc. EMC & Wireless Communications Laboratory, would like to declare that the tested sample has been evaluated in accordance with the test procedures given in ANSI / TIA-603-E and has been in compliance with the applicable technical standards.

The test results in this report apply exclusively to the tested model / sample. Without written approval from Sporton International Inc. EMC & Wireless Communications Laboratory, the test report shall not be reproduced except in full.

Louis Wu

Approved by: Louis Wu

Sporton International Inc. EMC & Wireless Communications Laboratory

No. 52, Huaya 1st Rd., Guishan Dist., Taoyuan City 333, Taiwan (R.O.C.)



Table of Contents

History of this test report..... 3

Summary of Test Result..... 4

1 General Description 6

 1.1 Product Feature of Equipment Under Test..... 6

 1.2 Modification of EUT 6

 1.3 Testing Location 7

 1.4 Applicable Standards..... 8

2 Test Configuration of Equipment Under Test 9

 2.1 Test Mode..... 9

 2.2 Connection Diagram of Test System..... 10

 2.3 Support Unit used in test configuration and system 10

 2.4 Measurement Results Explanation Example..... 10

 2.5 Frequency List of Low/Middle/High Channels 11

3 Conducted Test Items..... 15

 3.1 Measuring Instruments 15

 3.2 Conducted Output Power and ERP/EIRP 16

 3.3 Peak-to-Average Ratio 18

 3.4 Occupied Bandwidth..... 19

 3.5 Conducted Band Edge 20

 3.6 Conducted Spurious Emission 22

 3.7 Frequency Stability 23

4 Radiated Test Items 24

 4.1 Measuring Instruments 24

 4.2 Radiated Spurious Emission Measurement 26

5 List of Measuring Equipment..... 27

6 Measurement Uncertainty 29

Appendix A. Test Results of Conducted Test

Appendix B. Test Results of Radiated Test

Appendix C. Test Setup Photographs



History of this test report

Report No.	Version	Description	Issue Date
FG320711B	01	Initial issue of report	Oct. 04, 2023
FG320711B	02	Revise appendix A and Section 3.2.1 This report is an updated version, replacing the report issued on Oct. 04, 2023.	Nov. 08, 2023



Summary of Test Result

Report Clause	Ref Std. Clause	Test Items	Result (PASS/FAIL)	Remark
3.2	§2.1046	Conducted Output Power	Reporting only	-
	§22.913 (a)(5)	Effective Radiated Power (n5) (n26)	Pass	
	§27.50 (c)(3)	Effective Radiated Power (n12) (n71)		
	§24.232 (c) §27.50 (h)(2)	Equivalent Isotropic Radiated Power (n2) (n25)(n41)		
	§27.50 (d)(4)	Equivalent Isotropic Radiated Power (n66)		
3.3	§24.232 (d) §27.50 (d)(5)	Peak-to-Average Ratio	Pass	-
3.4	§2.1049	Occupied Bandwidth	Reporting only	-
3.5	§2.1051 §22.917 (a) §24.238 (a) §27.53 (g) §27.53 (h)	Conducted Band Edge Measurement (n2) (n5) (n12) (n25) (n26) (n66) (n71)	Pass	-
	§2.1051 §27.53 (m)(2)(v)	Conducted Band Edge Measurement (n41)		
3.6	§2.1051 §22.917 (a) §24.238 (a) §27.53 (g) §27.53 (h)	Conducted Spurious Emission (n2) (n5) (n12) (n25) (n26) (n66) (n71)	Pass	-
	§2.1051 §27.53 (m)(2)(v)	Conducted Spurious Emission (n41)		
3.7	§2.1055 §22.355 §24.235 §27.54	Frequency Stability Temperature & Voltage	Pass	-



Report Clause	Ref Std. Clause	Test Items	Result (PASS/FAIL)	Remark
4.2	§2.1053 §22.917 (a) §24.238 (a) §27.53 (g) §27.53 (h)	Radiated Spurious Emission (n2) (n5) (n12) (n25) (n26) (n66) (n71)	Pass	6.81 dB under the limit at 7490.00 MHz
	§2.1051 §27.53 (m)(2)(v)	Radiated Spurious Emission (n41)		

Conformity Assessment Condition:

1. The test results (PASS/FAIL) with all measurement uncertainty excluded are presented against the regulation limits or in accordance with the requirements stipulated by the applicant/manufacture who shall bear all the risks of non-compliance that may potentially occur if measurement uncertainty is taken into account.
2. The measurement uncertainty please refer to each test result in the section "Measurement Uncertainty".

Disclaimer:

The product specifications of the EUT presented in the test report that may affect the test assessments are declared by the manufacturer who shall take full responsibility for the authenticity.

Reviewed by: Avis Chuang

Report Producer: Lucy Wu



1 General Description

1.1 Product Feature of Equipment Under Test

Product Feature	
General Specs 4G-LTE, 5G-FR1, Bluetooth-LE, and GNSS.	
Antenna Type WWAN: Fixed Internal Antenna Bluetooth-LE: Fixed Internal Antenna GPS / Glonass / BDS / Galileo: Fixed Internal Antenna	

Support Band and Evaluated Information	
Supported Band	n2, n5, n12, n25, n26, n41, n66, n71
Evaluated and Tested Band	n12, n25, n26, n41, n66, n71
Band Covered Information	Wider operating frequency band range covers narrower one when the power is worse as follows: <ul style="list-style-type: none"> ■ n26 cover n5 (Part 22) ■ n25 cover n2 (Part 24)

TDD Band Power Class					
	PC3	PC2	PC3 MIMO	PC2 MIMO	PC1.5 MIMO
n41	V	V	V	V	

Antenna Information								
Band	Ant0	Ant1	Ant4	Ant6	Ant12	Ant13	Main Ant. #	Secondary Ant. #
n2					5.0	4.7	13	12
n5	3.4	3.5					0	1
n12	2.4						0	
n25					5.0	4.7	13	12
n26	3.4						0	
n41					5.5	5.4	12	13
n66					5.0	4.9	13	12
n71	2.2						0	

Remark: The EUT's information above is declared by manufacturer. Please refer to Disclaimer in report summary.

1.2 Modification of EUT

No modifications made to the EUT during the testing.



1.3 Testing Location

Test Site	Sporton International Inc. EMC & Wireless Communications Laboratory
Test Site Location	No.52, Huaya 1st Rd., Guishan Dist., Taoyuan City 333, Taiwan (R.O.C.) TEL: +886-3-327-3456 FAX: +886-3-328-4978
Test Site No.	Sporton Site No. TH03-HY
Test Engineer	Luffy Lin and George Chen
Temperature (°C)	22~24
Relative Humidity (%)	51~56

Test Site	Sporton International Inc. Wensan Laboratory
Test Site Location	No.58, Aly. 75, Ln. 564, Wenhua 3rd, Rd., Guishan Dist., Taoyuan City 333010, Taiwan (R.O.C.) TEL: +886-3-327-0868 FAX: +886-3-327-0855
Test Site No.	Sporton Site No. 03CH13-HY (TAF Code: 3786)
Test Engineer	Rain Lee, Jacky Hong and Mancy Chou
Temperature (°C)	20~26
Relative Humidity (%)	40~65
Remark	The Radiated Spurious Emission test item subcontracted to Sporton International Inc. Wensan Laboratory.

Note: The test site complies with ANSI C63.4 2014 requirement.

FCC Designation No.: TW1190 and TW3786



1.4 Applicable Standards

According to the specifications declared by the manufacturer, the EUT must comply with the requirements of the following standards:

- ♦ ANSI C63.26-2015
- ♦ ANSI / TIA-603-E
- ♦ FCC 47 CFR Part 2, 22(H), 24(E), 27
- ♦ FCC KDB 971168 D01 Power Meas. License Digital Systems v03r01
- ♦ FCC KDB 412172 D01 Determining ERP and EIRP v01r01
- ♦ FCC KDB 414788 D01 Radiated Test Site v01r01.
- ♦ FCC KDB 662911 D01 Multiple Transmitter Output v02r01.

Remark:

1. All the test items were validated and recorded in accordance with the standards without any modification during the testing.
2. This EUT has also been tested and complied with the requirements of FCC Part 15, Subpart B, recorded in a separate test report.
3. The TAF code is not including all the FCC KDB listed without accreditation.



2 Test Configuration of Equipment Under Test

2.1 Test Mode

Antenna port conducted and radiated test items listed below are performed according to KDB 971168 D01 Power Meas. License Digital Systems v03r01 with maximum output power.

For radiated measurement, the measured emission level of the EUT was maximized by rotating the EUT on a turntable, adjusting the orientation of the EUT and EUT antenna in three orthogonal axis (X: flat, Y: portrait, Z: landscape), and adjusting the measurement antenna orientation, following C63.26 exploratory test procedures and only the worst case emissions were reported in this report.

Modulation Type	Modulation	Modulation Type	Modulation
A	DFT-s-OFDM pi/2 BPSK	N/A	N/A
B	DFT-s-OFDM QPSK	F	CP-OFDM QPSK
C	DFT-s-OFDM 16QAM	G	CP-OFDM 16QAM
D	DFT-s-OFDM 64QAM	H	CP-OFDM 64QAM
E	DFT-s-OFDM 256QAM	I	CP-OFDM 256QAM

Test Item	Modulation Type	Bandwidth	RB Size	Channel
Conducted Power	A, B, C, D, E	All	1, Half, Full	L, M, H
EIRP	A, B, C, D, E	All	1, Half, Full	L, M, H
PAR	A, B, C, D, E	20 MHz or less	Outer_Full	M
Bandwidth	A, F, G, H, I	All	Outer_Full	M
CBE,	A, B, C, D, E, F	All	Outer_1RB Outer_Full	L, H
CSE	B	Minimum	Inner_1RB	L, M, H
Frequency Stability	A	20 MHz or less	Outer_Full	M
RSE	A	20 MHz or less	Inner_1RB	L, M, H

Remark:

1. Evaluated all the transmitter signal and reporting worst-case configuration among all modulation types.
2. The device is investigated from 30MHz to 10 times of fundamental signal for radiated spurious emission test under different RB size/offset and modulations in exploratory test. Subsequently, only the worst-case emissions are reported.
3. For 5G NR test combination are EN-DC 2A_n5A, EN-DC 48A_n5A, EN-DC 66A_n5A, EN-DC 12A_n25A, EN-DC 66A_n25A, EN-DC 4A_n2A, EN-DC 5A_n2A, EN-DC 12A_n2A, EN-DC 13A_n2A, EN-DC 66A_n2A, EN-DC 2A_n66A, EN-DC 5A_n66A, EN-DC 12A_n66A, EN-DC 13A_n66A, EN-DC 48A_n66A, EN-DC 2A_n12A, EN-DC 48A_n12A, EN-DC 66A_n12A, EN-DC 2A_n41A, EN-DC 66A_n41A, EN-DC 2A_n71A, EN-DC 48A_n71A, and EN-DC 66A_n71A.

2.2 Connection Diagram of Test System

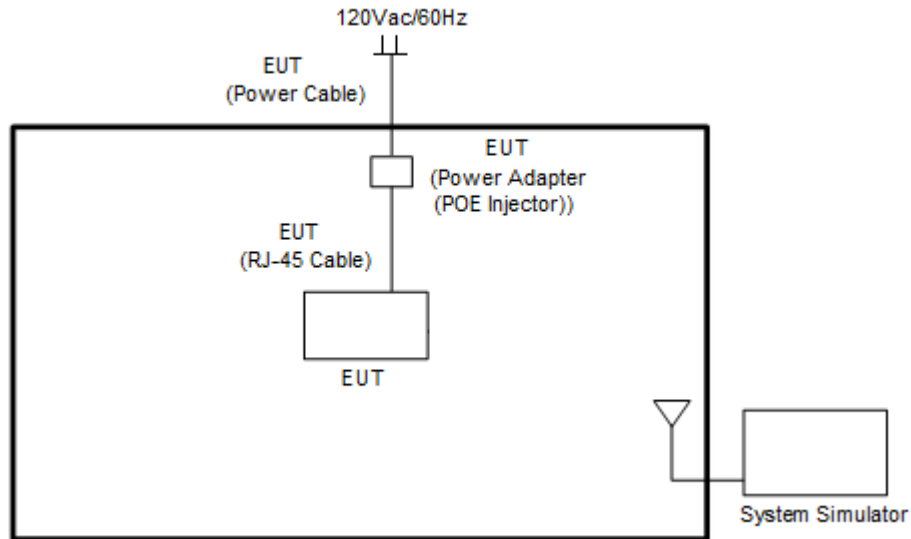

2.3 Support Unit used in test configuration and system

Item	Equipment	Brand Name	Model No.	FCC ID	Data Cable	Power Cord
1.	System Simulator	Anritsu	MT8821C	N/A	N/A	Unshielded, 1.8 m
2.	5G Wireless Test Platform	Anritsu	MT8000A	N/A	N/A	Unshielded, 1.8 m

2.4 Measurement Results Explanation Example

For all conducted test items:

The offset level is set in the spectrum analyzer to compensate the RF cable loss and attenuator factor between EUT conducted output port and spectrum analyzer. With the offset compensation, the spectrum analyzer reading level is exactly the EUT RF output level.

The spectrum analyzer offset is derived from RF cable loss and attenuator factor.

Offset = RF cable loss + attenuator factor.

Following shows an offset computation example with cable loss 4.2 dB and 10dB attenuator.

Example :

$$\begin{aligned} \text{Offset(dB)} &= \text{RF cable loss(dB)} + \text{attenuator factor(dB)}. \\ &= 4.2 + 10 = 14.2 \text{ (dB)} \end{aligned}$$



2.5 Frequency List of Low/Middle/High Channels

5G NR n2 Channel and Frequency List				
BW [MHz]	Channel/Frequency(MHz)	Lowest	Middle	Highest
20	Channel	372000	376000	380000
	Frequency	1860	1880	1900
15	Channel	371500	376000	380500
	Frequency	1857.5	1880	1902.5
10	Channel	371000	376000	381000
	Frequency	1855	1880	1905
5	Channel	370500	376000	381500
	Frequency	1852.5	1880	1907.5

5G NR n5 Channel and Frequency List				
BW [MHz]	Channel/Frequency(MHz)	Lowest	Middle	Highest
20	Channel	166800	167300	167800
	Frequency	834	836.5	839
15	Channel	166300	167300	168300
	Frequency	831.5	836.5	841.5
10	Channel	165800	167300	168800
	Frequency	829	836.5	844
5	Channel	165300	167300	169300
	Frequency	826.5	836.5	846.5

5G NR n12 Channel and Frequency List				
BW [MHz]	Channel/Frequency(MHz)	Lowest	Middle	Highest
15	Channel	141300	141500	141700
	Frequency	706.5	707.5	708.5
10	Channel	140800	141500	142200
	Frequency	704	707.5	711
5	Channel	140300	141500	142700
	Frequency	701.5	707.5	713.5



5G NR n25 Channel and Frequency List				
BW [MHz]	Channel/Frequency(MHz)	Lowest	Middle	Highest
40	Channel	374000	376500	379000
	Frequency	1870	1882.5	1895
35	Channel	373500	376500	379500
	Frequency	1867.5	1882.5	1897.5
30	Channel	373000	376500	380000
	Frequency	1865	1882.5	1900
25	Channel	372500	376500	380500
	Frequency	1862.5	1882.5	1902.5
20	Channel	372000	376500	381000
	Frequency	1860	1882.5	1905
15	Channel	371500	376500	381500
	Frequency	1857.5	1882.5	1907.5
10	Channel	371000	376500	382000
	Frequency	1855	1882.5	1910
5	Channel	370500	376500	382500
	Frequency	1852.5	1882.5	1912.5

5G NR n26 Channel and Frequency List				
BW [MHz]	Channel/Frequency(MHz)	Lowest	Middle	Highest
20	Channel	166800	167300	167800
	Frequency	834	836.5	839
15	Channel	166300	167300	168300
	Frequency	831.5	836.5	841.5
10	Channel	165800	167300	168800
	Frequency	829	836.5	844
5	Channel	165300	167300	169300
	Frequency	826.5	836.5	846.5



5G NR n41 Channel and Frequency List				
BW [MHz]	Channel/Frequency(MHz)	Lowest	Middle	Highest
100	Channel	509202	518598	528000
	Frequency	2546.01	2592.99	2640
90	Channel	508200	518598	528996
	Frequency	2541	2592.99	2644.98
80	Channel	507204	518598	529998
	Frequency	2536.02	2592.99	2649.99
70	Channel	506202	518598	531000
	Frequency	2531.01	2592.99	2655
60	Channel	505200	518598	531996
	Frequency	2526	2592.99	2659.98
50	Channel	504204	518598	532998
	Frequency	2521.02	2592.99	2664.99
40	Channel	503202	518598	534000
	Frequency	2516.01	2592.99	2670
30	Channel	502200	518598	534996
	Frequency	2511	2592.99	2674.98
20	Channel	501204	518598	535998
	Frequency	2506.02	2592.99	2679.99
15	Channel	500700	518598	536496
	Frequency	2503.5	2592.99	2682.48
10	Channel	500202	518598	537000
	Frequency	2501.01	2592.99	2685



5G NR n66 Channel and Frequency List				
BW [MHz]	Channel/Frequency(MHz)	Lowest	Middle	Highest
40	Channel	346000	346500	347000
	Frequency	1730	1733	1735
35	Channel	345500	346500	347500
	Frequency	1727.5	1732.5	1737.5
30	Channel	345000	346500	348000
	Frequency	1725	1732.5	1740
25	Channel	344500	346500	348500
	Frequency	1722.5	1732.5	1742.5
20	Channel	344000	346500	349000
	Frequency	1720	1732.5	1745
15	Channel	343500	346500	349500
	Frequency	1717.5	1732.5	1747.5
10	Channel	343000	346500	350000
	Frequency	1715	1732.5	1750
5	Channel	342500	346500	350500
	Frequency	1712.5	1732.5	1752.5

5G NR n71 Channel and Frequency List				
BW [MHz]	Channel/Frequency(MHz)	Lowest	Middle	Highest
20	Channel	134600	136100	137600
	Frequency	673	680.5	688
15	Channel	134100	136100	138100
	Frequency	670.5	680.5	690.5
10	Channel	133600	136100	138600
	Frequency	668	680.5	693
5	Channel	133100	136100	139100
	Frequency	665.5	680.5	695.5

3 Conducted Test Items

3.1 Measuring Instruments

See list of measuring instruments of this test report.

3.1.1 Test Setup

3.1.2 Conducted Output Power

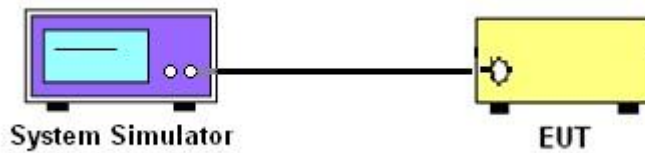

3.1.3 Peak-to-Average Ratio, Occupied Bandwidth ,Conducted Band-Edge and Conducted Spurious Emission

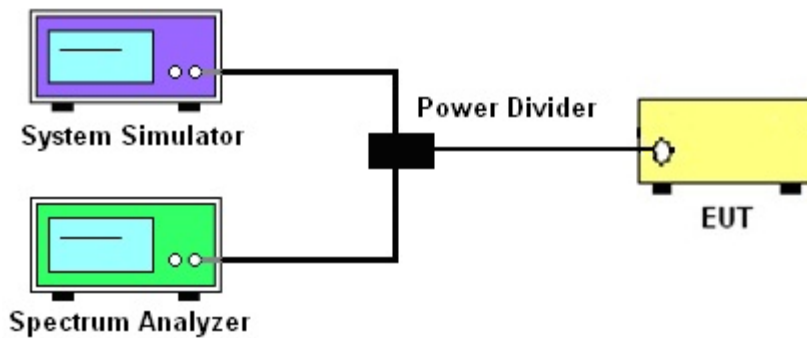

3.1.4 Frequency Stability

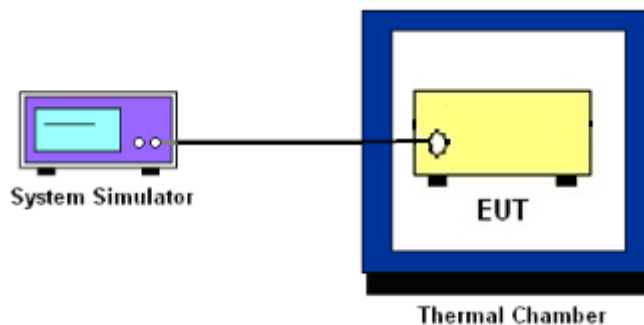

3.1.5 Test Result of Conducted Test

Please refer to Appendix A.



3.2 Conducted Output Power and ERP/EIRP

3.2.1 Description of the Conducted Output Power Measurement and ERP/EIRP Measurement

A system simulator was used to establish communication with the EUT. Its parameters were set to force the EUT transmitting at maximum output power. The measured power in the radio frequency on the transmitter output terminals shall be reported.

The ERP of mobile transmitters must not exceed 7 Watts for 5G NR n5 and n26

The ERP of transmitters must not exceed 1000 Watts for 5G NR n12 and n71

The EIRP of mobile transmitters must not exceed 2 Watts for 5G NR n2 and n25

The EIRP of transmitters must not exceed 1 Watts for 5G NR n66

The output power of transmitters must not exceed 2 Watts for 5G NR n41

According to KDB 412172 D01 Power Approach,

$$EIRP = P_T + G_T - L_C, ERP = EIRP - 2.15, \text{ where}$$

P_T = transmitter output power in dBm

G_T = gain of the transmitting antenna in dBi

L_C = signal attenuation in the connecting cable between the transmitter and antenna in dB

Remark: For MIMO mode, the calculation is following F)2)d) of KDB 662911 D01 v02r01.

d) *Unequal antenna gains, with equal transmit powers.* For antenna gains given by G_1, G_2, \dots, G_N dBi

(i) If transmit signals are *correlated*, then

$$\text{Directional gain} = 10 \log\left[\frac{(10^{G_1/20} + 10^{G_2/20} + \dots + 10^{G_N/20})^2}{N_{ANT}}\right] \text{ dBi} \text{ [Note the "20"s in the denominator of each exponent and the square of the sum of terms; the object is to combine the signal levels coherently.]}$$

(ii) If all transmit signals are *completely uncorrelated*, then

$$\text{Directional gain} = 10 \log\left[\frac{(10^{G_1/10} + 10^{G_2/10} + \dots + 10^{G_N/10})}{N_{ANT}}\right] \text{ dBi}$$

			MIMO Mode Uncorrelated NSS = 2 (dBi)
5G NR n41	Ant 12 (dBi)	Ant 13 (dBi)	
Ant. 12+13	5.50	5.40	5.46

Directional gain for Ant. 12+13 uncorrelated of MIMO mode derived from formula which is

$$10 \times \log \{ [10^{5.50} + 10^{5.40}] / 2 \} = 5.46 \text{ dB.}$$



3.2.2 Test Procedures

1. The transmitter output port was connected to the system simulator.
2. Set EUT at maximum power through the system simulator.
3. Select lowest, middle, and highest channels for each band and different modulation.
4. Measure and record the power level from the system simulator.



3.3 Peak-to-Average Ratio

3.3.1 Description of the PAR Measurement

Power Complementary Cumulative Distribution Function (CCDF) curves provide a means for characterizing the power peaks of a digitally modulated signal on a statistical basis. A CCDF curve depicts the probability of the peak signal amplitude exceeding the average power level. Most contemporary measurement instrumentation include the capability to produce CCDF curves for an input signal provided that the instrument's resolution bandwidth can be set wide enough to accommodate the entire input signal bandwidth. In measuring transmissions in this band using an average power technique, the peak-to-average ratio (PAR) of the transmission may not exceed 13 dB.

3.3.2 Test Procedures

The testing follows ANSI C63.26-2015 Section 5.2.6

1. The EUT was connected to spectrum and system simulator via a power divider.
2. Set the CCDF (Complementary Cumulative Distribution Function) option in spectrum analyzer.
3. The highest RF powers were measured and recorded the maximum PAPR level associated with a probability of 0.1 %.
4. Record the deviation as Peak to Average Ratio.



3.4 Occupied Bandwidth

3.4.1 Description of Occupied Bandwidth Measurement

The occupied bandwidth is the width of a frequency band such that, below the lower and above the upper frequency limits, the mean powers emitted are each equal to a specified percentage 0.5% of the total mean transmitted power.

The 26 dB emission bandwidth is defined as the frequency range between two points, one above and one below the carrier frequency, at which the spectral density of the emission is attenuated 26 dB below the maximum in-band spectral density of the modulated signal. Spectral density (power per unit bandwidth) is to be measured with a detector of resolution bandwidth equal to approximately 1.0% of the emission bandwidth.

3.4.2 Test Procedures

The testing follows ANSI C63.26-2015 Section 5.4.3 (26dB) and Section 5.4.4 (99OB)

1. The EUT was connected to spectrum analyzer and system simulator via a power divider.
2. The spectrum analyzer center frequency is set to the nominal EUT channel center frequency. The span range for the spectrum analyzer shall be between two and five times the anticipated OBW.
3. The nominal resolution bandwidth (RBW) shall be in the range of 1 to 5 % of the anticipated OBW, and the VBW shall be at least 3 times the RBW.
4. Set the detection mode to peak, and the trace mode to max hold.
5. Determine the reference value: Set the EUT to transmit a modulated signal. Allow the trace to stabilize. Set the spectrum analyzer marker to the highest level of the displayed trace.
(this is the reference value)
6. Determine the “-26 dB down amplitude” as equal to (Reference Value – X).
7. Place two markers, one at the lowest and the other at the highest frequency of the envelope of the spectral display such that each marker is at or slightly below the “-X dB down amplitude” determined in step 6. If a marker is below this “-X dB down amplitude” value it shall be placed as close as possible to this value. The OBW is the positive frequency difference between the two markers.
8. Use the 99 % power bandwidth function of the spectrum analyzer and report the measured bandwidth.



3.5 Conducted Band Edge

3.5.1 Description of Conducted Band Edge Measurement

22.917(a)

For operations in the 824 – 849 MHz band, the FCC limit is $43 + 10\log_{10}(P[\text{Watts}])$ dB below the transmitter power $P(\text{Watts})$ in a 100kHz bandwidth. However, in the 1MHz bands immediately outside and adjacent to the licensee's frequency block, a resolution bandwidth of at least one percent of the emission bandwidth of the fundamental emission of the transmitter may be employed.

24.238 (a)

For operations in the 1850-1910 and 1930-1990 MHz band, the FCC limit is $43 + 10\log_{10}(P[\text{Watts}])$ dB below the transmitter power $P(\text{Watts})$ in a 1MHz bandwidth. However, in the 1 MHz bands immediately outside and adjacent to the frequency block a resolution bandwidth of at least one percent of the emission bandwidth of the fundamental emission of the transmitter may be employed.

27.53 (g)

For operations in the 600MHz band and 698-746 MHz band, the FCC limit is $43 + 10\log_{10}(P[\text{Watts}])$ dB below the transmitter power $P(\text{Watts})$ in a 100 kHz bandwidth. However, in the 100 kilohertz bands immediately outside and adjacent to a licensee's frequency block, a resolution bandwidth of at least 30 kHz may be employed.

27.53 (h)

For operations in the 1695–1710 MHz, 1710 – 1755 MHz bands, the limit is $43 + 10\log_{10}(P[\text{Watts}])$ dB below the transmitter power $P(\text{Watts})$ in a 1 MHz bandwidth. However, in the 1MHz bands immediately outside and adjacent to the licensee's frequency block, a resolution bandwidth of at least one percent of the emission bandwidth of the fundamental emission of the transmitter may be employed.



27.53(m)

For all fixed digital user stations, the attenuation factor shall be not less than $43 + 10\log_{10}(P[\text{Watts}])$ dB at the channel edge

3.5.2 Test Procedures

The testing follows FCC KDB 971168 D01 v03r01 Section 6.1.

1. The EUT was connected to spectrum analyzer and system simulator via a power divider.
2. The band edges of low and high channels for the highest RF powers were measured.
3. Set RBW \geq 1% EBW in the 1MHz band immediately outside and adjacent to the band edge.
4. Beyond the 1 MHz band from the band edge, RBW=1MHz was used.
5. Set spectrum analyzer with RMS detector.
6. The RF fundamental frequency should be excluded against the limit line in the operating frequency band.
7. Checked that all the results comply with the emission limit line.
The limit line is derived from $43 + 10\log(P)\text{dB}$ below the transmitter power $P(\text{Watts})$
8. For MIMO mode, add additional MIMO factor $10\log(\text{NTX}=2) = 3.01\text{dB}$ into the spectrum analyzer offset.



3.6 Conducted Spurious Emission

3.6.1 Description of Conducted Spurious Emission Measurement

The power of any emission outside of the authorized operating frequency ranges must be lower than the transmitter power (P) by a factor of at least $43 + 10 \log (P)$ dB.

3.6.2 Test Procedures

The testing follows FCC KDB 971168 D01 v03r01 Section 6.1.

1. The EUT was connected to spectrum analyzer and system simulator via a power divider.
2. The RF output of EUT was connected to the spectrum analyzer by RF cable and attenuator. The path loss was compensated to the results for each measurement.
3. The middle channel for the highest RF power within the transmitting frequency was measured.
4. The conducted spurious emission for the whole frequency range was taken.
5. Make the measurement with the spectrum analyzer's RBW = 1MHz, VBW = 3MHz.
6. Set spectrum analyzer with RMS detector.
7. Taking the record of maximum spurious emission.
8. The RF fundamental frequency should be excluded against the limit line in the operating frequency band.
9. The limit line is derived from $43 + 10\log(P)$ dB below the transmitter power P(Watts)
10. For MIMO mode, add additional MIMO factor $10\log(NTX=2) = 3.01$ dB into the spectrum analyzer offset.



3.7 Frequency Stability

3.7.1 Description of Frequency Stability Measurement

22.355

The frequency stability shall be measured by variation of ambient temperature and variation of primary supply voltage to ensure that the fundamental emission stays within the authorized frequency block. The frequency stability of the transmitter shall be maintained within $\pm 0.00025\%$ ($\pm 2.5\text{ppm}$) of the center frequency.

24.235 & 27.54

The frequency stability shall be sufficient to ensure that the fundamental emission stays within the authorized frequency block.

3.7.2 Test Procedures for Temperature Variation

The testing follows FCC KDB 971168 D01 v03r01 Section 9.0.

1. The EUT was set up in the thermal chamber and connected with the system simulator.
2. With power OFF, the temperature was decreased to -30°C and the EUT was stabilized before testing. Power was applied and the maximum change in frequency was recorded within one minute.
3. With power OFF, the temperature was raised in 10°C step up to 50°C . The EUT was stabilized at each step for at least half an hour. Power was applied and the maximum frequency change was recorded within one minute.

3.7.3 Test Procedures for Voltage Variation

The testing follows FCC KDB 971168 D01 v03r01 Section 9.0.

1. The EUT was placed in a temperature chamber at $20\pm 5^{\circ}\text{C}$ and connected with the system simulator.
2. The power supply voltage to the EUT was varied from 85% to 115% of the nominal value measured at the input to the EUT.
3. The variation in frequency was measured for the worst case.

4 Radiated Test Items

4.1 Measuring Instruments

See list of measuring instruments of this test report.

4.1.1 Test Setup

For radiated test below 30MHz

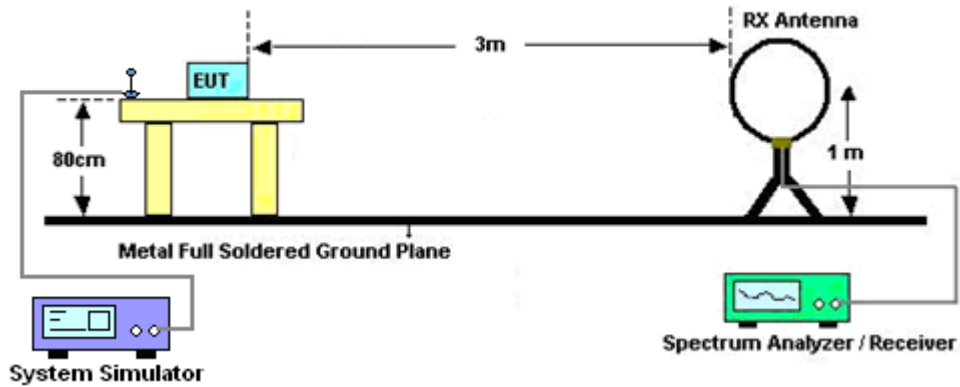

For radiated test from 30MHz to 1GHz

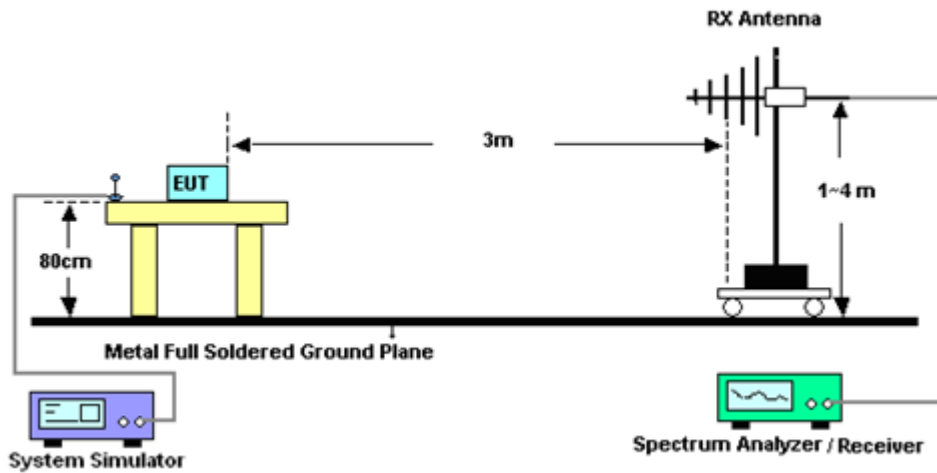

For radiated test from 1GHz to 18GHz

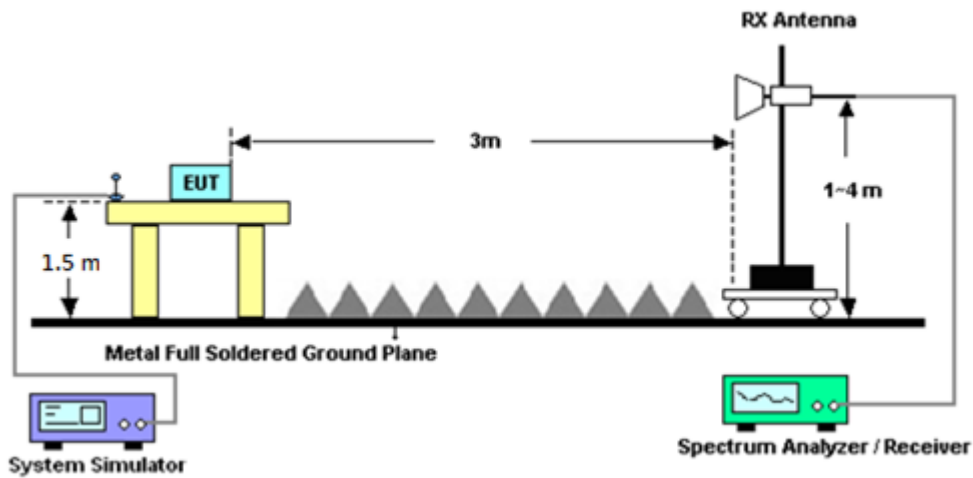

For radiated test above 18GHz

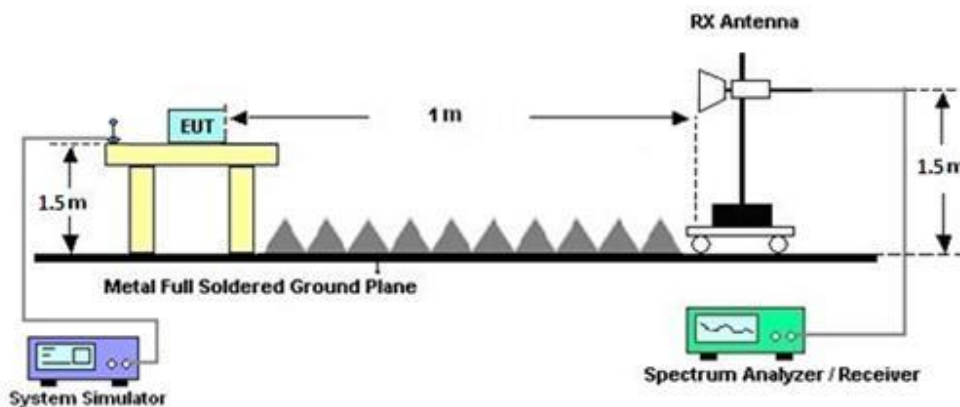

4.1.2 Test Result of Radiated Test

Please refer to Appendix B.

Note:

The low frequency, which started from 9 kHz to 30MHz, was pre-scanned and the result which was 20dB lower than the limit line was not reported.

There is adequate comparison measurement of both open-field test site and alternative test site - semi-Anechoic chamber according to 414788 D01 Radiated Test Site v01r01, and the result came out very similar.



4.2 Radiated Spurious Emission Measurement

4.2.1 Description of Radiated Spurious Emission Measurement

The radiated spurious emission was measured by substitution method according to ANSI / TIA-603-E. The power of any emission outside of the authorized operating frequency ranges must be attenuated below the transmitter power (P) by a factor of at least $43 + 10 \log (P)$ dB. The spectrum is scanned from 30 MHz up to a frequency including its 10th harmonic.

4.2.2 Test Procedures

The testing follows FCC KDB 971168 D01 v03r01 Section 7 and ANSI / TIA-603-E Section 2.2.12.

1. The EUT was placed on a turntable with 0.8 meter for frequency below 1GHz and 1.5 meter for frequency above 1GHz respectively above ground.
2. The EUT was set 3 meters from the receiving antenna, which was mounted on the antenna tower.
3. The table was rotated 360 degrees to determine the position of the highest spurious emission.
4. The height of the receiving antenna is varied between one meter and four meters to search the maximum spurious emission for both horizontal and vertical polarizations.
5. Make the measurement with the spectrum analyzer's RBW = 1MHz, VBW = 3MHz, taking the record of maximum spurious emission.
6. A horn antenna was substituted in place of the EUT and was driven by a signal generator.
7. Tune the output power of signal generator to the same emission level with EUT maximum spurious emission.
8. Taking the record of output power at antenna port.
9. Repeat step 7 to step 8 for another polarization.
10. The RF fundamental frequency should be excluded against the limit line in the operating frequency band.

The limit line is derived from $43 + 10\log(P)$ dB below the transmitter power P(Watts)

$EIRP \text{ (dBm)} = S.G. \text{ Power} - Tx \text{ Cable Loss} + Tx \text{ Antenna Gain}$

$ERP \text{ (dBm)} = EIRP - 2.15$



5 List of Measuring Equipment

Instrument	Brand Name	Model No.	Serial No.	Characteristics	Calibration Date	Test Date	Due Date	Remark
Loop Antenna	Rohde & Schwarz	HFH2-Z2	100488	9 kHz~30 MHz	Sep. 20, 2022	Jul. 25, 2023~ Aug. 29, 2023	Sep. 19, 2023	Radiation (03CH13-HY)
Preamplifier	EMEC	EM18G40G	060715	18GHz~40GHz	Dec. 07, 2022	Jul. 25, 2023~ Aug. 29, 2023	Dec. 06, 2023	Radiation (03CH13-HY)
SHF-EHF Horn Antenna	SCHWARZBECK	BBHA9170	1223	18GHz-40GHz	Jul. 10, 2023	Jul. 25, 2023~ Aug. 29, 2023	Jul. 09, 2024	Radiation (03CH13-HY)
RF Cable	HUBER + SUHNER	SUCOFLEX 102	505134/2	30MHz~40GHz	Dec. 20, 2022	Jul. 25, 2023~ Aug. 29, 2023	Dec. 19, 2023	Radiation (03CH13-HY)
SHF-EHF Horn Antenna	SCHWARZBECK	BBHA 9170	BBHA9170576	18GHz~40GHz	May 15, 2023	Jul. 25, 2023~ Aug. 29, 2023	May 14, 2024	Radiation (03CH13-HY)
Amplifier	SONOMA	310N	187282	9kHz~1GHz	Dec. 14, 2022	Jul. 25, 2023~ Aug. 29, 2023	Dec. 13, 2023	Radiation (03CH13-HY)
Bilog Antenna	TESEQ	CBL 6111D & 00800N1D01N-06	40103 & 07	30MHz~1GHz	Apr. 23, 2023	Jul. 25, 2023~ Aug. 29, 2023	Apr. 22, 2024	Radiation (03CH13-HY)
Bilog Antenna	TESEQ	CBL 6111D & 00800N1D01N-06	41912 & 05	30MHz~1GHz	Feb. 05, 2023	Jul. 25, 2023~ Aug. 29, 2023	Feb. 04, 2024	Radiation (03CH13-HY)
Hygrometer	TECEP	DTM-303B	TP140325	N/A	Nov. 07, 2022	Jul. 25, 2023~ Aug. 29, 2023	Nov. 06, 2023	Radiation (03CH13-HY)
Preamplifier	MITEQ	AMF-7D-0010 1800-30-10P	1590074	1GHz~18GHz	May 16, 2023	Jul. 25, 2023~ Aug. 29, 2023	May 15, 2024	Radiation (03CH13-HY)
Preamplifier	EM Electronics	EM01G18G	060803	1GHz~18GHz	Jan. 10, 2023	Jul. 25, 2023~ Aug. 29, 2023	Jan. 09, 2024	Radiation (03CH13-HY)
Spectrum Analyzer	Keysight	N9010A	MY55370526	10Hz~44GHz	Mar. 23, 2023	Jul. 25, 2023~ Aug. 29, 2023	Mar. 22, 2024	Radiation (03CH13-HY)
Filter	Wainwright	WLK4-1000-15 30-8000-40SS	SN12	1.53GHz Low Pass Filter	Sep. 13, 2022	Jul. 25, 2023~ Aug. 29, 2023	Sep. 12, 2023	Radiation (03CH13-HY)
Filter	Wainwright	WHKX12-1080 -1200-15000-6 0SS	SN3	1.2GHz High Pass Filter	Jun. 29, 2023	Jul. 25, 2023~ Aug. 29, 2023	Jun. 28, 2024	Radiation (03CH13-HY)
Filter	Wainwright	WHKX12-2700 -3000-18000-6 0SS	SN2	3GHz High Pass Filter	Jul. 10, 2023	Jul. 25, 2023~ Aug. 29, 2023	Jul. 09, 2024	Radiation (03CH13-HY)
RF Cable	HUBER + SUHNER	SUCOFLEX 126E	0030/126E	30MHz~18GHz	Feb. 08, 2023	Jul. 25, 2023~ Aug. 29, 2023	Feb. 07, 2024	Radiation (03CH13-HY)
RF Cable	HUBER + SUHNER	SUCOFLEX 104	804793/4	30MHz~18GHz	Feb. 08, 2023	Jul. 25, 2023~ Aug. 29, 2023	Feb. 07, 2024	Radiation (03CH13-HY)
RF Cable	HUBER + SUHNER	SUCOFLEX 104	MY15682/4	9 kHz~18GHz	Feb. 22, 2023	Jul. 25, 2023~ Aug. 29, 2023	Feb. 21, 2024	Radiation (03CH13-HY)
RF Cable	HUBER + SUHNER	SUCOFLEX 104	MY24961/4	30MHz~18GHz	Feb. 08, 2023	Jul. 25, 2023~ Aug. 29, 2023	Feb. 07, 2024	Radiation (03CH13-HY)
Controller	EMEC	EM1000	N/A	Control Turn table & Ant Mast	N/A	Jul. 25, 2023~ Aug. 29, 2023	N/A	Radiation (03CH13-HY)
Antenna Mast	EMEC	AM-BS-4500-B	N/A	1m~4m	N/A	Jul. 25, 2023~ Aug. 29, 2023	N/A	Radiation (03CH13-HY)
Turn Table	EMEC	TT2000	N/A	0~360 Degree	N/A	Jul. 25, 2023~ Aug. 29, 2023	N/A	Radiation (03CH13-HY)
Horn Antenna	SCHWARZBECK	BBHA 9120 D	9120D-1326	1GHz~18GHz	Aug. 24, 2022	Jul. 25, 2023~ Aug. 17, 2023	Aug. 23, 2023	Radiation (03CH13-HY)
Horn Antenna	SCHWARZBECK	BBHA 9120 D	9120D-1326	1GHz~18GHz	Aug. 17, 2023	Aug. 18, 2023~ Aug. 29, 2023	Aug. 16, 2024	Radiation (03CH13-HY)
Horn Antenna	SCHWARZBECK	BBHA 9120 D	9120D-1212	1GHz~18GHz	Mar. 23, 2023	Jul. 25, 2023~ Aug. 29, 2023	Mar. 22, 2024	Radiation (03CH13-HY)



Instrument	Brand Name	Model No.	Serial No.	Characteristics	Calibration Date	Test Date	Due Date	Remark
Programmable Power Supply	GW Instek	PSS-2005	EL890001	50Hz~60Hz	Sep. 29, 2022	Jul. 25, 2023~ Sep. 23, 2023	Sep. 28, 2023	Conducted (TH03-HY)
Signal Analyzer	Rohde & Schwarz	FSV3044	101048	10Hz~44GHz	May 03, 2023	Jul. 25, 2023~ Sep. 23, 2023	May 02, 2024	Conducted (TH03-HY)
Temperature Chamber	ESPEC	SH-241	92003713	-30°C ~90°C	May 17, 2023	Jul. 25, 2023~ Sep. 23, 2023	May 16, 2024	Conducted (TH03-HY)
Base Station (Measure)	Anritsu	MT8821C	6262116730	LTE	Jul. 10, 2023	Jul. 25, 2023~ Sep. 23, 2023	Jul. 09, 2024	Conducted (TH03-HY)
Base Station (Measure)	Anritsu	MT8000A	6262134933	FR1	Jul. 10, 2023	Jul. 25, 2023~ Sep. 23, 2023	Jul. 09, 2024	Conducted (TH03-HY)



6 Measurement Uncertainty

Uncertainty of Radiated Emission Measurement (30 MHz ~ 1000 MHz)

Measuring Uncertainty for a Level of Confidence of 95% ($U = 2Uc(y)$)	3.02 dB
---	---------

Uncertainty of Radiated Emission Measurement (1 GHz ~ 18 GHz)

Measuring Uncertainty for a Level of Confidence of 95% ($U = 2Uc(y)$)	3.55 dB
---	---------

Uncertainty of Radiated Emission Measurement (18 GHz ~ 40 GHz)

Measuring Uncertainty for a Level of Confidence of 95% ($U = 2Uc(y)$)	3.82 dB
---	---------



Appendix A. Test Results of Conducted Test

Conducted Output Power(Average power and ERP/EIRP)

<SISO Mode>

5G-FR1 SA n2 Maximum Average Power [dBm] (GT - LC = 5 dB)								
BW [MHz]	RB Size	RB Offset	Mod	Lowest	Middle	Highest	EIRP (dBm)	EIRP(W)
5	1	1	PI/2 BPSK	24.65	24.90	24.67	29.90	0.9772
5	1	23		24.58	24.76	24.54		
5	12	6		24.65	24.82	24.64		
5	1	0		24.12	24.31	24.17		
5	1	24		24.05	24.29	24.00		
5	25	0		24.10	24.33	24.14		
5	1	1	QPSK	24.62	24.83	24.61		
5	1	23		24.71	24.90	24.61		
5	12	6		24.62	24.84	24.46		
5	1	0		23.64	23.88	23.66		
5	1	24		23.58	23.82	23.62		
5	25	0		23.64	23.84	23.63		
5	1	1	16-QAM	23.58	23.79	23.63	28.79	0.7568
5	1	1	64-QAM	22.37	22.55	22.41		
5	1	1	256-QAM	19.67	19.89	19.68		
Limit	EIRP < 2W			Result			Pass	

5G-FR1 SA n2 Maximum Average Power [dBm] (GT - LC = 5 dB)								
BW [MHz]	RB Size	RB Offset	Mod	Lowest	Middle	Highest	EIRP (dBm)	EIRP(W)
10	1	1	PI/2 BPSK	24.66	24.80	24.67	29.89	0.9750
10	1	50		24.66	24.79	24.70		
10	25	12		24.66	24.89	24.60		
10	1	0		24.20	24.46	24.14		
10	1	51		24.19	24.31	24.13		
10	50	0		24.19	24.42	24.19		
10	1	1	QPSK	24.69	24.84	24.67		
10	1	50		24.67	24.83	24.61		
10	25	12		24.68	24.84	24.53		
10	1	0		23.64	23.95	23.65		
10	1	51		23.67	23.86	23.64		
10	50	0		23.70	23.87	23.64		
10	1	1	16-QAM	23.60	23.76	23.64	28.76	0.7516
10	1	1	64-QAM	22.44	22.58	22.39		
10	1	1	256-QAM	19.68	19.80	19.70		
Limit	EIRP < 2W			Result			Pass	



5G-FR1 SA n2 Maximum Average Power [dBm] (GT - LC = 5 dB)								
BW [MHz]	RB Size	RB Offset	Mod	Lowest	Middle	Highest	EIRP (dBm)	EIRP(W)
15	1	1	PI/2 BPSK	24.88	24.92	24.88	29.97	0.9931
15	1	77		24.86	24.93	24.67		
15	36	18		24.85	24.92	24.66		
15	1	0		24.35	24.44	24.26		
15	1	78		24.32	24.40	24.29		
15	75	0		24.40	24.54	24.29		
15	1	1	QPSK	24.89	24.97	24.94		
15	1	77		24.96	24.97	24.61		
15	36	18		24.91	24.93	24.59		
15	1	0		23.85	24.08	23.78		
15	1	78		23.86	24.01	23.81		
15	75	0		23.92	24.09	23.80		
15	1	1	16-QAM	23.74	23.80	23.83	28.83	0.7638
15	1	1	64-QAM	22.53	22.64	22.65		
15	1	1	256-QAM	19.83	19.90	19.91		
Limit	EIRP < 2W			Result			Pass	

5G-FR1 SA n2 Maximum Average Power [dBm] (GT - LC = 5 dB)								
BW [MHz]	RB Size	RB Offset	Mod	Lowest	Middle	Highest	EIRP (dBm)	EIRP(W)
20	1	1	PI/2 BPSK	24.81	24.95	24.89	29.95	0.9886
20	1	104		24.90	24.93	24.69		
20	50	25		24.92	24.93	24.88		
20	1	0		24.38	24.52	24.28		
20	1	105		24.50	24.48	24.31		
20	100	0		24.43	24.57	24.45		
20	1	1	QPSK	24.89	24.91	24.93		
20	1	104		24.90	24.95	24.62		
20	50	25		24.92	24.92	24.78		
20	1	0		23.83	24.05	23.82		
20	1	105		23.98	23.98	23.83		
20	100	0		23.86	24.02	23.95		
20	1	1	16-QAM	23.76	23.89	23.85	28.89	0.7745
20	1	1	64-QAM	22.59	22.69	22.69		
20	1	1	256-QAM	19.90	19.93	19.92		
Limit	EIRP < 2W			Result			Pass	



5G-FR1 SA n5 Maximum Average Power [dBm] (GT - LC = 3.5 dB)								
BW [MHz]	RB Size	RB Offset	Mod	Lowest	Middle	Highest	ERP (dBm)	ERP(W)
5	1	1	PI/2 BPSK	24.92	24.94	24.92	26.33	0.4295
5	1	23		24.88	24.79	24.90		
5	12	6		24.86	24.79	24.87		
5	1	0		24.40	24.54	24.57		
5	1	24		24.35	24.54	24.53		
5	25	0		24.35	24.48	24.59		
5	1	1	QPSK	24.90	24.98	24.92		
5	1	23		24.80	24.81	24.84		
5	12	6		24.88	24.95	24.89		
5	1	0		23.89	24.06	24.11		
5	1	24		23.79	24.03	24.07		
5	25	0		23.86	23.97	24.03		
5	1	1	16-QAM	23.95	23.92	24.10	25.45	0.3508
5	1	1	64-QAM	22.50	22.59	22.63		
5	1	1	256-QAM	19.85	19.97	20.10		
Limit	ERP < 7W			Result			Pass	

5G-FR1 SA n5 Maximum Average Power [dBm] (GT - LC = 3.5 dB)								
BW [MHz]	RB Size	RB Offset	Mod	Lowest	Middle	Highest	ERP (dBm)	ERP(W)
10	1	1	PI/2 BPSK	24.85	24.83	24.97	26.32	0.4285
10	1	50		24.92	24.82	24.80		
10	25	12		24.84	24.82	24.96		
10	1	0		24.44	24.54	24.59		
10	1	51		24.46	24.56	24.50		
10	50	0		24.26	24.49	24.48		
10	1	1	QPSK	24.84	24.84	24.83		
10	1	50		24.96	24.91	24.81		
10	25	12		24.80	24.97	24.95		
10	1	0		23.83	24.05	24.14		
10	1	51		23.87	24.07	23.97		
10	50	0		23.85	24.05	23.98		
10	1	1	16-QAM	23.85	23.91	24.06	25.41	0.3475
10	1	1	64-QAM	22.43	22.47	22.66		
10	1	1	256-QAM	19.81	19.85	20.01		
Limit	ERP < 7W			Result			Pass	



5G-FR1 SA n5 Maximum Average Power [dBm] (GT - LC = 3.5 dB)								
BW [MHz]	RB Size	RB Offset	Mod	Lowest	Middle	Highest	ERP (dBm)	ERP(W)
15	1	1	PI/2 BPSK	24.92	24.96	24.88	26.33	0.4295
15	1	77		24.81	24.92	24.85		
15	36	18		24.87	24.94	24.94		
15	1	0		24.59	24.60	24.60		
15	1	78		24.54	24.57	24.53		
15	75	0		24.51	24.57	24.68		
15	1	1	QPSK	24.98	24.95	24.90		
15	1	77		24.89	24.90	24.96		
15	36	18		24.82	24.94	24.84		
15	1	0		24.11	24.19	24.21		
15	1	78		24.03	23.99	24.12		
15	75	0		24.06	24.10	24.14		
15	1	1	16-QAM	23.92	23.91	24.04	25.39	0.3459
15	1	1	64-QAM	22.53	22.59	22.68		
15	1	1	256-QAM	19.95	20.03	20.23		
Limit	ERP < 7W			Result			Pass	

5G-FR1 SA n5 Maximum Average Power [dBm] (GT - LC = 3.5 dB)								
BW [MHz]	RB Size	RB Offset	Mod	Lowest	Middle	Highest	ERP (dBm)	ERP(W)
20	1	1	PI/2 BPSK	24.95	24.87	24.90	26.31	0.4276
20	1	104		24.88	24.84	24.83		
20	50	25		24.96	24.95	24.87		
20	1	0		24.71	24.67	24.60		
20	1	105		24.59	24.63	24.55		
20	100	0		24.58	24.64	24.60		
20	1	1	QPSK	24.95	24.91	24.94		
20	1	104		24.89	24.94	24.89		
20	50	25		24.95	24.94	24.87		
20	1	0		24.23	24.17	24.18		
20	1	105		24.10	24.04	24.09		
20	100	0		24.10	24.16	24.12		
20	1	1	16-QAM	23.90	23.90	23.99	25.34	0.3420
20	1	1	64-QAM	22.48	22.53	22.52		
20	1	1	256-QAM	19.95	19.92	19.92		
Limit	ERP < 7W			Result			Pass	



5G-FR1 SA n12 Maximum Average Power [dBm] (GT - LC = 2.4 dB)								
BW [MHz]	RB Size	RB Offset	Mod	Lowest	Middle	Highest	ERP (dBm)	ERP(W)
5	1	1	PI/2 BPSK	24.70	24.61	24.47	24.95	0.3126
5	1	23		24.62	24.60	24.54		
5	12	6		24.63	24.55	24.53		
5	1	0		24.15	24.10	24.03		
5	1	24		24.18	23.99	23.97		
5	25	0		24.12	24.15	24.02		
5	1	1	QPSK	24.69	24.66	24.49		
5	1	23		24.65	24.59	24.49		
5	12	6		24.63	24.60	24.49		
5	1	0		23.69	23.67	23.57		
5	1	24		23.54	23.58	23.43		
5	25	0		23.67	23.61	23.54		
5	1	1	16-QAM	23.67	23.67	23.53	23.92	0.2466
5	1	1	64-QAM	22.34	22.37	22.19		
5	1	1	256-QAM	19.66	19.65	19.48		
Limit	ERP < 1000W			Result			Pass	

5G-FR1 SA n12 Maximum Average Power [dBm] (GT - LC = 2.4 dB)								
BW [MHz]	RB Size	RB Offset	Mod	Lowest	Middle	Highest	ERP (dBm)	ERP(W)
10	1	1	PI/2 BPSK	24.69	24.60	24.64	24.96	0.3133
10	1	50		24.60	24.53	24.50		
10	25	12		24.71	24.58	24.51		
10	1	0		24.31	24.27	24.10		
10	1	51		24.05	23.97	23.93		
10	50	0		24.17	24.14	24.04		
10	1	1	QPSK	24.69	24.64	24.66		
10	1	50		24.58	24.51	24.49		
10	25	12		24.69	24.59	24.54		
10	1	0		23.83	23.68	23.68		
10	1	51		23.56	23.50	23.48		
10	50	0		23.70	23.62	23.55		
10	1	1	16-QAM	23.73	23.68	23.78	24.03	0.2529
10	1	1	64-QAM	22.36	22.32	22.32		
10	1	1	256-QAM	19.67	19.52	19.55		
Limit	ERP < 1000W			Result			Pass	



5G-FR1 SA n12 Maximum Average Power [dBm] (GT - LC = 2.4 dB)								
BW [MHz]	RB Size	RB Offset	Mod	Lowest	Middle	Highest	ERP (dBm)	ERP(W)
15	1	1	PI/2 BPSK	24.87	24.80	24.81	25.14	0.3266
15	1	77		24.54	24.50	24.52		
15	36	18		24.71	24.74	24.67		
15	1	0		24.34	24.27	24.28		
15	1	78		24.02	24.08	24.05		
15	75	0		24.26	24.25	24.20		
15	1	1	QPSK	24.89	24.83	24.79		
15	1	77		24.59	24.56	24.54		
15	36	18		24.76	24.71	24.68		
15	1	0		23.90	23.84	23.79		
15	1	78		23.52	23.52	23.52		
15	75	0		23.75	23.69	23.70		
15	1	1	16-QAM	23.82	23.86	23.84	24.11	0.2576
15	1	1	64-QAM	22.49	22.53	22.47		
15	1	1	256-QAM	19.94	19.88	19.90		
Limit	ERP < 100W			Result			Pass	



5G-FR1 SA n25 Maximum Average Power [dBm] (GT - LC = 5 dB)								
BW [MHz]	RB Size	RB Offset	Mod	Lowest	Middle	Highest	EIRP (dBm)	EIRP(W)
5	1	1	PI/2 BPSK	24.17	24.47	24.21	29.48	0.8872
5	1	23		24.18	24.48	24.32		
5	12	6		24.13	24.42	24.20		
5	1	0		23.65	23.98	23.82		
5	1	24		23.70	23.96	23.84		
5	25	0		23.66	23.93	23.78		
5	1	1	QPSK	24.15	24.42	24.23		
5	1	23		24.09	24.39	24.30		
5	12	6		24.07	24.40	24.18		
5	1	0		23.18	23.49	23.38		
5	1	24		23.16	23.44	23.38		
5	25	0		23.20	23.47	23.28		
5	1	1	16-QAM	22.99	23.39	22.99	28.39	0.6902
5	1	1	64-QAM	21.95	22.20	21.95		
5	1	1	256-QAM	19.21	19.51	19.34		
Limit	EIRP < 2W			Result			Pass	

5G-FR1 SA n25 Maximum Average Power [dBm] (GT - LC = 5 dB)								
BW [MHz]	RB Size	RB Offset	Mod	Lowest	Middle	Highest	EIRP (dBm)	EIRP(W)
10	1	1	PI/2 BPSK	24.22	24.30	24.28	29.54	0.8995
10	1	50		24.28	24.30	24.37		
10	25	12		24.29	24.54	24.37		
10	1	0		23.75	23.93	23.79		
10	1	51		23.77	23.82	23.87		
10	50	0		23.78	23.98	23.89		
10	1	1	QPSK	24.26	24.41	24.28		
10	1	50		24.34	24.39	24.34		
10	25	12		24.28	24.49	24.32		
10	1	0		23.29	23.44	23.43		
10	1	51		23.35	23.39	23.38		
10	50	0		23.36	23.56	23.38		
10	1	1	16-QAM	23.18	23.22	23.17	28.22	0.6637
10	1	1	64-QAM	22.03	22.01	22.07		
10	1	1	256-QAM	19.32	19.39	19.32		
Limit	EIRP < 2W			Result			Pass	



5G-FR1 SA n25 Maximum Average Power [dBm] (GT - LC = 5 dB)								
BW [MHz]	RB Size	RB Offset	Mod	Lowest	Middle	Highest	EIRP (dBm)	EIRP(W)
15	1	1	PI/2 BPSK	24.32	24.68	24.46	29.82	0.9594
15	1	77		24.54	24.53	24.37		
15	36	18		24.47	24.61	24.54		
15	1	0		24.02	24.13	24.00		
15	1	78		24.05	24.02	23.91		
15	75	0		23.97	24.14	24.01		
15	1	1	QPSK	24.42	24.62	24.54		
15	1	77		24.56	24.82	24.46		
15	36	18		24.54	24.67	24.56		
15	1	0		23.50	23.72	23.49		
15	1	78		23.53	23.59	23.41		
15	75	0		23.55	23.71	23.52		
15	1	1	16-QAM	23.31	23.55	23.32	28.55	0.7161
15	1	1	64-QAM	22.02	22.42	22.17		
15	1	1	256-QAM	19.46	19.73	19.67		
Limit	EIRP < 2W			Result			Pass	

5G-FR1 SA n25 Maximum Average Power [dBm] (GT - LC = 5 dB)								
BW [MHz]	RB Size	RB Offset	Mod	Lowest	Middle	Highest	EIRP (dBm)	EIRP(W)
20	1	1	PI/2 BPSK	24.35	24.57	24.56	29.64	0.9204
20	1	104		24.51	24.42	24.41		
20	50	25		24.48	24.64	24.59		
20	1	0		23.92	24.10	23.95		
20	1	105		23.99	23.90	23.98		
20	100	0		24.05	24.15	24.11		
20	1	1	QPSK	24.39	24.64	24.60		
20	1	104		24.57	24.51	24.36		
20	50	25		24.56	24.64	24.58		
20	1	0		23.46	23.71	23.60		
20	1	105		23.59	23.51	23.35		
20	100	0		23.57	23.71	23.63		
20	1	1	16-QAM	23.19	23.48	23.37	28.48	0.7047
20	1	1	64-QAM	22.06	22.16	22.40		
20	1	1	256-QAM	19.47	19.75	19.69		
Limit	EIRP < 2W			Result			Pass	



5G-FR1 SA n25 Maximum Average Power [dBm] (GT - LC = 5 dB)										
BW [MHz]	RB Size	RB Offset	Mod	Lowest	Middle	Highest	EIRP (dBm)	EIRP(W)		
25	1	1	PI/2 BPSK	24.32	24.53	24.55	29.76	0.9462		
25	1	131		24.62	24.52	24.41				
25	64	32		24.50	24.66	24.53				
25	1	0		24.09	24.14	24.04				
25	1	132		24.13	24.00	23.95				
25	128	0		24.03	24.08	23.97				
25	1	1	QPSK	24.45	24.56	24.53			29.76	0.9462
25	1	131		24.76	24.47	24.46				
25	64	32		24.50	24.64	24.59				
25	1	0		23.52	23.69	23.57				
25	1	132		23.61	23.58	23.46				
25	128	0		23.49	23.69	23.57				
25	1	1	16-QAM	23.23	23.37	23.36	28.37	0.6871		
25	1	1	64-QAM	22.09	22.26	22.38				
25	1	1	256-QAM	19.46	19.66	19.65				
Limit	EIRP < 2W			Result			Pass			

5G-FR1 SA n25 Maximum Average Power [dBm] (GT - LC = 5 dB)										
BW [MHz]	RB Size	RB Offset	Mod	Lowest	Middle	Highest	EIRP (dBm)	EIRP(W)		
30	1	1	PI/2 BPSK	24.29	24.54	24.60	29.71	0.9354		
30	1	158		24.64	24.57	24.51				
30	80	40		24.67	24.65	24.67				
30	1	0		24.06	24.24	24.19				
30	1	159		24.17	24.10	24.04				
30	160	0		24.22	24.17	24.21				
30	1	1	QPSK	24.44	24.57	24.69			29.71	0.9354
30	1	158		24.71	24.63	24.55				
30	80	40		24.66	24.66	24.71				
30	1	0		23.69	23.76	23.74				
30	1	159		23.68	23.66	23.58				
30	160	0		23.73	23.69	23.73				
30	1	1	16-QAM	23.26	23.30	23.51	28.51	0.7096		
30	1	1	64-QAM	22.22	22.33	22.39				
30	1	1	256-QAM	19.49	19.65	19.78				
Limit	EIRP < 2W			Result			Pass			



5G-FR1 SA n25 Maximum Average Power [dBm] (GT - LC = 5 dB)								
BW [MHz]	RB Size	RB Offset	Mod	Lowest	Middle	Highest	EIRP (dBm)	EIRP(W)
35	1	1	PI/2 BPSK	24.65	24.82	24.93	29.97	0.9929
35	1	186		24.82	24.70	24.79		
35	90	45		24.92	24.95	24.95		
35	1	0		24.33	24.46	24.65		
35	1	187		24.29	24.25	24.31		
35	180	0		24.48	24.45	24.54		
35	1	1	QPSK	24.70	24.82	24.95		
35	1	186		24.92	24.82	24.84		
35	90	45		24.96	24.96	24.97		
35	1	0		24.01	24.08	24.32		
35	1	187		23.84	24.03	23.95		
35	180	0		24.02	24.02	24.05		
35	1	1	16-QAM	23.47	23.71	23.72	28.72	0.7447
35	1	1	64-QAM	22.35	22.54	22.69		
35	1	1	256-QAM	19.74	20.01	20.24		
Limit	EIRP < 2W			Result			Pass	

5G-FR1 SA n25 Maximum Average Power [dBm] (GT - LC = 5 dB)								
BW [MHz]	RB Size	RB Offset	Mod	Lowest	Middle	Highest	EIRP (dBm)	EIRP(W)
40	1	1	PI/2 BPSK	24.21	24.53	24.67	29.84	0.9638
40	1	214		24.51	24.52	24.51		
40	108	54		24.67	24.67	24.76		
40	1	0		23.49	24.22	24.31		
40	1	215		23.56	24.12	23.98		
40	216	0		23.68	24.16	24.28		
40	1	1	QPSK	24.45	24.47	24.75		
40	1	214		24.84	24.84	24.57		
40	108	54		24.65	24.70	24.83		
40	1	0		23.65	23.76	23.89		
40	1	215		23.73	23.56	23.42		
40	216	0		23.62	23.66	23.81		
40	1	1	16-QAM	23.86	23.37	23.64	28.86	0.7691
40	1	1	64-QAM	21.62	22.28	22.41		
40	1	1	256-QAM	19.47	19.65	19.83		
Limit	EIRP < 2W			Result			Pass	



5G-FR1 SA n26 Maximum Average Power [dBm] (GT - LC = 3.4 dB)								
BW [MHz]	RB Size	RB Offset	Mod	Lowest	Middle	Highest	ERP (dBm)	ERP(W)
5	1	1	PI/2 BPSK	24.92	25.16	25.15	26.61	0.4581
5	1	23		25.07	25.24	25.21		
5	12	6		25.09	25.15	25.25		
5	1	0		24.57	24.64	24.76		
5	1	24		24.55	24.65	24.67		
5	25	0		24.54	24.58	24.79		
5	1	1	QPSK	24.96	25.16	25.22		
5	1	23		25.01	25.23	25.23		
5	12	6		24.96	25.14	25.26		
5	1	0		23.98	24.20	24.32		
5	1	24		24.00	24.19	24.21		
5	25	0		24.06	24.11	24.23		
5	1	1	16-QAM	23.96	24.17	24.18	25.53	0.3573
5	1	1	64-QAM	22.60	22.80	22.79		
5	1	1	256-QAM	20.01	20.16	20.24		
Limit	ERP < 7W			Result			Pass	

5G-FR1 SA n26 Maximum Average Power [dBm] (GT - LC = 3.4 dB)								
BW [MHz]	RB Size	RB Offset	Mod	Lowest	Middle	Highest	ERP (dBm)	ERP(W)
10	1	1	PI/2 BPSK	24.96	25.06	25.10	26.53	0.4498
10	1	50		25.00	25.12	25.15		
10	25	12		24.97	25.15	25.13		
10	1	0		24.51	24.63	24.73		
10	1	51		24.55	24.63	24.59		
10	50	0		24.55	24.64	24.74		
10	1	1	QPSK	24.95	25.09	25.11		
10	1	50		25.01	25.13	25.17		
10	25	12		24.98	25.18	25.10		
10	1	0		24.03	24.18	24.27		
10	1	51		24.07	24.18	24.15		
10	50	0		24.01	24.17	24.10		
10	1	1	16-QAM	23.93	24.14	24.11	25.49	0.3540
10	1	1	64-QAM	22.60	22.76	22.74		
10	1	1	256-QAM	19.97	20.15	20.12		
Limit	ERP < 7W			Result			Pass	



5G-FR1 SA n26 Maximum Average Power [dBm] (GT - LC = 3.4 dB)								
BW [MHz]	RB Size	RB Offset	Mod	Lowest	Middle	Highest	ERP (dBm)	ERP(W)
15	1	1	PI/2 BPSK	25.04	25.19	25.18	26.64	0.4613
15	1	77		25.16	25.28	25.29		
15	36	18		25.11	25.20	25.28		
15	1	0		24.71	24.77	24.81		
15	1	78		24.68	24.73	24.75		
15	75	0		24.63	24.77	24.77		
15	1	1	QPSK	25.01	25.21	25.24		
15	1	77		25.15	25.25	25.16		
15	36	18		25.13	25.18	25.26		
15	1	0		24.19	24.35	24.27		
15	1	78		24.17	24.33	24.27		
15	75	0		24.19	24.25	24.25		
15	1	1	16-QAM	24.01	24.16	24.16	25.51	0.3556
15	1	1	64-QAM	22.59	22.89	22.83		
15	1	1	256-QAM	20.03	20.17	20.23		
Limit	ERP < 7W			Result			Pass	

5G-FR1 SA n26 Maximum Average Power [dBm] (GT - LC = 3.4 dB)								
BW [MHz]	RB Size	RB Offset	Mod	Lowest	Middle	Highest	ERP (dBm)	ERP(W)
20	1	1	PI/2 BPSK	25.06	25.11	25.17	26.64	0.4613
20	1	104		25.21	25.19	25.22		
20	50	25		25.06	25.23	25.26		
20	1	0		24.72	24.80	24.84		
20	1	105		24.74	24.70	24.78		
20	100	0		24.64	24.76	24.75		
20	1	1	QPSK	25.04	25.07	25.14		
20	1	104		25.24	25.24	25.29		
20	50	25		25.11	25.27	25.20		
20	1	0		24.21	24.29	24.37		
20	1	105		24.24	24.27	24.22		
20	100	0		24.14	24.26	24.27		
20	1	1	16-QAM	24.03	24.10	24.17	25.52	0.3565
20	1	1	64-QAM	22.73	22.74	22.83		
20	1	1	256-QAM	20.18	20.17	20.21		
Limit	ERP < 7W			Result			Pass	



5G-FR1 SA n41 (PC2) Maximum Average Power [dBm] (GT - LC = 5.5 dB)								
BW [MHz]	RB Size	RB Offset	Mod	Lowest	Middle	Highest	EIRP (dBm)	EIRP(W)
10	1	1	PI/2 BPSK	26.70	26.85	26.66	32.48	1.7701
10	1	22		26.66	26.98	26.59		
10	12	6		26.79	26.91	26.60		
10	1	0		23.27	23.40	23.03		
10	1	23		23.20	23.45	23.05		
10	24	0		26.28	26.47	26.13		
10	1	1	QPSK	26.65	26.81	26.60		
10	1	22		26.65	26.94	26.54		
10	12	6		26.81	26.96	26.58		
10	1	0		23.08	23.41	23.05		
10	1	23		23.18	23.46	23.03		
10	24	0		25.76	25.99	25.60		
10	1	1	16-QAM	25.70	25.81	25.61	31.31	1.3521
10	1	1	64-QAM	24.29	24.33	24.12		
10	1	1	256-QAM	22.16	22.47	22.08		
Limit	Power < 2W			Result			Pass	

5G-FR1 SA n41 (PC2) Maximum Average Power [dBm] (GT - LC = 5.5 dB)								
BW [MHz]	RB Size	RB Offset	Mod	Lowest	Middle	Highest	EIRP (dBm)	EIRP(W)
15	1	1	PI/2 BPSK	26.83	26.96	26.91	32.46	1.762
15	1	36		26.85	26.96	26.87		
15	18	9		26.84	26.96	26.86		
15	1	0		23.27	23.50	23.29		
15	1	37		23.35	23.64	23.33		
15	36	0		26.33	26.55	26.34		
15	1	1	QPSK	26.82	26.95	26.86		
15	1	36		26.83	26.93	26.80		
15	18	9		26.79	26.96	26.83		
15	1	0		23.25	23.48	23.30		
15	1	37		23.42	23.61	23.34		
15	36	0		25.84	26.10	25.85		
15	1	1	16-QAM	25.90	25.84	25.91	31.41	1.3836
15	1	1	64-QAM	24.43	24.45	24.38		
15	1	1	256-QAM	22.39	22.45	22.40		
Limit	Power < 2W			Result			Pass	



5G-FR1 SA n41 (PC2) Maximum Average Power [dBm] (GT - LC = 5.5 dB)								
BW [MHz]	RB Size	RB Offset	Mod	Lowest	Middle	Highest	EIRP (dBm)	EIRP(W)
20	1	1	PI/2 BPSK	26.74	26.93	26.84	32.46	1.762
20	1	49		26.62	26.95	26.80		
20	25	12		26.72	26.96	26.88		
20	1	0		23.14	23.41	23.39		
20	1	50		23.17	23.63	23.28		
20	50	0		26.21	26.53	26.37		
20	1	1	QPSK	26.69	26.90	26.80		
20	1	49		26.63	26.96	26.79		
20	25	12		26.72	26.95	26.91		
20	1	0		23.19	23.47	23.34		
20	1	50		23.09	23.61	23.33		
20	50	0		25.76	26.06	25.91		
20	1	1	16-QAM	25.74	25.89	25.80	31.39	1.3772
20	1	1	64-QAM	24.26	24.38	24.37		
20	1	1	256-QAM	22.26	22.54	22.26		
Limit	Power < 2W			Result			Pass	

5G-FR1 SA n41 (PC2) Maximum Average Power [dBm] (GT - LC = 5.5 dB)								
BW [MHz]	RB Size	RB Offset	Mod	Lowest	Middle	Highest	EIRP (dBm)	EIRP(W)
30	1	1	PI/2 BPSK	26.90	26.97	26.96	32.48	1.7701
30	1	76		26.86	26.95	26.94		
30	36	18		26.80	26.94	26.96		
30	1	0		23.21	23.49	23.38		
30	1	77		23.41	23.69	23.50		
30	75	0		26.33	26.62	26.50		
30	1	1	QPSK	26.85	26.98	26.95		
30	1	76		26.85	26.98	26.93		
30	36	18		26.79	26.93	26.94		
30	1	0		23.22	23.49	23.40		
30	1	77		23.40	23.72	23.48		
30	75	0		25.87	26.15	25.97		
30	1	1	16-QAM	25.94	25.92	25.99	31.49	1.4093
30	1	1	64-QAM	24.52	24.56	24.62		
30	1	1	256-QAM	22.50	22.57	22.51		
Limit	Power < 2W			Result			Pass	



5G-FR1 SA n41 (PC2) Maximum Average Power [dBm] (GT - LC = 5.5 dB)								
BW [MHz]	RB Size	RB Offset	Mod	Lowest	Middle	Highest	EIRP (dBm)	EIRP(W)
40	1	1	PI/2 BPSK	26.87	26.97	26.93	32.49	1.7742
40	1	104		26.79	26.99	26.92		
40	50	25		26.78	26.94	26.91		
40	1	0		23.24	23.57	23.33		
40	1	105		23.31	23.75	23.46		
40	100	0		26.29	26.65	26.40		
40	1	1	QPSK	26.87	26.93	26.92		
40	1	104		26.78	26.95	26.93		
40	50	25		26.73	26.95	26.87		
40	1	0		23.20	23.56	23.33		
40	1	105		23.31	23.80	23.43		
40	100	0		25.78	26.16	25.90		
40	1	1	16-QAM	25.79	26.01	26.02	31.52	1.4191
40	1	1	64-QAM	24.34	24.56	24.60		
40	1	1	256-QAM	22.39	22.63	22.58		
Limit	Power < 2W			Result			Pass	

5G-FR1 SA n41 (PC2) Maximum Average Power [dBm] (GT - LC = 5.5 dB)								
BW [MHz]	RB Size	RB Offset	Mod	Lowest	Middle	Highest	EIRP (dBm)	EIRP(W)
50	1	1	PI/2 BPSK	26.70	26.89	26.95	32.48	1.7701
50	1	131		26.66	26.93	26.86		
50	64	32		26.70	26.93	26.98		
50	1	0		23.06	23.46	23.24		
50	1	132		23.15	23.69	23.38		
50	128	0		26.21	26.60	26.46		
50	1	1	QPSK	26.61	26.85	26.91		
50	1	131		26.63	26.97	26.90		
50	64	32		26.71	26.95	26.98		
50	1	0		23.02	23.41	23.23		
50	1	132		23.19	23.62	23.38		
50	128	0		25.73	26.08	25.93		
50	1	1	16-QAM	25.59	25.90	25.91	31.41	1.3836
50	1	1	64-QAM	24.24	24.34	24.44		
50	1	1	256-QAM	22.33	22.37	22.46		
Limit	Power < 2W			Result			Pass	



5G-FR1 SA n41 (PC2) Maximum Average Power [dBm] (GT - LC = 5.5 dB)								
BW [MHz]	RB Size	RB Offset	Mod	Lowest	Middle	Highest	EIRP (dBm)	EIRP(W)
60	1	1	PI/2 BPSK	26.62	26.88	26.91	32.47	1.766
60	1	160		26.59	26.97	26.73		
60	81	40		26.56	26.95	26.87		
60	1	0		22.88	23.36	23.06		
60	1	161		23.03	23.46	23.19		
60	162	0		26.14	26.56	26.30		
60	1	1	QPSK	26.63	26.86	26.86		
60	1	160		26.55	26.89	26.67		
60	81	40		26.58	26.96	26.87		
60	1	0		22.87	23.36	23.13		
60	1	161		23.06	23.46	23.16		
60	162	0		25.61	26.06	25.84		
60	1	1	16-QAM	25.55	25.87	25.80	31.37	1.3709
60	1	1	64-QAM	24.04	24.28	24.46		
60	1	1	256-QAM	22.24	22.34	22.38		
Limit	Power < 2W			Result			Pass	

5G-FR1 SA n41 (PC2) Maximum Average Power [dBm] (GT - LC = 5.5 dB)								
BW [MHz]	RB Size	RB Offset	Mod	Lowest	Middle	Highest	EIRP (dBm)	EIRP(W)
70	1	1	PI/2 BPSK	26.51	26.66	26.75	32.38	1.7298
70	1	187		26.44	26.71	26.43		
70	90	45		26.55	26.82	26.64		
70	1	0		22.83	23.11	23.04		
70	1	188		22.94	23.21	22.93		
70	180	0		26.09	26.37	26.15		
70	1	1	QPSK	26.54	26.67	26.75		
70	1	187		26.38	26.70	26.35		
70	90	45		26.58	26.88	26.68		
70	1	0		22.82	23.16	23.03		
70	1	188		22.92	23.20	22.92		
70	180	0		25.59	25.88	25.67		
70	1	1	16-QAM	25.53	25.61	25.76	31.26	1.3366
70	1	1	64-QAM	23.84	24.12	24.27		
70	1	1	256-QAM	22.14	22.18	22.35		
Limit	Power < 2W			Result			Pass	



5G-FR1 SA n41 (PC2) Maximum Average Power [dBm] (GT - LC = 5.5 dB)								
BW [MHz]	RB Size	RB Offset	Mod	Lowest	Middle	Highest	EIRP (dBm)	EIRP(W)
80	1	1	PI/2 BPSK	26.49	26.65	26.80	32.39	1.7338
80	1	215		26.42	26.80	26.51		
80	108	54		26.47	26.89	26.73		
80	1	0		22.71	23.17	23.03		
80	1	216		22.93	23.33	23.05		
80	216	0		25.97	26.40	26.20		
80	1	1	QPSK	26.40	26.65	26.80		
80	1	215		26.37	26.74	26.61		
80	108	54		26.48	26.86	26.74		
80	1	0		22.69	23.15	22.97		
80	1	216		22.91	23.32	23.04		
80	216	0		25.50	25.90	25.76		
80	1	1	16-QAM	25.51	25.65	25.83	31.33	1.3583
80	1	1	64-QAM	23.99	24.20	24.28		
80	1	1	256-QAM	21.94	22.14	22.43		
Limit	Power < 2W			Result			Pass	

5G-FR1 SA n41 (PC2) Maximum Average Power [dBm] (GT - LC = 5.5 dB)								
BW [MHz]	RB Size	RB Offset	Mod	Lowest	Middle	Highest	EIRP (dBm)	EIRP(W)
90	1	1	PI/2 BPSK	26.51	26.65	26.88	32.43	1.7498
90	1	243		26.58	26.65	26.66		
90	120	60		26.51	26.90	26.93		
90	1	0		22.64	23.14	22.99		
90	1	244		23.09	23.31	23.14		
90	243	0		26.10	26.34	26.34		
90	1	1	QPSK	26.51	26.59	26.82		
90	1	243		26.56	26.76	26.61		
90	120	60		26.50	26.89	26.91		
90	1	0		22.60	23.16	23.01		
90	1	244		23.13	23.30	23.18		
90	243	0		25.58	25.80	25.86		
90	1	1	16-QAM	25.57	25.57	25.88	31.38	1.374
90	1	1	64-QAM	24.07	24.18	24.40		
90	1	1	256-QAM	22.14	22.06	22.42		
Limit	Power < 2W			Result			Pass	



5G-FR1 SA n41 (PC2) Maximum Average Power [dBm] (GT - LC = 5.5 dB)								
BW [MHz]	RB Size	RB Offset	Mod	Lowest	Middle	Highest	EIRP (dBm)	EIRP(W)
100	1	1	PI/2 BPSK	26.51	26.60	26.84	32.43	1.7498
100	1	271		26.64	26.83	26.63		
100	135	67		26.46	26.91	26.85		
100	1	0		22.61	23.09	23.07		
100	1	272		23.21	23.33	23.15		
100	270	0		26.04	26.40	26.33		
100	1	1	QPSK	26.51	26.61	26.82	31.27	1.3397
100	1	271		26.63	26.81	26.56		
100	135	67		26.49	26.93	26.84		
100	1	0		22.61	23.14	23.09		
100	1	272		23.13	23.34	23.17		
100	270	0		25.51	25.82	25.82		
100	1	1	16-QAM	25.45	25.56	25.77	31.27	1.3397
100	1	1	64-QAM	24.00	24.14	24.39		
100	1	1	256-QAM	21.98	22.19	22.33		
Limit	Power < 2W			Result			Pass	



5G-FR1 SA n66 Maximum Average Power [dBm] (GT - LC = 5 dB)								
BW [MHz]	RB Size	RB Offset	Mod	Lowest	Middle	Highest	EIRP (dBm)	EIRP(W)
5	1	1	PI/2 BPSK	24.73	24.72	24.70	29.75	0.9441
5	1	23		24.67	24.68	24.70		
5	12	6		24.72	24.74	24.73		
5	1	0		24.20	24.13	24.21		
5	1	24		24.23	24.14	24.22		
5	25	0		24.24	24.24	24.28		
5	1	1	QPSK	24.72	24.75	24.73		
5	1	23		24.73	24.69	24.73		
5	12	6		24.71	24.68	24.74		
5	1	0		23.76	23.70	23.72		
5	1	24		23.84	23.72	23.74		
5	25	0		23.78	23.70	23.78		
5	1	1	16-QAM	23.64	23.78	23.66	28.78	0.7551
5	1	1	64-QAM	22.47	22.43	22.43		
5	1	1	256-QAM	19.80	19.73	19.69		
Limit	EIRP < 1W			Result			Pass	

5G-FR1 SA n66 Maximum Average Power [dBm] (GT - LC = 5 dB)								
BW [MHz]	RB Size	RB Offset	Mod	Lowest	Middle	Highest	EIRP (dBm)	EIRP(W)
10	1	1	PI/2 BPSK	24.86	24.76	24.73	29.97	0.9931
10	1	50		24.86	24.64	24.72		
10	25	12		24.94	24.76	24.80		
10	1	0		24.38	24.21	24.29		
10	1	51		24.36	24.18	24.27		
10	50	0		24.41	24.23	24.28		
10	1	1	QPSK	24.83	24.76	24.81		
10	1	50		24.92	24.73	24.76		
10	25	12		24.97	24.76	24.76		
10	1	0		23.97	23.71	23.73		
10	1	51		23.86	23.72	23.76		
10	50	0		23.92	23.75	23.78		
10	1	1	16-QAM	23.73	23.61	23.70	28.73	0.7464
10	1	1	64-QAM	22.54	22.47	22.49		
10	1	1	256-QAM	19.82	19.77	19.76		
Limit	EIRP < 1W			Result			Pass	



5G-FR1 SA n66 Maximum Average Power [dBm] (GT - LC = 5 dB)										
BW [MHz]	RB Size	RB Offset	Mod	Lowest	Middle	Highest	EIRP (dBm)	EIRP(W)		
15	1	1	PI/2 BPSK	24.91	24.94	24.88	29.99	0.9977		
15	1	77		24.87	24.85	24.92				
15	36	18		24.97	24.92	24.90				
15	1	0		24.50	24.40	24.40				
15	1	78		24.54	24.32	24.36				
15	75	0		24.51	24.46	24.41				
15	1	1	QPSK	24.93	24.97	24.91			28.86	0.7691
15	1	77		24.89	24.89	24.91				
15	36	18		24.99	24.93	24.97				
15	1	0		24.03	23.95	23.90				
15	1	78		24.12	23.91	23.86				
15	75	0		24.01	24.01	23.95				
15	1	1	16-QAM	23.86	23.86	23.80	28.86	0.7691		
15	1	1	64-QAM	22.69	22.63	22.64				
15	1	1	256-QAM	20.03	19.95	19.95				
Limit	EIRP < 1W			Result			Pass			

5G-FR1 SA n66 Maximum Average Power [dBm] (GT - LC = 5 dB)										
BW [MHz]	RB Size	RB Offset	Mod	Lowest	Middle	Highest	EIRP (dBm)	EIRP(W)		
20	1	1	PI/2 BPSK	24.98	24.97	24.95	29.99	0.9977		
20	1	104		24.98	24.86	24.92				
20	50	25		24.83	24.94	24.97				
20	1	0		24.55	24.54	24.40				
20	1	105		24.50	24.37	24.36				
20	100	0		24.45	24.44	24.47				
20	1	1	QPSK	24.95	24.99	24.98			28.91	0.7780
20	1	104		24.81	24.93	24.95				
20	50	25		24.92	24.97	24.88				
20	1	0		24.04	23.96	24.01				
20	1	105		24.04	23.93	23.91				
20	100	0		24.00	23.96	23.97				
20	1	1	16-QAM	23.87	23.86	23.91	28.91	0.7780		
20	1	1	64-QAM	22.70	22.76	22.71				
20	1	1	256-QAM	20.05	20.04	20.02				
Limit	EIRP < 1W			Result			Pass			



5G-FR1 SA n66 Maximum Average Power [dBm] (GT - LC = 5 dB)								
BW [MHz]	RB Size	RB Offset	Mod	Lowest	Middle	Highest	EIRP (dBm)	EIRP(W)
25	1	1	PI/2 BPSK	24.96	24.98	24.97	29.98	0.9954
25	1	131		24.96	24.98	24.97		
25	64	32		24.96	24.97	24.91		
25	1	0		24.93	24.76	24.80		
25	1	132		24.88	24.72	24.84		
25	128	0		24.50	24.50	24.41		
25	1	1	QPSK	24.92	24.97	24.98		
25	1	131		24.89	24.96	24.94		
25	64	32		24.93	24.98	24.92		
25	1	0		24.42	24.42	24.33		
25	1	132		24.34	24.40	24.34		
25	128	0		24.11	23.99	23.96		
25	1	1	16-QAM	24.11	24.09	24.08	29.11	0.8147
25	1	1	64-QAM	22.97	22.95	22.96		
25	1	1	256-QAM	20.26	20.18	20.23		
Limit	EIRP < 1W			Result			Pass	

5G-FR1 SA n66 Maximum Average Power [dBm] (GT - LC = 5 dB)								
BW [MHz]	RB Size	RB Offset	Mod	Lowest	Middle	Highest	EIRP (dBm)	EIRP(W)
30	1	1	PI/2 BPSK	24.97	24.95	24.93	29.98	0.9954
30	1	158		24.93	24.93	24.96		
30	80	40		24.93	24.89	24.94		
30	1	0		24.64	24.54	24.54		
30	1	159		24.39	24.44	24.44		
30	160	0		24.65	24.51	24.48		
30	1	1	QPSK	24.91	24.94	24.93		
30	1	158		24.88	24.98	24.97		
30	80	40		24.93	24.95	24.92		
30	1	0		24.22	24.07	24.12		
30	1	159		23.98	24.01	24.03		
30	160	0		24.16	24.01	23.99		
30	1	1	16-QAM	24.03	23.75	23.90	29.03	0.7998
30	1	1	64-QAM	22.85	22.65	22.75		
30	1	1	256-QAM	20.13	19.94	20.12		
Limit	EIRP < 1W			Result			Pass	



5G-FR1 SA n66 Maximum Average Power [dBm] (GT - LC = 5 dB)										
BW [MHz]	RB Size	RB Offset	Mod	Lowest	Middle	Highest	EIRP (dBm)	EIRP(W)		
35	1	1	PI/2 BPSK	24.87	24.74	24.95	29.95	0.9886		
35	1	186		24.92	24.70	24.87				
35	90	45		24.91	24.93	24.94				
35	1	0		24.36	24.33	24.66				
35	1	187		24.59	24.25	24.46				
35	180	0		24.57	24.62	24.67				
35	1	1	QPSK	24.92	24.59	4.94			29.79	0.9528
35	1	186		24.86	24.49	24.86				
35	90	45		24.91	24.92	24.45				
35	1	0		24.21	24.19	24.41				
35	1	187		24.20	24.12	24.45				
35	180	0		24.05	24.13	24.19				
35	1	1	16-QAM	24.07	23.87	23.96	29.79	0.9528		
35	1	1	64-QAM	22.92	22.71	24.79				
35	1	1	256-QAM	20.15	20.10	20.02				
Limit	EIRP < 1W			Result			Pass			

5G-FR1 SA n66 Maximum Average Power [dBm] (GT - LC = 5 dB)										
BW [MHz]	RB Size	RB Offset	Mod	Lowest	Middle	Highest	EIRP (dBm)	EIRP(W)		
40	1	1	PI/2 BPSK	24.95	24.91	24.91	29.97	0.9931		
40	1	214		24.94	24.94	24.96				
40	108	54		24.91	24.92	24.88				
40	1	0		24.69	24.51	24.62				
40	1	215		24.49	24.44	24.50				
40	216	0		24.52	24.43	24.52				
40	1	1	QPSK	24.97	24.96	24.94			28.97	0.7889
40	1	214		24.93	24.93	24.91				
40	108	54		24.97	24.93	24.89				
40	1	0		24.15	24.10	24.16				
40	1	215		24.01	23.94	23.99				
40	216	0		24.02	24.02	24.06				
40	1	1	16-QAM	23.97	23.87	23.92	28.97	0.7889		
40	1	1	64-QAM	22.76	22.62	22.75				
40	1	1	256-QAM	20.00	19.99	20.03				
Limit	EIRP < 1W			Result			Pass			



5G-FR1 SA n71 Maximum Average Power [dBm] (GT - LC = 2.2 dB)										
BW [MHz]	RB Size	RB Offset	Mod	Lowest	Middle	Highest	ERP (dBm)	ERP(W)		
5	1	1	PI/2 BPSK	24.72	24.61	24.65	24.81	0.3027		
5	1	23		24.76	24.61	24.63				
5	12	6		24.71	24.73	24.67				
5	1	0		24.41	24.18	24.21				
5	1	24		24.23	24.21	24.10				
5	25	0		24.26	24.15	24.12				
5	1	1	QPSK	24.76	24.64	24.63			24.81	0.3027
5	1	23		24.75	24.58	24.66				
5	12	6		24.72	24.67	24.60				
5	1	0		23.87	23.67	23.74				
5	1	24		23.72	23.67	23.68				
5	25	0		23.84	23.63	23.58				
5	1	1	16-QAM	23.73	23.63	23.69	23.78	0.2388		
5	1	1	64-QAM	22.48	22.24	22.32				
5	1	1	256-QAM	19.78	19.65	19.69				
Limit	ERP < 1000W			Result			Pass			

5G-FR1 SA n71 Maximum Average Power [dBm] (GT - LC = 2.2 dB)										
BW [MHz]	RB Size	RB Offset	Mod	Lowest	Middle	Highest	ERP (dBm)	ERP(W)		
10	1	1	PI/2 BPSK	24.78	24.61	24.66	24.83	0.3041		
10	1	50		24.74	24.64	24.69				
10	25	12		24.68	24.66	24.64				
10	1	0		24.43	24.31	24.25				
10	1	51		24.15	24.17	24.15				
10	50	0		24.16	24.15	24.10				
10	1	1	QPSK	24.75	24.64	24.67			24.83	0.3041
10	1	50		24.67	24.67	24.71				
10	25	12		24.75	24.66	24.65				
10	1	0		23.94	23.82	23.74				
10	1	51		23.68	23.64	23.71				
10	50	0		23.75	23.66	23.61				
10	1	1	16-QAM	23.70	23.69	23.71	23.76	0.2377		
10	1	1	64-QAM	22.48	22.28	22.33				
10	1	1	256-QAM	19.74	19.66	19.66				
Limit	ERP < 1000W			Result			Pass			



5G-FR1 SA n71 Maximum Average Power [dBm] (GT - LC = 2.2 dB)								
BW [MHz]	RB Size	RB Offset	Mod	Lowest	Middle	Highest	ERP (dBm)	ERP(W)
15	1	1	PI/2 BPSK	24.75	24.77	24.73	24.99	0.3155
15	1	77		24.88	24.64	24.74		
15	36	18		24.74	24.78	24.71		
15	1	0		24.45	24.49	24.38		
15	1	78		24.39	24.07	24.19		
15	75	0		24.28	24.25	24.19		
15	1	1	QPSK	24.82	24.81	24.70		
15	1	77		24.94	24.60	24.71		
15	36	18		24.83	24.78	24.69		
15	1	0		24.01	24.00	23.89		
15	1	78		23.86	23.66	23.74		
15	75	0		23.78	23.81	23.69		
15	1	1	16-QAM	23.77	23.84	23.85	23.90	0.2455
15	1	1	64-QAM	22.47	22.50	22.43		
15	1	1	256-QAM	19.85	19.79	19.85		
Limit	ERP < 1000W			Result			Pass	

5G-FR1 SA n71 Maximum Average Power [dBm] (GT - LC = 2.2 dB)								
BW [MHz]	RB Size	RB Offset	Mod	Lowest	Middle	Highest	ERP (dBm)	ERP(W)
20	1	1	PI/2 BPSK	24.71	24.78	24.87	24.96	0.3133
20	1	104		24.70	24.70	24.65		
20	50	25		24.74	24.84	24.65		
20	1	0		24.55	24.54	24.49		
20	1	105		24.18	24.18	24.11		
20	100	0		24.27	24.32	24.21		
20	1	1	QPSK	24.76	24.77	24.91		
20	1	104		24.70	24.71	24.69		
20	50	25		24.84	24.79	24.65		
20	1	0		24.06	24.06	23.98		
20	1	105		23.68	23.70	23.67		
20	100	0		23.83	23.81	23.68		
20	1	1	16-QAM	23.66	23.69	23.84	23.89	0.2449
20	1	1	64-QAM	22.48	22.42	22.54		
20	1	1	256-QAM	19.77	19.76	19.81		
Limit	ERP < 1000W			Result			Pass	



<MIMO Mode>

5G-FR1 SA n41 MIMO (PC2) Maximum Average Power [dBm], DG = 5.46 dBi														
BW (MHz)	RB Size	RB Offset	Mod	Antenna 12			Antenna 13			Combine			EIRP (dBm)	EIRP (W)
				Lowest	Middle	Highest	Lowest	Middle	Highest	Lowest	Middle	Highest		
10	1	1	QPSK	21.79	22.04	21.73	22.05	22.27	22.14	24.93	25.17	24.95	30.77	1.1940
10	1	22		21.75	22.10	21.72	22.14	22.47	22.59	24.96	25.30	25.19		
10	12	6		21.91	22.08	21.70	22.11	22.50	22.20	25.02	25.31	24.97		
10	1	0		19.69	20.06	19.57	20.13	20.37	20.24	22.93	23.23	22.93		
10	1	23		19.86	20.08	19.60	19.95	20.40	20.19	22.92	23.25	22.92		
10	24	0		20.36	20.55	20.18	20.62	21.00	20.69	23.50	23.79	23.45		
10	1	1	16-QAM	21.35	21.56	21.23	21.95	21.99	21.62	24.67	24.79	24.44	30.25	1.0593
10	1	1	64-QAM	19.86	20.08	19.76	20.33	20.37	20.20	23.11	23.24	23.00		
10	1	1	256-QAM	16.85	17.04	16.55	17.10	17.58	17.36	19.99	20.33	19.98		
Limit	Power < 2W			Result									Pass	

5G-FR1 SA n41 MIMO (PC2) Maximum Average Power [dBm], DG = 5.46 dBi														
BW (MHz)	RB Size	RB Offset	Mod	Antenna 12			Antenna 13			Combine			EIRP (dBm)	EIRP (W)
				Lowest	Middle	Highest	Lowest	Middle	Highest	Lowest	Middle	Highest		
15	1	1	QPSK	21.97	22.22	21.96	22.14	22.59	22.47	25.07	25.42	25.23	30.95	1.2445
15	1	36		21.99	22.30	22.02	22.40	22.65	22.60	25.21	25.49	25.33		
15	19	9		21.88	22.29	21.87	22.28	22.64	22.49	25.09	25.48	25.20		
15	1	0		19.92	20.31	19.88	20.39	20.74	20.56	23.17	23.54	23.24		
15	1	37		20.11	20.34	19.91	20.26	20.79	20.63	23.20	23.58	23.30		
15	38	0		20.39	20.78	20.50	20.78	21.18	21.04	23.60	23.99	23.79		
15	1	1	16-QAM	21.37	21.79	21.41	21.73	22.05	21.96	24.56	24.93	24.70	30.39	1.0940
15	1	1	64-QAM	19.96	20.22	19.72	20.43	20.56	20.41	23.21	23.40	23.09		
15	1	1	256-QAM	16.97	17.24	16.83	17.32	17.72	17.42	20.16	20.50	20.15		
Limit	Power < 2W			Result									Pass	

5G-FR1 SA n41 MIMO (PC2) Maximum Average Power [dBm], DG = 5.46 dBi														
BW (MHz)	RB Size	RB Offset	Mod	Antenna 12			Antenna 13			Combine			EIRP (dBm)	EIRP (W)
				Lowest	Middle	Highest	Lowest	Middle	Highest	Lowest	Middle	Highest		
20	1	1	QPSK	21.82	22.01	21.97	22.06	22.57	22.44	24.95	25.31	25.22	30.92	1.2359
20	1	49		21.71	22.13	21.76	22.13	22.59	22.25	24.94	25.38	25.02		
20	25	12		21.88	22.14	21.75	22.10	22.74	22.50	25.00	25.46	25.15		
20	1	0		19.75	20.03	19.76	20.23	20.61	20.62	23.01	23.34	23.22		
20	1	50		19.92	20.21	19.80	20.04	20.61	20.41	22.99	23.42	23.13		
20	51	0		20.34	20.62	20.24	20.60	21.16	20.98	23.48	23.91	23.64		
20	1	1	16-QAM	21.38	21.60	21.43	21.66	21.96	22.10	24.53	24.79	24.79	30.25	1.0593
20	1	1	64-QAM	19.89	19.86	19.93	20.19	20.52	20.56	23.05	23.21	23.27		
20	1	1	256-QAM	16.84	17.07	16.91	17.26	17.61	17.57	20.07	20.36	20.26		
Limit	Power < 2W			Result									Pass	



5G-FR1 SA n41 MIMO (PC2) Maximum Average Power [dBm], DG = 5.46 dBi														
BW	RB	RB	Mod	Antenna 12			Antenna 13			Combine			EIRP	EIRP
(MHz)	Size	Offset		Lowest	Middle	Highest	Lowest	Middle	Highest	Lowest	Middle	Highest	(dBm)	(W)
30	1	1	QPSK	21.95	22.16	22.11	22.16	22.36	22.69	25.07	25.27	25.42	30.94	1.2417
30	1	76		22.15	22.34	22.19	22.37	22.60	22.71	25.27	25.48	25.47		
30	39	19		21.85	22.26	22.04	22.18	22.60	22.67	25.03	25.44	25.38		
30	1	0		19.76	20.14	20.02	20.37	20.74	20.92	23.09	23.46	23.50		
30	1	77		20.01	20.36	20.05	20.41	20.79	20.75	23.22	23.59	23.42		
30	78	0		20.41	20.78	20.54	20.76	21.17	21.24	23.60	23.99	23.91		
30	1	1	16-QAM	21.56	21.81	21.69	21.65	21.82	22.14	24.62	24.83	24.93	30.39	1.0940
30	1	1	64-QAM	20.02	20.24	20.02	20.32	20.56	20.73	23.18	23.41	23.40		
30	1	1	256-QAM	17.05	17.32	17.11	17.15	17.45	17.72	20.11	20.40	20.44		
Limit	Power < 2W			Result									Pass	

5G-FR1 SA n41 MIMO (PC2) Maximum Average Power [dBm], DG = 5.46 dBi														
BW	RB	RB	Mod	Antenna 12			Antenna 13			Combine			EIRP	EIRP
(MHz)	Size	Offset		Lowest	Middle	Highest	Lowest	Middle	Highest	Lowest	Middle	Highest	(dBm)	(W)
40	1	1	QPSK	22.02	22.03	22.11	22.18	22.40	22.61	25.11	25.23	25.38	30.94	1.2417
40	1	104		21.74	22.26	21.85	22.59	22.67	22.75	25.20	25.48	25.33		
40	53	26		21.72	22.21	21.85	22.08	22.66	22.55	24.91	25.45	25.22		
40	1	0		19.80	20.06	19.82	20.56	20.67	20.87	23.21	23.39	23.39		
40	1	105		19.74	20.28	19.84	20.44	20.72	20.70	23.11	23.52	23.30		
40	106	0		20.36	20.60	20.39	20.72	21.12	21.12	23.55	23.88	23.78		
40	1	1	16-QAM	21.42	21.65	21.56	21.81	21.93	21.94	24.63	24.80	24.76	30.26	1.0617
40	1	1	64-QAM	20.19	20.10	20.06	20.14	20.58	20.63	23.18	23.36	23.36		
40	1	1	256-QAM	16.88	17.09	17.12	17.27	17.57	17.84	20.09	20.35	20.51		
Limit	Power < 2W			Result									Pass	

5G-FR1 SA n41 MIMO (PC2) Maximum Average Power [dBm], DG = 5.46 dBi														
BW	RB	RB	Mod	Antenna 12			Antenna 13			Combine			EIRP	EIRP
(MHz)	Size	Offset		Lowest	Middle	Highest	Lowest	Middle	Highest	Lowest	Middle	Highest	(dBm)	(W)
50	1	1	QPSK	21.65	22.02	22.09	22.14	22.35	22.58	24.91	25.20	25.35	30.81	1.2050
50	1	131		21.66	22.11	21.83	22.59	22.50	22.56	25.16	25.32	25.22		
50	67	33		21.73	22.11	21.94	22.32	22.55	22.54	25.05	25.35	25.26		
50	1	0		19.55	20.08	19.73	20.57	20.66	20.84	23.10	23.39	23.33		
50	1	132		19.64	20.21	19.79	20.66	20.56	20.50	23.19	23.40	23.17		
50	133	0		20.30	20.65	20.39	20.87	21.06	21.14	23.60	23.87	23.79		
50	1	1	16-QAM	21.30	21.48	21.53	21.60	21.87	21.88	24.46	24.69	24.72	30.18	1.0423
50	1	1	64-QAM	19.80	20.03	20.04	20.38	20.53	20.55	23.11	23.30	23.31		
50	1	1	256-QAM	16.97	17.02	17.07	17.26	17.38	17.57	20.13	20.21	20.34		
Limit	Power < 2W			Result									Pass	



5G-FR1 SA n41 MIMO (PC2) Maximum Average Power [dBm], DG = 5.46 dBi														
BW	RB	RB	Mod	Antenna 12			Antenna 13			Combine			EIRP	EIRP
(MHz)	Size	Offset		Lowest	Middle	Highest	Lowest	Middle	Highest	Lowest	Middle	Highest	(dBm)	(W)
60	1	1	QPSK	21.74	21.91	21.89	21.99	22.24	22.27	24.88	25.09	25.09	30.82	1.2078
60	1	160		21.61	22.05	21.71	22.40	22.26	22.39	25.03	25.17	25.07		
60	81	40		21.60	22.12	21.82	22.19	22.56	22.55	24.92	25.36	25.21		
60	1	0		19.37	19.97	19.71	20.36	20.57	20.68	22.90	23.29	23.23		
60	1	161		19.61	19.97	19.67	20.52	20.25	20.55	23.10	23.12	23.14		
60	162	0		20.20	20.60	20.33	20.73	20.97	21.05	23.48	23.80	23.72		
60	1	1	16-QAM	21.10	21.72	21.41	21.53	21.84	21.53	24.33	24.79	24.48	30.25	1.0593
60	1	1	64-QAM	19.82	19.90	19.87	20.11	20.31	20.38	22.98	23.12	23.14		
60	1	1	256-QAM	16.89	17.04	16.80	17.08	17.34	17.25	20.00	20.20	20.04		
Limit	Power < 2W			Result									Pass	

5G-FR1 SA n41 MIMO (PC2) Maximum Average Power [dBm], DG = 5.46 dBi														
BW	RB	RB	Mod	Antenna 12			Antenna 13			Combine			EIRP	EIRP
(MHz)	Size	Offset		Lowest	Middle	Highest	Lowest	Middle	Highest	Lowest	Middle	Highest	(dBm)	(W)
70	1	1	QPSK	21.65	21.82	21.77	21.79	22.09	21.95	24.73	24.97	24.87	30.59	1.1455
70	1	187		21.62	21.88	21.51	22.52	22.31	22.46	25.10	25.11	25.02		
70	95	47		21.59	21.92	21.73	22.21	22.31	22.21	24.92	25.13	24.99		
70	1	0		19.28	19.69	19.52	20.29	20.56	20.41	22.82	23.16	23.00		
70	1	188		19.51	19.68	19.44	20.15	20.36	20.21	22.85	23.04	22.85		
70	189	0		20.06	20.46	20.19	20.66	20.80	20.69	23.38	23.64	23.46		
70	1	1	16-QAM	21.10	21.31	21.36	21.47	21.62	21.74	24.30	24.48	24.56	30.02	1.0046
70	1	1	64-QAM	19.81	19.96	19.60	19.74	20.09	20.36	22.79	23.04	23.01		
70	1	1	256-QAM	16.76	16.92	16.77	17.05	16.97	17.48	19.92	19.96	20.15		
Limit	Power < 2W			Result									Pass	

5G-FR1 SA n41 MIMO (PC2) Maximum Average Power [dBm], DG = 5.46 dBi														
BW	RB	RB	Mod	Antenna 12			Antenna 13			Combine			EIRP	EIRP
(MHz)	Size	Offset		Lowest	Middle	Highest	Lowest	Middle	Highest	Lowest	Middle	Highest	(dBm)	(W)
80	1	1	QPSK	21.61	21.69	21.78	21.84	22.09	22.40	24.74	24.90	25.11	30.61	1.1508
80	1	215		21.58	21.76	21.61	22.03	22.26	22.34	24.82	25.03	25.00		
80	109	54		21.49	21.92	21.74	22.13	22.35	22.35	24.83	25.15	25.07		
80	1	0		19.25	19.63	19.53	20.35	20.68	20.75	22.85	23.20	23.19		
80	1	216		19.56	19.83	19.53	20.07	20.26	20.13	22.83	23.06	22.85		
80	217	0		20.04	20.38	20.22	20.62	20.75	20.83	23.35	23.58	23.55		
80	1	1	16-QAM	21.14	21.34	21.18	21.24	21.52	21.74	24.20	24.44	24.48	29.94	0.9863
80	1	1	64-QAM	19.67	19.70	20.02	19.98	20.07	20.36	22.84	22.90	23.20		
80	1	1	256-QAM	16.38	16.73	16.79	16.97	17.31	17.31	19.70	20.04	20.07		
Limit	Power < 2W			Result									Pass	



5G-FR1 SA n41 MIMO (PC2) Maximum Average Power [dBm], DG = 5.46 dBi														
BW	RB	RB	Mod	Antenna 12			Antenna 13			Combine			EIRP	EIRP
(MHz)	Size	Offset		Lowest	Middle	Highest	Lowest	Middle	Highest	Lowest	Middle	Highest	(dBm)	(W)
90	1	1	QPSK	21.65	21.81	21.87	21.89	22.23	22.19	24.78	25.04	25.04	30.65	1.1614
90	1	243		21.85	21.70	21.66	22.40	22.55	22.43	25.14	25.16	25.07		
90	123	61		21.55	21.95	21.78	22.24	22.29	22.54	24.92	25.13	25.19		
90	1	0		19.14	19.53	19.58	20.53	20.72	20.92	22.90	23.18	23.31		
90	1	244		19.66	19.78	19.63	20.31	20.28	20.34	23.01	23.05	23.01		
90	245	0		20.14	20.28	20.26	20.71	20.77	21.02	23.44	23.54	23.67		
90	1	1	16-QAM	21.22	21.35	21.75	21.39	21.76	21.87	24.32	24.57	24.82	30.28	1.0666
90	1	1	64-QAM	19.51	19.70	20.04	19.78	20.04	20.09	22.66	22.88	23.08		
90	1	1	256-QAM	16.61	16.82	17.15	16.75	17.20	17.17	19.69	20.02	20.17		
Limit	Power < 2W			Result									Pass	

5G-FR1 SA n41 MIMO (PC2) Maximum Average Power [dBm], DG = 5.46 dBi														
BW	RB	RB	Mod	Antenna 12			Antenna 13			Combine			EIRP	EIRP
(MHz)	Size	Offset		Lowest	Middle	Highest	Lowest	Middle	Highest	Lowest	Middle	Highest	(dBm)	(W)
100	1	1	QPSK	21.51	21.70	22.01	21.90	22.16	22.21	24.72	24.95	25.12	30.60	1.1482
100	1	271		21.70	21.88	21.56	22.23	22.32	22.42	24.98	25.12	25.02		
100	137	68		21.48	21.97	21.74	22.20	22.29	22.32	24.87	25.14	25.05		
100	1	0		19.10	19.71	19.64	20.57	20.73	20.88	22.91	23.26	23.31		
100	1	272		19.68	19.86	19.56	20.30	20.50	20.24	23.01	23.20	22.92		
100	273	0		20.06	20.32	20.27	20.62	20.81	20.85	23.36	23.58	23.58		
100	1	1	16-QAM	21.24	21.19	21.50	21.49	21.65	21.57	24.38	24.44	24.55	30.01	1.0023
100	1	1	64-QAM	19.49	19.60	19.91	20.06	20.31	20.27	22.79	22.98	23.10		
100	1	1	256-QAM	16.69	16.78	17.13	16.98	17.34	17.31	19.85	20.08	20.23		
Limit	Power < 2W			Result									Pass	



5G-FR1 SA n12

Peak-to-Average Ratio

Mode	5G-FR1 SA n12 / 15MHz / DFT-S OFDM				
Mod.	PI/2 BPSK	QPSK	16QAM	64QAM	Limit: 13dB
RB Size	Full RB	Full RB	Full RB	Full RB	Result
Middle CH	4.56	5.62	6.52	6.60	PASS
Mode	5G-FR1 SA n12 / 15MHz / DFT-S OFDM				
Mod.	256QAM				Limit: 13dB
RB Size	Full RB				Result
Middle CH	6.66				PASS



5G-FR1 SA n12 / 15MHz / DFT-S OFDM / Middle Channel / Full RB

PI/2 BPSK

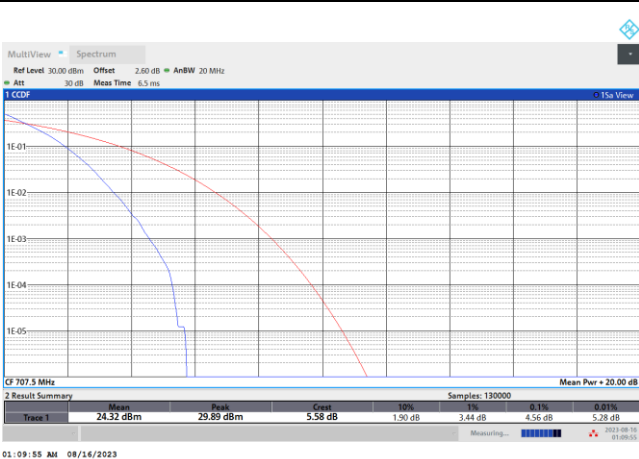

QPSK

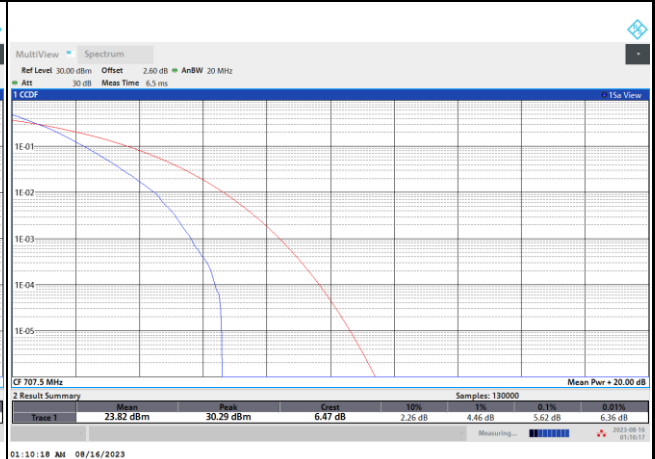

16QAM

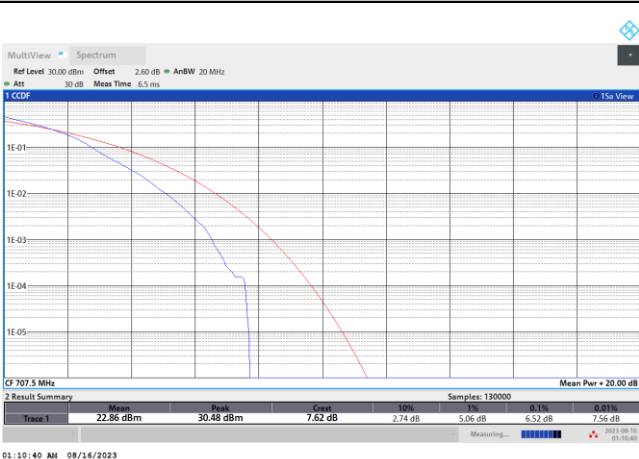

64QAM

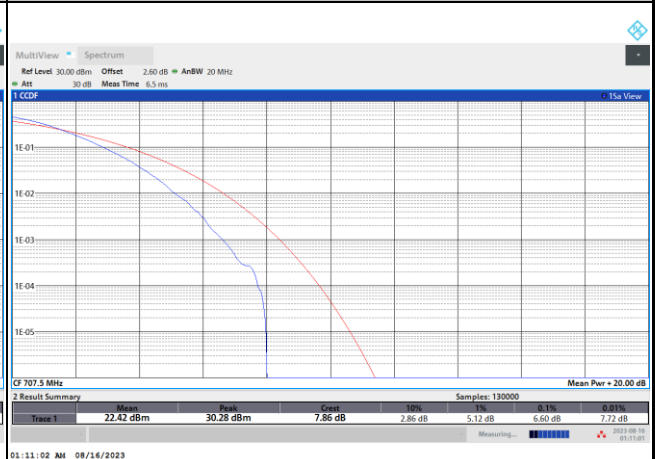

256QAM

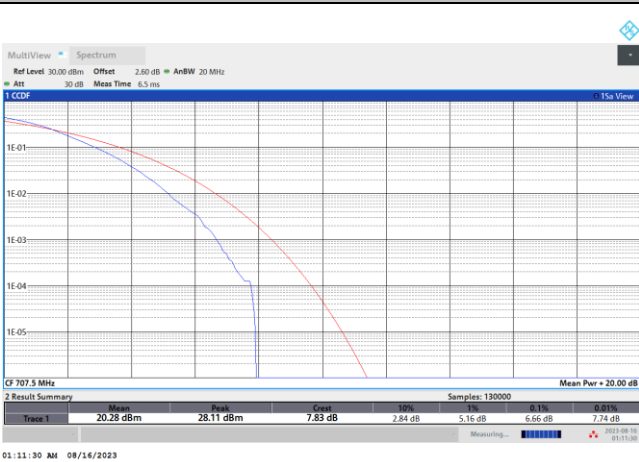



26dB Bandwidth

Mode	5G-FR1 SA n12 : 26dB BW(MHz) / DFT-S OFDM						
BW	5MHz		10MHz		15MHz		
Mod.	PI/2 BPSK		PI/2 BPSK		PI/2 BPSK		
Middle CH	5.18		9.65		14.57		

Mode	5G-FR1 SA n12 : 26dB BW(MHz) / CP OFDM						
BW	5MHz		10MHz		15MHz		
Mod.	QPSK	16QAM	QPSK	16QAM	QPSK	16QAM	
Middle CH	5.21	5.27	10.17	10.13	15.29	15.26	
Mod.	64QAM	256QAM	64QAM	256QAM	64QAM	256QAM	
Middle CH	5.25	5.29	10.11	10.09	15.29	15.29	



5G-FR1 SA n12 / 5MHz / DFT-S OFDM / Middle Channel / Full RB

PI/2 BPSK

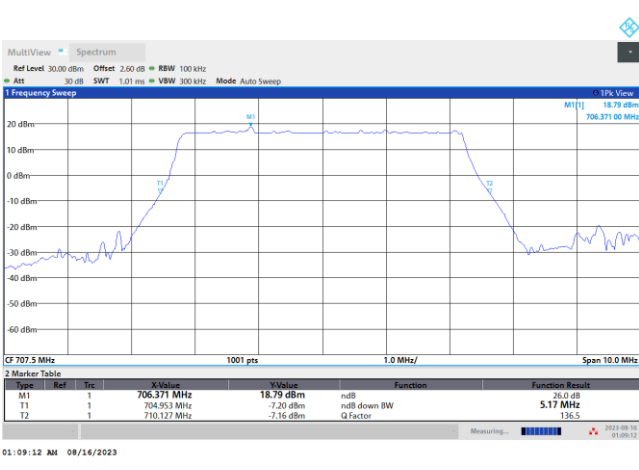

5G-FR1 SA n12 / 5MHz / CP OFDM / Middle Channel / Full RB

QPSK

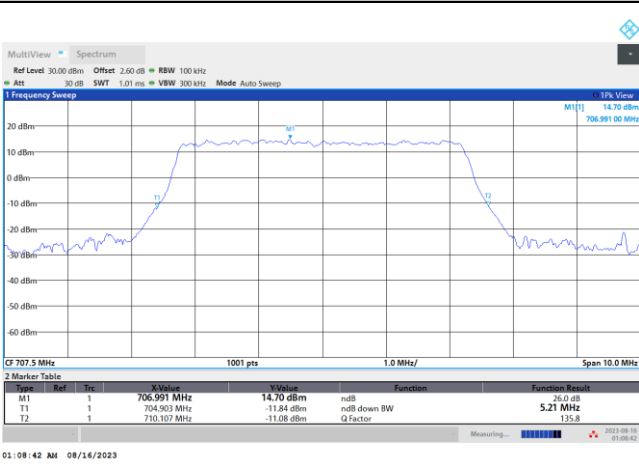

16QAM

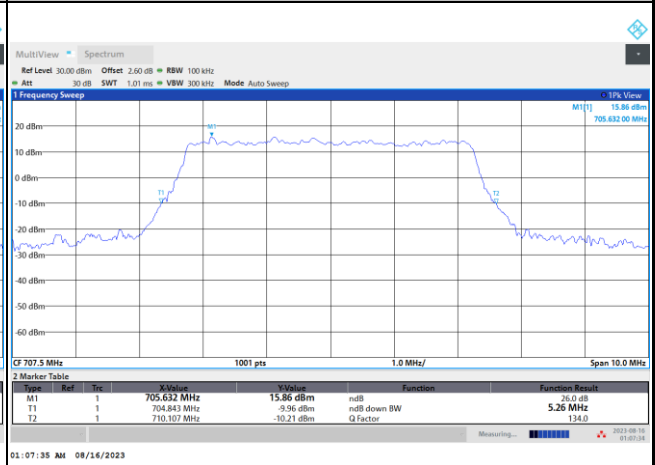

64QAM

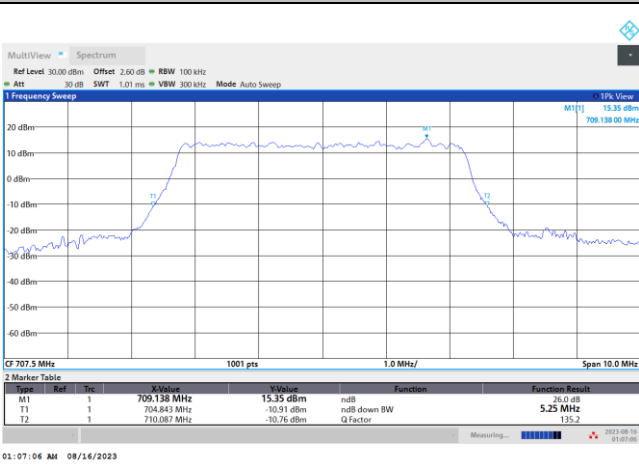

256QAM

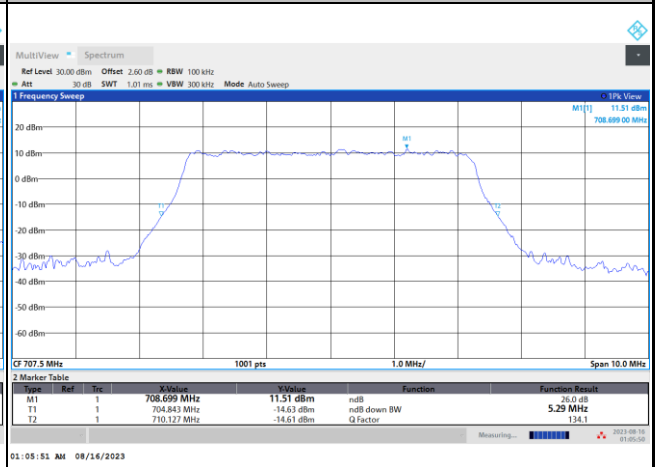



5G-FR1 SA n12 / 10MHz / DFT-S OFDM / Middle Channel / Full RB

PI/2 BPSK

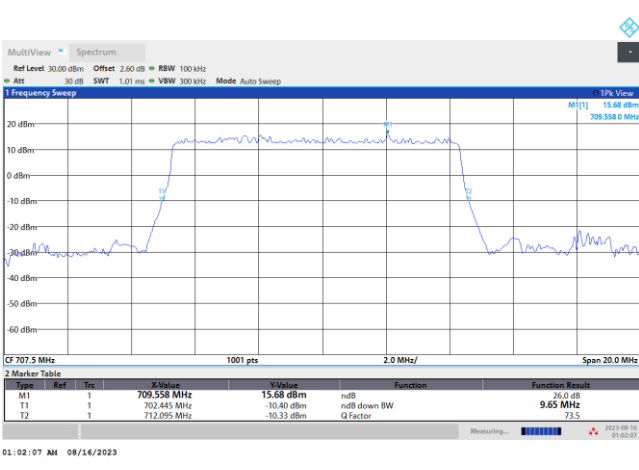

5G-FR1 SA n12 / 10MHz / CP OFDM / Middle Channel / Full RB

QPSK

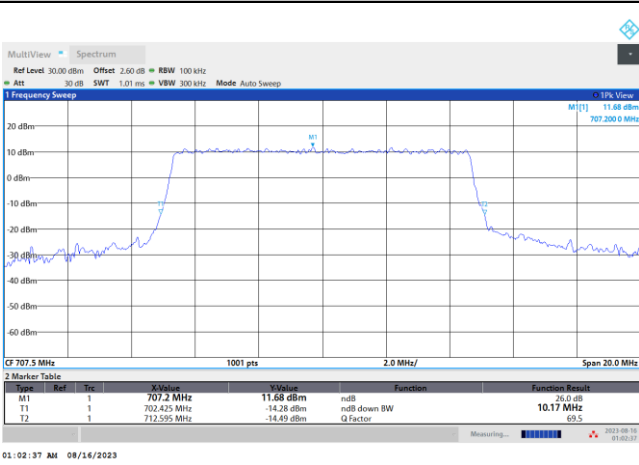

16QAM

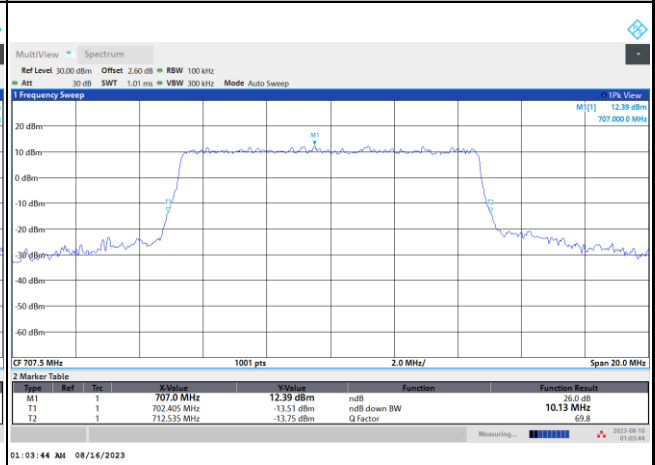

64QAM

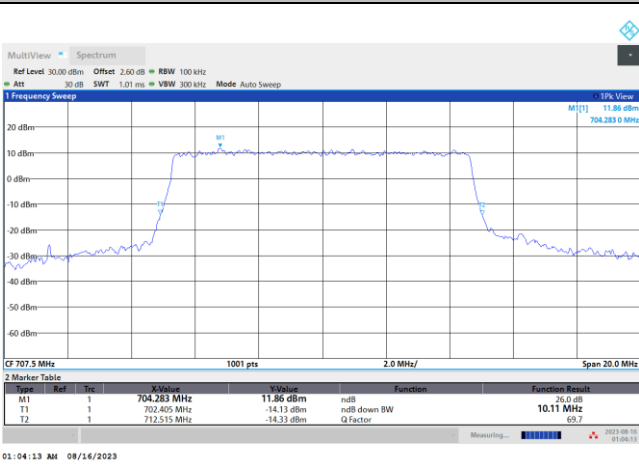

256QAM

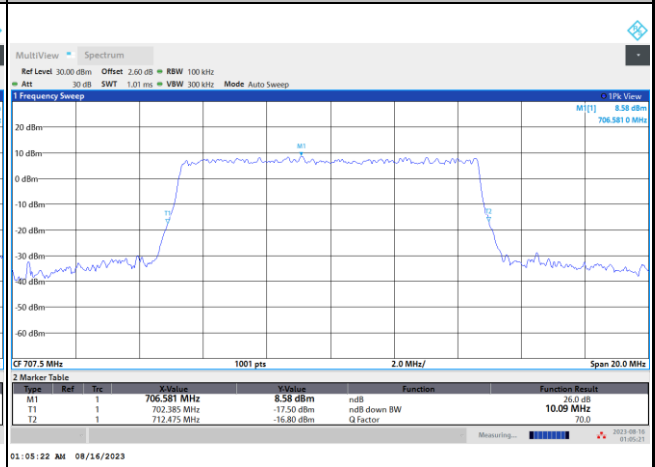



5G-FR1 SA n12 / 15MHz / DFT-S OFDM / Middle Channel / Full RB

PI/2 BPSK

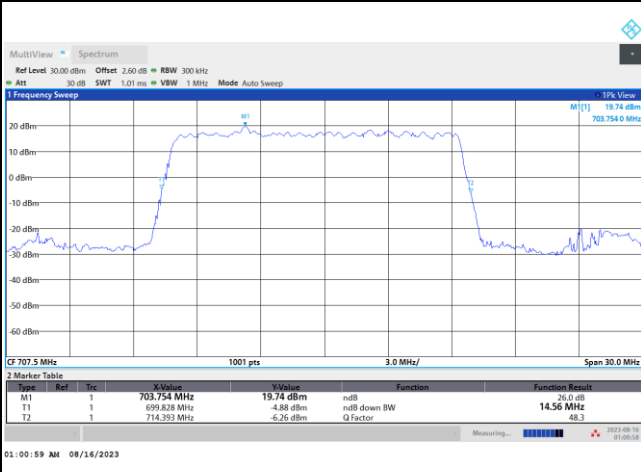

5G-FR1 SA n12 / 15MHz / CP OFDM / Middle Channel / Full RB

QPSK

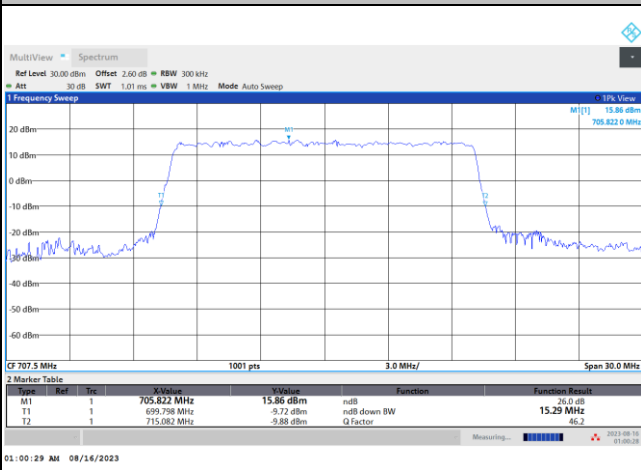

16QAM

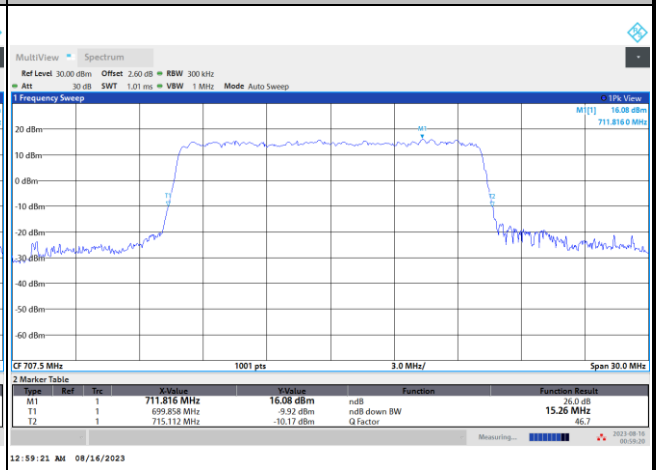

64QAM

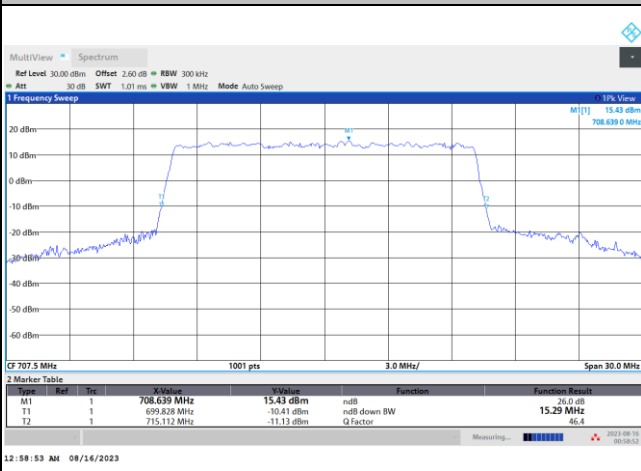

256QAM

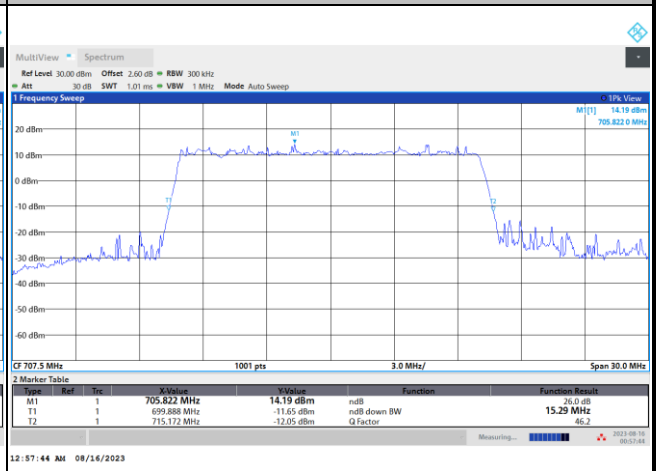



Occupied Bandwidth

Mode	5G-FR1 SA n12 : 99%OBW(MHz) / DFT-S OFDM						
BW	5MHz		10MHz		15MHz		
Mod.	PI/2 BPSK		PI/2 BPSK		PI/2 BPSK		
Middle CH	4.49		8.94		13.45		

Mode	5G-FR1 SA n12 : 99%OBW (MHz) / CP OFDM						
BW	5MHz		10MHz		15MHz		
Mod.	QPSK	16QAM	QPSK	16QAM	QPSK	16QAM	
Middle CH	4.52	4.52	9.28	9.29	14.13	14.14	
Mod.	64QAM	256QAM	64QAM	256QAM	64QAM	256QAM	
Middle CH	4.52	4.52	9.28	9.30	14.17	14.17	



5G-FR1 SA n12 / 5MHz / DFT-S OFDM / Middle Channel / Full RB

PI/2 BPSK

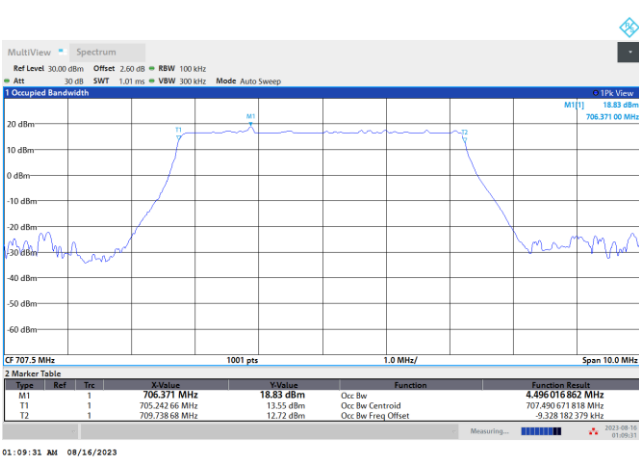

5G-FR1 SA n12 / 5MHz / CP OFDM / Middle Channel / Full RB

QPSK

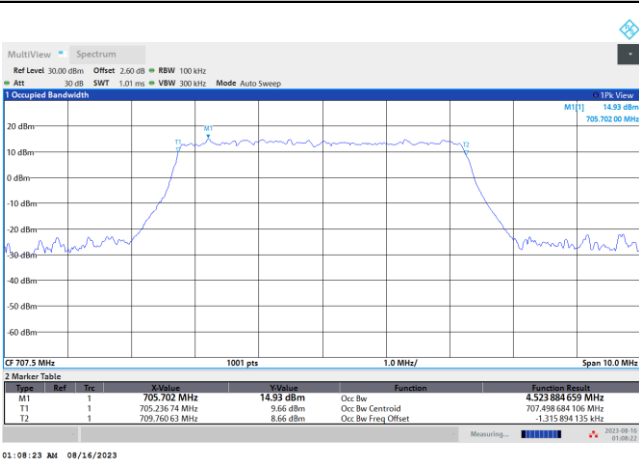

16QAM

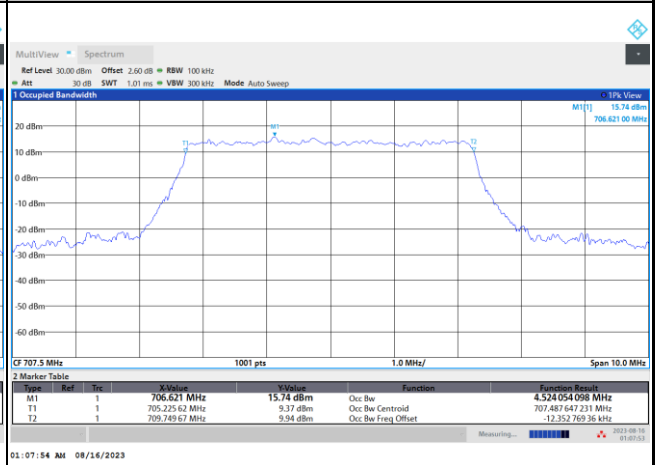

64QAM

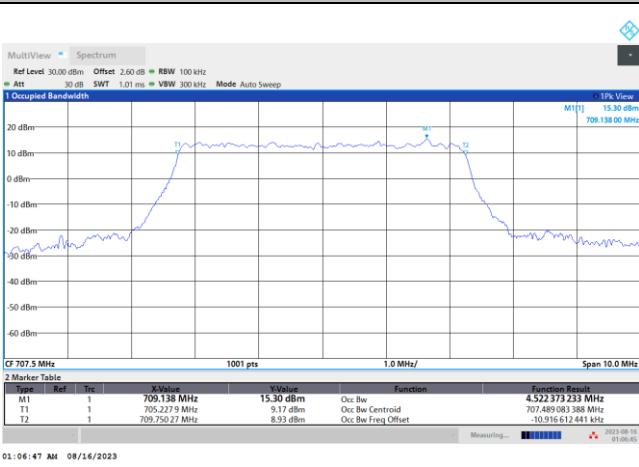

256QAM

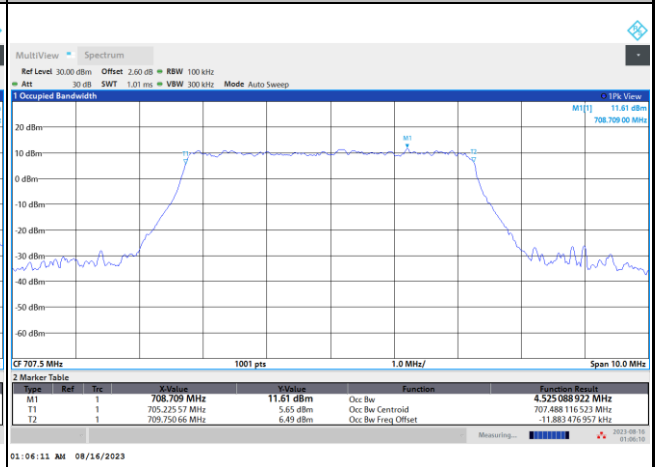



5G-FR1 SA n12 / 10MHz / DFT-S OFDM / Middle Channel / Full RB

PI/2 BPSK

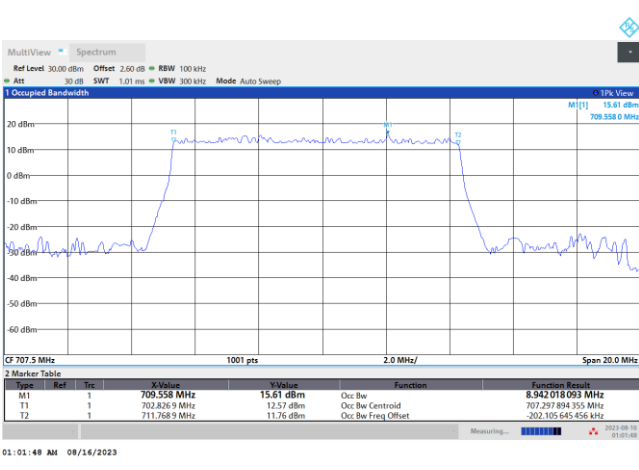

01:01:48 AM 08/14/2023

5G-FR1 SA n12 / 10MHz / CP OFDM / Middle Channel / Full RB

QPSK

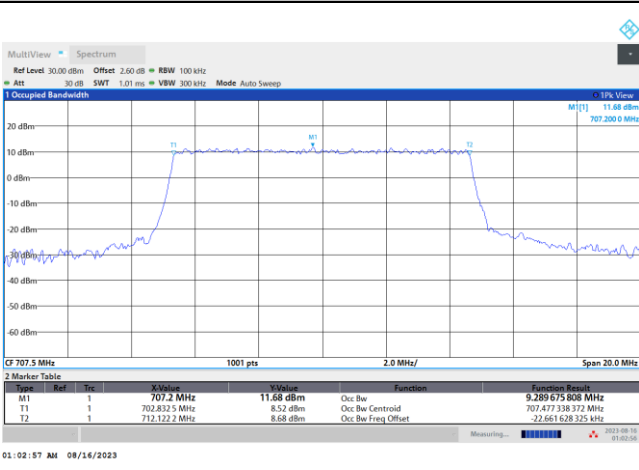

01:02:57 AM 08/14/2023

16QAM

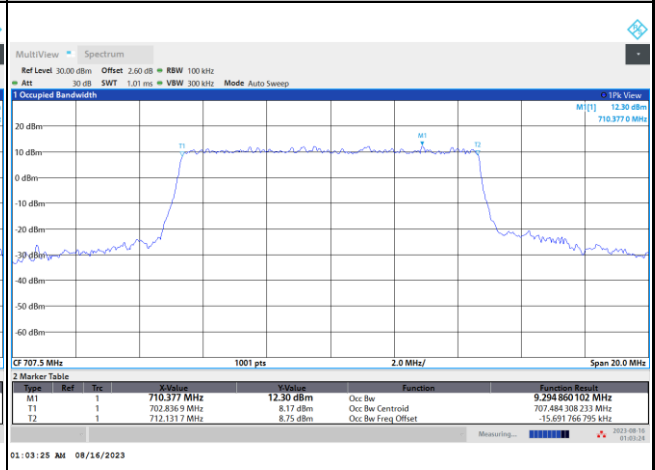

01:03:25 AM 08/14/2023

64QAM

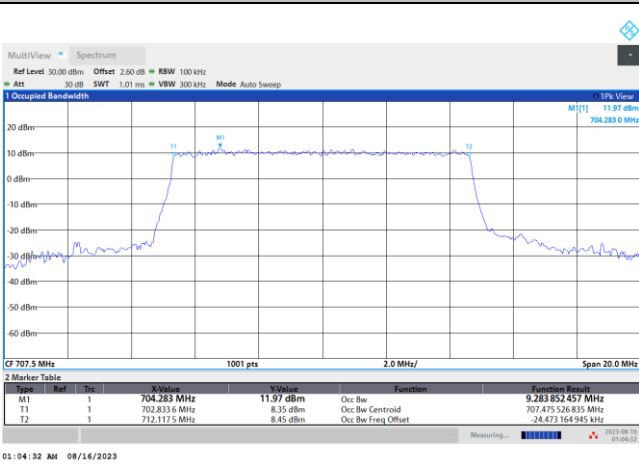

01:04:32 AM 08/14/2023

256QAM

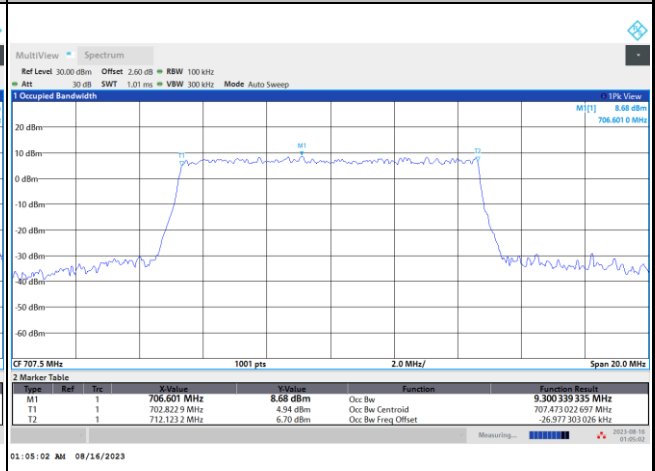

01:05:02 AM 08/14/2023



5G-FR1 SA n12 / 15MHz / DFT-S OFDM / Middle Channel / Full RB

PI/2 BPSK

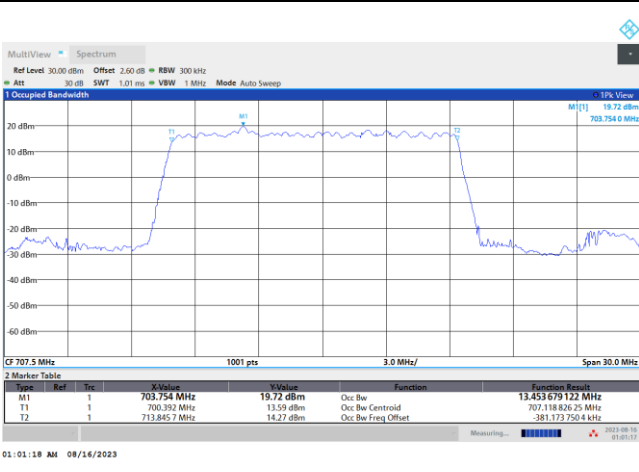

5G-FR1 SA n12 / 15MHz / CP OFDM / Middle Channel / Full RB

QPSK

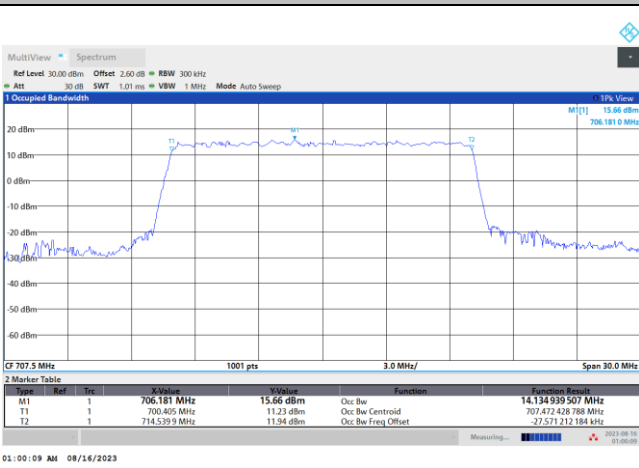

16QAM

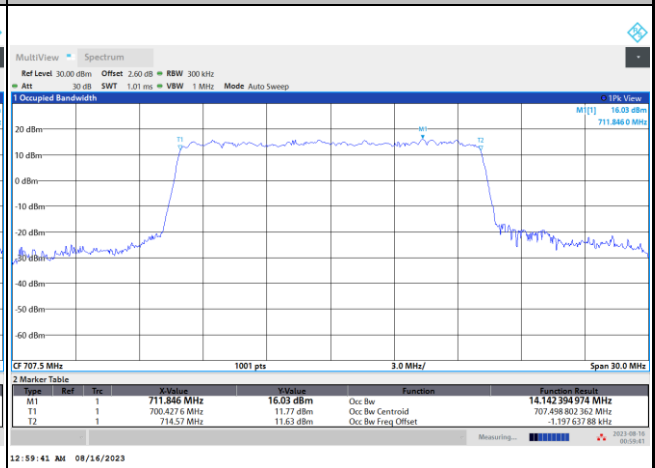

64QAM

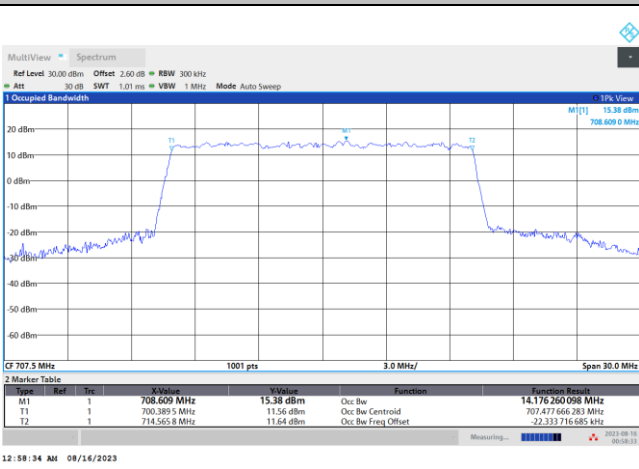

256QAM

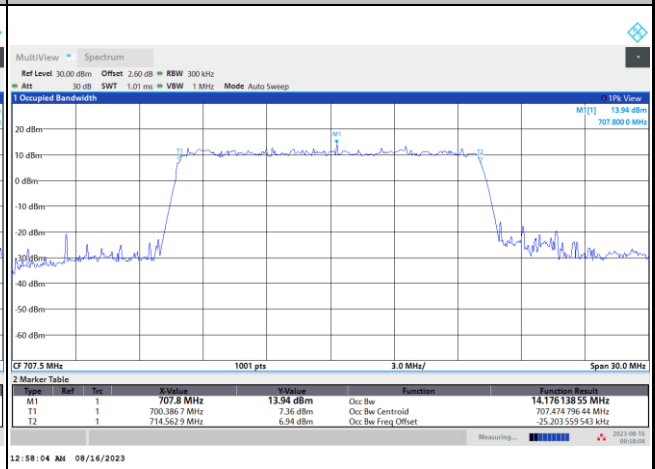



Conducted Band Edge

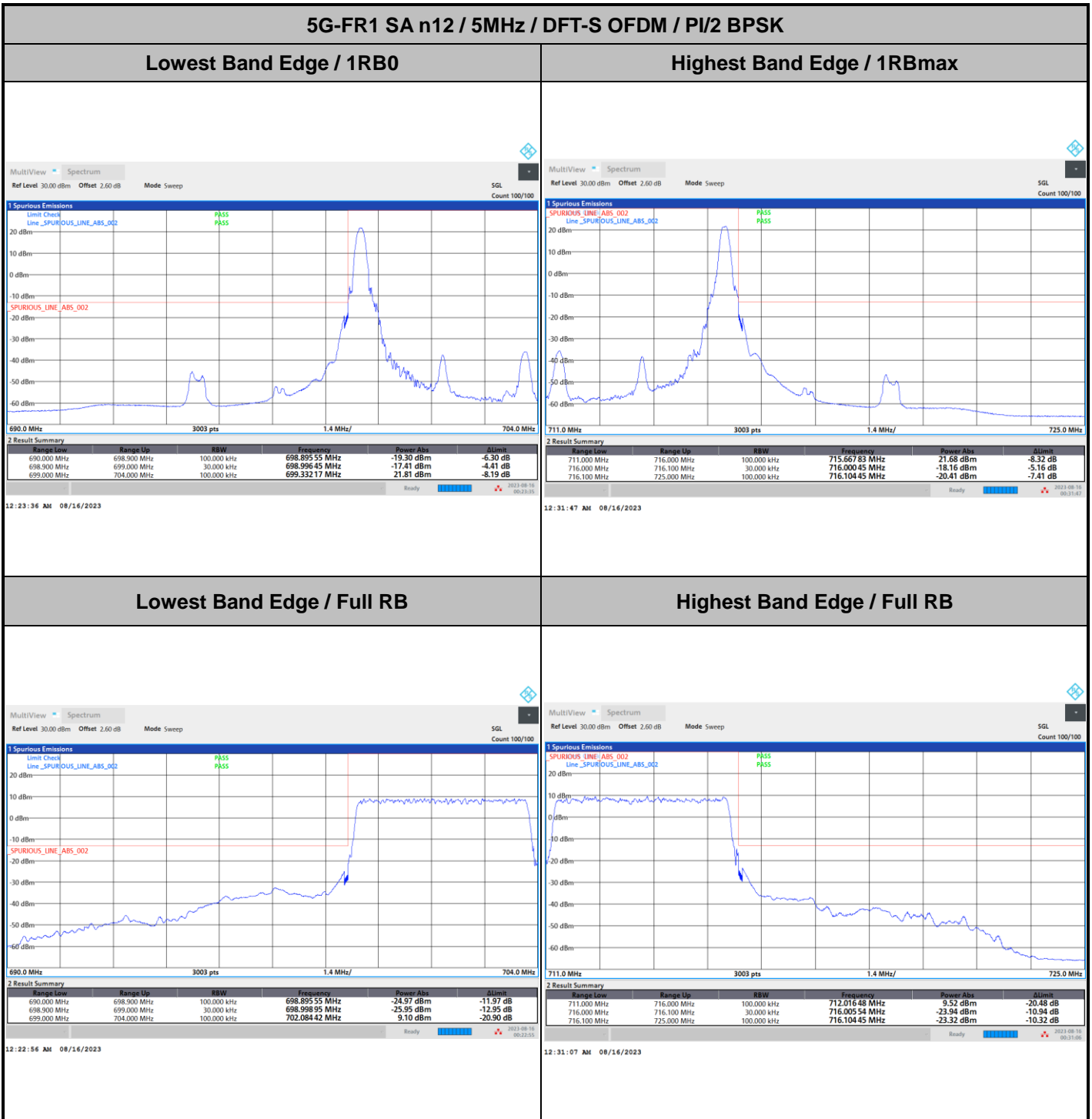



5G-FR1 SA n12 / 5MHz / DFT-S OFDM / QPSK

Lowest Band Edge / 1RB0

Highest Band Edge / 1RBmax

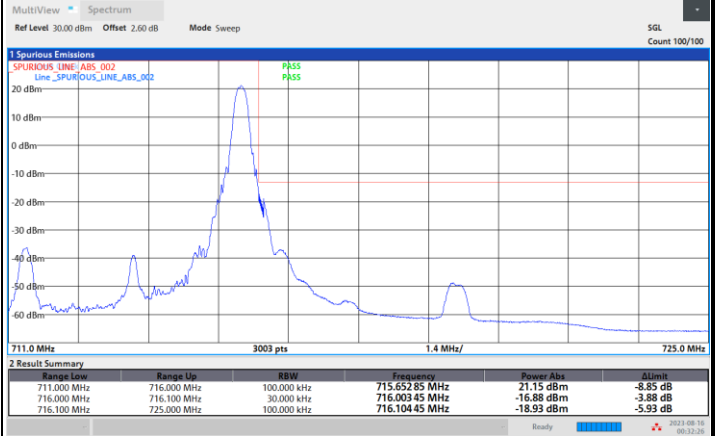
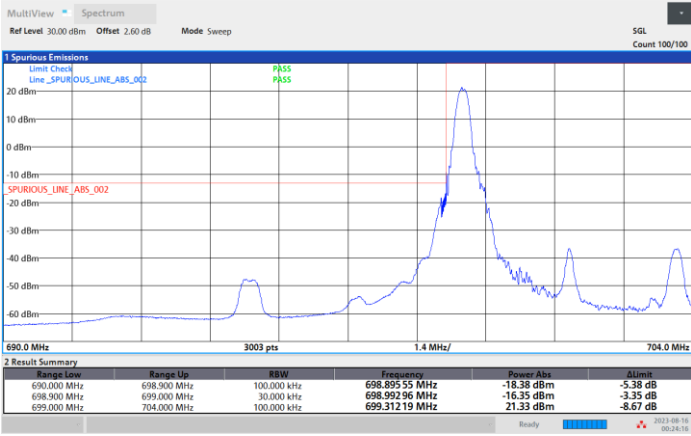

Lowest Band Edge / Full RB

Highest Band Edge / Full RB

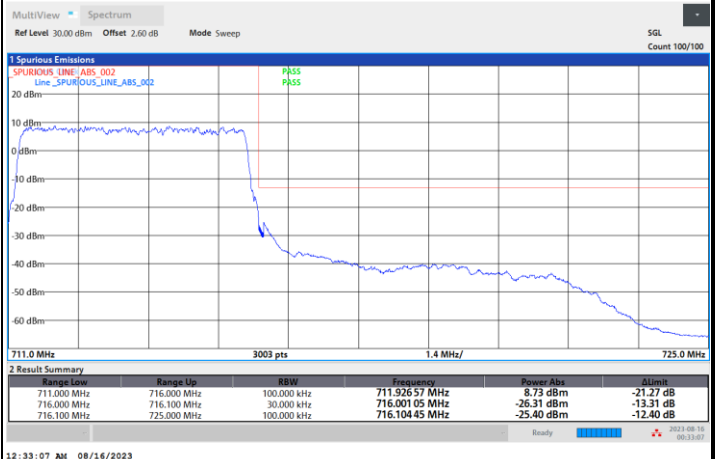
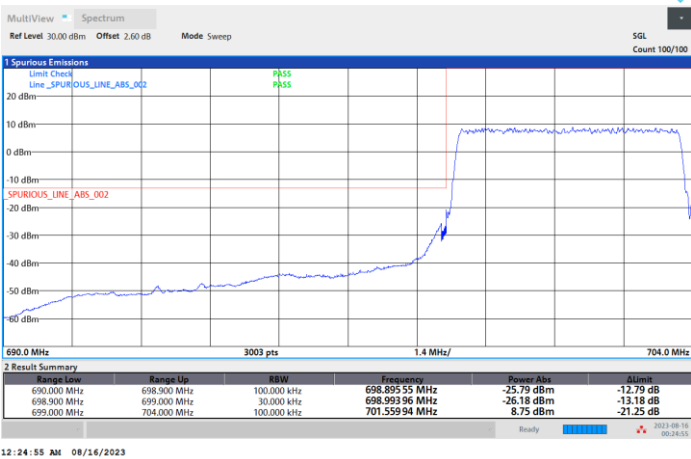



5G-FR1 SA n12 / 5MHz / DFT-S OFDM / 16QAM

Lowest Band Edge / 1RB0

Highest Band Edge / 1RBmax

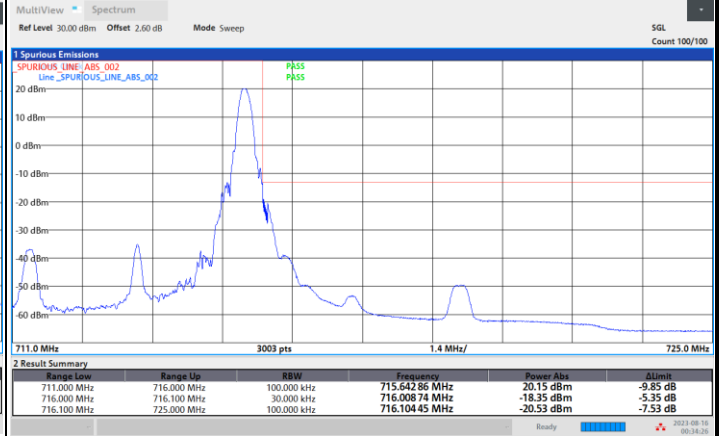
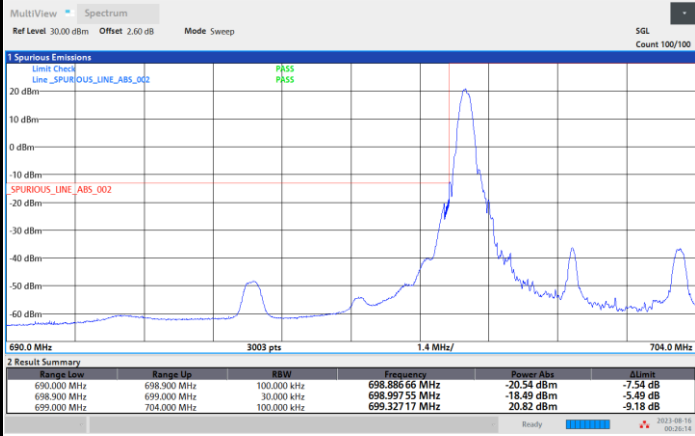

Lowest Band Edge / Full RB

Highest Band Edge / Full RB

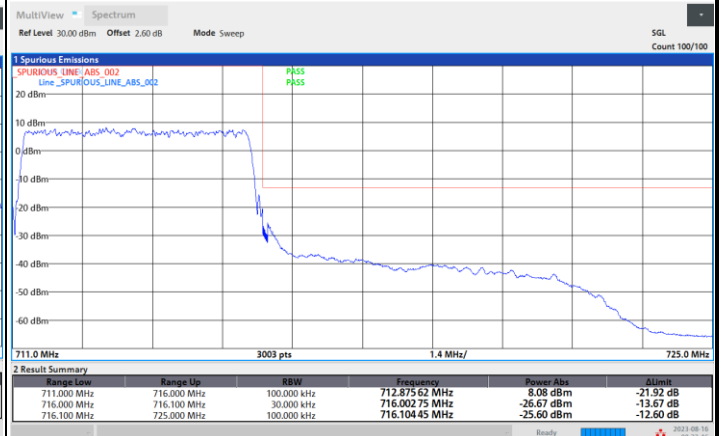
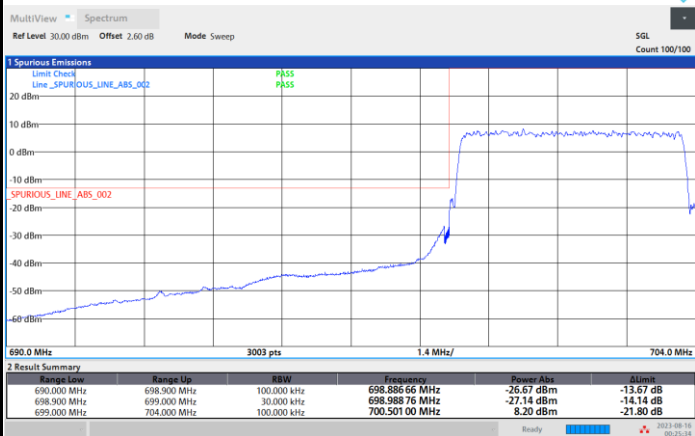



5G-FR1 SA n12 / 5MHz / DFT-S OFDM / 64QAM

Lowest Band Edge / 1RB0

Highest Band Edge / 1RBmax

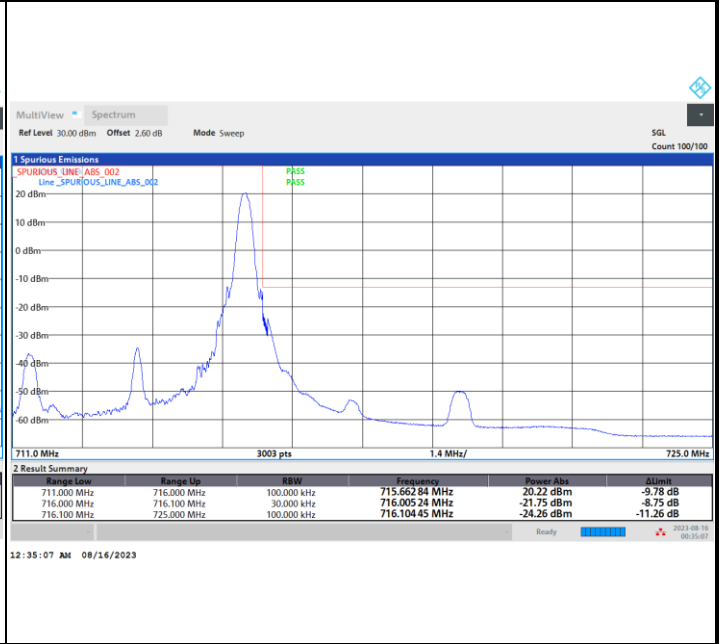
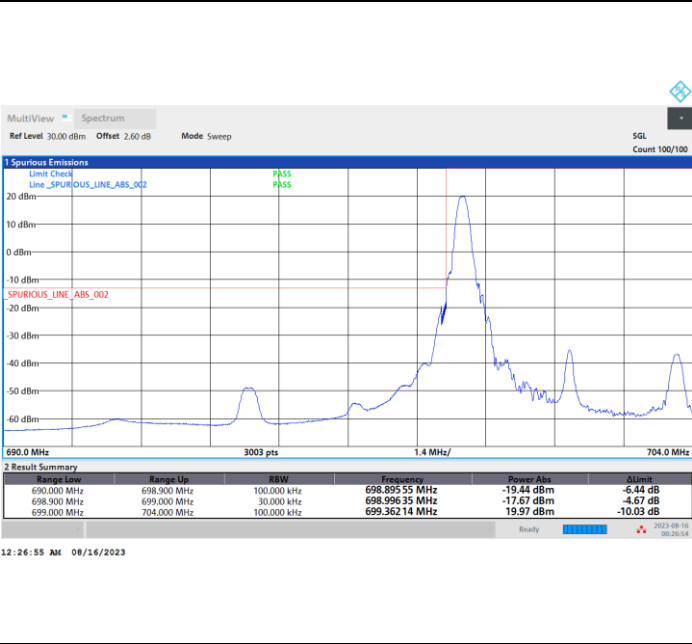

Lowest Band Edge / Full RB

Highest Band Edge / Full RB

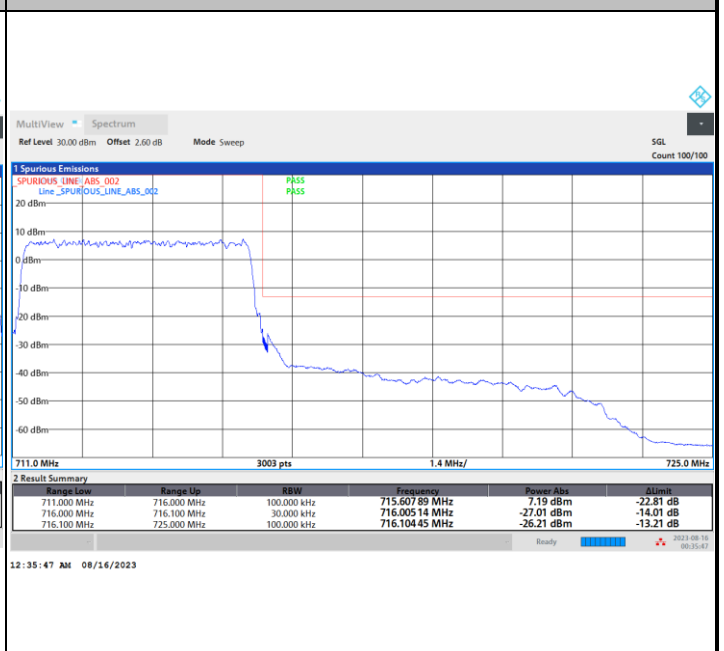
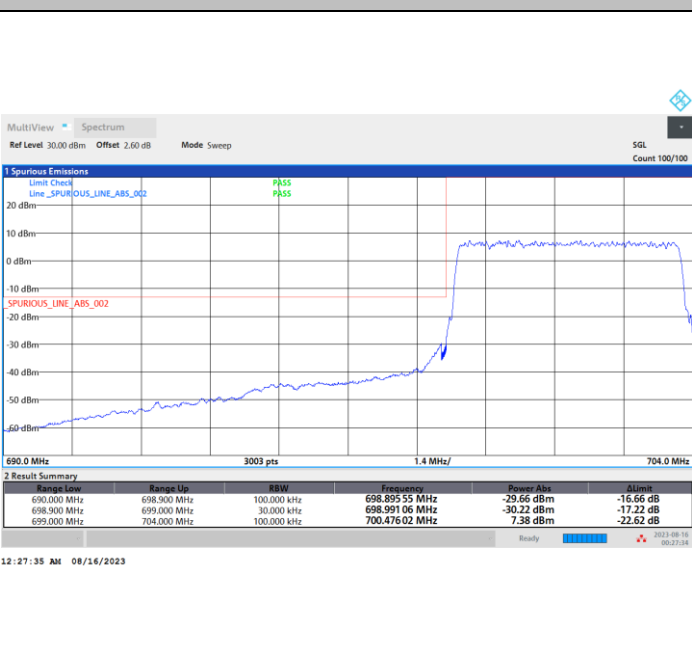



5G-FR1 SA n12 / 5MHz / DFT-S OFDM / 256QAM

Lowest Band Edge / 1RB0

Highest Band Edge / 1RBmax

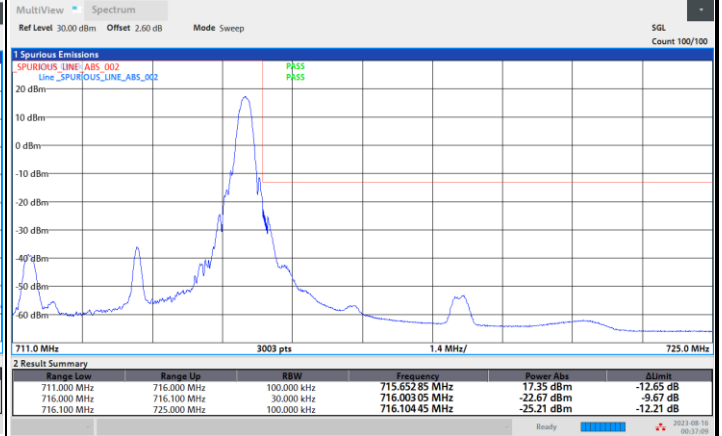
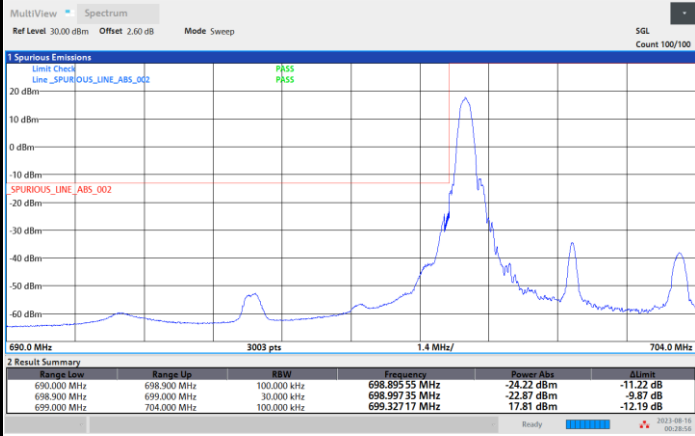

12:28:56 AM 08/16/2023

12:37:09 AM 08/16/2023

Lowest Band Edge / Full RB

Highest Band Edge / Full RB

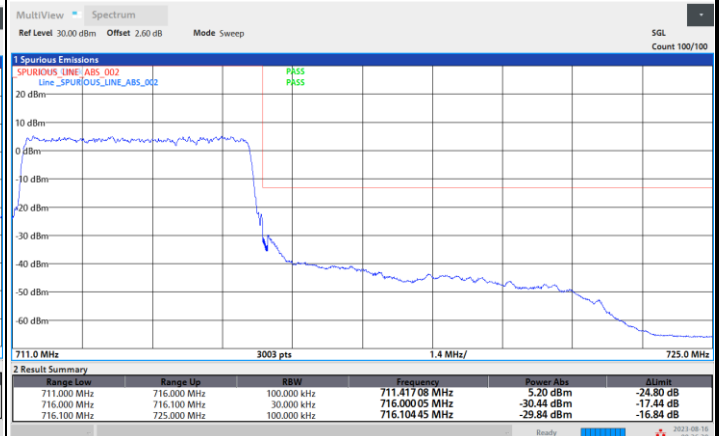
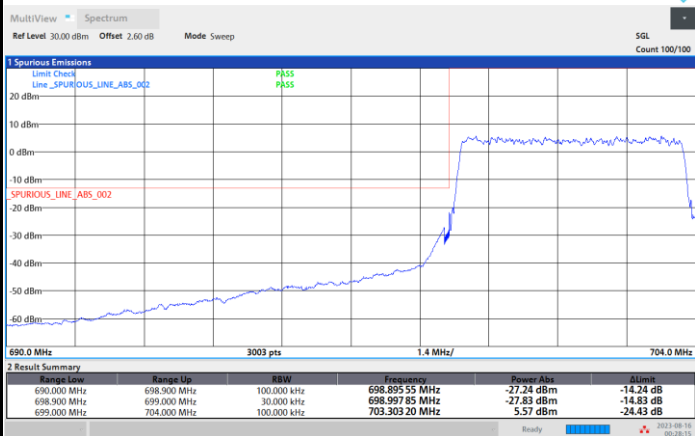

12:28:16 AM 08/16/2023

12:36:29 AM 08/16/2023

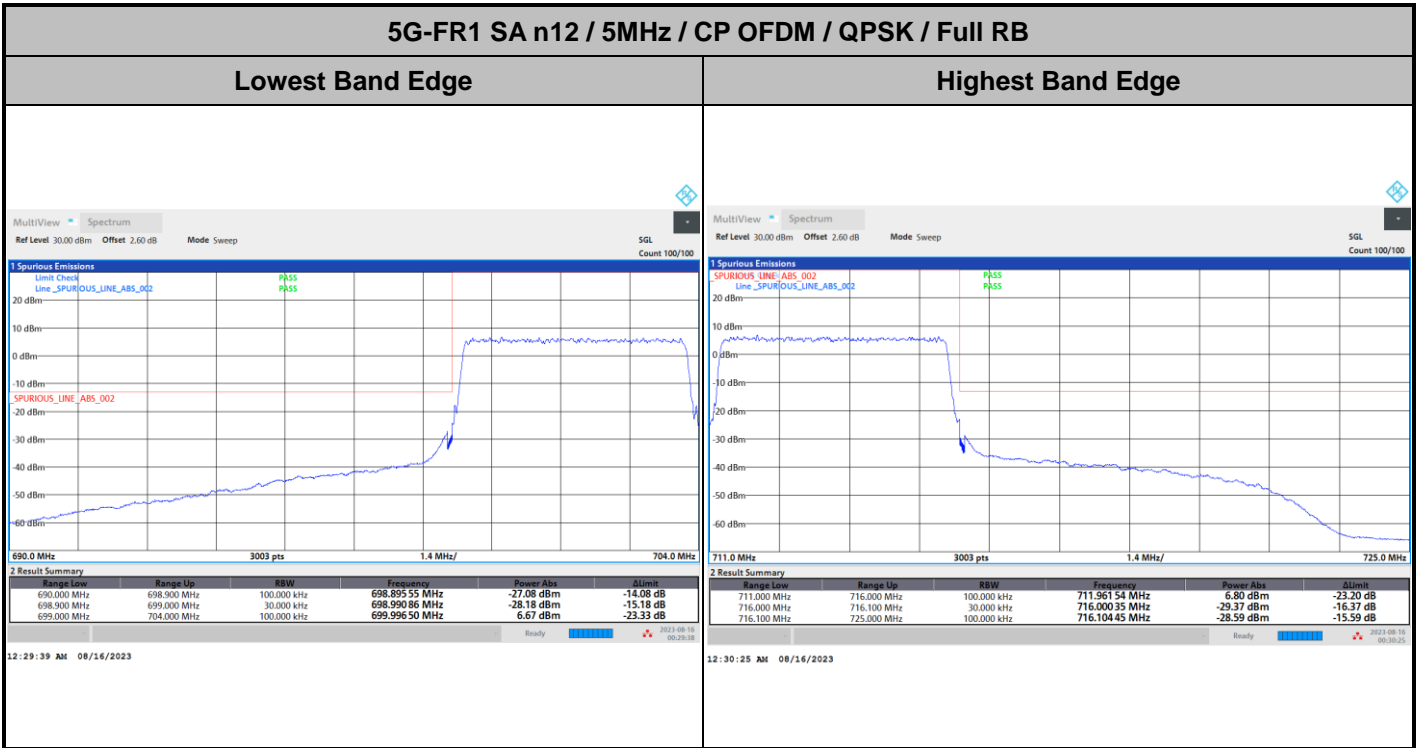



5G-FR1 SA n12 / 10MHz / DFT-s-OFDM / PI/2 BPSK / Full RB

Lowest Band Edge

Highest Band Edge

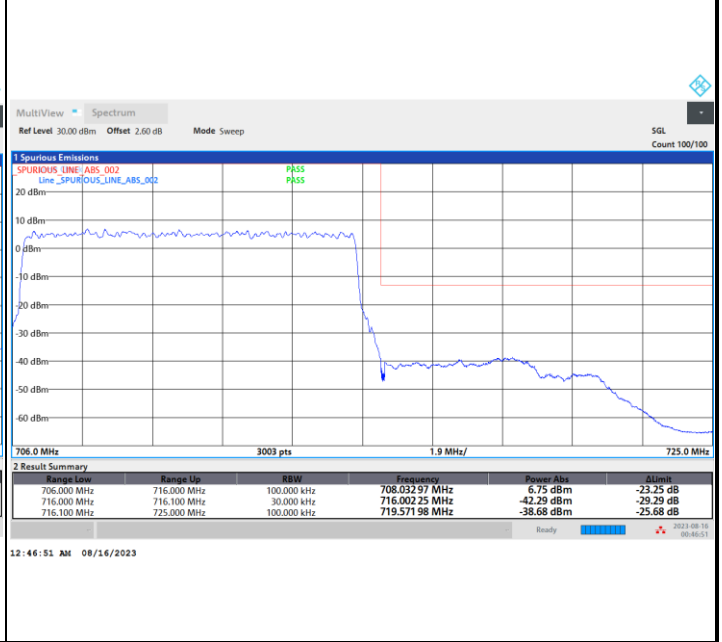
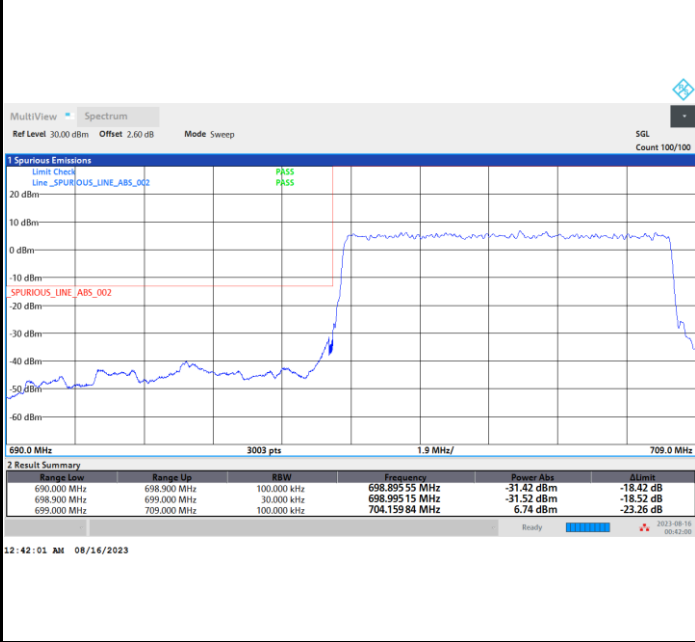

5G-FR1 SA n12 / 10MHz / DFT-s-OFDM / QPSK / Full RB

Lowest Band Edge

Highest Band Edge

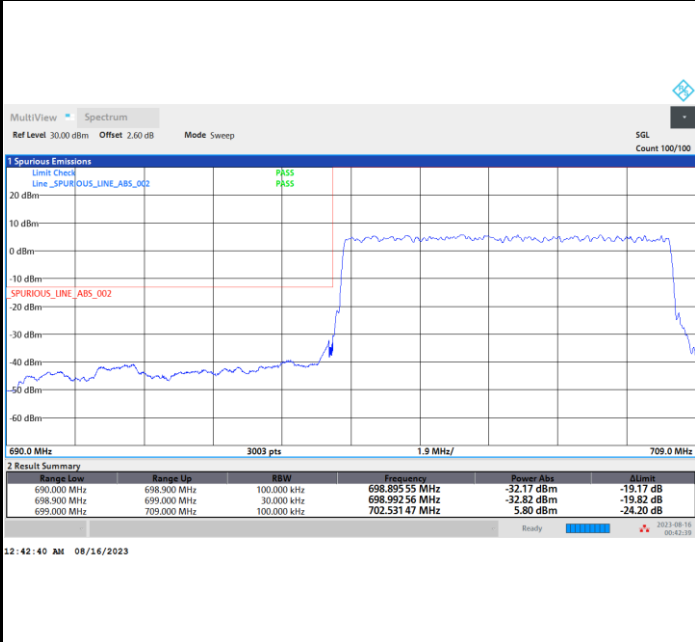



5G-FR1 SA n12 / 10MHz / DFT-s-OFDM / 16QAM / Full RB

Lowest Band Edge

Highest Band Edge

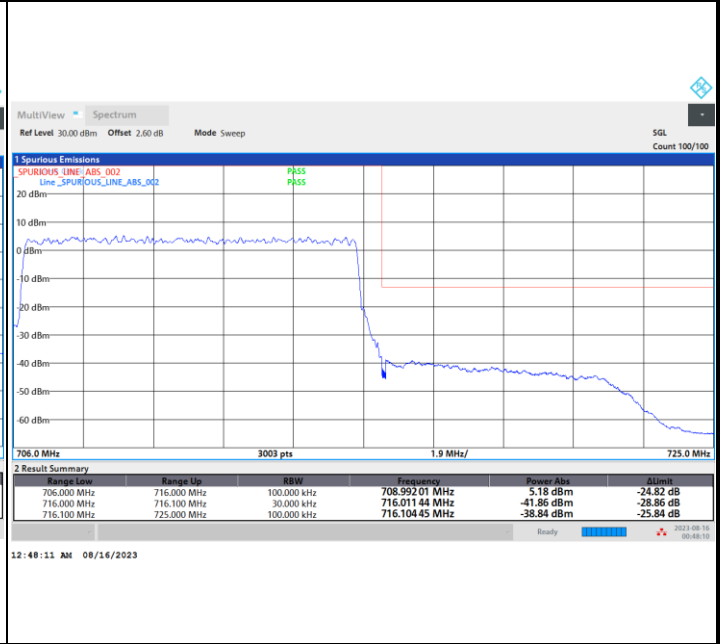
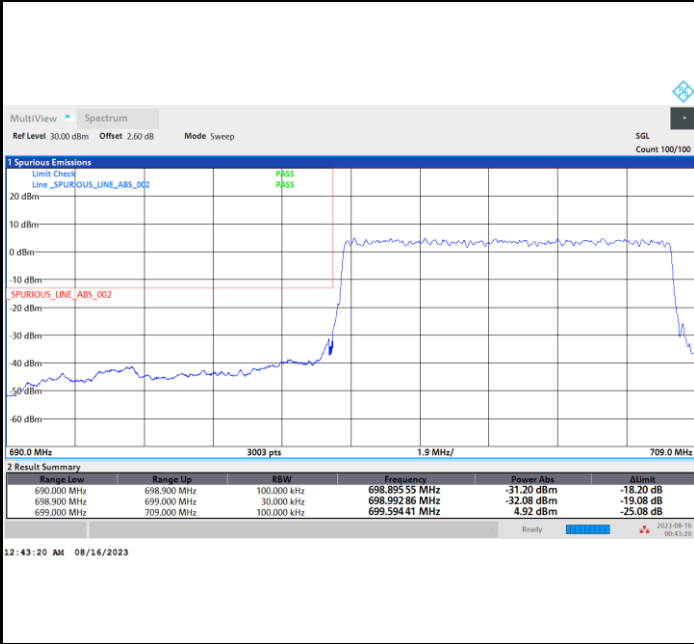

5G-FR1 SA n12 / 10MHz / DFT-s-OFDM / 64QAM / Full RB

Lowest Band Edge

Highest Band Edge

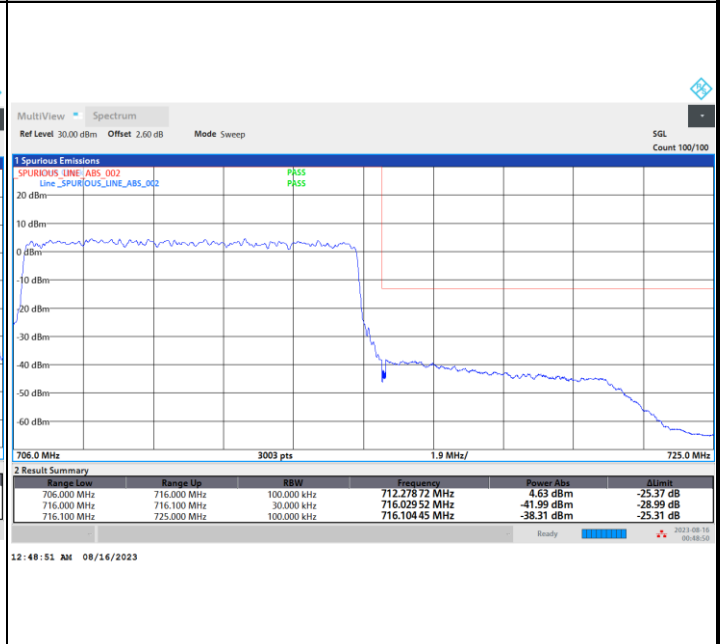
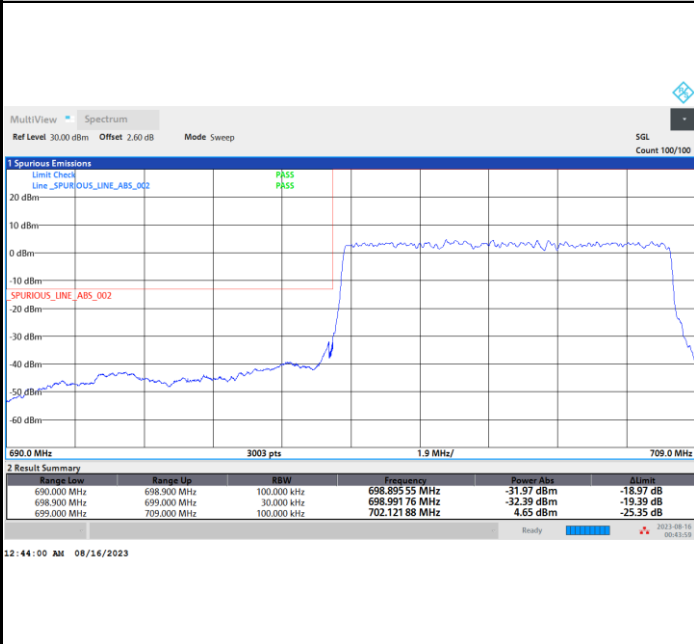



5G-FR1 SA n12 / 10MHz / DFT-s-OFDM / 256QAM / Full RB

Lowest Band Edge

Highest Band Edge

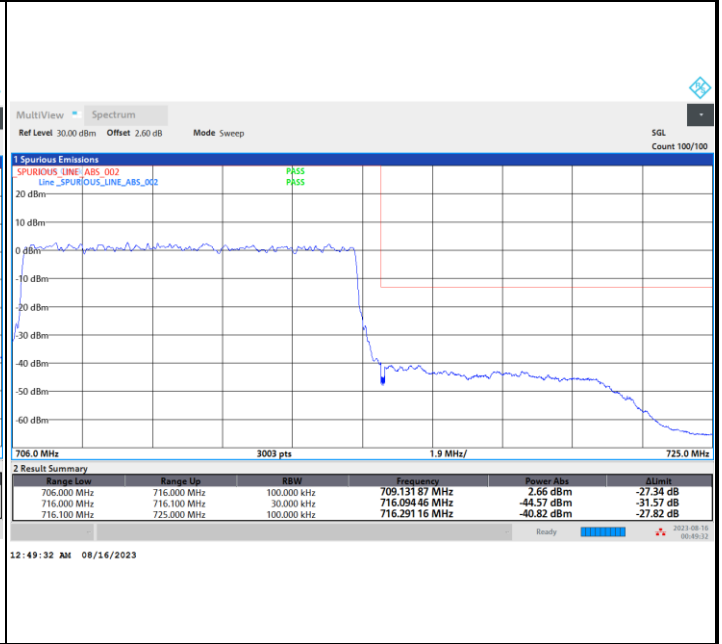
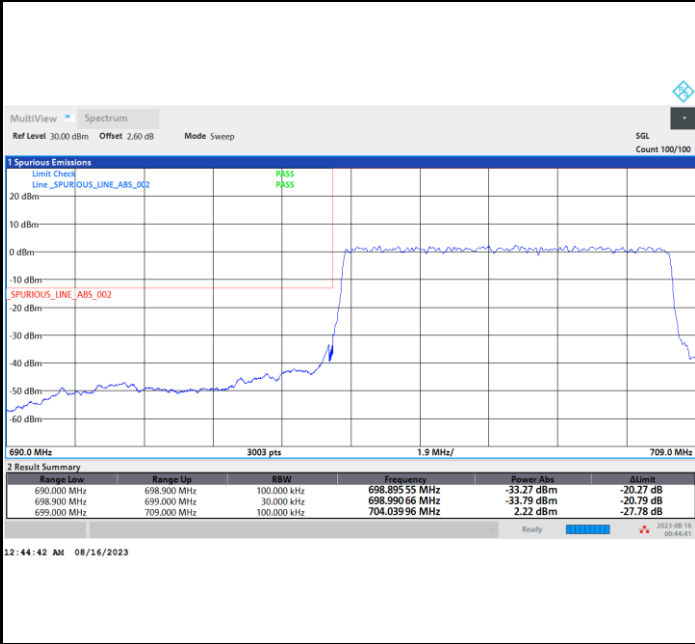

5G-FR1 SA n12 / 10MHz / CP OFDM / QPSK / Full RB

Lowest Band Edge

Highest Band Edge

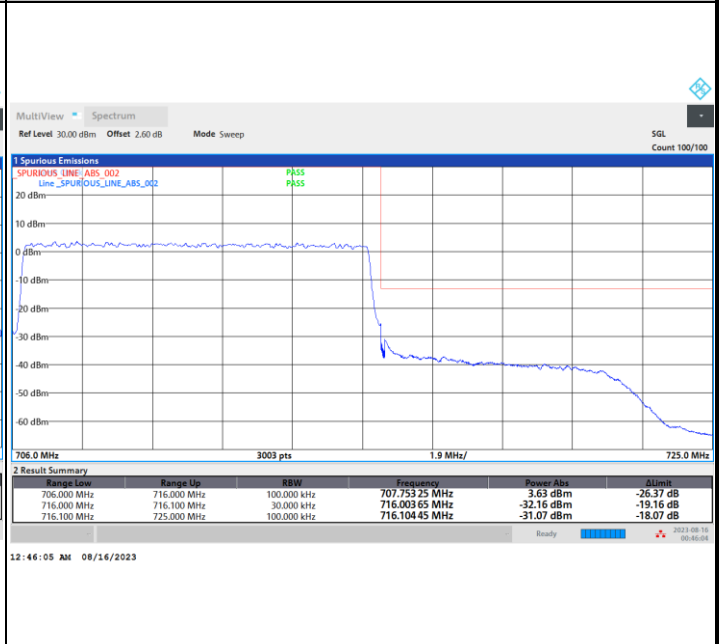
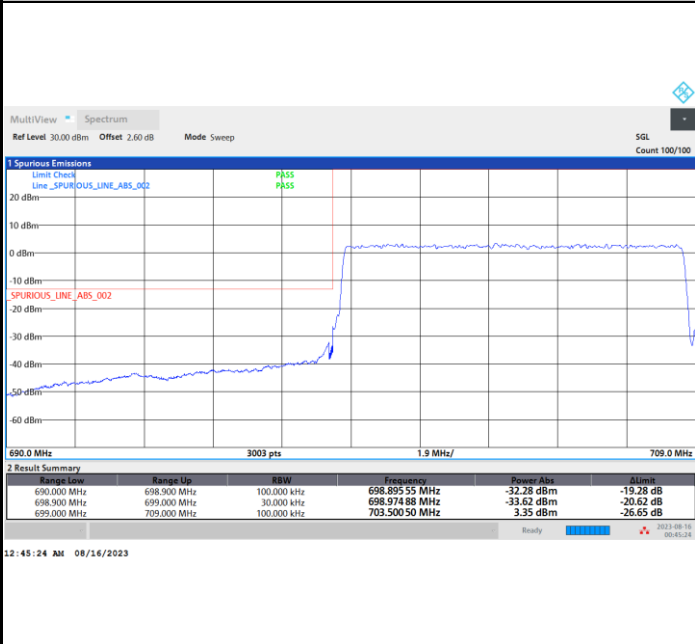



5G-FR1 SA n12 / 15MHz / DFT-s-OFDM / PI/2 BPSK / Full RB

Lowest Band Edge

Highest Band Edge

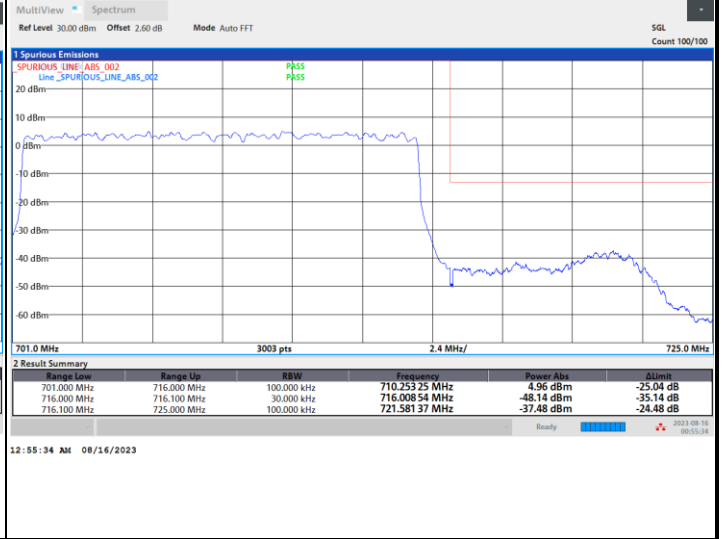
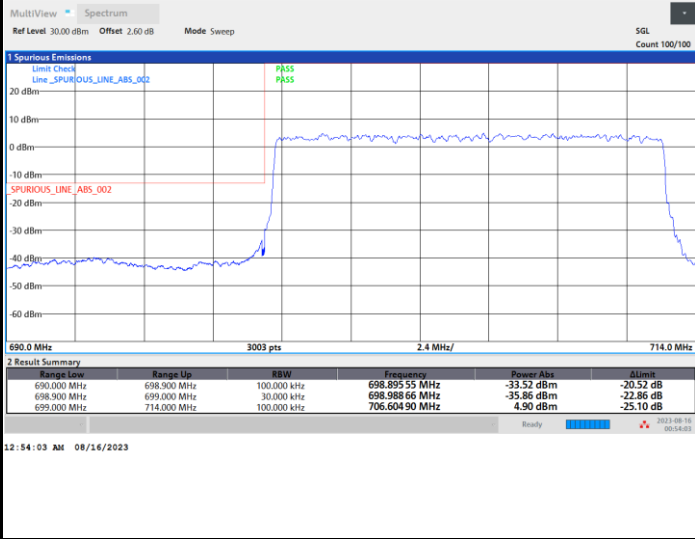

5G-FR1 SA n12 / 15MHz / DFT-s-OFDM / QPSK / Full RB

Lowest Band Edge

Highest Band Edge

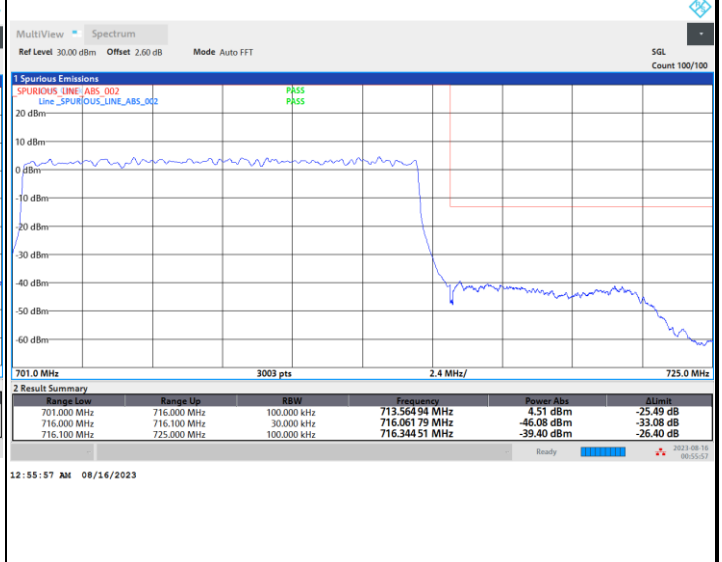
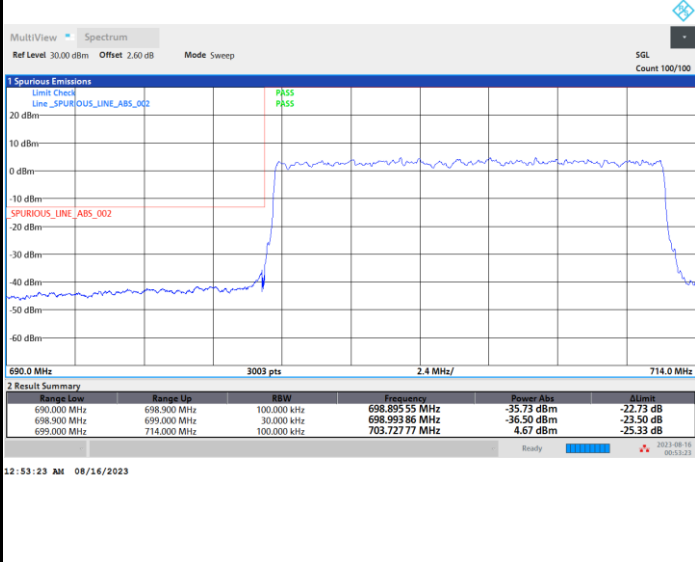



5G-FR1 SA n12 / 15MHz / DFT-s-OFDM / 16QAM / Full RB

Lowest Band Edge

Highest Band Edge

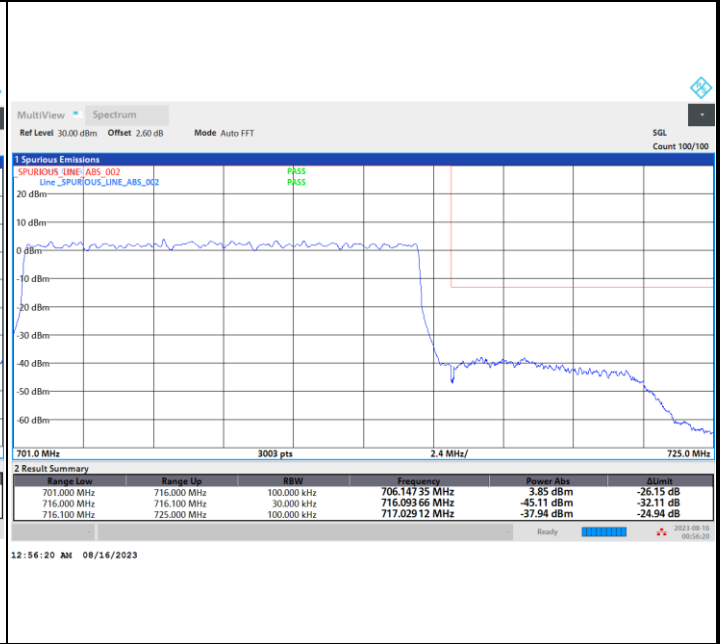
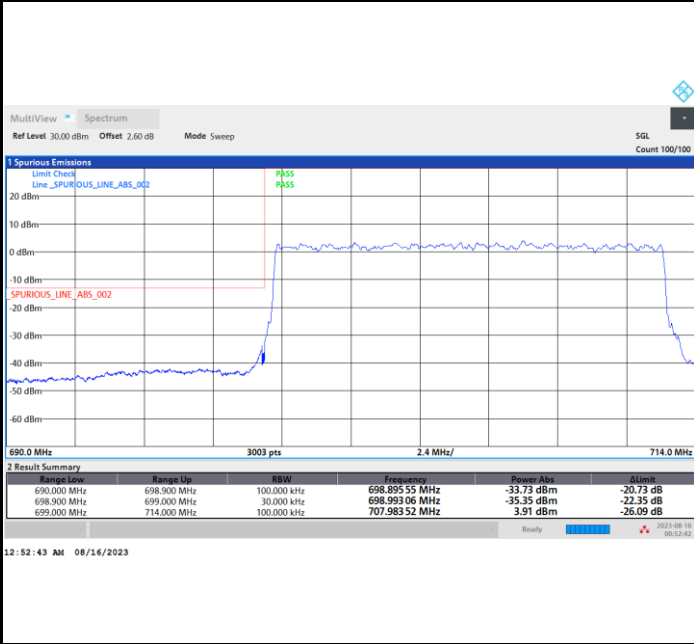

5G-FR1 SA n12 / 15MHz / DFT-s-OFDM / 64QAM / Full RB

Lowest Band Edge

Highest Band Edge

