



FCC RADIO TEST REPORT

FCC ID : PKRISGFW3000
Equipment : Outdoor Fixed CPE
Brand Name : Inseego
Model Name : FW3000
Marketing Name : FW3000
Applicant : Inseego Corp.
 9710 Scranton Road Suite 200, San Diego, CA 92121
Manufacturer : Inseego Corp.
 9710 Scranton Road Suite 200, San Diego, CA 92121
Standard : FCC 47 CFR Part 2, 27

The product was received on Jul. 24, 2023 and testing was performed from Jul. 25, 2023 to Sep. 28, 2023. We, Sporton International Inc. EMC & Wireless Communications Laboratory, would like to declare that the tested sample has been evaluated in accordance with the test procedures given in ANSI / TIA-603-E and has been in compliance with the applicable technical standards.

The test results in this report apply exclusively to the tested model / sample. Without written approval from Sporton International Inc. EMC & Wireless Communications Laboratory, the test report shall not be reproduced except in full.

Louis Wu

Approved by: Louis Wu

Sporton International Inc. EMC & Wireless Communications Laboratory

No. 52, Huaya 1st Rd., Guishan Dist., Taoyuan City 333, Taiwan (R.O.C.)



Table of Contents

History of this test report..... 3

Summary of Test Result..... 4

1 General Description 5

 1.1 Product Feature of Equipment Under Test..... 5

 1.2 Modification of EUT 5

 1.3 Testing Location 6

 1.4 Applicable Standards..... 6

2 Test Configuration of Equipment Under Test 7

 2.1 Test Mode..... 7

 2.2 Connection Diagram of Test System..... 8

 2.3 Support Unit used in test configuration and system 8

 2.4 Measurement Results Explanation Example..... 8

 2.5 Frequency List of Low/Middle/High Channels 9

3 Conducted Test Items..... 10

 3.1 Measuring Instruments 10

 3.2 Conducted Output Power and EIRP 11

 3.3 Peak-to-Average Ratio 12

 3.4 Occupied Bandwidth..... 13

 3.5 Conducted Band Edge 14

 3.6 Conducted Spurious Emission 15

 3.7 Frequency Stability 16

4 Radiated Test Items 17

 4.1 Measuring Instruments 17

 4.2 Radiated Spurious Emission Measurement 19

5 List of Measuring Equipment..... 20

6 Measurement Uncertainty 22

Appendix A. Test Results of Conducted Test

Appendix B. Test Results of Radiated Test

Appendix C. Test Setup Photographs



History of this test report

Report No.	Version	Description	Issue Date
FG320711D	01	Initial issue of report	Oct. 05, 2023



Summary of Test Result

Report Clause	Ref Std. Clause	Test Items	Result (PASS/FAIL)	Remark
3.2	§2.1046	Conducted Output Power	Reporting only	-
	§27.50 (j)(2)	Equivalent Isotropic Radiated Power (n77)	Pass	
3.3	§27.50 (j)(4)	Peak-to-Average Ratio	Pass	-
3.4	§2.1049	Occupied Bandwidth	Reporting only	-
3.5	§2.1051 §27.53 (l)(1)	Conducted Band Edge Measurement (n77)	Pass	-
3.6	§2.1051 §27.53 (l)(1)	Conducted Spurious Emission (n77)	Pass	-
3.7	§2.1055 §27.54	Frequency Stability Temperature & Voltage	Pass	-
4.2	§2.1051 §27.53 (l)(1)	Radiated Spurious Emission (n77)	Pass	21.96 dB under limit at 15334.00 MHz

Conformity Assessment Condition:

- The test results (PASS/FAIL) with all measurement uncertainty excluded are presented against the regulation limits or in accordance with the requirements stipulated by the applicant/manufacturer who shall bear all the risks of non-compliance that may potentially occur if measurement uncertainty is taken into account.
- The measurement uncertainty please refer to each test result in the section "Measurement Uncertainty".

Disclaimer:

The product specifications of the EUT presented in the test report that may affect the test assessments are declared by the manufacturer who shall take full responsibility for the authenticity.

Reviewed by: Avis Chuang

Report Producer: Lucy Wu



1 General Description

1.1 Product Feature of Equipment Under Test

Product Feature	
General Specs 4G-LTE, 5G-FR1, Bluetooth-LE, and GNSS.	
Antenna Type WWAN: Fixed Internal Antenna Bluetooth-LE: Fixed Internal Antenna GPS / Glonass / BDS / Galileo: Fixed Internal Antenna	

Support Band and Evaluated Information	
Supported Band	n77
Evaluated and Tested Band	n77

TDD Band Power Class					
	PC3	PC2	PC3 MIMO	PC2 MIMO	PC1.5 MIMO
n77	√	√	√	√	√

Antenna Information								
Band	Ant0	Ant1	Ant4	Ant6	Ant12	Ant13	Main Ant. #	Secondary Ant. #
n77			8.8	9.8			4	6

Remark: The above EUT's information was declared by manufacturer. Please refer to Disclaimer in report summary.

1.2 Modification of EUT

No modifications are made to the EUT during all test items.



1.3 Testing Location

Test Site	Sporton International Inc. EMC & Wireless Communications Laboratory
Test Site Location	No.52, Huaya 1st Rd., Guishan Dist., Taoyuan City 333, Taiwan (R.O.C.) TEL: +886-3-327-3456 FAX: +886-3-328-4978
Test Site No.	Sporton Site No.
	TH03-HY
Test Engineer	Luffy Lin and George Chen
Temperature (°C)	22~24
Relative Humidity (%)	51~56

Test Site	Sporton International Inc. Wensan Laboratory.
Test Site Location	No.58, Aly. 75, Ln. 564, Wenhua 3rd, Rd., Guishan Dist., Taoyuan City 333010, Taiwan (R.O.C.) TEL: +886-3-327-0868 FAX: +886-3-327-0855
Test Site No.	Sporton Site No.
	03CH12-HY (TAF Code: 3786)
Test Engineer	Jesse Fan, Tim Lee and Wilson Wu
Temperature (°C)	20~25
Relative Humidity (%)	50~60
Remark	The Radiated Spurious Emission test item subcontracted to Sporton International Inc. Wensan Laboratory.

Note: The test site complies with ANSI C63.4 2014 requirement.

FCC Designation No.: TW1190 and TW3786

1.4 Applicable Standards

According to the specifications of the manufacturer, the EUT must comply with the requirements of the following standards:

- ♦ ANSI C63.26-2015
- ♦ ANSI / TIA-603-E
- ♦ FCC 47 CFR Part 2, 27
- ♦ FCC KDB 971168 D01 Power Meas. License Digital Systems v03r01
- ♦ FCC KDB 412172 D01 Determining ERP and EIRP v01r01
- ♦ FCC KDB 414788 D01 Radiated Test Site v01r01.
- ♦ FCC KDB 662911 D01 Multiple Transmitter Output v02r01.

Remark:

1. All test items were verified and recorded according to the standards and without any deviation during the test.
2. This EUT has also been tested and complied with the requirements of FCC Part 15, Subpart B, recorded in a separate test report.
3. The TAF code is not including all the FCC KDB listed without accreditation.



2 Test Configuration of Equipment Under Test

2.1 Test Mode

Antenna port conducted and radiated test items listed below are performed according to KDB 971168 D01 Power Meas. License Digital Systems v03r01 with maximum output power.

For radiated measurement, the measured emission level of the EUT was maximized by rotating the EUT on a turntable, adjusting the orientation of the EUT and EUT antenna in three orthogonal axis (X: flat, Y: portrait, Z: landscape) and adjusting the measurement antenna orientation, following C63.26 exploratory test procedures and only the worst case emissions were reported in this report.

Modulation Type	Modulation	Modulation Type	Modulation
A	DFT-s-OFDM pi/2 BPSK	N/A	N/A
B	DFT-s-OFDM QPSK	F	CP-OFDM QPSK
C	DFT-s-OFDM 16QAM	G	CP-OFDM 16QAM
D	DFT-s-OFDM 64QAM	H	CP-OFDM 64QAM
E	DFT-s-OFDM 256QAM	I	CP-OFDM 256QAM

Test Item	Modulation Type	Bandwidth	RB Size	Channel
Conducted Power	A, B, C, D, E	All	1, Half, Full	L, M, H
EIRP	A, B, C, D, E	All	1, Half, Full	L, M, H
PAR	A, B, C, D, E	20 MHz or less	Outer_Full	M
Bandwidth	A, F, G, H, I	All	Outer_Full	M
CBE,	A, B, C, D, E, F	All	Outer_1RB Outer_Full	L, H
CSE	B	Minimum	Inner_1RB	L, M, H
Frequency Stability	A	20 MHz or less	Outer_Full	M
RSE	A	20 MHz or less	Inner_1RB	L, M, H

Remark:

1. Evaluated all the transmitter signal and reporting worst-case configuration among all modulation types.
2. The device is investigated from 30MHz to 10 times of fundamental signal for radiated spurious emission test under different RB size/offset and modulations in exploratory test. Subsequently, only the worst-case emissions are reported.
3. For 5G NR test combination are EN-DC 2A_n77A, EN-DC 5A_n77A, EN-DC 12A_n77A, EN-DC 13A_n77A, EN-DC 66A_n77A, EN-DC 71A_n77A.

2.2 Connection Diagram of Test System

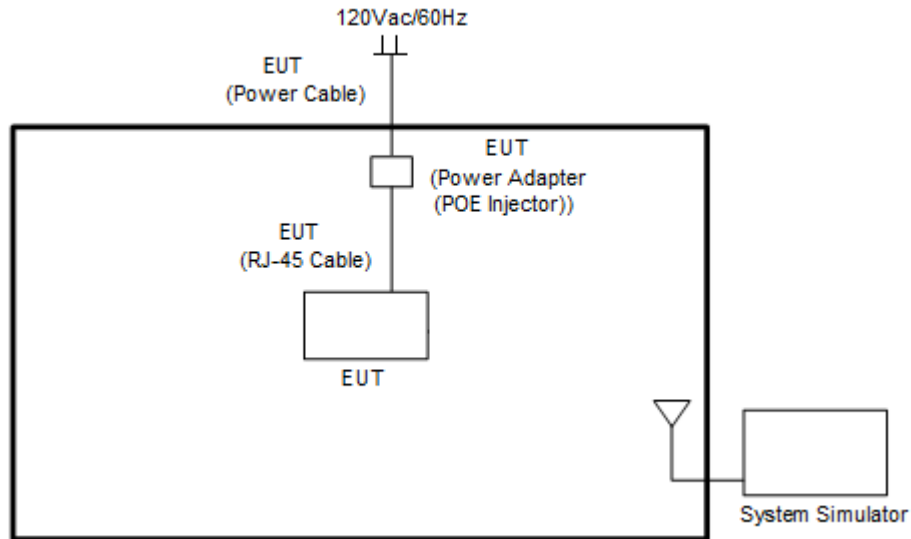

2.3 Support Unit used in test configuration and system

Item	Equipment	Brand Name	Model No.	FCC ID	Data Cable	Power Cord
1.	System Simulator	Anritsu	MT8821C	N/A	N/A	Unshielded, 1.8 m
2.	5G Wireless Test Platform	Anritsu	MT8000A	N/A	N/A	Unshielded, 1.8 m

2.4 Measurement Results Explanation Example

For all conducted test items:

The offset level is set in the spectrum analyzer to compensate the RF cable loss and attenuator factor between EUT conducted output port and spectrum analyzer. With the offset compensation, the spectrum analyzer reading level is exactly the EUT RF output level.

The spectrum analyzer offset is derived from RF cable loss and attenuator factor.

Offset = RF cable loss + attenuator factor.

Following shows an offset computation example with cable loss 4.2 dB and 10dB attenuator.

Example :

$$\begin{aligned} \text{Offset(dB)} &= \text{RF cable loss(dB)} + \text{attenuator factor(dB)}. \\ &= 4.2 + 10 = 14.2 \text{ (dB)} \end{aligned}$$



2.5 Frequency List of Low/Middle/High Channels

5G NR Band n77 Channel and Frequency List				
BW [MHz]	Channel/Frequency(MHz)	Lowest	Middle	Highest
100	Channel	650000	656000	662000
	Frequency	3750	3840	3930
90	Channel	649668	656000	662332
	Frequency	3745.02	3840	3934.98
80	Channel	649334	656000	662666
	Frequency	3740.01	3840	3939.99
70	Channel	649000	656000	663000
	Frequency	3735	3840	3945
60	Channel	648668	656000	663332
	Frequency	3730.02	3840	3949.98
50	Channel	648334	656000	663666
	Frequency	3725.01	3840	3954.99
40	Channel	648000	656000	664000
	Frequency	3720	3840	3960
30	Channel	647668	656000	664332
	Frequency	3715.02	3840	3965
20	Channel	647334	656000	664666
	Frequency	3710.01	3840	3969.99
25	Channel	647500	656000	664500
	Frequency	3712.5	3840	3967.5
15	Channel	647168	656000	664832
	Frequency	3707.52	3840	3972.48
10	Channel	647000	656000	665000
	Frequency	3705	3840	3975

3 Conducted Test Items

3.1 Measuring Instruments

See list of measuring instruments of this test report.

3.1.1 Test Setup

3.1.2 Conducted Output Power

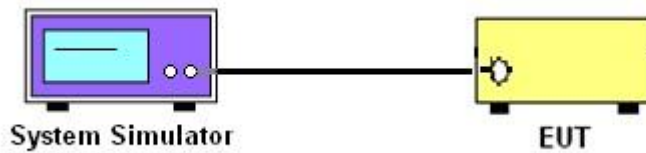

3.1.3 Peak-to-Average Ratio, Occupied Bandwidth ,Conducted Band-Edge and Conducted Spurious Emission

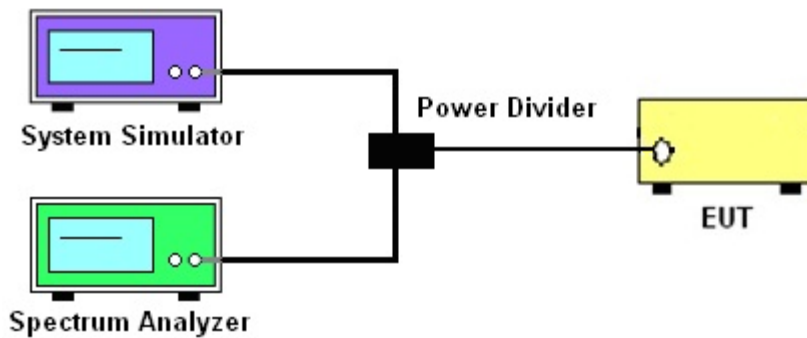

3.1.4 Frequency Stability

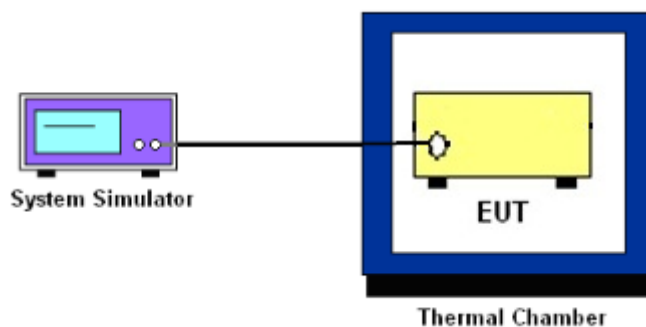

3.1.5 Test Result of Conducted Test

Please refer to Appendix A.



3.2 Conducted Output Power and EIRP

3.2.1 Description of the Conducted Output Power Measurement and EIRP Measurement

A system simulator was used to establish communication with the EUT. Its parameters were set to force the EUT transmitting at maximum output power. The measured power in the radio frequency on the transmitter output terminals shall be reported.

The EIRP of transmitters must not exceed 1640 Watts/MHz for 5G NR n77

According to KDB 412172 D01 Power Approach,

$$EIRP = P_T + G_T - L_C, ERP = EIRP - 2.15, \text{ where}$$

P_T = transmitter output power in dBm

G_T = gain of the transmitting antenna in dBi

L_C = signal attenuation in the connecting cable between the transmitter and antenna in dB

Remark: For MIMO mode, the calculation is following F)2)d) of KDB 662911 D01 v02r01.

d) *Unequal antenna gains, with equal transmit powers.* For antenna gains given by G_1, G_2, \dots, G_N dBi

(i) If transmit signals are *correlated*, then

$$\text{Directional gain} = 10 \log\left[\frac{(10^{G_1/20} + 10^{G_2/20} + \dots + 10^{G_N/20})^2}{N_{ANT}}\right] \text{ dBi}$$
 [Note the "20"s in the denominator of each exponent and the square of the sum of terms; the object is to combine the signal levels coherently.]

(ii) If all transmit signals are *completely uncorrelated*, then

$$\text{Directional gain} = 10 \log\left[\frac{10^{G_1/10} + 10^{G_2/10} + \dots + 10^{G_N/10}}{N_{ANT}}\right] \text{ dBi}$$

5G NR n77	Ant 4 (dBi)	Ant 6 (dBi)	MIMO Mode Uncorrelated NSS = 2 (dBi)
Ant. 4 + 6	8.80	9.80	9.33

Directional gain for Ant. 4+6 uncorrelated of MIMO mode derived from formula which is

$$10 \times \log \left\{ \left[10^{(8.80 \text{ dBi} / 10)} + 10^{(9.80 \text{ dBi} / 10)} \right] / 2 \right\}$$

$$= 9.33 \text{ dB.}$$

3.2.2 Test Procedures

1. The transmitter output port was connected to the system simulator.
2. Set EUT at maximum power through the system simulator.
3. Select lowest, middle, and highest channels for each band and different modulation.
4. Measure and record the power level from the system simulator.



3.3 Peak-to-Average Ratio

3.3.1 Description of the PAR Measurement

Power Complementary Cumulative Distribution Function (CCDF) curves provide a means for characterizing the power peaks of a digitally modulated signal on a statistical basis. A CCDF curve depicts the probability of the peak signal amplitude exceeding the average power level. Most contemporary measurement instrumentation include the capability to produce CCDF curves for an input signal provided that the instrument's resolution bandwidth can be set wide enough to accommodate the entire input signal bandwidth. In measuring transmissions in this band using an average power technique, the peak-to-average ratio (PAR) of the transmission may not exceed 13 dB.

3.3.2 Test Procedures

The testing follows ANSI C63.26-2015 Section 5.2.6

1. The EUT was connected to spectrum and system simulator via a power divider.
2. Set the CCDF (Complementary Cumulative Distribution Function) option in spectrum analyzer.
3. The highest RF powers were measured and recorded the maximum PAPR level associated with a probability of 0.1 %.
4. Record the deviation as Peak to Average Ratio.



3.4 Occupied Bandwidth

3.4.1 Description of Occupied Bandwidth Measurement

The occupied bandwidth is the width of a frequency band such that, below the lower and above the upper frequency limits, the mean powers emitted are each equal to a specified percentage 0.5% of the total mean transmitted power.

The 26 dB emission bandwidth is defined as the frequency range between two points, one above and one below the carrier frequency, at which the spectral density of the emission is attenuated 26 dB below the maximum in-band spectral density of the modulated signal. Spectral density (power per unit bandwidth) is to be measured with a detector of resolution bandwidth equal to approximately 1.0% of the emission bandwidth.

3.4.2 Test Procedures

The testing follows ANSI C63.26-2015 Section 5.4.3 (26dB) and Section 5.4.4 (99OB)

1. The EUT was connected to spectrum analyzer and system simulator via a power divider.
2. The spectrum analyzer center frequency is set to the nominal EUT channel center frequency. The span range for the spectrum analyzer shall be between two and five times the anticipated OBW.
3. The nominal resolution bandwidth (RBW) shall be in the range of 1 to 5 % of the anticipated OBW, and the VBW shall be at least 3 times the RBW.
4. Set the detection mode to peak, and the trace mode to max hold.
5. Determine the reference value: Set the EUT to transmit a modulated signal. Allow the trace to stabilize. Set the spectrum analyzer marker to the highest level of the displayed trace.
(this is the reference value)
6. Determine the “-26 dB down amplitude” as equal to (Reference Value – X).
7. Place two markers, one at the lowest and the other at the highest frequency of the envelope of the spectral display such that each marker is at or slightly below the “-X dB down amplitude” determined in step 6. If a marker is below this “-X dB down amplitude” value it shall be placed as close as possible to this value. The OBW is the positive frequency difference between the two markers.
8. Use the 99 % power bandwidth function of the spectrum analyzer and report the measured bandwidth.



3.5 Conducted Band Edge

3.5.1 Description of Conducted Band Edge Measurement

27.53 (l)(1)

For base station operations in the 3700–3980 MHz band, the conducted power of any emission outside the licensee's authorized bandwidth shall not exceed -13 dBm/MHz. Compliance with this paragraph (l)(1) is based on the use of measurement instrumentation employing a resolution bandwidth of 1 megahertz or greater. However, in the 1 megahertz bands immediately outside and adjacent to the licensee's frequency block, a resolution bandwidth of at least one percent of the emission bandwidth of the fundamental emission of the transmitter may be employed. The emission bandwidth is defined as the width of the signal between two points, one below the carrier center frequency and one above the carrier center frequency, outside of which all emissions are attenuated at least 26 dB below the transmitter power.

3.5.2 Test Procedures

The testing follows FCC KDB 971168 D01 v03r01 Section 6.1.

1. The EUT was connected to spectrum analyzer and system simulator via a power divider.
2. The band edges of low and high channels for the highest RF powers were measured.
3. For $EBW < 20\text{MHz}$, set $RBW \geq 1\%$ EBW in the 1MHz band immediately outside and adjacent to the band edge.
4. For $EBW \geq 20\text{MHz}$, set $RBW = 200\text{kHz}$ in the 1MHz band immediately outside and adjacent to the band edge.
5. Between 1 ~5 MHz from the band edge, $RBW=500$ kHz was used.
6. Set spectrum analyzer with RMS detector.
7. The RF fundamental frequency should be excluded against the limit line in the operating frequency band.
8. Checked that all the results comply with the emission limit line.
The limit line is derived from $43 + 10\log(P)\text{dB}$ below the transmitter power P(Watts)
9. For MIMO mode, add additional MIMO factor $10\log(\text{NTX}=2) = 3.01\text{dB}$ into the spectrum analyzer offset.



3.6 Conducted Spurious Emission

3.6.1 Description of Conducted Spurious Emission Measurement

For base station operations in the 3700–3980 MHz band, the conducted power of any emission outside the licensee's authorized bandwidth shall not exceed –13 dBm/MHz.

3.6.2 Test Procedures

The testing follows FCC KDB 971168 D01 v03r01 Section 6.1.

1. The EUT was connected to spectrum analyzer and system simulator via a power divider.
2. The RF output of EUT was connected to the spectrum analyzer by RF cable and attenuator. The path loss was compensated to the results for each measurement.
3. The middle channel for the highest RF power within the transmitting frequency was measured.
4. The conducted spurious emission for the whole frequency range was taken.
5. Make the measurement with the spectrum analyzer's RBW = 1MHz, VBW = 3MHz.
6. Set spectrum analyzer with RMS detector.
7. Taking the record of maximum spurious emission.
8. The RF fundamental frequency should be excluded against the limit line in the operating frequency band.
9. The limit line is derived from $43 + 10\log(P)$ dB below the transmitter power P(Watts)
10. For MIMO mode, add additional MIMO factor $10\log(NTX=2) = 3.01$ dB into the spectrum analyzer offset.



3.7 Frequency Stability

3.7.1 Description of Frequency Stability Measurement

27.54

The frequency stability shall be sufficient to ensure that the fundamental emission stays within the authorized frequency block.

3.7.2 Test Procedures for Temperature Variation

The testing follows FCC KDB 971168 D01 v03r01 Section 9.0.

1. The EUT was set up in the thermal chamber and connected with the system simulator.
2. With power OFF, the temperature was decreased to -30°C and the EUT was stabilized before testing. Power was applied and the maximum change in frequency was recorded within one minute.
3. With power OFF, the temperature was raised in 10°C step up to 50°C . The EUT was stabilized at each step for at least half an hour. Power was applied and the maximum frequency change was recorded within one minute.

3.7.3 Test Procedures for Voltage Variation

The testing follows FCC KDB 971168 D01 v03r01 Section 9.0.

1. The EUT was placed in a temperature chamber at $20\pm 5^{\circ}\text{C}$ and connected with the system simulator.
2. The power supply voltage to the EUT was varied from 85% to 115% of the nominal value measured at the input to the EUT.
3. The variation in frequency was measured for the worst case.

4 Radiated Test Items

4.1 Measuring Instruments

See list of measuring instruments of this test report.

4.1.1 Test Setup

For radiated test below 30MHz

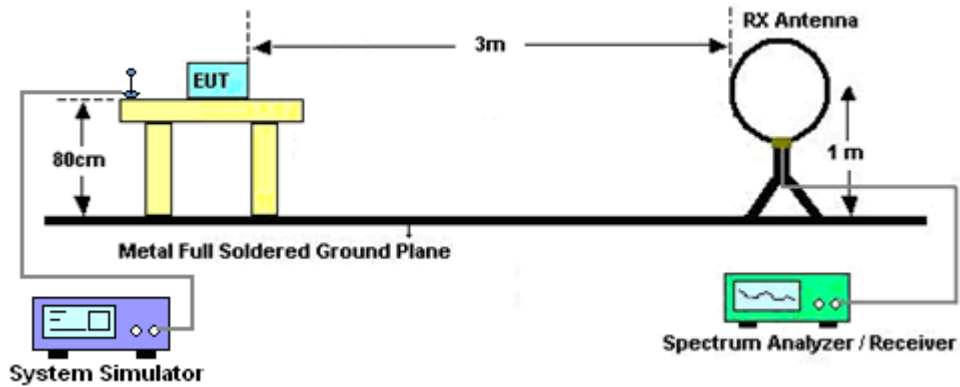

For radiated test from 30MHz to 1GHz

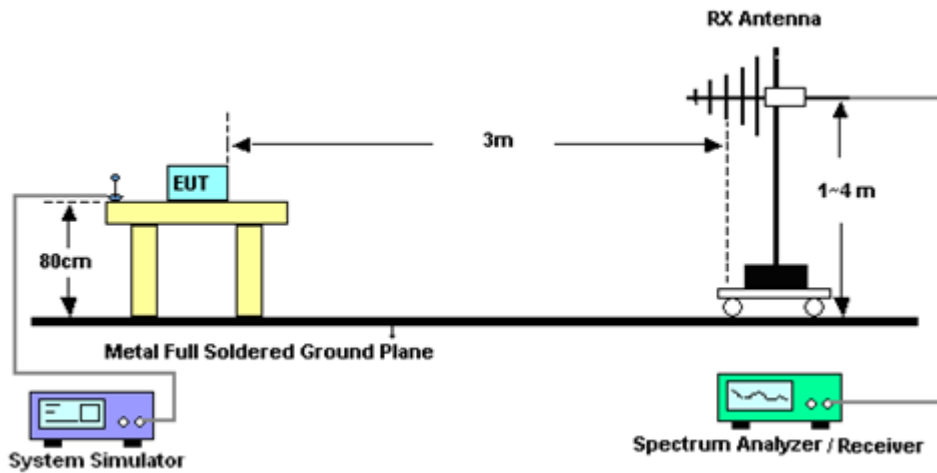

For radiated test from 1GHz to 18GHz

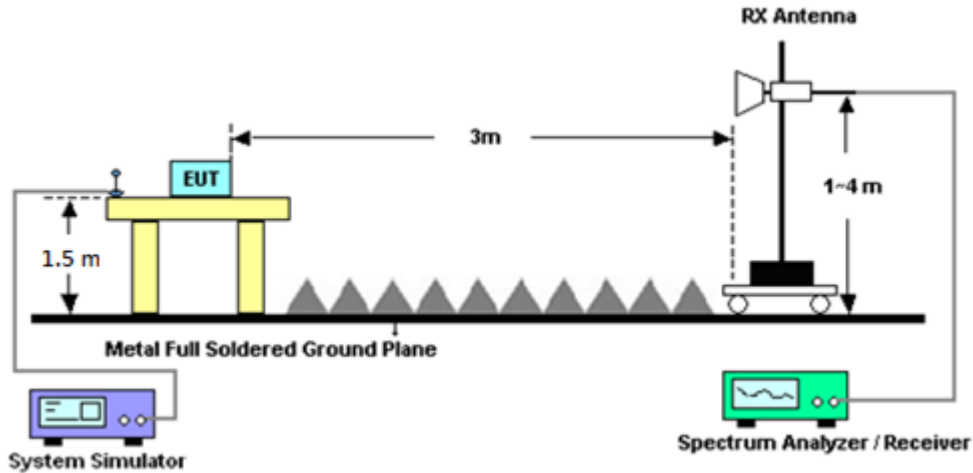

For radiated test above 18GHz

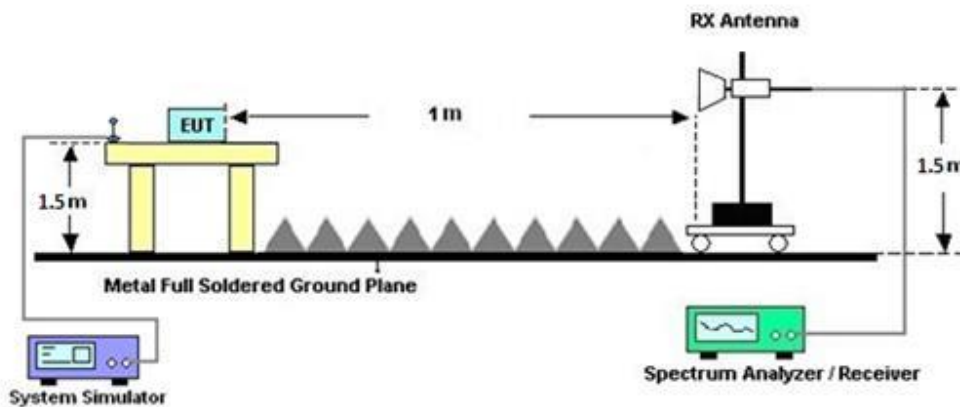

4.1.2 Test Result of Radiated Test

Please refer to Appendix B.

Note:

The low frequency, which started from 9 kHz to 30MHz, was pre-scanned and the result which was 20dB lower than the limit line was not reported.

There is adequate comparison measurement of both open-field test site and alternative test site - semi-Anechoic chamber according to 414788 D01 Radiated Test Site v01r01, and the result came out very similar.



4.2 Radiated Spurious Emission Measurement

4.2.1 Description of Radiated Spurious Emission Measurement

The radiated spurious emission was measured by substitution method according to ANSI / TIA-603-E. For base station operations in the 3700–3980 MHz band, the conducted power of any emission outside the licensee's authorized bandwidth shall not exceed –13 dBm/MHz.

The spectrum is scanned from 30 MHz up to a frequency including its 10th harmonic.

4.2.2 Test Procedures

The testing follows FCC KDB 971168 D01 v03r01 Section 7 and ANSI / TIA-603-E Section 2.2.12.

1. The EUT was placed on a turntable with 0.8 meter for frequency below 1GHz and 1.5 meter for frequency above 1GHz respectively above ground.
2. The EUT was set 3 meters from the receiving antenna, which was mounted on the antenna tower.
3. The table was rotated 360 degrees to determine the position of the highest spurious emission.
4. The height of the receiving antenna is varied between one meter and four meters to search the maximum spurious emission for both horizontal and vertical polarizations.
5. Make the measurement with the spectrum analyzer's RBW = 1MHz, VBW = 3MHz, taking the record of maximum spurious emission.
6. A horn antenna was substituted in place of the EUT and was driven by a signal generator.
7. Tune the output power of signal generator to the same emission level with EUT maximum spurious emission.
8. Taking the record of output power at antenna port.
9. Repeat step 7 to step 8 for another polarization.
10. The RF fundamental frequency should be excluded against the limit line in the operating frequency band.

The limit line is derived from $43 + 10\log(P)$ dB below the transmitter power P(Watts)

$EIRP \text{ (dBm)} = S.G. \text{ Power} - Tx \text{ Cable Loss} + Tx \text{ Antenna Gain}$

$ERP \text{ (dBm)} = EIRP - 2.15$



5 List of Measuring Equipment

Instrument	Brand Name	Model No.	Serial No.	Characteristics	Calibration Date	Test Date	Due Date	Remark
Loop Antenna	Rohde & Schwarz	HFH2-Z2	100488	9 kHz~30 MHz	Sep. 20, 2022	Aug. 23, 2023~ Sep. 05, 2023	Sep. 19, 2023	Radiation (03CH12-HY)
Loop Antenna	Rohde & Schwarz	HFH2-Z2	100488	9 kHz~30 MHz	Sep. 12, 2023	Sep. 15, 2023~ Sep. 28, 2023	Sep. 11, 2024	Radiation (03CH12-HY)
Bilog Antenna	TESEQ	CBL 6111D & 00800N1D01N -06	37059 & 01	30MHz~1GHz	Nov. 10, 2022	Aug. 23, 2023~ Sep. 28, 2023	Nov. 09, 2023	Radiation (03CH12-HY)
Bilog Antenna	TESEQ	CBL 6111D & 00800N1D01N -06	40103 & 07	30MHz~1GHz	Apr. 23, 2023	Aug. 23, 2023~ Sep. 28, 2023	Apr. 22, 2024	Radiation (03CH12-HY)
Horn Antenna	SCHWARZBE CK	BBHA 9120 D	9120D-1328	1GHz~18GHz	Dec. 15, 2022	Aug. 23, 2023~ Sep. 28, 2023	Dec. 14, 2023	Radiation (03CH12-HY)
Horn Antenna	SCHWARZBE CK	BBHA 9120 D	9120D-0211 4	1GHz~18GHz	Jul. 31, 2023	Aug. 23, 2023~ Sep. 28, 2023	Jul. 30, 2024	Radiation (03CH12-HY)
SHF-EHF Horn Antenna	SCHWARZBE CK	BBHA9170	00993	18GHz~40GHz	Nov. 24, 2022	Aug. 23, 2023~ Sep. 28, 2023	Nov. 23, 2023	Radiation (03CH12-HY)
SHF-EHF Horn Antenna	SCHWARZBE CK	BBHA9170	00991	18GHz~40GHz	Jun. 01, 2023	Aug. 23, 2023~ Sep. 28, 2023	May 31, 2024	Radiation (03CH12-HY)
Preamplifier	COM-POWER	PA-103A	161241	10MHz~1GHz	Oct. 03, 2022	Aug. 23, 2023~ Sep. 28, 2023	Oct. 02, 2023	Radiation (03CH12-HY)
Preamplifier	Agilent	8449B	3008A02375	1GHz~26.5GHz	May 23, 2023	Aug. 23, 2023~ Sep. 28, 2023	May 22, 2024	Radiation (03CH12-HY)
Preamplifier	E-INSTRUME NT TECH LTD.	ERA-100M-18 G-56-01-A70	EC1900249	1GHz-18GHz	Dec. 21, 2022	Aug. 23, 2023~ Sep. 28, 2023	Dec. 20, 2023	Radiation (03CH12-HY)
Preamplifier	EMEC	EM18G40G	060715	18GHz~40GHz	Dec. 07, 2022	Aug. 23, 2023~ Sep. 28, 2023	Dec. 06, 2023	Radiation (03CH12-HY)
Spectrum Analyzer	Agilent	N9010A	MY53470118	10Hz~44GHz	Jan. 10, 2023	Aug. 23, 2023~ Sep. 28, 2023	Jan. 09, 2024	Radiation (03CH12-HY)
Filter	Wainwright	WHKX8-5872. 5-6750-18000- 40ST	SN2	6.75GHz High Pass Filter	Mar. 14, 2023	Aug. 23, 2023~ Sep. 28, 2023	Mar. 13, 2024	Radiation (03CH12-HY)
RF Cable	HUBER + SUHNER	SUCOFLEX 102	803951/2	9kHz~30MHz	Mar. 07, 2023	Aug. 23, 2023~ Sep. 28, 2023	Mar. 06, 2024	Radiation (03CH12-HY)
RF Cable	HUBER + SUHNER	SUCOFLEX 126E	0058/126E	30MHz~18GHz	Dec. 20, 2022	Aug. 23, 2023~ Sep. 28, 2023	Dec. 19, 2023	Radiation (03CH12-HY)
RF Cable	HUBER + SUHNER	SUCOFLEX 102	505134/2	30MHz~40GHz	Dec. 20, 2022	Aug. 23, 2023~ Sep. 28, 2023	Dec. 19, 2023	Radiation (03CH12-HY)
RF Cable	HUBER + SUHNER	SUCOFLEX 102	803953/2	30MHz~40GHz	Dec. 20, 2022	Aug. 23, 2023~ Sep. 28, 2023	Dec. 19, 2023	Radiation (03CH12-HY)
Hygrometer	TECPEL	DTM-303B	TP210090	N/A	Oct. 03, 2022	Aug. 23, 2023~ Sep. 28, 2023	Oct. 02, 2023	Radiation (03CH12-HY)
Controller	EMEC	EM1000	N/A	Control Turn table & Ant Mast	N/A	Aug. 23, 2023~ Sep. 28, 2023	N/A	Radiation (03CH12-HY)
Antenna Mast	EMEC	AM-BS-4500-B	N/A	1m~4m	N/A	Aug. 23, 2023~ Sep. 28, 2023	N/A	Radiation (03CH12-HY)
Turn Table	EMEC	TT2000	N/A	0~360 Degree	N/A	Aug. 23, 2023~ Sep. 28, 2023	N/A	Radiation (03CH12-HY)
Software	Audix	E3 6.2009-8-24	RK-000989	N/A	N/A	Aug. 23, 2023~ Sep. 28, 2023	N/A	Radiation (03CH12-HY)



Instrument	Brand Name	Model No.	Serial No.	Characteristics	Calibration Date	Test Date	Due Date	Remark
Programmable Power Supply	GW Instek	PSS-2005	EL890001	50Hz~60Hz	Sep. 29, 2022	Jul. 25, 2023~ Sep. 23, 2023	Sep. 28, 2023	Conducted (TH03-HY)
Signal Analyzer	Rohde & Schwarz	FSV3044	101048	10Hz~44GHz	May 03, 2023	Jul. 25, 2023~ Sep. 23, 2023	May 02, 2024	Conducted (TH03-HY)
Temperature Chamber	ESPEC	SH-241	92003713	-30°C ~90°C	May 17, 2023	Jul. 25, 2023~ Sep. 23, 2023	May 16, 2024	Conducted (TH03-HY)
Base Station (Measure)	Anritsu	MT8821C	6262116730	LTE	Jul. 10, 2023	Jul. 25, 2023~ Sep. 23, 2023	Jul. 09, 2024	Conducted (TH03-HY)
Base Station (Measure)	Anritsu	MT8000A	6262134933	FR1	Jul. 10, 2023	Jul. 25, 2023~ Sep. 23, 2023	Jul. 09, 2024	Conducted (TH03-HY)



6 Measurement Uncertainty

Uncertainty of Radiated Emission Measurement (30 MHz ~ 1000 MHz)

Measuring Uncertainty for a Level of Confidence of 95% ($U = 2Uc(y)$)	3.07 dB
---	---------

Uncertainty of Radiated Emission Measurement (1 GHz ~ 18 GHz)

Measuring Uncertainty for a Level of Confidence of 95% ($U = 2Uc(y)$)	3.63 dB
---	---------

Uncertainty of Radiated Emission Measurement (18 GHz ~ 40 GHz)

Measuring Uncertainty for a Level of Confidence of 95% ($U = 2Uc(y)$)	4.14 dB
---	---------



Appendix A. Test Results of Conducted Test

Conducted Output Power(Average power and EIRP)

<SISO Mode>

Part 270_5G-FR1 SA n77 (PC2) Maximum Average Power [dBm] (GT - LC = 9.8 dB)								
BW [MHz]	RB Size	RB Offset	Mod	Lowest	Middle	Highest	EIRP (dBm)	EIRP(W)
10	1	1	PI/2 BPSK	26.50	26.70	26.72	36.58	4.5499
10	1	22		26.59	26.57	26.66		
10	12	6		26.64	26.65	26.76		
10	1	0		20.65	20.68	20.76		
10	1	23		20.68	20.61	20.68		
10	24	0		25.25	25.13	25.28		
10	1	1	QPSK	26.46	26.60	26.72		
10	1	22		26.58	26.62	26.69		
10	12	6		26.61	26.64	26.78		
10	1	0		20.04	20.13	20.24		
10	1	23		20.05	20.14	20.20		
10	24	0		24.65	24.67	24.76		
10	1	1	16-QAM	25.48	25.53	25.63	35.43	3.4914
10	1	1	64-QAM	23.53	23.56	23.70		
10	1	1	256-QAM	21.00	21.04	21.25		
Limit	EIRP < 1640W/MHz			Result			Pass	

Part 270_5G-FR1 SA n77 (PC2) Maximum Average Power [dBm] (GT - LC = 9.8 dB)								
BW [MHz]	RB Size	RB Offset	Mod	Lowest	Middle	Highest	EIRP (dBm)	EIRP(W)
15	1	1	PI/2 BPSK	26.78	26.75	26.92	36.78	4.7643
15	1	36		26.75	26.78	26.98		
15	18	9		26.78	26.80	26.93		
15	1	0		20.34	20.79	21.14		
15	1	37		20.39	20.76	21.03		
15	36	0		24.84	25.26	25.56		
15	1	1	QPSK	26.71	26.77	26.96		
15	1	36		26.78	26.74	26.93		
15	18	9		26.78	26.75	26.92		
15	1	0		20.29	20.25	20.62		
15	1	37		20.40	20.26	20.57		
15	36	0		24.80	24.79	25.11		
15	1	1	16-QAM	25.71	25.80	26.02	35.82	3.8194
15	1	1	64-QAM	23.76	23.88	24.02		
15	1	1	256-QAM	21.39	21.24	21.48		
Limit	EIRP < 1640W/MHz			Result			Pass	



Part 270_5G-FR1 SA n77 (PC2) Maximum Average Power [dBm] (GT - LC = 9.8 dB)								
BW [MHz]	RB Size	RB Offset	Mod	Lowest	Middle	Highest	EIRP (dBm)	EIRP(W)
20	1	1	PI/2 BPSK	26.73	26.75	26.97	36.77	4.7534
20	1	49		26.85	26.70	26.93		
20	25	12		26.82	26.77	26.93		
20	1	0		20.78	20.76	21.06		
20	1	50		20.91	20.70	20.96		
20	50	0		25.39	25.26	25.58		
20	1	1	QPSK	26.74	26.70	26.94		
20	1	49		26.86	26.71	26.96		
20	25	12		26.81	26.74	26.94		
20	1	0		20.33	20.28	20.50		
20	1	50		20.45	20.23	20.46		
20	50	0		24.86	24.82	24.97		
20	1	1	16-QAM	25.72	25.75	26.04	35.84	3.8371
20	1	1	64-QAM	23.78	23.86	24.12		
20	1	1	256-QAM	21.32	21.34	21.48		
Limit	EIRP < 1640W/MHz			Result			Pass	

Part 270_5G-FR1 SA n77 (PC2) Maximum Average Power [dBm] (GT - LC = 9.8 dB)								
BW [MHz]	RB Size	RB Offset	Mod	Lowest	Middle	Highest	EIRP (dBm)	EIRP(W)
25	1	1	PI/2 BPSK	26.79	26.72	26.91	36.76	4.7424
25	1	63		26.92	26.68	26.95		
25	32	16		26.83	26.75	26.96		
25	1	0		20.86	20.76	21.01		
25	1	64		20.95	20.70	20.96		
25	64	0		25.42	25.26	25.41		
25	1	1	QPSK	26.85	26.74	26.95		
25	1	63		26.93	26.64	26.84		
25	32	16		26.89	26.74	26.90		
25	1	0		20.37	20.28	20.51		
25	1	64		20.44	20.25	20.47		
25	64	0		24.96	24.78	24.97		
25	1	1	16-QAM	25.88	25.74	26.08	35.88	3.8726
25	1	1	64-QAM	23.81	23.85	24.15		
25	1	1	256-QAM	21.35	21.27	21.60		
Limit	EIRP < 1640W/MHz			Result			Pass	



Part 270_5G-FR1 SA n77 (PC2) Maximum Average Power [dBm] (GT - LC = 9.8 dB)										
BW [MHz]	RB Size	RB Offset	Mod	Lowest	Middle	Highest	EIRP (dBm)	EIRP(W)		
30	1	1	PI/2 BPSK	26.79	26.77	26.94	36.74	4.7206		
30	1	76		26.87	26.74	26.89				
30	36	18		26.83	26.81	26.93				
30	1	0		20.80	20.78	21.17				
30	1	77		20.93	20.75	21.02				
30	75	0		25.43	25.31	25.59				
30	1	1	QPSK	26.74	26.75	26.91			36.74	4.7206
30	1	76		26.84	26.77	26.90				
30	36	18		26.88	26.80	26.93				
30	1	0		20.32	20.30	20.67				
30	1	77		20.41	20.25	20.37				
30	75	0		24.87	24.84	25.05				
30	1	1	16-QAM	25.77	25.72	26.15	35.95	3.9355		
30	1	1	64-QAM	23.92	23.87	24.15				
30	1	1	256-QAM	21.44	21.41	21.55				
Limit	EIRP < 1640W/MHz			Result			Pass			

Part 270_5G-FR1 SA n77 (PC2) Maximum Average Power [dBm] (GT - LC = 9.8 dB)										
BW [MHz]	RB Size	RB Offset	Mod	Lowest	Middle	Highest	EIRP (dBm)	EIRP(W)		
40	1	1	PI/2 BPSK	26.95	26.95	26.98	36.79	4.7753		
40	1	104		26.91	26.95	26.93				
40	50	25		26.95	26.88	26.95				
40	1	0		21.19	21.16	21.28				
40	1	105		21.16	20.99	21.25				
40	100	0		25.66	25.61	25.72				
40	1	1	QPSK	26.91	26.93	26.99			36.79	4.7753
40	1	104		26.91	26.94	26.96				
40	50	25		26.91	26.93	26.94				
40	1	0		20.73	20.68	20.80				
40	1	105		20.66	20.51	20.78				
40	100	0		25.20	25.10	25.25				
40	1	1	16-QAM	26.20	26.18	26.28	36.08	4.0551		
40	1	1	64-QAM	24.01	24.15	24.37				
40	1	1	256-QAM	21.86	21.84	21.91				
Limit	EIRP < 1640W/MHz			Result			Pass			



Part 270_5G-FR1 SA n77 (PC2) Maximum Average Power [dBm] (GT - LC = 9.8 dB)										
BW [MHz]	RB Size	RB Offset	Mod	Lowest	Middle	Highest	EIRP (dBm)	EIRP(W)		
50	1	1	PI/2 BPSK	26.70	26.83	26.92	36.75	4.7315		
50	1	131		26.71	26.80	26.91				
50	64	32		26.92	26.90	26.95				
50	1	0		20.86	20.38	21.07				
50	1	132		20.67	20.32	21.00				
50	128	0		25.35	24.84	25.56				
50	1	1	QPSK	26.70	26.84	26.91			35.76	3.7670
50	1	131		26.68	26.74	26.92				
50	64	32		26.87	26.86	26.95				
50	1	0		20.36	20.36	20.65				
50	1	132		20.20	20.27	20.47				
50	128	0		24.91	24.84	25.12				
50	1	1	16-QAM	25.72	25.83	25.96	35.76	3.7670		
50	1	1	64-QAM	23.83	23.86	24.07				
50	1	1	256-QAM	21.28	21.38	21.68				
Limit	EIRP < 1640W/MHz			Result			Pass			

Part 270_5G-FR1 SA n77 (PC2) Maximum Average Power [dBm] (GT - LC = 9.8 dB)										
BW [MHz]	RB Size	RB Offset	Mod	Lowest	Middle	Highest	EIRP (dBm)	EIRP(W)		
60	1	1	PI/2 BPSK	26.74	26.85	26.83	36.73	4.7098		
60	1	160		26.68	26.74	26.91				
60	81	40		26.91	26.93	26.89				
60	1	0		20.89	20.90	21.00				
60	1	161		20.75	20.76	21.06				
60	162	0		25.42	25.36	25.54				
60	1	1	QPSK	26.79	26.81	26.86			35.65	3.6728
60	1	160		26.78	26.76	26.92				
60	81	40		26.92	26.84	26.87				
60	1	0		20.35	20.40	20.53				
60	1	161		20.24	20.24	20.58				
60	162	0		24.96	24.88	25.09				
60	1	1	16-QAM	25.85	25.84	25.82	35.65	3.6728		
60	1	1	64-QAM	23.91	23.84	23.85				
60	1	1	256-QAM	21.32	21.38	21.40				
Limit	EIRP < 1640W/MHz			Result			Pass			



Part 270_5G-FR1 SA n77 (PC2) Maximum Average Power [dBm] (GT - LC = 9.8 dB)								
BW [MHz]	RB Size	RB Offset	Mod	Lowest	Middle	Highest	EIRP (dBm)	EIRP(W)
70	1	1	PI/2 BPSK	26.63	26.84	26.91	36.72	4.6989
70	1	187		26.67	26.61	26.82		
70	90	45		26.83	26.71	26.92		
70	1	0		20.81	20.30	20.93		
70	1	188		20.69	20.21	20.89		
70	180	0		25.34	24.80	25.42		
70	1	1	QPSK	26.68	26.87	26.82		
70	1	187		26.70	26.59	26.86		
70	90	45		26.82	26.72	26.92		
70	1	0		20.30	20.24	20.46		
70	1	188		20.15	20.16	20.40		
70	180	0		24.83	24.77	24.89		
70	1	1	16-QAM	25.67	25.90	25.85	35.70	3.7154
70	1	1	64-QAM	23.63	23.82	23.75		
70	1	1	256-QAM	21.25	21.40	21.48		
Limit	EIRP < 1640W/MHz			Result			Pass	

Part 270_5G-FR1 SA n77 (PC2) Maximum Average Power [dBm] (GT - LC = 9.8 dB)								
BW [MHz]	RB Size	RB Offset	Mod	Lowest	Middle	Highest	EIRP (dBm)	EIRP(W)
80	1	1	PI/2 BPSK	26.47	26.58	26.58	36.51	4.4771
80	1	215		26.51	26.53	26.71		
80	108	54		26.61	26.50	26.71		
80	1	0		20.57	20.46	20.81		
80	1	216		20.62	20.54	20.66		
80	216	0		25.11	25.07	25.21		
80	1	1	QPSK	26.48	26.56	26.56		
80	1	215		26.50	26.51	26.63		
80	108	54		26.55	26.48	26.70		
80	1	0		20.12	20.07	20.32		
80	1	216		20.07	20.06	20.17		
80	216	0		24.66	24.58	24.70		
80	1	1	16-QAM	25.48	25.72	25.59	35.52	3.5645
80	1	1	64-QAM	23.62	23.57	23.58		
80	1	1	256-QAM	21.06	21.13	21.14		
Limit	EIRP < 1640W/MHz			Result			Pass	



Part 270_5G-FR1 SA n77 (PC2) Maximum Average Power [dBm] (GT - LC = 9.8 dB)										
BW [MHz]	RB Size	RB Offset	Mod	Lowest	Middle	Highest	EIRP (dBm)	EIRP(W)		
90	1	1	PI/2 BPSK	26.42	26.50	26.48	36.51	4.4771		
90	1	243		26.69	26.48	26.57				
90	120	60		26.55	26.42	26.70				
90	1	0		20.52	20.50	20.71				
90	1	244		20.70	20.48	20.59				
90	243	0		25.05	24.99	25.18				
90	1	1	QPSK	26.40	26.61	26.39			36.51	4.4771
90	1	243		26.56	26.49	26.64				
90	120	60		26.42	26.44	26.71				
90	1	0		20.08	19.97	20.25				
90	1	244		20.03	19.98	20.09				
90	243	0		24.56	24.51	24.70				
90	1	1	16-QAM	25.43	25.58	25.43	35.38	3.4514		
90	1	1	64-QAM	23.39	23.58	23.51				
90	1	1	256-QAM	20.95	21.16	21.09				
Limit	EIRP < 1640W/MHz			Result			Pass			

Part 270_5G-FR1 SA n77 (PC2) Maximum Average Power [dBm] (GT - LC = 9.8 dB)										
BW [MHz]	RB Size	RB Offset	Mod	Lowest	Middle	Highest	EIRP (dBm)	EIRP(W)		
100	1	1	PI/2 BPSK	26.51	26.66	26.42	36.56	4.5290		
100	1	271		26.63	26.60	26.73				
100	135	67		26.58	26.51	26.75				
100	1	0		20.59	20.55	20.75				
100	1	272		20.72	20.57	20.74				
100	270	0		25.15	25.14	25.26				
100	1	1	QPSK	26.49	26.68	26.44			36.56	4.5290
100	1	271		26.63	26.61	26.74				
100	135	67		26.59	26.49	26.76				
100	1	0		20.12	20.10	20.29				
100	1	272		20.12	20.11	20.22				
100	270	0		24.58	24.59	24.78				
100	1	1	16-QAM	25.53	25.62	25.40	35.42	3.4834		
100	1	1	64-QAM	23.48	23.68	23.52				
100	1	1	256-QAM	21.02	21.25	20.97				
Limit	EIRP < 1640W/MHz			Result			Pass			



<MIMO Mode>

Part270_5G-FR1 n77 MIMO (PC1.5) Maximum Average Power [dBm], DG = 9.33 dBi														
BW (MHz)	RB Size	RB Offset	Mod	Antenna 4			Antenna 6			Combine			EIRP (dBm)	EIRP (W)
				Lowest	Middle	Highest	Lowest	Middle	Highest	Lowest	Middle	Highest		
10	1	1	QPSK	25.25	25.30	25.34	24.37	24.89	24.87	27.84	28.11	28.12	37.53	5.6624
10	1	22		25.27	25.34	25.36	24.49	24.93	24.91	27.91	28.15	28.15		
10	12	6		25.34	25.27	25.43	24.48	24.97	24.93	27.94	28.13	28.20		
10	1	0		20.27	20.36	20.24	19.49	19.69	19.93	22.91	23.05	23.10		
10	1	23		20.34	20.32	20.39	19.45	19.89	19.99	22.93	23.12	23.20		
10	24	0		22.79	22.81	22.89	21.95	22.47	22.44	25.40	25.65	25.68		
10	1	1	16-QAM	24.94	24.82	24.77	23.88	24.32	24.40	27.45	27.59	27.60	36.93	4.9317
10	1	1	64-QAM	22.76	22.89	22.73	22.04	22.50	22.37	25.43	25.71	25.56		
10	1	1	256-QAM	19.29	19.36	19.27	18.34	18.92	19.02	21.85	22.16	22.16		
Limit	EIRP < 1640W/MHz			Result									Pass	

Part270_5G-FR1 n77 MIMO (PC1.5) Maximum Average Power [dBm], DG = 9.33 dBi														
BW (MHz)	RB Size	RB Offset	Mod	Antenna 4			Antenna 6			Combine			EIRP (dBm)	EIRP (W)
				Lowest	Middle	Highest	Lowest	Middle	Highest	Lowest	Middle	Highest		
15	1	1	QPSK	25.43	25.54	25.63	24.76	25.09	25.32	28.12	28.33	28.49	37.82	6.0534
15	1	36		25.49	25.42	25.49	24.99	25.39	25.38	28.26	28.42	28.45		
15	19	9		25.47	25.53	25.62	24.79	25.20	25.25	28.15	28.38	28.45		
15	1	0		20.48	20.55	20.77	19.74	20.16	20.39	23.14	23.37	23.59		
15	1	37		20.52	20.47	20.69	19.88	20.23	20.41	23.22	23.36	23.56		
15	38	0		22.93	23.00	23.16	22.26	22.69	22.87	25.62	25.86	26.03		
15	1	1	16-QAM	25.14	25.07	25.28	24.09	24.58	24.87	27.66	27.84	28.09	37.42	5.5208
15	1	1	64-QAM	23.00	23.11	23.28	22.20	22.59	22.85	25.63	25.87	26.08		
15	1	1	256-QAM	19.61	19.56	19.81	18.77	19.23	19.43	22.22	22.41	22.63		
Limit	EIRP < 1640W/MHz			Result									Pass	

Part270_5G-FR1 n77 MIMO (PC1.5) Maximum Average Power [dBm], DG = 9.33 dBi														
BW (MHz)	RB Size	RB Offset	Mod	Antenna 4			Antenna 6			Combine			EIRP (dBm)	EIRP (W)
				Lowest	Middle	Highest	Lowest	Middle	Highest	Lowest	Middle	Highest		
20	1	1	QPSK	25.44	25.44	25.67	24.78	25.02	25.26	28.13	28.25	28.48	37.81	6.0395
20	1	49		25.57	25.36	25.66	24.88	25.17	25.22	28.25	28.28	28.46		
20	25	12		25.46	25.43	25.59	24.76	25.17	25.33	28.13	28.31	28.47		
20	1	0		20.49	20.51	20.78	19.75	20.10	20.30	23.15	23.32	23.56		
20	1	50		20.67	20.48	20.69	19.92	20.15	20.29	23.32	23.33	23.50		
20	51	0		23.03	23.03	23.10	22.36	22.71	22.83	25.72	25.88	25.98		
20	1	1	16-QAM	24.96	25.08	25.17	24.30	24.63	24.84	27.65	27.87	28.02	37.35	5.4325
20	1	1	64-QAM	23.00	23.02	23.28	22.28	22.67	22.89	25.67	25.86	26.10		
20	1	1	256-QAM	19.34	19.47	19.83	18.86	19.19	19.27	22.12	22.34	22.57		
Limit	EIRP < 1640W/MHz			Result									Pass	

Part270_5G-FR1 n77 MIMO (PC1.5) Maximum Average Power [dBm], DG = 9.33 dBi														
BW (MHz)	RB Size	RB Offset	Mod	Antenna 4			Antenna 6			Combine			EIRP (dBm)	EIRP (W)
				Lowest	Middle	Highest	Lowest	Middle	Highest	Lowest	Middle	Highest		
25	1	1	QPSK	25.38	25.20	25.59	24.58	24.94	25.10	28.01	28.08	28.36	37.69	5.8749
25	1	63		25.50	25.23	25.37	25.02	24.77	24.97	28.28	28.02	28.18		
25	33	16		25.37	25.22	25.43	24.73	24.92	24.98	28.07	28.08	28.22		
25	1	0		20.43	20.24	20.50	19.58	19.84	20.24	23.04	23.05	23.38		
25	1	64		20.60	20.24	20.54	19.74	19.89	19.99	23.20	23.08	23.28		
25	65	0		22.90	22.77	22.90	22.20	22.39	22.57	25.57	25.59	25.75		
25	1	1	16-QAM	24.91	24.75	25.08	24.14	24.42	24.56	27.55	27.60	27.84	37.17	5.2119
25	1	1	64-QAM	22.87	22.78	23.11	22.18	22.50	22.55	25.55	25.65	25.85		
25	1	1	256-QAM	19.34	19.37	19.62	18.68	19.04	19.20	22.03	22.22	22.43		
Limit	EIRP < 1640W/MHz			Result									Pass	



Part270_5G-FR1 n77 MIMO (PC1.5) Maximum Average Power [dBm], DG = 9.33 dBi														
BW	RB	RB	Mod	Antenna 4			Antenna 6			Combine			EIRP	EIRP
(MHz)	Size	Offset		Lowest	Middle	Highest	Lowest	Middle	Highest	Lowest	Middle	Highest	(dBm)	(W)
30	1	1	QPSK	25.28	25.30	25.65	24.48	24.91	25.23	27.91	28.12	28.46	37.79	6.0117
30	1	76		25.35	25.21	25.73	25.05	25.26	24.97	28.21	28.25	28.38		
30	39	19		25.36	25.32	25.58	24.66	24.96	25.12	28.03	28.15	28.37		
30	1	0		20.27	20.26	20.68	19.56	19.99	20.32	22.94	23.14	23.51		
30	1	77		20.42	20.29	20.53	19.82	19.91	20.21	23.14	23.11	23.38		
30	78	0		22.85	22.79	23.05	22.15	22.48	22.69	25.52	25.65	25.88		
30	1	1	16-QAM	24.83	24.78	25.23	23.79	24.41	24.84	27.35	27.61	28.05	37.38	5.4702
30	1	1	64-QAM	22.89	22.83	23.06	22.05	22.44	22.95	25.50	25.65	26.02		
30	1	1	256-QAM	19.27	19.32	19.62	18.57	19.09	19.31	21.94	22.22	22.48		
Limit	EIRP < 1640W/MHz			Result									Pass	

Part270_5G-FR1 n77 MIMO (PC1.5) Maximum Average Power [dBm], DG = 9.33 dBi														
BW	RB	RB	Mod	Antenna 4			Antenna 6			Combine			EIRP	EIRP
(MHz)	Size	Offset		Lowest	Middle	Highest	Lowest	Middle	Highest	Lowest	Middle	Highest	(dBm)	(W)
40	1	1	QPSK	25.58	25.60	25.52	24.79	25.00	25.15	28.21	28.32	28.35	37.70	5.8884
40	1	104		25.49	25.28	25.56	24.75	24.93	25.15	28.15	28.12	28.37		
40	53	26		25.50	25.29	25.53	24.75	24.95	25.13	28.15	28.13	28.34		
40	1	0		20.58	20.44	20.61	19.81	20.02	20.22	23.22	23.25	23.43		
40	1	105		20.58	20.20	20.59	19.84	19.96	20.04	23.24	23.09	23.33		
40	106	0		22.92	22.78	23.02	22.26	22.48	22.68	25.61	25.64	25.86		
40	1	1	16-QAM	25.10	24.97	25.06	24.13	24.75	24.79	27.65	27.87	27.94	37.27	5.3333
40	1	1	64-QAM	23.03	22.93	23.16	22.23	22.57	22.64	25.66	25.76	25.92		
40	1	1	256-QAM	19.67	19.30	19.52	18.77	19.01	19.19	22.25	22.17	22.37		
Limit	EIRP < 1640W/MHz			Result									Pass	

Part270_5G-FR1 n77 MIMO (PC1.5) Maximum Average Power [dBm], DG = 9.33 dBi														
BW	RB	RB	Mod	Antenna 4			Antenna 6			Combine			EIRP	EIRP
(MHz)	Size	Offset		Lowest	Middle	Highest	Lowest	Middle	Highest	Lowest	Middle	Highest	(dBm)	(W)
50	1	1	QPSK	25.02	25.15	25.18	24.21	24.71	24.89	27.64	27.95	28.05	37.54	5.6754
50	1	131		24.99	25.02	25.31	24.35	24.76	24.77	27.69	27.90	28.06		
50	67	33		25.20	25.21	25.42	24.41	24.82	24.97	27.83	28.03	28.21		
50	1	0		20.10	20.09	20.40	19.11	19.65	19.89	22.64	22.89	23.16		
50	1	132		20.00	20.02	20.31	19.32	19.74	19.90	22.68	22.89	23.12		
50	133	0		22.66	22.66	22.91	21.92	22.29	22.49	25.32	25.49	25.72		
50	1	1	16-QAM	24.61	24.70	24.97	23.78	24.09	24.38	27.23	27.42	27.70	37.03	5.0466
50	1	1	64-QAM	22.84	22.63	22.91	21.68	22.30	22.58	25.31	25.48	25.76		
50	1	1	256-QAM	19.13	19.24	19.28	18.43	18.74	18.86	21.80	22.01	22.09		
Limit	EIRP < 1640W/MHz			Result									Pass	

Part270_5G-FR1 n77 MIMO (PC1.5) Maximum Average Power [dBm], DG = 9.33 dBi														
BW	RB	RB	Mod	Antenna 4			Antenna 6			Combine			EIRP	EIRP
(MHz)	Size	Offset		Lowest	Middle	Highest	Lowest	Middle	Highest	Lowest	Middle	Highest	(dBm)	(W)
60	1	1	QPSK	25.12	25.07	25.07	24.22	24.69	24.74	27.70	27.89	27.92	37.55	5.6885
60	1	160		25.04	24.97	25.36	24.32	24.77	24.96	27.71	27.88	28.17		
60	81	40		25.12	25.06	25.38	24.50	24.76	25.03	27.83	27.92	28.22		
60	1	0		20.18	20.09	20.30	19.47	19.75	19.84	22.85	22.93	23.09		
60	1	161		20.08	20.00	20.26	19.42	19.66	19.96	22.77	22.84	23.12		
60	162	0		22.72	22.61	22.76	21.93	22.23	22.48	25.35	25.43	25.63		
60	1	1	16-QAM	24.46	24.57	24.60	23.83	24.32	24.35	27.17	27.46	27.49	36.82	4.8084
60	1	1	64-QAM	22.70	22.52	22.62	21.95	22.28	22.20	25.35	25.41	25.43		
60	1	1	256-QAM	19.00	19.17	19.20	18.37	18.68	18.73	21.71	21.94	21.98		
Limit	EIRP < 1640W/MHz			Result									Pass	



Part270_5G-FR1 n77 MIMO (PC1.5) Maximum Average Power [dBm], DG = 9.33 dBi														
BW	RB	RB	Mod	Antenna 4			Antenna 6			Combine			EIRP	EIRP
(MHz)	Size	Offset		Lowest	Middle	Highest	Lowest	Middle	Highest	Lowest	Middle	Highest	(dBm)	(W)
70	1	1	QPSK	25.03	25.02	25.16	24.18	24.63	24.72	27.64	27.84	27.96	37.35	5.4325
70	1	187		25.13	25.04	25.06	24.56	24.60	24.88	27.86	27.84	27.98		
70	95	47		25.07	24.95	25.18	24.37	24.67	24.83	27.74	27.82	28.02		
70	1	0		20.16	19.95	20.28	19.09	19.74	19.91	22.67	22.86	23.11		
70	1	188		19.90	19.87	20.06	19.55	19.57	19.93	22.74	22.73	23.01		
70	189	0		22.55	22.58	22.65	21.74	22.22	22.34	25.17	25.41	25.51		
70	1	1	16-QAM	24.60	24.84	25.05	24.02	24.49	24.13	27.33	27.68	27.62	37.01	5.0234
70	1	1	64-QAM	22.60	22.57	22.91	21.58	22.18	22.29	25.13	25.39	25.62		
70	1	1	256-QAM	19.15	19.25	19.19	18.27	19.01	18.47	21.74	22.14	21.86		
Limit	EIRP < 1640W/MHz			Result									Pass	

Part270_5G-FR1 n77 MIMO (PC1.5) Maximum Average Power [dBm], DG = 9.33 dBi														
BW	RB	RB	Mod	Antenna 4			Antenna 6			Combine			EIRP	EIRP
(MHz)	Size	Offset		Lowest	Middle	Highest	Lowest	Middle	Highest	Lowest	Middle	Highest	(dBm)	(W)
80	1	1	QPSK	25.08	25.03	25.28	24.14	24.70	24.62	27.65	27.88	27.97	37.42	5.5208
80	1	215		25.08	25.01	25.31	24.54	24.66	24.84	27.83	27.85	28.09		
80	109	54		25.18	24.97	25.17	24.44	24.59	24.89	27.84	27.79	28.04		
80	1	0		20.08	19.93	20.28	19.22	19.43	19.67	22.68	22.70	23.00		
80	1	216		20.00	20.11	20.32	19.62	19.50	19.93	22.82	22.83	23.14		
80	217	0		22.68	22.53	22.72	21.87	22.15	22.32	25.30	25.35	25.53		
80	1	1	16-QAM	24.66	24.52	24.67	23.73	24.23	24.20	27.23	27.39	27.45	36.78	4.7643
80	1	1	64-QAM	22.56	22.69	22.69	21.71	22.36	22.24	25.17	25.54	25.48		
80	1	1	256-QAM	19.35	19.08	19.17	18.18	18.81	18.81	21.81	21.96	22.00		
Limit	EIRP < 1640W/MHz			Result									Pass	

Part270_5G-FR1 n77 MIMO (PC1.5) Maximum Average Power [dBm], DG = 9.33 dBi														
BW	RB	RB	Mod	Antenna 4			Antenna 6			Combine			EIRP	EIRP
(MHz)	Size	Offset		Lowest	Middle	Highest	Lowest	Middle	Highest	Lowest	Middle	Highest	(dBm)	(W)
90	1	1	QPSK	25.27	25.18	24.92	24.09	24.81	24.77	27.73	28.01	27.86	37.45	5.5590
90	1	243		25.08	24.98	25.24	24.62	24.72	24.97	27.87	27.86	28.12		
90	123	61		24.95	24.97	25.28	24.30	24.60	24.89	27.65	27.80	28.10		
90	1	0		20.02	20.01	20.33	19.07	19.66	19.88	22.58	22.85	23.12		
90	1	244		20.29	20.10	20.24	19.63	19.76	19.69	22.98	22.94	22.98		
90	245	0		22.60	22.51	22.75	21.82	22.13	22.35	25.24	25.33	25.56		
90	1	1	16-QAM	24.45	24.70	24.51	23.65	24.68	24.32	27.08	27.70	27.43	37.03	5.0466
90	1	1	64-QAM	22.11	22.79	22.42	21.65	22.36	22.26	24.90	25.59	25.35		
90	1	1	256-QAM	18.95	19.55	18.86	18.13	18.87	18.92	21.57	22.23	21.90		
Limit	EIRP < 1640W/MHz			Result									Pass	

Part270_5G-FR1 n77 MIMO (PC1.5) Maximum Average Power [dBm], DG = 9.33 dBi														
BW	RB	RB	Mod	Antenna 4			Antenna 6			Combine			EIRP	EIRP
(MHz)	Size	Offset		Lowest	Middle	Highest	Lowest	Middle	Highest	Lowest	Middle	Highest	(dBm)	(W)
100	1	1	QPSK	24.87	24.99	24.92	24.24	24.78	24.58	27.58	27.90	27.76	37.37	5.4576
100	1	271		25.11	25.05	25.15	24.46	24.75	24.84	27.81	27.91	28.01		
100	137	68		25.06	24.95	25.23	24.34	24.55	24.81	27.73	27.76	28.04		
100	1	0		20.02	20.06	20.27	19.34	19.74	19.79	22.70	22.91	23.05		
100	1	272		20.13	20.14	20.21	19.40	19.78	19.94	22.79	22.97	23.09		
100	273	0		22.65	22.51	22.74	21.93	22.23	22.32	25.32	25.38	25.55		
100	1	1	16-QAM	24.75	24.75	24.68	24.06	24.29	24.12	27.43	27.54	27.42	36.87	4.8641
100	1	1	64-QAM	22.40	22.85	22.61	21.93	22.30	22.05	25.18	25.59	25.35		
100	1	1	256-QAM	19.08	19.22	18.94	18.30	19.01	18.63	21.72	22.13	21.80		
Limit	EIRP < 1640W/MHz			Result									Pass	



5G-FR1 SA n77 (PC2)

<SISO Mode>

Peak-to-Average Ratio

Mode	5G-FR1 SA n77 (PC2) / 20MHz / DFT-S OFDM				
Mod.	PI/2 BPSK	QPSK	16QAM	64QAM	Limit: 13dB
RB Size	Full RB	Full RB	Full RB	Full RB	Result
Middle CH	4.32	5.06	6.06	6.28	PASS
Mode	5G-FR1 SA n77 (PC2) / 20MHz / DFT-S OFDM				
Mod.	256QAM				Limit: 13dB
RB Size	Full RB				Result
Middle CH	6.60				PASS



5G-FR1 SA n77 (PC2) / 20MHz / DFT-S OFDM / Middle Channel / Full RB

PI/2 BPSK

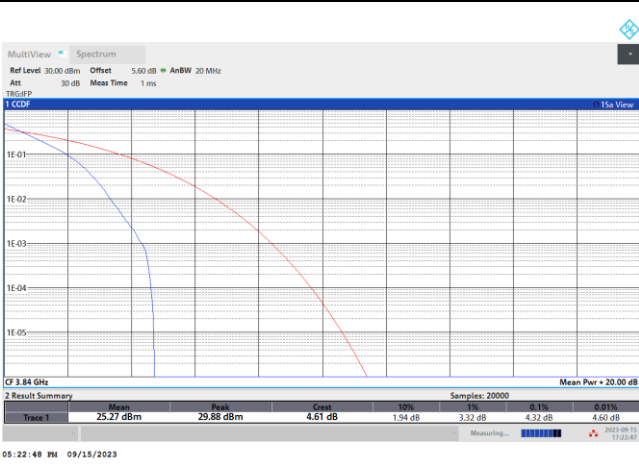

QPSK

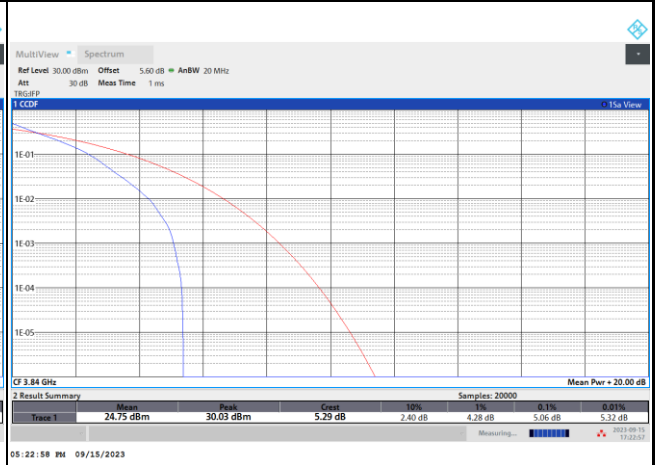

16QAM

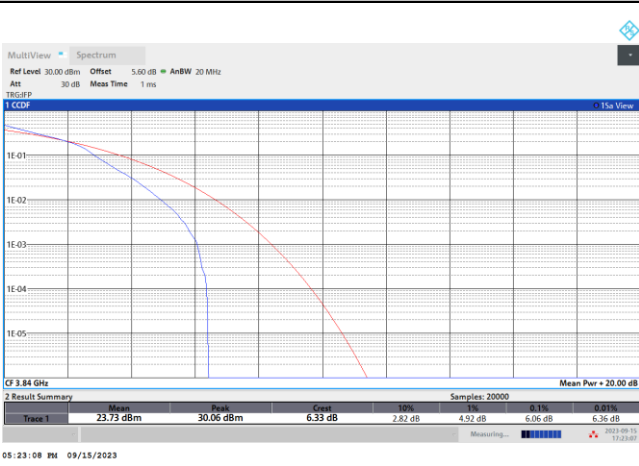

64QAM

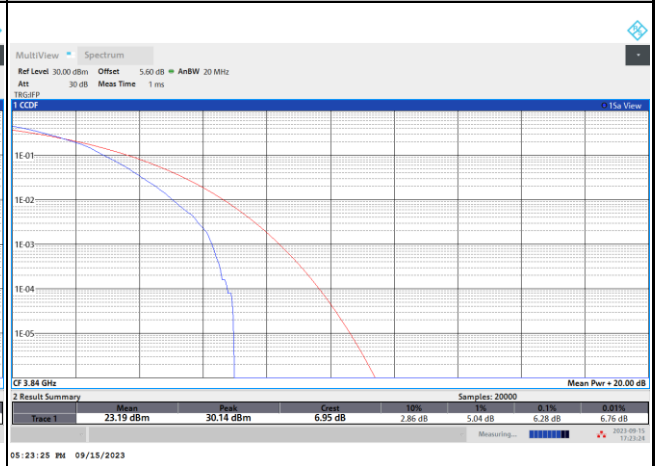

256QAM

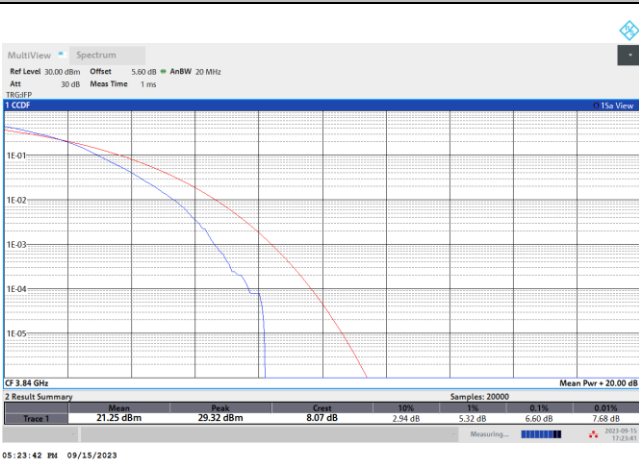



26dB Bandwidth

Mode	5G-FR1 SA n77 (PC2) : 26dB BW(MHz) / DFT-S OFDM							
BW	10MHz	15MHz	20MHz	25MHz	30MHz	40MHz	50MHz	60MHz
Mod.	PI/2 BPSK	PI/2 BPSK	PI/2 BPSK	PI/2 BPSK	PI/2 BPSK	PI/2 BPSK	PI/2 BPSK	PI/2 BPSK
Middle CH	9.67	14.51	19.34	24.83	28.53	38.20	48.55	60.66
BW	70MHz	80MHz	90MHz	100MHz				
Mod.	PI/2 BPSK	PI/2 BPSK	PI/2 BPSK	PI/2 BPSK				
Middle CH	67.13	80.24	89.73	99.70				

Mode	5G-FR1 SA n77 (PC2) : 26dB BW(MHz) / CP OFDM							
BW	10MHz		15MHz		20MHz		25MHz	
Mod.	QPSK	16QAM	QPSK	16QAM	QPSK	16QAM	QPSK	16QAM
Middle CH	9.95	9.99	15.32	15.17	19.98	19.58	25.03	24.73
Mod.	64QAM	256QAM	64QAM	256QAM	64QAM	256QAM	64QAM	256QAM
Middle CH	9.97	9.75	15.08	14.84	19.74	19.86	24.38	24.93
BW	30MHz		40MHz		50MHz		60MHz	
Mod.	QPSK	16QAM	QPSK	16QAM	QPSK	16QAM	QPSK	16QAM
Middle CH	29.55	29.31	40.52	40.52	50.25	50.15	60.42	60.78
Mod.	64QAM	256QAM	64QAM	256QAM	64QAM	256QAM	64QAM	256QAM
Middle CH	29.31	29.25	40.68	40.60	50.25	50.25	60.54	60.78
BW	70MHz		80MHz		90MHz		100MHz	
Mod.	QPSK	16QAM	QPSK	16QAM	QPSK	16QAM	QPSK	16QAM
Middle CH	70.49	70.49	80.72	80.40	90.63	90.63	100.90	100.50
Mod.	64QAM	256QAM	64QAM	256QAM	64QAM	256QAM	64QAM	256QAM
Middle CH	70.35	70.35	80.72	80.56	90.63	90.81	100.90	100.90



5G-FR1 SA n77 (PC2) / 10MHz / DFT-S OFDM / Middle Channel / Full RB

PI/2 BPSK

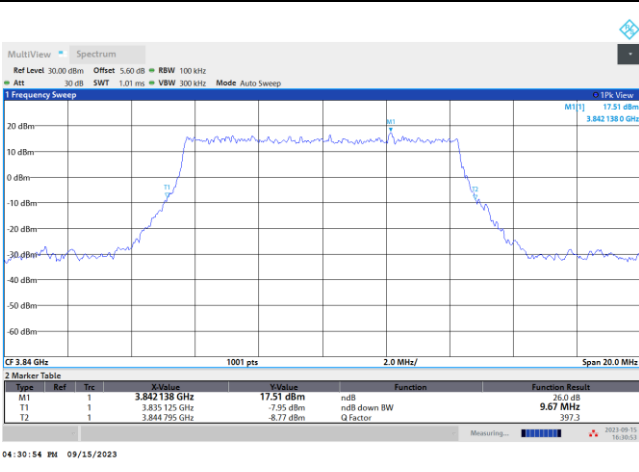

5G-FR1 SA n77 (PC2) / 10MHz / CP OFDM / Middle Channel / Full RB

QPSK

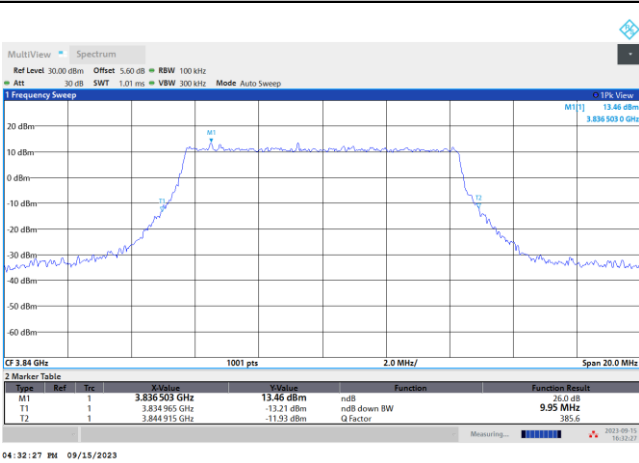

16QAM

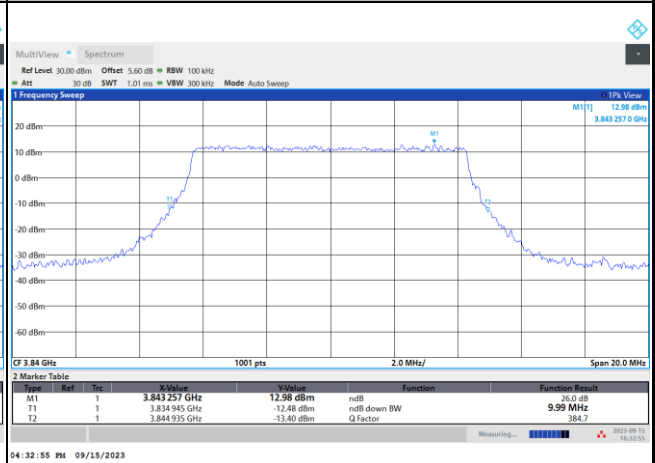

64QAM

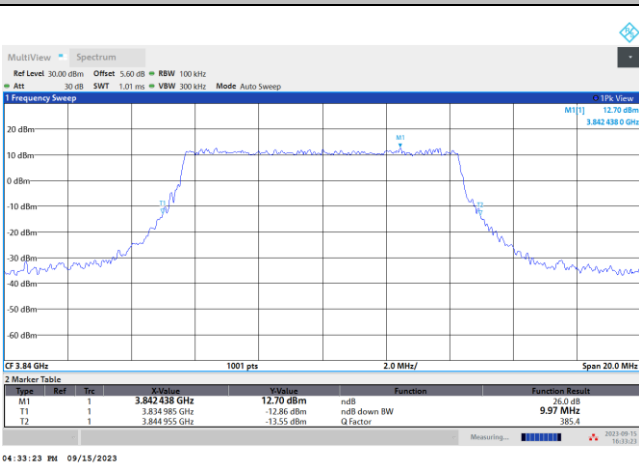

256QAM

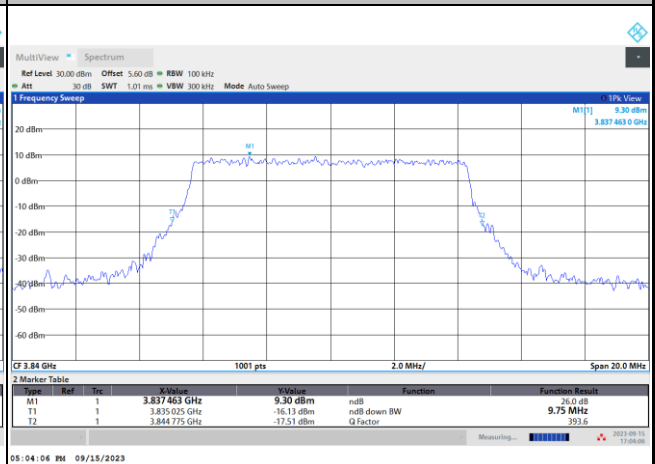



5G-FR1 SA n77 (PC2) / 15MHz / DFT-S OFDM / Middle Channel / Full RB

PI/2 BPSK

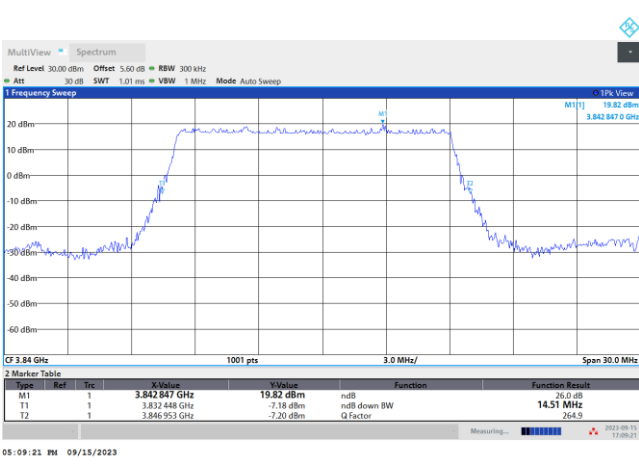

5G-FR1 SA n77 (PC2) / 15MHz / CP OFDM / Middle Channel / Full RB

QPSK

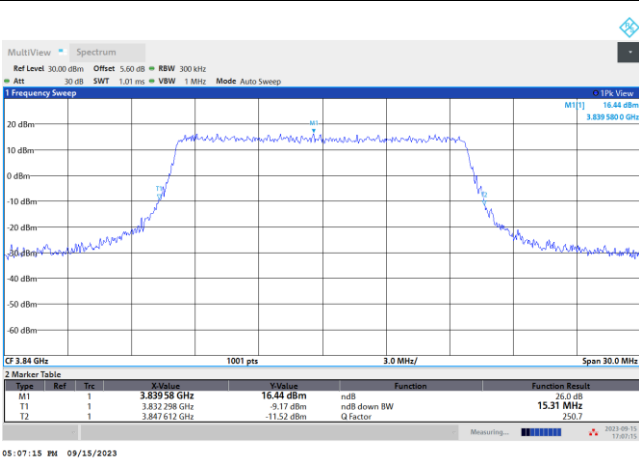

16QAM

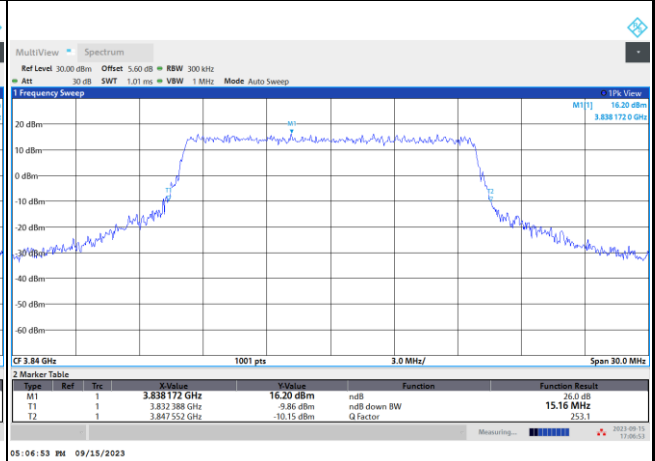

64QAM

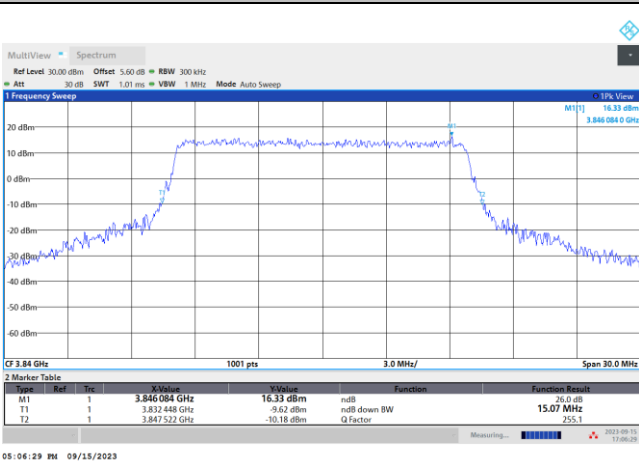

256QAM

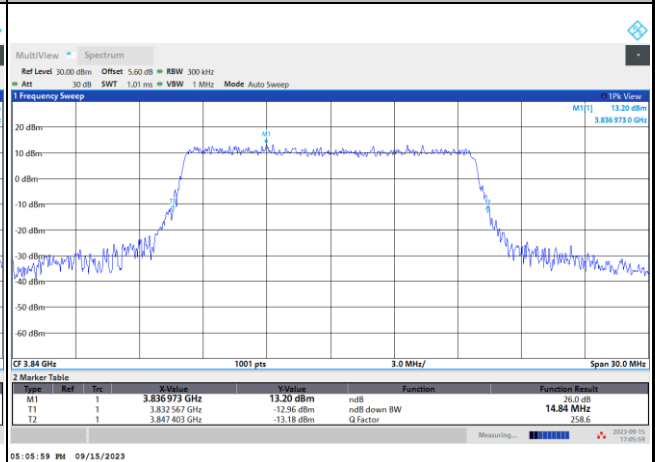



5G-FR1 SA n77 (PC2) / 20MHz / DFT-S OFDM / Middle Channel / Full RB

PI/2 BPSK

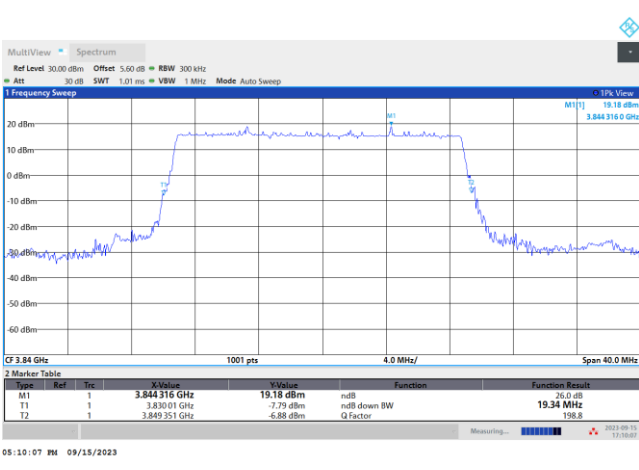

5G-FR1 SA n77 (PC2) / 20MHz / CP OFDM / Middle Channel / Full RB

QPSK

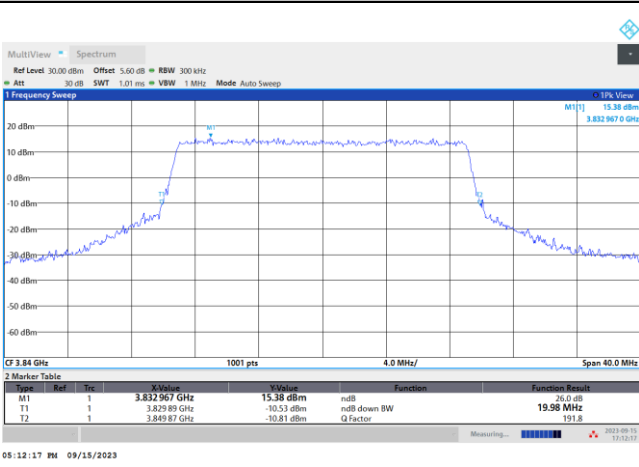

16QAM

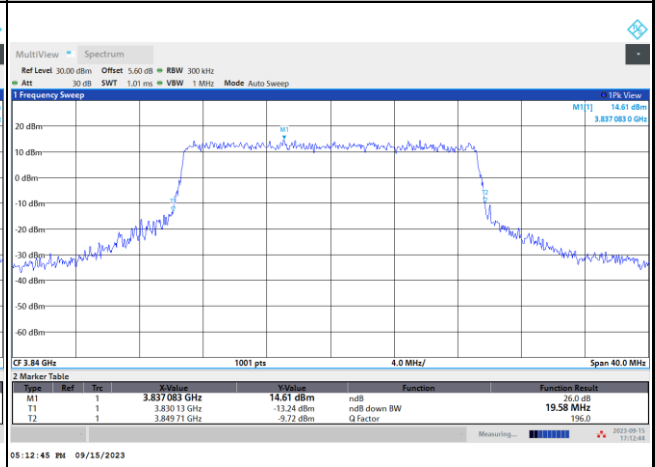

64QAM

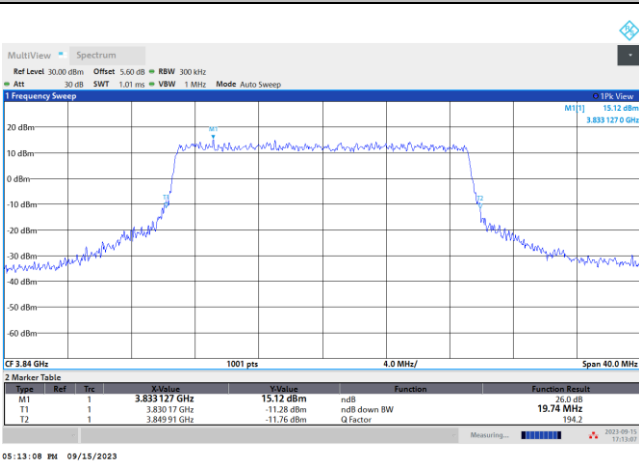

256QAM

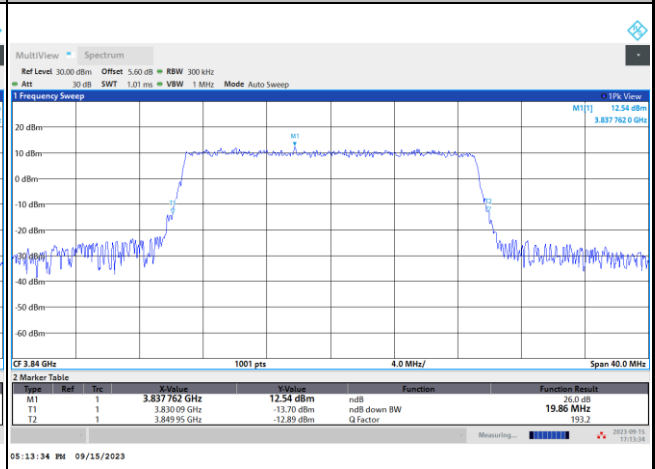



5G-FR1 SA n77 (PC2) / 25MHz / DFT-S OFDM / Middle Channel / Full RB

PI/2 BPSK

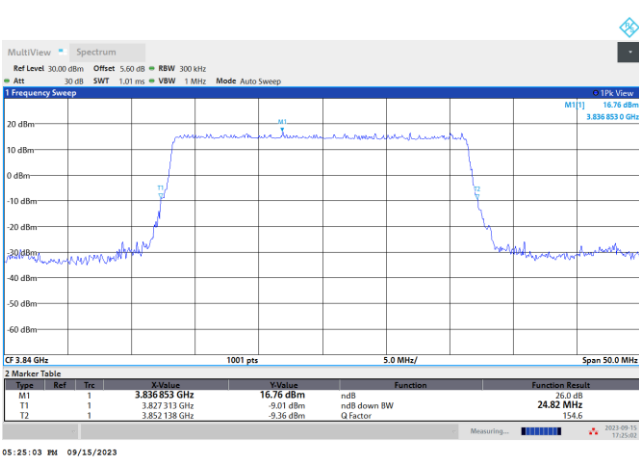

5G-FR1 SA n77 (PC2) / 25MHz / CP OFDM / Middle Channel / Full RB

QPSK

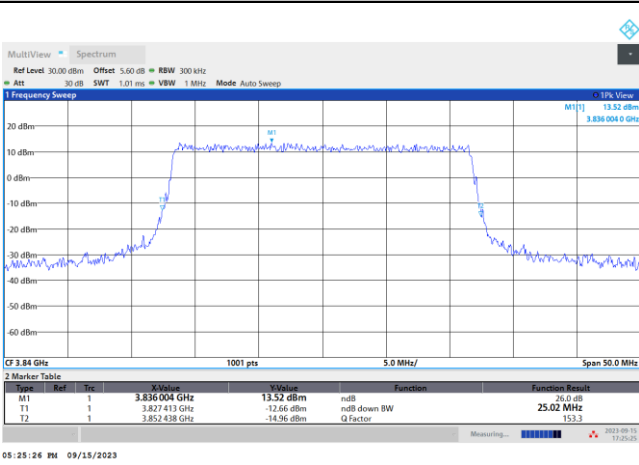

16QAM

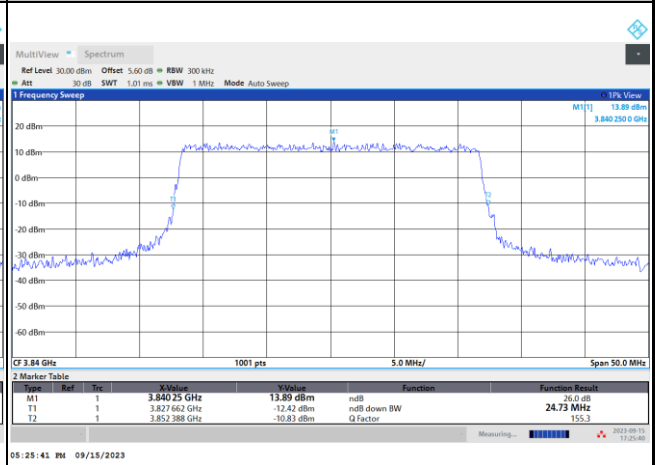

64QAM

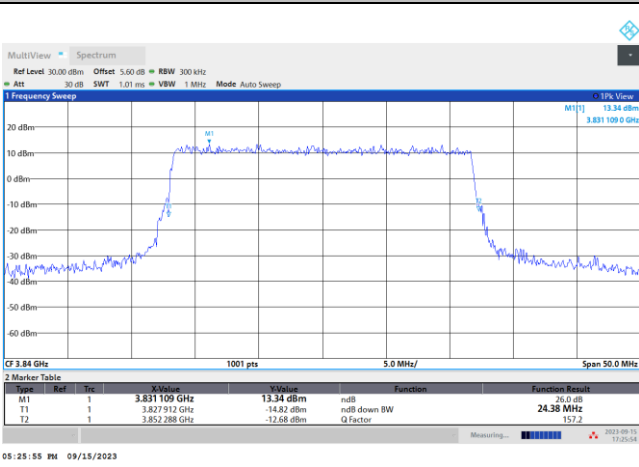

256QAM

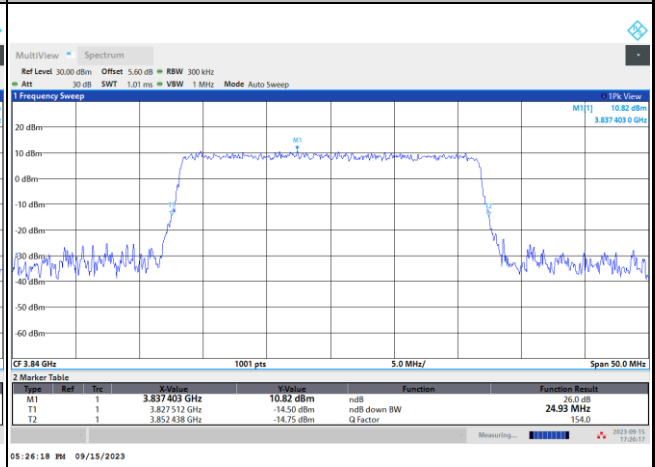



5G-FR1 SA n77 (PC2) / 30MHz / DFT-S OFDM / Middle Channel / Full RB

PI/2 BPSK

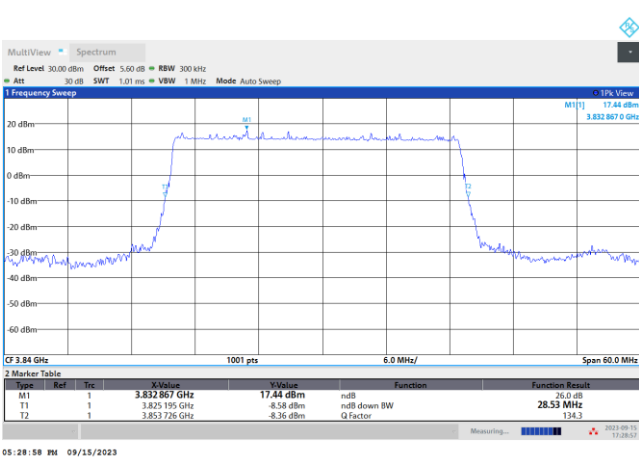

5G-FR1 SA n77 (PC2) / 30MHz / CP OFDM / Middle Channel / Full RB

QPSK

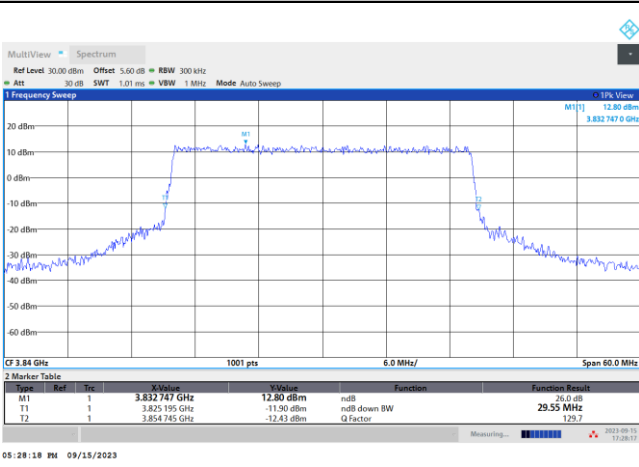

16QAM

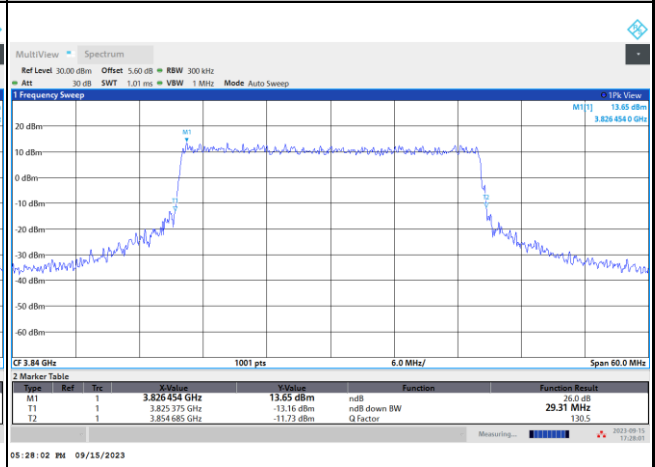

64QAM

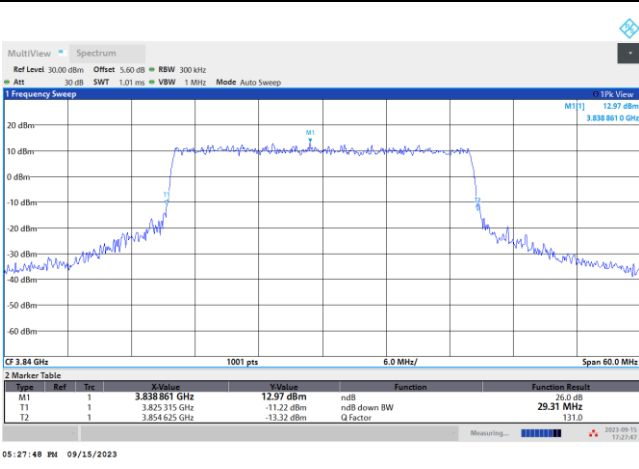

256QAM

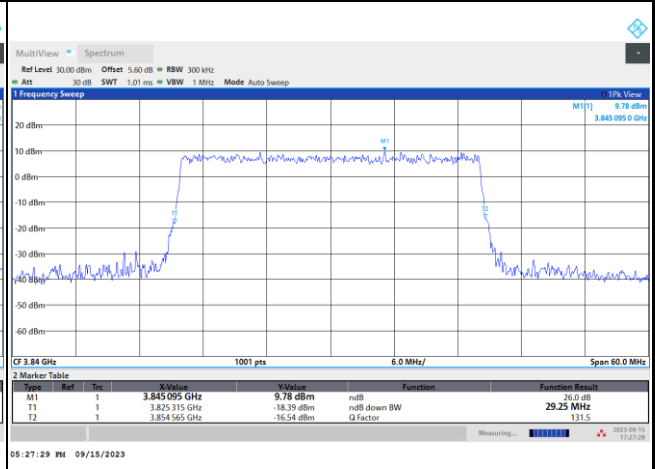



5G-FR1 SA n77 (PC2) / 40MHz / DFT-S OFDM / Middle Channel / Full RB

PI/2 BPSK

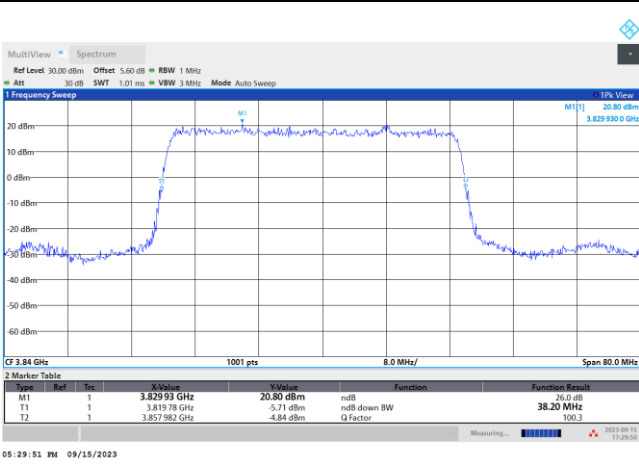

5G-FR1 SA n77 (PC2) / 40MHz / CP OFDM / Middle Channel / Full RB

QPSK

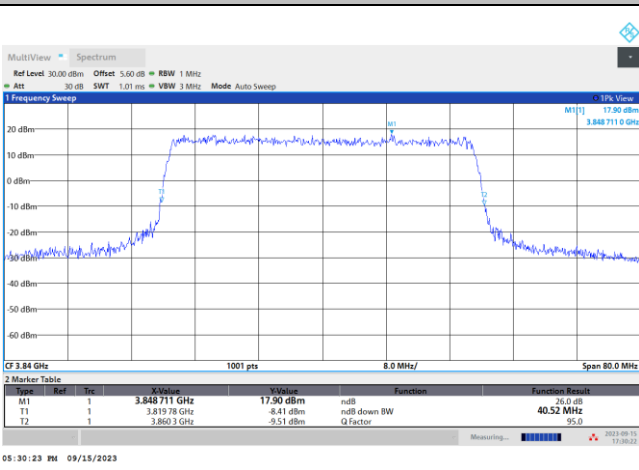

16QAM

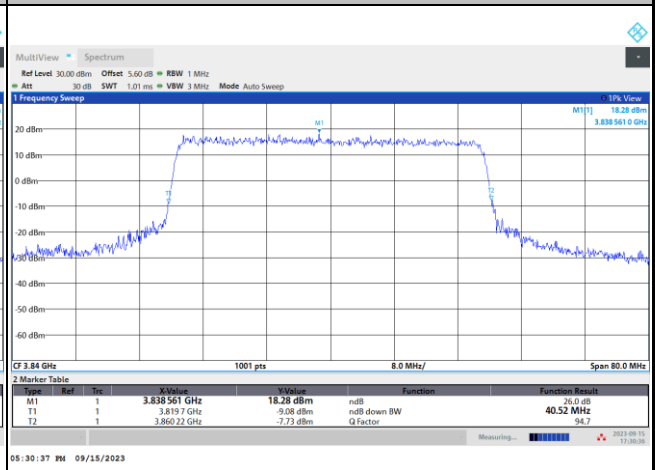

64QAM

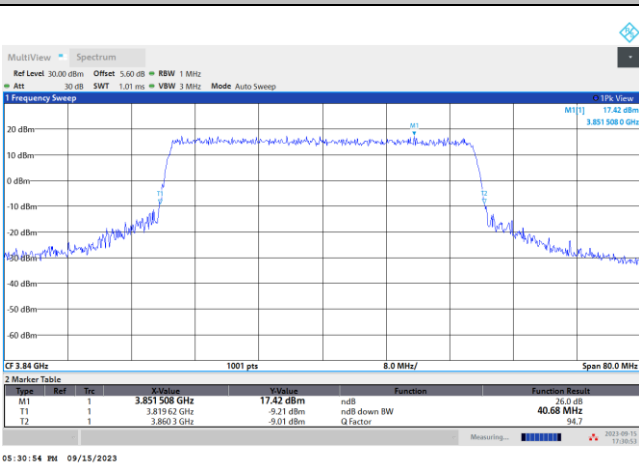

256QAM

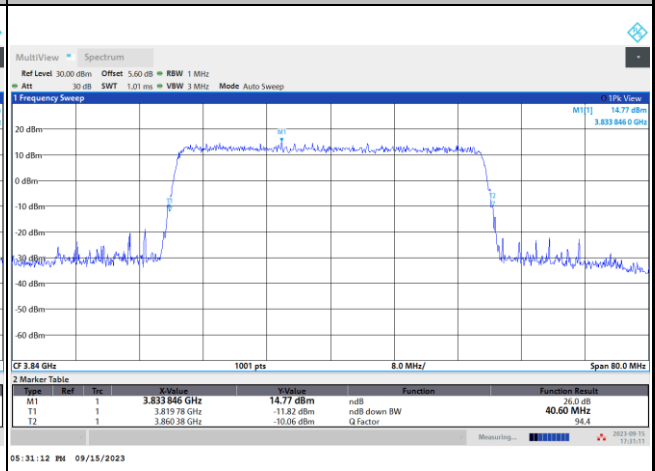



5G-FR1 SA n77 (PC2) / 50MHz / DFT-S OFDM / Middle Channel / Full RB

PI/2 BPSK

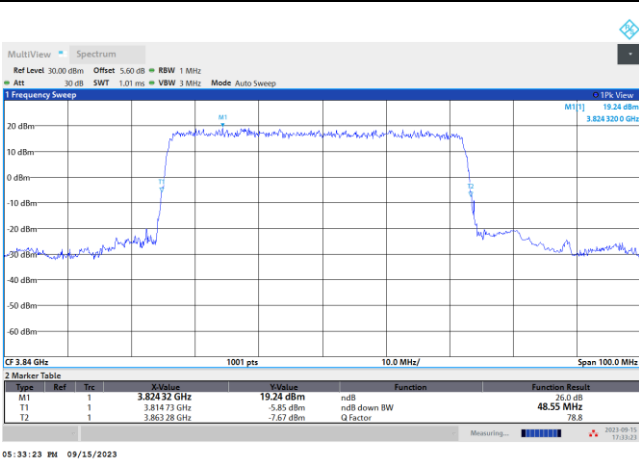

5G-FR1 SA n77 (PC2) / 50MHz / CP OFDM / Middle Channel / Full RB

QPSK

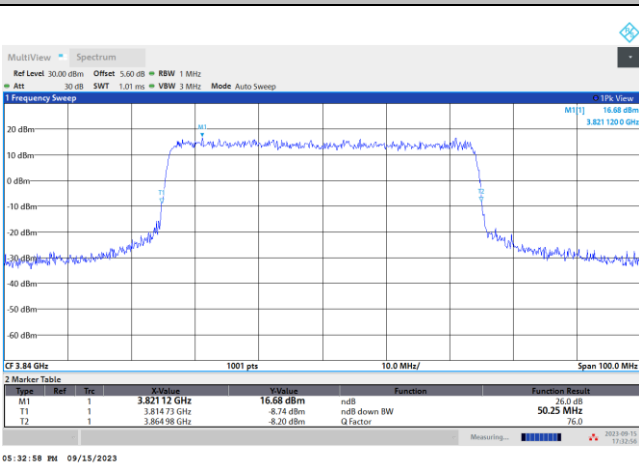

16QAM

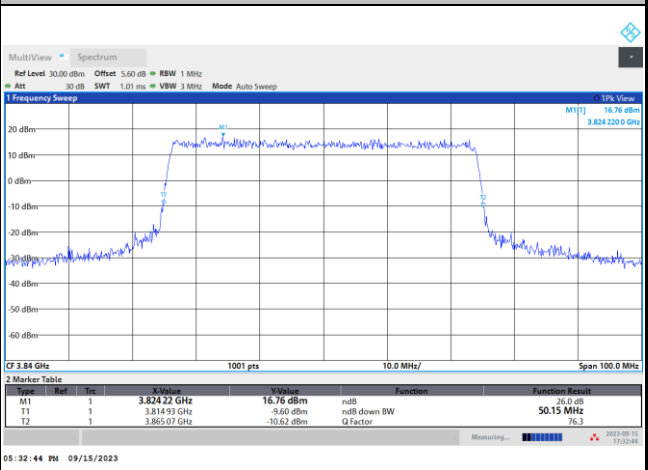

64QAM

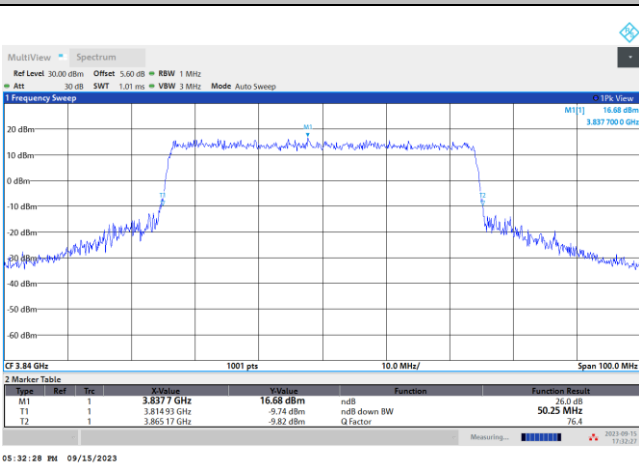

256QAM

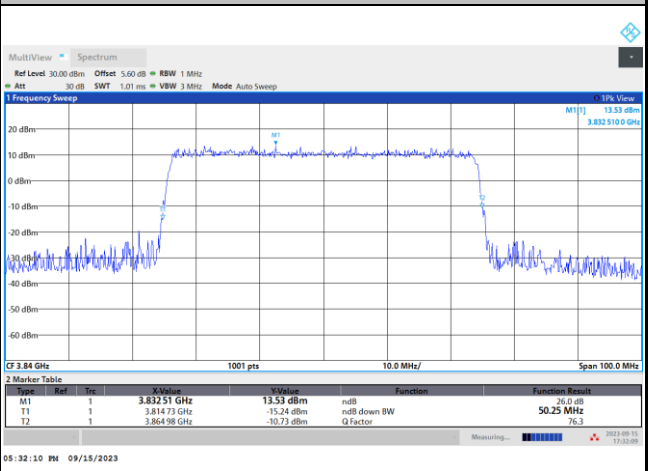



5G-FR1 SA n77 (PC2) / 60MHz / DFT-S OFDM / Middle Channel / Full RB

PI/2 BPSK

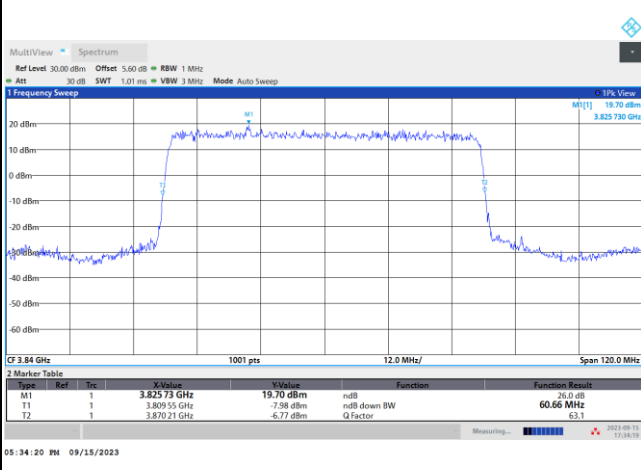

5G-FR1 SA n77 (PC2) / 60MHz / CP OFDM / Middle Channel / Full RB

QPSK

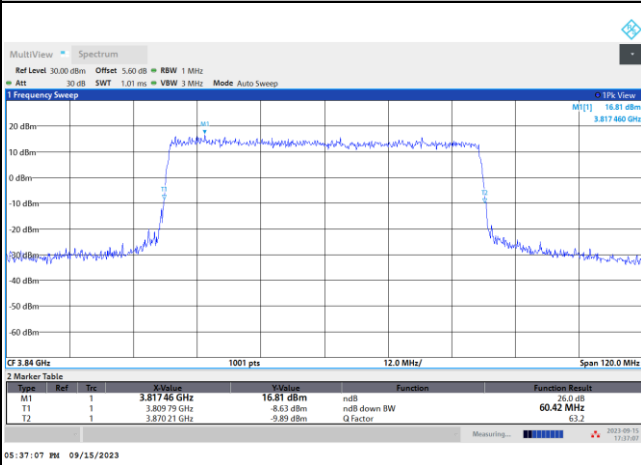

16QAM

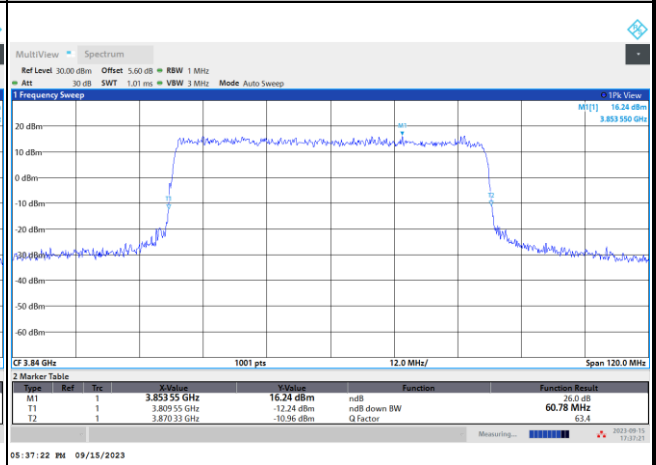

64QAM

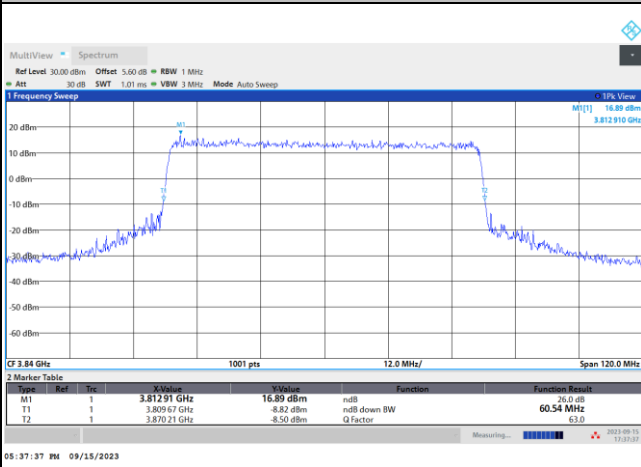

256QAM

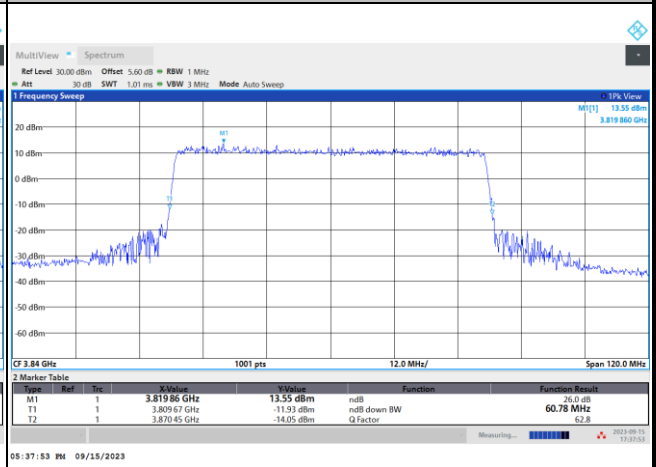



5G-FR1 SA n77 (PC2) / 70MHz / DFT-S OFDM / Middle Channel / Full RB

PI/2 BPSK

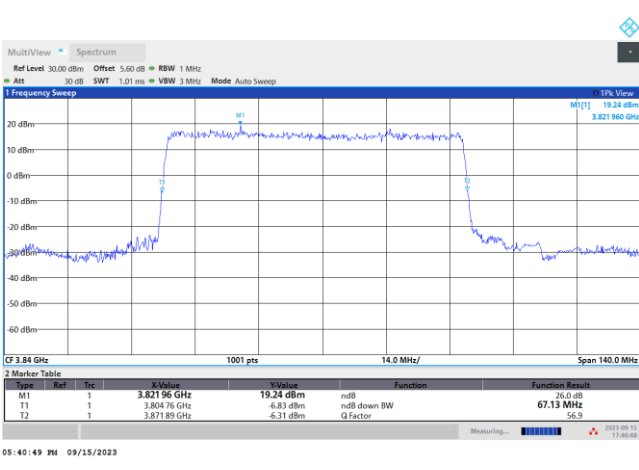

5G-FR1 SA n77 (PC2) / 70MHz / CP OFDM / Middle Channel / Full RB

QPSK

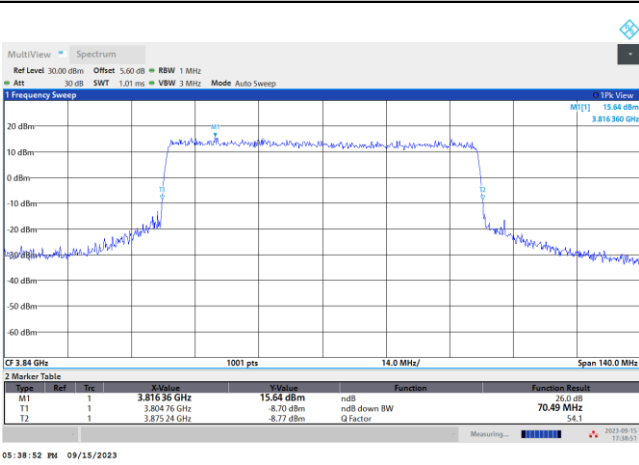

16QAM

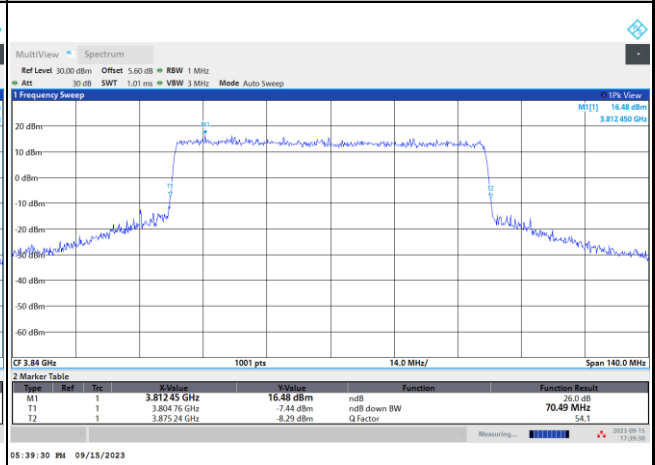

64QAM

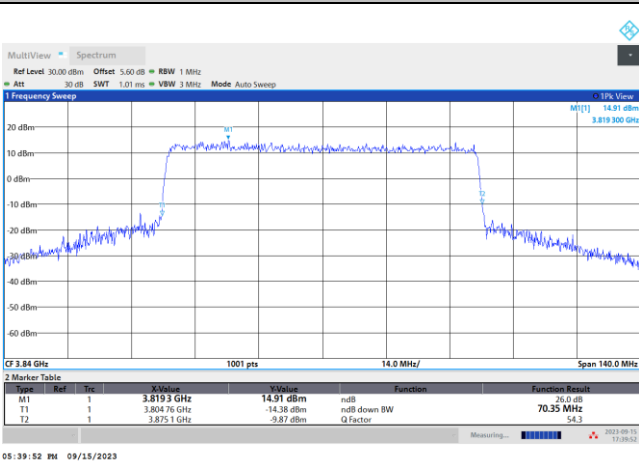

256QAM

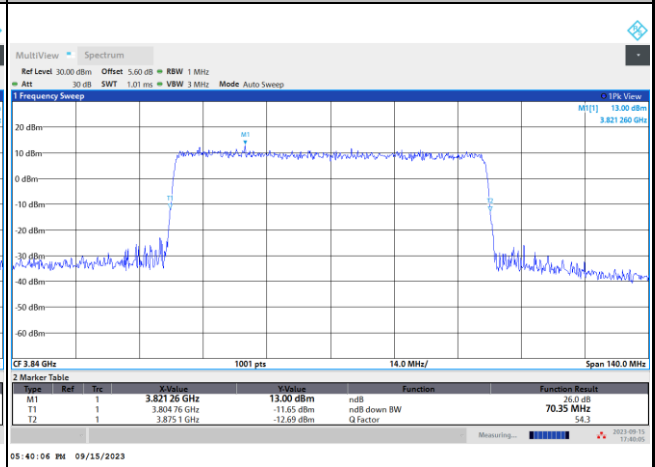



5G-FR1 SA n77 (PC2) / 80MHz / DFT-S OFDM / Middle Channel / Full RB

PI/2 BPSK

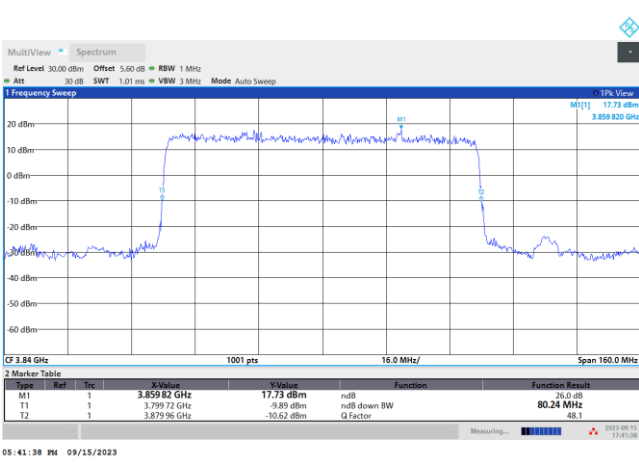

5G-FR1 SA n77 (PC2) / 80MHz / CP OFDM / Middle Channel / Full RB

QPSK

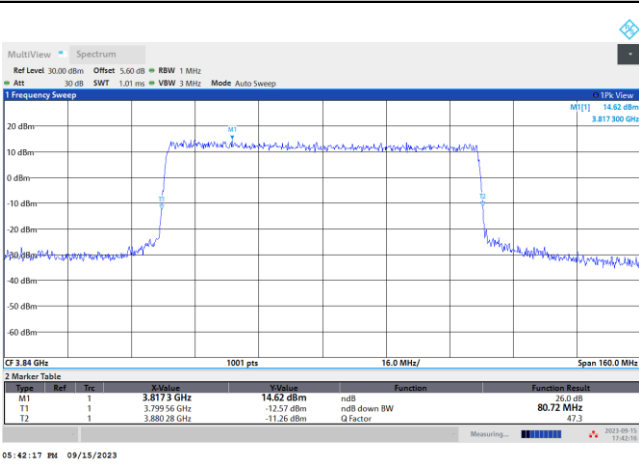

16QAM

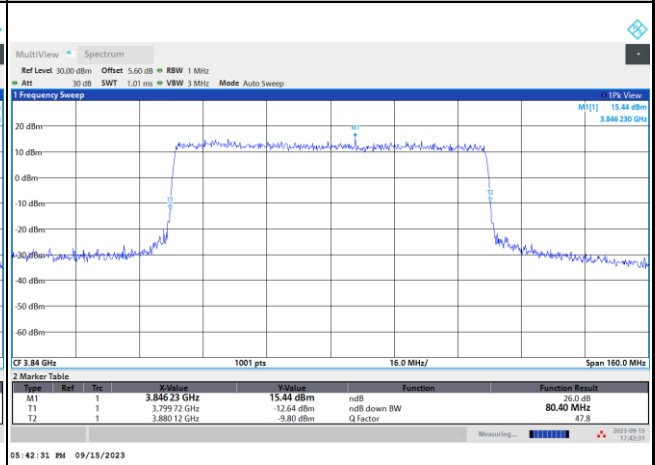

64QAM

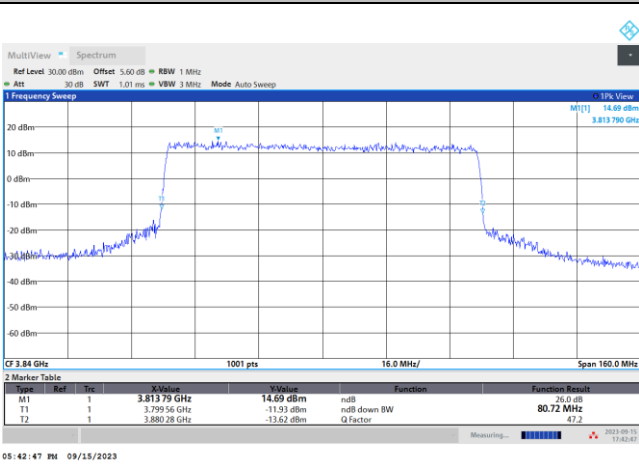

256QAM

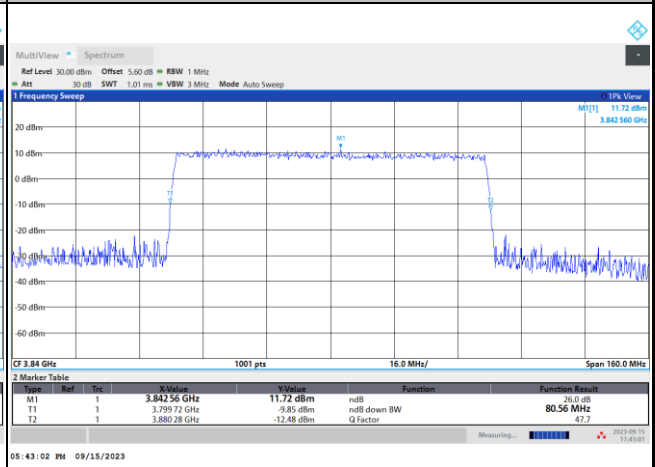



5G-FR1 SA n77 (PC2) / 90MHz / DFT-S OFDM / Middle Channel / Full RB

PI/2 BPSK

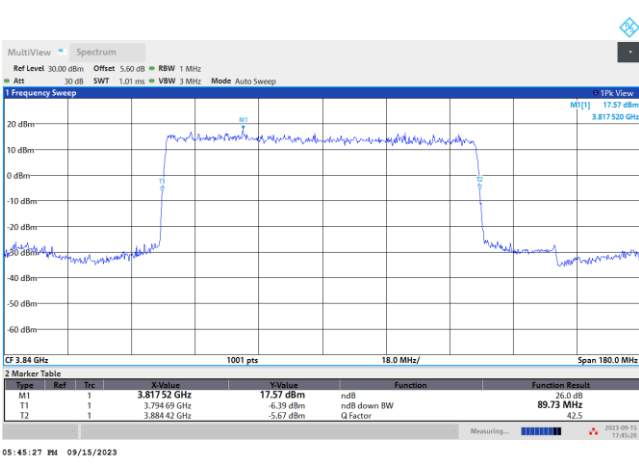

5G-FR1 SA n77 (PC2) / 90MHz / CP OFDM / Middle Channel / Full RB

QPSK

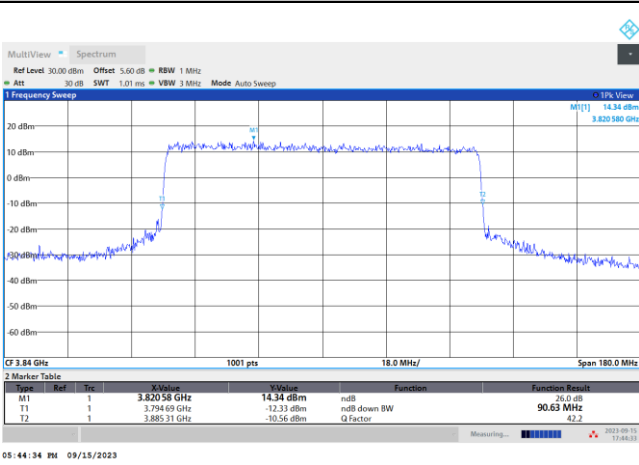

16QAM

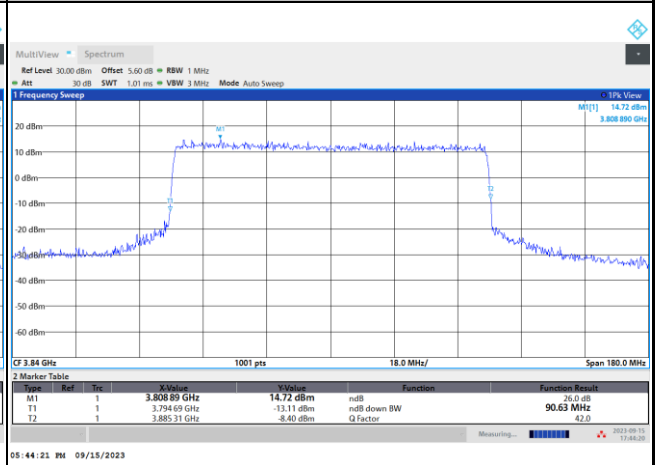

64QAM

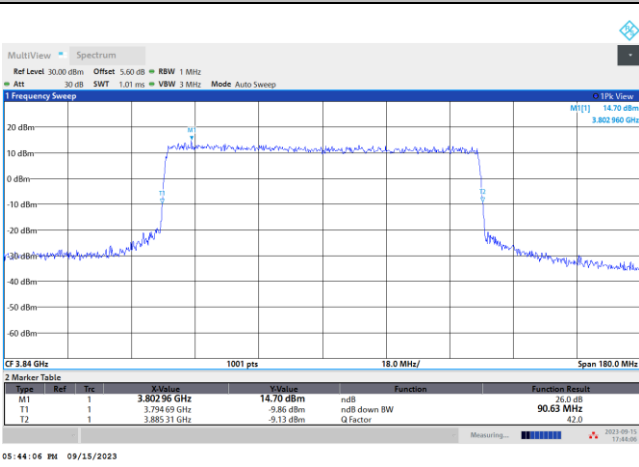

256QAM

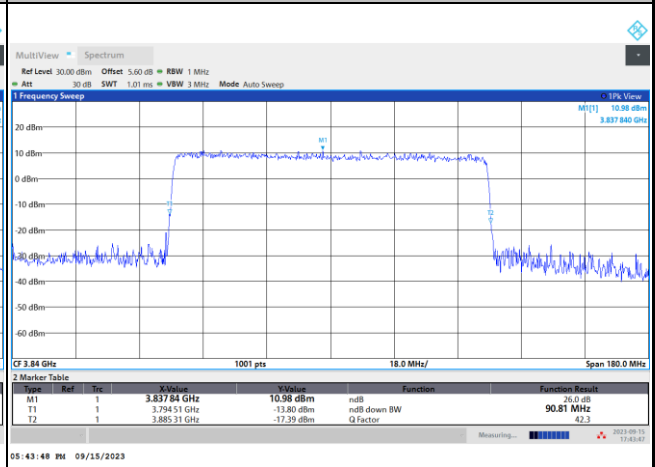



5G-FR1 SA n77 (PC2) / 100MHz / DFT-S OFDM / Middle Channel / Full RB

PI/2 BPSK

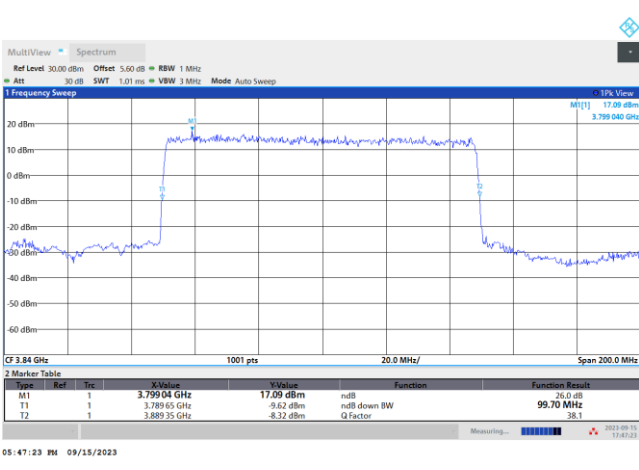

5G-FR1 SA n77 (PC2) / 100MHz / CP OFDM / Middle Channel / Full RB

QPSK

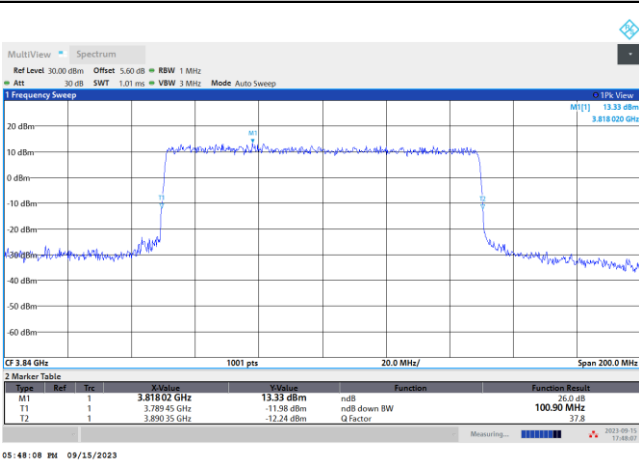

16QAM

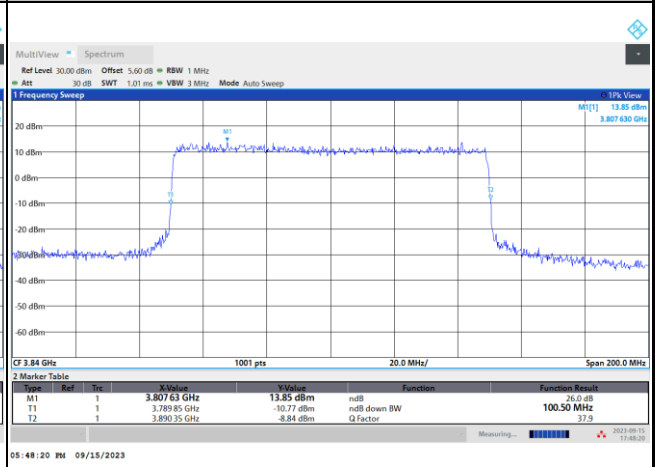

64QAM

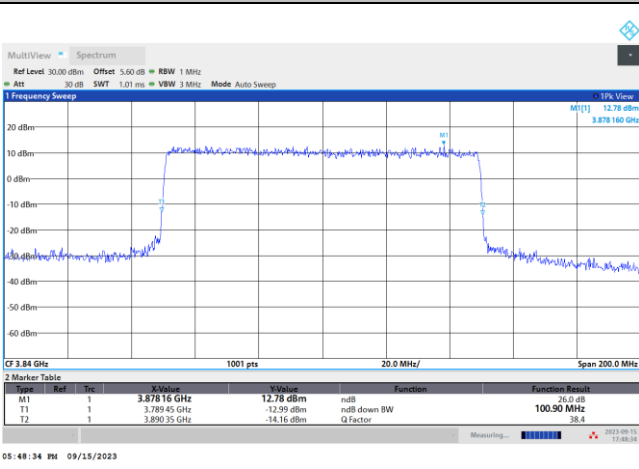

256QAM

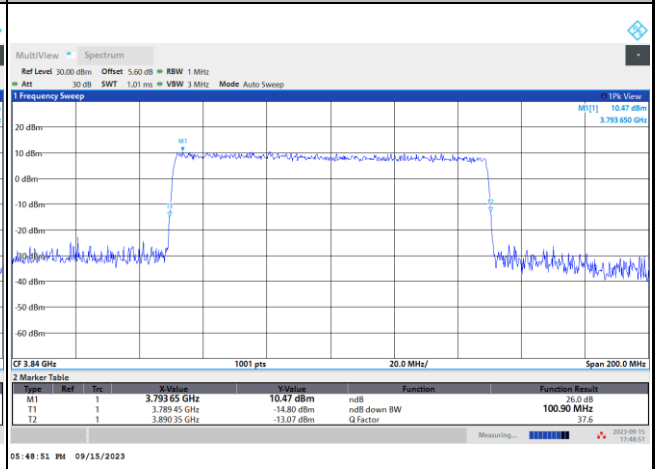



Occupied Bandwidth

Mode	5G-FR1 SA n77 (PC2) : OB BW(MHz) / DFT-S OFDM							
BW	10MHz	15MHz	20MHz	25MHz	30MHz	40MHz	50MHz	60MHz
Mod.	PI/2 BPSK	PI/2 BPSK	PI/2 BPSK	PI/2 BPSK	PI/2 BPSK	PI/2 BPSK	PI/2 BPSK	PI/2 BPSK
Middle CH	8.61	12.93	17.91	22.89	26.83	36.00	45.81	57.76
BW	70MHz	80MHz	90MHz	100MHz				
Mod.	PI/2 BPSK	PI/2 BPSK	PI/2 BPSK	PI/2 BPSK				
Middle CH	64.32	76.98	86.79	96.25				

Mode	5G-FR1 SA n77 (PC2) : OB BW(MHz) / CP OFDM							
BW	10MHz		15MHz		20MHz		25MHz	
Mod.	QPSK	16QAM	QPSK	16QAM	QPSK	16QAM	QPSK	16QAM
Middle CH	8.63	8.63	13.67	13.69	18.25	18.20	23.17	23.23
Mod.	64QAM	256QAM	64QAM	256QAM	64QAM	256QAM	64QAM	256QAM
Middle CH	8.62	8.60	13.65	13.65	18.30	18.25	23.24	23.17
BW	30MHz		40MHz		50MHz		60MHz	
Mod.	QPSK	16QAM	QPSK	16QAM	QPSK	16QAM	QPSK	16QAM
Middle CH	27.86	27.87	38.01	37.98	47.57	47.59	57.83	57.73
Mod.	64QAM	256QAM	64QAM	256QAM	64QAM	256QAM	64QAM	256QAM
Middle CH	27.88	27.84	37.99	38.02	47.57	47.50	57.83	57.86
BW	70MHz		80MHz		90MHz		100MHz	
Mod.	QPSK	16QAM	QPSK	16QAM	QPSK	16QAM	QPSK	16QAM
Middle CH	67.42	67.43	77.41	77.49	87.27	87.38	97.43	97.34
Mod.	64QAM	256QAM	64QAM	256QAM	64QAM	256QAM	64QAM	256QAM
Middle CH	67.59	67.50	77.44	77.35	87.23	87.42	97.23	97.32



5G-FR1 SA n77 (PC2) / 10MHz / DFT-S OFDM / Middle Channel / Full RB

PI/2 BPSK

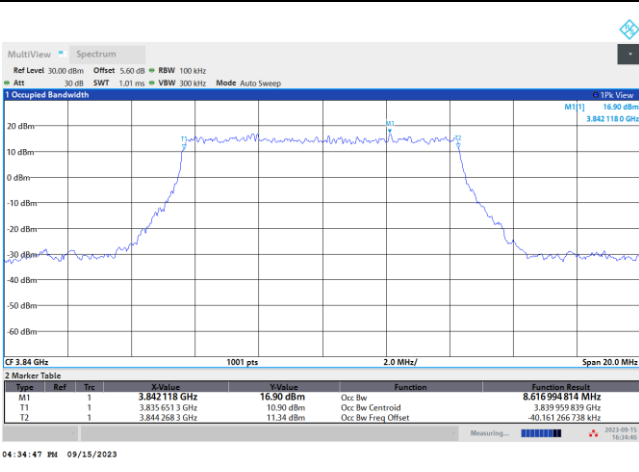

5G-FR1 SA n77 (PC2) / 10MHz / CP OFDM / Middle Channel / Full RB

QPSK

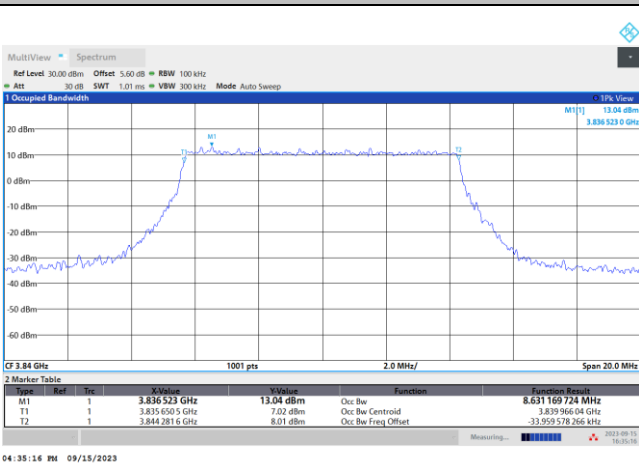

16QAM

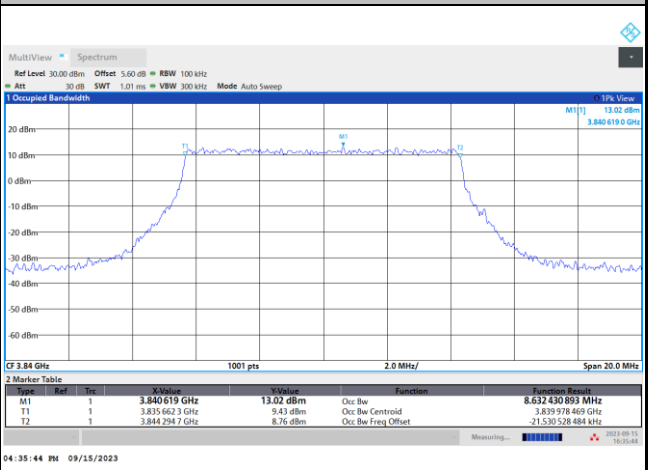

64QAM

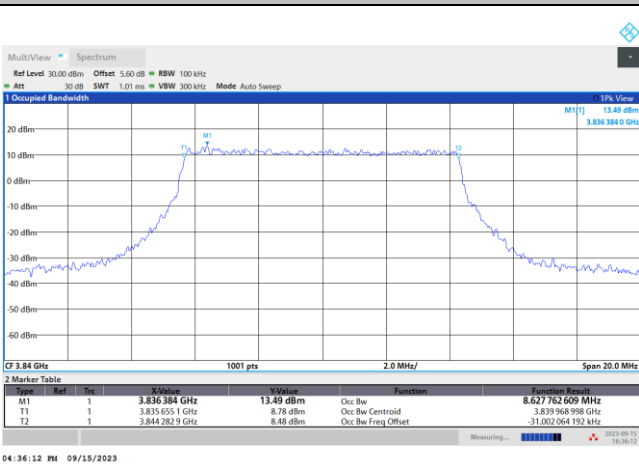

256QAM

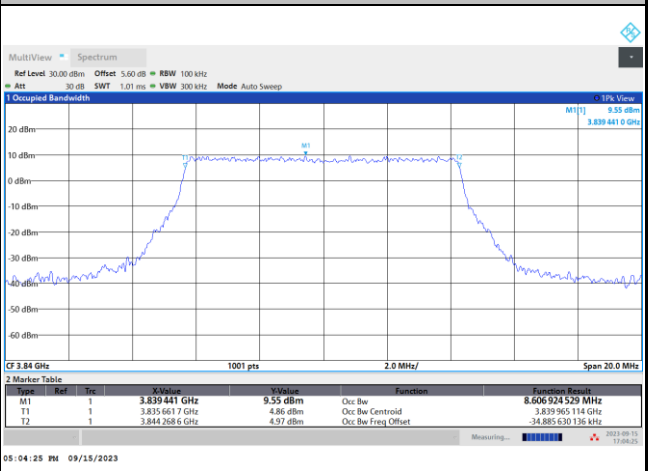



5G-FR1 SA n77 (PC2) / 15MHz / DFT-S OFDM / Middle Channel / Full RB

PI/2 BPSK

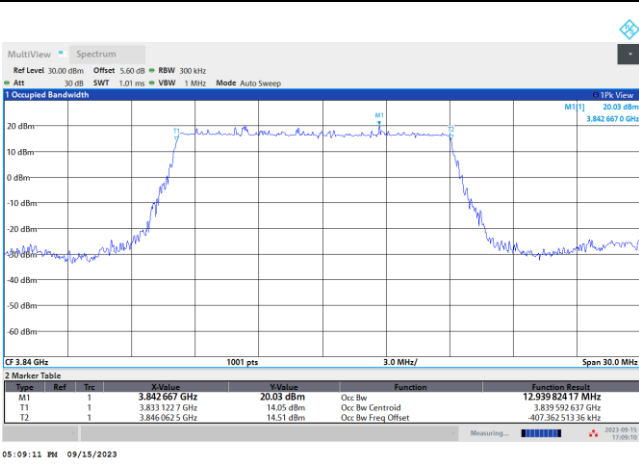

5G-FR1 SA n77 (PC2) / 15MHz / CP OFDM / Middle Channel / Full RB

QPSK

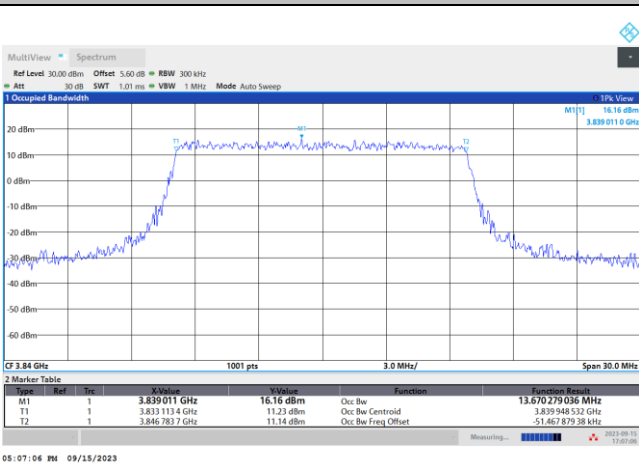

16QAM

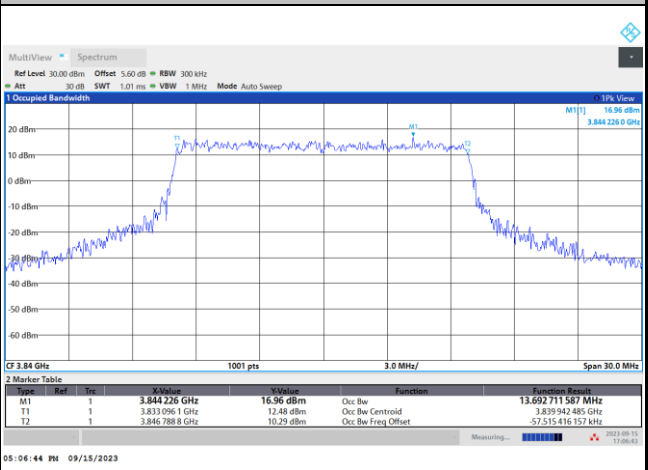

64QAM

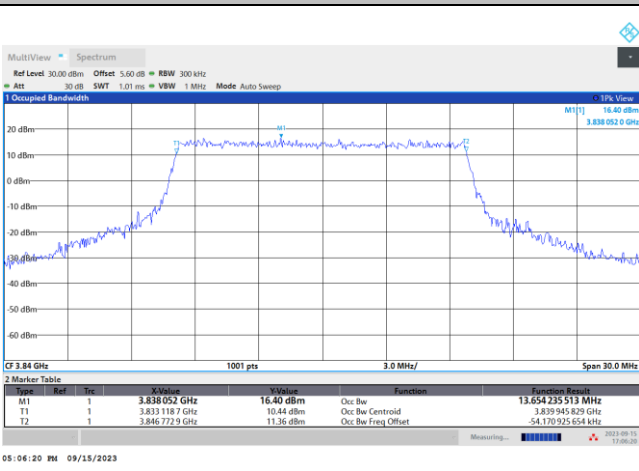

256QAM

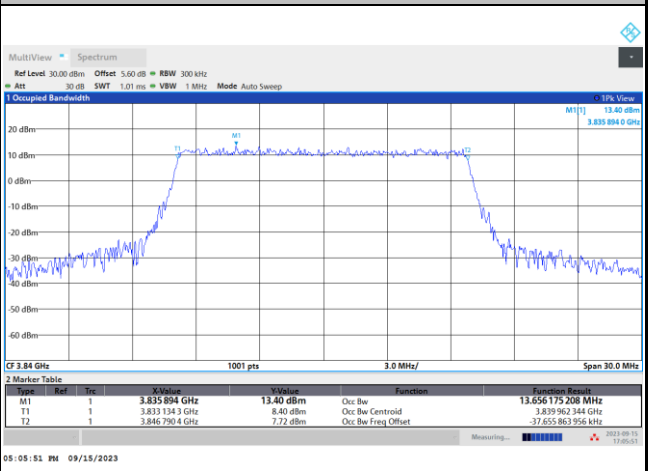



5G-FR1 SA n77 (PC2) / 20MHz / DFT-S OFDM / Middle Channel / Full RB

PI/2 BPSK

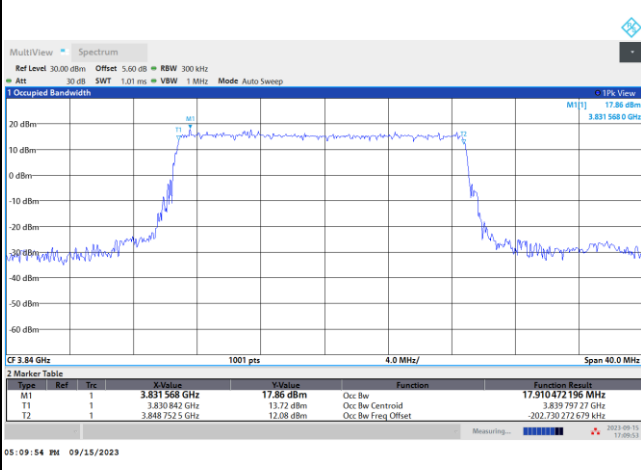

5G-FR1 SA n77 (PC2) / 20MHz / CP OFDM / Middle Channel / Full RB

QPSK

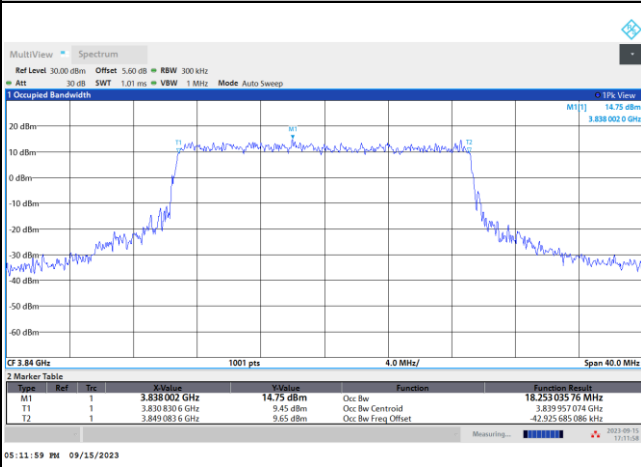

16QAM

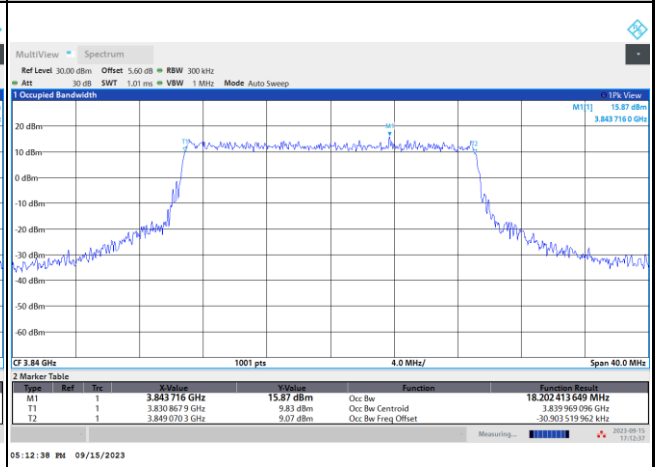

64QAM

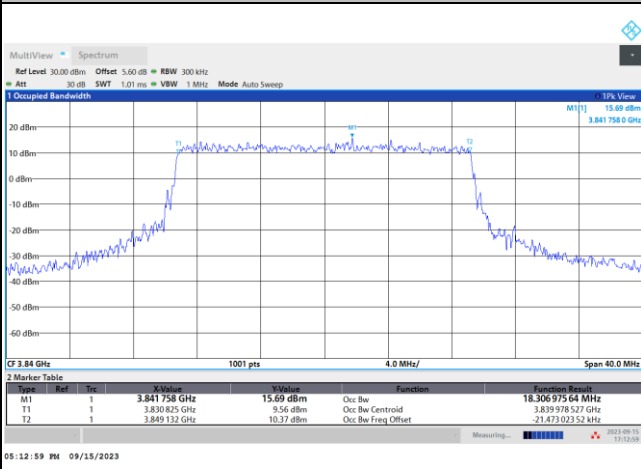

256QAM

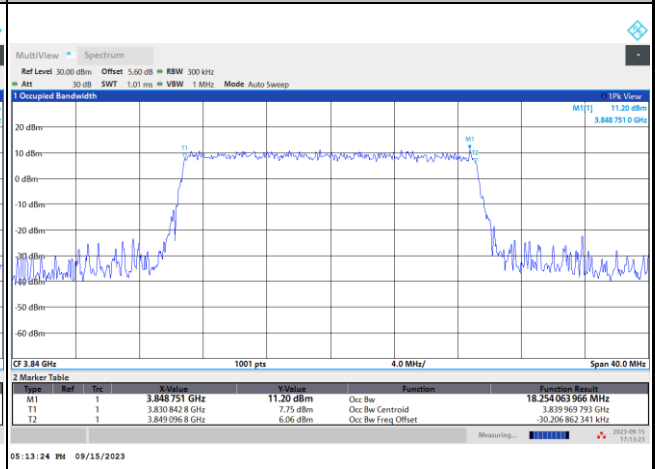



5G-FR1 SA n77 (PC2) / 25MHz / DFT-S OFDM / Middle Channel / Full RB

PI/2 BPSK

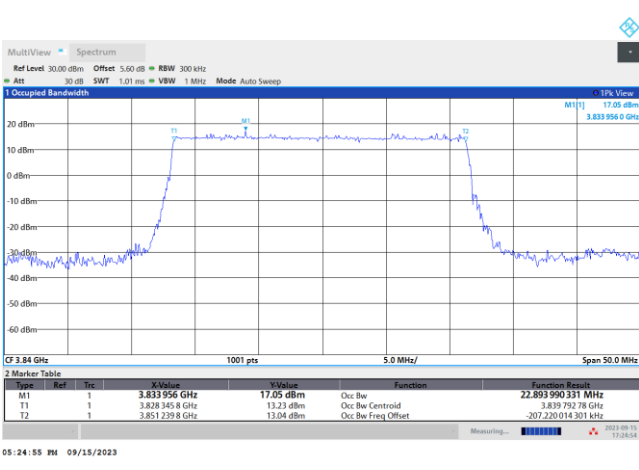

5G-FR1 SA n77 (PC2) / 25MHz / CP OFDM / Middle Channel / Full RB

QPSK

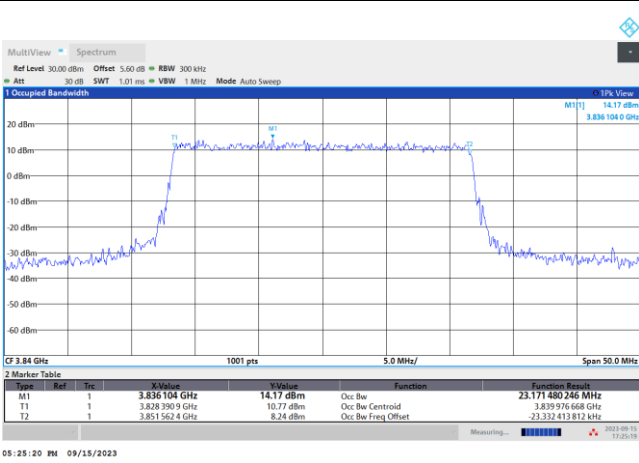

16QAM

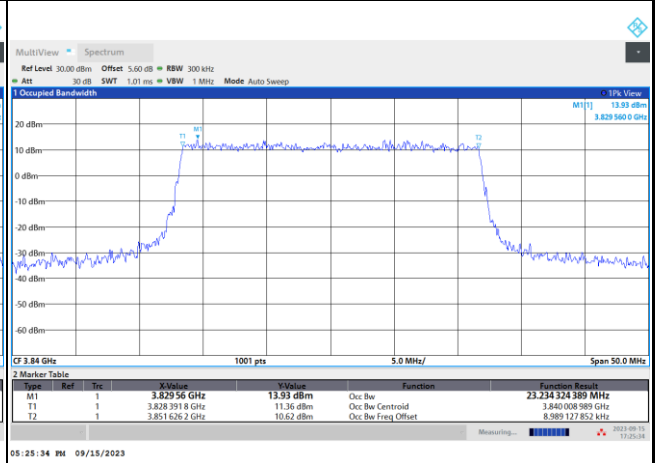

64QAM

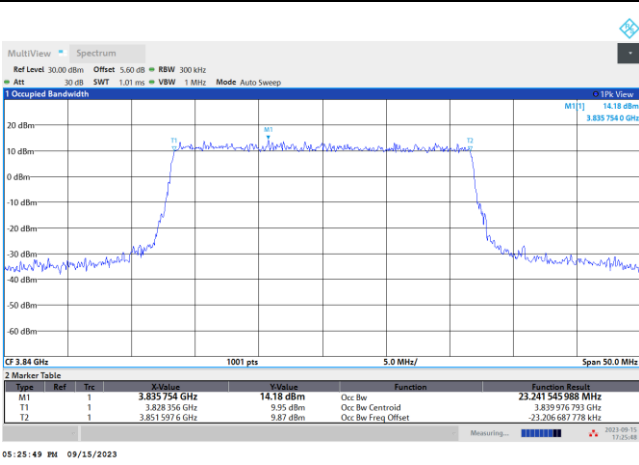

256QAM

