



FCC RADIO TEST REPORT

FCC ID : PKRISGMD2000
Equipment : Wireless Module
Brand Name : Inseego
Model Name : MD2000
Applicant : Inseego Corporation
9710 Scranton Road Suite 200, San Diego, CA 92121
Manufacturer : Inseego Corporation
9710 Scranton Road Suite 200, San Diego, CA 92121
Standard : FCC 47 CFR Part 2, 22(H), 24(E), 27

The product was received on Sep. 14, 2020 and testing was started from Sep. 24, 2020 and completed on Oct. 15, 2020. We, SPORTON INTERNATIONAL INC. EMC & Wireless Communications Laboratory, would like to declare that the tested sample has been evaluated in accordance with the test procedures given in ANSI / TIA-603-E and has been in compliance with the applicable technical standards.

The test results in this variant report apply exclusively to the tested model / sample. Without written approval of SPORTON INTERNATIONAL INC. EMC & Wireless Communications Laboratory, the test report shall not be reproduced except in full.

Louis Wu

Approved by: Louis Wu

SPORTON INTERNATIONAL INC. EMC & Wireless Communications Laboratory

No. 52, Huaya 1st Rd., Guishan Dist., Taoyuan City, Taiwan (R.O.C.)



Table of Contents

History of this test report..... 3

Summary of Test Result..... 4

1 General Description 6

 1.1 Product Feature of Equipment Under Test..... 6

 1.2 Modification of EUT 6

 1.3 Testing Location 6

 1.4 Applicable Standards..... 7

2 Test Configuration of Equipment Under Test 8

 2.1 Test Mode..... 8

 2.2 Connection Diagram of Test System..... 10

 2.3 Support Unit used in test configuration and system 11

 2.4 Measurement Results Explanation Example..... 11

 2.5 Frequency List of Low/Middle/High Channels 11

3 Conducted Test Items..... 17

 3.1 Measuring Instruments 17

 3.2 Conducted Output Power and ERP/EIRP 18

 3.3 Occupied Bandwidth..... 19

 3.4 Conducted Band Edge 20

 3.5 Conducted Spurious Emission 22

4 Radiated Test Items 23

 4.1 Measuring Instruments 23

 4.2 Radiated Spurious Emission Measurement 25

5 List of Measuring Equipment..... 26

6 Uncertainty of Evaluation..... 27

Appendix A. Test Results of Conducted Test

Appendix B. Test Results of ERP/EIRP and Radiated Test

Appendix C. Test Setup Photographs



Summary of Test Result

Report Clause	Ref Std. Clause	Test Items	Result (PASS/FAIL)	Remark
3.2	§2.1046	Conducted Output Power	Reporting only	-
	§22.913 (a)(2)	Effective Radiated Power (Band 5) (Band 26)	Pass	
	§27.50 (b)(10) §27.50 (c)(10)	Effective Radiated Power (Band 12) (Band 13) (Band 17) (Band 71)		
	§24.232 (c) §27.50 (h)(2)	Equivalent Isotropic Radiated Power (Band 2) (Band 25) (Band 7) (Band 38) (Band 41)		
	§27.50 (d)(4)	Equivalent Isotropic Radiated Power (Band 4) (Band 66)		
-	§24.232 (d) §27.50 (d)(5)	Peak-to-Average Ratio	Not Required	-
3.3	§2.1049	Occupied Bandwidth	Reporting only	-
3.4	§2.1051 §22.917 (a) §24.238 (a) §27.53 (c)(2)(4) §27.53 (g) §27.53 (h)	Conducted Band Edge Measurement (Band 2) (Band 4) (Band 5) (Band 12) (Band 13) (Band 17) (Band 25) (Band 26) (Band 66) (Band 71)	Pass	-
	§2.1051 §27.53 (m)(4)	Conducted Band Edge Measurement (Band 7) (Band 38) (Band 41)		
3.5	§2.1051 §22.917 (a) §24.238 (a) §27.53 (c)(2) §27.53 (g) §27.53 (h)	Conducted Spurious Emission (Band 2) (Band 4) (Band 5) (Band 12) (Band 13) (Band 17) (Band 25) (Band 26) (Band 66) (Band 71)	Pass	-
	§2.1051 §27.53 (m)(4)	Conducted Spurious Emission (Band 7) (Band 38) (Band 41)		
-	§2.1055 §22.355 §24.235 §27.54	Frequency Stability Temperature & Voltage	Not Required	-



Report Clause	Ref Std. Clause	Test Items	Result (PASS/FAIL)	Remark
4.2	§2.1053 §22.917 (a) §24.238 (a) §27.53 (c)(2) §27.53 (f) §27.53 (g) §27.53 (h)	Radiated Spurious Emission (Band 2) (Band 4) (Band 5) (Band 12) (Band 13) (Band 17) (Band 25) (Band 26) (Band 66) (Band 71)	Pass	Under limit 21.69 dB at 10368.000 MHz
	§2.1051 §27.53 (m)(4)	Radiated Spurious Emission (Band 7) (Band 38) (Band 41)		

Remark: This is a variant report by enable LTE CA Band. All the test cases were performed on original report which can be referred to Sporton Report Number FG090125B.

Declaration of Conformity:

The test results with all measurement uncertainty excluded are presented in accordance with the regulation limits or requirements declared by manufacturers.

Comments and Explanations:

The declared of product specification for EUT presented in the report are provided by the manufacturer, and the manufacturer takes all the responsibilities for the accuracy of product specification.

Reviewed by: Wii Chang

Report Producer: Lucy Wu



1 General Description

1.1 Product Feature of Equipment Under Test

WCDMA/LTE/5G NR, Wi-Fi 2.4GHz 802.11b/g/n/ac/ax, Wi-Fi 5GHz 802.11a/n/ac/ax, and GNSS.

Product Specification subjective to this standard	
Antenna Type	WWAN: Monopole Antenna WLAN <Ant. 0>: Monopole Antenna <Ant. 1>: Monopole Antenna GPS / Glonass / BDS / Galileo: Monopole Antenna

1.2 Modification of EUT

No modifications are made to the EUT during all test items.

1.3 Testing Location

Test Site	SPORTON INTERNATIONAL INC. EMC & Wireless Communications Laboratory
Test Site Location	No.52, Huaya 1st Rd., Guishan Dist., Taoyuan City, Taiwan (R.O.C.) TEL: +886-3-327-3456 FAX: +886-3-328-4978
Test Site No.	Sporton Site No. TH05-HY
Test Engineer	Benjamin Lin
Temperature	22.2~25.3°C
Relative Humidity	46.2~50.6%

Test Site	SPORTON INTERNATIONAL INC. EMC & Wireless Communications Laboratory
Test Site Location	No.58, Aly. 75, Ln. 564, Wenhua 3rd, Rd., Guishan Dist., Taoyuan City, Taiwan (R.O.C.) TEL: +886-3-327-0868 FAX: +886-3-327-0855
Test Site No.	Sporton Site No. 03CH12-HY
Test Engineer	Jack Cheng, Lance Chiang and Chuan Chu
Temperature	24.3~26.4°C
Relative Humidity	58~66%

Note: The test site complies with ANSI C63.4 2014 requirement.

FCC Designation No.: TW1190 and TW0007



1.4 Applicable Standards

According to the specifications of the manufacturer, the EUT must comply with the requirements of the following standards:

- ♦ ANSI C63.26-2015
- ♦ ANSI / TIA-603-E
- ♦ FCC 47 CFR Part 2, 22(H), 24(E), 27
- ♦ FCC KDB 971168 D01 Power Meas. License Digital Systems v03r01
- ♦ FCC KDB 412172 D01 Determining ERP and EIRP v01r01
- ♦ FCC KDB 414788 D01 Radiated Test Site v01r01.

Remark:

1. All test items were verified and recorded according to the standards and without any deviation during the test.
2. This EUT has also been tested and complied with the requirements of FCC Part 15, Subpart B, recorded in a separate test report.
3. The TAF code is not including all the FCC KDB listed without accreditation.



2 Test Configuration of Equipment Under Test

2.1 Test Mode

Antenna port conducted and radiated test items listed below are performed according to KDB 971168 D01 Power Meas. License Digital Systems v03r01 with maximum output power.

For radiated measurement, pre-scanned in two config (Ant. Horizontal and Ant. Vertical). The worst cases (Ant. Horizontal for LTE Band 5_CA, 41_CA, 66C_CA ; Ant. Vertical for LTE Band 66B_CA) were recorded in this report.

Test Items	Band	Bandwidth (MHz)					Modulation				RB #			Test Channel			
		3+5	5+3	5+10	10+5	10+10	QPSK	16QAM	64QAM	256QAM	1	Half	Full	L	M	H	
Max. Output Power	5_CA			v	v	v	v	v	v	v	v			v	v	v	v
26dB and 99% Bandwidth	5_CA			v	v	v	v	v	v	v				v	v	v	v
Conducted Band Edge	5_CA			v	v	v	v	v	v	v	v			v	v		v
Conducted Spurious Emission	5_CA			v	v	v	v	v	v	v	v			v	v	v	v
E.R.P.	5_CA			v	v	v	v	v	v	v	v			v	v	v	v
Radiated Spurious Emission	5_CA	Worst Case											v	v	v		
Remark	<ol style="list-style-type: none"> The mark "v " means that this configuration is chosen for testing The mark "- " means that this bandwidth is not supported. The device is investigated from 30MHz to 10 times of fundamental signal for radiated spurious emission test under different RB size/offset and modulations in exploratory test. Subsequently, only the worst case emissions are reported. 																



Test Items	Band	Bandwidth (MHz)										Modulation				RB #			Test Channel		
		20+20	20+15	15+20	20+10	10+20	20+5	5+20	15+15	15+10	10+15	QPSK	16QAM	64QAM	256QAM	1	Half	Full	L	M	H
Max. Output Power	38_CA	v	-	-	-	-	-	-	v	-	-	v	v	v	v	v	v	v	v	v	v
	41_CA	v	v	v	v	v	v	v	v	v	v	v	v	v	v	v	v	v	v	v	v
26dB and 99% Bandwidth	38_CA	Covered by Band 41C																			
	41_CA	v	v	v	v	v	v	v	v	v	v	v	v	v	v	v	v	v	v	v	v
Conducted Band Edge	38_CA	Covered by Band 41C																			
	41_CA	v	v	v	v	v	v	v	v	v	v	v	v	v	v	v	v	v	v	v	v
Conducted Spurious Emission	38_CA	Covered by Band 41C																			
	41_CA	v	v	v	v	v	v	v	v	v	v	v	v	v	v	v	v	v	v	v	v
E.I.R.P.	38_CA	v	-	-	-	-	-	-	v	-	-	v	v	v	v	v	v	v	v	v	v
	41_CA	v	v	v	v	v	v	v	v	v	v	v	v	v	v	v	v	v	v	v	v
Radiated Spurious Emission	38_CA	Covered by Band 41C																			
	41_CA	Worst Case																	v	v	v
Remark	<ol style="list-style-type: none"> The mark "v" means that this configuration is chosen for testing The mark "-" means that this bandwidth is not supported. The device is investigated from 30MHz to 10 times of fundamental signal for radiated spurious emission test under different RB size/offset and modulations in exploratory test. Subsequently, only the worst case emissions are reported. Wider operating range bandwidth covers narrower one when the power is higher or the same. 																				

Test Items	Band	Bandwidth (MHz)						Modulation				RB #			Test Channel					
		5+5	5+10	10+5	5+15	15+5	10+10	QPSK	16QAM	64QAM	256QAM	1	Half	Full	L	M	H			
Max. Output Power	66B_CA	v	v	v	v	v	v	v	v	v	v	v	v	v	v	v	v	v	v	v
26dB and 99% Bandwidth	66B_CA	v	v	v	v	v	v	v	v	v	v	v	v	v	v	v	v	v	v	v
Conducted Band Edge	66B_CA	v	v	v	v	v	v	v	v	v	v	v	v	v	v	v	v	v	v	v
Conducted Spurious Emission	66B_CA	v	v	v	v	v	v	v	v	v	v	v	v	v	v	v	v	v	v	v
E.I.R.P.	66B_CA	v	v	v	v	v	v	v	v	v	v	v	v	v	v	v	v	v	v	v
Radiated Spurious Emission	66B_CA	Worst Case														v	v	v		
Remark	<ol style="list-style-type: none"> The mark "v" means that this configuration is chosen for testing The mark "-" means that this bandwidth is not supported. The device is investigated from 30MHz to 10 times of fundamental signal for radiated spurious emission test under different RB size/offset and modulations in exploratory test. Subsequently, only the worst case emissions are reported. 																			



Test Items	Band	Bandwidth (MHz)										Modulation				RB #			Test Channel		
		15+15	10+15	15+10	5+20	20+5	10+20	20+10	15+20	20+15	20+20	QPSK	16QAM	64QAM	256QAM	1	Half	Full	L	M	H
Max. Output Power	66C_CA	v	v	v	v	v	v	v	v	v	v	v	v	v	v	v	v	v	v	v	v
26dB and 99% Bandwidth	66C_CA	v	v	v	v	v	v	v	v	v	v	v	v	v	v	v	v	v	v	v	v
Conducted Band Edge	66C_CA	v	v	v	v	v	v	v	v	v	v	v	v	v	v	v	v	v	v	v	v
Conducted Spurious Emission	66C_CA	v	v	v	v	v	v	v	v	v	v	v	v	v	v	v	v	v	v	v	v
E.R.P.	66C_CA	v	v	v	v	v	v	v	v	v	v	v	v	v	v	v	v	v	v	v	v
Radiated Spurious Emission	66C_CA	Worst Case																	v	v	v
Remark	1. The mark "v" means that this configuration is chosen for testing 2. The mark "-" means that this bandwidth is not supported. 3. The device is investigated from 30MHz to 10 times of fundamental signal for radiated spurious emission test under different RB size/offset and modulations in exploratory test. Subsequently, only the worst case emissions are reported.																				

2.2 Connection Diagram of Test System

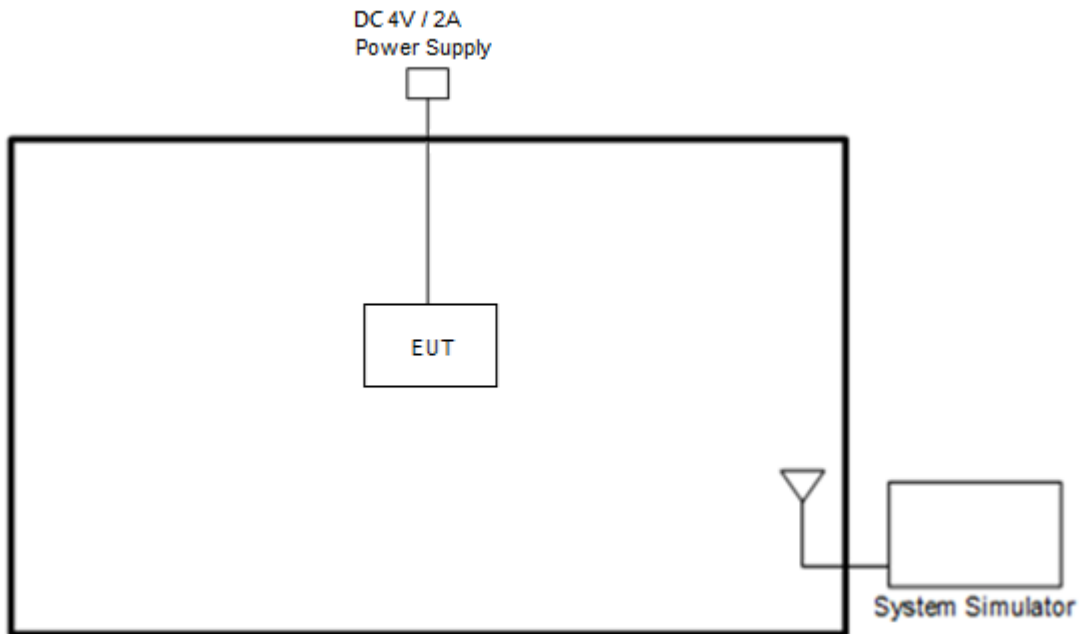



2.3 Support Unit used in test configuration and system

Item	Equipment	Brand Name	Model No.	FCC ID	Data Cable	Power Cord
1.	System Simulator	Anritsu	MT8821C	N/A	N/A	Unshielded, 1.8 m

2.4 Measurement Results Explanation Example

For all conducted test items:

The offset level is set in the spectrum analyzer to compensate the RF cable loss and attenuator factor between EUT conducted output port and spectrum analyzer. With the offset compensation, the spectrum analyzer reading level is exactly the EUT RF output level.

The spectrum analyzer offset is derived from RF cable loss and attenuator factor.

$$\text{Offset} = \text{RF cable loss} + \text{attenuator factor}.$$

Following shows an offset computation example with cable loss 4.2 dB and 10dB attenuator.

Example :

$$\begin{aligned} \text{Offset(dB)} &= \text{RF cable loss(dB)} + \text{attenuator factor(dB)} \\ &= 4.2 + 10 = 14.2 \text{ (dB)} \end{aligned}$$

2.5 Frequency List of Low/Middle/High Channels

LTE Band 5 Channel and Frequency List_CA					
BW [MHz]	Channel/Frequency(MHz)		Lowest	Middle	Highest
5 + 10	PCC	Channel	20428	20478	20528
		Frequency	826.8	831.8	836.8
	SCC	Channel	20500	20550	20600
		Frequency	834	839	844
10 + 5	PCC	Channel	20450	20500	20550
		Frequency	829	834	839
	SCC	Channel	20522	20572	20622
		Frequency	836.2	841.2	846.2
10 + 10	PCC	Channel	20450	20476	20501
		Frequency	829	831.6	834.1
	SCC	Channel	20549	20575	20600
		Frequency	838.9	841.5	844



LTE Band 38 Channel and Frequency List					
BW [MHz]	Channel/Frequency(MHz)		Lowest	Middle	Highest
20 + 20	PCC	Channel	37850	37901	37952
		Frequency	2580.0	2585.1	2590.2
	SCC	Channel	38048	38099	38150
		Frequency	2599.8	2604.9	2610.0
15+ 15	PCC	Channel	37825	37925	38025
		Frequency	2577.5	2587.5	2597.5
	SCC	Channel	37975	38075	38175
		Frequency	2592.5	2602.5	2612.5

LTE Band 41 Channel and Frequency List					
BW [MHz]	Channel/Frequency(MHz)		Lowest	Middle	Highest
20 + 20	PCC	Channel	39750	40521	41292
		Frequency	2506.0	2583.1	2660.2
	SCC	Channel	39948	40719	41490
		Frequency	2525.8	2602.9	2680.0
20 + 15	PCC	Channel	39750	40546	41341
		Frequency	2506.0	2585.6	2665.1
	SCC	Channel	39921	40717	41512
		Frequency	2523.1	2602.7	2682.2
15 + 20	PCC	Channel	39728	40523	41319
		Frequency	2503.8	2593.3	2662.9
	SCC	Channel	39899	40694	41490
		Frequency	2520.9	2600.4	2680.0
20 + 10	PCC	Channel	39750	40571	41391
		Frequency	2506.0	2588.1	2670.1
	SCC	Channel	39894	40715	41535
		Frequency	2520.4	2602.5	2684.5
10 + 20	PCC	Channel	39705	40526	41346
		Frequency	2501.5	2583.6	2665.6
	SCC	Channel	39849	40670	41490
		Frequency	2515.9	2598.0	2680.0



LTE Band 41 Channel and Frequency List					
20 + 5	PCC	Channel	39750	40595	41440
		Frequency	2506.0	2590.5	2675.0
	SCC	Channel	39867	40712	41557
		Frequency	2517.7	2602.2	2686.7
5 + 20	PCC	Channel	39683	40528	41373
		Frequency	2499.3	2583.8	2668.3
	SCC	Channel	39800	40645	41490
		Frequency	2511.0	2595.5	2680.0
15 + 15	PCC	Channel	39725	40545	41365
		Frequency	2503.5	2585.5	2667.5
	SCC	Channel	39875	40695	41515
		Frequency	2518.5	2600.5	2682.5
10 + 15	PCC	Channel	39703	40549	41395
		Frequency	2501.3	2585.9	2670.5
	SCC	Channel	39823	40669	41515
		Frequency	2513.3	2597.9	2682.5
15 + 10	PCC	Channel	39725	40571	41417
		Frequency	2503.5	2588.1	2672.7
	SCC	Channel	39845	40691	41537
		Frequency	2515.5	2600.1	2684.7



LTE Band 66B Channel and Frequency List_CA					
BW [MHz]	Channel/Frequency(MHz)		Lowest	Middle	Highest
5 + 5	PCC	Channel	131997	132398	132599
		Frequency	1712.5	1752.6	1772.7
	SCC	Channel	132045	133346	132647
		Frequency	1717.3	1757.4	1777.5
5 + 10	PCC	Channel	132000	132375	132550
		Frequency	1712.8	1750.3	1767.8
	SCC	Channel	132072	133347	132622
		Frequency	1720	1757.5	1775
10 + 5	PCC	Channel	132022	132397	132572
		Frequency	1715	1752.5	1770
	SCC	Channel	132094	133369	132644
		Frequency	1722.2	1759.7	1777.2
5 + 15	PCC	Channel	132002	132353	132504
		Frequency	1713	1748.1	1763.2
	SCC	Channel	132095	133346	132597
		Frequency	1722.3	1757.4	1772.5
15 + 5	PCC	Channel	132047	132398	132549
		Frequency	1717.5	1752.6	1767.7
	SCC	Channel	132140	133391	132642
		Frequency	1726.8	1761.9	1777
10 + 10	PCC	Channel	132022	132373	135523
		Frequency	1715	1750.1	1765.1
	SCC	Channel	132121	133372	132622
		Frequency	1724.9	1760	1775



LTE Band 66C Channel and Frequency List_CA					
BW [MHz]	Channel/Frequency(MHz)		Lowest	Middle	Highest
10 + 15	PCC	Channel	132025	132351	132477
		Frequency	1715.3	1747.9	1760.5
	SCC	Channel	132145	133371	132597
		Frequency	1727.3	1759.9	1772.5
15 + 10	PCC	Channel	132047	132373	132499
		Frequency	1717.5	1750.1	1762.7
	SCC	Channel	132167	133393	132619
		Frequency	1729.5	1761.1	1774.7
10 + 20	PCC	Channel	132027	132328	132428
		Frequency	1715.5	1745.6	1755.6
	SCC	Channel	131171	133372	132572
		Frequency	1729.9	1760	1770
20 + 10	PCC	Channel	132072	132373	132473
		Frequency	1720	1750.1	1760.1
	SCC	Channel	132216	133417	132617
		Frequency	1734.4	1764.5	1774.5
15 + 15	PCC	Channel	132047	132347	132447
		Frequency	1717.5	1747.5	1757.5
	SCC	Channel	132197	133397	132597
		Frequency	1732.5	1762.5	1772.5
15 + 20	PCC	Channel	132050	132325	132401
		Frequency	1717.8	1745.3	1752.9
	SCC	Channel	132221	133396	132572
		Frequency	1734.9	1762.4	1770
20 + 15	PCC	Channel	132072	132348	132423
		Frequency	1720	1747.6	1755.1
	SCC	Channel	132243	133419	132594
		Frequency	1737.1	1764.7	1772.2
20 + 5	PCC	Channel	132072	132397	132522
		Frequency	1720	1752.5	1765
	SCC	Channel	132189	133414	132639
		Frequency	1731.7	1764.2	1776.7



LTE Band 66C Channel and Frequency List_CA					
5 + 20	PCC	Channel	132005	132330	132455
		Frequency	1713.3	1745.8	1758.3
	SCC	Channel	132122	132447	132572
		Frequency	1725	1757.5	1770.0
20 + 20	PCC	Channel	132072	132323	132374
		Frequency	1720	1745.1	1750.2
	SCC	Channel	132270	133421	132572
		Frequency	1739.8	1764.9	1770

3 Conducted Test Items

3.1 Measuring Instruments

See list of measuring instruments of this test report.

3.1.1 Test Setup

3.1.2 Conducted Output Power

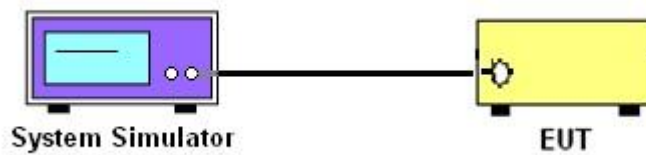

3.1.3 Occupied Bandwidth ,Conducted Band-Edge and Conducted Spurious Emission

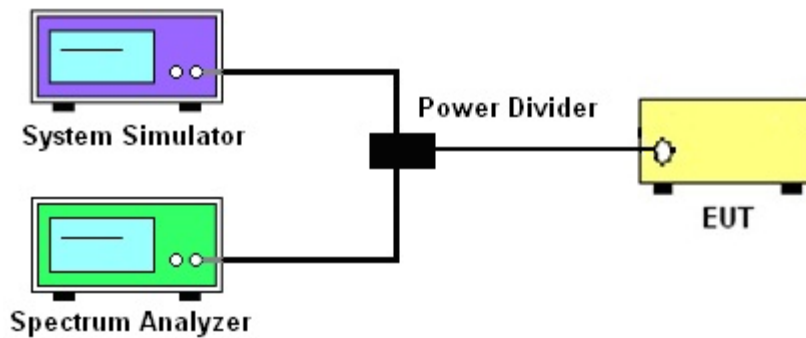

3.1.4 Test Result of Conducted Test

Please refer to Appendix A.



3.2 Conducted Output Power and ERP/EIRP

3.2.1 Description of the Conducted Output Power Measurement and ERP/EIRP Measurement

A system simulator was used to establish communication with the EUT. Its parameters were set to force the EUT transmitting at maximum output power. The measured power in the radio frequency on the transmitter output terminals shall be reported.

The ERP of mobile transmitters must not exceed 7 Watts for LTE Band 5

The EIRP of mobile transmitters must not exceed 2 Watts for LTE Band 38 and Band 41

The EIRP of mobile transmitters must not exceed 1 Watts for LTE Band 66

According to KDB 412172 D01 Power Approach,

$EIRP = P_T + G_T - L_C$, $ERP = EIRP - 2.15$, where

P_T = transmitter output power in dBm

G_T = gain of the transmitting antenna in dBi

L_C = signal attenuation in the connecting cable between the transmitter and antenna in dB

3.2.2 Test Procedures

1. The transmitter output port was connected to the system simulator.
2. Set EUT at maximum power through the system simulator.
3. Select lowest, middle, and highest channels for each band and different modulation.
4. Measure and record the power level from the system simulator.



3.3 Occupied Bandwidth

3.3.1 Description of Occupied Bandwidth Measurement

The occupied bandwidth is the width of a frequency band such that, below the lower and above the upper frequency limits, the mean powers emitted are each equal to a specified percentage 0.5% of the total mean transmitted power.

The 26 dB emission bandwidth is defined as the frequency range between two points, one above and one below the carrier frequency, at which the spectral density of the emission is attenuated 26 dB below the maximum in-band spectral density of the modulated signal. Spectral density (power per unit bandwidth) is to be measured with a detector of resolution bandwidth equal to approximately 1.0% of the emission bandwidth.

3.3.2 Test Procedures

The testing follows ANSI C63.26-2015 Section 5.4.3 (26dB) and Section 5.4.4 (99OB)

1. The EUT was connected to spectrum analyzer and system simulator via a power divider.
2. The spectrum analyzer center frequency is set to the nominal EUT channel center frequency. The span range for the spectrum analyzer shall be between two and five times the anticipated OBW.
3. The nominal resolution bandwidth (RBW) shall be in the range of 1 to 5 % of the anticipated OBW, and the VBW shall be at least 3 times the RBW.
4. Set the detection mode to peak, and the trace mode to max hold.
5. Determine the reference value: Set the EUT to transmit a modulated signal. Allow the trace to stabilize. Set the spectrum analyzer marker to the highest level of the displayed trace.
(this is the reference value)
6. Determine the “-26 dB down amplitude” as equal to (Reference Value – X).
7. Place two markers, one at the lowest and the other at the highest frequency of the envelope of the spectral display such that each marker is at or slightly below the “-X dB down amplitude” determined in step 6. If a marker is below this “-X dB down amplitude” value it shall be placed as close as possible to this value. The OBW is the positive frequency difference between the two markers.
8. Use the 99 % power bandwidth function of the spectrum analyzer and report the measured bandwidth.



3.4 Conducted Band Edge

3.4.1 Description of Conducted Band Edge Measurement

22.917(a)

For operations in the 824 – 849 MHz band, the FCC limit is $43 + 10\log_{10}(P[\text{Watts}])$ dB below the transmitter power $P(\text{Watts})$ in a 100kHz bandwidth. However, in the 1MHz bands immediately outside and adjacent to the licensee's frequency block, a resolution bandwidth of at least one percent of the emission bandwidth of the fundamental emission of the transmitter may be employed.

27.53 (h)

For operations in the 1710 – 1755 MHz band, 1755-1780 MHz, the FCC limit is $43 + 10\log_{10}(P[\text{Watts}])$ dB below the transmitter power $P(\text{Watts})$ in a 1 MHz bandwidth. However, in the 1MHz bands immediately outside and adjacent to the licensee's frequency block, a resolution bandwidth of at least one percent of the emission bandwidth of the fundamental emission of the transmitter may be employed.

27.53(m)(4)

For mobile digital stations, the attenuation factor shall be not less than $40 + 10 \log (P)$ dB on all frequencies between the channel edge and 5 megahertz from the channel edge, $43 + 10 \log (P)$ dB on all frequencies between 5 megahertz and X megahertz from the channel edge, and $55 + 10 \log (P)$ dB on all frequencies more than X megahertz from the channel edge, where X is the greater of 6 megahertz or the actual emission bandwidth as defined in paragraph (m)(6) of this section. In addition, the attenuation factor shall not be less that $43 + 10 \log (P)$ dB on all frequencies between 2490.5 MHz and 2496 MHz and $55 + 10 \log (P)$ dB at or below 2490.5 MHz. Mobile Satellite Service licensees operating on frequencies below 2495 MHz may also submit a documented interference complaint against BRS licensees operating on channel BRS Channel 1 on the same terms and conditions as adjacent channel BRS or EBS licensees.



3.4.2 Test Procedures

The testing follows FCC KDB 971168 D01 v03r01 Section 6.1.

1. The EUT was connected to spectrum analyzer and system simulator via a power divider.
2. The band edges of low and high channels for the highest RF powers were measured.
3. Set RBW \geq 1% EBW in the 1MHz band immediately outside and adjacent to the band edge.
4. Beyond the 1 MHz band from the band edge, RBW=1MHz was used.
5. Set spectrum analyzer with RMS detector.
6. The RF fundamental frequency should be excluded against the limit line in the operating frequency band.
7. Checked that all the results comply with the emission limit line.

The limit line is derived from $43 + 10\log(P)$ dB below the transmitter power P(Watts)

For LTE Band 38, 41

The other 40 dB, and 55 dB have additionally applied same calculation above.



3.5 Conducted Spurious Emission

3.5.1 Description of Conducted Spurious Emission Measurement

The power of any emission outside of the authorized operating frequency ranges must be lower than the transmitter power (P) by a factor of at least $43 + 10 \log (P)$ dB.

For LTE Band 38, 41

The power of any emission outside of the authorized operating frequency ranges must be lower than the transmitter power (P) by a factor of at least $55 + 10 \log (P)$ dB.

It is measured by means of a calibrated spectrum analyzer and scanned from 30 MHz up to a frequency including its 10th harmonic.

3.5.2 Test Procedures

The testing follows FCC KDB 971168 D01 v03r01 Section 6.1.

1. The EUT was connected to spectrum analyzer and system simulator via a power divider.
2. The RF output of EUT was connected to the spectrum analyzer by RF cable and attenuator.
The path loss was compensated to the results for each measurement.
3. The middle channel for the highest RF power within the transmitting frequency was measured.
4. The conducted spurious emission for the whole frequency range was taken.
5. Make the measurement with the spectrum analyzer's RBW = 1MHz, VBW = 3MHz.
6. Set spectrum analyzer with RMS detector.
7. Taking the record of maximum spurious emission.
8. The RF fundamental frequency should be excluded against the limit line in the operating frequency band.
9. The limit line is derived from $43 + 10\log(P)$ dB below the transmitter power P(Watts)
For LTE Band 38, 41
The limit line is derived from $55 + 10\log(P)$ dB below the transmitter power P(Watts)

4 Radiated Test Items

4.1 Measuring Instruments

See list of measuring instruments of this test report.

4.1.1 Test Setup

For radiated test below 30MHz

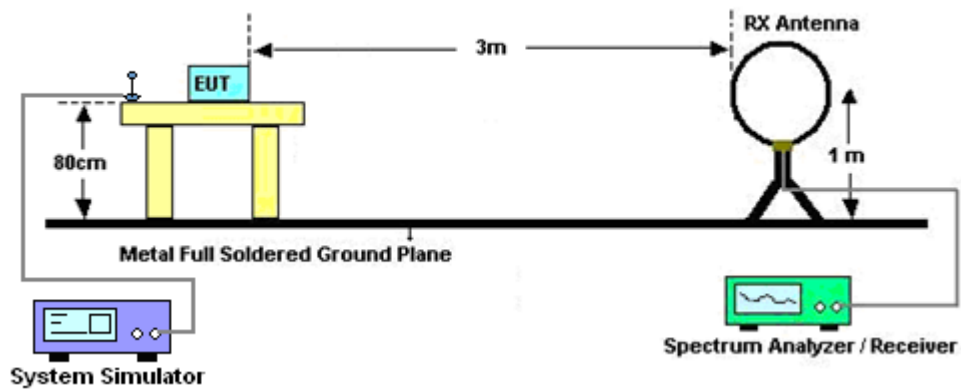

For radiated test from 30MHz to 1GHz

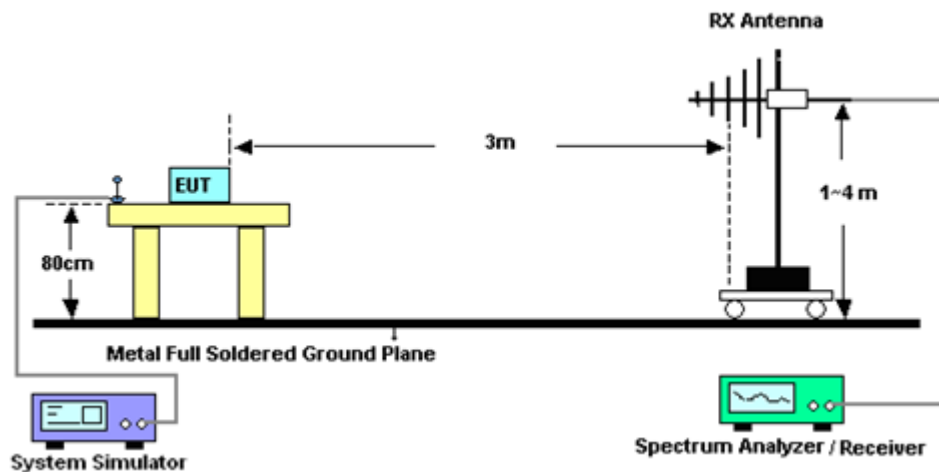

For radiated test from 1GHz to 18GHz

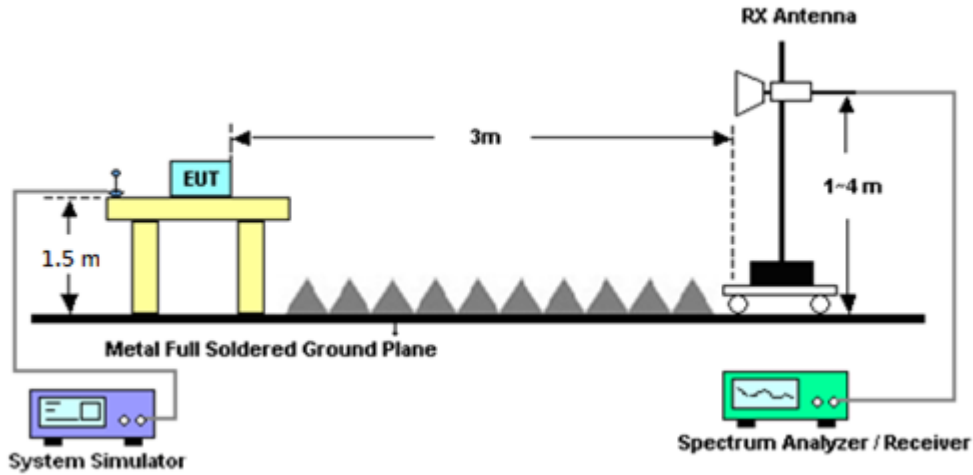

For radiated test above 18GHz

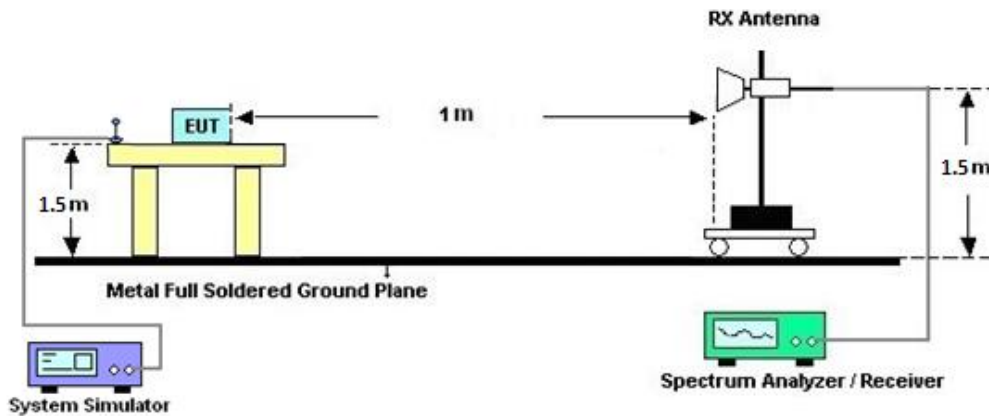

4.1.2 Test Result of Radiated Test

Please refer to Appendix B.

Note:

The low frequency, which started from 9 kHz to 30MHz, was pre-scanned and the result which was 20dB lower than the limit line was not reported.

There is a comparison data of both open-field test site and alternative test site - semi-Anechoic chamber according to 414788 D01 Radiated Test Site v01r01, and the result came out very similar.



4.2 Radiated Spurious Emission Measurement

4.2.1 Description of Radiated Spurious Emission Measurement

The radiated spurious emission was measured by substitution method according to ANSI / TIA-603-E. The power of any emission outside of the authorized operating frequency ranges must be attenuated below the transmitter power (P) by a factor of at least $43 + 10 \log (P)$ dB.

For LTE Band 38, 41

The power of any emission outside of the authorized operating frequency ranges must be attenuated below the transmitter power (P) by a factor of at least $55 + 10 \log (P)$ dB.

The spectrum is scanned from 30 MHz up to a frequency including its 10th harmonic.

4.2.2 Test Procedures

The testing follows FCC KDB 971168 D01 v03r01 Section 7 and ANSI / TIA-603-E Section 2.2.12.

1. The EUT was placed on a turntable with 0.8 meter for frequency below 1GHz and 1.5 meter for frequency above 1GHz respectively above ground.
2. The EUT was set 3 meters from the receiving antenna, which was mounted on the antenna tower.
3. The table was rotated 360 degrees to determine the position of the highest spurious emission.
4. The height of the receiving antenna is varied between one meter and four meters to search the maximum spurious emission for both horizontal and vertical polarizations.
5. Make the measurement with the spectrum analyzer's RBW = 1MHz, VBW = 3MHz, taking the record of maximum spurious emission.
6. A horn antenna was substituted in place of the EUT and was driven by a signal generator.
7. Tune the output power of signal generator to the same emission level with EUT maximum spurious emission.
8. Taking the record of output power at antenna port.
9. Repeat step 7 to step 8 for another polarization.
10. The RF fundamental frequency should be excluded against the limit line in the operating frequency band.

The limit line is derived from $43 + 10\log(P)$ dB below the transmitter power P(Watts)

For LTE Band 38, 41

The limit line is derived from $55 + 10\log(P)$ dB below the transmitter power P(Watts)

EIRP (dBm) = S.G. Power – Tx Cable Loss + Tx Antenna Gain

ERP (dBm) = EIRP - 2.15



5 List of Measuring Equipment

Instrument	Brand Name	Model No.	Serial No.	Characteristics	Calibration Date	Test Date	Due Date	Remark
Base Station (Measure)	Anritsu	MT8821C	6262025280	LTE FDD/TDD with 44) /LTE-3CC DLCA,2CC ULCA	Oct. 25, 2019	Oct. 04, 2020~ Oct. 09, 2020	Oct. 24, 2020	Conducted (TH05-HY)
Spectrum Analyzer	Rohde & Schwarz	FSV40	101908	10Hz~40GHz	May 13, 2020	Oct. 04, 2020~ Oct. 09, 2020	May 12, 2021	Conducted (TH05-HY)
Coupler	Warison	20dB 25W SMA Directional Coupler	#A	1-18GHz	Jan. 13, 2020	Oct. 04, 2020~ Oct. 09, 2020	Jan. 12, 2021	Conducted (TH05-HY)
Loop Antenna	Rohde & Schwarz	HFH2-Z2	100315	9 kHz~30 MHz	Dec. 26, 2019	Sep. 24, 2020~ Oct. 15, 2020	Dec. 25, 2020	Radiation (03CH12-HY)
Bilog Antenna	TESEQ	CBL 6111D & 00800N1D01 N-06	40103 & 07	30MHz~1GHz	Apr. 29, 2020	Sep. 24, 2020~ Oct. 15, 2020	Apr. 28, 2021	Radiation (03CH12-HY)
Horn Antenna	SCHWARZBECK	BBHA 9120 D	9120D-1328	1GHz~18GHz	Nov. 14, 2019	Sep. 24, 2020~ Oct. 15, 2020	Nov. 13, 2020	Radiation (03CH12-HY)
Horn Antenna	SCHWARZBECK	BBHA 9120D	9120D-1241	1GHz ~ 18GHz	Jul. 15, 2020	Sep. 24, 2020~ Oct. 15, 2020	Jul. 14, 2021	Radiation (03CH12-HY)
SHF-EHF Horn Antenna	SCHWARZBECK	BBHA 9170	BBHA9170584	18GHz~40GHz	Dec. 10, 2019	Sep. 24, 2020~ Oct. 15, 2020	Dec. 09, 2020	Radiation (03CH12-HY)
SHF-EHF Horn Antenna	SCHWARZBECK	BBHA 9170	BBHA9170980	18GHz ~ 40GHz	Jan. 10, 2019	Sep. 24, 2020~ Oct. 15, 2020	Jan. 09, 2021	Radiation (03CH12-HY)
Preamplifier	COM-POWER	PA-103	161075	10MHz~1GHz	Mar. 25, 2020	Sep. 24, 2020~ Oct. 15, 2020	Mar. 24, 2021	Radiation (03CH12-HY)
Preamplifier	Keysight	83017A	MY57280120	1GHz~26.5GHz	Jul. 20, 2020	Sep. 24, 2020~ Oct. 15, 2020	Jul. 19, 2021	Radiation (03CH12-HY)
Preamplifier	Jet-Power	JPA0118-55-303K	1710001800054002	1GHz~18GHz	Feb. 07, 2020	Sep. 24, 2020~ Oct. 15, 2020	Feb. 06, 2021	Radiation (03CH12-HY)
Preamplifier	EMEC	EM18G40G	060715	18GHz~40GHz	Dec. 13, 2019	Sep. 24, 2020~ Oct. 15, 2020	Dec. 12, 2020	Radiation (03CH12-HY)
Spectrum Analyzer	Agilent	N9010A	MY54200485	10Hz~44GHz	Feb. 10, 2020	Sep. 24, 2020~ Oct. 15, 2020	Feb. 09, 2021	Radiation (03CH12-HY)
Signal Generator	Anritsu	MG3694C	163401	0.1Hz~40GHz	Feb. 15, 2020	Sep. 24, 2020~ Oct. 15, 2020	Feb. 14, 2021	Radiation (03CH12-HY)
RF Cable	HUBER + SUHNER	SUCOFLEX 104	MY9837/4PE	9kHz~30MHz	Mar. 12, 2020	Sep. 24, 2020~ Oct. 15, 2020	Mar. 11, 2021	Radiation (03CH12-HY)
RF Cable	HUBER + SUHNER	SUCOFLEX 126E	0058/126E	30MHz~18GHz	Dec. 12, 2019	Sep. 24, 2020~ Oct. 15, 2020	Dec. 11, 2020	Radiation (03CH12-HY)
RF Cable	HUBER + SUHNER	SUCOFLEX 102	505134/2	30MHz~40GHz	Feb. 25, 2020	Sep. 24, 2020~ Oct. 15, 2020	Feb. 24, 2021	Radiation (03CH12-HY)
RF Cable	HUBER + SUHNER	SUCOFLEX 102	800740/2	30MHz~40GHz	Feb. 25, 2020	Sep. 24, 2020~ Oct. 15, 2020	Feb. 24, 2021	Radiation (03CH12-HY)
Hygrometer	TECEPEL	DTM-303B	TP140349	N/A	Oct. 25, 2019	Sep. 24, 2020~ Oct. 15, 2020	Oct. 24, 2020	Radiation (03CH12-HY)
Controller	EMEC	EM1000	N/A	Control Turn table & Ant Mast	N/A	Sep. 24, 2020~ Oct. 15, 2020	N/A	Radiation (03CH12-HY)
Antenna Mast	EMEC	AM-BS-4500-B	N/A	1m~4m	N/A	Sep. 24, 2020~ Oct. 15, 2020	N/A	Radiation (03CH12-HY)
Turn Table	EMEC	TT2000	N/A	0~360 Degree	N/A	Sep. 24, 2020~ Oct. 15, 2020	N/A	Radiation (03CH12-HY)
Software	Audix	E3 6.2009-8-24	RK-000989	N/A	N/A	Sep. 24, 2020~ Oct. 15, 2020	N/A	Radiation (03CH12-HY)



6 Uncertainty of Evaluation

Uncertainty of Radiated Emission Measurement (30 MHz ~ 1000 MHz)

Measuring Uncertainty for a Level of Confidence of 95% ($U = 2Uc(y)$)	3.07
---	------

Uncertainty of Radiated Emission Measurement (1 GHz ~ 18 GHz)

Measuring Uncertainty for a Level of Confidence of 95% ($U = 2Uc(y)$)	3.21
---	------

Uncertainty of Radiated Emission Measurement (18 GHz ~ 40 GHz)

Measuring Uncertainty for a Level of Confidence of 95% ($U = 2Uc(y)$)	3.80
---	------



Appendix A. Test Results of Conducted Test

Conducted Output Power(Average power)

LTE Band 5B_CA Maximum Average Power [dBm]								
BW [MHz]	PCC		SCC		Mod	Lowest	Middle	Highest
	RB Size	RB Offset	RB Size	RB Offset				
10+10	50	0	50	0	QPSK	21.37	21.38	21.28
10+10	1	0	1	49		11.35	11.31	11.47
10+10	1	49	1	0		23.16	23.12	22.34
10+10	50	0	50	0	16-QAM	20.42	20.36	20.32
10+10	1	0	1	49		11.79	11.72	11.97
10+10	1	49	1	0		22.68	22.54	21.84
10+10	50	0	50	0	64-QAM	20.38	20.29	18.88
10+10	1	0	1	49		11.80	11.71	11.93
10+10	1	49	1	0		21.47	21.43	21.54
10+10	50	0	50	0	256-QAM	18.43	18.37	18.28
10+10	1	0	1	49		10.70	10.46	10.72
10+10	1	49	1	0		18.46	18.38	18.51
10+5	50	0	25	0	QPSK	22.14	22.08	22.04
10+5	1	0	1	24		11.94	12.14	12.38
10+5	1	49	1	0		23.75	23.77	23.65
10+5	50	0	25	0	16-QAM	21.14	21.02	21.02
10+5	1	0	1	24		12.55	12.51	12.81
10+5	1	49	1	0		23.52	23.28	23.23
10+5	50	0	25	0	64-QAM	21.12	21.04	20.88
10+5	1	0	1	24		12.51	12.47	12.60
10+5	1	49	1	0		21.34	21.38	20.29
10+5	50	0	25	0	256-QAM	19.08	19.05	19.06
10+5	1	0	1	24		11.40	11.30	11.48
10+5	1	49	1	0		19.21	19.07	19.21
5+10	25	0	50	0	QPSK	22.08	22.03	21.99
5+10	1	0	1	49		11.92	12.07	12.35
5+10	1	24	1	0		23.68	23.62	23.60
5+10	25	0	50	0	16-QAM	21.13	21.03	21.03
5+10	1	0	1	49		12.39	12.58	12.83
5+10	1	24	1	0		23.44	23.40	23.51
5+10	25	0	50	0	64-QAM	21.04	21.05	21.01
5+10	1	0	1	49		12.42	12.41	12.63
5+10	1	24	1	0		21.17	21.58	21.52
5+10	25	0	50	0	256-QAM	19.10	19.05	19.01
5+10	1	0	1	49		11.39	11.21	11.44
5+10	1	24	1	0		19.32	19.12	19.16



LTE Band 66B_CA Maximum Average Power [dBm]								
BW [MHz]	PCC		SCC		Mod	Lowest	Middle	Highest
	RB Size	RB Offset	RB Size	RB Offset				
10+10	50	0	50	0	QPSK	21.49	21.86	21.51
10+10	1	0	1	49		13.01	12.93	13.07
10+10	1	49	1	0		23.32	23.33	23.76
10+10	50	0	50	0	16-QAM	20.48	20.87	20.47
10+10	1	0	1	49		13.43	13.38	13.52
10+10	1	49	1	0		22.79	22.86	22.85
10+10	50	0	50	0	64-QAM	20.51	20.87	20.51
10+10	1	0	1	49		13.21	13.52	13.32
10+10	1	49	1	0		21.67	21.80	20.20
10+10	50	0	50	0	256-QAM	18.42	18.84	18.54
10+10	1	0	1	49		13.21	13.47	13.34
10+10	1	49	1	0		18.56	18.80	18.83
15+5	75	0	25	0	QPSK	21.32	20.86	21.73
15+5	1	0	1	24		13.07	12.55	13.43
15+5	1	74	1	0		23.68	22.90	23.71
15+5	75	0	25	0	16-QAM	20.35	19.81	20.80
15+5	1	0	1	24		13.55	13.06	13.90
15+5	1	74	1	0		23.33	22.48	23.32
15+5	75	0	25	0	64-QAM	20.33	19.85	20.88
15+5	1	0	1	24		13.28	12.96	13.73
15+5	1	74	1	0		22.13	21.35	21.80
15+5	75	0	25	0	256-QAM	18.34	17.93	18.81
15+5	1	0	1	24		13.06	12.71	13.65
15+5	1	74	1	0		18.95	18.40	18.94
5+15	25	0	75	0	QPSK	21.51	21.73	21.42
5+15	1	0	1	74		13.21	13.24	12.86
5+15	1	24	1	0		23.63	23.57	23.45
5+15	25	0	75	0	16-QAM	20.52	20.81	20.45
5+15	1	0	1	74		13.55	13.66	13.28
5+15	1	24	1	0		23.01	23.26	23.36
5+15	25	0	75	0	64-QAM	20.53	20.73	20.45
5+15	1	0	1	74		13.38	13.55	13.46
5+15	1	24	1	0		21.75	21.55	21.32
5+15	25	0	75	0	256-QAM	18.53	18.76	18.53
5+15	1	0	1	74		13.21	13.54	13.34
5+15	1	24	1	0		18.85	18.97	19.03



LTE Band 66B_CA Maximum Average Power [dBm]								
BW [MHz]	PCC		SCC		Mod	Lowest	Middle	Highest
	RB Size	RB Offset	RB Size	RB Offset				
10+5	50	0	25	0	QPSK	21.76	21.99	21.41
10+5	1	0	1	24		13.96	14.04	13.44
10+5	1	49	1	0		23.64	23.78	23.33
10+5	50	0	25	0	16-QAM	20.83	20.97	20.42
10+5	1	0	1	24		14.28	14.30	13.78
10+5	1	49	1	0		23.08	23.22	22.81
10+5	50	0	25	0	64-QAM	20.82	21.01	20.43
10+5	1	0	1	24		14.07	14.32	13.64
10+5	1	49	1	0		21.96	22.05	19.76
10+5	50	0	25	0	256-QAM	18.84	18.99	18.52
10+5	1	0	1	24		14.08	14.18	13.51
10+5	1	49	1	0		18.99	18.97	18.78
5+10	25	0	50	0	QPSK	21.96	22.16	22.12
5+10	1	0	1	49		14.13	14.32	14.07
5+10	1	24	1	0		23.80	23.81	23.75
5+10	25	0	50	0	16-QAM	20.87	21.23	21.08
5+10	1	0	1	49		14.28	14.58	14.37
5+10	1	24	1	0		23.58	23.44	23.50
5+10	25	0	50	0	64-QAM	20.91	21.15	21.12
5+10	1	0	1	49		14.35	14.49	14.30
5+10	1	24	1	0		21.87	22.54	21.26
5+10	25	0	50	0	256-QAM	18.95	19.23	19.10
5+10	1	0	1	49		13.83	14.37	14.24
5+10	1	24	1	0		19.03	19.80	19.17
5+5	25	0	25	0	QPSK	22.07	22.17	22.02
5+5	1	0	1	24		14.11	14.20	14.15
5+5	1	24	1	0		23.70	23.78	23.75
5+5	25	0	25	0	16-QAM	21.07	21.16	21.05
5+5	1	0	1	24		14.39	14.62	14.64
5+5	1	24	1	0		23.33	23.60	23.48
5+5	25	0	25	0	64-QAM	20.99	21.27	21.09
5+5	1	0	1	24		14.28	14.42	14.14
5+5	1	24	1	0		22.29	22.58	21.81
5+5	25	0	25	0	256-QAM	19.02	19.21	19.04
5+5	1	0	1	24		14.19	14.32	14.07
5+5	1	24	1	0		19.15	19.37	19.04



LTE Band 66C_CA Maximum Average Power [dBm]								
BW [MHz]	PCC		SCC		Mod	Lowest	Middle	Highest
	RB Size	RB Offset	RB Size	RB Offset				
20+20	100	0	100	0	QPSK	21.21	21.19	21.29
20+20	1	0	1	99		14.67	14.51	15.02
20+20	1	99	1	0		22.94	22.75	23.38
20+20	100	0	100	0	16-QAM	20.13	20.07	20.41
20+20	1	0	1	99		15.12	15.05	15.51
20+20	1	99	1	0		22.56	22.23	22.74
20+20	100	0	100	0	64-QAM	20.29	20.09	20.50
20+20	1	0	1	99		14.85	14.87	15.46
20+20	1	99	1	0		21.47	20.69	21.65
20+20	100	0	100	0	256-QAM	18.18	18.15	18.44
20+20	1	0	1	99		14.83	14.65	15.09
20+20	1	99	1	0		18.61	18.62	18.36
20+15	100	0	75	0	QPSK	21.35	21.45	21.65
20+15	1	0	1	74		14.99	14.90	15.19
20+15	1	74	1	0		23.13	23.12	23.25
20+15	100	0	75	0	16-QAM	20.26	20.26	20.65
20+15	1	0	1	74		15.37	14.91	15.55
20+15	1	74	1	0		22.41	22.37	22.83
20+15	100	0	75	0	64-QAM	20.34	20.23	20.75
20+15	1	0	1	74		15.12	14.90	15.66
20+15	1	74	1	0		21.61	21.16	20.27
20+15	100	0	75	0	256-QAM	18.32	18.32	18.79
20+15	1	0	1	74		14.88	14.82	15.38
20+15	1	74	1	0		18.48	18.08	18.44
15+20	75	0	100	0	QPSK	21.22	21.44	21.67
15+20	1	0	1	99		14.75	14.91	14.95
15+20	1	74	1	0		22.99	23.25	23.58
15+20	75	0	100	0	16-QAM	20.32	20.65	20.34
15+20	1	0	1	99		15.05	15.19	15.39
15+20	1	74	1	0		22.34	22.80	23.43
15+20	75	0	100	0	64-QAM	20.23	20.23	20.61
15+20	1	0	1	99		15.01	15.38	15.20
15+20	1	74	1	0		21.70	21.35	20.52
15+20	75	0	100	0	256-QAM	18.32	18.43	18.34
15+20	1	0	1	99		15.24	15.28	15.45
15+20	1	74	1	0		18.22	18.52	19.06



LTE Band 66C_CA Maximum Average Power [dBm]								
BW [MHz]	PCC		SCC		Mod	Lowest	Middle	Highest
	RB Size	RB Offset	RB Size	RB Offset				
20+10	100	0	50	0	QPSK	21.20	21.44	21.65
20+10	1	0	1	49		14.85	14.81	15.24
20+10	1	99	1	0		23.19	23.40	23.33
20+10	100	0	50	0	16-QAM	20.35	20.37	20.61
20+10	1	0	1	49		15.28	15.78	15.58
20+10	1	99	1	0		22.85	22.48	23.12
20+10	100	0	50	0	64-QAM	19.75	20.43	20.62
20+10	1	0	1	49		14.98	15.45	15.33
20+10	1	99	1	0		21.64	21.72	20.18
20+10	100	0	50	0	256-QAM	18.33	18.52	18.58
20+10	1	0	1	49		15.16	15.23	15.44
20+10	1	99	1	0		18.53	18.40	18.86
10+20	50	0	100	0	QPSK	21.14	21.37	21.48
10+20	1	0	1	99		14.79	14.98	15.04
10+20	1	49	1	0		22.98	23.27	23.31
10+20	50	0	100	0	16-QAM	20.25	20.51	20.56
10+20	1	0	1	99		15.10	15.54	15.68
10+20	1	49	1	0		22.27	23.00	22.52
10+20	50	0	100	0	64-QAM	20.20	20.28	20.63
10+20	1	0	1	99		15.00	15.08	15.39
10+20	1	49	1	0		21.17	21.94	22.01
10+20	50	0	100	0	256-QAM	18.15	18.50	18.59
10+20	1	0	1	99		14.99	15.53	15.36
10+20	1	49	1	0		18.21	18.17	18.55
20+5	100	0	25	0	QPSK	20.82	21.03	21.55
20+5	1	0	1	24		14.41	14.39	15.16
20+5	1	99	1	0		22.90	22.77	23.41
20+5	100	0	25	0	16-QAM	19.87	20.12	20.59
20+5	1	0	1	24		14.96	14.78	15.71
20+5	1	99	1	0		22.45	22.24	22.88
20+5	100	0	25	0	64-QAM	19.91	20.01	20.61
20+5	1	0	1	24		14.28	14.74	15.42
20+5	1	99	1	0		21.35	21.22	20.39
20+5	100	0	25	0	256-QAM	17.87	18.11	18.59
20+5	1	0	1	24		14.57	14.90	15.36
20+5	1	99	1	0		18.36	18.31	19.06



LTE Band 66C_CA Maximum Average Power [dBm]								
BW [MHz]	PCC		SCC		Mod	Lowest	Middle	Highest
	RB Size	RB Offset	RB Size	RB Offset				
5+20	25	0	100	0	QPSK	20.97	21.11	21.16
5+20	1	0	1	99		14.41	14.62	14.72
5+20	1	24	1	0		23.02	23.26	23.14
5+20	25	0	100	0	16-QAM	19.98	20.25	20.35
5+20	1	0	1	99		15.23	14.65	15.07
5+20	1	24	1	0		22.36	22.42	22.77
5+20	25	0	100	0	64-QAM	19.94	20.16	20.25
5+20	1	0	1	99		14.77	15.07	14.87
5+20	1	24	1	0		20.48	21.41	21.22
5+20	25	0	100	0	256-QAM	17.90	18.22	18.34
5+20	1	0	1	99		14.80	15.11	15.03
5+20	1	24	1	0		17.85	17.71	18.50
15+10	75	0	50	0	QPSK	21.13	21.27	21.58
15+10	1	0	1	49		14.65	14.62	15.02
15+10	1	74	1	0		23.01	23.04	23.41
15+10	75	0	50	0	16-QAM	20.17	20.14	20.62
15+10	1	0	1	49		15.08	15.12	15.64
15+10	1	74	1	0		22.37	22.31	23.08
15+10	75	0	50	0	64-QAM	20.18	20.18	20.55
15+10	1	0	1	49		14.95	14.86	15.43
15+10	1	74	1	0		21.09	21.64	20.53
15+10	75	0	50	0	256-QAM	18.21	18.21	18.68
15+10	1	0	1	49		14.83	14.91	15.43
15+10	1	74	1	0		17.73	18.01	18.45
10+15	50	0	75	0	QPSK	20.98	20.52	21.63
10+15	1	0	1	74		14.40	14.19	15.16
10+15	1	49	1	0		22.72	22.67	23.48
10+15	50	0	75	0	16-QAM	20.02	19.58	20.72
10+15	1	0	1	74		14.88	14.62	14.53
10+15	1	49	1	0		22.30	21.88	22.97
10+15	50	0	75	0	64-QAM	20.02	19.59	20.64
10+15	1	0	1	74		14.82	14.02	15.39
10+15	1	49	1	0		20.77	20.95	21.83
10+15	50	0	75	0	256-QAM	18.02	17.57	18.68
10+15	1	0	1	74		15.04	14.05	15.44
10+15	1	49	1	0		18.14	17.53	18.93



LTE Band 66C_CA Maximum Average Power [dBm]								
BW [MHz]	PCC		SCC		Mod	Lowest	Middle	Highest
	RB Size	RB Offset	RB Size	RB Offset				
15+15	75	0	75	0	QPSK	21.25	21.73	21.73
15+15	1	0	1	74		14.53	14.62	15.26
15+15	1	74	1	0		22.90	23.19	23.13
15+15	75	0	75	0	16-QAM	20.17	20.57	20.77
15+15	1	0	1	74		15.11	15.43	15.58
15+15	1	74	1	0		22.36	22.44	22.76
15+15	75	0	75	0	64-QAM	20.13	20.37	20.67
15+15	1	0	1	74		15.22	15.12	15.58
15+15	1	74	1	0		21.27	21.34	19.64
15+15	75	0	75	0	256-QAM	18.21	18.33	18.72
15+15	1	0	1	74		14.93	15.88	15.45
15+15	1	74	1	0		18.34	18.40	18.38



LTE Band 38C_CA Maximum Average Power [dBm]								
BW [MHz]	PCC		SCC		Mod	Lowest	Middle	Highest
	RB Size	RB Offset	RB Size	RB Offset				
20+20	100	0	100	0	QPSK	18.29	18.09	17.87
20+20	1	0	1	99		13.59	13.54	13.59
20+20	1	99	1	0		20.84	20.94	21.20
20+20	100	0	100	0	16-QAM	17.44	17.20	16.60
20+20	1	0	1	99		14.12	14.05	14.11
20+20	1	99	1	0		20.44	20.30	20.60
20+20	100	0	100	0	64-QAM	16.44	16.16	15.56
20+20	1	0	1	99		13.89	13.83	13.88
20+20	1	99	1	0		17.34	17.08	17.35
20+20	100	0	100	0	256-QAM	15.45	15.10	14.55
20+20	1	0	1	99		13.87	13.73	13.81
20+20	1	99	1	0		16.27	16.03	16.28
15+15	75	0	75	0	QPSK	18.29	18.13	18.32
15+15	1	0	1	74		13.64	13.56	13.56
15+15	1	74	1	0		20.69	20.96	21.12
15+15	75	0	75	0	16-QAM	17.45	17.34	17.23
15+15	1	0	1	74		14.18	14.10	14.05
15+15	1	74	1	0		20.36	20.36	20.56
15+15	75	0	75	0	64-QAM	16.55	16.39	16.19
15+15	1	0	1	74		13.89	13.84	13.79
15+15	1	74	1	0		17.33	17.18	17.27
15+15	75	0	75	0	256-QAM	15.51	15.31	15.17
15+15	1	0	1	74		13.78	13.70	13.79
15+15	1	74	1	0		16.36	16.11	16.21



LTE Band 41C_CA Maximum Average Power [dBm]								
BW [MHz]	PCC		SCC		Mod	Lowest	Middle	Highest
	RB Size	RB Offset	RB Size	RB Offset				
20+20	100	0	100	0	QPSK	20.46	20.93	20.84
20+20	1	0	1	99		13.97	14.37	14.35
20+20	1	99	1	0		22.28	22.40	23.15
20+20	100	0	100	0	16-QAM	19.52	19.95	19.86
20+20	1	0	1	99		13.98	14.41	14.37
20+20	1	99	1	0		20.99	21.47	21.71
20+20	100	0	100	0	64-QAM	19.48	19.94	19.85
20+20	1	0	1	99		13.64	14.03	14.06
20+20	1	99	1	0		19.95	20.45	20.84
20+20	100	0	100	0	256-QAM	17.46	17.94	17.88
20+20	1	0	1	99		13.88	14.27	14.24
20+20	1	99	1	0		17.23	17.63	18.13
20+15	100	0	75	0	QPSK	20.93	21.31	21.19
20+15	1	0	1	74		14.43	14.79	14.73
20+15	1	99	1	0		22.48	23.09	23.01
20+15	100	0	75	0	16-QAM	19.93	20.33	20.18
20+15	1	0	1	74		14.44	14.82	14.71
20+15	1	99	1	0		21.49	21.73	21.64
20+15	100	0	75	0	64-QAM	19.99	20.38	20.21
20+15	1	0	1	74		14.12	14.48	14.39
20+15	1	99	1	0		20.47	20.91	20.76
20+15	100	0	75	0	256-QAM	17.97	18.40	18.25
20+15	1	0	1	74		14.30	14.68	14.58
20+15	1	99	1	0		17.77	18.11	18.02
15+20	75	0	100	0	QPSK	20.86	21.24	21.13
15+20	1	0	1	99		14.43	14.68	14.59
15+20	1	74	1	0		22.66	22.99	22.90
15+20	75	0	100	0	16-QAM	19.86	20.25	20.08
15+20	1	0	1	99		14.28	14.79	14.62
15+20	1	74	1	0		21.41	21.79	21.41
15+20	75	0	100	0	64-QAM	19.87	20.24	20.05
15+20	1	0	1	99		13.96	14.44	14.34
15+20	1	74	1	0		20.61	20.81	20.68
15+20	75	0	100	0	256-QAM	17.87	18.26	18.14
15+20	1	0	1	99		14.37	14.70	14.49
15+20	1	74	1	0		17.60	17.99	17.93



LTE Band 41C_CA Maximum Average Power [dBm]								
BW [MHz]	PCC		SCC		Mod	Lowest	Middle	Highest
	RB Size	RB Offset	RB Size	RB Offset				
20+10	100	0	50	0	QPSK	20.23	20.72	21.03
20+10	1	0	1	49		13.69	14.21	14.58
20+10	1	99	1	0		22.11	22.55	22.86
20+10	100	0	50	0	16-QAM	19.23	19.78	20.06
20+10	1	0	1	49		13.78	14.36	14.56
20+10	1	99	1	0		20.67	21.16	21.52
20+10	100	0	50	0	64-QAM	19.25	19.80	19.98
20+10	1	0	1	49		13.40	13.92	14.24
20+10	1	99	1	0		19.78	20.35	20.62
20+10	100	0	50	0	256-QAM	17.27	17.78	18.02
20+10	1	0	1	49		13.65	14.15	14.41
20+10	1	99	1	0		17.04	17.54	17.85
10+20	50	0	100	0	QPSK	20.19	20.66	20.54
10+20	1	0	1	99		13.73	14.18	14.13
10+20	1	49	1	0		21.97	22.46	22.36
10+20	50	0	100	0	16-QAM	19.23	19.70	19.60
10+20	1	0	1	99		13.86	14.29	14.12
10+20	1	49	1	0		20.63	21.06	21.04
10+20	50	0	100	0	64-QAM	19.21	19.71	19.63
10+20	1	0	1	99		13.42	13.90	13.79
10+20	1	49	1	0		19.71	20.26	20.07
10+20	50	0	100	0	256-QAM	17.25	17.76	17.64
10+20	1	0	1	99		13.65	14.09	13.94
10+20	1	49	1	0		16.99	17.49	17.38
20+5	100	0	25	0	QPSK	20.01	20.56	20.58
20+5	1	0	1	24		13.46	14.12	14.13
20+5	1	99	1	0		21.71	22.48	22.45
20+5	100	0	25	0	16-QAM	19.06	19.53	19.60
20+5	1	0	1	24		13.54	14.27	14.14
20+5	1	99	1	0		20.48	21.26	21.16
20+5	100	0	25	0	64-QAM	19.03	19.67	19.59
20+5	1	0	1	24		13.20	13.85	13.80
20+5	1	99	1	0		19.72	20.15	20.25
20+5	100	0	25	0	256-QAM	17.05	17.63	17.64
20+5	1	0	1	24		13.39	14.02	13.94
20+5	1	99	1	0		16.81	17.43	17.50



LTE Band 41C_CA Maximum Average Power [dBm]								
BW [MHz]	PCC		SCC		Mod	Lowest	Middle	Highest
	RB Size	RB Offset	RB Size	RB Offset				
5+20	25	0	100	0	QPSK	20.60	20.94	21.04
5+20	1	0	1	99		14.16	14.41	14.58
5+20	1	24	1	0		22.46	22.84	22.98
5+20	25	0	100	0	16-QAM	19.65	19.96	20.09
5+20	1	0	1	99		14.31	14.61	14.61
5+20	1	24	1	0		21.14	21.41	21.72
5+20	25	0	100	0	64-QAM	19.63	19.94	20.03
5+20	1	0	1	99		13.83	14.08	14.26
5+20	1	24	1	0		20.19	20.62	20.72
5+20	25	0	100	0	256-QAM	17.66	18.00	17.99
5+20	1	0	1	99		14.06	14.41	14.46
5+20	1	24	1	0		17.40	17.80	17.98
15+10	75	0	50	0	QPSK	20.02	20.63	20.71
15+10	1	0	1	49		13.53	14.12	14.12
15+10	1	74	1	0		21.87	22.46	22.32
15+10	75	0	50	0	16-QAM	19.01	19.65	19.61
15+10	1	0	1	49		13.62	14.29	14.14
15+10	1	74	1	0		20.49	21.21	21.06
15+10	75	0	50	0	64-QAM	19.05	19.68	19.56
15+10	1	0	1	49		13.26	13.82	13.78
15+10	1	74	1	0		19.55	20.26	20.18
15+10	75	0	50	0	256-QAM	17.07	17.79	17.64
15+10	1	0	1	49		13.54	14.05	14.00
15+10	1	74	1	0		17.02	17.46	17.42
10+15	50	0	75	0	QPSK	20.05	20.65	20.62
10+15	1	0	1	74		13.69	14.15	14.18
10+15	1	49	1	0		21.96	22.43	22.46
10+15	50	0	75	0	16-QAM	19.08	19.68	19.66
10+15	1	0	1	74		13.79	14.29	14.18
10+15	1	49	1	0		20.52	20.99	21.13
10+15	50	0	75	0	64-QAM	19.12	19.75	19.73
10+15	1	0	1	74		13.40	13.87	14.09
10+15	1	49	1	0		19.69	20.26	20.19
10+15	50	0	75	0	256-QAM	17.25	17.76	17.72
10+15	1	0	1	74		13.64	14.09	14.04
10+15	1	49	1	0		16.89	17.48	17.50



LTE Band 41C_CA Maximum Average Power [dBm]								
BW [MHz]	PCC		SCC		Mod	Lowest	Middle	Highest
	RB Size	RB Offset	RB Size	RB Offset				
15+15	75	0	75	0	QPSK	20.75	21.13	20.75
15+15	1	0	1	74		14.30	14.57	14.27
15+15	1	74	1	0		22.29	22.86	22.77
15+15	75	0	75	0	16-QAM	19.77	20.15	19.80
15+15	1	0	1	74		14.27	14.70	14.40
15+15	1	74	1	0		21.23	21.59	21.43
15+15	75	0	75	0	64-QAM	19.83	20.16	19.88
15+15	1	0	1	74		13.96	14.35	14.13
15+15	1	74	1	0		20.25	20.63	20.49
15+15	75	0	75	0	256-QAM	17.81	18.19	17.94
15+15	1	0	1	74		14.19	14.44	14.31
15+15	1	74	1	0		17.51	17.83	17.62



LTE Band 5B

26dB Bandwidth

Mode	LTE Band 5B : 26dB BW(MHz)		
QPSK			
BW	3MHz+5MHz	5MHz+3MHz	5MHz+10MHz
Lowest CH	-	-	14.51
Middle CH	-	-	14.63
Highest CH	-	-	14.63
BW	10MHz+5MHz	10MHz+10MHz	N/A
Lowest CH	14.60	19.54	-
Middle CH	14.66	19.74	-
Highest CH	14.63	19.82	-

Mode	LTE Band 5B : 26dB BW(MHz)		
16QAM			
BW	3MHz+5MHz	5MHz+3MHz	5MHz+10MHz
Lowest CH	-	-	14.54
Middle CH	-	-	14.54
Highest CH	-	-	14.51
BW	10MHz+5MHz	10MHz+10MHz	N/A
Lowest CH	14.60	19.70	-
Middle CH	14.63	19.82	-
Highest CH	14.54	19.62	-

Mode	LTE Band 5B : 26dB BW(MHz)		
64QAM			
BW	3MHz+5MHz	5MHz+3MHz	5MHz+10MHz
Lowest CH	-	-	14.57
Middle CH	-	-	14.57
Highest CH	-	-	14.54
BW	10MHz+5MHz	10MHz+10MHz	N/A
Lowest CH	14.72	19.70	-
Middle CH	14.69	19.54	-
Highest CH	14.72	19.74	-



Mode	LTE Band 5B : 26dB BW(MHz)		
256QAM			
BW	3MHz+5MHz	5MHz+3MHz	5MHz+10MHz
Lowest CH	-	-	14.54
Middle CH	-	-	14.57
Highest CH	-	-	14.54
BW	10MHz+5MHz	10MHz+10MHz	N/A
Lowest CH	14.57	19.66	-
Middle CH	14.60	19.70	-
Highest CH	14.60	19.54	-



LTE Band 5B

QPSK

Lowest Channel / 5MHz+10MHz

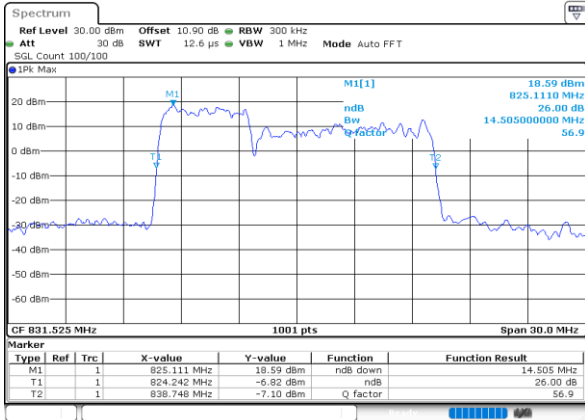

Date: 4.OCT.2020 13:05:02

Lowest Channel / 10MHz+5MHz

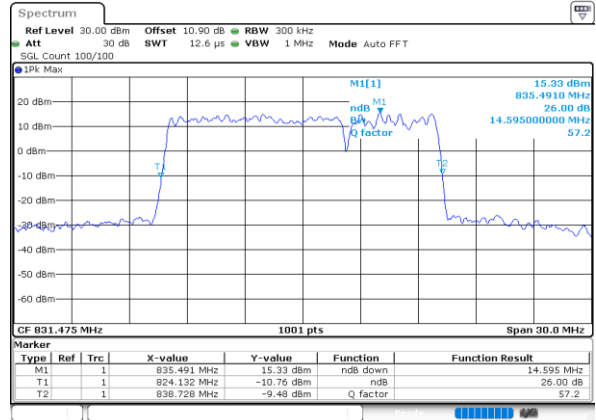

Date: 4.OCT.2020 14:30:53

Middle Channel / 5MHz+10MHz

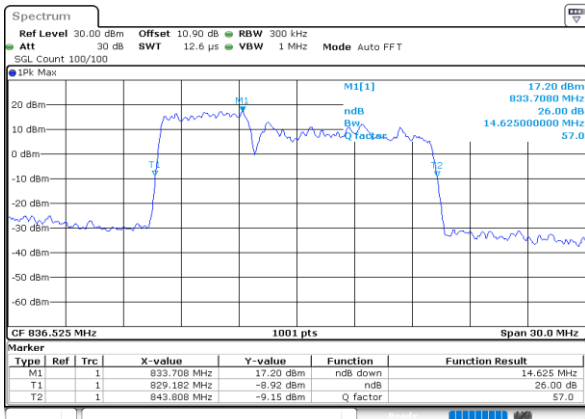

Date: 4.OCT.2020 13:41:17

Middle Channel / 10MHz+5MHz

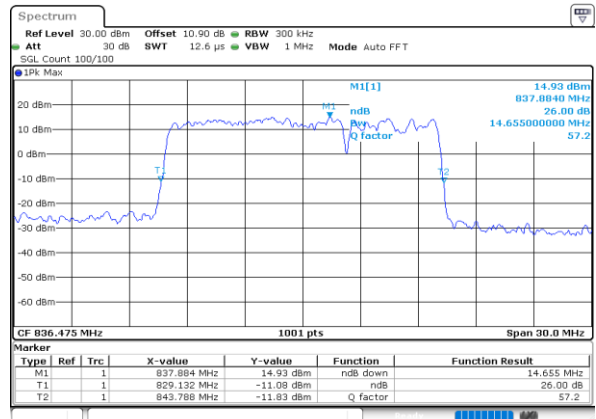

Date: 4.OCT.2020 15:23:53

Highest Channel / 5MHz+10MHz

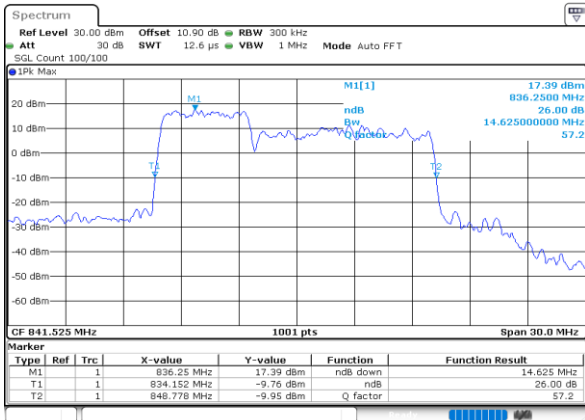

Date: 4.OCT.2020 13:52:15

Highest Channel / 10MHz+5MHz

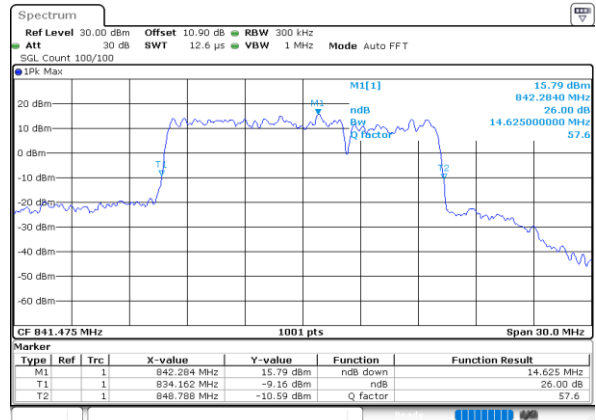

Date: 4.OCT.2020 15:34:32



LTE Band 5B

QPSK

Lowest Channel / 10MHz+10MHz

N/A

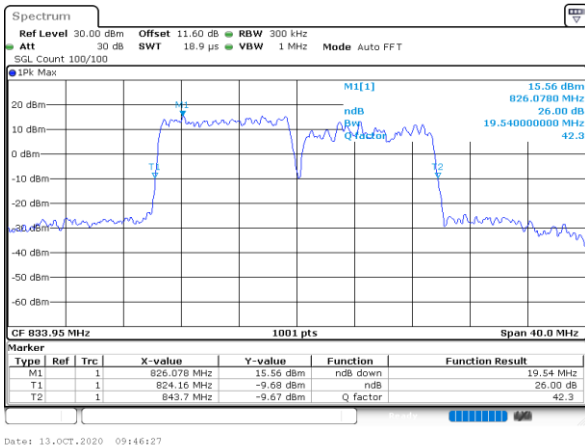

Date: 13.OCT.2020 09:46:27

Middle Channel / 10MHz+10MHz

N/A

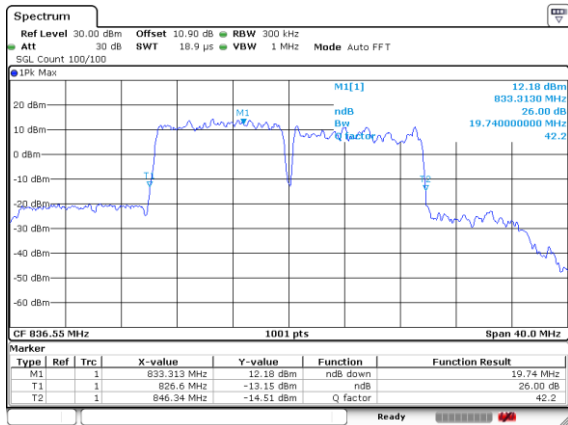

Date: 4.OCT.2020 16:57:07

Highest Channel / 10MHz+10MHz

N/A

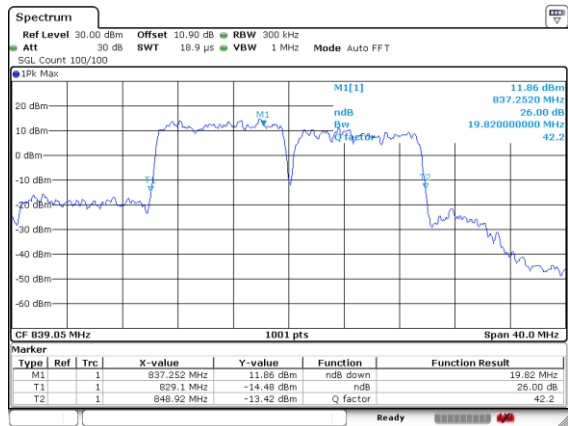

Date: 4.OCT.2020 17:39:04



LTE Band 5B

16QAM

Lowest Channel / 5MHz+10MHz

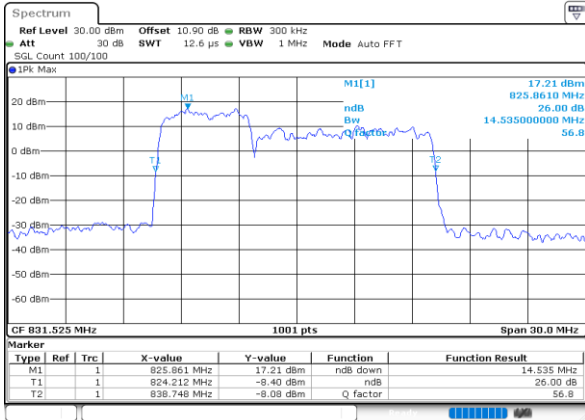

Date: 4.OCT.2020 13:04:39

Lowest Channel / 10MHz+5MHz

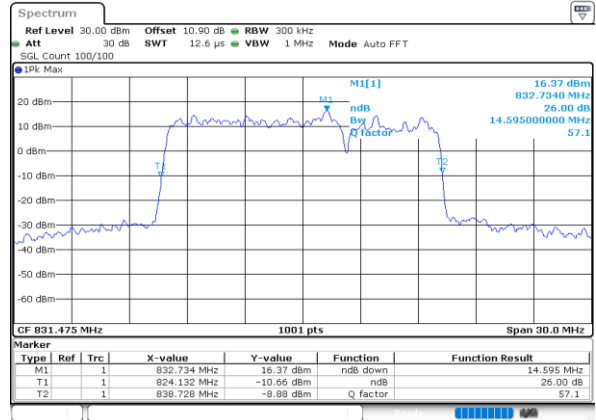

Date: 4.OCT.2020 14:30:31

Middle Channel / 5MHz+10MHz

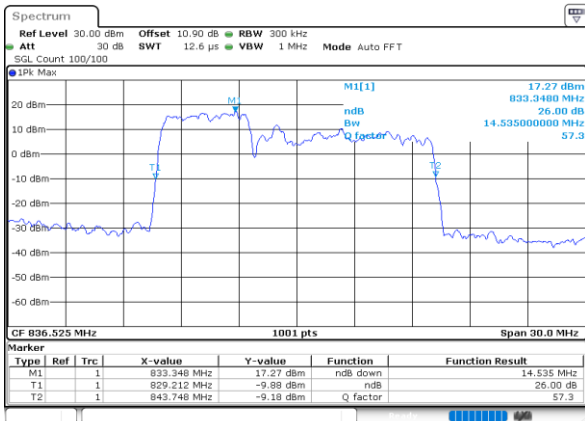

Date: 4.OCT.2020 13:40:54

Middle Channel / 10MHz+5MHz

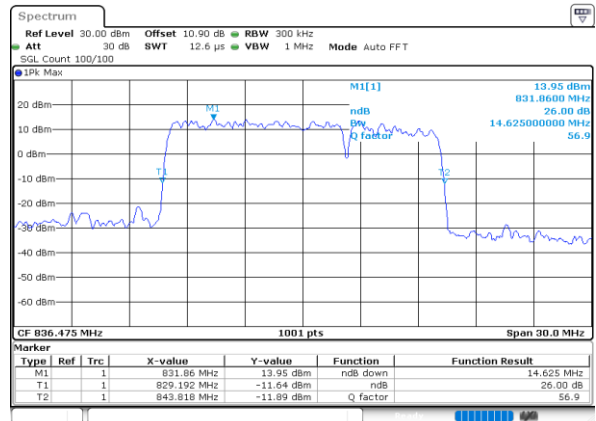

Date: 4.OCT.2020 15:23:30

Highest Channel / 5MHz+10MHz

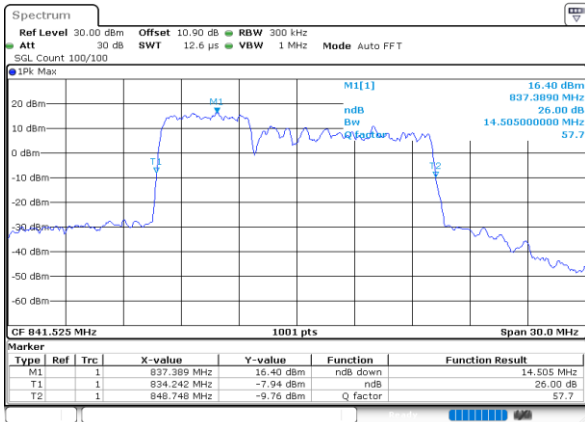

Date: 4.OCT.2020 13:52:37

Highest Channel / 10MHz+5MHz

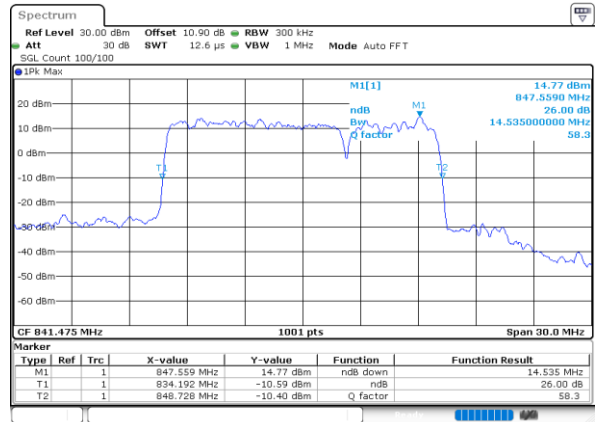

Date: 4.OCT.2020 15:34:54



LTE Band 5B

16QAM

Lowest Channel / 10MHz+10MHz

N/A

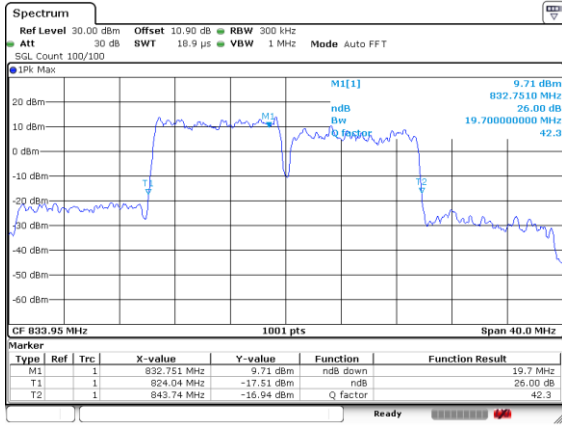

Date: 4.OCT.2020 16:42:48

Middle Channel / 10MHz+10MHz

N/A

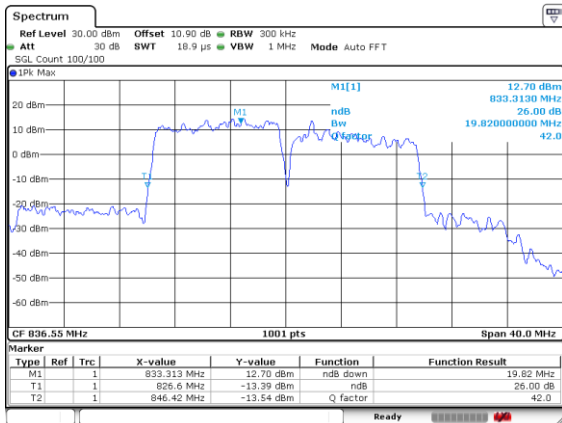

Date: 4.OCT.2020 16:57:23

Highest Channel / 10MHz+10MHz

N/A

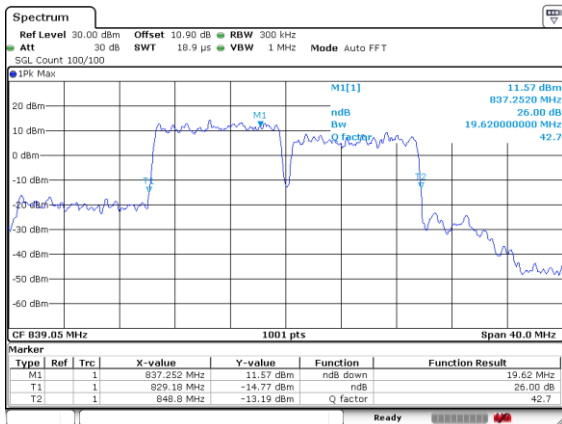

Date: 4.OCT.2020 17:39:18



LTE Band 5B

64QAM

Lowest Channel / 5MHz+10MHz

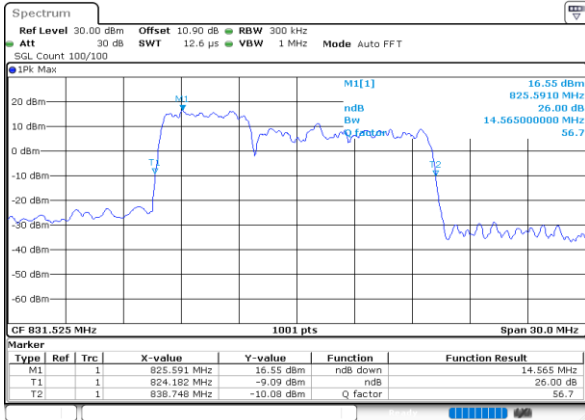

Date: 4.OCT.2020 13:04:16

Lowest Channel / 10MHz+5MHz

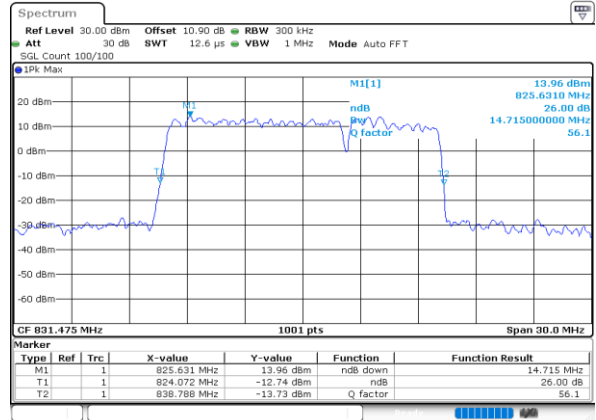

Date: 4.OCT.2020 14:30:08

Middle Channel / 5MHz+10MHz

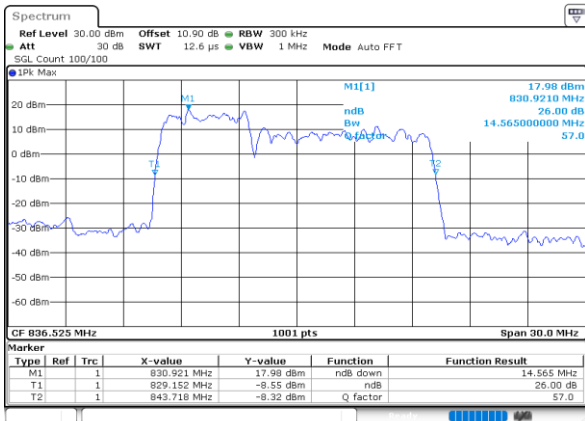

Date: 4.OCT.2020 13:40:32

Middle Channel / 10MHz+5MHz

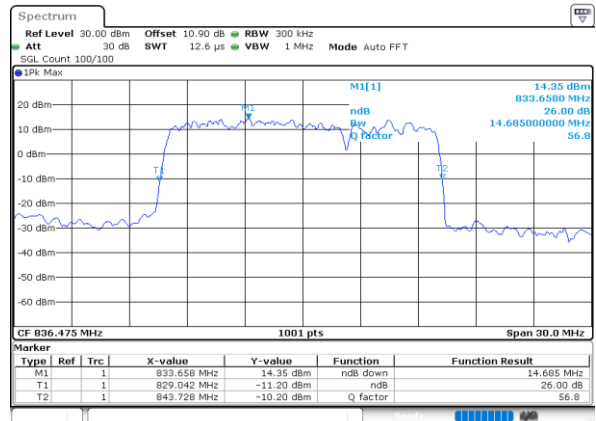

Date: 4.OCT.2020 15:23:07

Highest Channel / 5MHz+10MHz

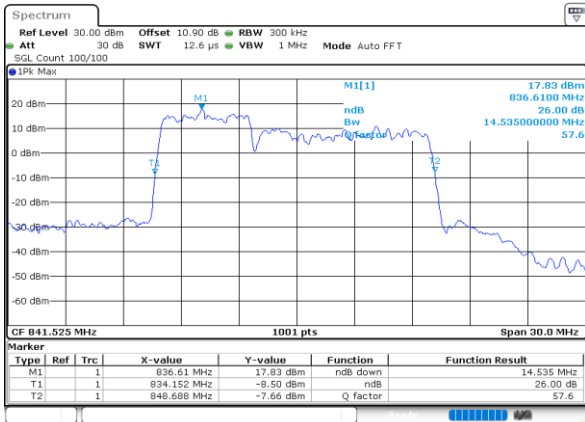

Date: 4.OCT.2020 13:53:00

Highest Channel / 10MHz+5MHz

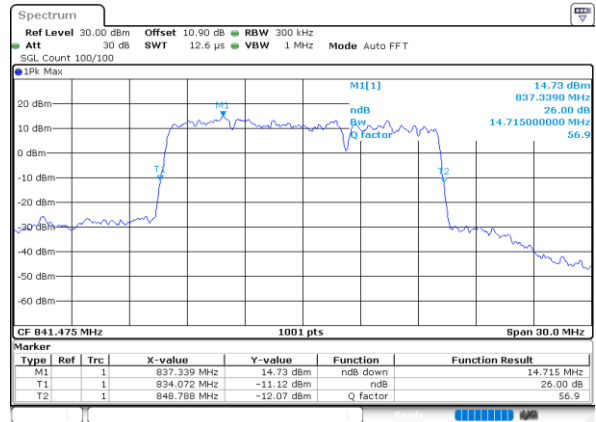

Date: 4.OCT.2020 15:35:17



LTE Band 5B

64QAM

Lowest Channel / 10MHz+10MHz

N/A

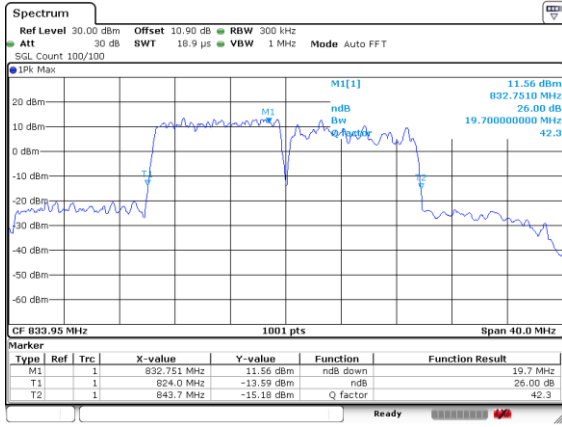

Date: 4.OCT.2020 16:43:11

Middle Channel / 10MHz+10MHz

N/A

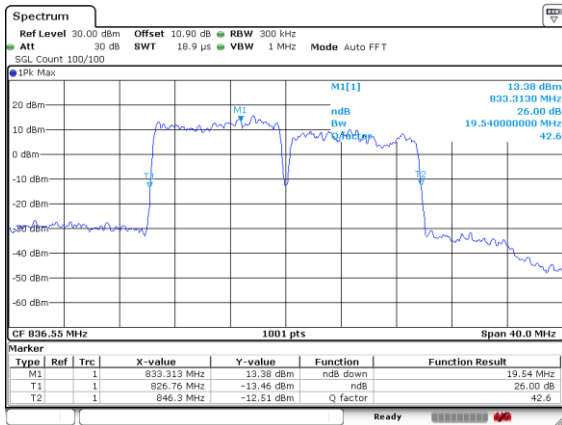

Date: 4.OCT.2020 16:57:39

Highest Channel / 10MHz+10MHz

N/A

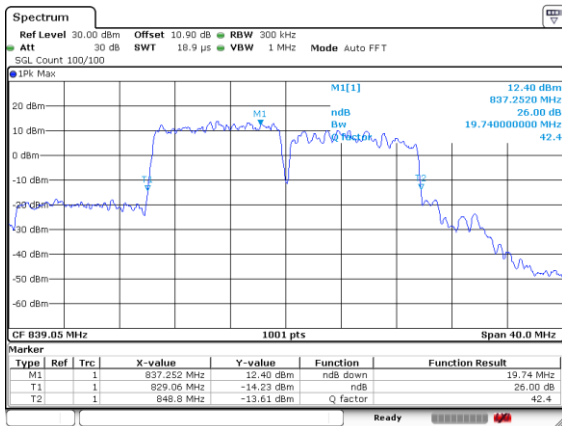

Date: 4.OCT.2020 17:39:33



LTE Band 5B

256QAM

Lowest Channel / 5MHz+10MHz

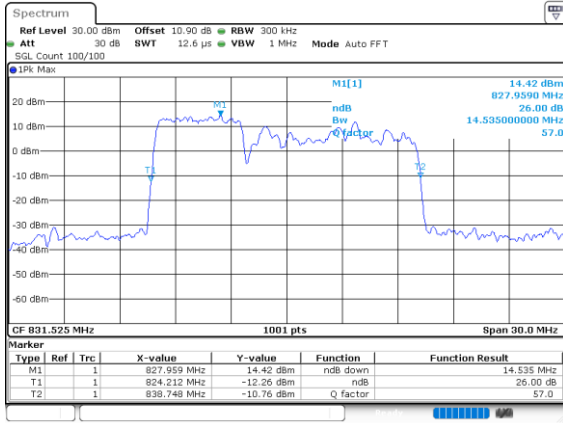

Date: 4.OCT.2020 13:03:54

Lowest Channel / 10MHz+5MHz

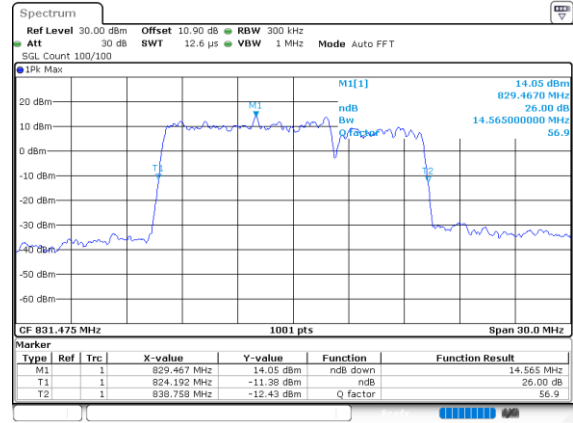

Date: 4.OCT.2020 14:29:46

Middle Channel / 5MHz+10MHz

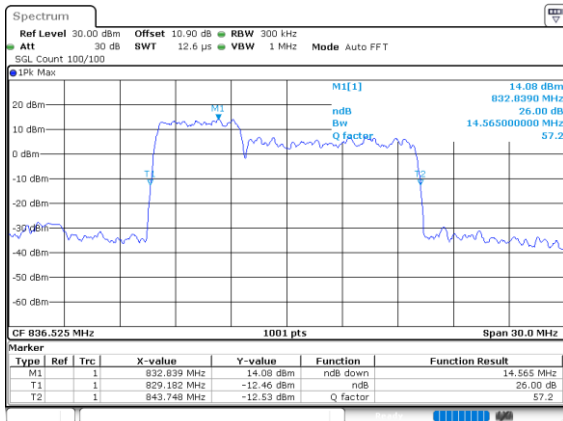

Date: 4.OCT.2020 13:40:10

Middle Channel / 10MHz+5MHz

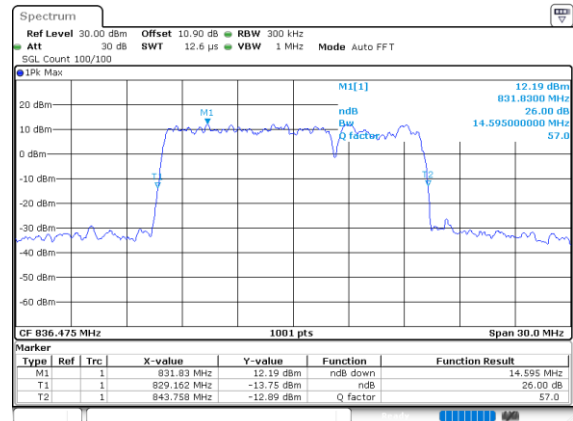

Date: 4.OCT.2020 15:22:45

Highest Channel / 5MHz+10MHz

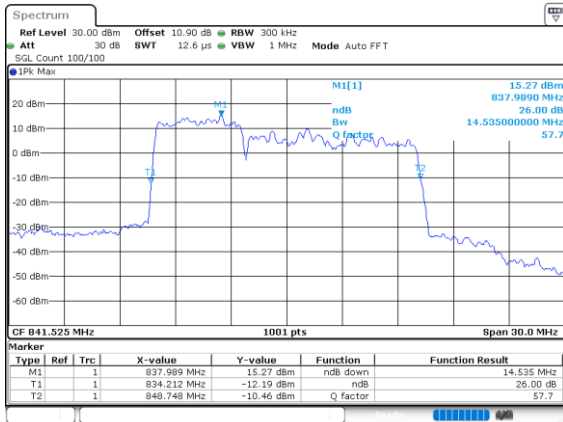

Date: 4.OCT.2020 13:53:22

Highest Channel / 10MHz+5MHz

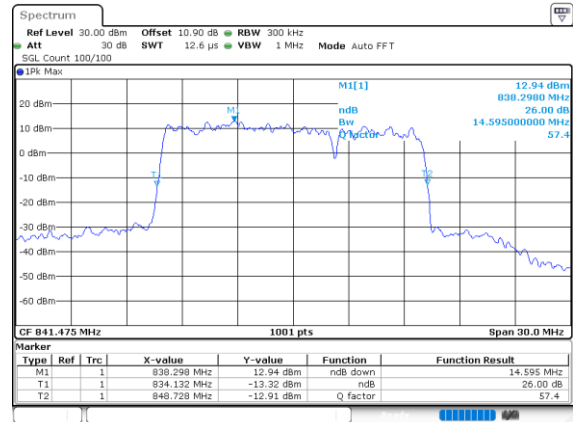

Date: 4.OCT.2020 15:35:19



LTE Band 5B

256QAM

Lowest Channel / 10MHz+10MHz

N/A

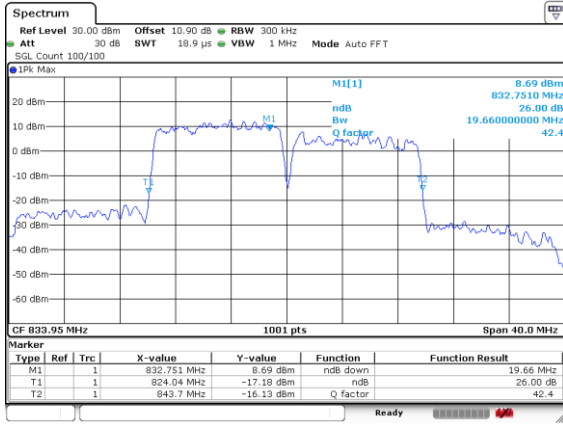

Date: 4.OCT.2020 16:43:27

Middle Channel / 10MHz+10MHz

N/A

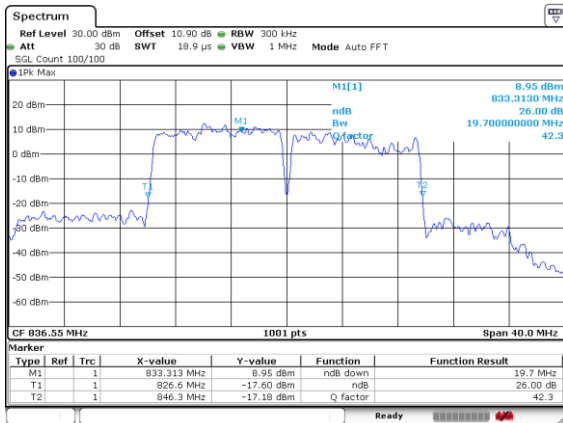

Date: 4.OCT.2020 16:58:00

Highest Channel / 10MHz+10MHz

N/A

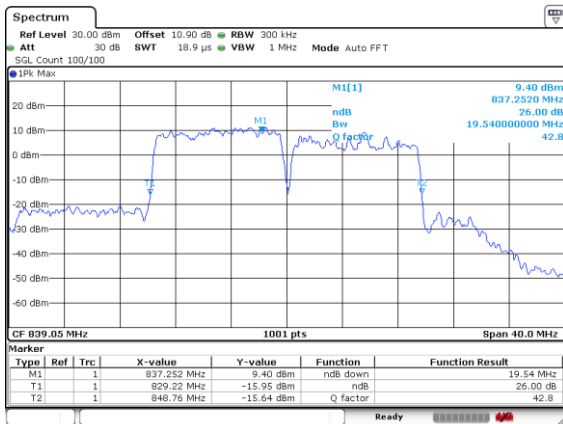

Date: 4.OCT.2020 17:39:50



Occupied Bandwidth

Mode	LTE Band 5B : 99%OBW(MHz)		
QPSK			
BW	3MHz+5MHz	5MHz+3MHz	5MHz+10MHz
Lowest CH	-	-	13.76
Middle CH	-	-	13.88
Highest CH	-	-	13.91
BW	10MHz+5MHz	10MHz+10MHz	N/A
Lowest CH	13.76	18.62	-
Middle CH	13.85	18.70	-
Highest CH	13.88	18.70	-

Mode	LTE Band 5B : 99%OBW(MHz)		
16QAM			
BW	3MHz+5MHz	5MHz+3MHz	5MHz+10MHz
Lowest CH	-	-	13.82
Middle CH	-	-	13.79
Highest CH	-	-	13.61
BW	10MHz+5MHz	10MHz+10MHz	N/A
Lowest CH	13.88	18.58	-
Middle CH	13.82	18.74	-
Highest CH	13.85	18.58	-

Mode	LTE Band 5B : 99%OBW(MHz)		
64QAM			
BW	3MHz+5MHz	5MHz+3MHz	5MHz+10MHz
Lowest CH	-	-	13.85
Middle CH	-	-	13.79
Highest CH	-	-	13.79
BW	10MHz+5MHz	10MHz+10MHz	N/A
Lowest CH	13.91	18.82	-
Middle CH	13.79	18.70	-
Highest CH	13.88	18.78	-



Mode	LTE Band 5B : 99%OBW(MHz)		
256QAM			
BW	3MHz+5MHz	5MHz+3MHz	5MHz+10MHz
Lowest CH	-	-	13.85
Middle CH	-	-	13.79
Highest CH	-	-	13.79
BW	10MHz+5MHz	10MHz+10MHz	N/A
Lowest CH	13.88	18.78	-
Middle CH	13.82	18.62	-
Highest CH	13.91	18.58	-



LTE Band 5B

QPSK

Lowest Channel / 5MHz+10MHz

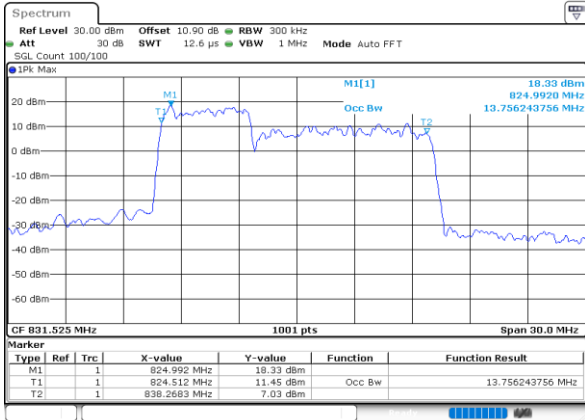

Date: 4.OCT.2020 13:00:22

Lowest Channel / 10MHz+5MHz

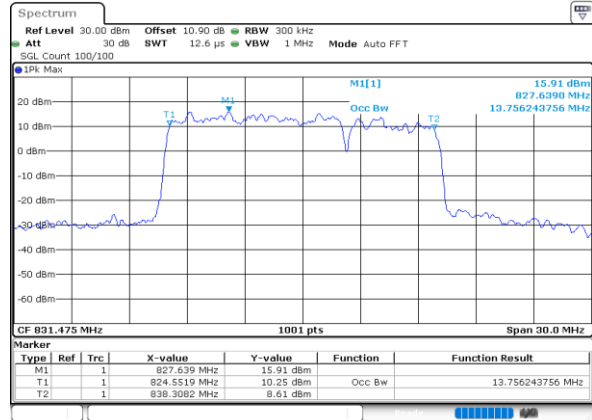

Date: 4.OCT.2020 14:28:16

Middle Channel / 5MHz+10MHz

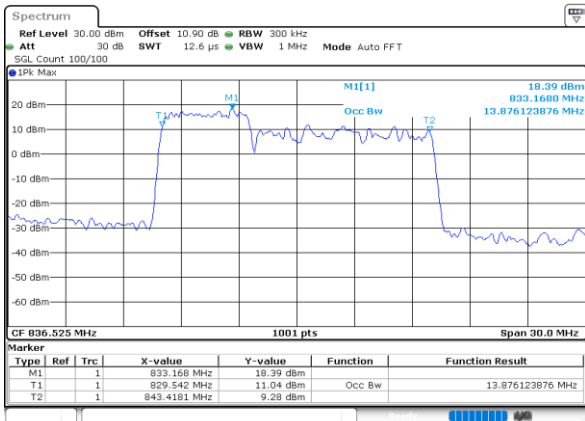

Date: 4.OCT.2020 13:38:40

Middle Channel / 10MHz+5MHz

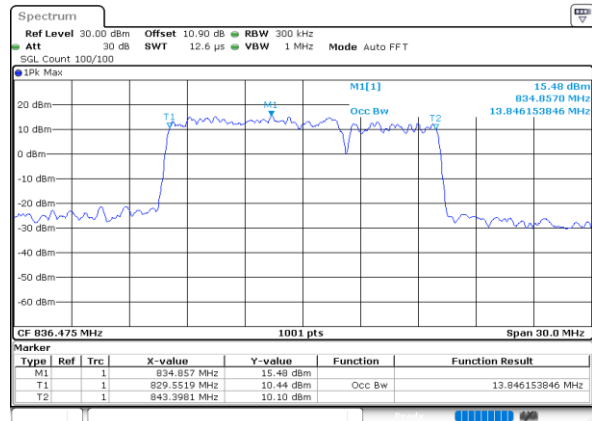

Date: 4.OCT.2020 15:21:16

Highest Channel / 5MHz+10MHz

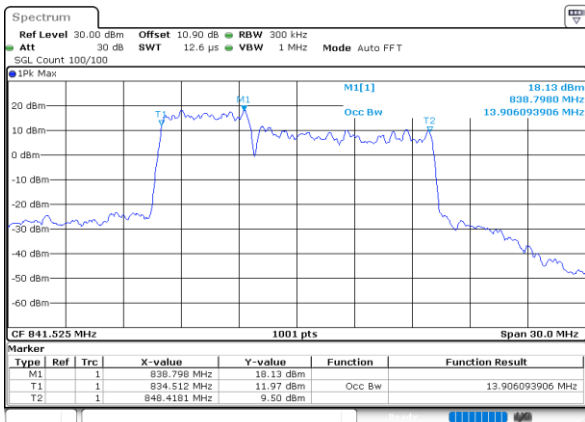

Date: 4.OCT.2020 13:51:53

Highest Channel / 10MHz+5MHz

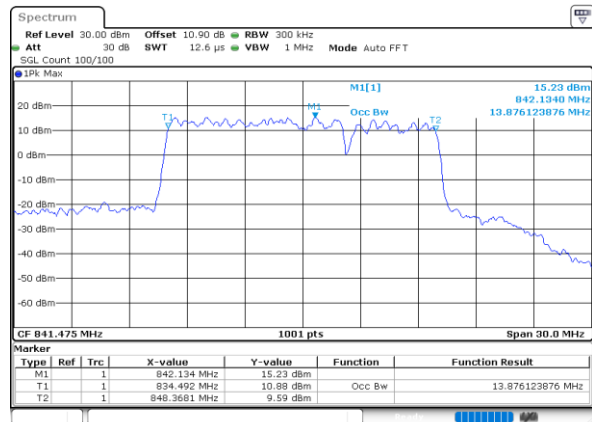

Date: 4.OCT.2020 15:34:10



LTE Band 5B

QPSK

Lowest Channel / 10MHz+10MHz

N/A

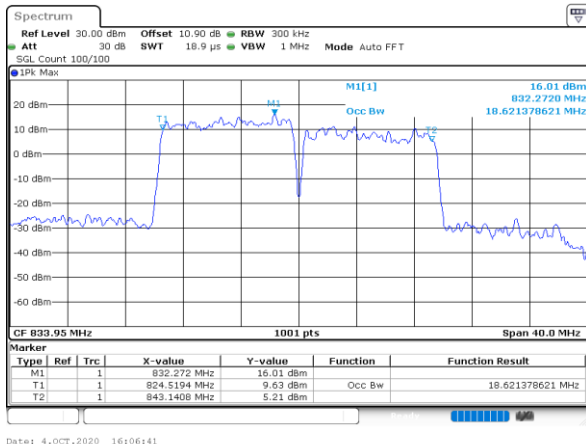

Middle Channel / 10MHz+10MHz

N/A

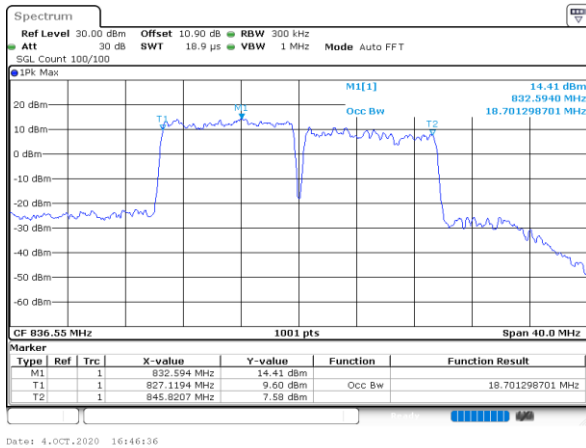

Highest Channel / 10MHz+10MHz

N/A

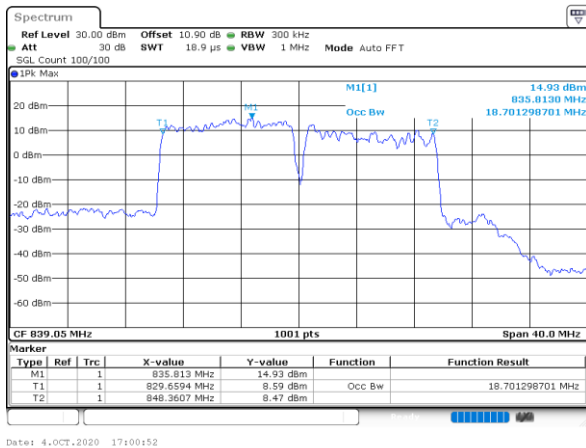



LTE Band 5B

16QAM

Lowest Channel / 5MHz+10MHz

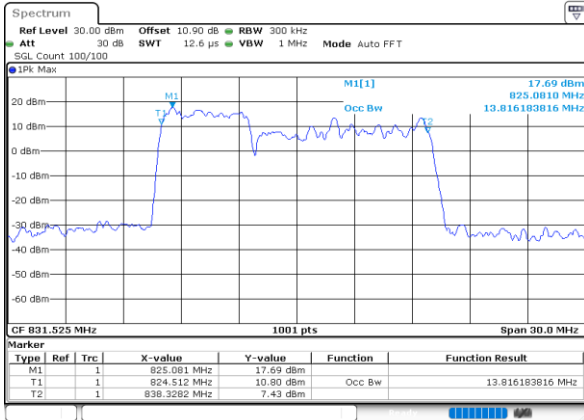

Date: 4.OCT.2020 13:00:45

Lowest Channel / 10MHz+5MHz

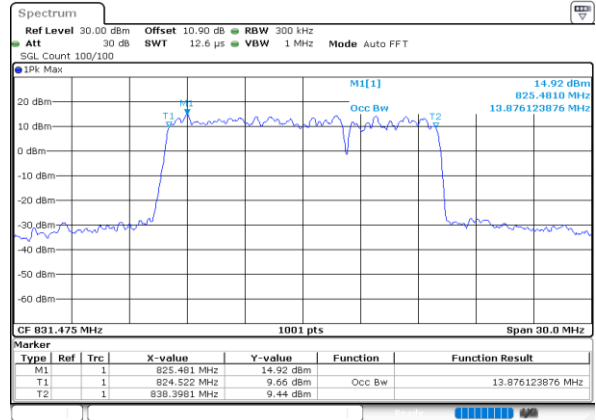

Date: 4.OCT.2020 14:28:39

Middle Channel / 5MHz+10MHz

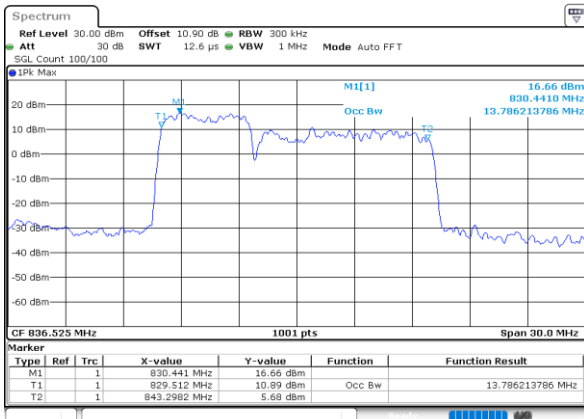

Date: 4.OCT.2020 13:19:03

Middle Channel / 10MHz+5MHz

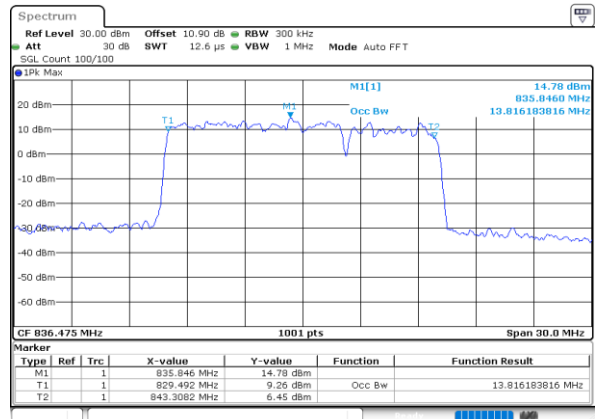

Date: 4.OCT.2020 15:21:38

Highest Channel / 5MHz+10MHz

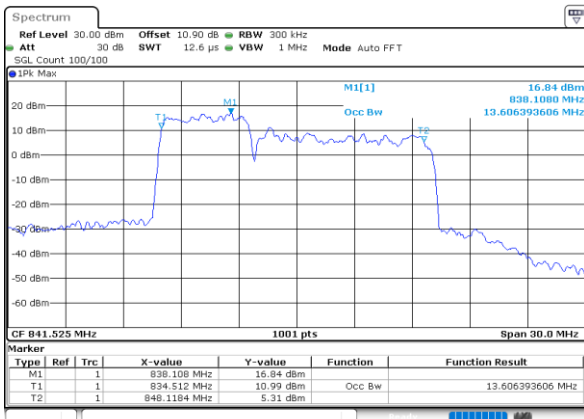

Date: 4.OCT.2020 13:51:30

Highest Channel / 10MHz+5MHz

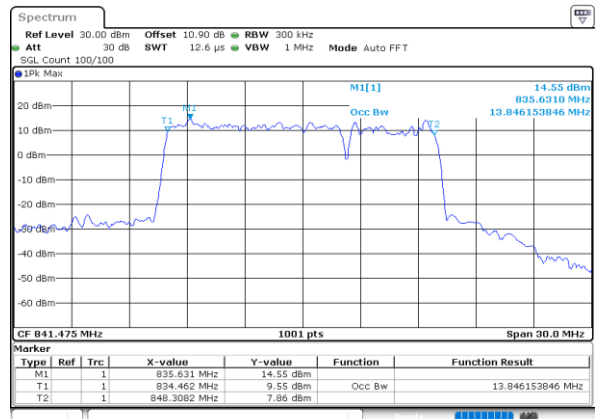

Date: 4.OCT.2020 15:33:47



LTE Band 5B

16QAM

Lowest Channel / 10MHz+10MHz

N/A

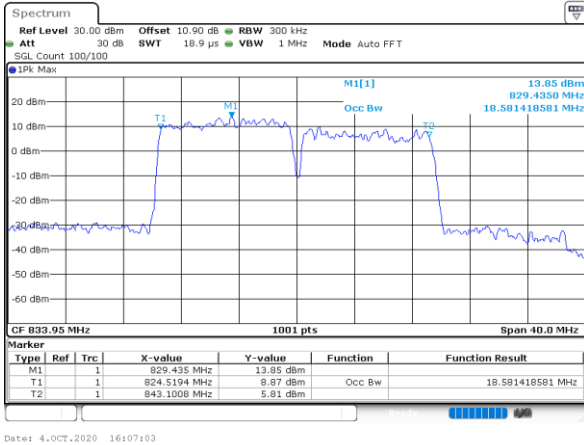

Date: 4.OCT.2020 16:07:03

Middle Channel / 10MHz+10MHz

N/A

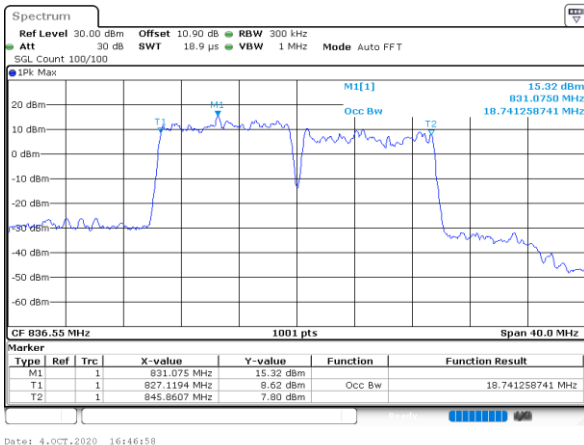

Date: 4.OCT.2020 16:46:58

Highest Channel / 10MHz+10MHz

N/A

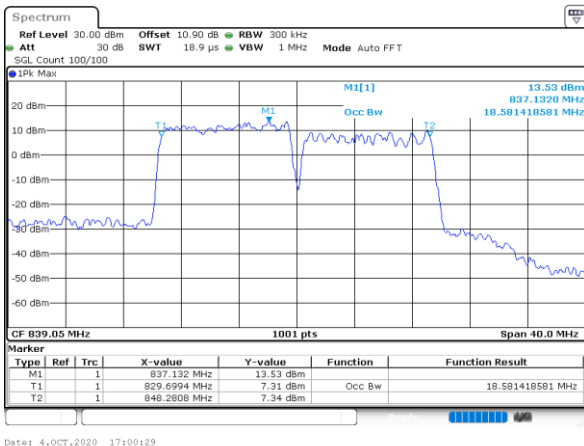

Date: 4.OCT.2020 17:00:29



LTE Band 5B

64QAM

Lowest Channel / 5MHz+10MHz

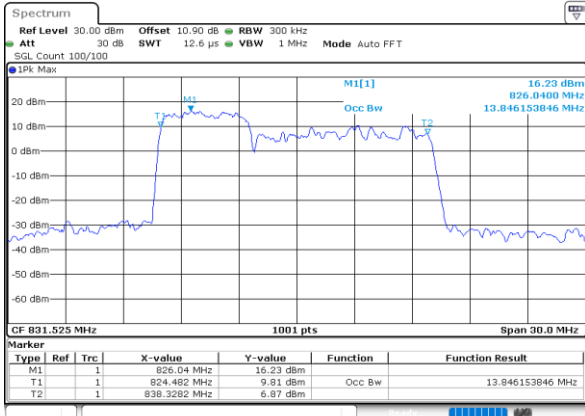

Date: 4.OCT.2020 13:03:09

Lowest Channel / 10MHz+5MHz

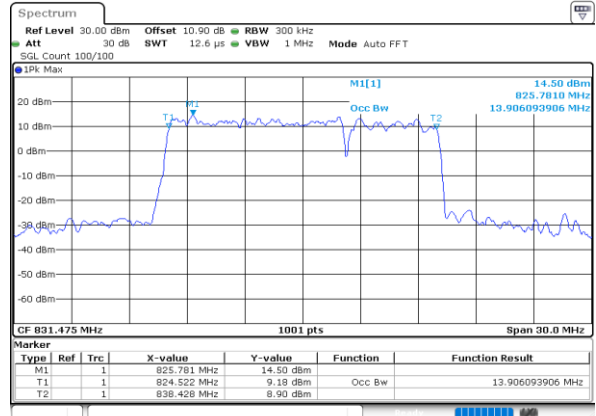

Date: 4.OCT.2020 14:22:01

Middle Channel / 5MHz+10MHz

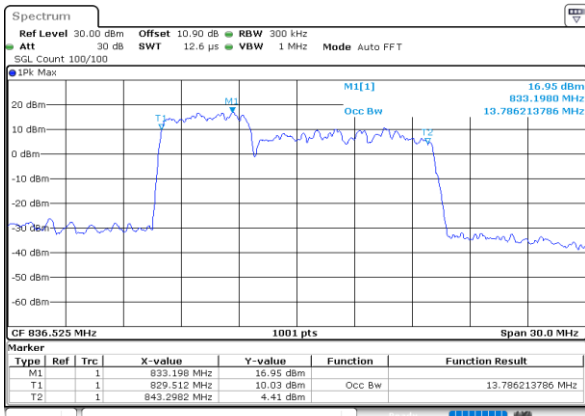

Date: 4.OCT.2020 13:19:25

Middle Channel / 10MHz+5MHz

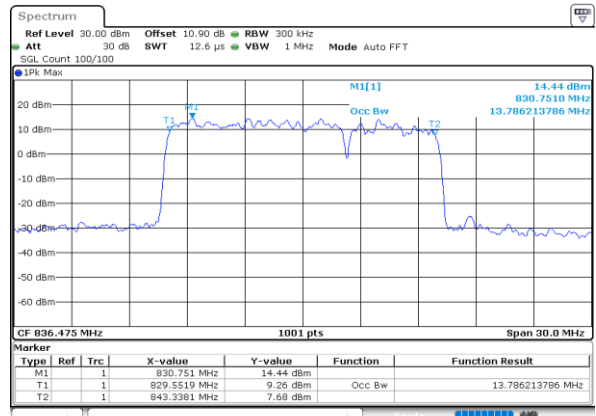

Date: 4.OCT.2020 15:22:00

Highest Channel / 5MHz+10MHz

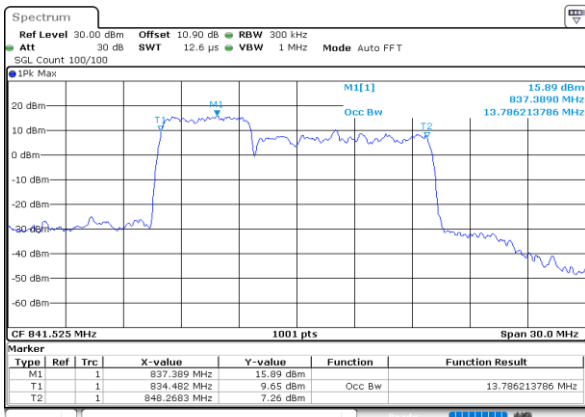

Date: 4.OCT.2020 13:51:08

Highest Channel / 10MHz+5MHz

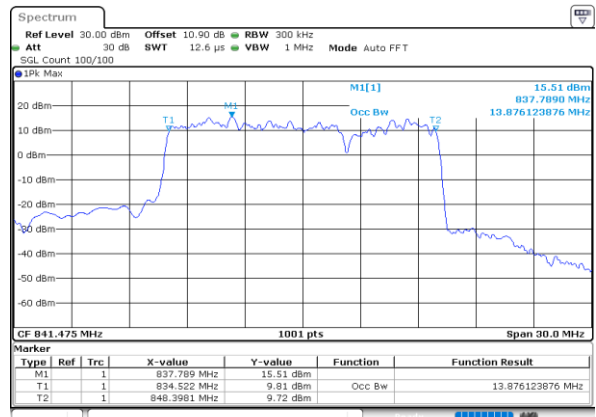

Date: 4.OCT.2020 15:33:25



LTE Band 5B

64QAM

Lowest Channel / 10MHz+10MHz

N/A

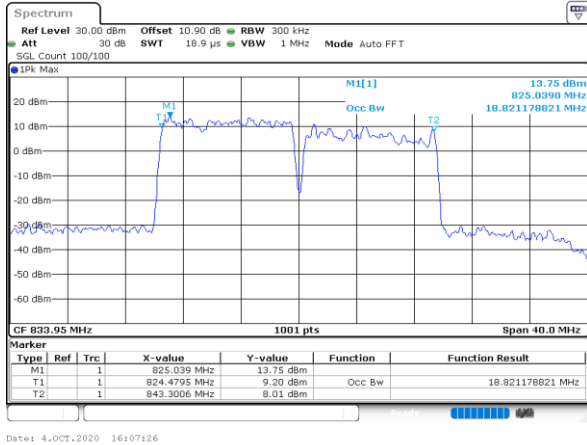

Middle Channel / 10MHz+10MHz

N/A

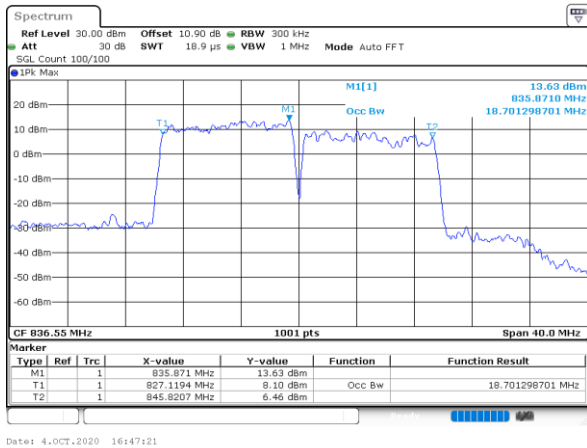

Highest Channel / 10MHz+10MHz

N/A

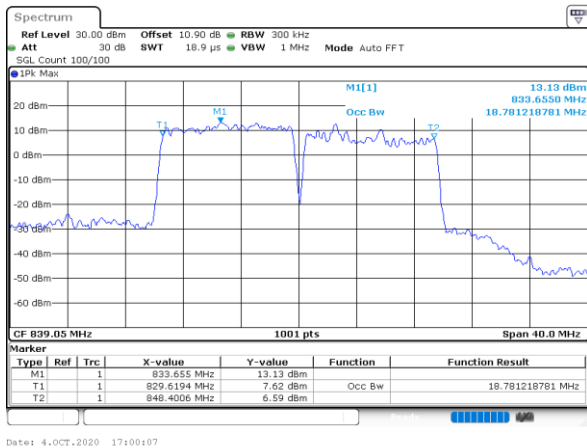



LTE Band 5B

256QAM

Lowest Channel / 5MHz+10MHz

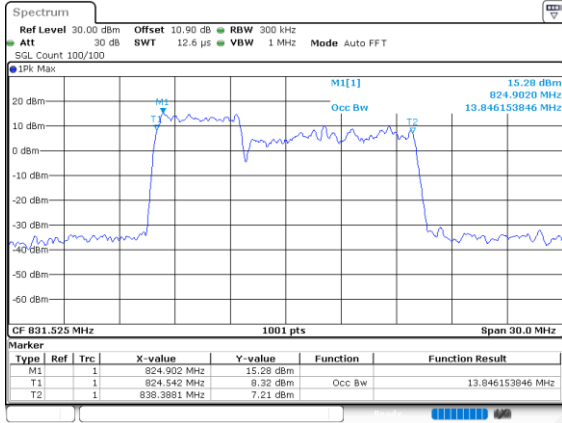

Date: 4.OCT.2020 13:03:32

Lowest Channel / 10MHz+5MHz

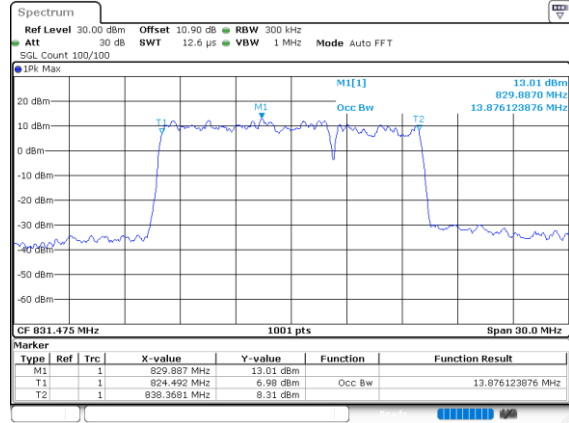

Date: 4.OCT.2020 14:29:24

Middle Channel / 5MHz+10MHz

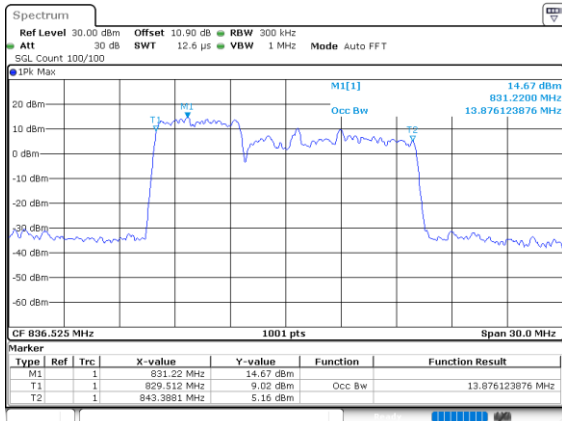

Date: 4.OCT.2020 13:39:48

Middle Channel / 10MHz+5MHz

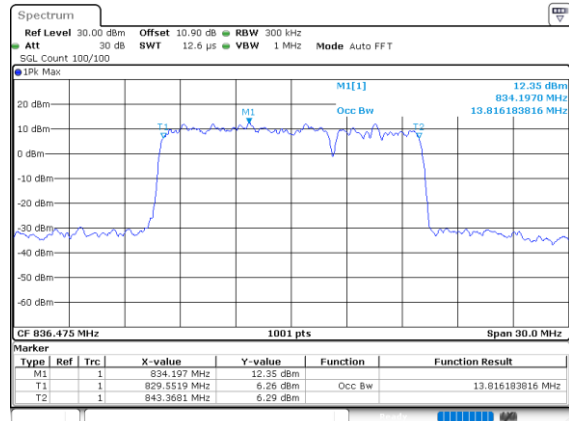

Date: 4.OCT.2020 15:22:23

Highest Channel / 5MHz+10MHz

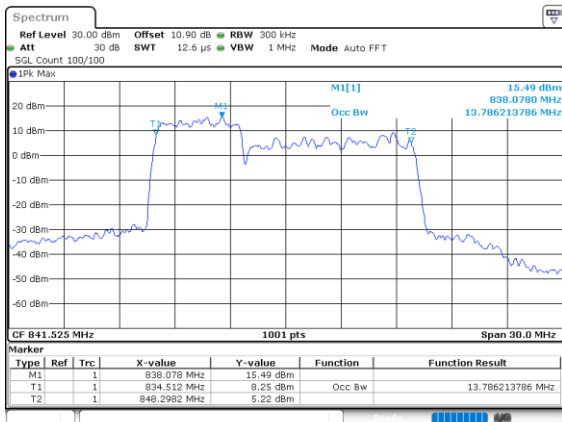

Date: 4.OCT.2020 13:50:45

Highest Channel / 10MHz+5MHz

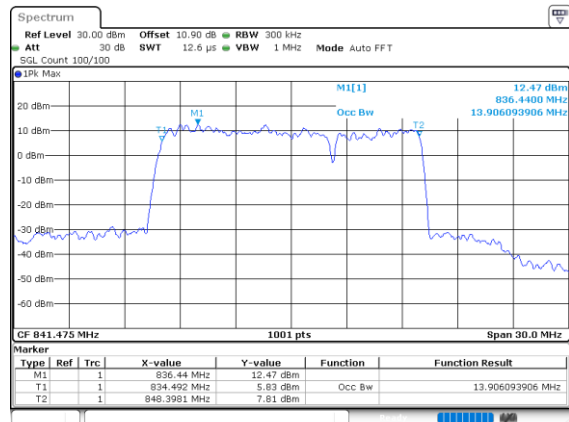

Date: 4.OCT.2020 15:33:02



LTE Band 5B

256QAM

Lowest Channel / 10MHz+10MHz

N/A

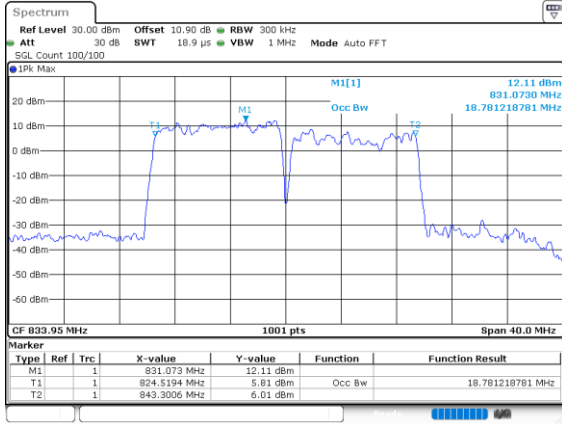

Date: 4.OCT.2020 16:07:48

Middle Channel / 10MHz+10MHz

N/A

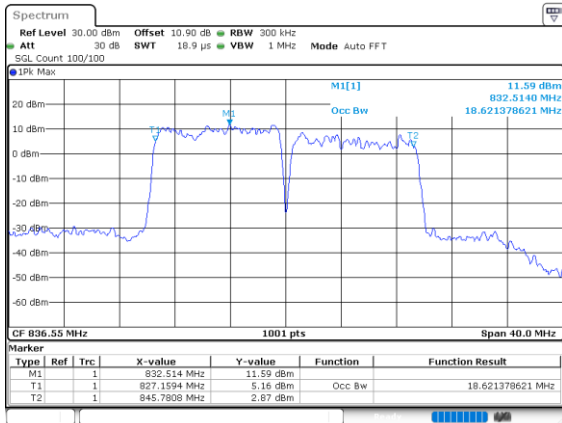

Date: 4.OCT.2020 16:47:43

Highest Channel / 10MHz+10MHz

N/A

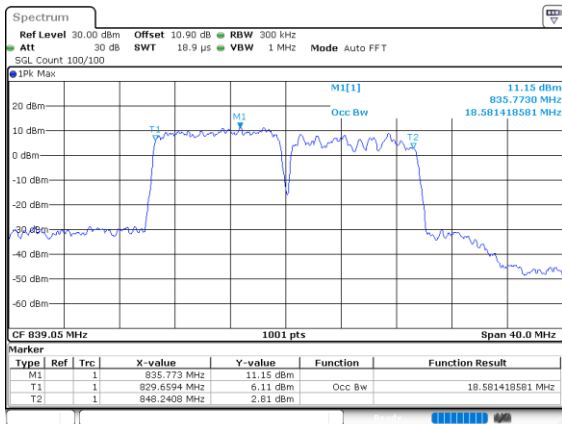

Date: 4.OCT.2020 16:59:44



Conducted Band Edge

LTE Band 5B / 5MHz+10MHz

QPSK

Lowest Band Edge / 1RB0 and 1RB49

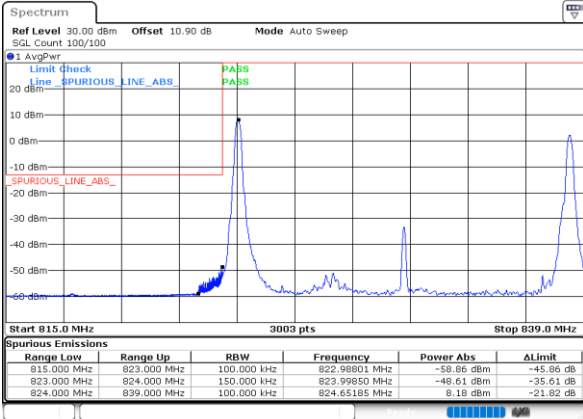

Highest Band Edge / 1RB0 and 1RB49

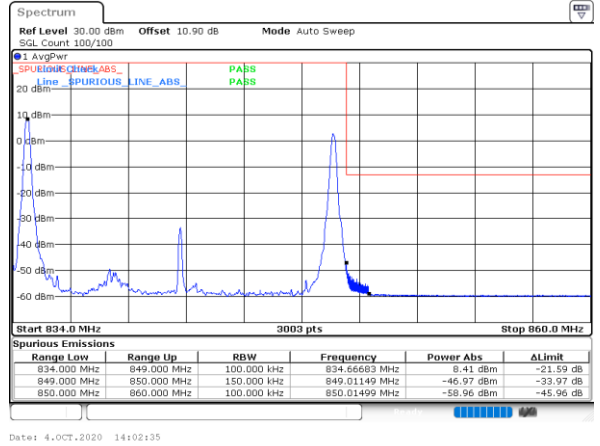

Lowest Band Edge / 1RB24 and 1RB0



Highest Band Edge / 1RB24 and 1RB0

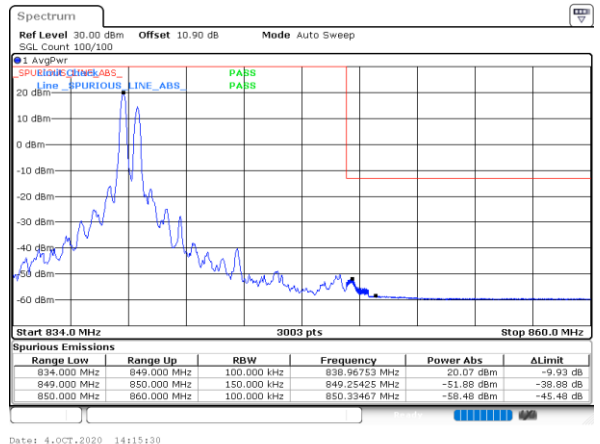

Lowest Band Edge / Full RB

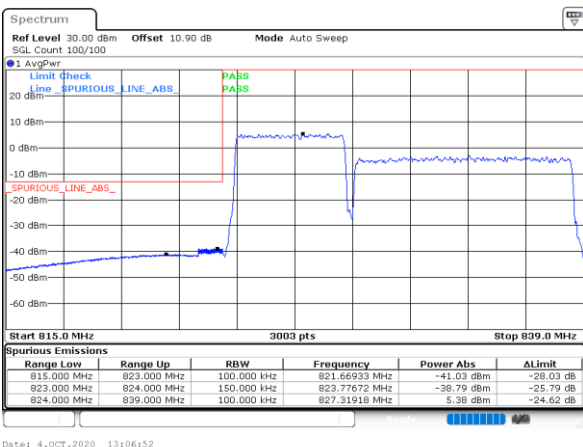

Highest Band Edge / Full RB

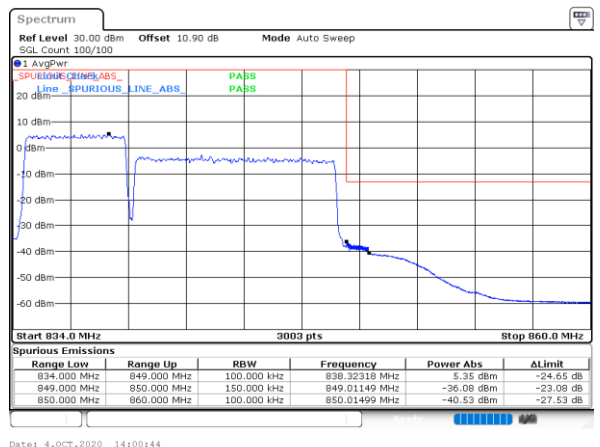



LTE Band 5B / 10MHz+5MHz

QPSK

Lowest Band Edge / 1RB0 and 1RB24

Highest Band Edge / 1RB0 and 1RB24

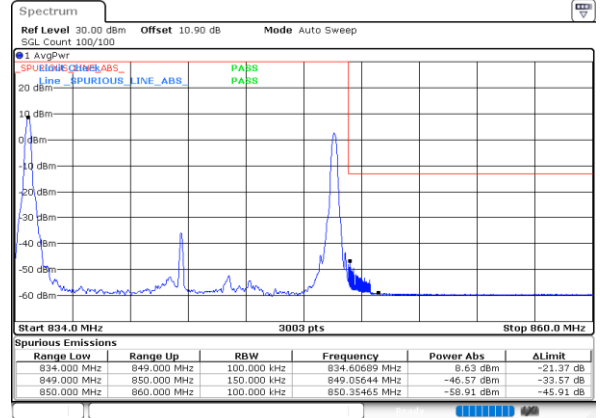
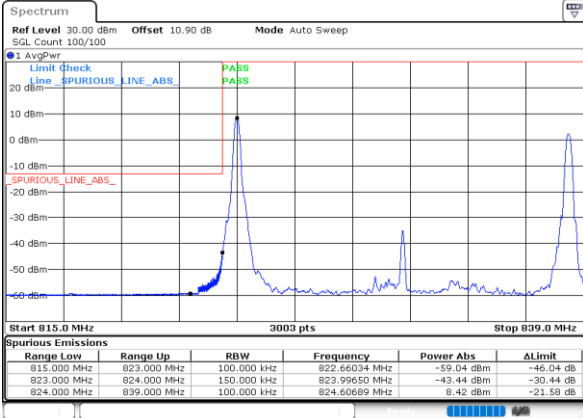

Lowest Band Edge / 1RB49 and 1RB0

Highest Band Edge / 1RB49 and 1RB0

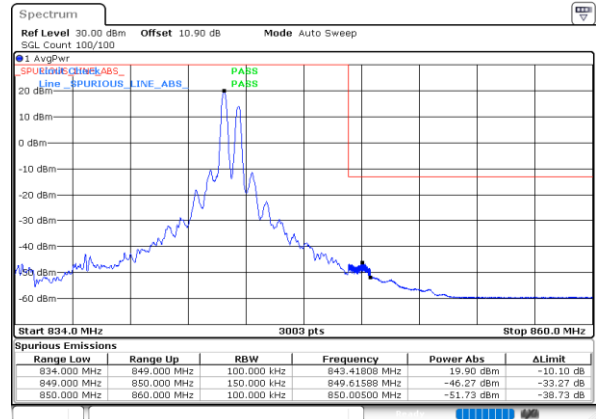

Lowest Band Edge / Full RB

Highest Band Edge / Full RB

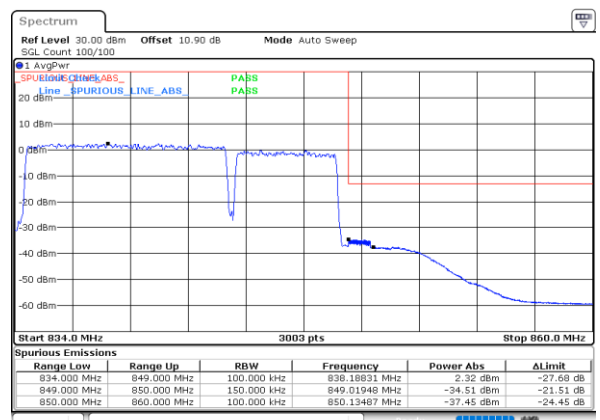
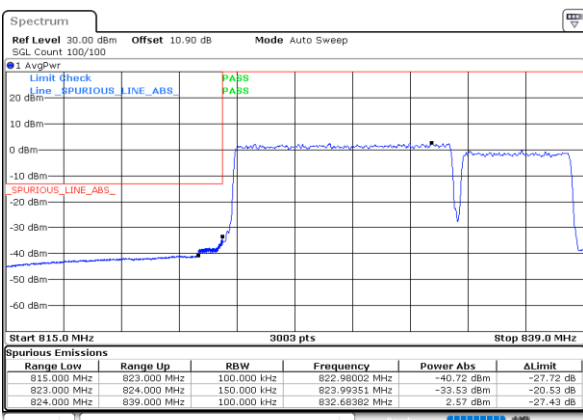



LTE Band 5B / 10MHz+10MHz

QPSK

Lowest Band Edge / 1RB0 and 1RB49

Highest Band Edge / 1RB0 and 1RB49

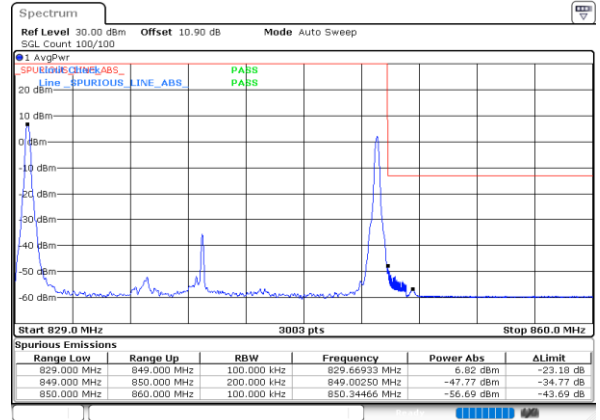
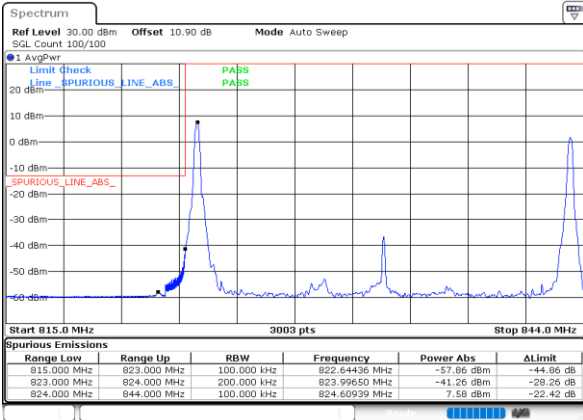

Lowest Band Edge / 1RB49 and 1RB0

Highest Band Edge / 1RB49 and 1RB0

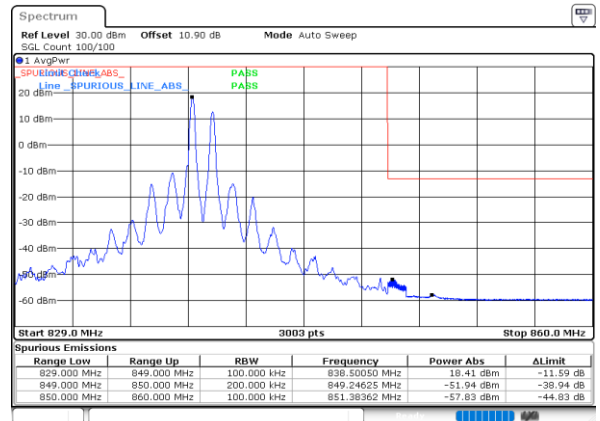
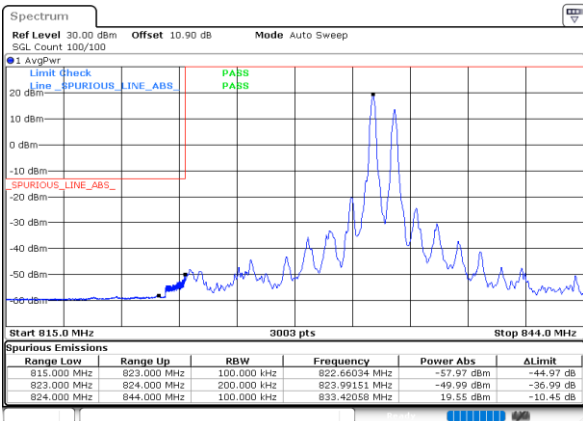

Lowest Band Edge / Full RB

Highest Band Edge / Full RB

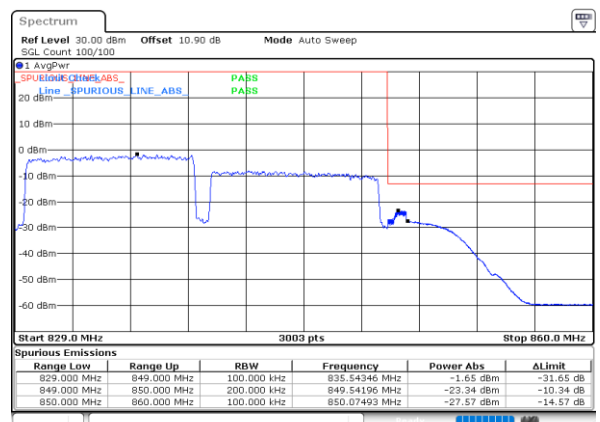
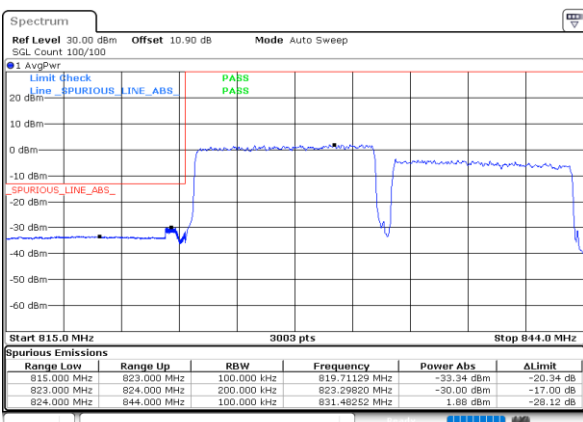



LTE Band 5B / 5MHz+10MHz

16QAM

Lowest Band Edge / 1RB0 and 1RB49

Highest Band Edge / 1RB0 and 1RB49

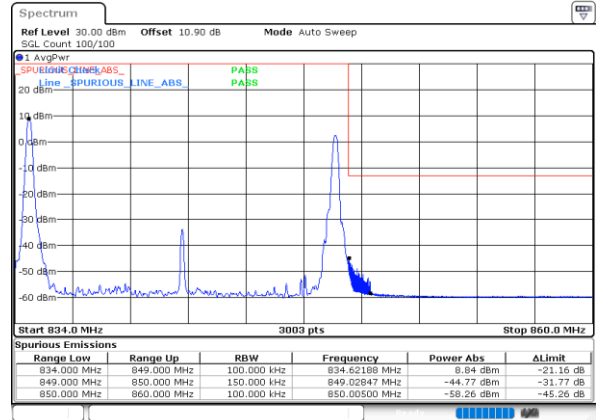
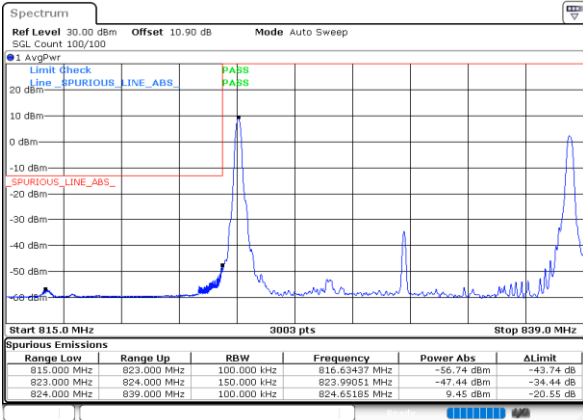

Lowest Band Edge / 1RB24 and 1RB0

Highest Band Edge / 1RB24 and 1RB0

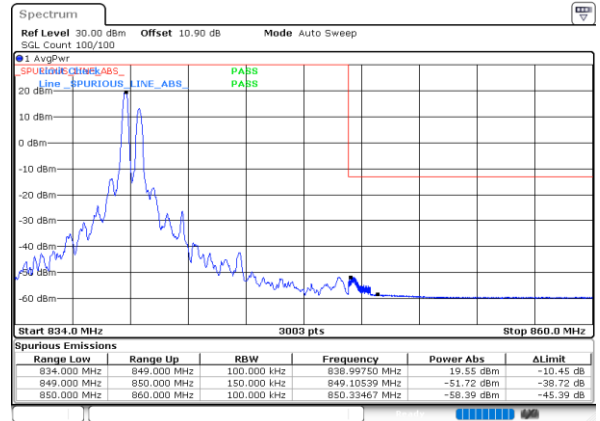
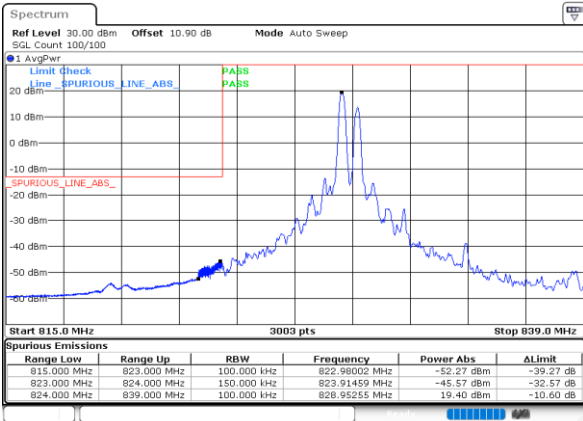

Lowest Band Edge / Full RB

Highest Band Edge / Full RB

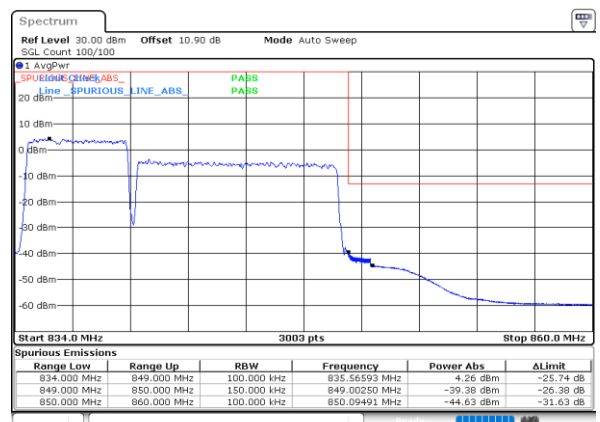
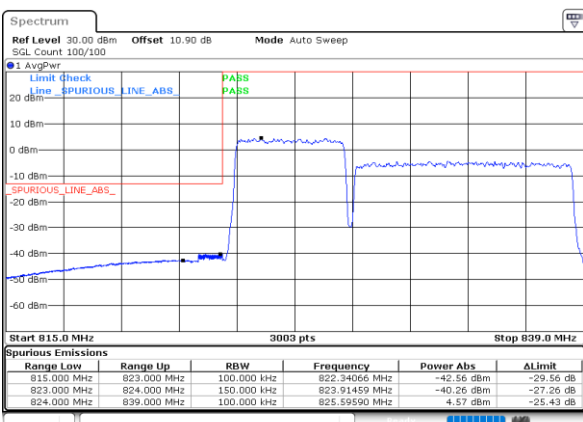



LTE Band 5B / 10MHz+5MHz

16QAM

Lowest Band Edge / 1RB0 and 1RB24

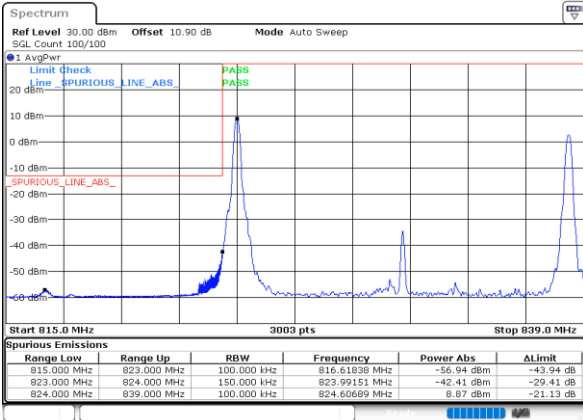

Highest Band Edge / 1RB0 and 1RB24

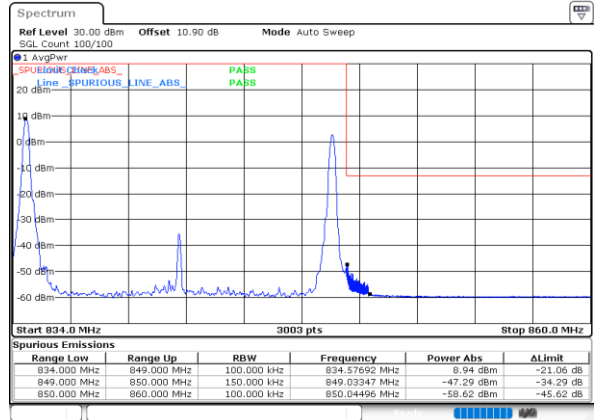

Lowest Band Edge / 1RB49 and 1RB0

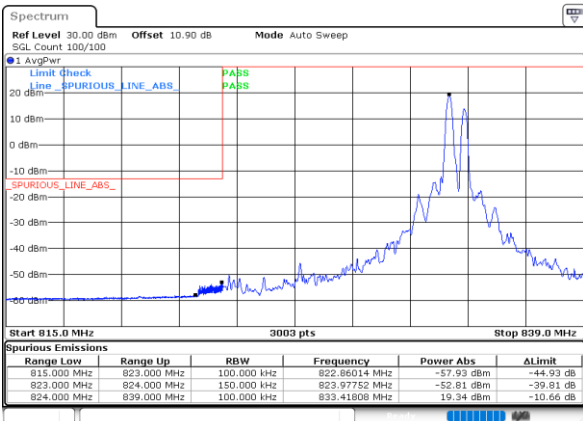

Highest Band Edge / 1RB49 and 1RB0

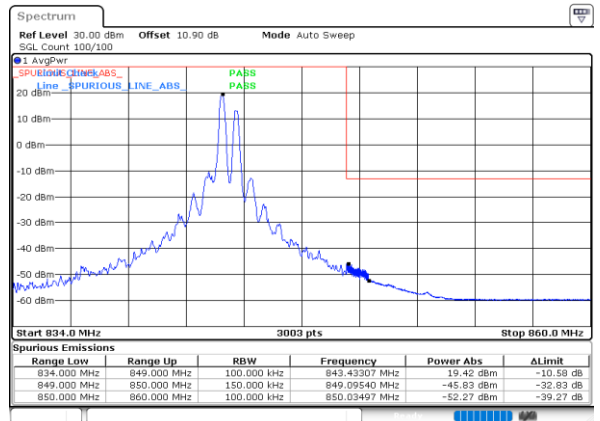

Lowest Band Edge / Full RB

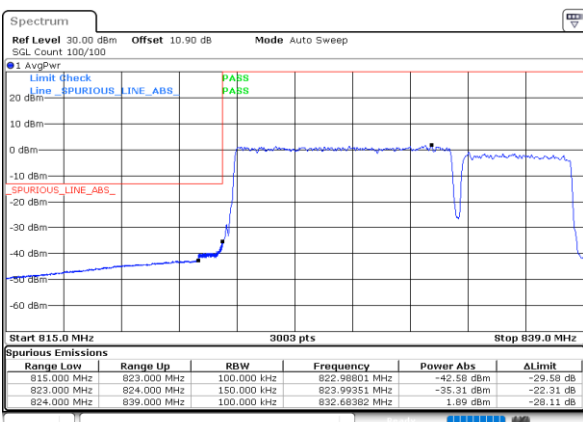

Highest Band Edge / Full RB

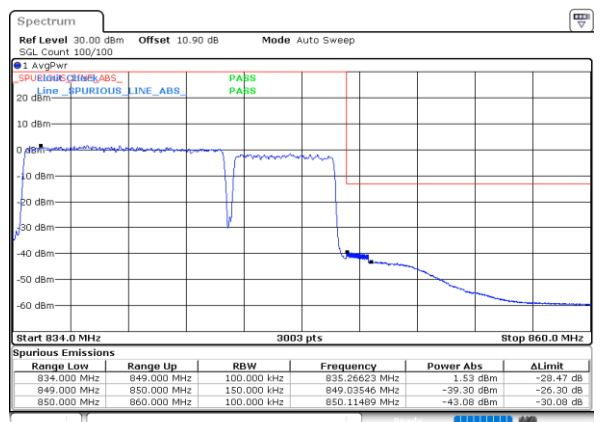



LTE Band 5B / 10MHz+10MHz

16QAM

Lowest Band Edge / 1RB0 and 1RB49

Highest Band Edge / 1RB0 and 1RB49

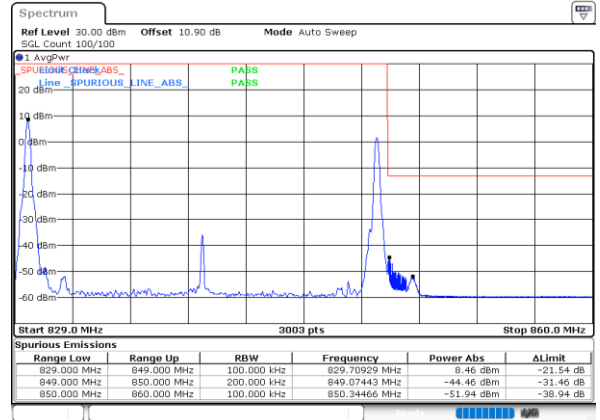
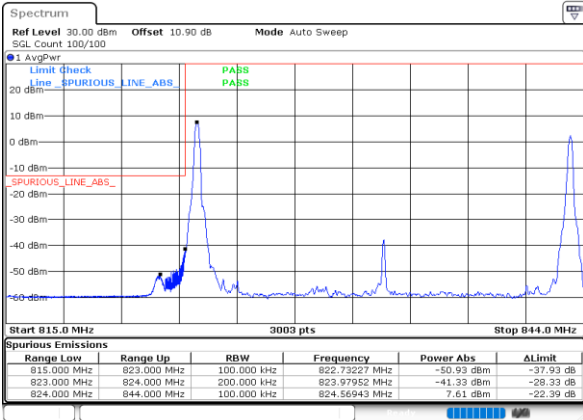

Date: 4.OCT.2020 16:22:14

Date: 4.OCT.2020 17:13:25

Lowest Band Edge / 1RB49 and 1RB0

Highest Band Edge / 1RB49 and 1RB0

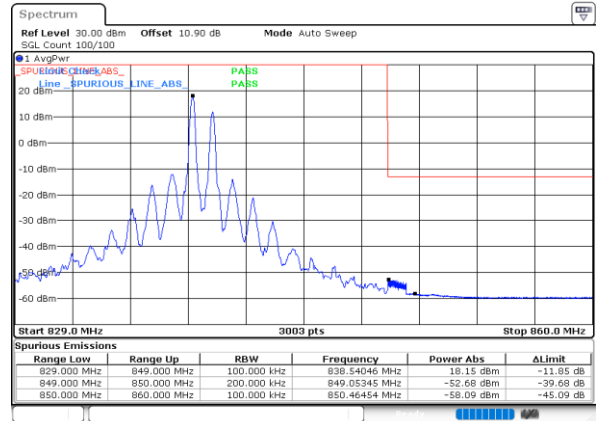
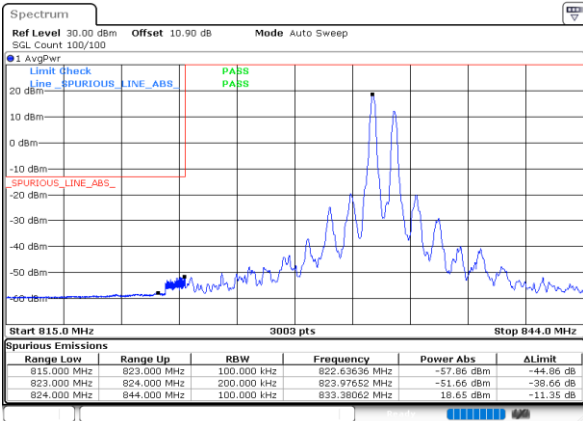

Date: 4.OCT.2020 16:27:47

Date: 4.OCT.2020 17:22:39

Lowest Band Edge / Full RB

Highest Band Edge / Full RB

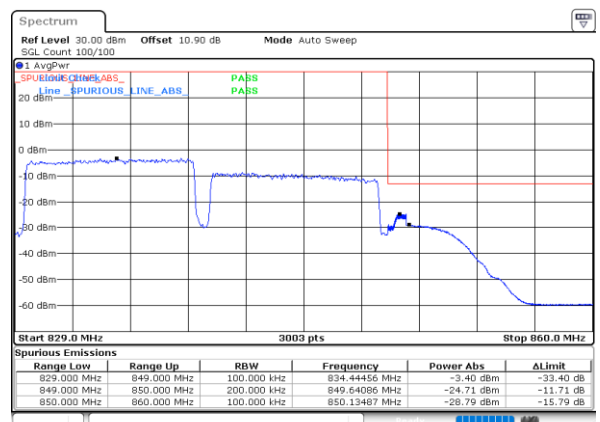
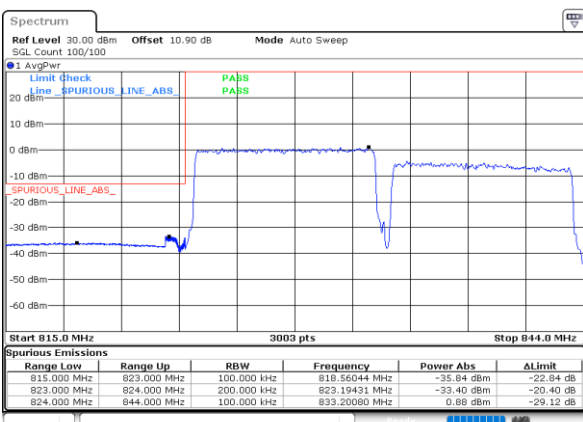

Date: 4.OCT.2020 16:12:59

Date: 4.OCT.2020 17:07:53



LTE Band 5B / 5MHz+10MHz

64QAM

Lowest Band Edge / 1RB0 and 1RB49

Highest Band Edge / 1RB0 and 1RB49

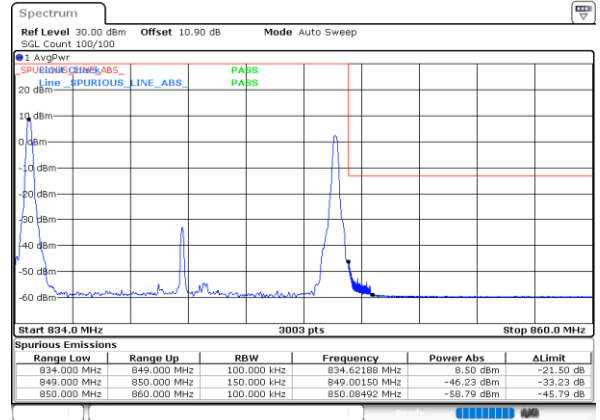
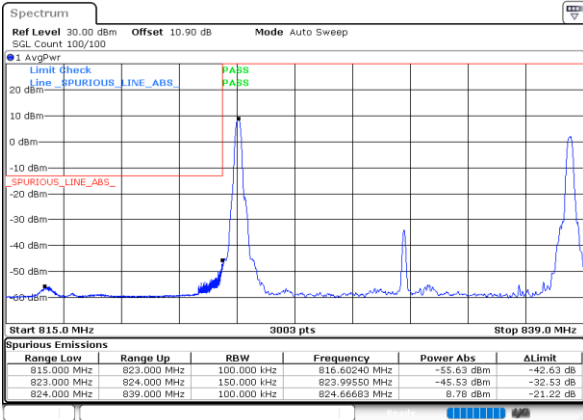

Lowest Band Edge / 1RB24 and 1RB0

Highest Band Edge / 1RB24 and 1RB0

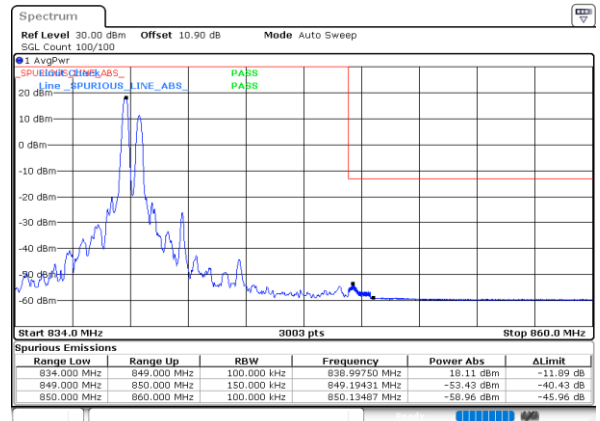
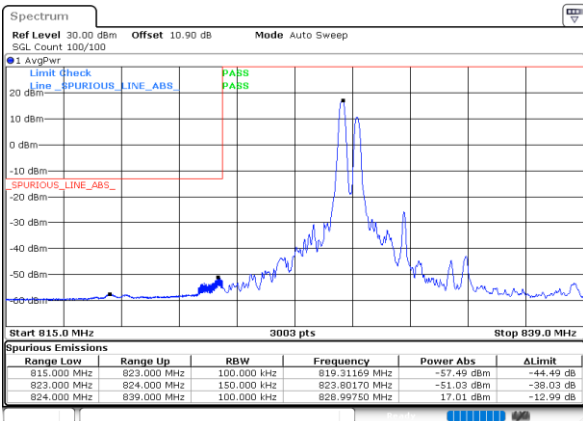

Lowest Band Edge / Full RB

Highest Band Edge / Full RB

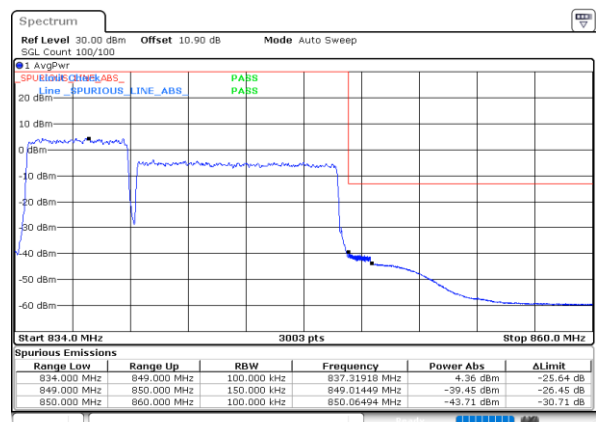
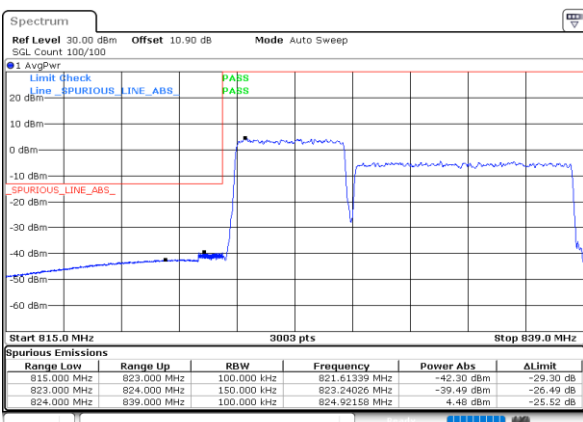



LTE Band 5B / 10MHz+5MHz

64QAM

Lowest Band Edge / 1RB0 and 1RB24

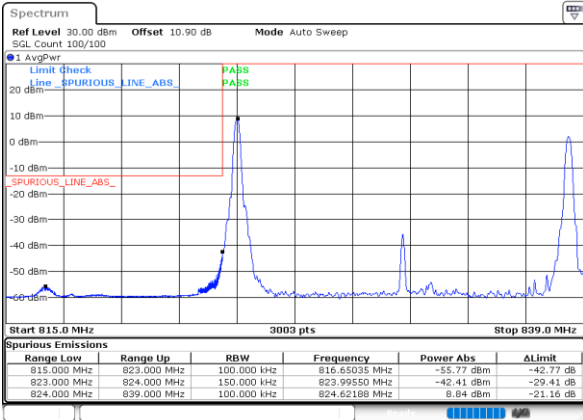

Highest Band Edge / 1RB0 and 1RB24

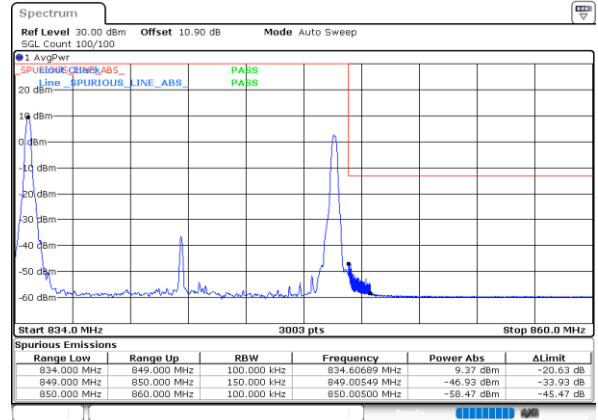

Lowest Band Edge / 1RB49 and 1RB0

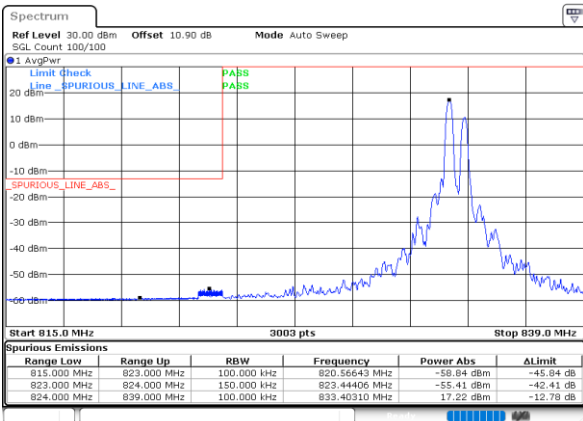

Highest Band Edge / 1RB49 and 1RB0

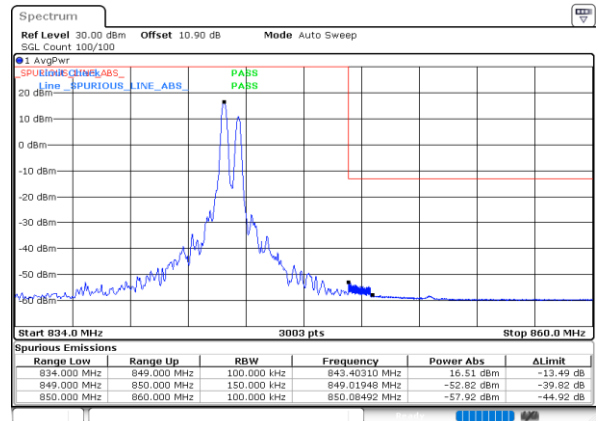

Lowest Band Edge / Full RB

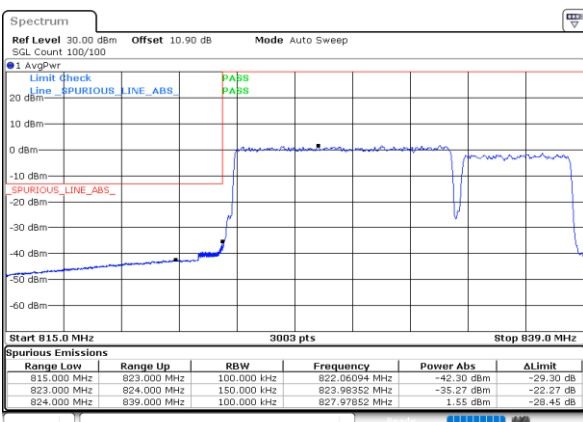

Highest Band Edge / Full RB

