

FCC Radio Test Report

FCC ID: PJZ24XXY1

This report concerns (check one): Original Grant Class I Change Class II Change

Project No. : 1612C280
Equipment : GPON 4 Port WiFi Gateway,
GE 4 Port WiFi Gateway
Model Name : (1) ZNID-GPON-2408A1, ZNID-GPON-2408A1-XX,
ZNID-GPON-2408A1-NYY,
ZNID-GPON-2408A1-XX-NYY, ZNID-GPON-2428A1,
ZNID-GPON-2428A1-XX, ZNID-GPON-2428A1-NYY,
ZNID-GPON-2428A1-XX-NYY
(2) ZNID-GE-2408A1, ZNID-GE-2408A1-XX,
ZNID-GE-2408A1-NYY, ZNID-GE-2408A1-XX-NYY,
ZNID-GE-2428A1, ZNID-GE-2428A1-XX,
ZNID-GE-2428A1-NYY, ZNID-GE-2428A1-XX-NYY
Applicant : DASAN Zhone Solutions, Inc.
Address : 7195 Oakport Street Oakland, CA 94621 USA

Date of Receipt : Dec. 28, 2016
Date of Test : Dec. 28, 2016 ~ Apr. 14, 2017
Issued Date : Apr. 17, 2017
Tested by : BTL Inc.

Testing Engineer : Shawn Xiao
(Shawn Xiao)
Technical Manager : David Mao
(David Mao)
Authorized Signatory : Steven Lu
(Steven Lu)

B T L I N C .

No.3, Jinshagang 1st Road, Shixia, Dalang Town, Dongguan,
Guangdong, China.

TEL: +86-769-8318-3000 FAX: +86-769-8319-6000

Declaration

BTL represents to the client that testing is done in accordance with standard procedures as applicable and that test instruments used has been calibrated with standards traceable to international standard(s) and/or national standard(s).

BTL's reports apply only to the specific samples tested under conditions. It is manufacture's responsibility to ensure that additional production units of this model are manufactured with the identical electrical and mechanical components. **BTL** shall have no liability for any declarations, inferences or generalizations drawn by the client or others from **BTL** issued reports.

BTL's report must not be used by the client to claim product certification, approval, or endorsement by NVLAP, NIST, or any agency of the Federal Government.

This report is the confidential property of the client. As a mutual protection to the clients, the public and **BTL-self**, extracts from the test report shall not be reproduced except in full with **BTL's** authorized written approval.

BTL's laboratory quality assurance procedures are in compliance with the **ISO Guide 17025** requirements, and accredited by the conformity assessment authorities listed in this test report.

Limitation

For the use of the authority's logo is limited unless the Test Standard(s)/Scope(s)/Item(s) mentioned in this test report is (are) included in the conformity assessment authorities acceptance respective.

Table of Contents

Page

1 . CERTIFICATION	6
2 . SUMMARY OF TEST RESULTS	7
2.1 TEST FACILITY	8
2.2 MEASUREMENT UNCERTAINTY	8
3 . GENERAL INFORMATION	9
3.1 GENERAL DESCRIPTION OF EUT	9
3.2 DESCRIPTION OF TEST MODES	11
3.3 TABLE OF PARAMETERS OF TEXT SOFTWARE SETTING	13
3.4 BLOCK DIAGRAM SHOWING THE CONFIGURATION OF SYSTEM TESTED	14
3.5 DESCRIPTION OF SUPPORT UNITS	14
4 . EMC EMISSION TEST	15
4.1 CONDUCTED EMISSION MEASUREMENT	15
4.1.1 POWER LINE CONDUCTED EMISSION LIMITS	15
4.1.2 TEST PROCEDURE	15
4.1.3 DEVIATION FROM TEST STANDARD	15
4.1.4 TEST SETUP	16
4.1.5 EUT OPERATING CONDITIONS	16
4.1.6 EUT TEST CONDITIONS	16
4.1.7 TEST RESULTS	16
4.2 RADIATED EMISSION MEASUREMENT	17
4.2.1 RADIATED EMISSION LIMITS	17
4.2.2 TEST PROCEDURE	18
4.2.3 DEVIATION FROM TEST STANDARD	18
4.2.4 TEST SETUP	19
4.2.5 EUT OPERATING CONDITIONS	20
4.2.6 EUT TEST CONDITIONS	20
4.2.7 TEST RESULTS (9KHZ TO 30MHZ)	20
4.2.8 TEST RESULTS (30MHZ TO 1000 MHZ)	20
4.2.9 TEST RESULTS (ABOVE 1000 MHZ)	20
5 . BANDWIDTH TEST	21
5.1 APPLIED PROCEDURES	21
5.1.1 TEST PROCEDURE	21
5.1.2 DEVIATION FROM STANDARD	21
5.1.3 TEST SETUP	21
5.1.4 EUT OPERATION CONDITIONS	21
5.1.5 EUT TEST CONDITIONS	21
5.1.6 TEST RESULTS	21
6 . MAXIMUM PEAK CONDUCTED OUTPUT POWER TEST	22

Table of Contents	Page
6.1 APPLIED PROCEDURES / LIMIT	22
6.1.1 TEST PROCEDURE	22
6.1.2 DEVIATION FROM STANDARD	22
6.1.3 TEST SETUP	22
6.1.4 EUT OPERATION CONDITIONS	22
6.1.5 EUT TEST CONDITIONS	22
6.1.6 TEST RESULTS	22
7 . ANTENNA CONDUCTED SPURIOUS EMISSION	23
7.1 APPLIED PROCEDURES / LIMIT	23
7.1.1 TEST PROCEDURE	23
7.1.2 DEVIATION FROM STANDARD	23
7.1.3 TEST SETUP	23
7.1.4 EUT OPERATION CONDITIONS	23
7.1.5 EUT TEST CONDITIONS	23
7.1.6 TEST RESULTS	23
8 . POWER SPECTRAL DENSITY TEST	24
8.1 APPLIED PROCEDURES / LIMIT	24
8.1.1 TEST PROCEDURE	24
8.1.2 DEVIATION FROM STANDARD	24
8.1.3 TEST SETUP	24
8.1.4 EUT OPERATION CONDITIONS	24
8.1.5 EUT TEST CONDITIONS	24
8.1.6 TEST RESULTS	24
9 . MEASUREMENT INSTRUMENTS LIST	25
10 . EUT TEST PHOTO	27
ATTACHMENT A - CONDUCTED EMISSION	31
ATTACHMENT B - RADIATED EMISSION (9KHZ TO 30MHZ)	36
ATTACHMENT C - RADIATED EMISSION (30MHZ TO 1000MHZ)	45
ATTACHMENT D - RADIATED EMISSION (ABOVE 1000MHZ)	58
ATTACHMENT E - BANDWIDTH	107
ATTACHMENT F – MAXIMUM PEAK CONDUCTED OUTPUT POWER	116
ATTACHMENT G - ANTENNA CONDUCTED SPURIOUS EMISSION	120
ATTACHMENT H - POWER SPECTRAL DENSITY	157

REPORT ISSUED HISTORY

Issued No.	Description	Issued Date
BTL-FCCP-1-1612C280	Original Issue.	Apr. 17, 2017

1. CERTIFICATION

Equipment : (1) GPON 4 Port WiFi Gateway,
GE 4 Port WiFi Gateway

Brand Name : 
DASAN Zhone Solutions

Model Name : (1) ZNID-GPON-2408A1, ZNID-GPON-2408A1-XX,
ZNID-GPON-2408A1-NYY, ZNID-GPON-2408A1-XX-NYY,
ZNID-GPON-2428A1, ZNID-GPON-2428A1-XX, ZNID-GPON-2428A1-NYY,
ZNID-GPON-2428A1-XX-NYY
(2) ZNID-GE-2408A1, ZNID-GE-2408A1-XX, ZNID-GE-2408A1-NYY, ZNID-
GE-2408A1-XX-NYY, ZNID-GE-2428A1, ZNID-GE-2428A1-XX, ZNID-
GE-2428A1-NYY, ZNID-GE-2428A1-XX-NYY

Applicant : DASAN Zhone Solutions, Inc.

Manufacturer : DASAN Zhone Solutions, Inc.

Address : 7195 Oakport Street Oakland, CA 94621 USA

Date of Test : Dec. 28, 2016 ~ Apr. 14, 2017

Test Sample : Engineering Sample

Standard(s) : FCC Part15, Subpart C:(15.247) / ANSI C63.10-2013

The above equipment has been tested and found compliance with the requirement of the relative standards by BTL Inc.

The test data, data evaluation, and equipment configuration contained in our test report (Ref No. BTL-FCCP-1-1612C280) were obtained utilizing the test procedures, test instruments, test sites that has been accredited by the Authority of TAF according to the ISO-17025 quality assessment standard and technical standard(s).

2. SUMMARY OF TEST RESULTS

Test procedures according to the technical standard(s):

Applied Standard(s): FCC Part15 (15.247) , Subpart C			
Standard(s) Section	Test Item	Judgment	Remark
15.207	Conducted Emission	PASS	
15.247(d)	Antenna conducted Spurious Emission	PASS	
15.247(a)(2)	6dB Bandwidth	PASS	
15.247(b)(3)	Peak Output Power	PASS	
15.247(e)	Power Spectral Density	PASS	
15.203	Antenna Requirement	PASS	
15.247(d)/15.205/15.209	Transmitter Radiated Emissions	PASS	

Note:

(1) "N/A" denotes test is not applicable in this test report.

2.1 TEST FACILITY

The test facilities used to collect the test data in this report is at the location of No.3,Jinshagang 1st Road, Shixia, Dalang Town, Dongguan, Guangdong, China.
 BTL's test firm number for FCC: 319330

2.2 MEASUREMENT UNCERTAINTY

Where relevant, the following measurement uncertainty levels have been estimated for tests performed on the EUT as specified in CISPR 16-4-2. The BTL measurement uncertainty is less than the CISPR 16-4-2 U_{cispr} requirement.

The reported uncertainty of measurement $y \pm U$, where expanded uncertainty U is based on a standard uncertainty multiplied by a coverage factor of $k=2$, providing a level of confidence of approximately 95 %.

A. Conducted Measurement:

Test Site	Method	Measurement Frequency Range	U, (dB)
DG-C02	CISPR	150 KHz ~ 30MHz	2.32

B. Radiated Measurement:

Test Site	Method	Measurement Frequency Range	Ant. H / V	U, (dB)
DG-CB03	CISPR	9KHz~30MHz	V	3.79
		9KHz~30MHz	H	3.57
		30MHz ~ 200MHz	V	3.82
		30MHz ~ 200MHz	H	3.78
		200MHz ~ 1,000MHz	V	4.10
		200MHz ~ 1,000MHz	H	4.06
		1GHz~18GHz	V	3.12
		1GHz~18GHz	H	3.68
		18GHz~40GHz	V	4.15
		18GHz~40GHz	H	4.14

Note: Unless specifically mentioned, the uncertainty of measurement has not been taken into account to declare the compliance or non-compliance to the specification.

3. GENERAL INFORMATION

3.1 GENERAL DESCRIPTION OF EUT

Equipment	GPON 4 Port WiFi Gateway, GE 4 Port WiFi Gateway		
Brand Name	 DZS DASAN Zhong Solutions		
Model Name	(1) ZNID-GPON-2408A1, ZNID-GPON-2408A1-XX, ZNID-GPON-2408A1-NYY, ZNID-GPON-2408A1-XX-NYY, ZNID-GPON-2428A1, ZNID-GPON-2428A1-XX, ZNID-GPON-2428A1-NYY, ZNID-GPON-2428A1-XX-NYY (2) ZNID-GE-2408A1, ZNID-GE-2408A1-XX, ZNID-GE-2408A1-NYY, ZNID-GE-2408A1-XX-NYY, ZNID-GE-2428A1, ZNID-GE-2428A1-XX, ZNID-GE-2428A1-NYY, ZNID-GE-2428A1-XX-NYY		
Model Difference	“XX”= NA, EU, UK, SG, blank, which indicates the power adapter plug type, For the optional “NYY” used only in Customer-specific configurations, “N” identifies the Revision number of the configuration from 0 to 9 or blank, and “YY” specifies the customer using a unique two letter identifier from A to Z or blank, please refer to note 3 for other different.		
Product Description	Operation Frequency	2412~2462 MHz	
	Modulation Technology	802.11b:DSSS 802.11g:OFDM 802.11n:OFDM	
	Bit Rate of Transmitter	802.11b: 11/5.5/2/1 Mbps 802.11g:54/48/36/24/18/12/9/6 Mbps 802.11n up to 300 Mbps	
	Output Power (Max.)	802.11b:23.32dBm 802.11g:27.69dBm 802.11n(20MHz):28.93dBm 802.11n(40MHz):28.46dBm	
Power Source	Supplied from adapter. Model: SOY-1200200US Model: S24B72-120A200-C4		
Power Rating	DC 12V 2A		

Note:

- For a more detailed features description, please refer to the manufacturer’s specifications or the user’s manual.
- Channel List:

CH01 – CH11 for 802.11b, 802.11g, 802.11n(20MHz)							
CH03 – CH09 for 802.11n(40MHz)							
Channel	Frequency (MHz)	Channel	Frequency (MHz)	Channel	Frequency (MHz)	Channel	Frequency (MHz)
01	2412	04	2427	07	2442	10	2457
02	2417	05	2432	08	2447	11	2462
03	2422	06	2437	09	2452		

3. Differ in below table:

Model Name	Equipment	Funtion	Other
ZNID-GPON-2408A1, ZNID-GPON-2408A1-XX, ZNID-GPON-2408A1-NYY, ZNID-GPON-2408A1-XX-NYY	GPON 4 Port WiFi Gateway	GPON ONT, 4 GE, 1 USB, 2x2 b/g/n (100mW+), 3x3 a/n/ac (250mW+)	Without voice function, 2.4G(2T2R) 5G(3T3R)
ZNID-GE-2408A1, ZNID-GE-2408A1-XX, ZNID-GE-2408A1-NYY, ZNID-GE-2408A1-XX-NYY	GE 4 Port WiFi Gateway	GE P2P ONT, 4 GE, 1 USB, 2x2 b/g/n (100mW+), 3x3 a/n/ac (250mW+)	Without voice function, 2.4G(2T2R) 5G(3T3R),P2P
ZNID-GPON-2428A1, ZNID-GPON-2428A1-XX, ZNID-GPON-2428A1-NYY, ZNID-GPON-2428A1-XX-NYY	GPON 4 Port WiFi Gateway	GPON ONT, 4 GE, 2FXS, 1 USB, 2x2 b/g/n (100mW+), 3x3 a/n/ac (250mW+)	With USB, voice function 2.4G(2T2R) 5G(3T3R)
ZNID-GE-2428A1, ZNID-GE-2428A1-XX, ZNID-GE-2428A1-NYY, ZNID-GE-2428A1-XX-NYY	GE 4 Port WiFi Gateway	GE P2P ONT, 4 GE, 2FXS,1 USB, 2x2 b/g/n (100mW+), 3x3 a/n/ac (250mW+)	With USB, voice function 2.4G(2T2R) 5G(3T3R),P2P

3. Table for Filed Antenna

Ant.	Brand	Model Name	Antenna Type	Connector	Gain (dBi)
1	N/A	N/A	PCB	IPEX	3
2	N/A	N/A	PCB	IPEX	3

Note:

This EUT supports MIMO 2X2, any transmit signals are correlated with each other,
So Directional gain = $G_{ANT} + 10\log(N)$ dBi, that is Directional gain = $3 + 10\log(2)$ dBi = 7.77; So,
the out power limit is $30 - 6.01 + 6 = 29.99$, the power density limit is $8 - 6.01 + 6 = 7.99$.

When Directional antenna gain is larger than 6dBi, for every 1 dBi increase in gain, the power limit and power density limit is reduced by 1 dBm.

3.2 DESCRIPTION OF TEST MODES

To investigate the maximum EMI emission characteristics generates from EUT, the test system was pre-scanning tested base on the consideration of following EUT operation mode or test configuration mode which possible have effect on EMI emission level. Each of these EUT operation mode(s) or test configuration mode(s) mentioned above was evaluated respectively.

Pretest Mode	Description
Mode 1	TX B MODE CHANNEL 01/06/11
Mode 2	TX G MODE CHANNEL 01/06/11
Mode 3	TX N-20MHZ MODE CHANNEL 01/06/11
Mode 4	TX N-40MHZ MODE CHANNEL 03/06/09
Mode 5	TX Mode

The EUT system operated these modes were found to be the worst case during the pre-scanning test as following:

For Conducted Test	
Final Test Mode	Description
Mode 5	TX Mode

For Radiated Test	
Final Test Mode	Description
Mode 1	TX B MODE CHANNEL 01/06/11
Mode 2	TX G MODE CHANNEL 01/06/11
Mode 3	TX N-20MHZ MODE CHANNEL 01/06/11
Mode 4	TX N-40MHZ MODE CHANNEL 03/06/09

For Band Edge Test	
Final Test Mode	Description
Mode 1	TX B MODE CHANNEL 01/06/11
Mode 2	TX G MODE CHANNEL 01/06/11
Mode 3	TX N-20MHZ MODE CHANNEL 01/06/11
Mode 4	TX N-40MHZ MODE CHANNEL 03/06/09

6dB Spectrum Bandwidth	
Final Test Mode	Description
Mode 1	TX B MODE CHANNEL 01/06/11
Mode 2	TX G MODE CHANNEL 01/06/11
Mode 3	TX N-20MHZ MODE CHANNEL 01/06/11
Mode 4	TX N-40MHZ MODE CHANNEL 03/06/09

Maximum Conducted Output Power	
Final Test Mode	Description
Mode 1	TX B MODE CHANNEL 01/06/11
Mode 2	TX G MODE CHANNEL 01/06/11
Mode 3	TX N-20MHZ MODE CHANNEL 01/06/11
Mode 4	TX N-40MHZ MODE CHANNEL 03/06/09

Power Spectral Density	
Final Test Mode	Description
Mode 1	TX B MODE CHANNEL 01/06/11
Mode 2	TX G MODE CHANNEL 01/06/11
Mode 3	TX N-20MHZ MODE CHANNEL 01/06/11
Mode 4	TX N-40MHZ MODE CHANNEL 03/06/09

Note:

- (1) The measurements are performed at the high, middle, low available channels.
- (2) 802.11b mode: DBPSK (1Mbps)
 802.11g mode: OFDM (6Mbps)
 802.11n HT20 mode : BPSK (13Mbps)
 802.11n HT40 mode : BPSK (27Mbps)
 For radiated emission tests, the highest output powers were set for final test.
- (3) For radiated below 1G test, the 802.11b is found to be the worst case and recorded.
- (4) The EUT was programmed to be in continuously transmitting mode and the transmit duty cycle is not less than 98%.

3.3 TABLE OF PARAMETERS OF TEXT SOFTWARE SETTING

During testing, channel & power controlling software provided by the customer was used to control the operating channel as well as the output power level. The RF output power selection is for the setting of RF output power expected by the customer and is going to be fixed on the firmware of the final end product power parameters of WLAN

Test software version	MTool_2.0.1.1		
Frequency (MHz)	2412	2437	2462
802.11b	54	65	67
802.11g	52	74	46
802.11n (20MHz)	48	50	44
Frequency	2422	2437	2452
802.11n (40MHz)	42	56	40

3.4 BLOCK DIAGRAM SHOWING THE CONFIGURATION OF SYSTEM TESTED

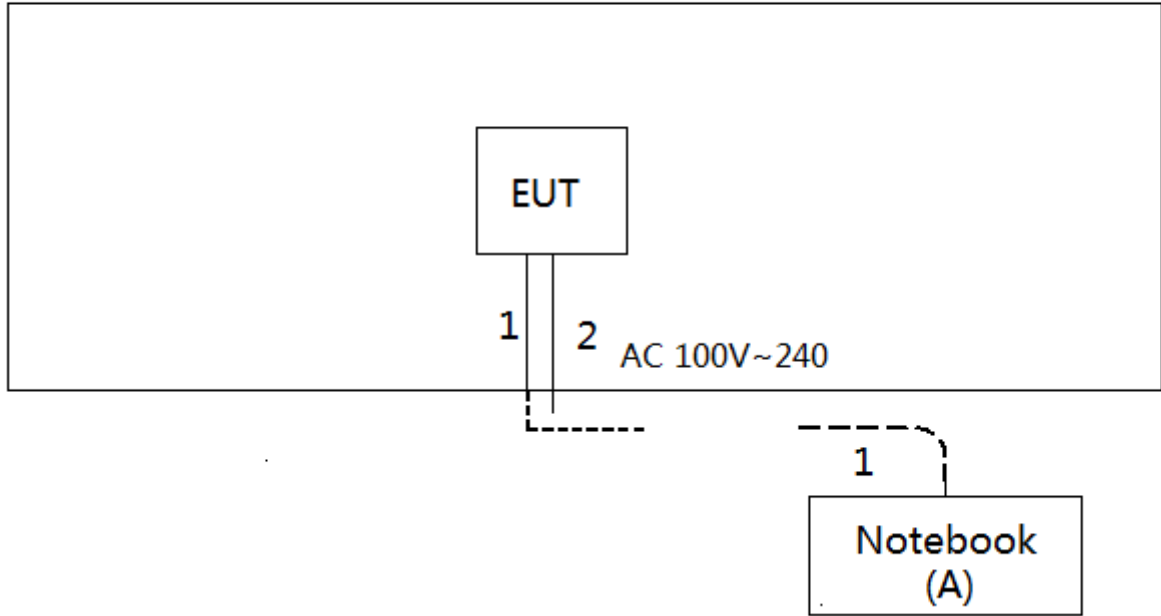

3.5 DESCRIPTION OF SUPPORT UNITS

The EUT has been tested as an independent unit together with other necessary accessories or support units. The following support units or accessories were used to form a representative test configuration during the tests.

Item	Equipment	Mfr/Brand	Model/Type No.	FCC ID	Series No.
A	Notebook	Dell	DCSM 745	DOC	G7K832X

Item	Shielded Type	Ferrite Core	Length	Note
1	NO	NO	10m	RJ45 Cable
2	NO	NO	1.2m	Power Cable

4. EMC EMISSION TEST

4.1 CONDUCTED EMISSION MEASUREMENT

4.1.1 POWER LINE CONDUCTED EMISSION LIMITS (Frequency Range 150KHz-30MHz)

Frequency of Emission (MHz)	Conducted Limit (dBμV)	
	Quasi-peak	Average
0.15 -0.50	66 to 56*	56 to 46*
0.50 -5.0	56	46
5.0 -30.0	60	50

Note:

- (1) The limit of " * " decreases with the logarithm of the frequency
- (2) The test result calculated as following:
 Measurement Value = Reading Level + Correct Factor
 Correct Factor = Insertion Loss + Cable Loss + Attenuator Factor(if use)
 Margin Level = Measurement Value - Limit Value

The following table is the setting of the receiver

Receiver Parameters	Setting
Attenuation	10 dB
Start Frequency	0.15 MHz
Stop Frequency	30 MHz
IF Bandwidth	9 KHz

4.1.2 TEST PROCEDURE

- a. The EUT was placed 0.8 meters from the horizontal ground plane with EUT being connected to the power mains through a line impedance stabilization network (LISN). All other support equipments powered from additional LISN(s). The LISN provide 50 Ohm/ 50uH of coupling impedance for the measuring instrument.
- b. Interconnecting cables that hang closer than 40 cm to the ground plane shall be folded back and forth in the center forming a bundle 30 to 40 cm long.
- c. I/O cables that are not connected to a peripheral shall be bundled in the center. The end of the cable may be terminated, if required, using the correct terminating impedance. The overall length shall not exceed 1 m.
- d. LISN at least 80 cm from nearest part of EUT chassis.
- e. For the actual test configuration, please refer to the related Item –EUT Test Photos.

4.1.3 DEVIATION FROM TEST STANDARD

No deviation

4.1.4 TEST SETUP

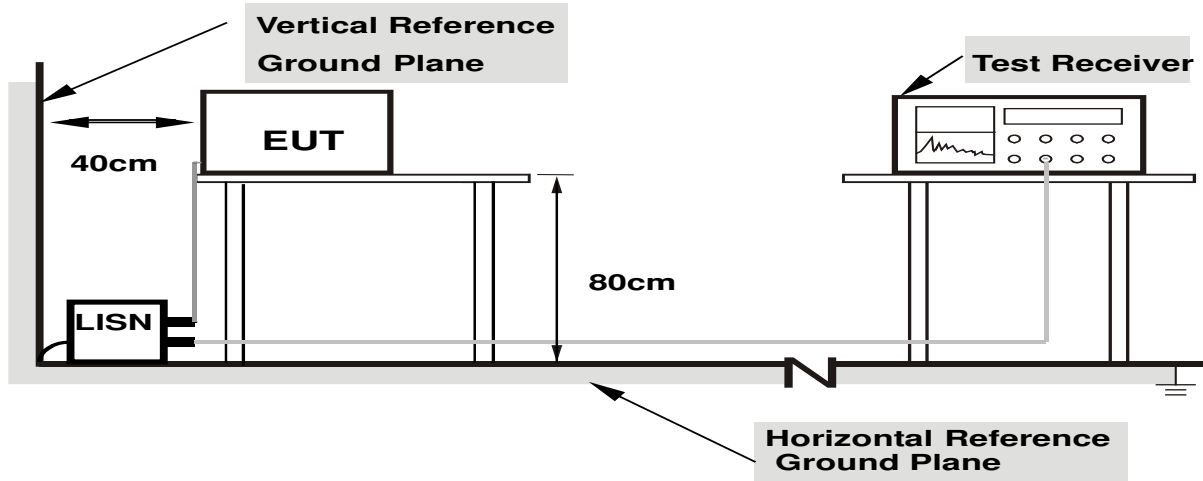

- Note:**
1. Support units were connected to second LISN.
 2. Both of LISNs (AMN) are 80 cm from EUT and at least 80 from other units and other metal planes

4.1.5 EUT OPERATING CONDITIONS

The EUT was placed on the test table and programmed in normal function.

4.1.6 EUT TEST CONDITIONS

Temperature: 25°C Relative Humidity: 55% Test Voltage: AC 120V/60Hz

4.1.7 TEST RESULTS

Please refer to the Attachment A.

4.2 RADIATED EMISSION MEASUREMENT

4.2.1 RADIATED EMISSION LIMITS

In case the emission fall within the restricted band specified on 15.205(a), then the 15.209(a) limit in the table below has to be followed.

LIMITS OF RADIATED EMISSION MEASUREMENT (9KHz-1000MHz)

Frequency (MHz)	Field Strength (microvolts/meter)	Measurement Distance (meters)
0.009~0.490	2400/F(KHz)	300
0.490~1.705	24000/F(KHz)	30
1.705~30.0	30	30
30~88	100	3
88~216	150	3
216~960	200	3
960~1000	500	3

LIMITS OF RADIATED EMISSION MEASUREMENT (Above 1000MHz)

Frequency (MHz)	(dBuV/m) (at 3 meters)	
	PEAK	AVERAGE
Above 1000	74	54

Notes:

- (1) The limit for radiated test was performed according to FCC PART 15C.
- (2) The tighter limit applies at the band edges.
- (3) Emission level (dBuV/m)=20log Emission level (uV/m).
- (4) The test result calculated as following:
 Measurement Value = Reading Level + Correct Factor
 Correct Factor = Antenna Factor + Cable Loss - Amplifier Gain(if use)
 Margin Level = Measurement Value - Limit Value

Spectrum Parameter	Setting
Attenuation	Auto
Start Frequency	1000 MHz
Stop Frequency	10th carrier harmonic
RBW / VBW (Emission in restricted band)	1MHz / 3MHz for Peak, 1MHz / 1/T for Average

Receiver Parameter	Setting
Attenuation	Auto
Start ~ Stop Frequency	9KHz~90KHz for PK/AVG detector
Start ~ Stop Frequency	90KHz~110KHz for QP detector
Start ~ Stop Frequency	110KHz~490KHz for PK/AVG detector
Start ~ Stop Frequency	490KHz~30MHz for QP detector
Start ~ Stop Frequency	30MHz~1000MHz for QP detector

4.2.2 TEST PROCEDURE

- a. The measuring distance of 3 m shall be used for measurements. The EUT was placed on the top of a rotating table 0.8 meter above the ground at a 3 meter semi-anechoic chamber. The table was rotated 360 degrees to determine the position of the highest radiation.(below 1GHz)
- b. The measuring distance of 3 m shall be used for measurements. The EUT was placed on the top of a rotating table 1.5 meter above the ground at a 3 meter semi-anechoic chamber. The table was rotated 360 degrees to determine the position of the highest radiation.(above 1GHz)
- c. The height of the equipment or of the substitution antenna shall be 0.8m or 1.5m; the height of the test antenna shall vary between 1 m to 4 m. Both horizontal and vertical polarizations of the antenna are set to make the measurement.
- d. For each suspected emission, the EUT was arranged to its worst case and then the antenna was tuned to heights find the maximum reading (used Bore sight function).
- e. The receiver system was set to peak and average detect function and specified bandwidth with maximum hold mode when the test frequency is above 1GHz.
- f. The initial step in collecting radiated emission data is a receiver peak detector mode pre-scanning the measurement frequency range. Significant peaks are then marked and then Quasi Peak detector mode re-measured.
- g. All readings are Peak unless otherwise stated QP in column of Note. Peak denotes that the Peak reading compliance with the QP Limits and then QP Mode measurement didn't perform. (below 1GHz)
- h. All readings are Peak Mode value unless otherwise stated AVG in column of Note. If the Peak Mode Measured value compliance with the Peak Limits and lower than AVG Limits, the EUT shall be deemed to meet both Peak & AVG Limits and then only Peak Mode was measured, but AVG Mode didn't perform. (above 1GHz)
- i. For the actual test configuration, please refer to the related Item –EUT Test Photos.

4.2.3 DEVIATION FROM TEST STANDARD

No deviation

4.2.4 TEST SETUP

(A) Radiated Emission Test Set-Up Frequency Below 1 GHz

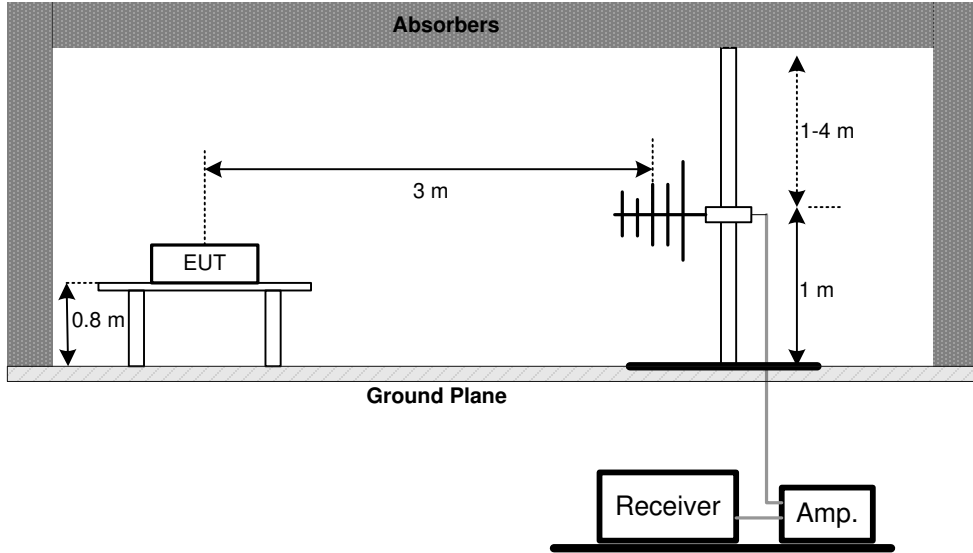

(B) Radiated Emission Test Set-Up Frequency Above 1 GHz

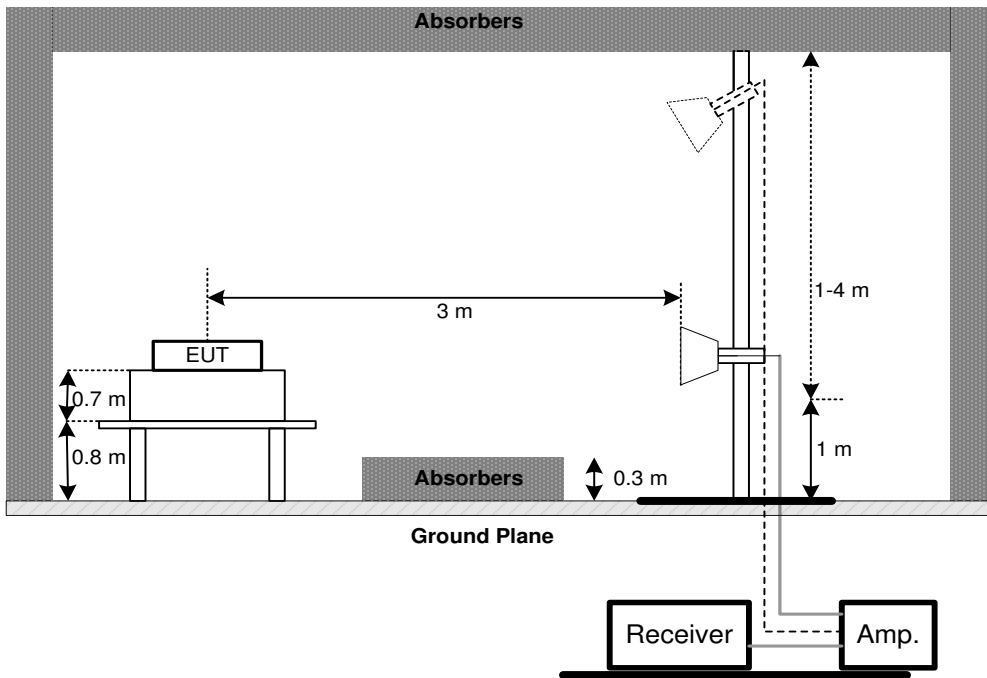

(C) For Radiated Emissions Below 30MHz

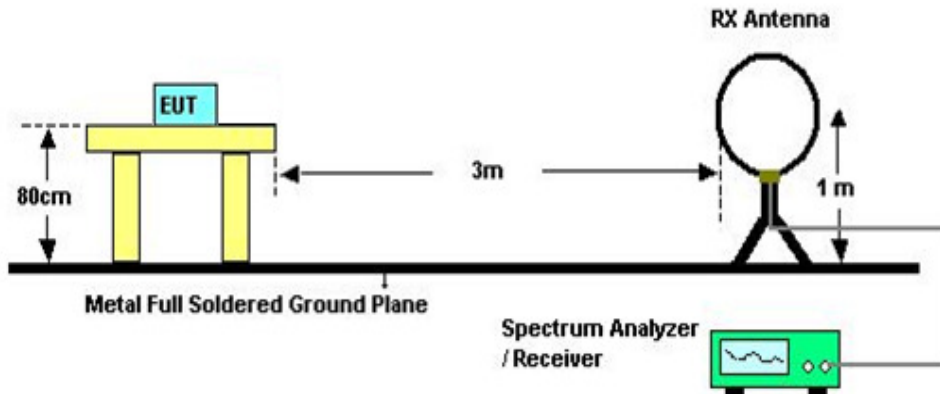

4.2.5 EUT OPERATING CONDITIONS

The EUT was programmed to be in continuously transmitting mode.

4.2.6 EUT TEST CONDITIONS

Temperature: 25°C Relative Humidity: 55% Test Voltage: AC 120V/60Hz

4.2.7 TEST RESULTS (9KHZ TO 30MHZ)

Please refer to the Attachment B

Remark:

- (1) The amplitude of spurious emissions which are attenuated by more than 20 dB below the permissible value has no need to be reported.
- (2) Distance extrapolation factor = $40 \log(\text{specific distance} / \text{test distance})$ (dB).
- (3) Limit line = specific limits (dBuV) + distance extrapolation factor.

4.2.8 TEST RESULTS (30MHZ TO 1000 MHZ)

Please refer to the Attachment C.

4.2.9 TEST RESULTS (ABOVE 1000 MHZ)

Please refer to the Attachment D.

Remark:

- (1) No limit: This is fundamental signal, the judgment is not applicable. For fundamental signal judgment was referred to Peak output test.

5. BANDWIDTH TEST

5.1 APPLIED PROCEDURES

FCC Part15 (15.247) , Subpart C			
Section	Test Item	Frequency Range (MHz)	Result
15.247(a)(2)	Bandwidth	2400-2483.5	PASS

5.1.1 TEST PROCEDURE

- a. The EUT was directly connected to the spectrum analyzer and antenna output port as show in the block diagram below,
- b. Spectrum Setting: RBW= 100KHz, VBW=300KHz, Sweep time = 2.5 ms.

5.1.2 DEVIATION FROM STANDARD

No deviation.

5.1.3 TEST SETUP

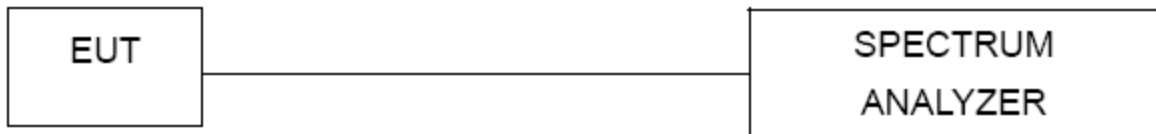

5.1.4 EUT OPERATION CONDITIONS

The EUT was programmed to be in continuously transmitting mode.

5.1.5 EUT TEST CONDITIONS

Temperature: 25°C Relative Humidity: 55% Test Voltage: AC 120V/60Hz

5.1.6 TEST RESULTS

Please refer to the Attachment E.

6. MAXIMUM PEAK CONDUCTED OUTPUT POWER TEST

6.1 APPLIED PROCEDURES / LIMIT

FCC Part15 (15.247) , Subpart C				
Section	Test Item	Limit	Frequency Range (MHz)	Result
15.247(b)(3)	Maximum Output Power	1 Watt or 30dBm	2400-2483.5	PASS

6.1.1 TEST PROCEDURE

- a. The EUT was directly connected to the power meter and antenna output port as show in the block diagram below,
- b. The maximum peak conducted output power was performed in accordance with method 9.1.2 of FCC KDB 558074 D01 DTS Meas Guidance and FCC KDB 662911 D01 Multiple Transmitter Output.

6.1.2 DEVIATION FROM STANDARD

No deviation.

6.1.3 TEST SETUP



6.1.4 EUT OPERATION CONDITIONS

The EUT was programmed to be in continuously transmitting mode.

6.1.5 EUT TEST CONDITIONS

Temperature: 25°C Relative Humidity: 55% Test Voltage: AC 120V/60Hz

6.1.6 TEST RESULTS

Please refer to the Attachment F.

7. ANTENNA CONDUCTED SPURIOUS EMISSION

7.1 APPLIED PROCEDURES / LIMIT

In any 100 kHz bandwidth outside the frequency band in which the spread spectrum or digitally modulated device is operating, the RF power that is produced shall be at least 20 dB below that in the 100 kHz bandwidth within the band that contains the highest level of the desired power, based on either an RF conducted or a radiated measurement, provided that the transmitter demonstrates compliance with the peak conducted power limits.

7.1.1 TEST PROCEDURE

- a. The EUT was directly connected to the spectrum analyzer and antenna output port as show in the block diagram below,
- b. Spectrum Setting: RBW= 100KHz, VBW=300KHz, Sweep time = Auto.
- c. Offset=antenna gain+cable loss

7.1.2 DEVIATION FROM STANDARD

No deviation.

7.1.3 TEST SETUP



7.1.4 EUT OPERATION CONDITIONS

The EUT was programmed to be in continuously transmitting mode.

7.1.5 EUT TEST CONDITIONS

Temperature: 25°C Relative Humidity: 55% Test Voltage: AC 120V/60Hz

7.1.6 TEST RESULTS

Please refer to the Attachment G.

8. POWER SPECTRAL DENSITY TEST

8.1 APPLIED PROCEDURES / LIMIT

FCC Part15 (15.247) , Subpart C				
Section	Test Item	Limit	Frequency Range (MHz)	Result
15.247(e)	Power Spectral Density	8 dBm (in any 3KHz)	2400-2483.5	PASS

8.1.1 TEST PROCEDURE

- a. The EUT was directly connected to the spectrum analyzer and antenna output port as show in the block diagram below,
- b. Spectrum Setting: RBW=3KHz, VBW=10KHz, Sweep time = Auto.

8.1.2 DEVIATION FROM STANDARD

No deviation.

8.1.3 TEST SETUP

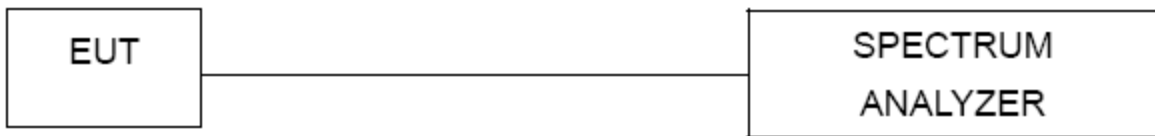

8.1.4 EUT OPERATION CONDITIONS

The EUT was programmed to be in continuously transmitting mode.

8.1.5 EUT TEST CONDITIONS

Temperature: 25°C Relative Humidity: 55% Test Voltage: AC 120V/60Hz

8.1.6 TEST RESULTS

Please refer to the Attachment H.

9. MEASUREMENT INSTRUMENTS LIST

Conducted Emission Measurement					
Item	Kind of Equipment	Manufacturer	Type No.	Serial No.	Calibrated until
1	LISN	EMCO	3816/2	0052765	Mar. 26, 2018
2	LISN	R&S	ENV216	101447	Mar. 26, 2018
3	Test Cable	emci	RG223(9KHz-30MHz)	C_17	Mar. 09, 2018
4	EMI Test Receiver	R&S	ESCI	100382	Mar. 26, 2018
5	50Ω Terminator	SHX	TF2-3G-A	08122901	Mar. 26, 2018
6	Measurement Software	Farad	EZ-EMC Ver.NB-03A1-01	N/A	N/A

Radiated Emission Measurement					
Item	Kind of Equipment	Manufacturer	Type No.	Serial No.	Calibrated until
1	Antenna	Schwarbeck	VULB9160	9160-3232	Mar. 26, 2018
2	Amplifier	HP	8447D	2944A09673	Feb. 22, 2018
3	Receiver	AGILENT	N9038A	MY52130039	Jun. 23, 2017
4	Test Cable	emci	LMR-400(30MHz-1GHz)	C-01	Jun. 26, 2017
5	Control	CT	SC100	N/A	N/A
6	Position Control	MF	MF-7802	MF780208416	N/A
7	Antenna	ETS	3115	00075789	Mar. 26, 2018
8	Amplifier	Agilent	8449B	3008A02274	Feb. 22, 2018
9	Receiver	AGILENT	N9038A	MY52130039	Jun. 23, 2017
10	Test Cable	emci	EMC104-SM-SM-10000(1GHz-26.5GHz)	C-68	Jun. 26, 2017
11	Controller	CT	SC100	N/A	N/A
12	Broad-Band Horn Antenna	Schwarzbeck	BBHA 9170	9170319	Apr. 23, 2017
13	Microwave Pre-amplifier With Adaptor	EMC INSTRUMENT	EMC2654045	980039 & HA01	Mar. 26, 2018
14	Active Loop Antenna	R&S	HFH2-Z2	830749/020	Sep. 06, 2017
15	Measurement Software	Farad	EZ-EMC Ver.NB-03A1-01	N/A	N/A

6dB Bandwidth Measurement					
Item	Kind of Equipment	Manufacturer	Type No.	Serial No.	Calibrated until
1	Spectrum Analyzer	R&S	FSP 40	100185	Sep. 04, 2017

Peak Output Power Measurement					
Item	Kind of Equipment	Manufacturer	Type No.	Serial No.	Calibrated until
1	P-series Power meter	Agilent	N1911A	MY45100473	Sep. 04, 2017
2	Wireband Power sensor	Agilent	N1921A	MY51100041	Sep. 04, 2017

Antenna Conducted Spurious Emission Measurement					
Item	Kind of Equipment	Manufacturer	Type No.	Serial No.	Calibrated until
1	Spectrum Analyzer	R&S	FSP 40	100185	Sep. 04, 2017

Power Spectral Density Measurement					
Item	Kind of Equipment	Manufacturer	Type No.	Serial No.	Calibrated until
1	Spectrum Analyzer	R&S	FSP 40	100185	Sep. 04, 2017

Remark: "N/A" denotes no model name, serial no. or calibration specified.
 All calibration period of equipment list is one year.

10. EUT TEST PHOTO

Conducted Measurement Photos



Radiated Measurement Photos

9KHz to 30MHz



Radiated Measurement Photos

30MHz to 1000MHz

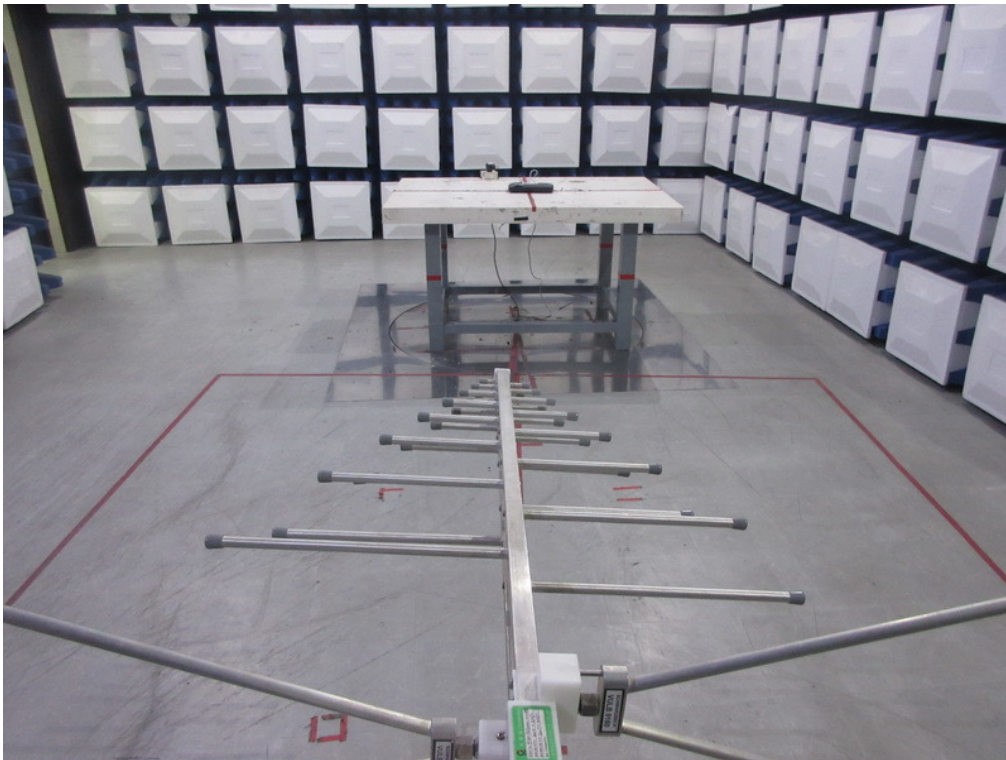

Radiated Measurement Photos

Above 1000MHz

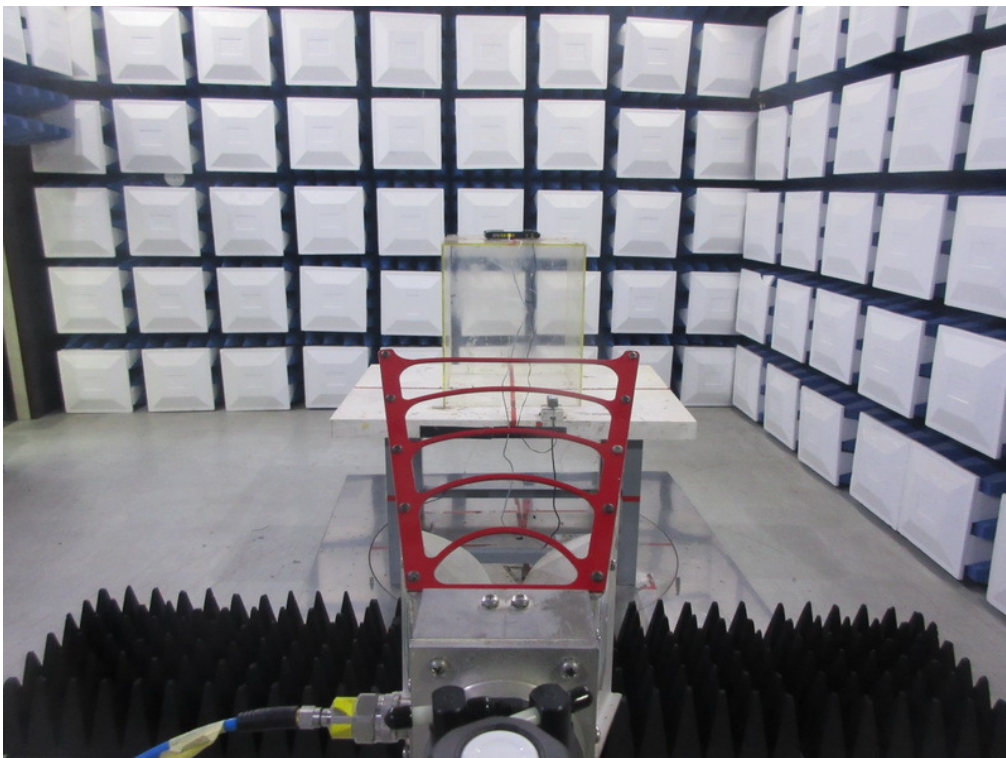

ATTACHMENT A - CONDUCTED EMISSION

Test Mode : TX Mode (Adapter: SOY-1200200US)

Line

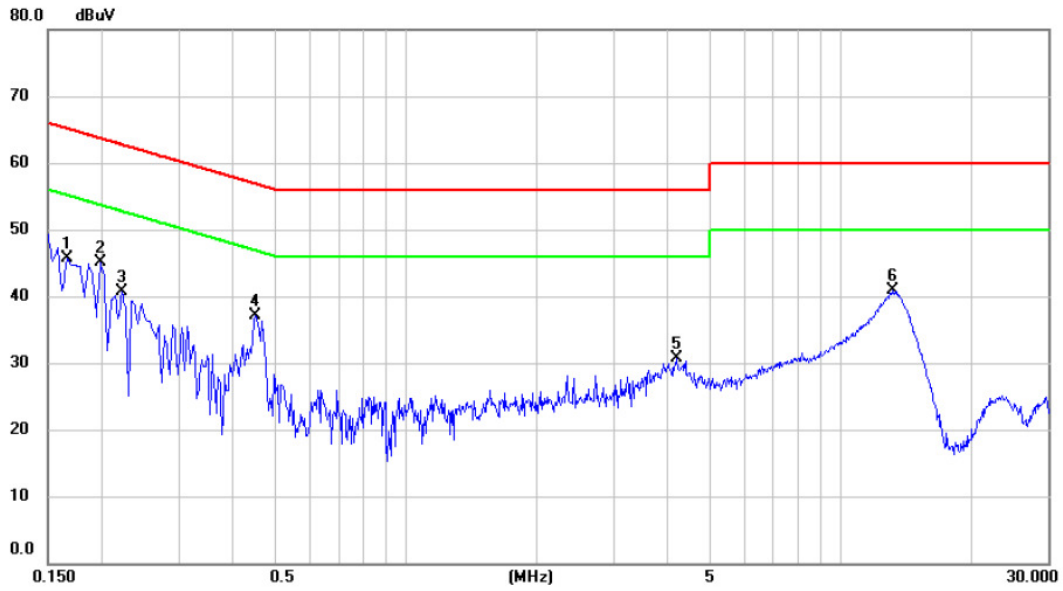

No.	Mk.	Freq. MHz	Reading Level dBuV	Correct Factor dB	Measure- ment dBuV	Limit dBuV	Margin dB	Detector	Comment
1		0.166	36.18	9.57	45.75	65.16	-19.41	peak	
2	*	0.198	35.52	9.57	45.09	63.69	-18.60	peak	
3		0.222	31.13	9.57	40.70	62.74	-22.04	peak	
4		0.450	27.45	9.64	37.09	56.88	-19.79	peak	
5		4.202	20.28	10.36	30.64	56.00	-25.36	peak	
6		13.130	30.30	10.62	40.92	60.00	-19.08	peak	

Test Mode : TX Mode (Adapter: SOY-1200200US)

Neutral

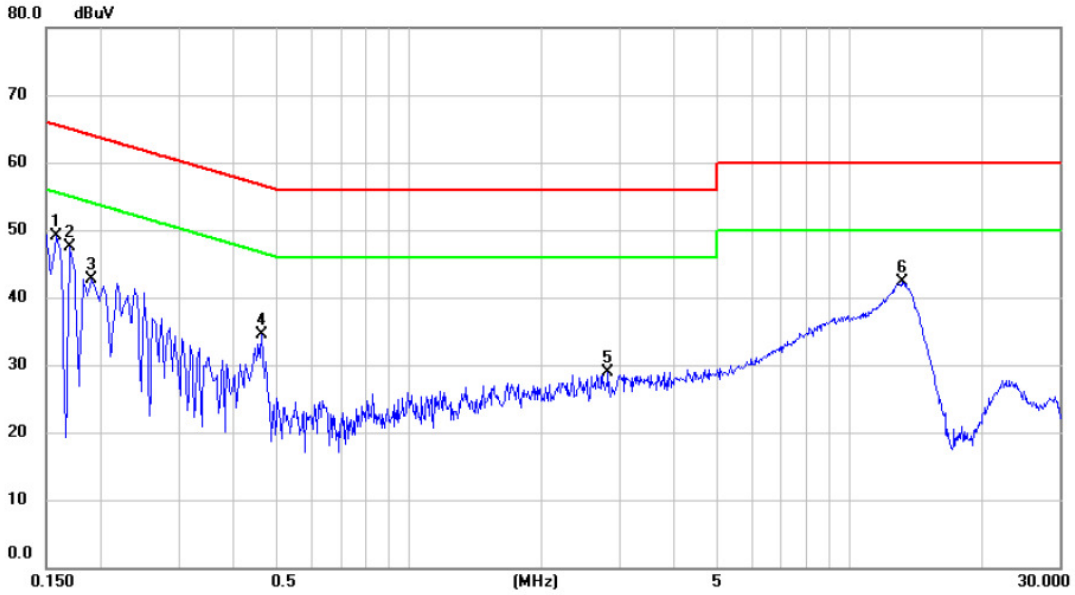

No.	Mk.	Freq. MHz	Reading Level dBuV	Correct Factor dB	Measure- ment dBuV	Limit dBuV	Margin dB	Detector	Comment
1	*	0.158	39.65	9.53	49.18	65.57	-16.39	peak	
2		0.170	38.12	9.47	47.59	64.96	-17.37	peak	
3		0.190	33.09	9.54	42.63	64.04	-21.41	peak	
4		0.462	24.95	9.49	34.44	56.66	-22.22	peak	
5		2.830	19.01	9.95	28.96	56.00	-27.04	peak	
6		13.190	31.67	10.66	42.33	60.00	-17.67	peak	

Test Mode : TX Mode (Adapter: S24B72-120A200-C4)

Line

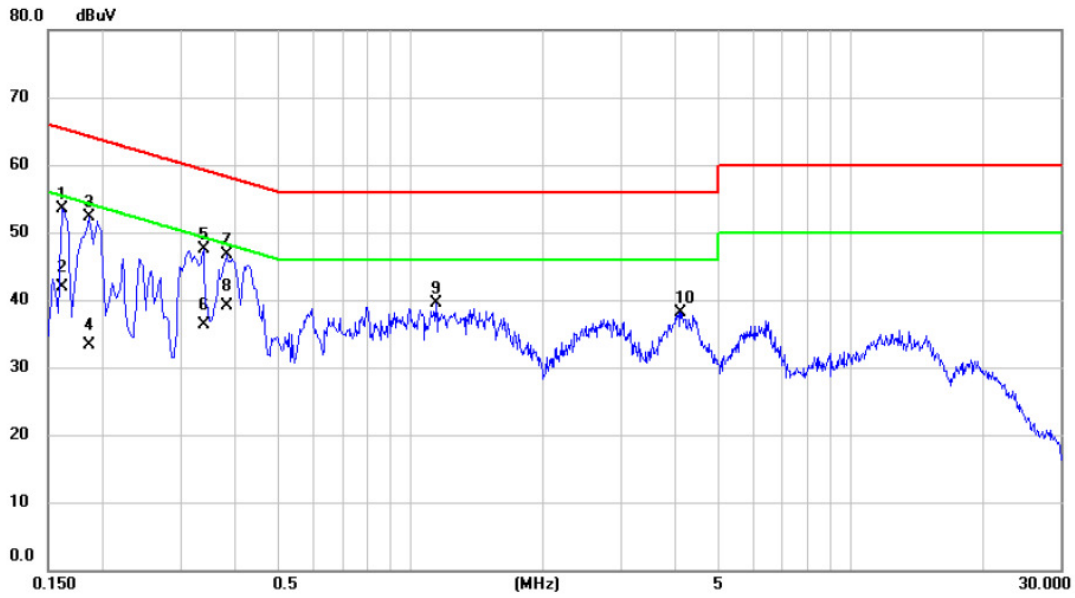

No. Mk.	Freq. MHz	Reading Level dBuV	Correct Factor dB	Measure- ment dBuV	Limit dBuV	Margin dB	Detector	Comment
1	0.162	43.98	9.57	53.55	65.36	-11.81	peak	
2	0.162	32.32	9.57	41.89	55.36	-13.47	AVG	
3	0.186	42.66	9.57	52.23	64.21	-11.98	peak	
4	0.186	23.65	9.57	33.22	54.21	-20.99	AVG	
5	0.338	37.85	9.58	47.43	59.25	-11.82	peak	
6	0.338	26.66	9.58	36.24	49.25	-13.01	AVG	
7	0.382	37.18	9.58	46.76	58.24	-11.48	peak	
8 *	0.382	29.45	9.58	39.03	48.24	-9.21	AVG	
9	1.146	29.57	9.85	39.42	56.00	-16.58	peak	
10	4.110	27.78	10.38	38.16	56.00	-17.84	peak	

Test Mode : TX Mode (Adapter: S24B72-120A200-C4)

Neutral

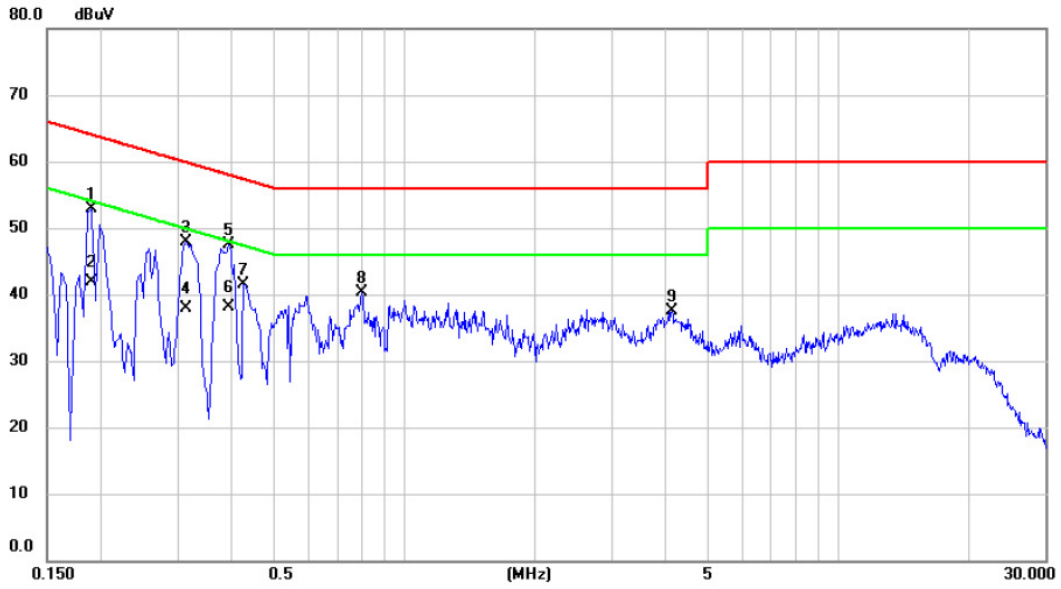

No. Mk.	Freq. MHz	Reading Level dBuV	Correct Factor dB	Measure- ment dBuV	Limit dBuV	Margin dB	Detector	Comment
1	0.190	43.32	9.54	52.86	64.04	-11.18	peak	
2	0.190	32.33	9.54	41.87	54.04	-12.17	AVG	
3	0.314	38.36	9.58	47.94	59.86	-11.92	peak	
4	0.314	28.30	9.58	37.88	49.86	-11.98	AVG	
5	0.394	38.05	9.49	47.54	57.98	-10.44	peak	
6 *	0.394	28.60	9.49	38.09	47.98	-9.89	AVG	
7	0.426	32.07	9.49	41.56	57.33	-15.77	peak	
8	0.798	30.76	9.62	40.38	56.00	-15.62	peak	
9	4.126	27.31	10.11	37.42	56.00	-18.58	peak	

ATTACHMENT B - RADIATED EMISSION (9KHZ TO 30MHZ)

Test Mode: TX B MODE CHANNEL 01 (Adapter: SOY-1200200US)

Ant 0°

160 dBuV/m

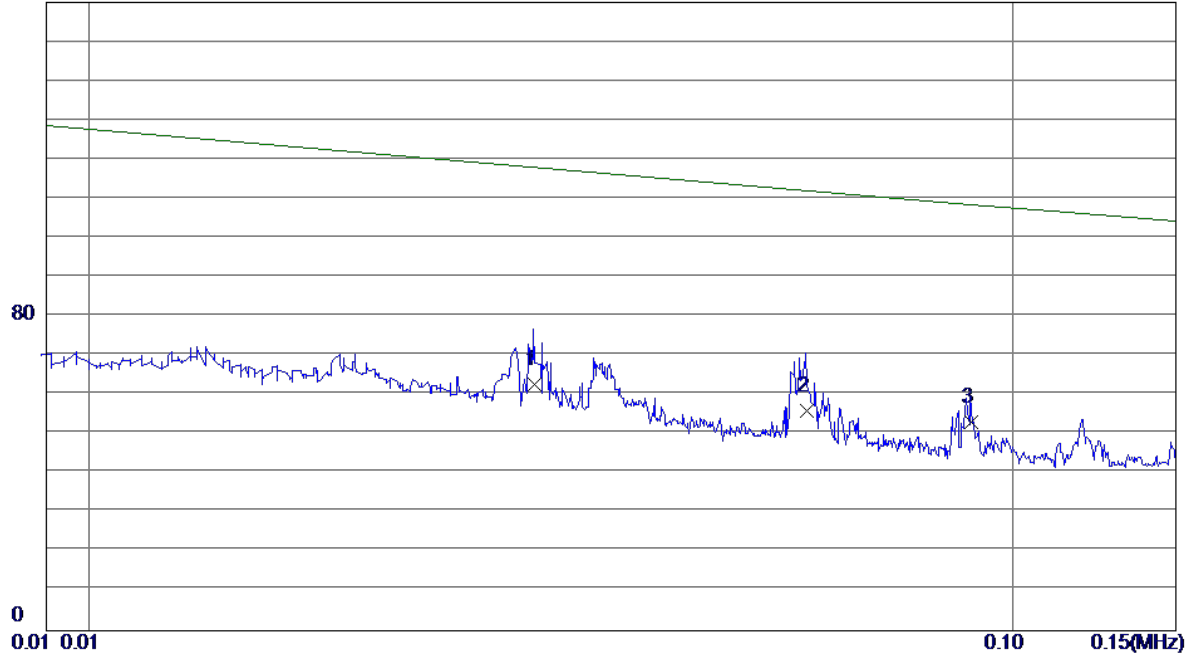

No.	Freq. MHz	Reading Level dBuV/m	Correct Factor dB	Measure ment dBuV/m	Limit dBuV/m	Margin dB	Detector	Comment
1	0.0304	40.62	22.24	62.86	123.21	-60.35	AVG	
2	0.0598	36.16	19.71	55.87	115.95	-60.08	AVG	
3 *	0.0901	34.12	18.86	52.98	108.50	-55.52	AVG	

Test Mode: TX B MODE CHANNEL 01 (Adapter: SOY-1200200US)

Ant 0°

160 dBuV/m

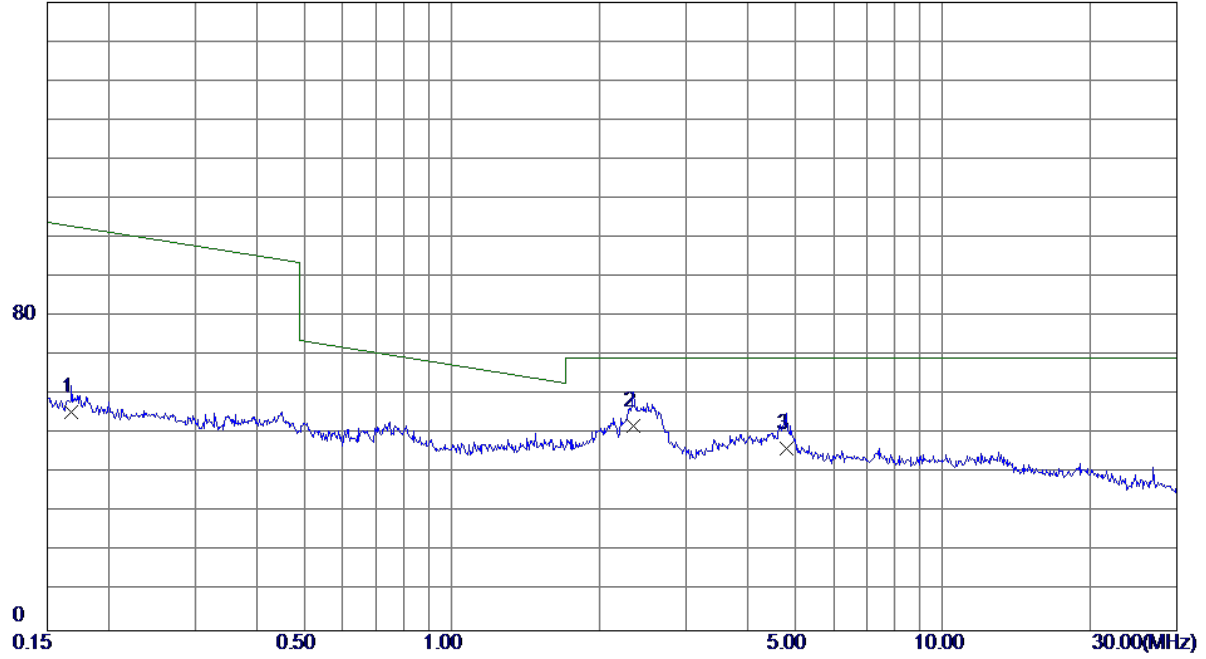

No.	Freq. MHz	Reading Level dBuV/m	Correct Factor dB	Measure ment dBuV/m	Limit dBuV/m	Margin dB	Detector	Comment
1	0.1675	36.81	18.72	55.53	104.82	-49.29	AVG	
2 *	2.3460	34.79	17.46	52.25	69.54	-17.29	QP	
3	4.7970	29.18	17.10	46.28	69.54	-23.26	QP	

Test Mode: TX B MODE CHANNEL 01 (Adapter: SOY-1200200US)

Ant 90°

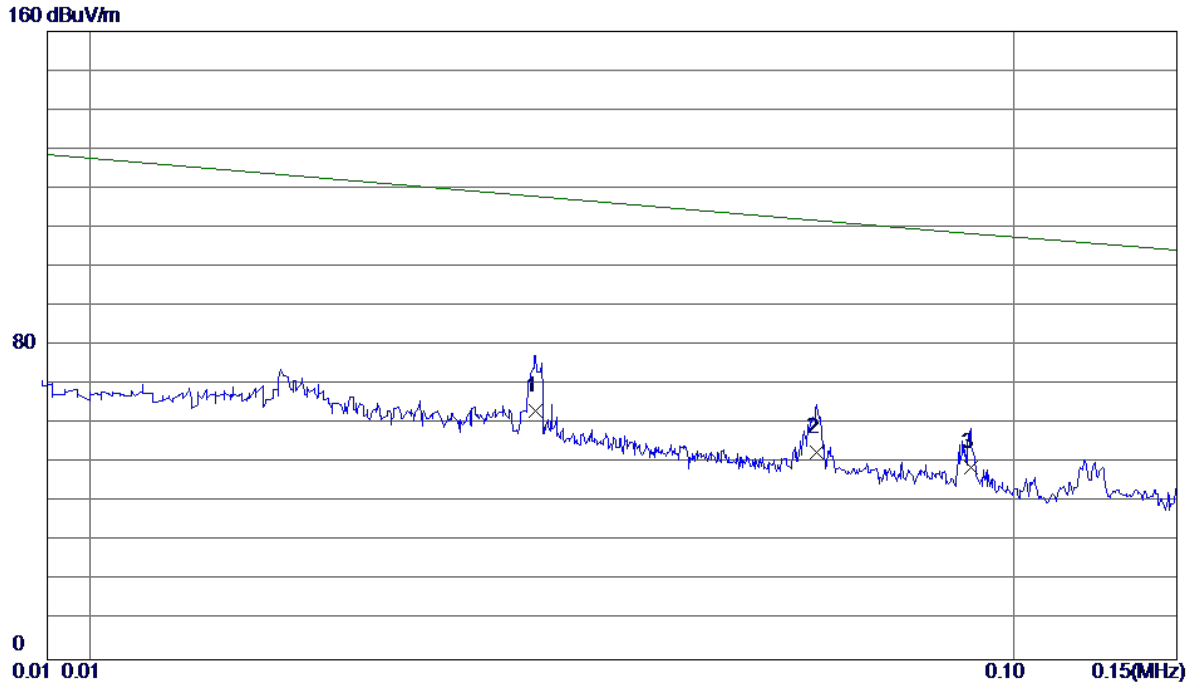

No.	Freq. MHz	Reading Level dBuV/m	Correct Factor dB	Measure ment dBuV/m	Limit dBuV/m	Margin dB	Detector	Comment
1	0.0304	41.25	22.24	63.49	123.21	-59.72	AVG	
2	0.0611	33.25	19.69	52.94	115.63	-62.69	AVG	
3 *	0.0898	30.03	18.88	48.91	108.54	-59.63	AVG	

Test Mode: TX B MODE CHANNEL 01 (Adapter: SOY-1200200US)

Ant 90°

160 dBuV/m

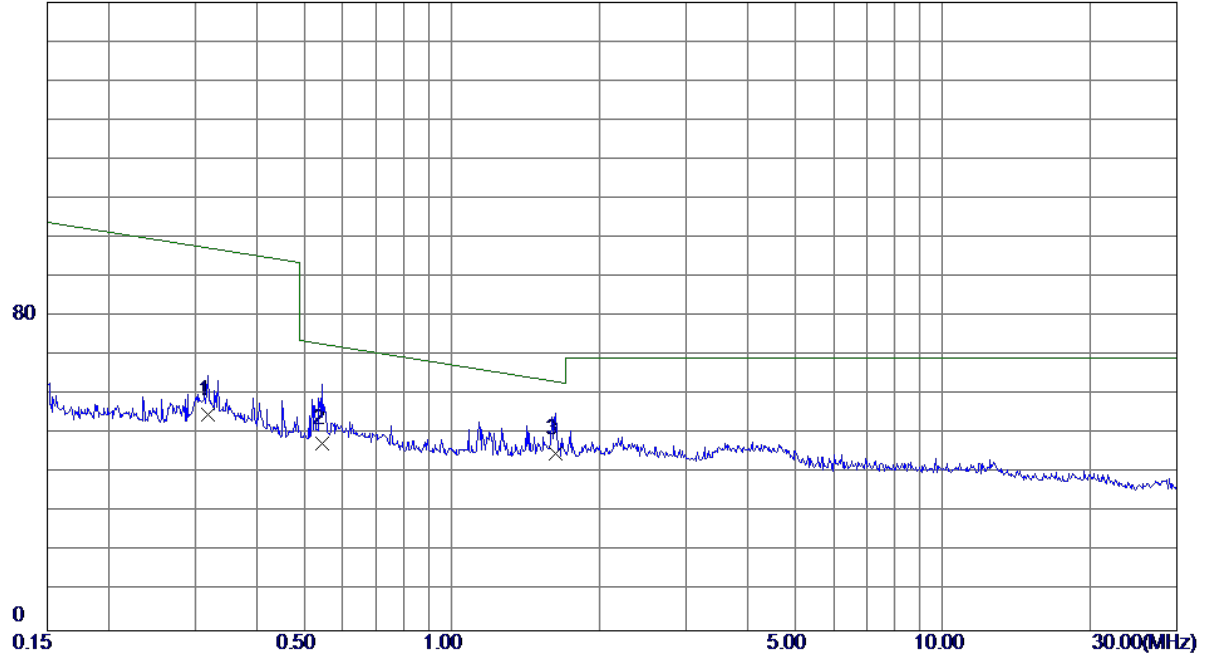

No.	Freq. MHz	Reading Level dBuV/m	Correct Factor dB	Measure ment dBuV/m	Limit dBuV/m	Margin dB	Detector	Comment
1	0.3183	36.32	18.57	54.89	99.66	-44.77	AVG	
2	0.5434	29.22	18.39	47.61	73.32	-25.71	QP	
3 *	1.6275	27.41	17.82	45.23	63.66	-18.43	QP	

Test Mode: TX B MODE CHANNEL 01 (Adapter: S24B72-120A200-C4)

Ant 0°

160 dBuV/m

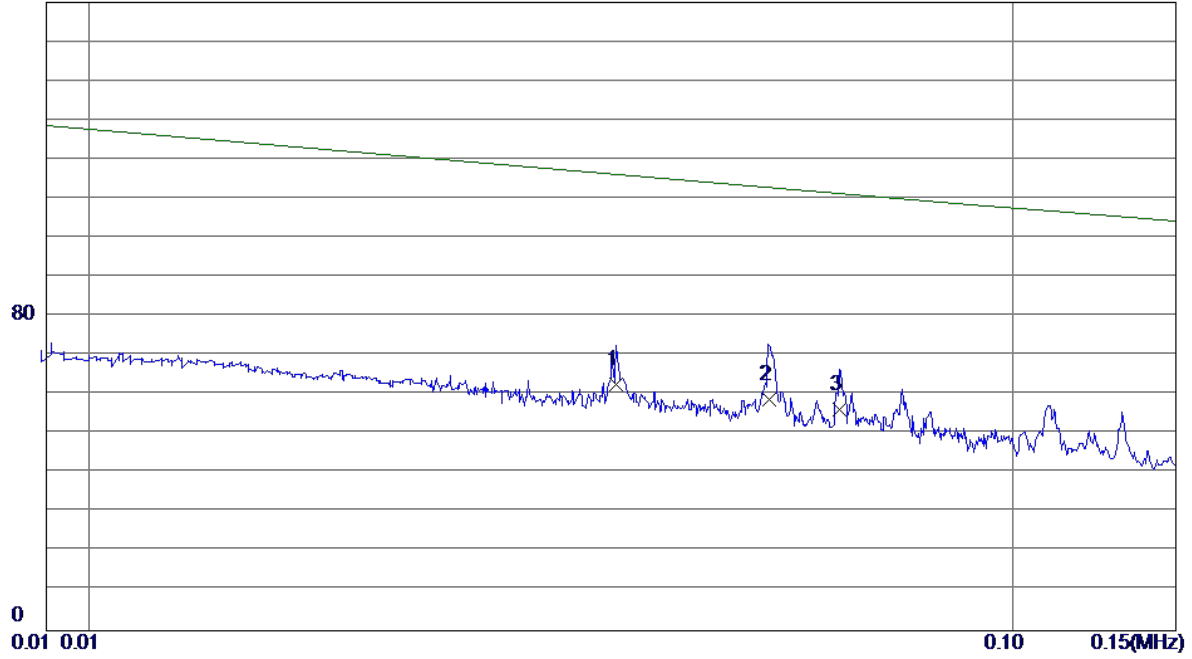

No.	Freq. MHz	Reading Level dBuV/m	Correct Factor dB	Measure ment dBuV/m	Limit dBuV/m	Margin dB	Detector	Comment
1	0.0372	41.39	21.40	62.79	121.53	-58.74	AVG	
2	0.0544	39.03	19.77	58.80	117.29	-58.49	AVG	
3 *	0.0650	36.78	19.65	56.43	114.67	-58.24	AVG	

Test Mode: TX B MODE CHANNEL 01 (Adapter: S24B72-120A200-C4)

Ant 0°

160 dBuV/m

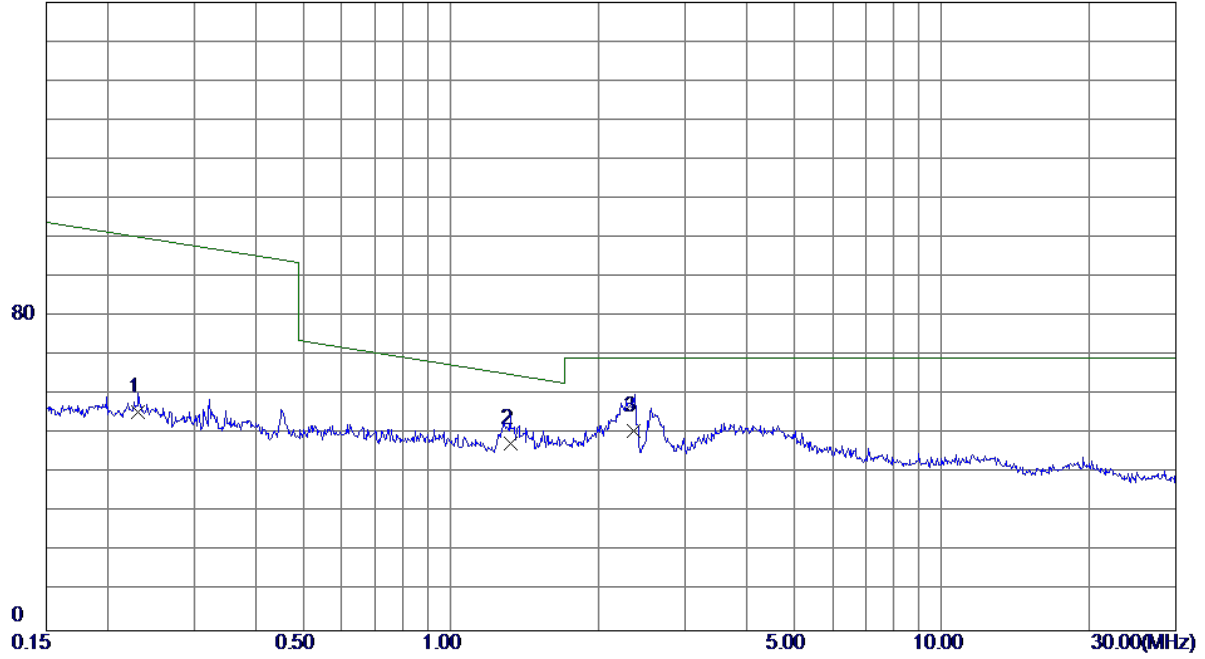

No.	Freq. MHz	Reading Level dBuV/m	Correct Factor dB	Measure ment dBuV/m	Limit dBuV/m	Margin dB	Detector	Comment
1	0.2303	36.90	18.67	55.57	102.67	-47.10	AVG	
2 *	1.3237	29.98	17.75	47.73	66.37	-18.64	QP	
3	2.3584	33.41	17.45	50.86	69.54	-18.68	QP	

Test Mode: TX B MODE CHANNEL 01 (Adapter: S24B72-120A200-C4)

Ant 90°

160 dBuV/m

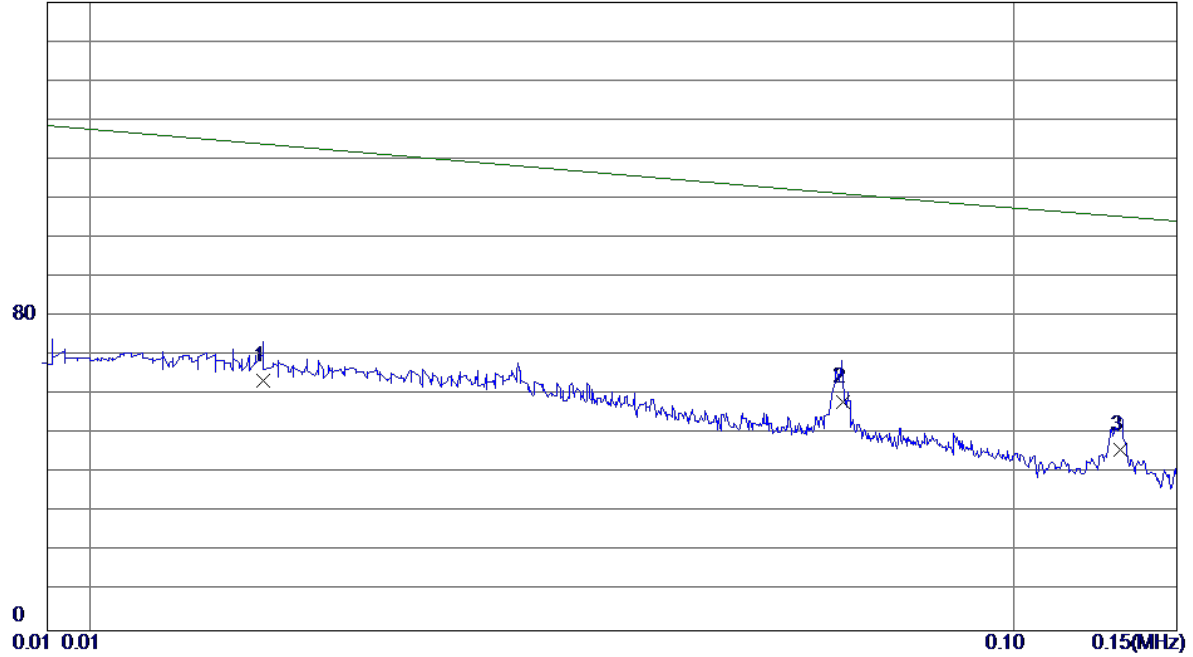

No.	Freq. MHz	Reading Level dBuV/m	Correct Factor dB	Measure ment dBuV/m	Limit dBuV/m	Margin dB	Detector	Comment
1	0.0154	39.86	23.80	63.66	126.92	-63.26	AVG	
2 *	0.0653	38.73	19.64	58.37	114.59	-56.22	AVG	
3	0.1303	27.39	18.62	46.01	106.09	-60.08	AVG	

Test Mode: TX B MODE CHANNEL 01 (Adapter: S24B72-120A200-C4)

Ant 90°

160 dBuV/m

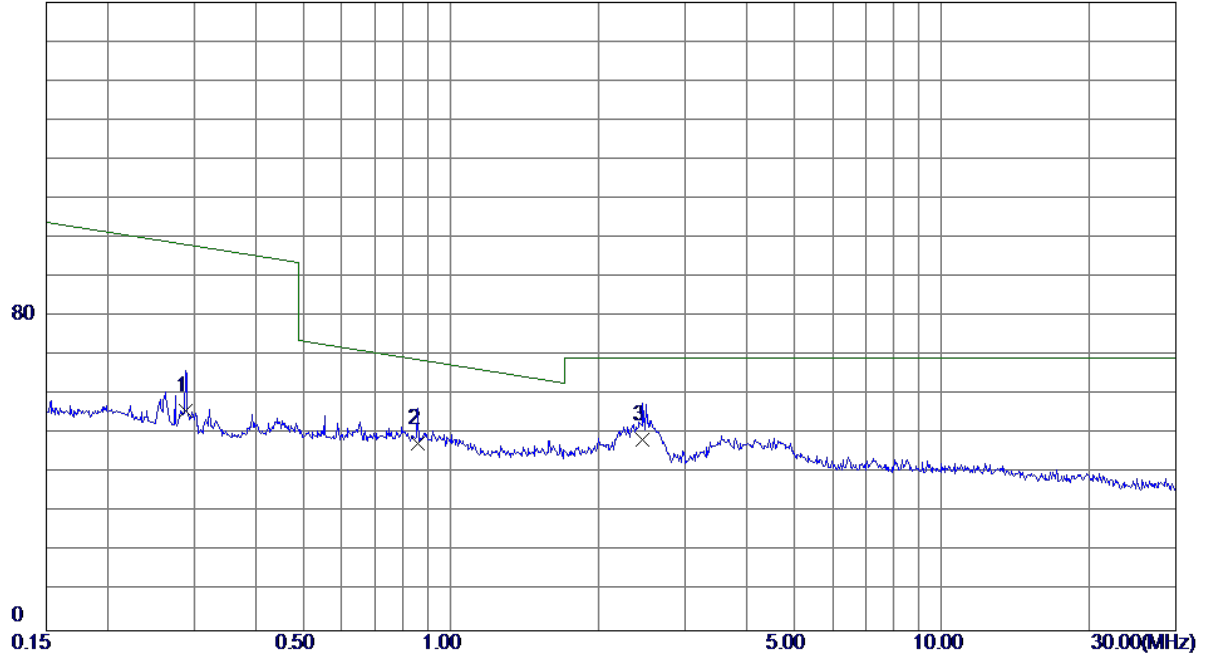

No.	Freq. MHz	Reading Level dBuV/m	Correct Factor dB	Measure ment dBuV/m	Limit dBuV/m	Margin dB	Detector	Comment
1	0.2878	37.48	18.61	56.09	100.71	-44.62	AVG	
2	0.8572	29.52	18.13	47.65	70.53	-22.88	QP	
3 *	2.4605	31.45	17.32	48.77	69.54	-20.77	QP	

ATTACHMENT C - RADIATED EMISSION (30MHZ TO 1000MHZ)

Test Mode: TX B MODE CHANNEL 01 (Adapter: SOY-1200200US)

Vertical

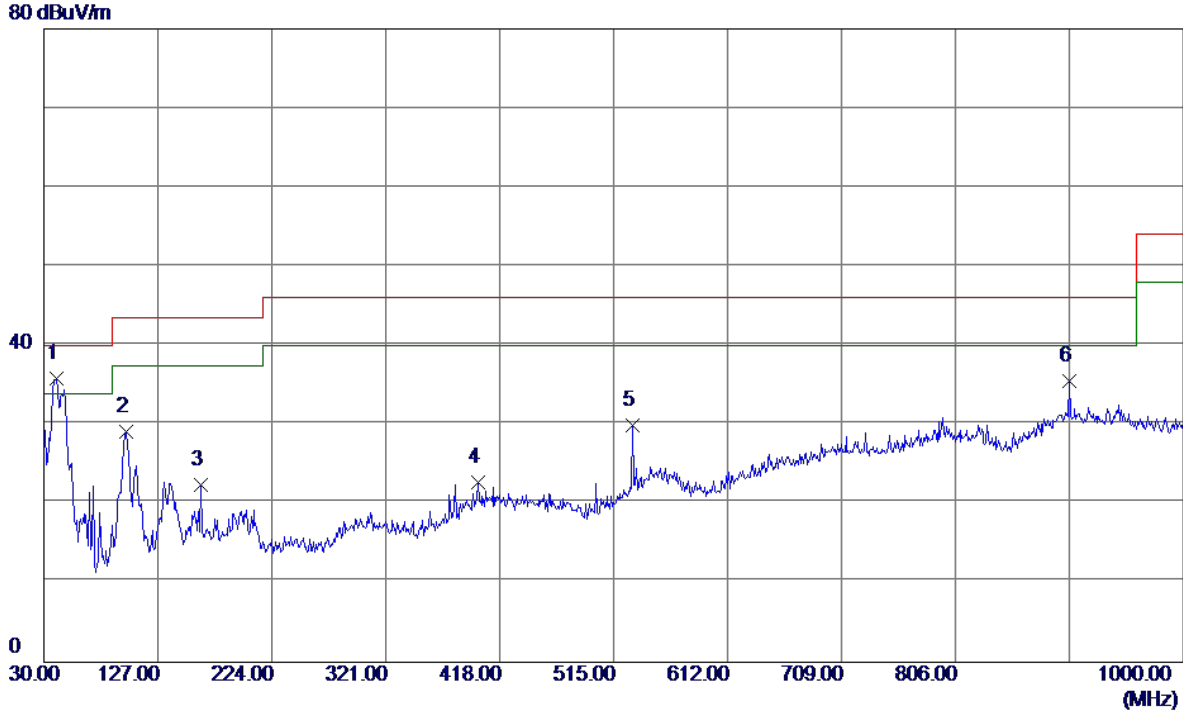

No.	Freq. MHz	Reading Level dBuV/m	Correct Factor dB	Measure ment dBuV/m	Limit dBuV/m	Margin dB	Detector	Comment
1 *	40.6699	49.65	-13.77	35.88	40.00	-4.12	Peak	
2	99.8399	44.63	-15.52	29.11	43.50	-14.39	Peak	
3	163.8600	34.63	-12.18	22.45	43.50	-21.05	Peak	
4	399.5700	30.55	-7.81	22.74	46.00	-23.26	Peak	
5	531.4900	36.40	-6.46	29.94	46.00	-16.06	Peak	
6	903.0000	32.93	2.63	35.56	46.00	-10.44	Peak	

Test Mode: TX B MODE CHANNEL 01 (Adapter: SOY-1200200US)

Horizontal

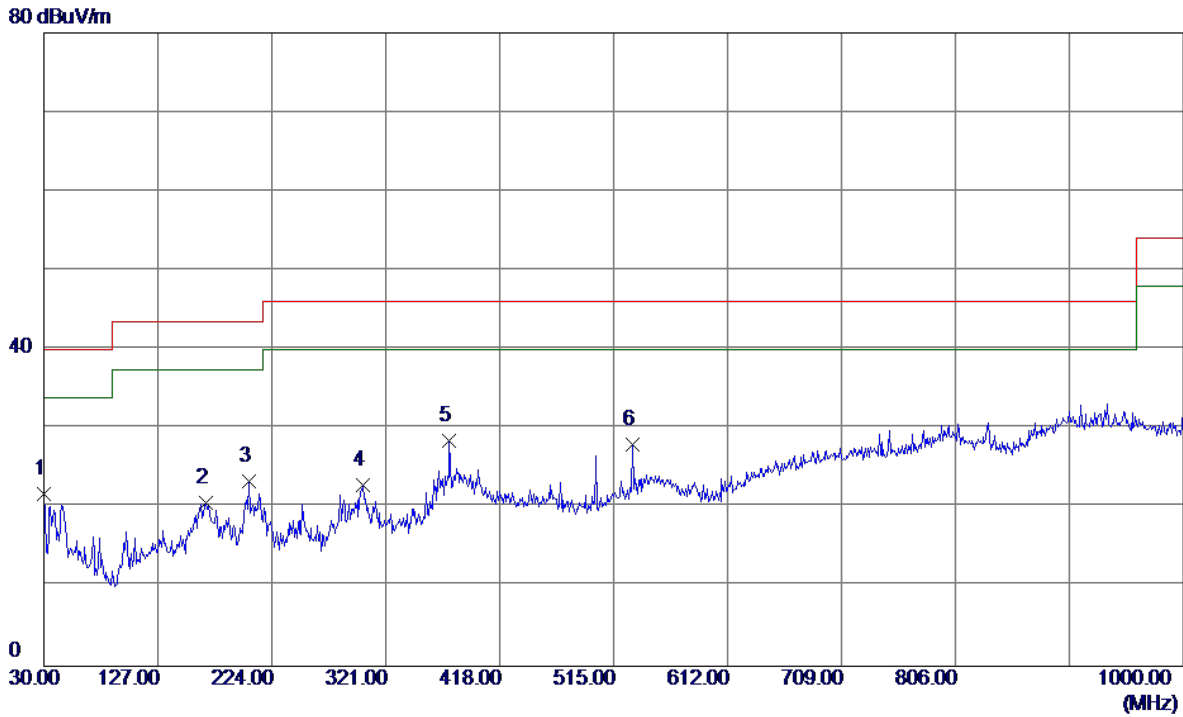

No.	Freq. MHz	Reading Level dBuV/m	Correct Factor dB	Measure ment dBuV/m	Limit dBuV/m	Margin dB	Detector	Comment
1	30.0000	35.86	-14.03	21.83	40.00	-18.17	Peak	
2	167.7400	32.84	-12.22	20.62	43.50	-22.88	Peak	
3	204.6000	37.89	-14.53	23.36	43.50	-20.14	Peak	
4	301.6000	33.01	-10.19	22.82	46.00	-23.18	Peak	
5 *	375.3200	37.91	-9.48	28.43	46.00	-17.57	Peak	
6	531.4900	34.42	-6.46	27.96	46.00	-18.04	Peak	

Test Mode: TX B MODE CHANNEL 06 (Adapter: SOY-1200200US)

Vertical

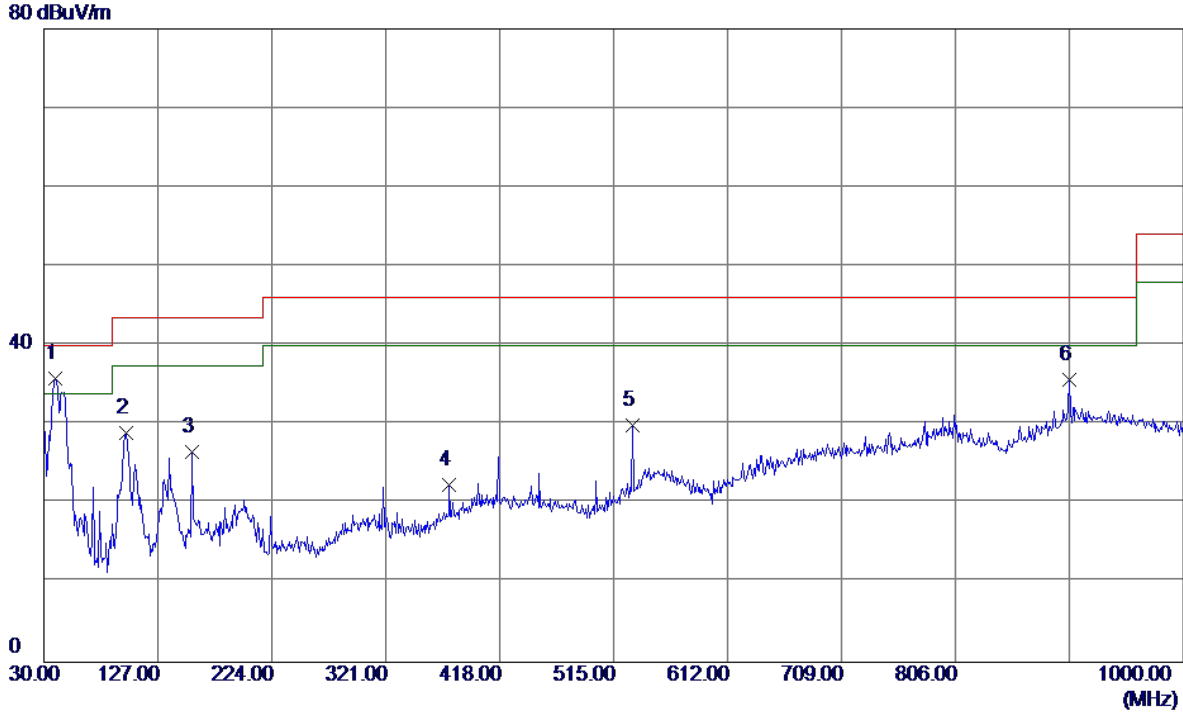

No.	Freq. MHz	Reading Level dBuV/m	Correct Factor dB	Measure ment dBuV/m	Limit dBuV/m	Margin dB	Detector	Comment
1 *	39.7000	49.72	-13.95	35.77	40.00	-4.23	Peak	
2	99.8399	44.51	-15.52	28.99	43.50	-14.51	Peak	
3	156.1000	39.00	-12.46	26.54	43.50	-16.96	Peak	
4	375.3200	31.84	-9.48	22.36	46.00	-23.64	Peak	
5	531.4900	36.45	-6.46	29.99	46.00	-16.01	Peak	
6	903.0000	33.08	2.63	35.71	46.00	-10.29	Peak	

Test Mode: TX B MODE CHANNEL 06 (Adapter: SOY-1200200US)

Horizontal

80 dBuV/m

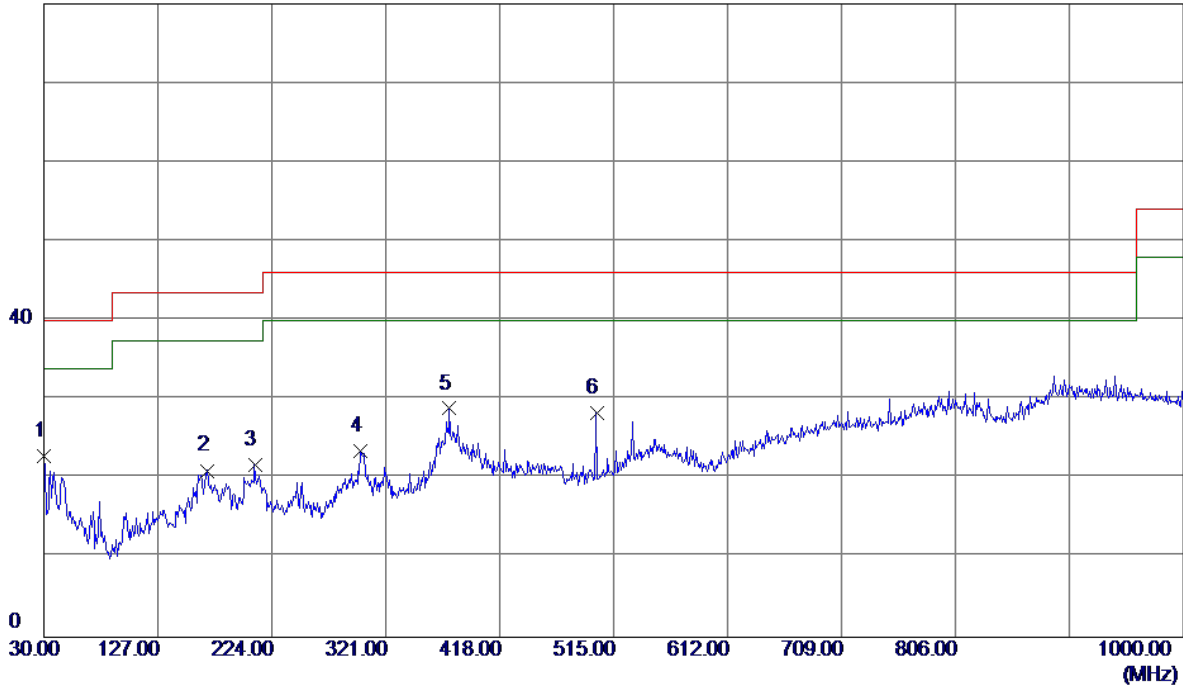

No.	Freq. MHz	Reading Level dBuV/m	Correct Factor dB	Measure ment dBuV/m	Limit dBuV/m	Margin dB	Detector	Comment
1 *	30.0000	36.95	-14.03	22.92	40.00	-17.08	Peak	
2	168.7100	33.27	-12.23	21.04	43.50	-22.46	Peak	
3	209.4500	36.41	-14.63	21.78	43.50	-21.72	Peak	
4	299.6600	33.67	-10.20	23.47	46.00	-22.53	Peak	
5	375.3200	38.36	-9.48	28.88	46.00	-17.12	Peak	
6	500.4500	37.97	-9.67	28.30	46.00	-17.70	Peak	

Test Mode: TX B MODE CHANNEL 11 (Adapter: SOY-1200200US)

Vertical

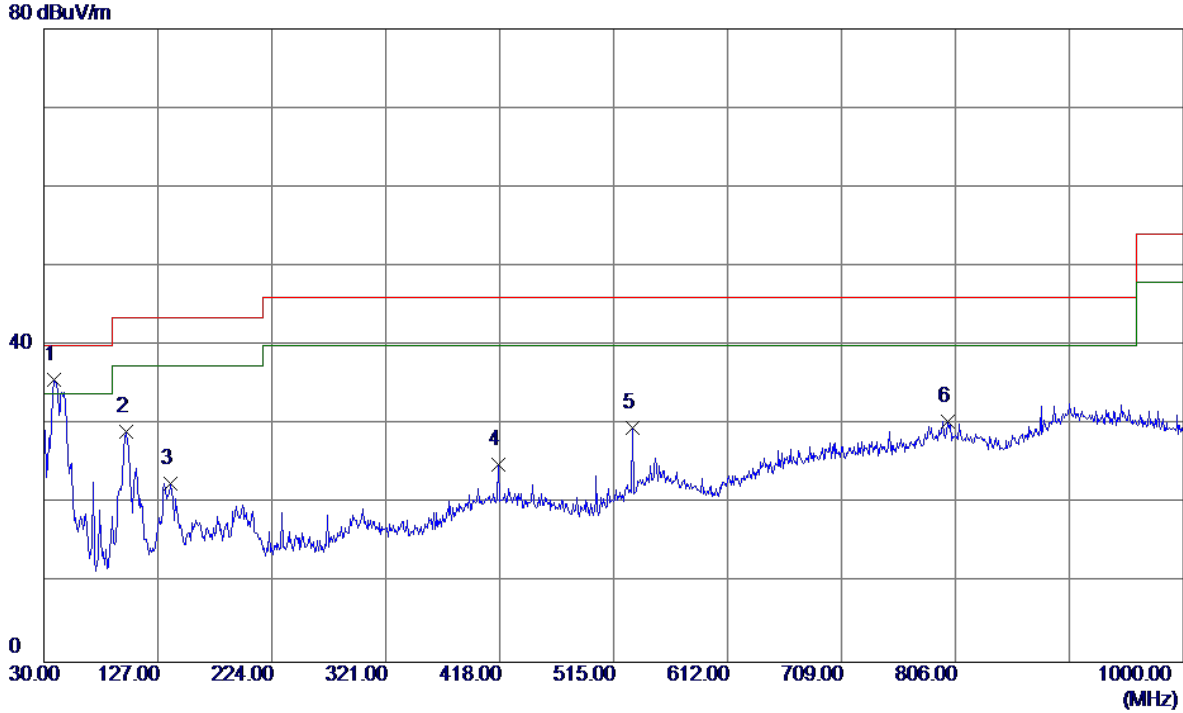

No.	Freq. MHz	Reading Level dBuV/m	Correct Factor dB	Measure ment dBuV/m	Limit dBuV/m	Margin dB	Detector	Comment
1 *	38.7300	49.74	-14.06	35.68	40.00	-4.32	Peak	
2	99.8399	44.62	-15.52	29.10	43.50	-14.40	Peak	
3	137.6700	36.03	-13.43	22.60	43.50	-20.90	Peak	
4	417.0300	32.84	-7.85	24.99	46.00	-21.01	Peak	
5	531.4900	36.00	-6.46	29.54	46.00	-16.46	Peak	
6	799.2100	30.24	0.22	30.46	46.00	-15.54	Peak	

Test Mode: TX B MODE CHANNEL 11 (Adapter: SOY-1200200US)

Horizontal

80 dBuV/m

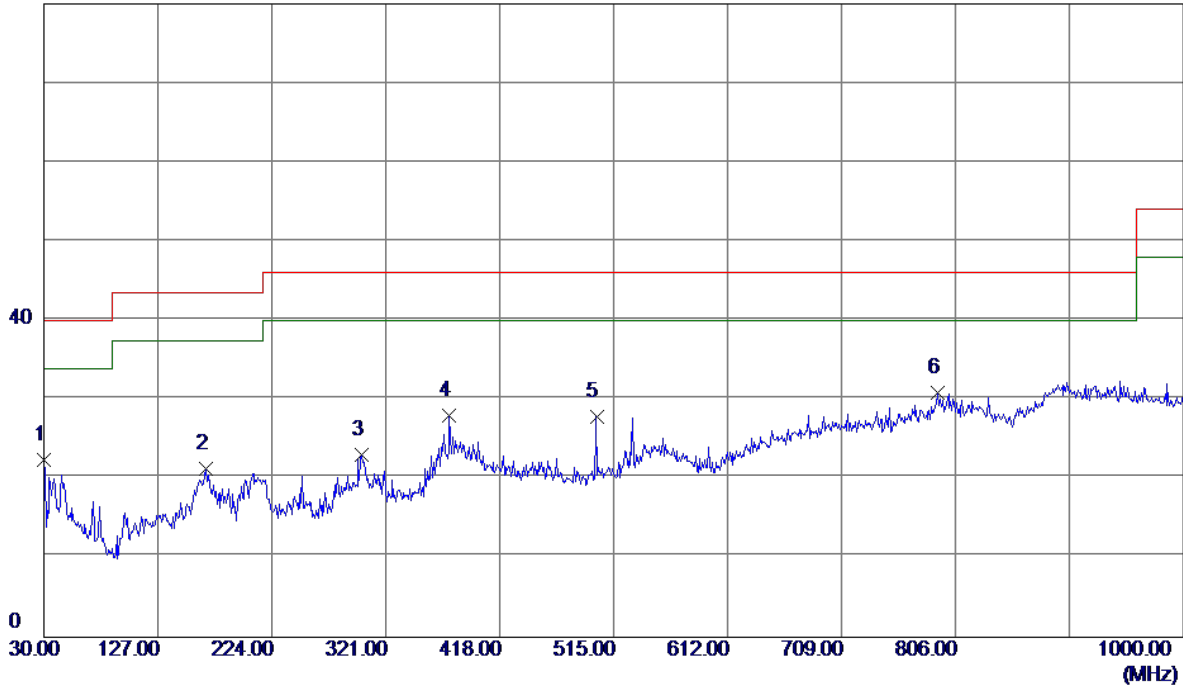

No.	Freq. MHz	Reading Level dBuV/m	Correct Factor dB	Measure ment dBuV/m	Limit dBuV/m	Margin dB	Detector	Comment
1	30.0000	36.50	-14.03	22.47	40.00	-17.53	Peak	
2	167.7400	33.48	-12.22	21.26	43.50	-22.24	Peak	
3	300.6300	33.15	-10.17	22.98	46.00	-23.02	Peak	
4	375.3200	37.54	-9.48	28.06	46.00	-17.94	Peak	
5	500.4500	37.53	-9.67	27.86	46.00	-18.14	Peak	
6 *	790.4800	31.08	-0.16	30.92	46.00	-15.08	Peak	

Test Mode: TX B MODE CHANNEL 01 (Adapter: S24B72-120A200-C4)

Vertical

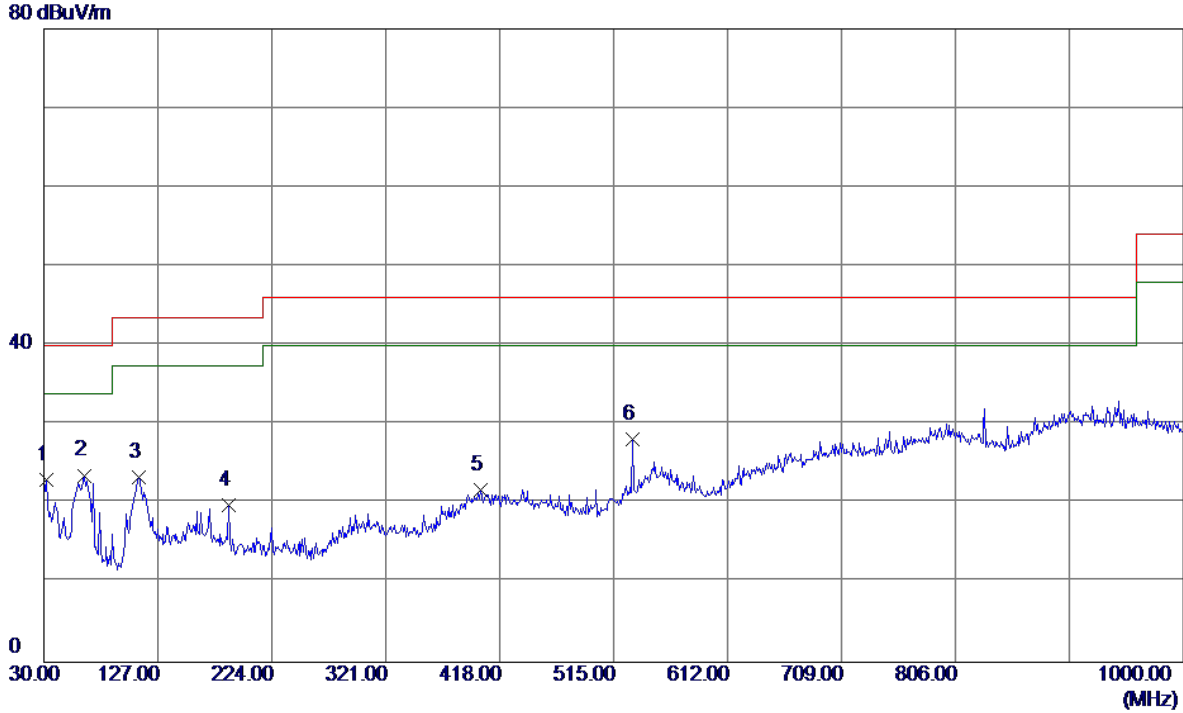

No.	Freq. MHz	Reading Level dBuV/m	Correct Factor dB	Measure ment dBuV/m	Limit dBuV/m	Margin dB	Detector	Comment
1	31.9400	37.30	-14.20	23.10	40.00	-16.90	Peak	
2 *	64.9200	38.75	-15.15	23.60	40.00	-16.40	Peak	
3	110.5100	37.97	-14.60	23.37	43.50	-20.13	Peak	
4	187.1400	33.53	-13.62	19.91	43.50	-23.59	Peak	
5	401.5100	29.60	-7.79	21.81	46.00	-24.19	Peak	
6	531.4900	34.67	-6.46	28.21	46.00	-17.79	Peak	

Test Mode: TX B MODE CHANNEL 01 (Adapter: S24B72-120A200-C4)

Horizontal

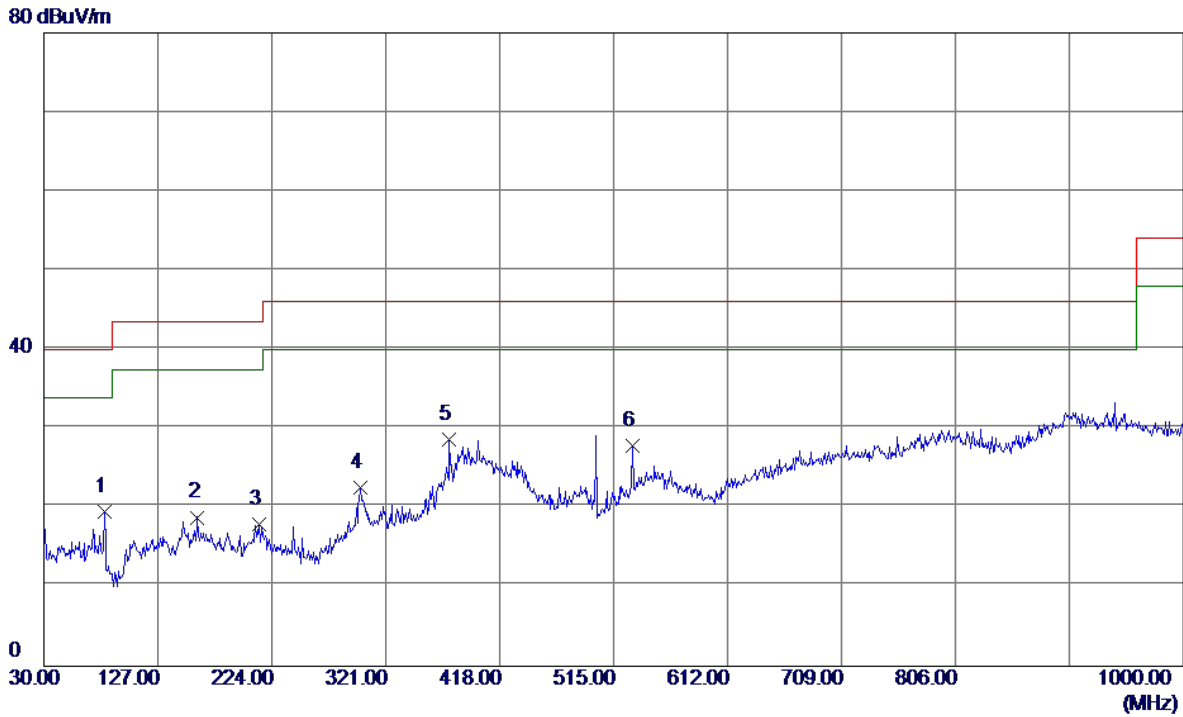

No.	Freq. MHz	Reading Level dBuV/m	Correct Factor dB	Measure ment dBuV/m	Limit dBuV/m	Margin dB	Detector	Comment
1	81.4100	35.94	-16.43	19.51	40.00	-20.49	Peak	
2	160.9500	30.96	-12.16	18.80	43.50	-24.70	Peak	
3	213.3300	32.36	-14.51	17.85	43.50	-25.65	Peak	
4	299.6600	32.78	-10.20	22.58	46.00	-23.42	Peak	
5 *	375.3200	38.05	-9.48	28.57	46.00	-17.43	Peak	
6	531.4900	34.29	-6.46	27.83	46.00	-18.17	Peak	

Test Mode: TX B MODE CHANNEL 06 (Adapter: S24B72-120A200-C4)

Vertical

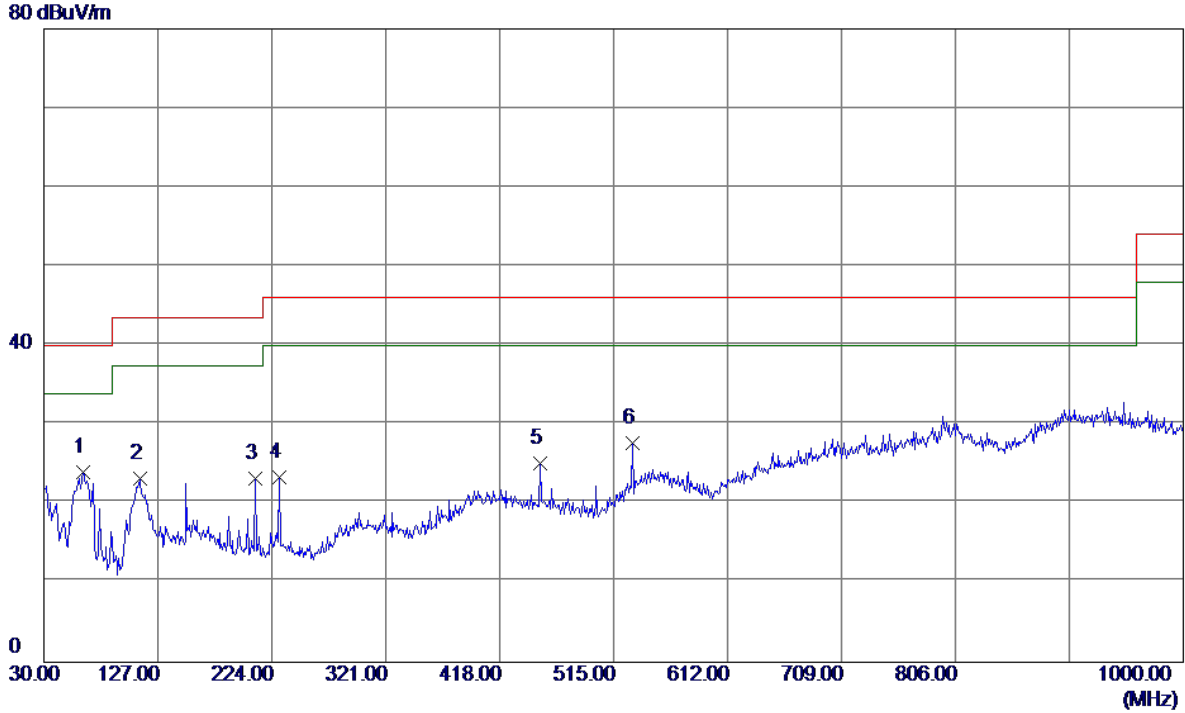

No.	Freq. MHz	Reading Level dBuV/m	Correct Factor dB	Measure ment dBuV/m	Limit dBuV/m	Margin dB	Detector	Comment
1 *	62.9800	38.63	-14.58	24.05	40.00	-15.95	Peak	
2	111.4800	37.62	-14.48	23.14	43.50	-20.36	Peak	
3	210.4200	37.85	-14.63	23.22	43.50	-20.28	Peak	
4	230.7900	36.70	-13.40	23.30	46.00	-22.70	Peak	
5	452.9200	33.24	-8.10	25.14	46.00	-20.86	Peak	
6	531.4900	34.13	-6.46	27.67	46.00	-18.33	Peak	

Test Mode: TX B MODE CHANNEL 06 (Adapter: S24B72-120A200-C4)

Horizontal

80 dBuV/m

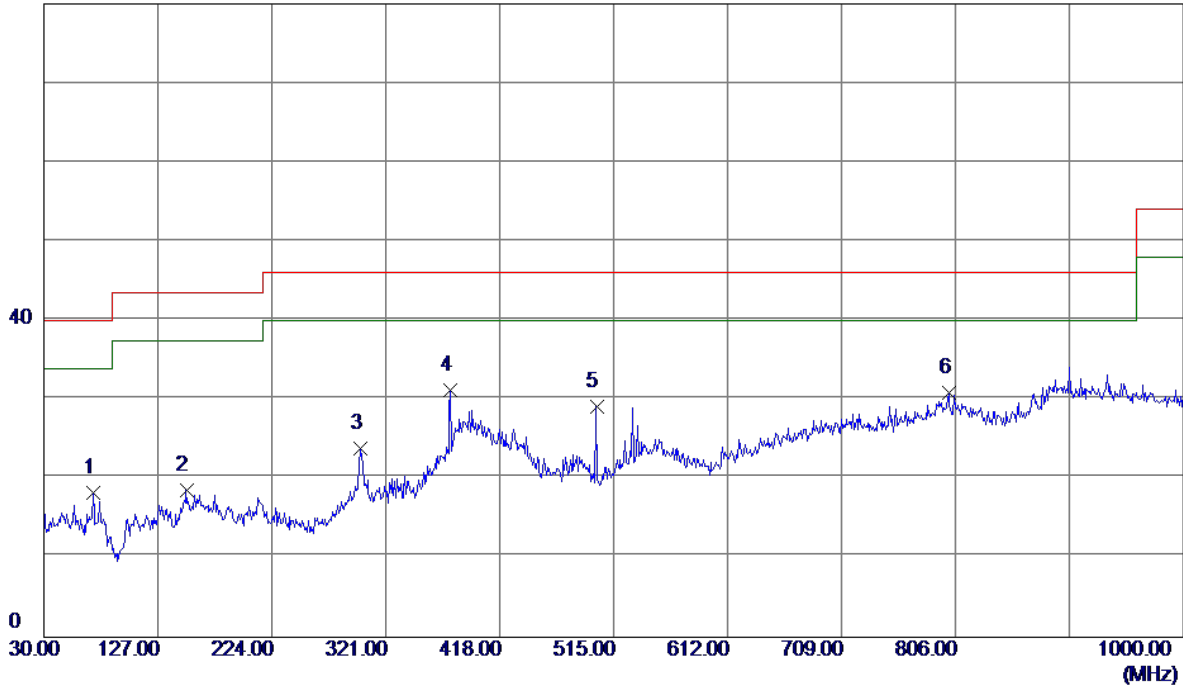

No.	Freq. MHz	Reading Level dBuV/m	Correct Factor dB	Measure ment dBuV/m	Limit dBuV/m	Margin dB	Detector	Comment
1	71.7100	34.80	-16.55	18.25	40.00	-21.75	Peak	
2	151.2500	31.42	-12.85	18.57	43.50	-24.93	Peak	
3	299.6600	34.04	-10.20	23.84	46.00	-22.16	Peak	
4 *	376.2900	40.55	-9.41	31.14	46.00	-14.86	Peak	
5	500.4500	38.83	-9.67	29.16	46.00	-16.84	Peak	
6	800.1800	30.63	0.25	30.88	46.00	-15.12	Peak	

Test Mode: TX B MODE CHANNEL 11 (Adapter: S24B72-120A200-C4)

Vertical

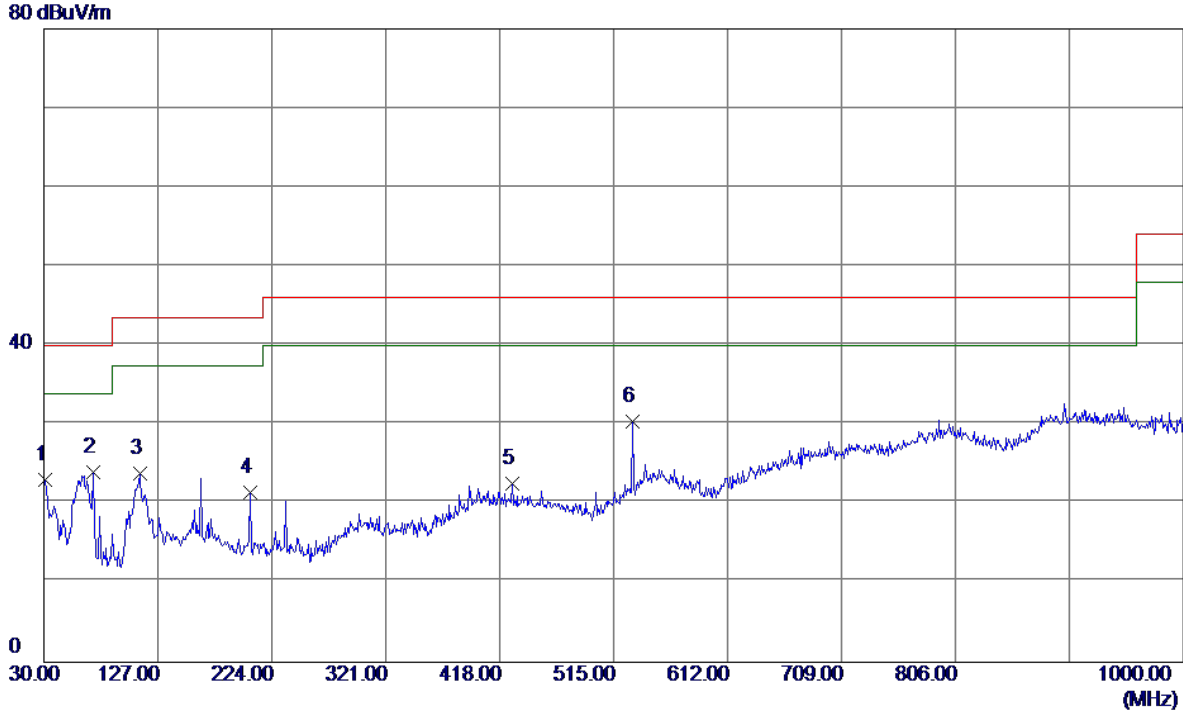

No.	Freq. MHz	Reading Level dBuV/m	Correct Factor dB	Measure ment dBuV/m	Limit dBuV/m	Margin dB	Detector	Comment
1	30.9700	37.20	-14.12	23.08	40.00	-16.92	Peak	
2	71.7100	40.48	-16.55	23.93	40.00	-16.07	Peak	
3	111.4800	38.32	-14.48	23.84	43.50	-19.66	Peak	
4	205.5700	36.02	-14.55	21.47	43.50	-22.03	Peak	
5	428.6700	30.43	-7.91	22.52	46.00	-23.48	Peak	
6 *	531.4900	36.85	-6.46	30.39	46.00	-15.61	Peak	

Test Mode: TX B MODE CHANNEL 11 (Adapter: S24B72-120A200-C4)

Horizontal

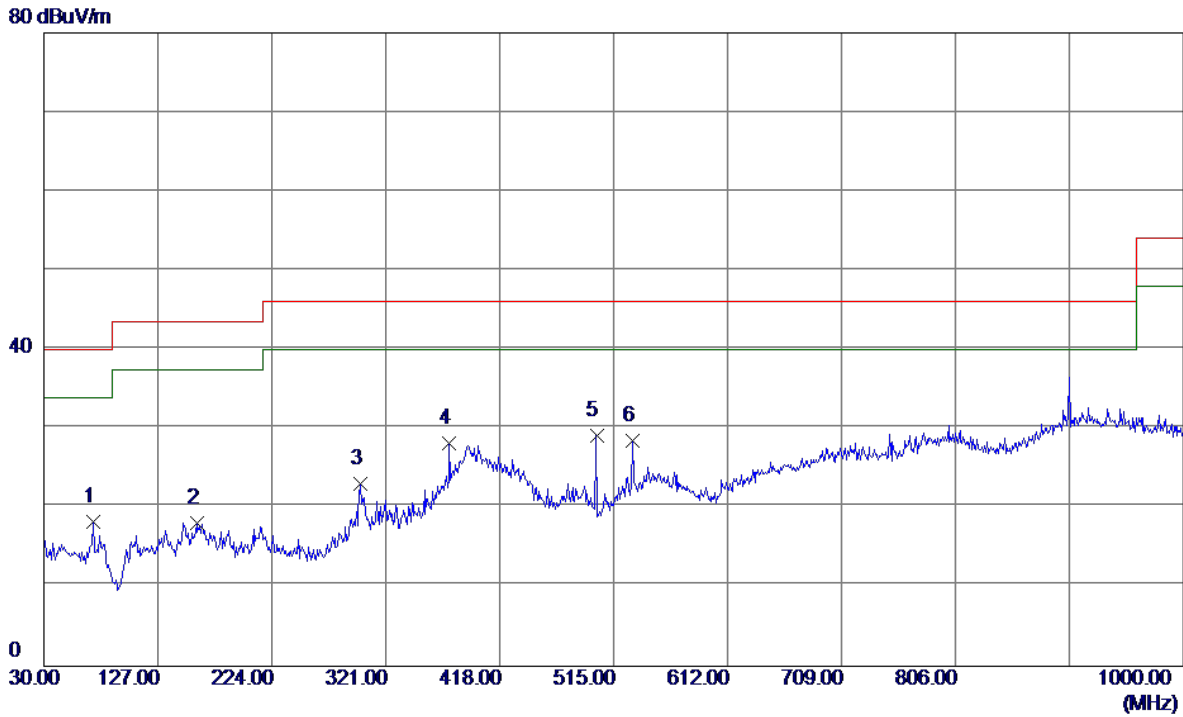

No.	Freq. MHz	Reading Level dBuV/m	Correct Factor dB	Measure ment dBuV/m	Limit dBuV/m	Margin dB	Detector	Comment
1	71.7100	34.85	-16.55	18.30	40.00	-21.70	Peak	
2	159.9800	30.25	-12.15	18.10	43.50	-25.40	Peak	
3	299.6600	33.19	-10.20	22.99	46.00	-23.01	Peak	
4	375.3200	37.61	-9.48	28.13	46.00	-17.87	Peak	
5 *	500.4500	38.79	-9.67	29.12	46.00	-16.88	Peak	
6	531.4900	34.99	-6.46	28.53	46.00	-17.47	Peak	

ATTACHMENT D - RADIATED EMISSION (ABOVE 1000MHZ)

Orthogonal Axis :	X
Test Mode :	TX B MODE 2412MHz

Vertical

120 dBuV/m

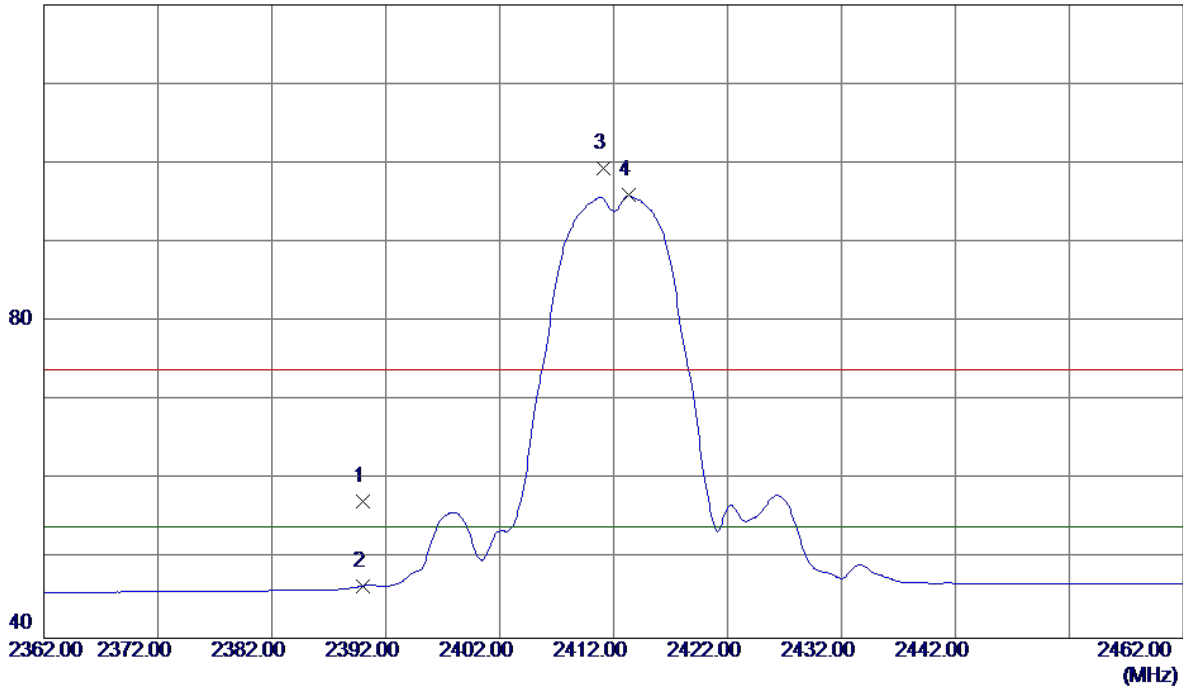

No.	Freq. MHz	Reading Level dBuV/m	Correct Factor dB	Measure ment dBuV/m	Limit dBuV/m	Margin dB	Detector	Comment
1	2390.0000	24.30	33.01	57.31	74.00	-16.69	Peak	
2	2390.0000	13.60	33.01	46.61	54.00	-7.39	AVG	
3	2411.1000	66.19	33.10	99.29	74.00	25.29	Peak	No Limit
4 *	2413.3000	62.82	33.11	95.93	54.00	41.93	AVG	No Limit

Orthogonal Axis :	X
Test Mode :	TX B MODE 2412MHz

Vertical

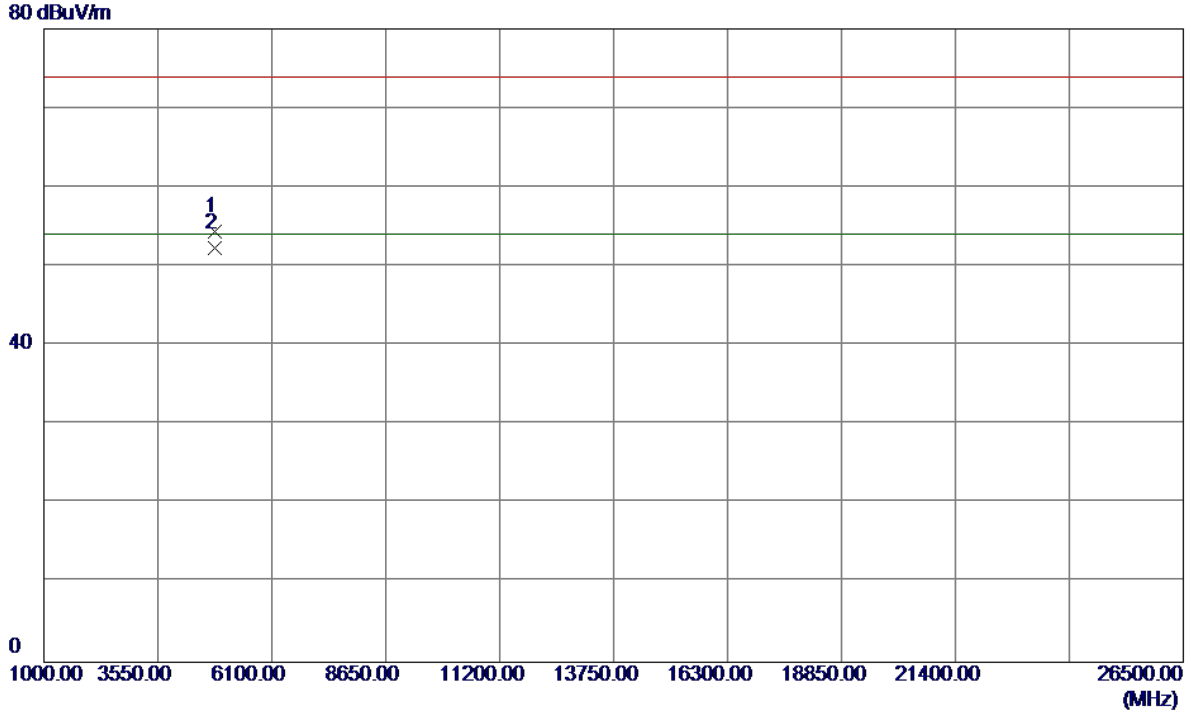

No.	Freq. MHz	Reading Level dBuV/m	Correct Factor dB	Measure ment dBuV/m	Limit dBuV/m	Margin dB	Detector	Comment
1	4823.9600	51.25	3.08	54.33	74.00	-19.67	Peak	
2 *	4824.0000	49.26	3.08	52.34	54.00	-1.66	AVG	

Orthogonal Axis :	X
Test Mode :	TX B MODE 2412MHz

Horizontal

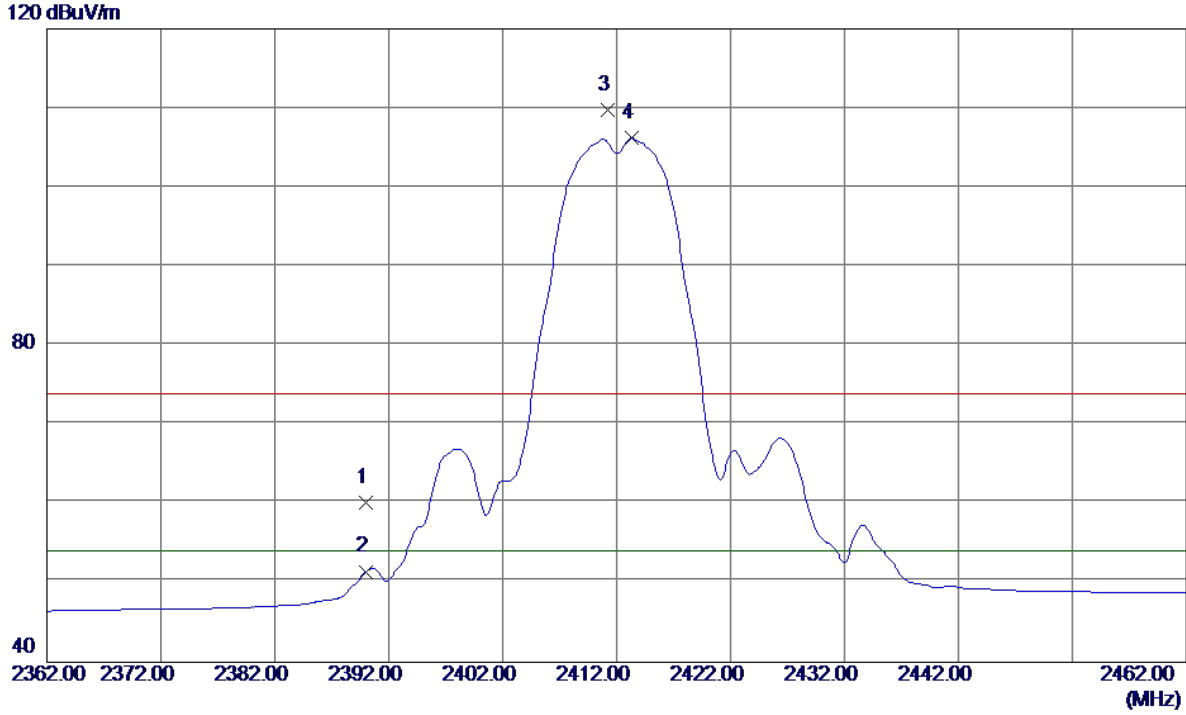

No.	Freq. MHz	Reading Level dBuV/m	Correct Factor dB	Measure ment dBuV/m	Limit dBuV/m	Margin dB	Detector	Comment
1	2390.0000	27.15	33.01	60.16	74.00	-13.84	Peak	
2	2390.0000	18.43	33.01	51.44	54.00	-2.56	AVG	
3	2411.2000	76.58	33.10	109.68	74.00	35.68	Peak	No Limit
4 *	2413.3000	73.10	33.11	106.21	54.00	52.21	AVG	No Limit

Orthogonal Axis :	X
Test Mode :	TX B MODE 2412MHz

Horizontal

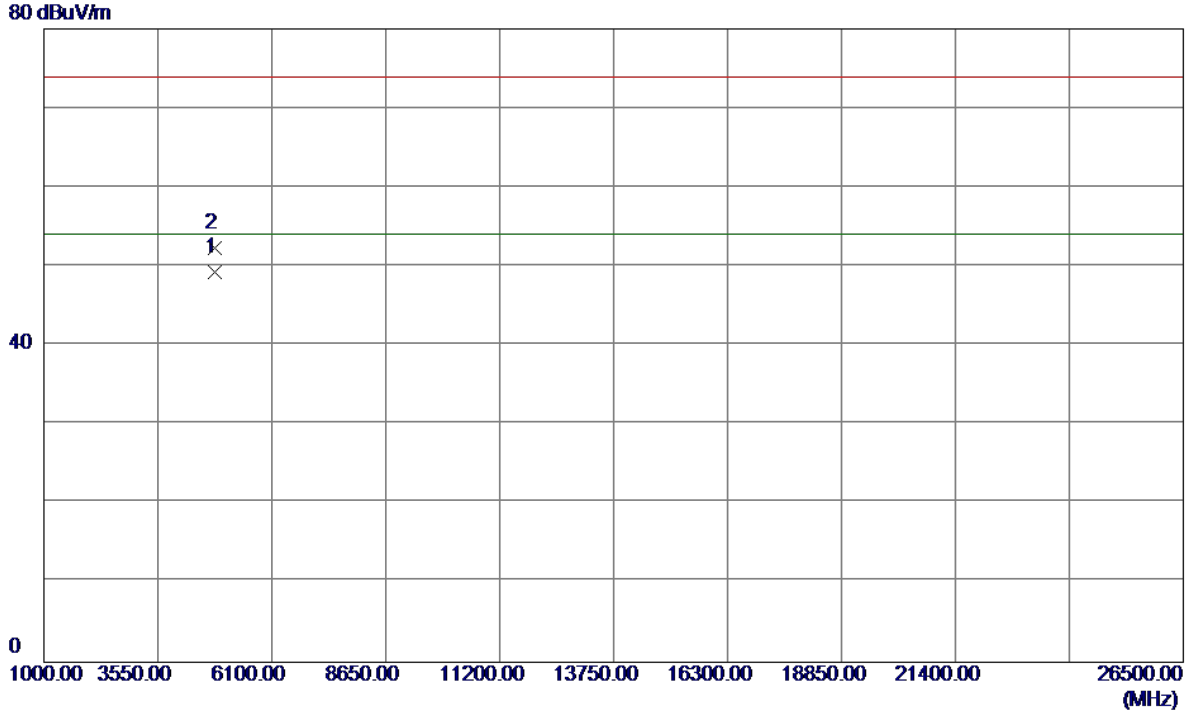

No.	Freq. MHz	Reading Level dBuV/m	Correct Factor dB	Measure ment dBuV/m	Limit dBuV/m	Margin dB	Detector	Comment
1 *	4824.0000	46.23	3.08	49.31	54.00	-4.69	AVG	
2	4824.1000	49.18	3.08	52.26	74.00	-21.74	Peak	

Orthogonal Axis :	X
Test Mode :	TX B MODE 2437MHz

Vertical

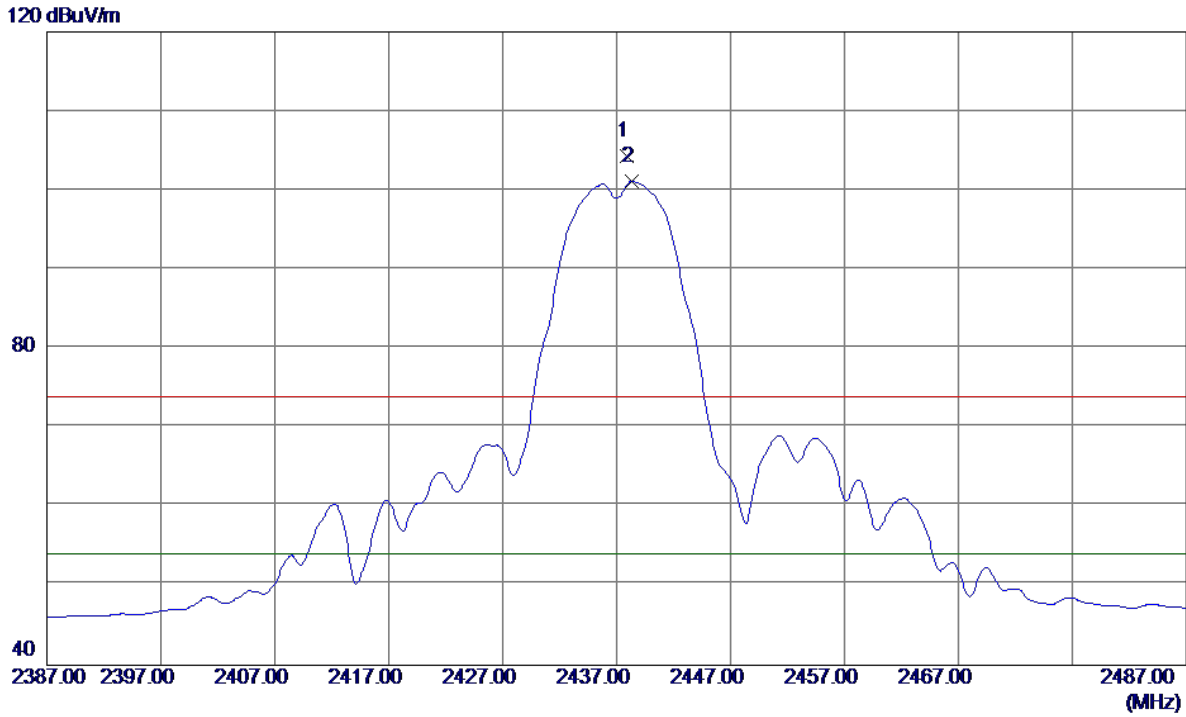

No.	Freq. MHz	Reading Level dBuV/m	Correct Factor dB	Measure ment dBuV/m	Limit dBuV/m	Margin dB	Detector	Comment
1	2437.9000	71.16	33.21	104.37	74.00	30.37	Peak	No Limit
2 *	2438.3000	67.97	33.21	101.18	54.00	47.18	AVG	No Limit

Orthogonal Axis :	X
Test Mode :	TX B MODE 2437MHz

Vertical

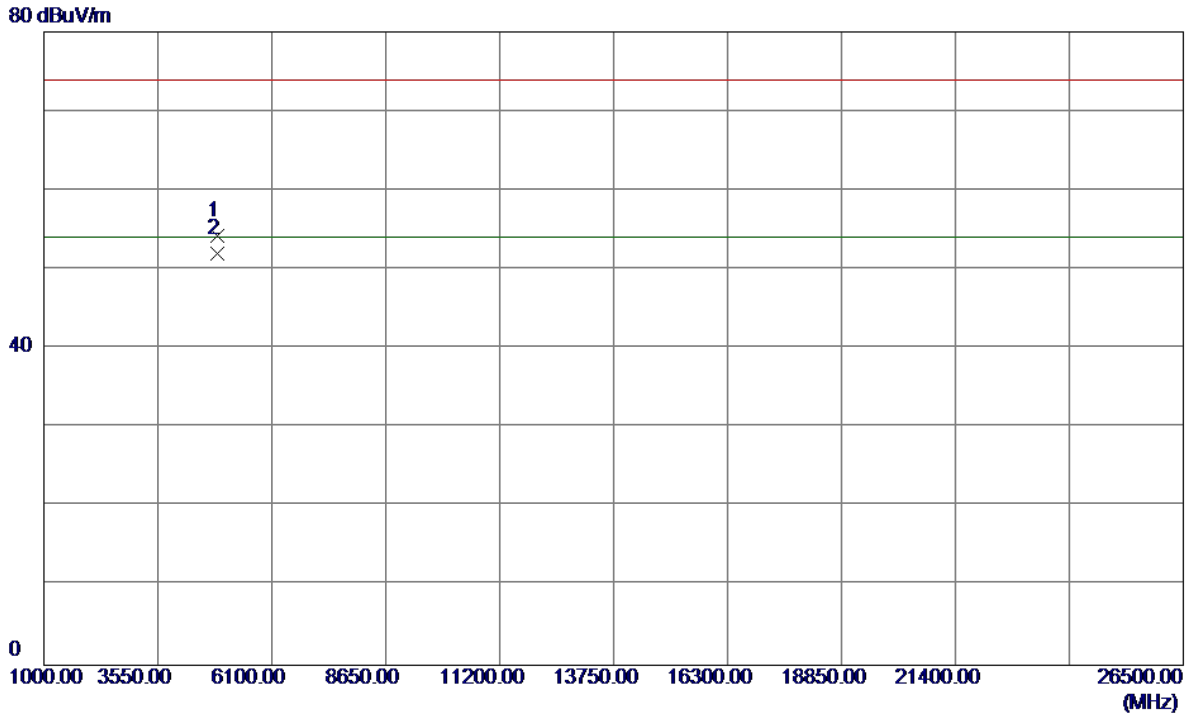

No.	Freq. MHz	Reading Level dBuV/m	Correct Factor dB	Measure ment dBuV/m	Limit dBuV/m	Margin dB	Detector	Comment
1	4874.0000	51.00	3.24	54.24	74.00	-19.76	Peak	
2 *	4874.0000	48.75	3.24	51.99	54.00	-2.01	AVG	

Orthogonal Axis :	X
Test Mode :	TX B MODE 2437MHz

Horizontal

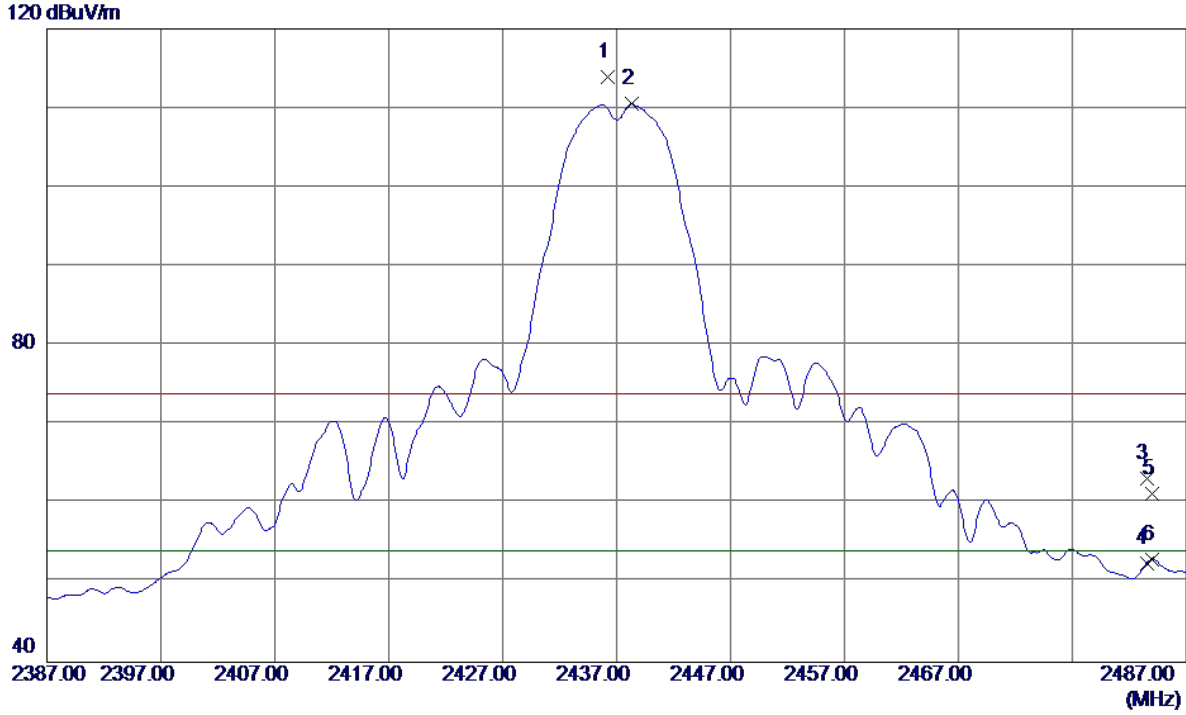

No.	Freq. MHz	Reading Level dBuV/m	Correct Factor dB	Measure ment dBuV/m	Limit dBuV/m	Margin dB	Detector	Comment
1	2436.2000	80.66	33.20	113.86	74.00	39.86	Peak	No Limit
2 *	2438.3000	77.33	33.21	110.54	54.00	56.54	AVG	No Limit
3	2483.5000	29.80	33.40	63.20	74.00	-10.80	Peak	
4	2483.5000	19.10	33.40	52.50	54.00	-1.50	AVG	
5	2484.0000	27.81	33.40	61.21	74.00	-12.79	Peak	
6	2484.0000	19.54	33.40	52.94	54.00	-1.06	AVG	

Orthogonal Axis :	X
Test Mode :	TX B MODE 2437MHz

Horizontal

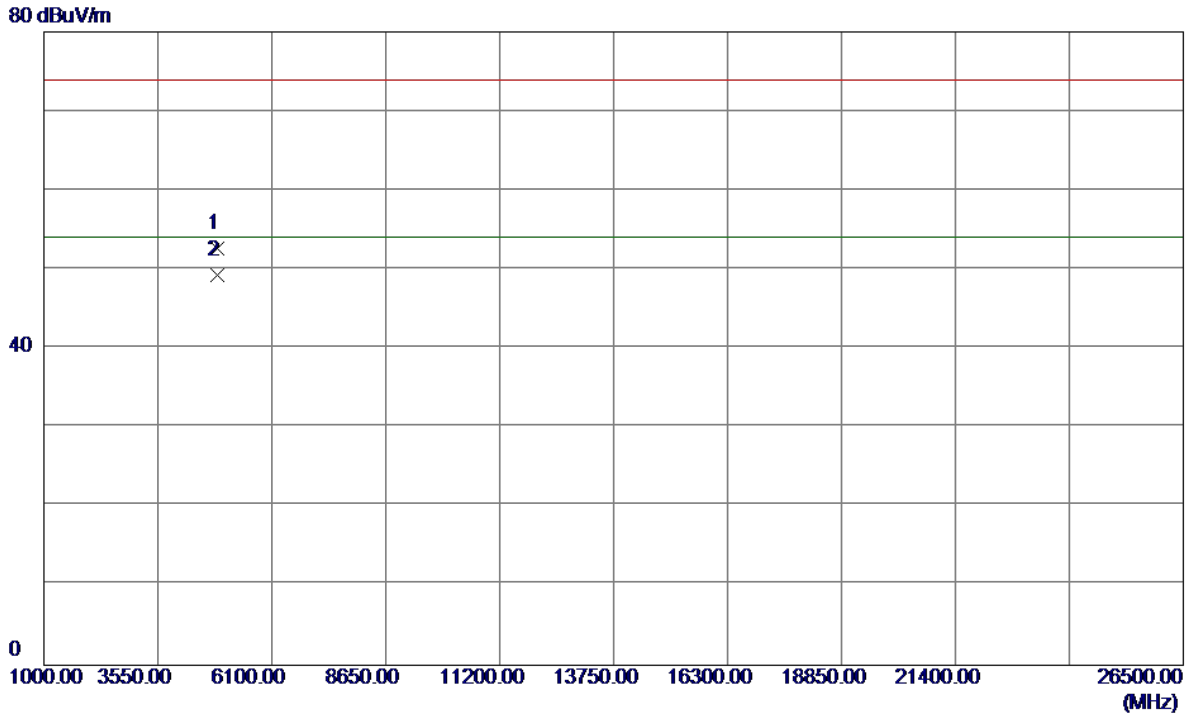

No.	Freq. MHz	Reading Level dBuV/m	Correct Factor dB	Measure ment dBuV/m	Limit dBuV/m	Margin dB	Detector	Comment
1	4874.0000	49.46	3.24	52.70	74.00	-21.30	Peak	
2 *	4874.0000	46.06	3.24	49.30	54.00	-4.70	AVG	

Orthogonal Axis :	X
Test Mode :	TX B MODE 2462MHz

Vertical

120 dBuV/m

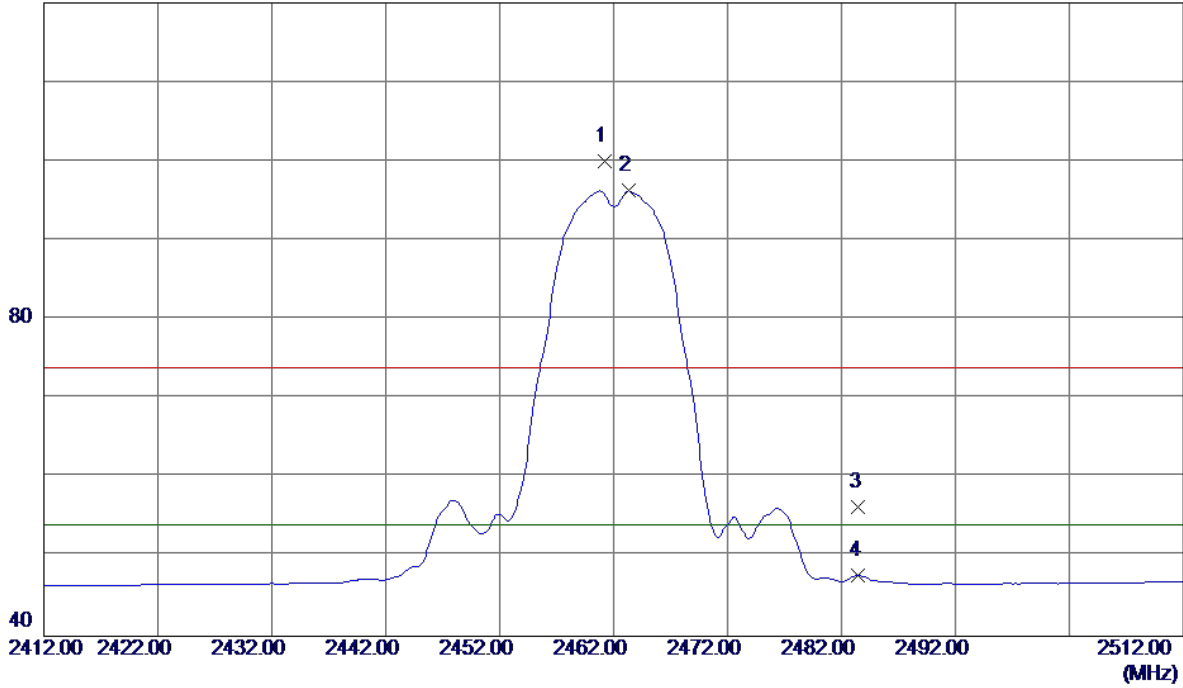

No.	Freq. MHz	Reading Level dBuV/m	Correct Factor dB	Measure ment dBuV/m	Limit dBuV/m	Margin dB	Detector	Comment
1	2461.2000	66.72	33.31	100.03	74.00	26.03	Peak	No Limit
2 *	2463.3000	62.94	33.32	96.26	54.00	42.26	AVG	No Limit
3	2483.5000	22.92	33.40	56.32	74.00	-17.68	Peak	
4	2483.5000	14.22	33.40	47.62	54.00	-6.38	AVG	

Orthogonal Axis :	X
Test Mode :	TX B MODE 2462MHz

Vertical

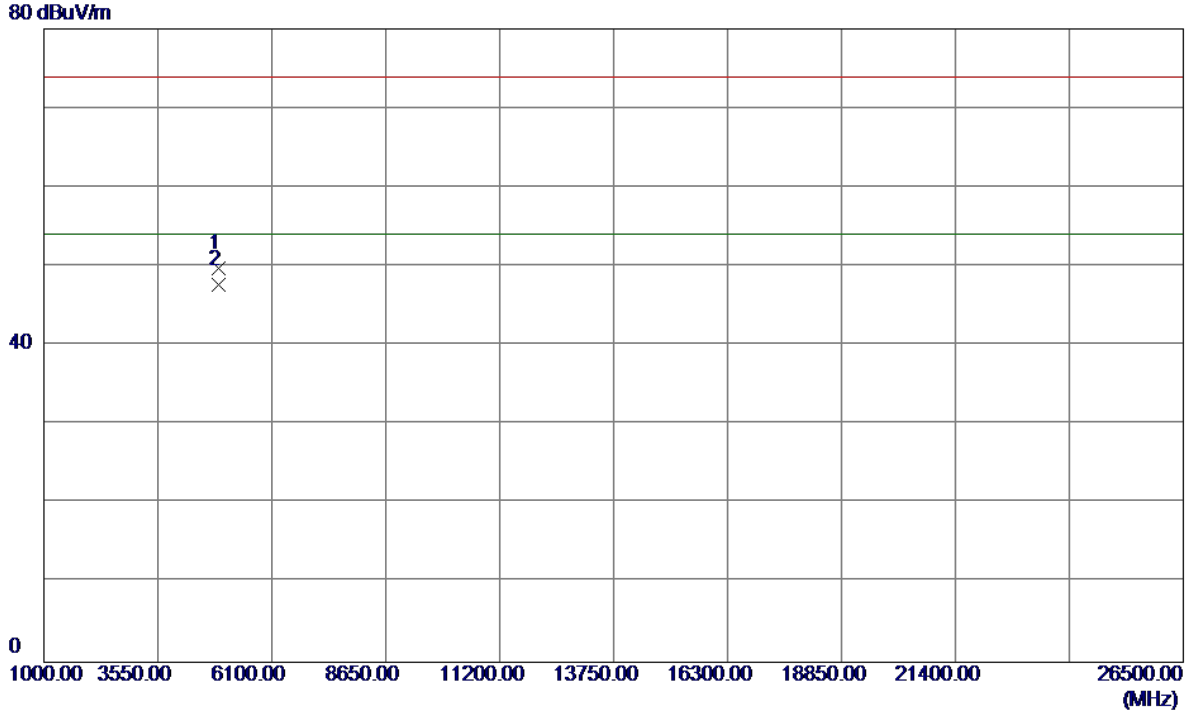

No.	Freq. MHz	Reading Level dBuV/m	Correct Factor dB	Measure ment dBuV/m	Limit dBuV/m	Margin dB	Detector	Comment
1	4923.9600	46.42	3.39	49.81	74.00	-24.19	Peak	
2 *	4924.0000	44.28	3.39	47.67	54.00	-6.33	AVG	

Orthogonal Axis :	X
Test Mode :	TX B MODE 2462MHz

Horizontal

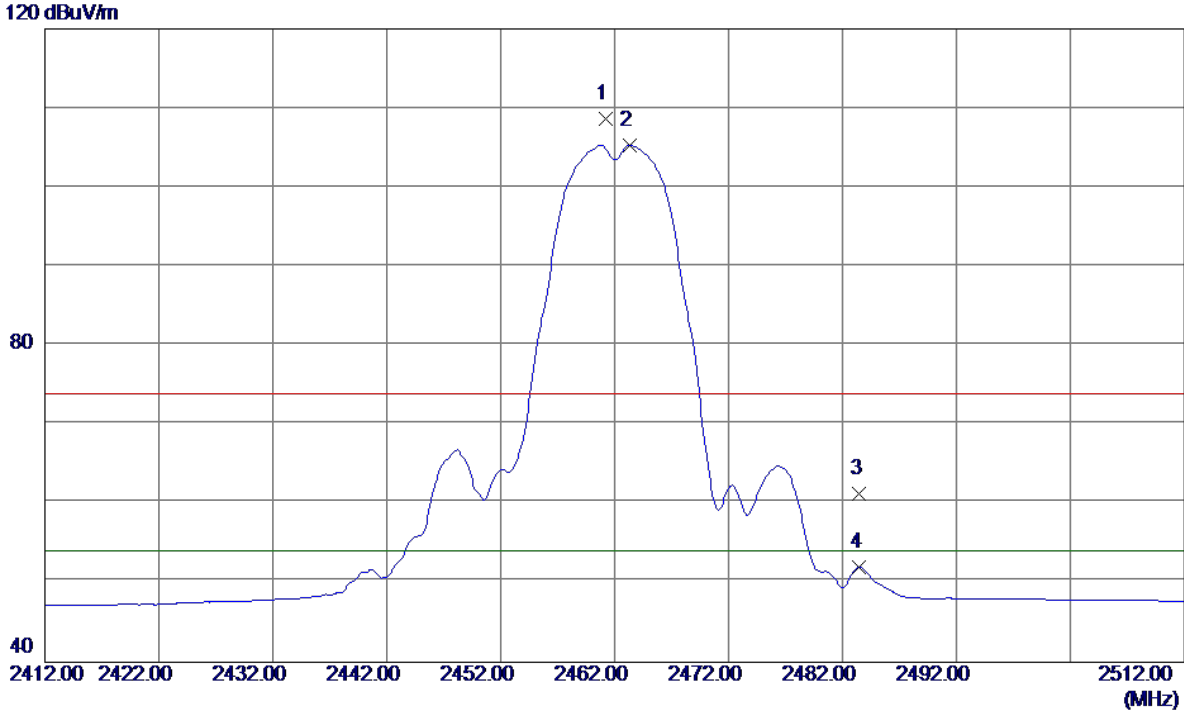

No.	Freq. MHz	Reading Level dBuV/m	Correct Factor dB	Measure ment dBuV/m	Limit dBuV/m	Margin dB	Detector	Comment
1	2461.2000	75.31	33.31	108.62	74.00	34.62	Peak	No Limit
2 *	2463.3000	72.02	33.32	105.34	54.00	51.34	AVG	No Limit
3	2483.5000	27.89	33.40	61.29	74.00	-12.71	Peak	
4	2483.5000	18.61	33.40	52.01	54.00	-1.99	AVG	

Orthogonal Axis :	X
Test Mode :	TX B MODE 2462MHz

Horizontal

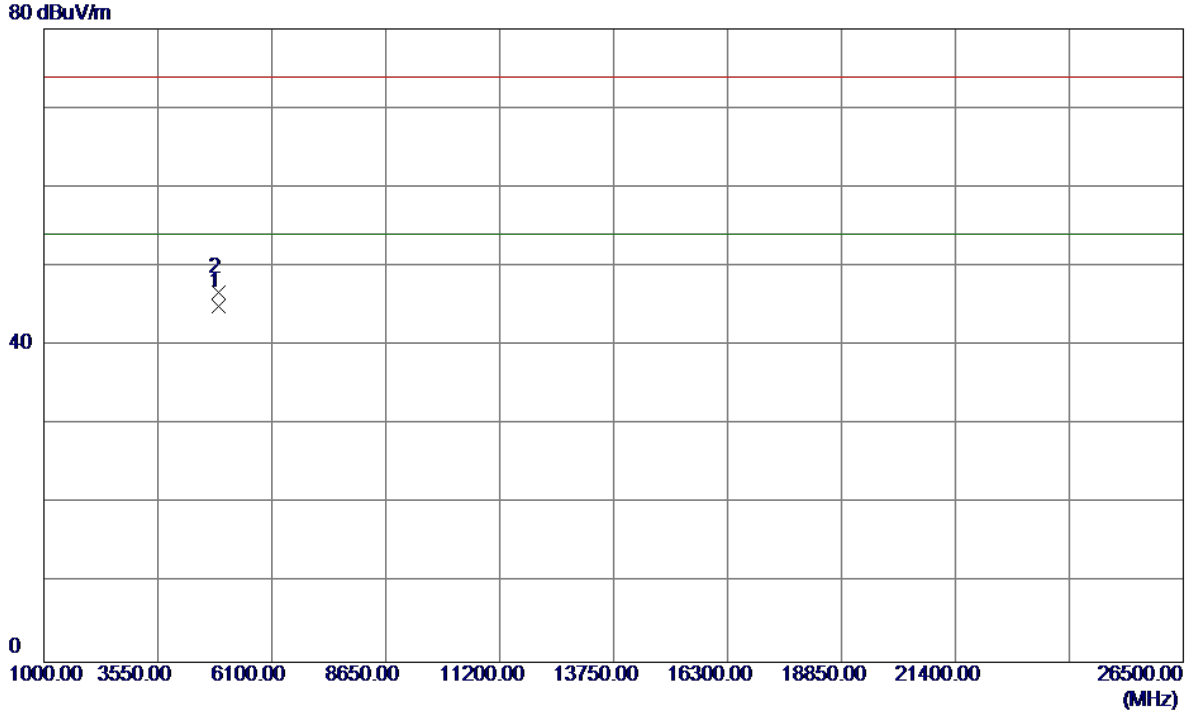

No.	Freq. MHz	Reading Level dBuV/m	Correct Factor dB	Measure ment dBuV/m	Limit dBuV/m	Margin dB	Detector	Comment
1 *	4924.0000	41.59	3.39	44.98	54.00	-9.02	AVG	
2	4924.1000	43.39	3.39	46.78	74.00	-27.22	Peak	

Orthogonal Axis :	X
Test Mode :	TX G MODE 2412MHz

Vertical

120 dBuV/m

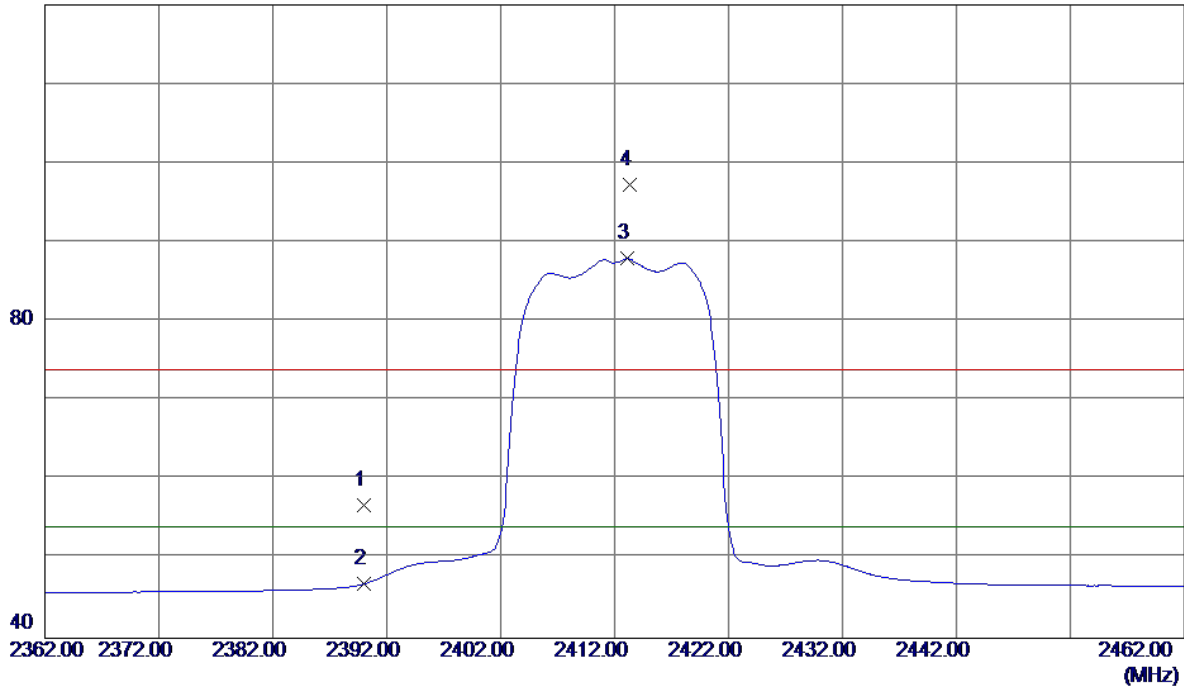

No.	Freq. MHz	Reading Level dBuV/m	Correct Factor dB	Measure ment dBuV/m	Limit dBuV/m	Margin dB	Detector	Comment
1	2390.0000	23.81	33.01	56.82	74.00	-17.18	Peak	
2	2390.0000	13.85	33.01	46.86	54.00	-7.14	AVG	
3 *	2413.1000	54.83	33.11	87.94	54.00	33.94	AVG	No Limit
4	2413.3000	64.18	33.11	97.29	74.00	23.29	Peak	No Limit

Orthogonal Axis :	X
Test Mode :	TX G MODE 2412MHz

Vertical

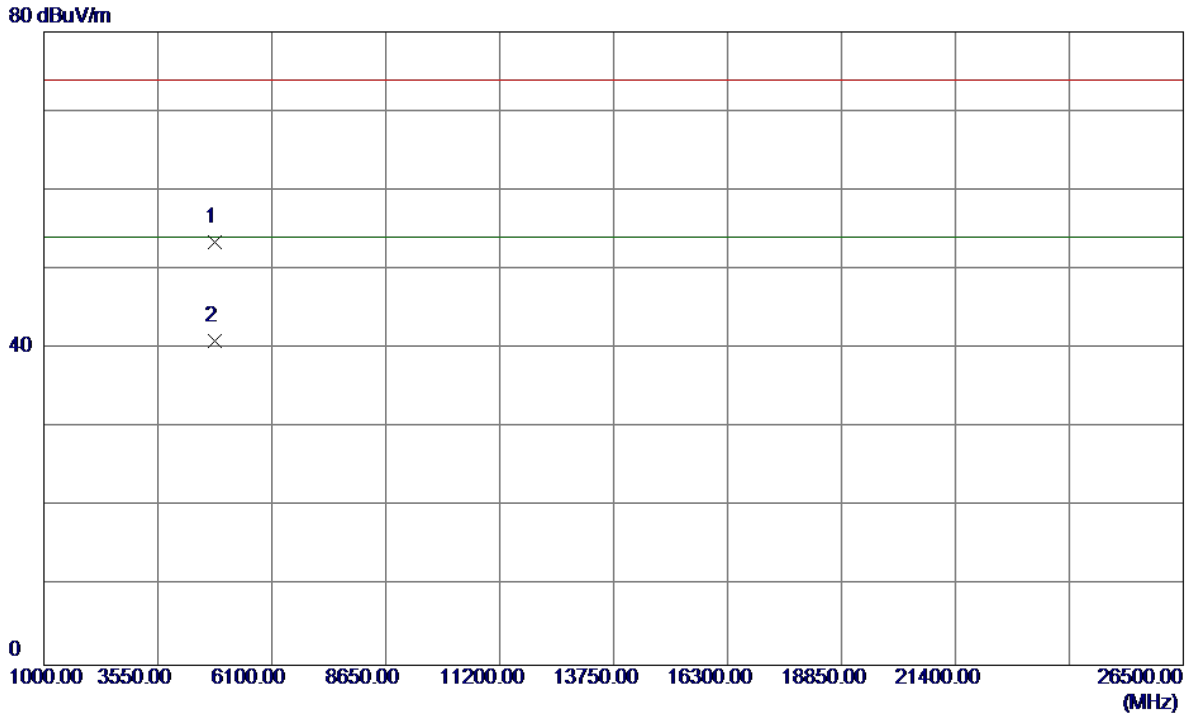

No.	Freq. MHz	Reading Level dBuV/m	Correct Factor dB	Measure ment dBuV/m	Limit dBuV/m	Margin dB	Detector	Comment
1	4822.9600	50.36	3.08	53.44	74.00	-20.56	Peak	
2 *	4824.0000	37.83	3.08	40.91	54.00	-13.09	AVG	

Orthogonal Axis :	X
Test Mode :	TX G MODE 2412MHz

Horizontal

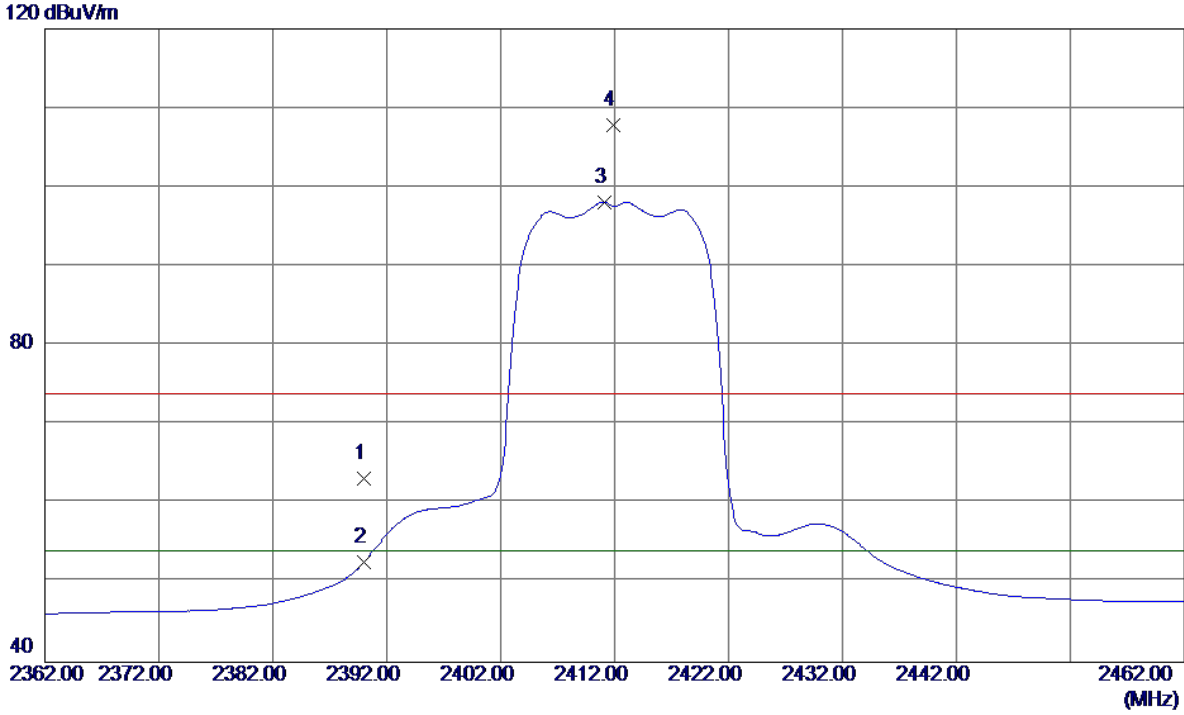

No.	Freq. MHz	Reading Level dBuV/m	Correct Factor dB	Measure ment dBuV/m	Limit dBuV/m	Margin dB	Detector	Comment
1	2390.0000	30.25	33.01	63.26	74.00	-10.74	Peak	
2	2390.0000	19.66	33.01	52.67	54.00	-1.33	AVG	
3 *	2411.1000	65.03	33.10	98.13	54.00	44.13	AVG	No Limit
4	2411.9000	74.68	33.10	107.78	74.00	33.78	Peak	No Limit

Orthogonal Axis :	X
Test Mode :	TX G MODE 2412MHz

Horizontal

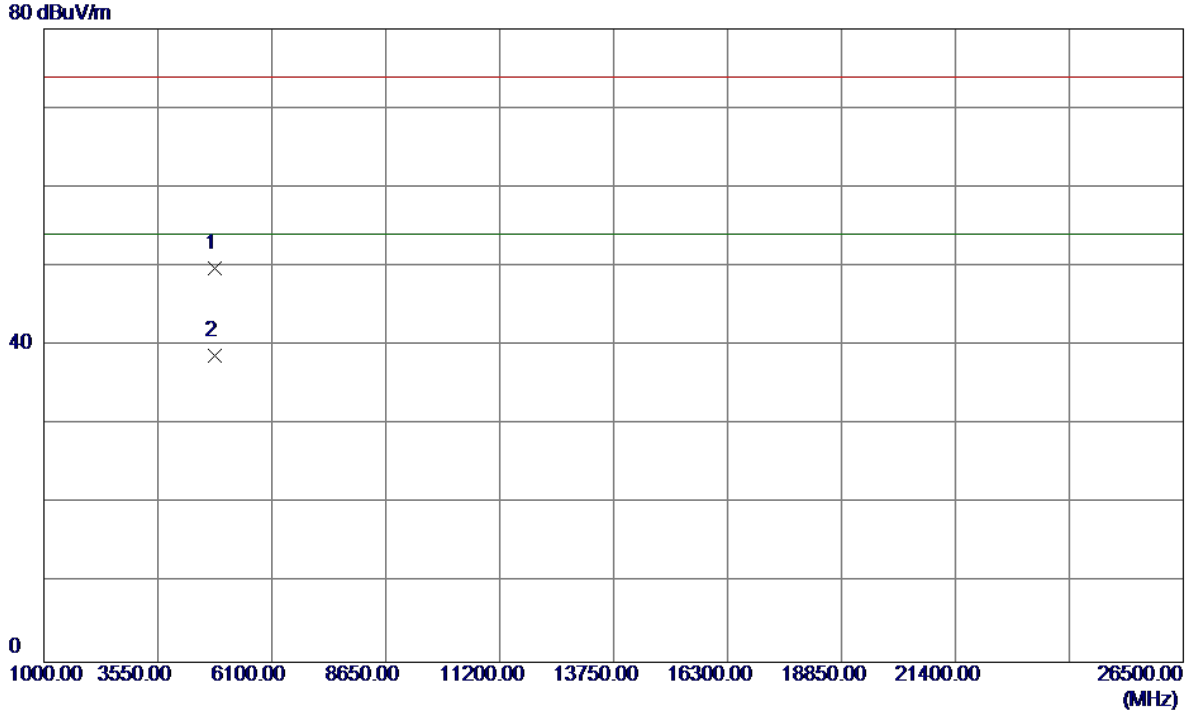

No.	Freq. MHz	Reading Level dBuV/m	Correct Factor dB	Measure ment dBuV/m	Limit dBuV/m	Margin dB	Detector	Comment
1	4823.9500	46.73	3.08	49.81	74.00	-24.19	Peak	
2 *	4823.9500	35.71	3.08	38.79	54.00	-15.21	AVG	

Orthogonal Axis :	X
Test Mode :	TX G MODE 2437MHz

Vertical

120 dBuV/m

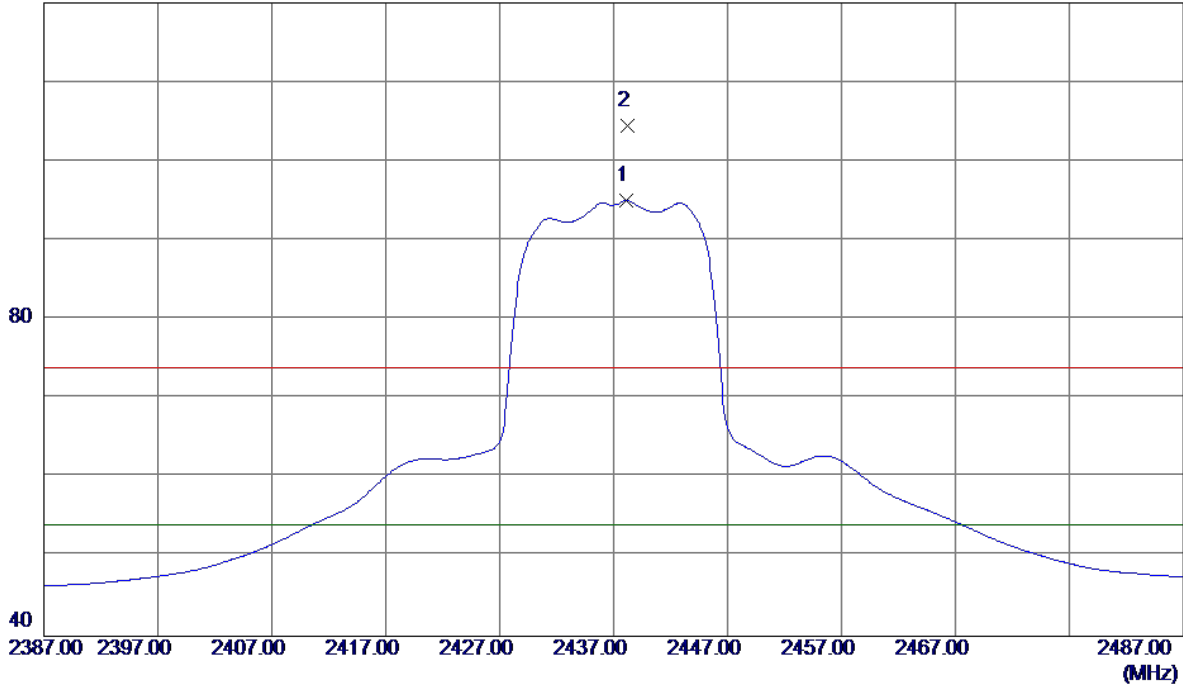

No.	Freq. MHz	Reading Level dBuV/m	Correct Factor dB	Measure ment dBuV/m	Limit dBuV/m	Margin dB	Detector	Comment
1 *	2438.1000	61.83	33.21	95.04	54.00	41.04	AVG	No Limit
2	2438.2000	71.23	33.21	104.44	74.00	30.44	Peak	No Limit

Orthogonal Axis :	X
Test Mode :	TX G MODE 2437MHz

Vertical

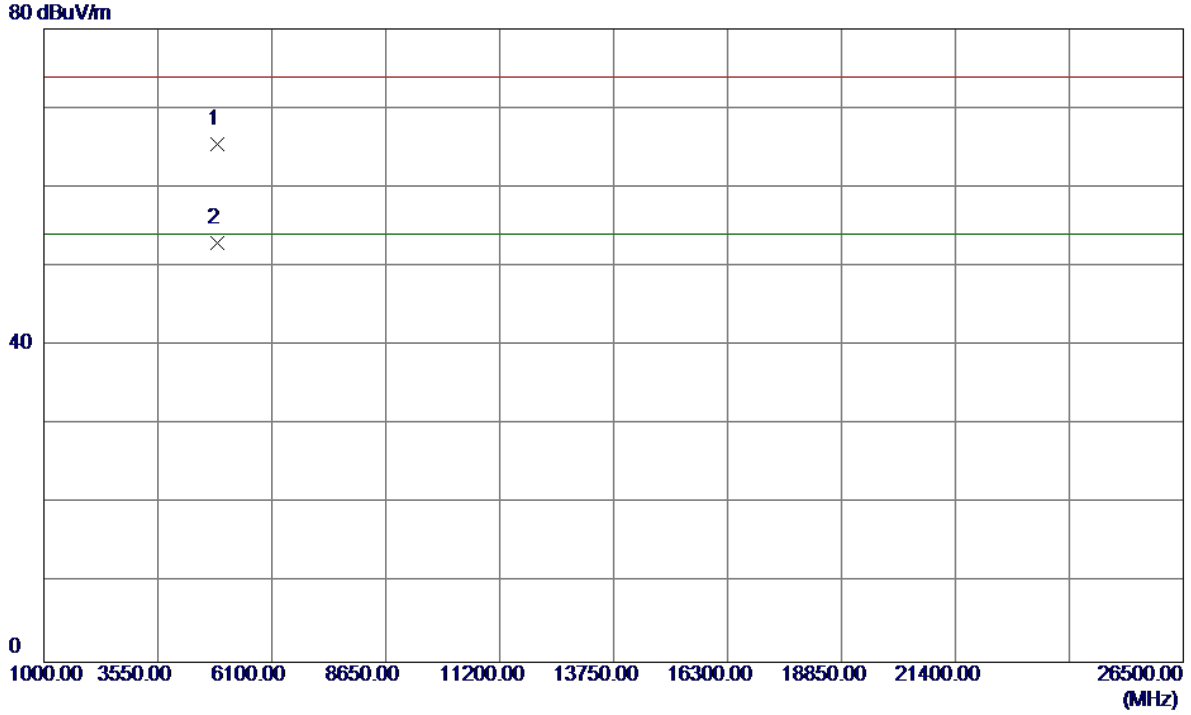

No.	Freq. MHz	Reading Level dBuV/m	Correct Factor dB	Measure ment dBuV/m	Limit dBuV/m	Margin dB	Detector	Comment
1	4868.2000	62.15	3.22	65.37	74.00	-8.63	Peak	
2 *	4874.1200	49.72	3.24	52.96	54.00	-1.04	AVG	

Orthogonal Axis :	X
Test Mode :	TX G MODE 2437MHz

Horizontal

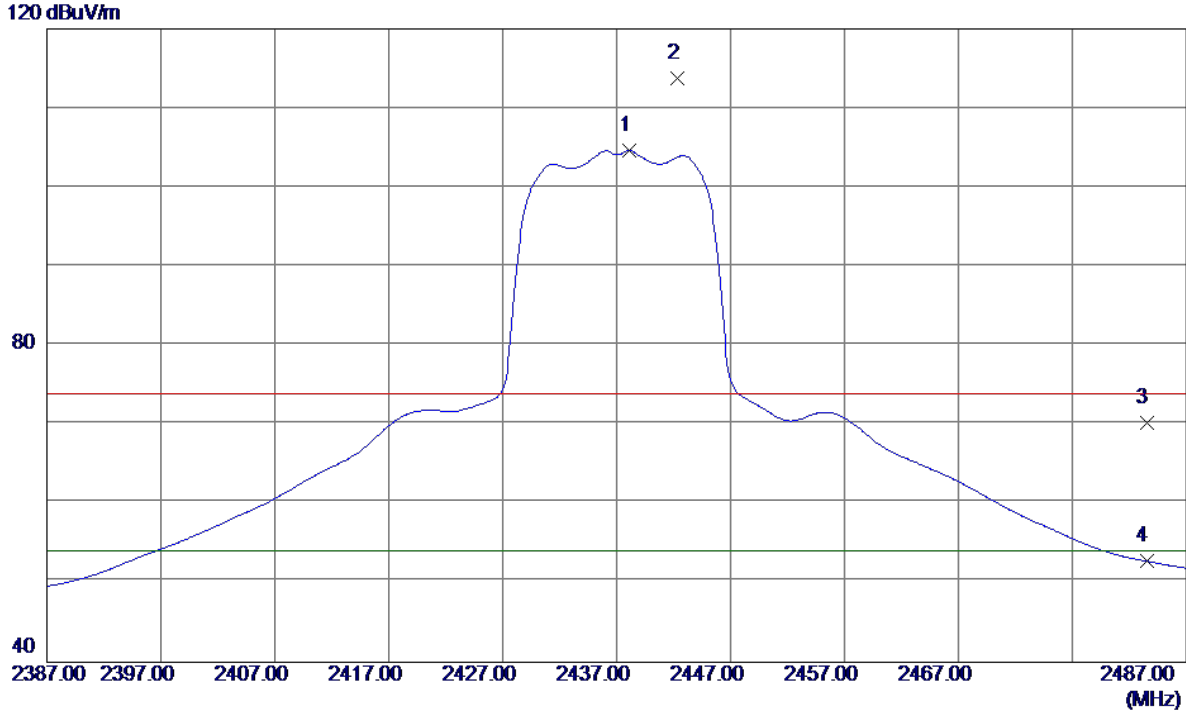

No.	Freq. MHz	Reading Level dBuV/m	Correct Factor dB	Measure ment dBuV/m	Limit dBuV/m	Margin dB	Detector	Comment
1 *	2438.1000	71.41	33.21	104.62	54.00	50.62	AVG	No Limit
2	2442.3000	80.48	33.23	113.71	74.00	39.71	Peak	No Limit
3	2483.5000	36.83	33.40	70.23	74.00	-3.77	Peak	
4	2483.5000	19.38	33.40	52.78	54.00	-1.22	AVG	

Orthogonal Axis :	X
Test Mode :	TX G MODE 2437MHz

Horizontal

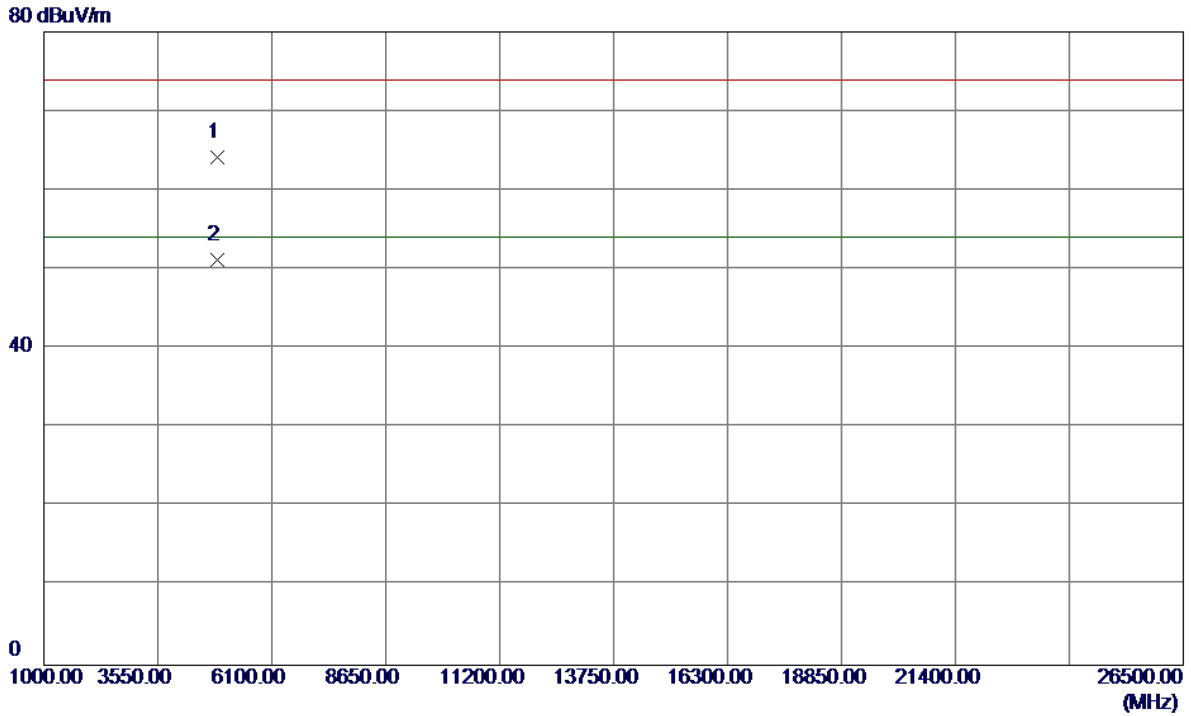

No.	Freq. MHz	Reading Level dBuV/m	Correct Factor dB	Measure ment dBuV/m	Limit dBuV/m	Margin dB	Detector	Comment
1	4873.0500	60.91	3.23	64.14	74.00	-9.86	Peak	
2 *	4874.0500	48.03	3.24	51.27	54.00	-2.73	AVG	

Orthogonal Axis :	X
Test Mode :	TX G MODE 2462MHz

Vertical

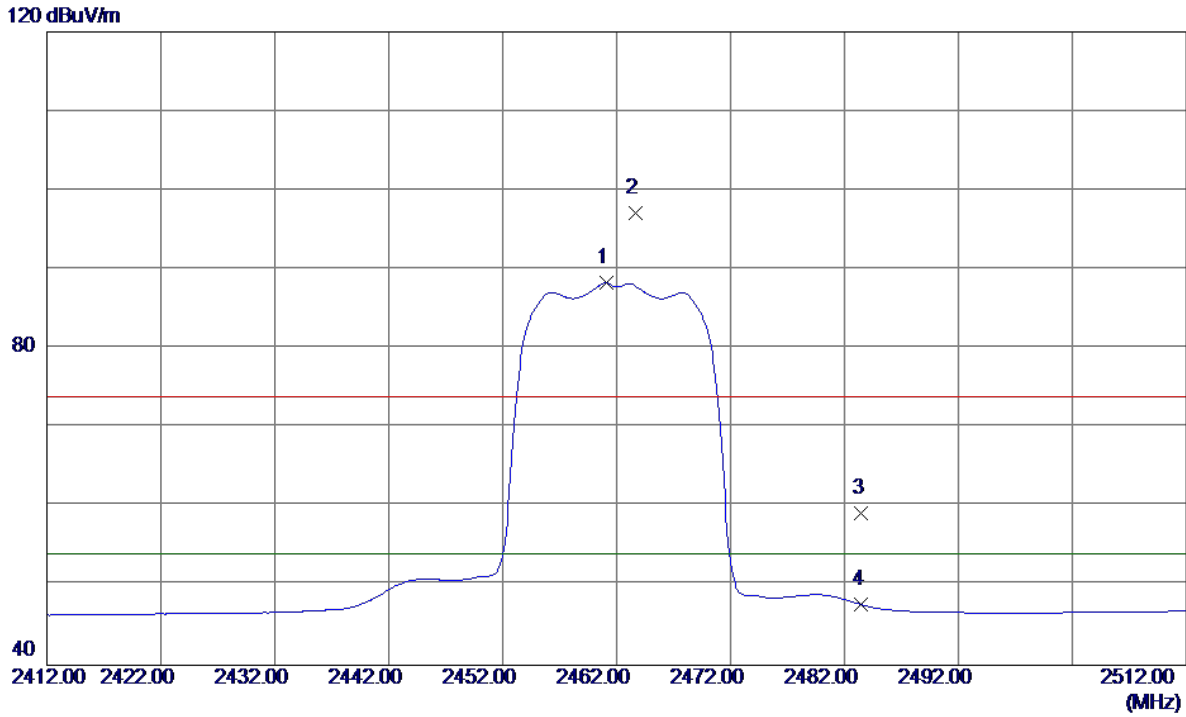

No.	Freq. MHz	Reading Level dBuV/m	Correct Factor dB	Measure ment dBuV/m	Limit dBuV/m	Margin dB	Detector	Comment
1 *	2461.1000	54.97	33.31	88.28	54.00	34.28	AVG	No Limit
2	2463.7000	63.86	33.32	97.18	74.00	23.18	Peak	No Limit
3	2483.5000	25.79	33.40	59.19	74.00	-14.81	Peak	
4	2483.5000	14.26	33.40	47.66	54.00	-6.34	AVG	

Orthogonal Axis :	X
Test Mode :	TX G MODE 2462MHz

Vertical

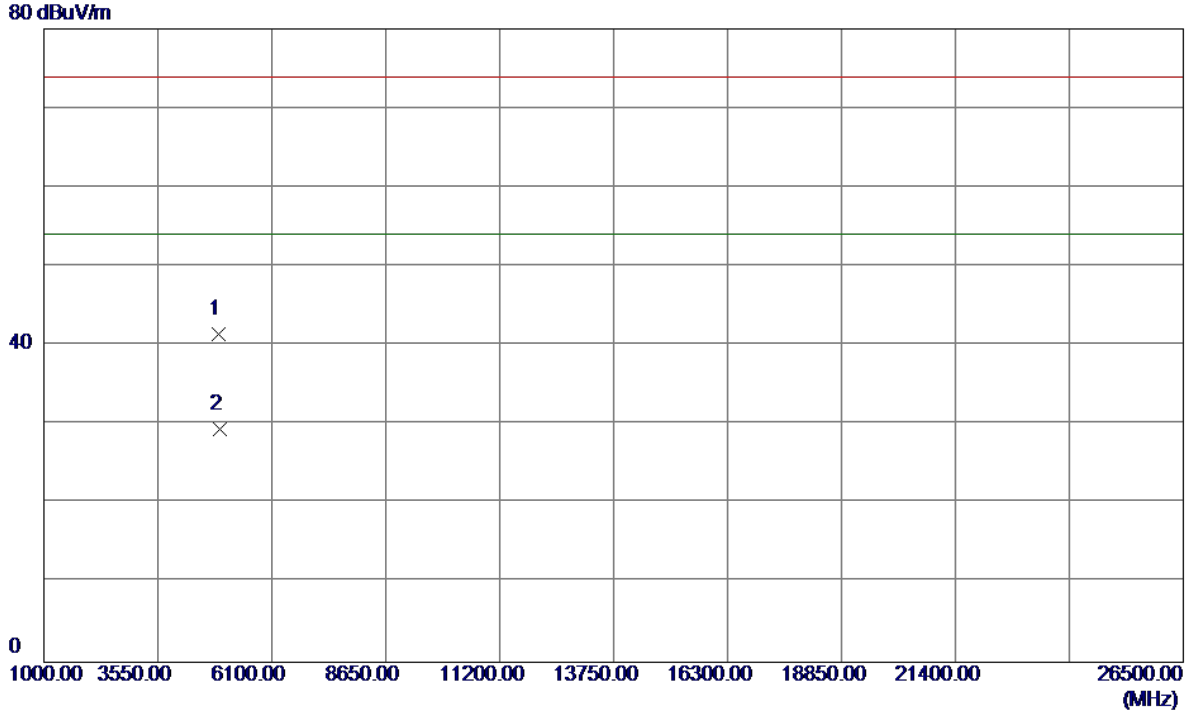

No.	Freq. MHz	Reading Level dBuV/m	Correct Factor dB	Measure ment dBuV/m	Limit dBuV/m	Margin dB	Detector	Comment
1	4916.8400	38.14	3.37	41.51	74.00	-32.49	Peak	
2 *	4924.2000	26.08	3.39	29.47	54.00	-24.53	AVG	

Orthogonal Axis :	X
Test Mode :	TX G MODE 2462MHz

Horizontal

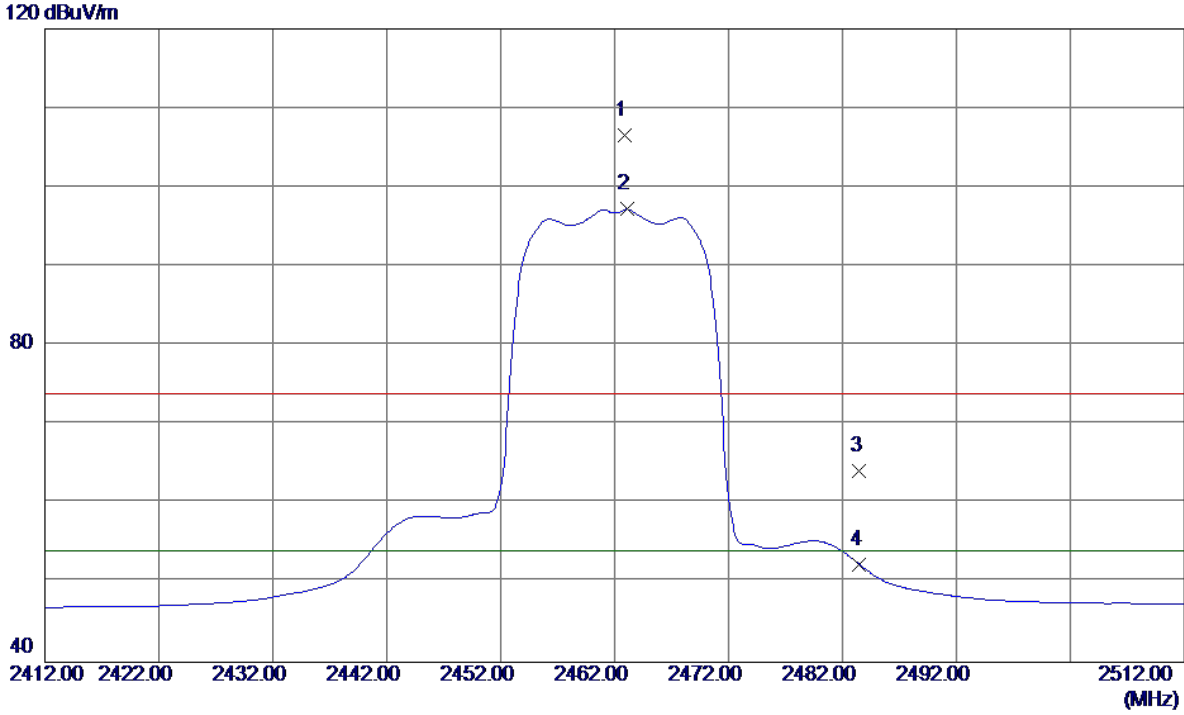

No.	Freq. MHz	Reading Level dBuV/m	Correct Factor dB	Measure ment dBuV/m	Limit dBuV/m	Margin dB	Detector	Comment
1	2462.9000	73.25	33.31	106.56	74.00	32.56	Peak	No Limit
2 *	2463.1000	63.89	33.32	97.21	54.00	43.21	AVG	No Limit
3	2483.5000	30.79	33.40	64.19	74.00	-9.81	Peak	
4	2483.5000	18.95	33.40	52.35	54.00	-1.65	AVG	

Orthogonal Axis :	X
Test Mode :	TX G MODE 2462MHz

Horizontal

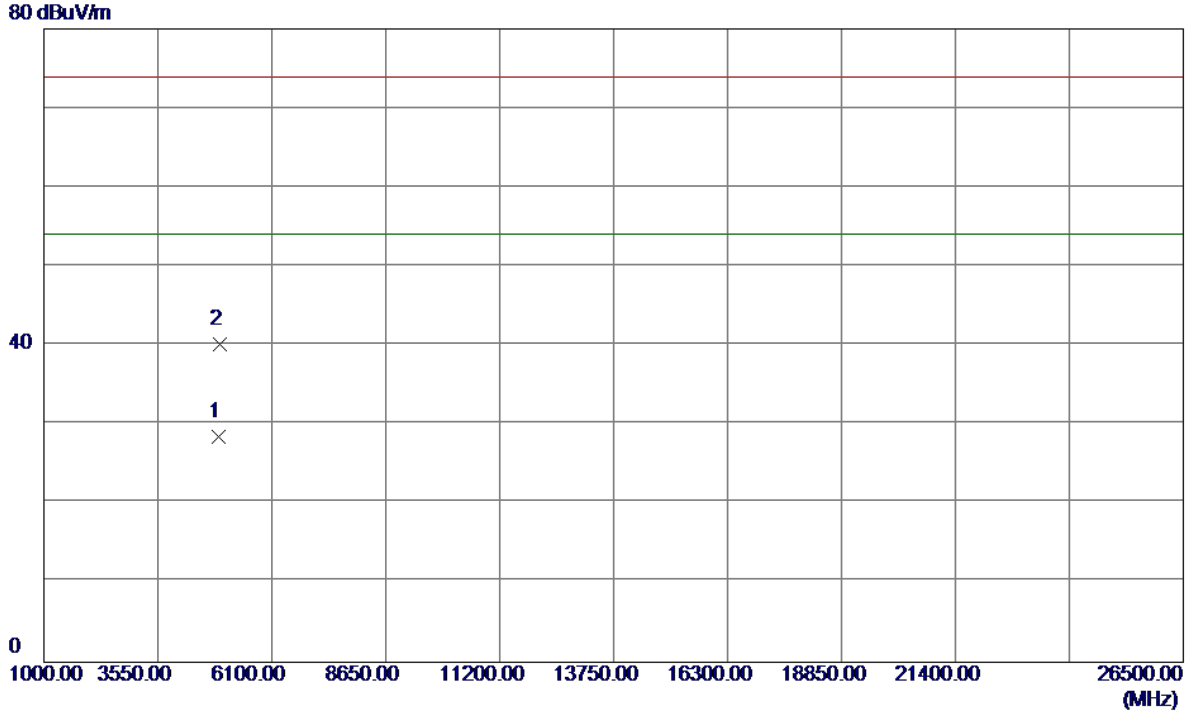

No.	Freq. MHz	Reading Level dBuV/m	Correct Factor dB	Measure ment dBuV/m	Limit dBuV/m	Margin dB	Detector	Comment
1 *	4923.9500	25.12	3.39	28.51	54.00	-25.49	AVG	
2	4925.6000	36.69	3.40	40.09	74.00	-33.91	Peak	

Orthogonal Axis :	X
Test Mode :	TX N-20M MODE 2412MHz

Vertical

120 dBuV/m

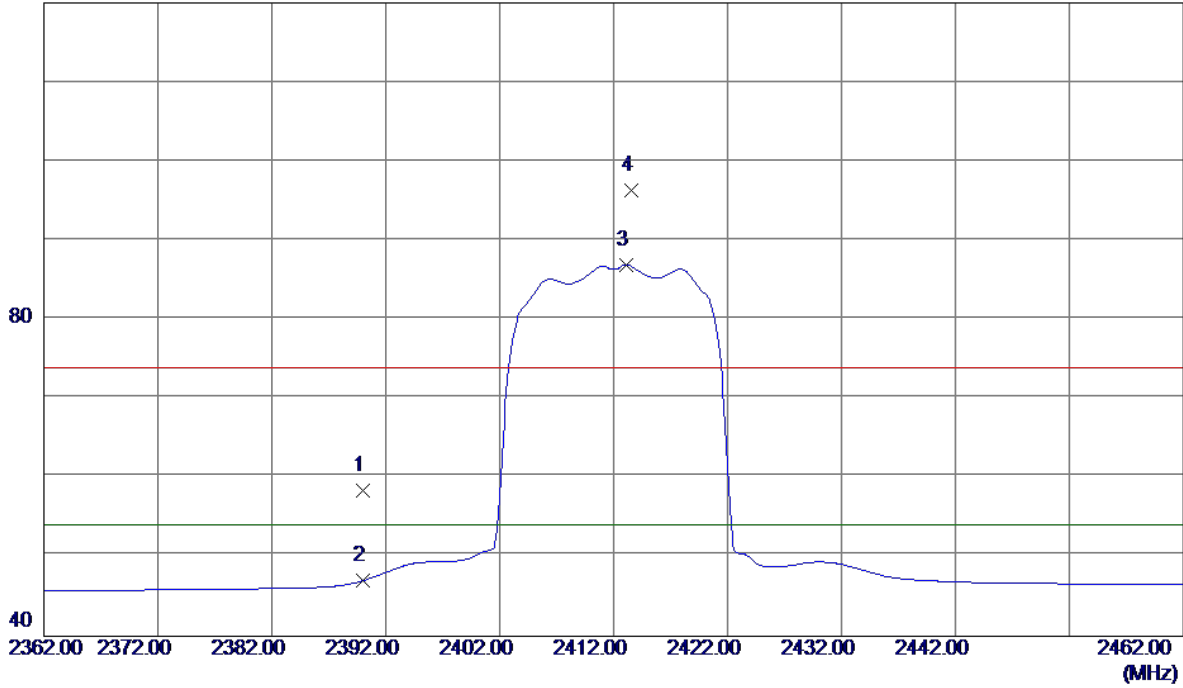

No.	Freq. MHz	Reading Level dBuV/m	Correct Factor dB	Measure ment dBuV/m	Limit dBuV/m	Margin dB	Detector	Comment
1	2390.0000	25.46	33.01	58.47	74.00	-15.53	Peak	
2	2390.0000	14.01	33.01	47.02	54.00	-6.98	AVG	
3 *	2413.1000	53.84	33.11	86.95	54.00	32.95	AVG	No Limit
4	2413.6000	63.22	33.11	96.33	74.00	22.33	Peak	No Limit

Orthogonal Axis :	X
Test Mode :	TX N-20M MODE 2412MHz

Vertical

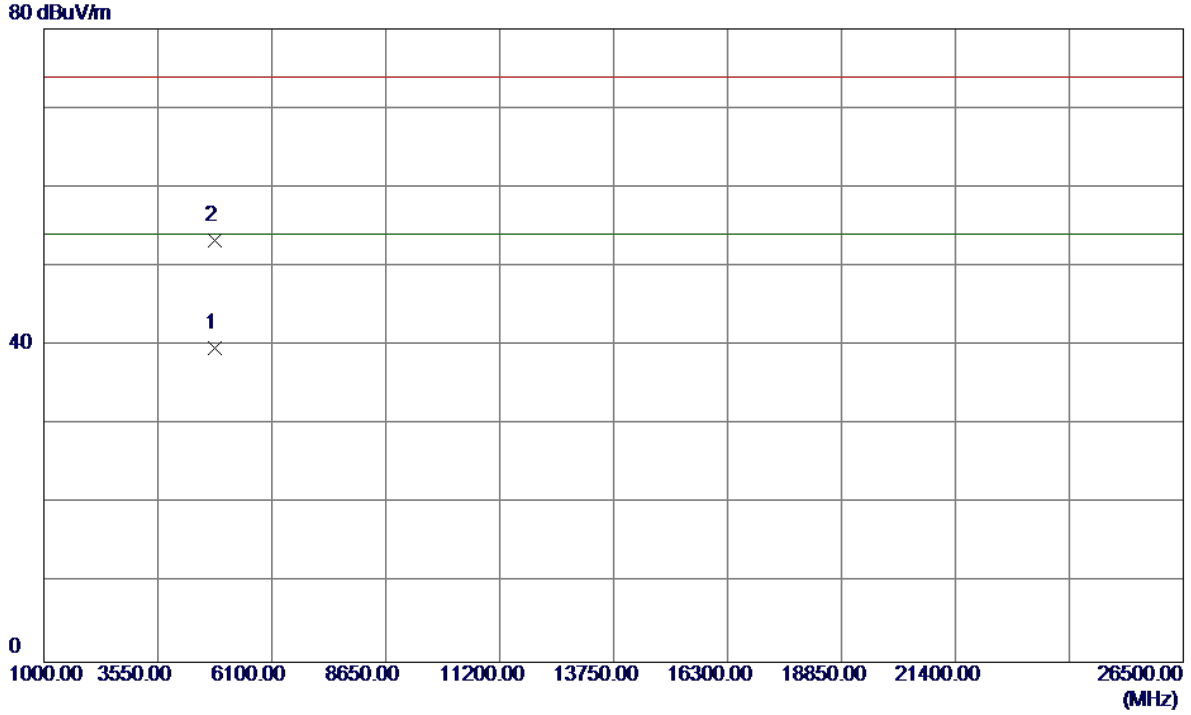

No.	Freq. MHz	Reading Level dBuV/m	Correct Factor dB	Measure ment dBuV/m	Limit dBuV/m	Margin dB	Detector	Comment
1 *	4823.9600	36.66	3.08	39.74	54.00	-14.26	AVG	
2	4824.8000	50.16	3.08	53.24	74.00	-20.76	Peak	

Orthogonal Axis :	X
Test Mode :	TX N-20M MODE 2412MHz

Horizontal

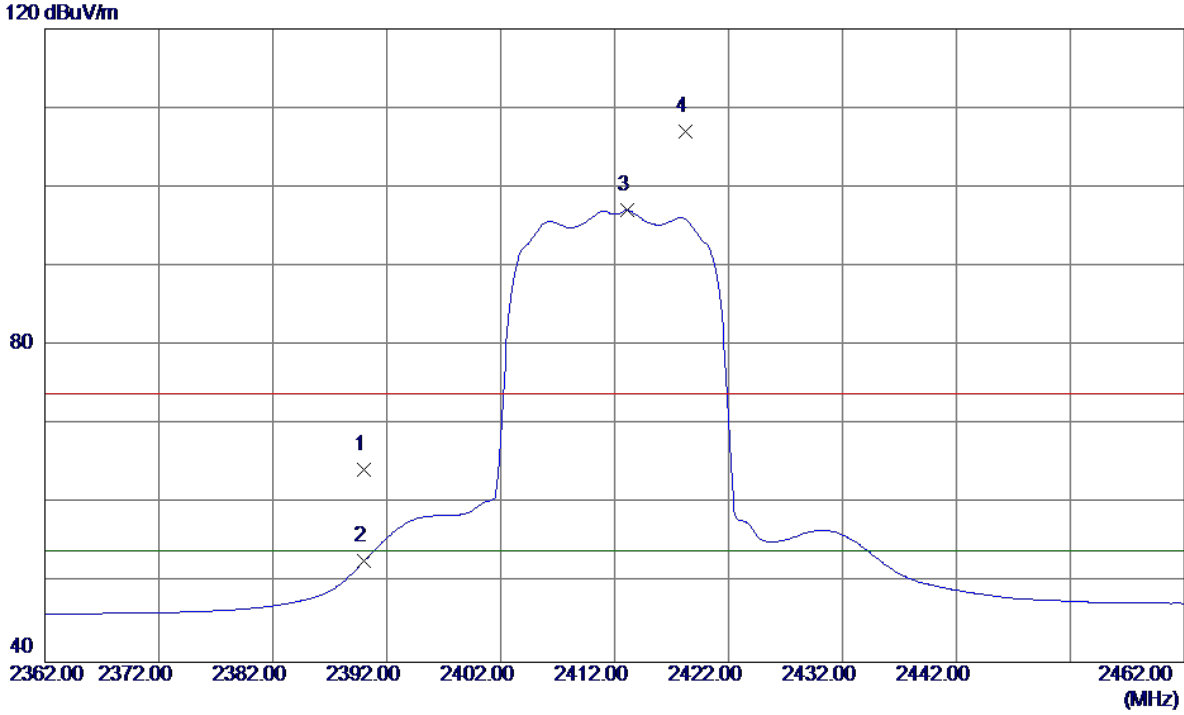

No.	Freq. MHz	Reading Level dBuV/m	Correct Factor dB	Measure ment dBuV/m	Limit dBuV/m	Margin dB	Detector	Comment
1	2390.0000	31.34	33.01	64.35	74.00	-9.65	Peak	
2	2390.0000	19.73	33.01	52.74	54.00	-1.26	AVG	
3 *	2413.1000	63.98	33.11	97.09	54.00	43.09	AVG	No Limit
4	2418.2000	73.98	33.13	107.11	74.00	33.11	Peak	No Limit

Orthogonal Axis :	X
Test Mode :	TX N-20M MODE 2412MHz

Horizontal



No.	Freq. MHz	Reading Level dBuV/m	Correct Factor dB	Measure ment dBuV/m	Limit dBuV/m	Margin dB	Detector	Comment
1	4823.6500	48.18	3.08	51.26	74.00	-22.74	Peak	
2 *	4824.0500	35.56	3.08	38.64	54.00	-15.36	AVG	

Orthogonal Axis :	X
Test Mode :	TX N-20M MODE 2437MHz

Vertical

120 dBuV/m

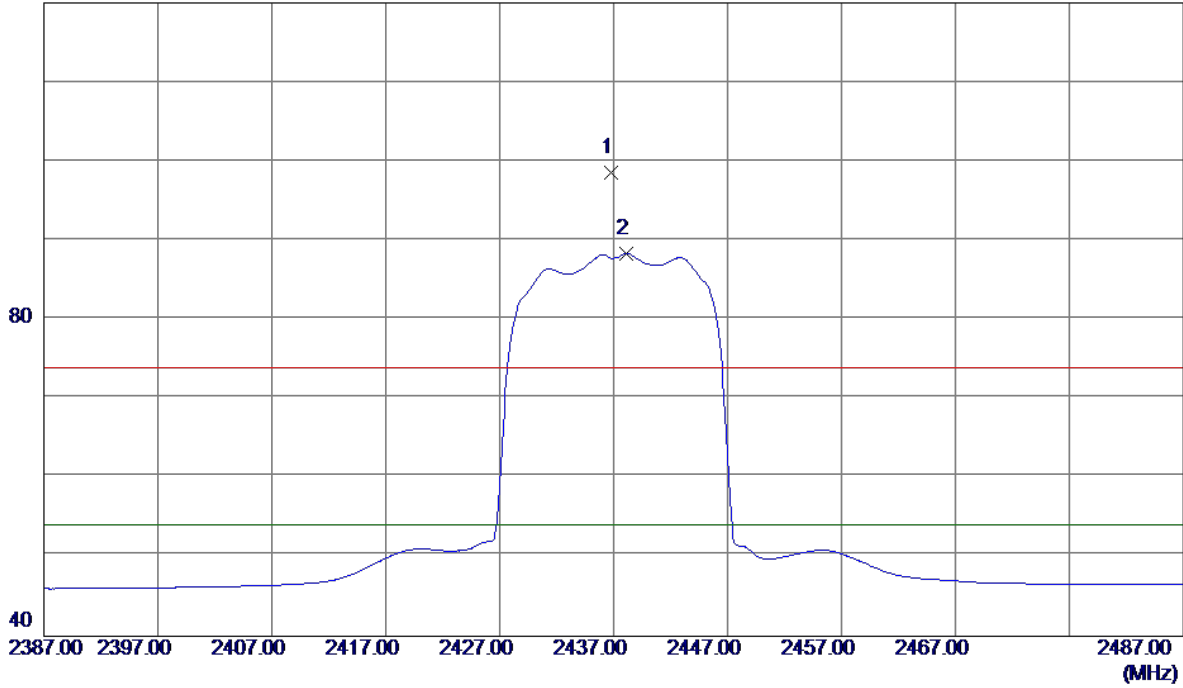

No.	Freq. MHz	Reading Level dBuV/m	Correct Factor dB	Measure ment dBuV/m	Limit dBuV/m	Margin dB	Detector	Comment
1	2436.8000	65.38	33.21	98.59	74.00	24.59	Peak	No Limit
2 *	2438.1000	55.14	33.21	88.35	54.00	34.35	AVG	No Limit

Orthogonal Axis :	X
Test Mode :	TX N-20M MODE 2437MHz

Vertical

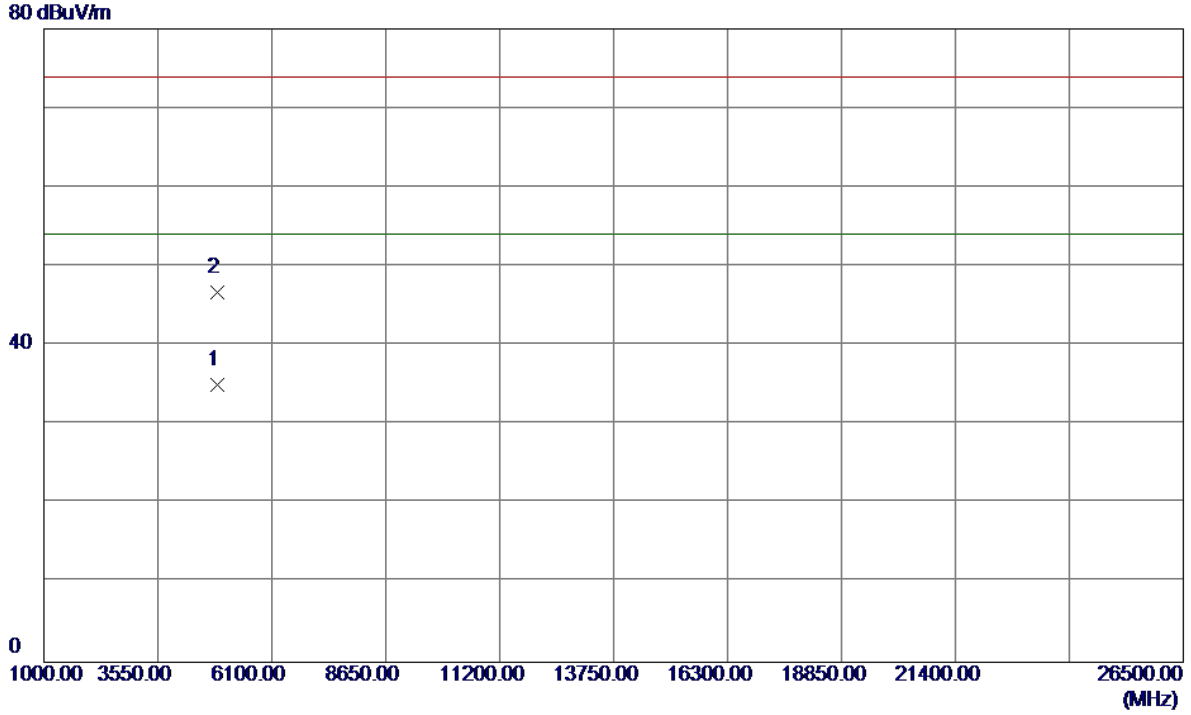

No.	Freq. MHz	Reading Level dBuV/m	Correct Factor dB	Measure ment dBuV/m	Limit dBuV/m	Margin dB	Detector	Comment
1 *	4873.9600	31.86	3.24	35.10	54.00	-18.90	AVG	
2	4874.9200	43.41	3.24	46.65	74.00	-27.35	Peak	

Orthogonal Axis :	X
Test Mode :	TX N-20M MODE 2437MHz

Horizontal

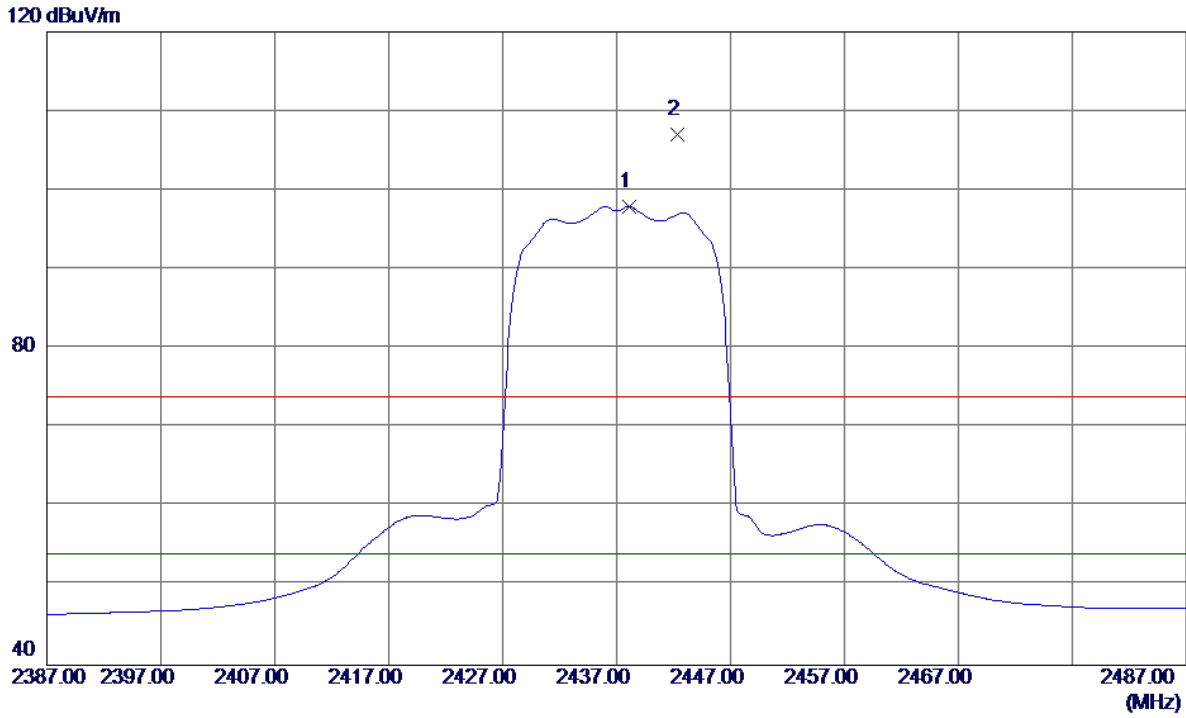

No.	Freq. MHz	Reading Level dBuV/m	Correct Factor dB	Measure ment dBuV/m	Limit dBuV/m	Margin dB	Detector	Comment
1 *	2438.1000	64.73	33.21	97.94	54.00	43.94	AVG	No Limit
2	2442.3000	73.74	33.23	106.97	74.00	32.97	Peak	No Limit

Orthogonal Axis :	X
Test Mode :	TX N-20M MODE 2437MHz

Horizontal

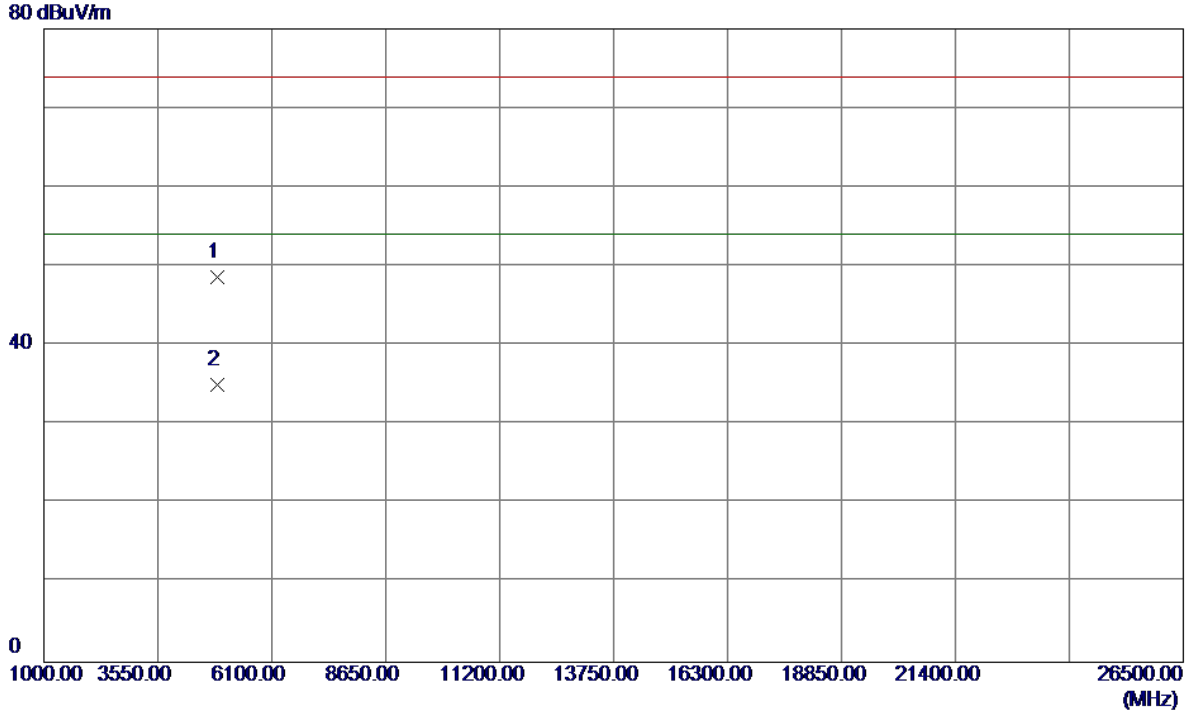

No.	Freq. MHz	Reading Level dBuV/m	Correct Factor dB	Measure ment dBuV/m	Limit dBuV/m	Margin dB	Detector	Comment
1	4870.3000	45.34	3.23	48.57	74.00	-25.43	Peak	
2 *	4874.0000	31.82	3.24	35.06	54.00	-18.94	AVG	

Orthogonal Axis :	X
Test Mode :	TX N-20M MODE 2462MHz

Vertical

120 dBuV/m

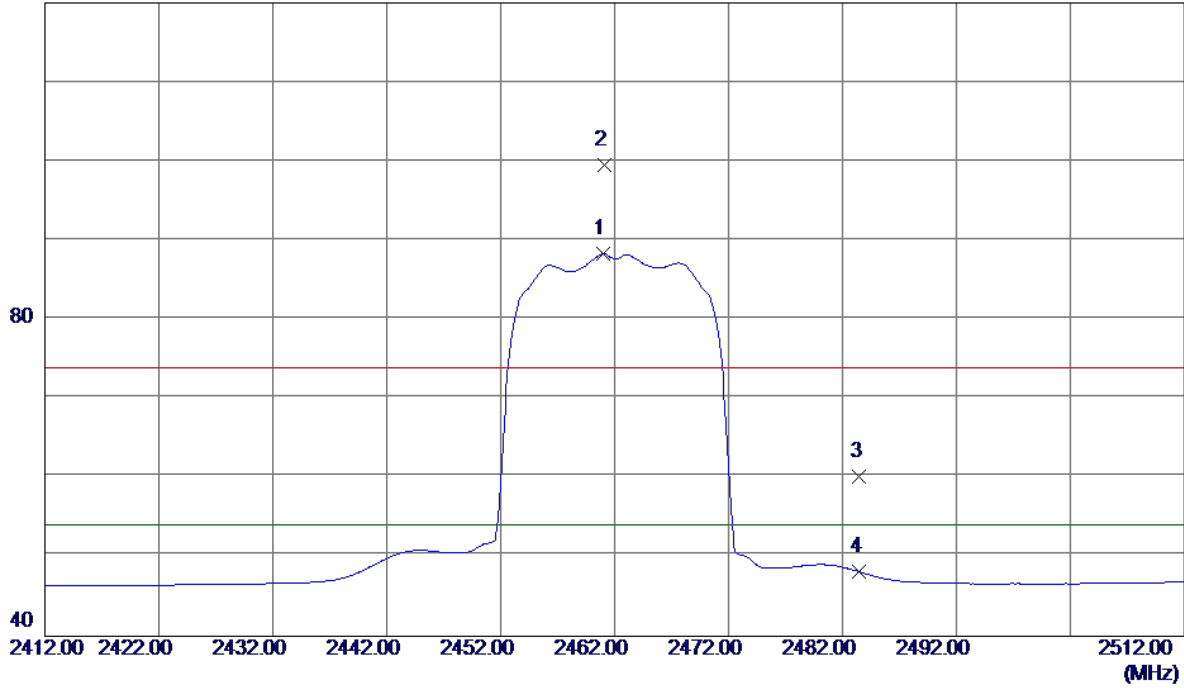

No.	Freq. MHz	Reading Level dBuV/m	Correct Factor dB	Measure ment dBuV/m	Limit dBuV/m	Margin dB	Detector	Comment
1 *	2461.0000	54.98	33.31	88.29	54.00	34.29	AVG	No Limit
2	2461.1000	66.18	33.31	99.49	74.00	25.49	Peak	No Limit
3	2483.5000	26.70	33.40	60.10	74.00	-13.90	Peak	
4	2483.5000	14.73	33.40	48.13	54.00	-5.87	AVG	

Orthogonal Axis :	X
Test Mode :	TX N-20M MODE 2462MHz

Vertical

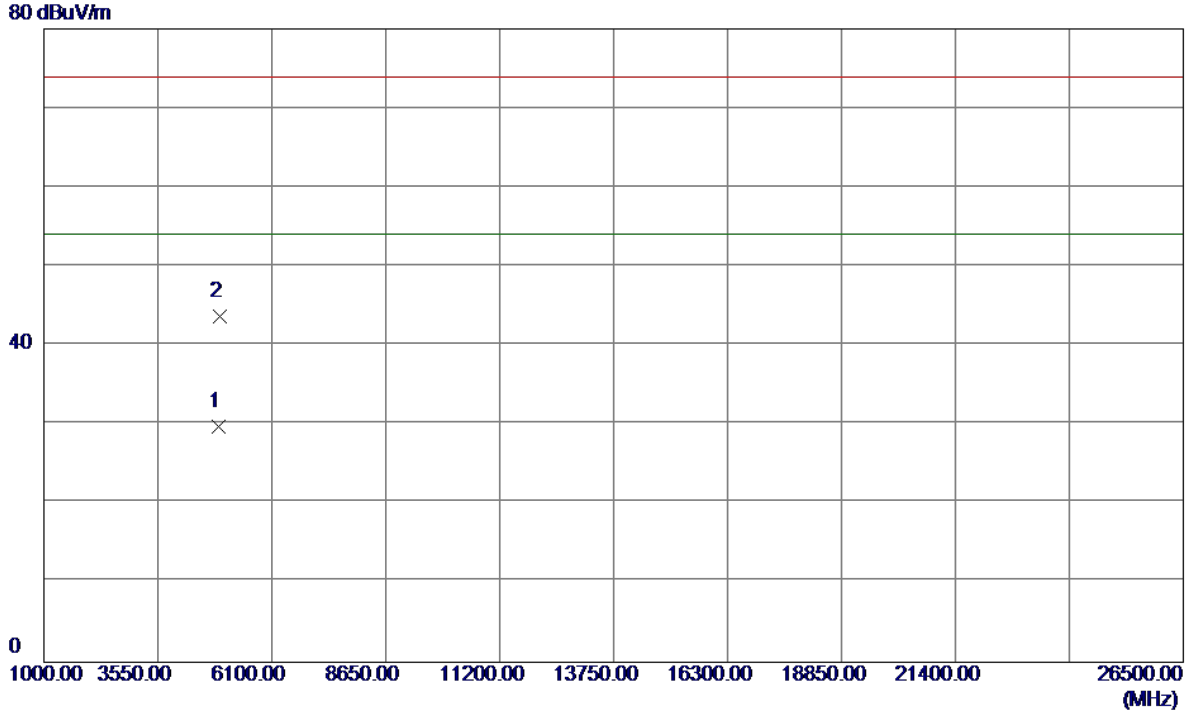

No.	Freq. MHz	Reading Level dBuV/m	Correct Factor dB	Measure ment dBuV/m	Limit dBuV/m	Margin dB	Detector	Comment
1 *	4923.9200	26.31	3.39	29.70	54.00	-24.30	AVG	
2	4931.9600	40.19	3.42	43.61	74.00	-30.39	Peak	

Orthogonal Axis :	X
Test Mode :	TX N-20M MODE 2462MHz

Horizontal

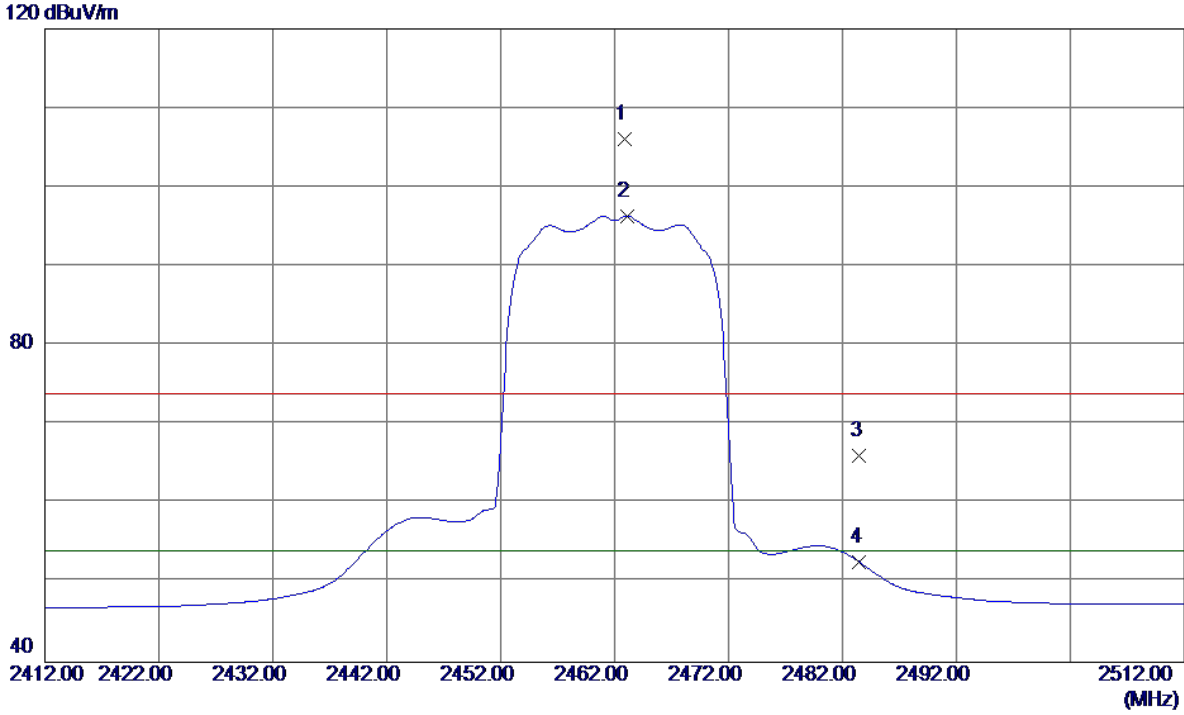

No.	Freq. MHz	Reading Level dBuV/m	Correct Factor dB	Measure ment dBuV/m	Limit dBuV/m	Margin dB	Detector	Comment
1	2462.9000	72.73	33.31	106.04	74.00	32.04	Peak	No Limit
2 *	2463.1000	63.07	33.32	96.39	54.00	42.39	AVG	No Limit
3	2483.5000	32.68	33.40	66.08	74.00	-7.92	Peak	
4	2483.5000	19.24	33.40	52.64	54.00	-1.36	AVG	

Orthogonal Axis :	X
Test Mode :	TX N-20M MODE 2462MHz

Horizontal

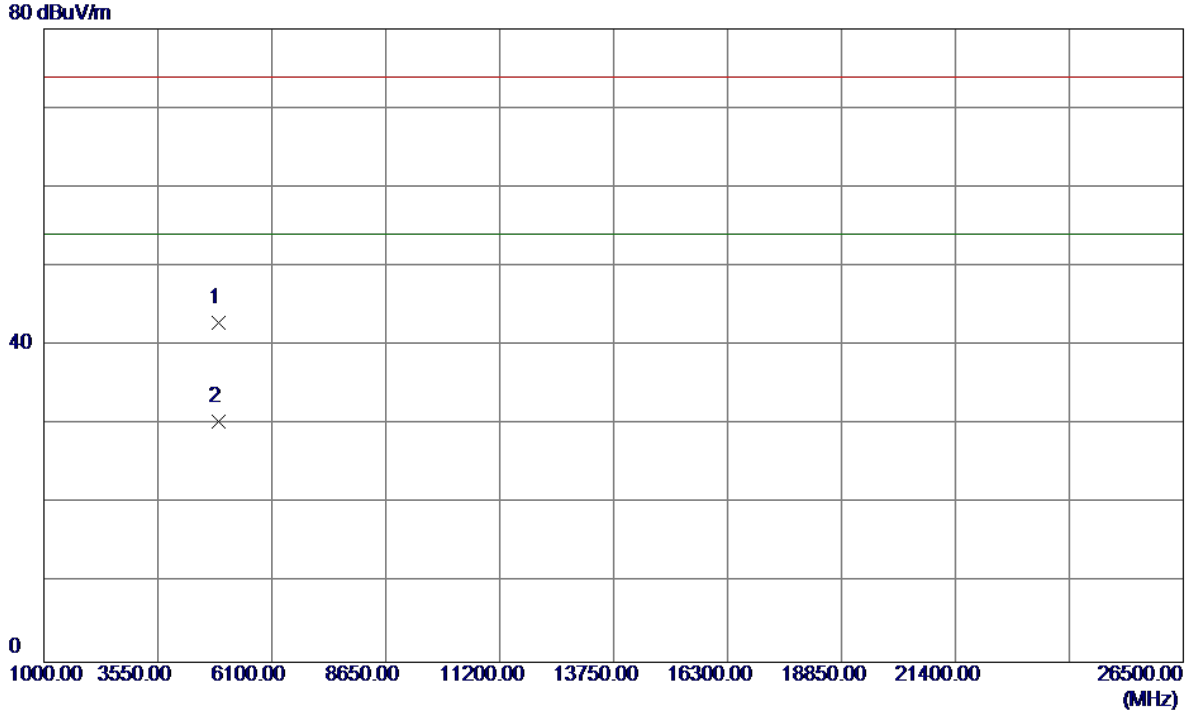

No.	Freq. MHz	Reading Level dBuV/m	Correct Factor dB	Measure ment dBuV/m	Limit dBuV/m	Margin dB	Detector	Comment
1	4922.8000	39.42	3.39	42.81	74.00	-31.19	Peak	
2 *	4923.9500	26.98	3.39	30.37	54.00	-23.63	AVG	

Orthogonal Axis :	X
Test Mode :	TX N-40M MODE 2422MHz

Vertical

120 dBuV/m

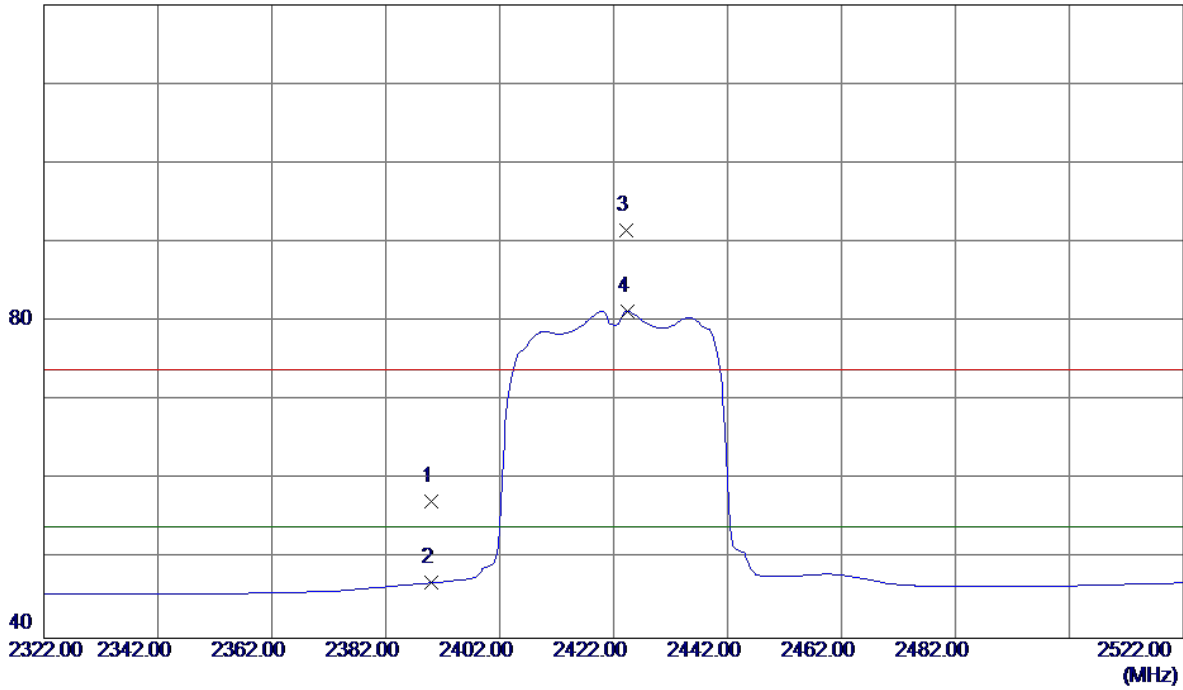

No.	Freq. MHz	Reading Level dBuV/m	Correct Factor dB	Measure ment dBuV/m	Limit dBuV/m	Margin dB	Detector	Comment
1	2390.0000	24.24	33.01	57.25	74.00	-16.75	Peak	
2	2390.0000	13.97	33.01	46.98	54.00	-7.02	AVG	
3	2424.2000	58.37	33.15	91.52	74.00	17.52	Peak	No Limit
4 *	2424.4000	48.17	33.15	81.32	54.00	27.32	AVG	No Limit

Orthogonal Axis :	X
Test Mode :	TX N-40M MODE 2422MHz

Vertical

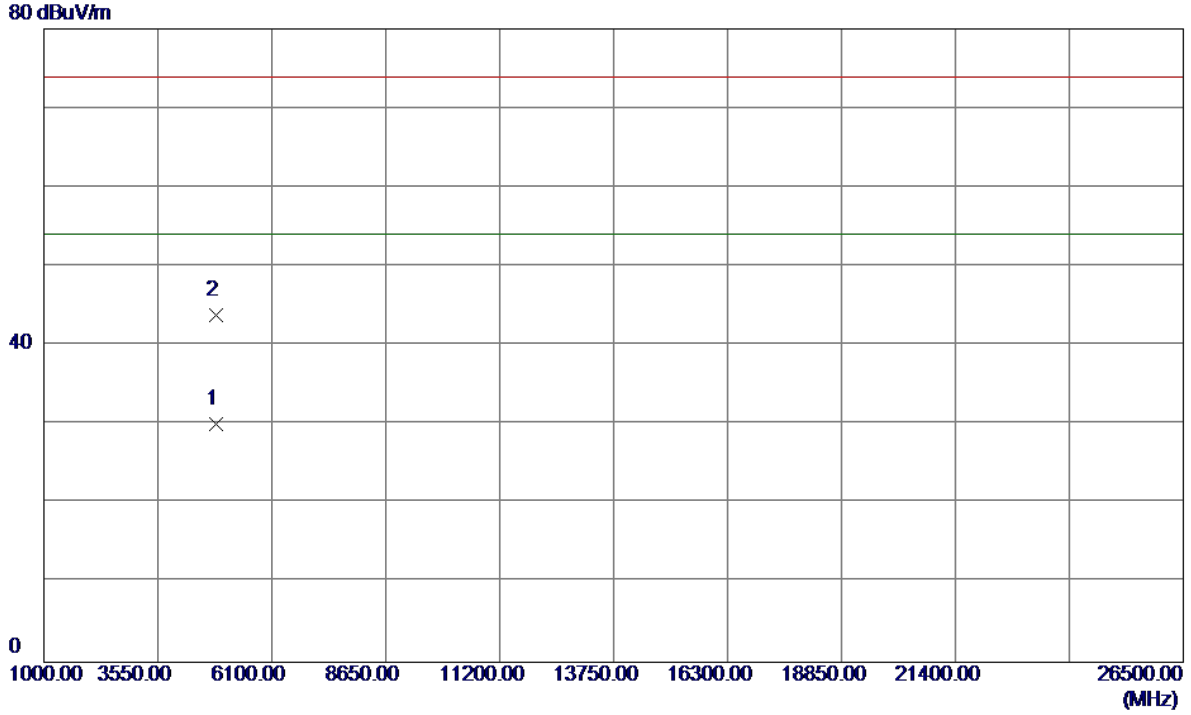

No.	Freq. MHz	Reading Level dBuV/m	Correct Factor dB	Measure ment dBuV/m	Limit dBuV/m	Margin dB	Detector	Comment
1 *	4844.0800	26.98	3.14	30.12	54.00	-23.88	AVG	
2	4845.6800	40.72	3.15	43.87	74.00	-30.13	Peak	

Orthogonal Axis :	X
Test Mode :	TX N-40M MODE 2422MHz

Horizontal

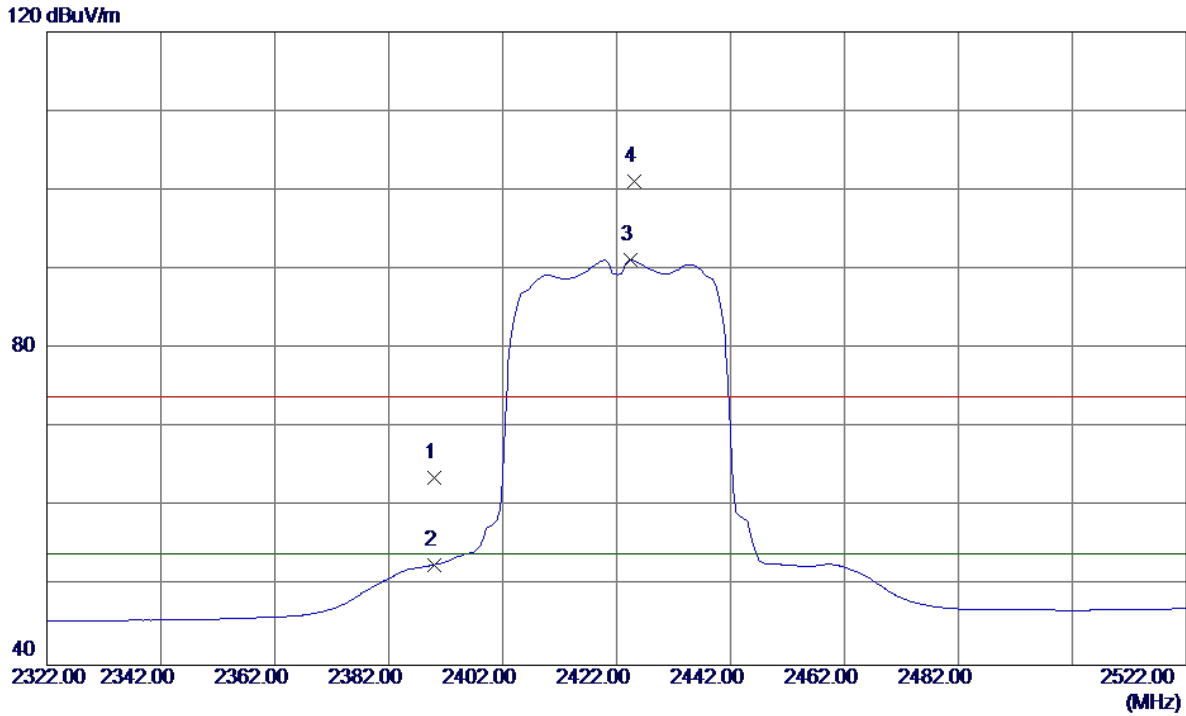

No.	Freq. MHz	Reading Level dBuV/m	Correct Factor dB	Measure ment dBuV/m	Limit dBuV/m	Margin dB	Detector	Comment
1	2390.0000	30.63	33.01	63.64	74.00	-10.36	Peak	
2	2390.0000	19.69	33.01	52.70	54.00	-1.30	AVG	
3 *	2424.4000	58.02	33.15	91.17	54.00	37.17	AVG	No Limit
4	2425.2000	67.98	33.16	101.14	74.00	27.14	Peak	No Limit

Orthogonal Axis :	X
Test Mode :	TX N-40M MODE 2422MHz

Horizontal



No.	Freq. MHz	Reading Level dBuV/m	Correct Factor dB	Measure ment dBuV/m	Limit dBuV/m	Margin dB	Detector	Comment
1	4844.1600	35.90	3.14	39.04	74.00	-34.96	Peak	
2 *	4844.1600	26.92	3.14	30.06	54.00	-23.94	AVG	

Orthogonal Axis :	X
Test Mode :	TX N-40M MODE 2437MHz

Vertical

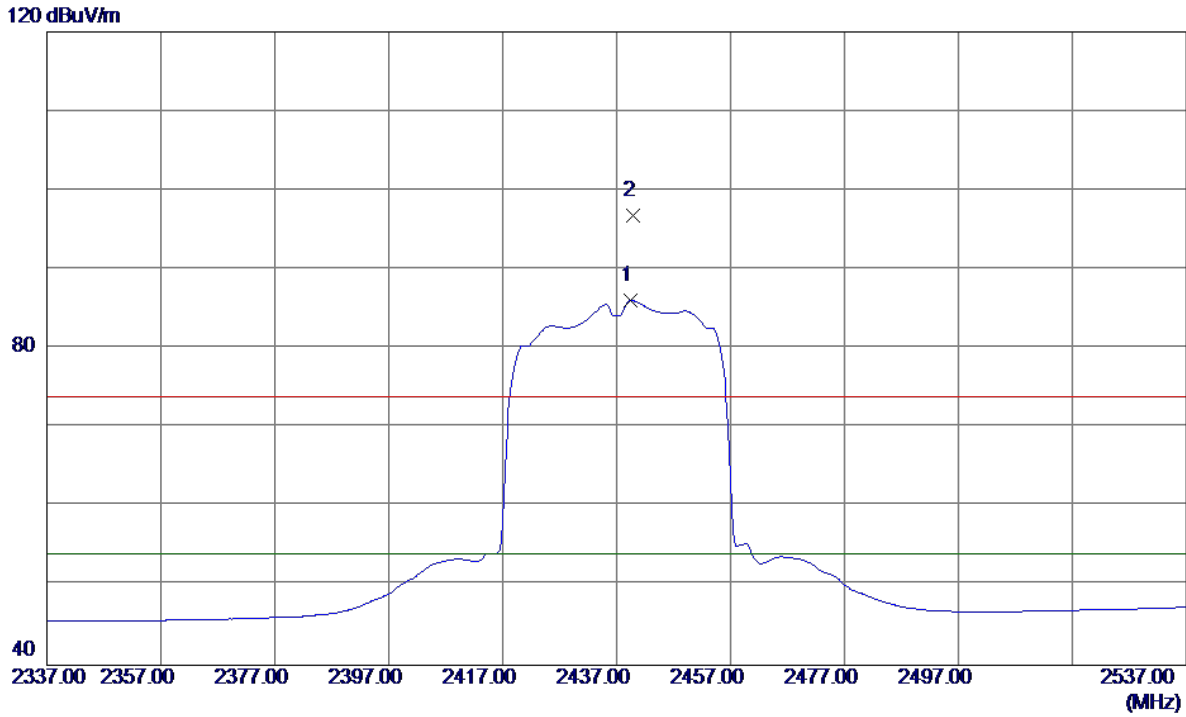

No.	Freq. MHz	Reading Level dBuV/m	Correct Factor dB	Measure ment dBuV/m	Limit dBuV/m	Margin dB	Detector	Comment
1 *	2439.4000	52.86	33.22	86.08	54.00	32.08	AVG	No Limit
2	2439.8000	63.55	33.22	96.77	74.00	22.77	Peak	No Limit

Orthogonal Axis :	X
Test Mode :	TX N-40M MODE 2437MHz

Vertical

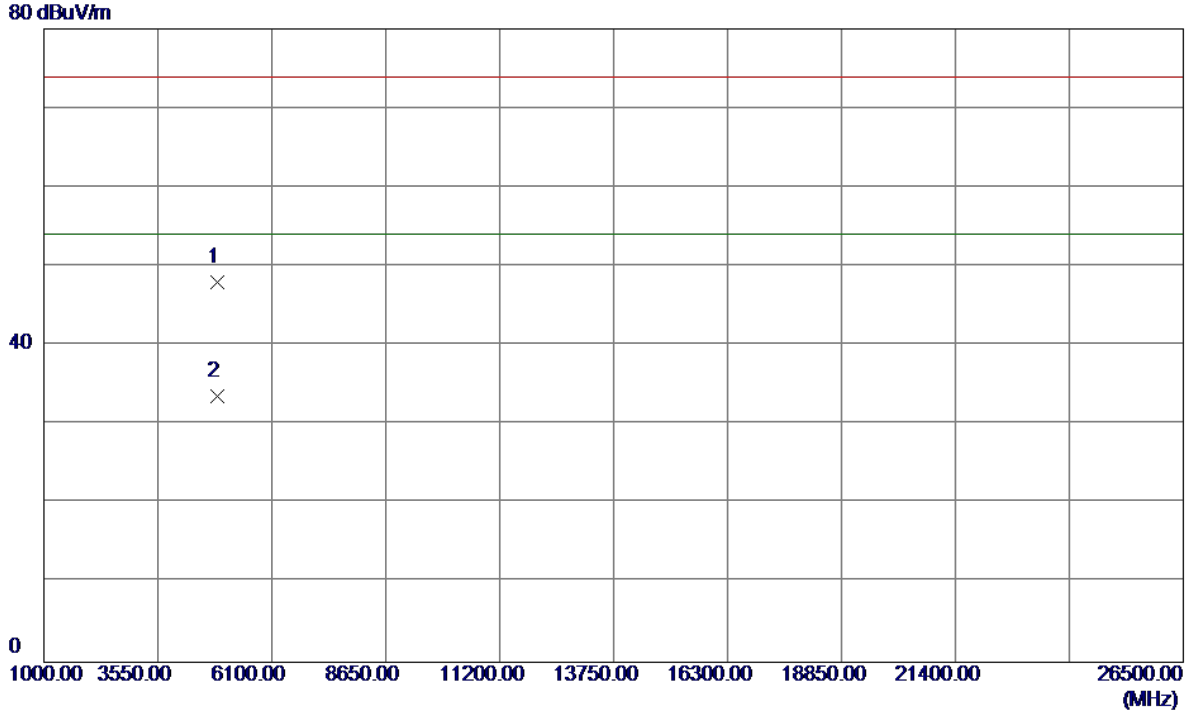

No.	Freq. MHz	Reading Level dBuV/m	Correct Factor dB	Measure ment dBuV/m	Limit dBuV/m	Margin dB	Detector	Comment
1	4870.4000	44.80	3.23	48.03	74.00	-25.97	Peak	
2 *	4872.6400	30.40	3.23	33.63	54.00	-20.37	AVG	

Orthogonal Axis :	X
Test Mode :	TX N-40M MODE 2437MHz

Horizontal

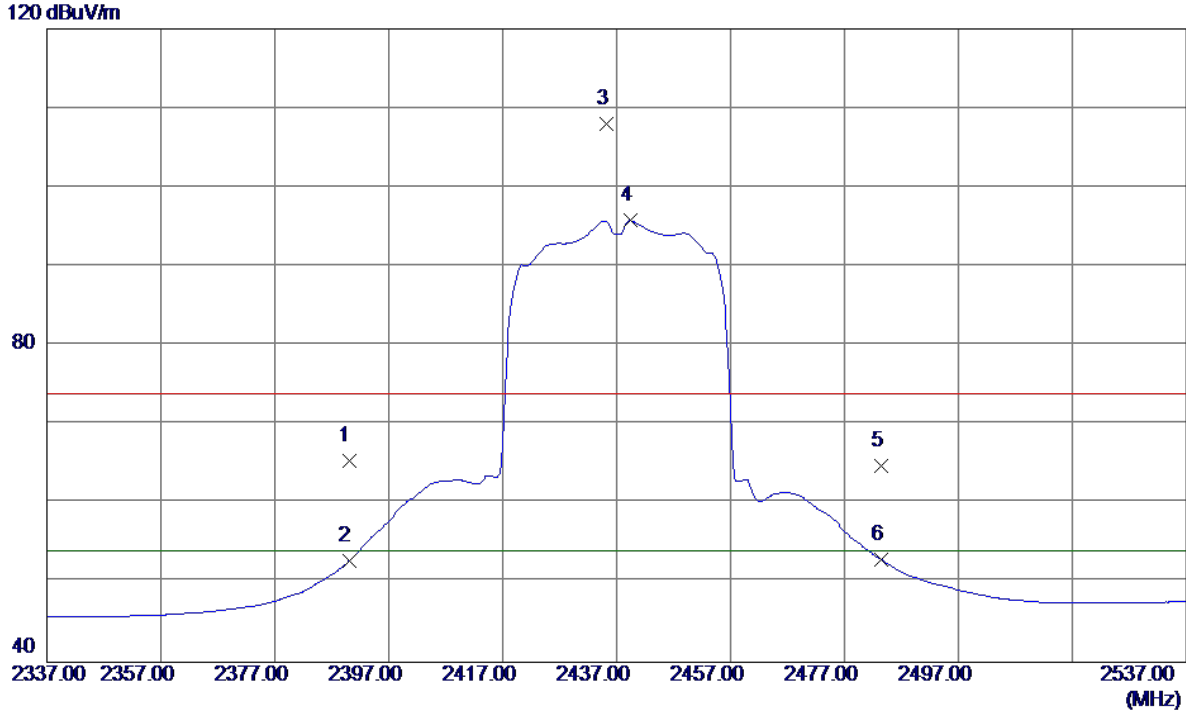

No.	Freq. MHz	Reading Level dBuV/m	Correct Factor dB	Measure ment dBuV/m	Limit dBuV/m	Margin dB	Detector	Comment
1	2390.0000	32.43	33.01	65.44	74.00	-8.56	Peak	
2	2390.0000	19.74	33.01	52.75	54.00	-1.25	AVG	
3	2435.2000	74.88	33.20	108.08	74.00	34.08	Peak	No Limit
4 *	2439.4000	62.56	33.22	95.78	54.00	41.78	AVG	No Limit
5	2483.5000	31.42	33.40	64.82	74.00	-9.18	Peak	
6	2483.5000	19.49	33.40	52.89	54.00	-1.11	AVG	

Orthogonal Axis :	X
Test Mode :	TX N-40M MODE 2437MHz

Horizontal

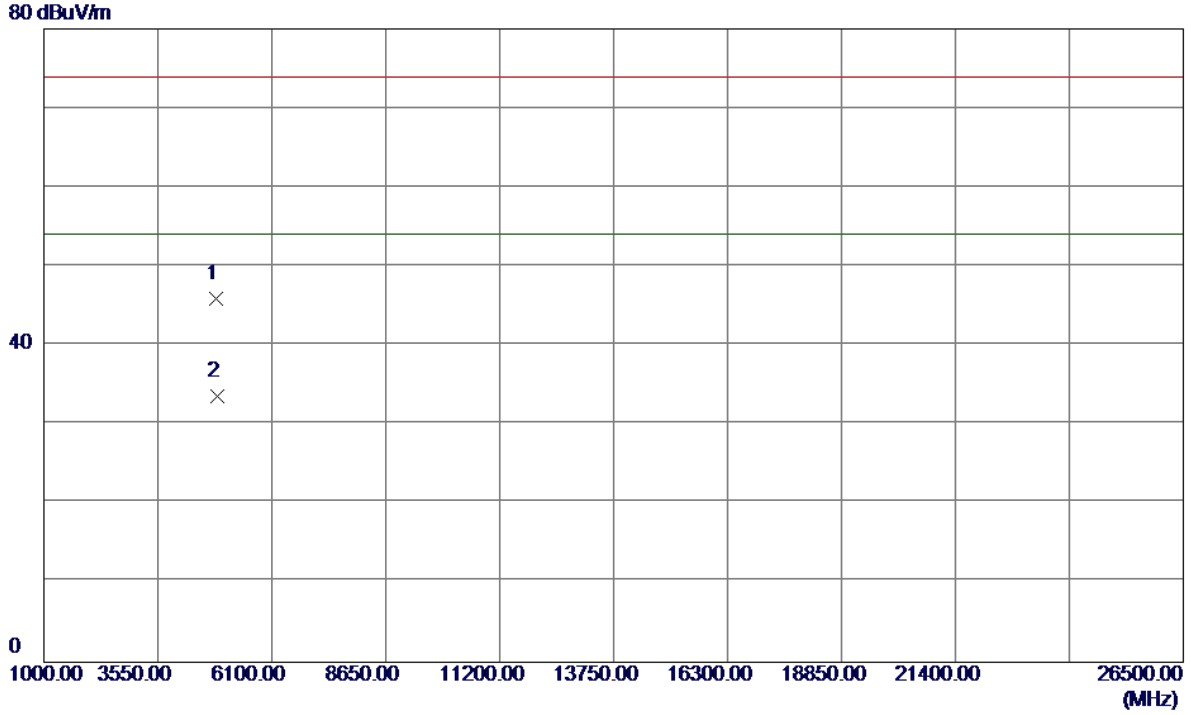

No.	Freq. MHz	Reading Level dBuV/m	Correct Factor dB	Measure ment dBuV/m	Limit dBuV/m	Margin dB	Detector	Comment
1	4857.8400	42.66	3.19	45.85	74.00	-28.15	Peak	
2 *	4874.3200	30.30	3.24	33.54	54.00	-20.46	AVG	

Orthogonal Axis :	X
Test Mode :	TX N-40M MODE 2452MHz

Vertical

120 dBuV/m

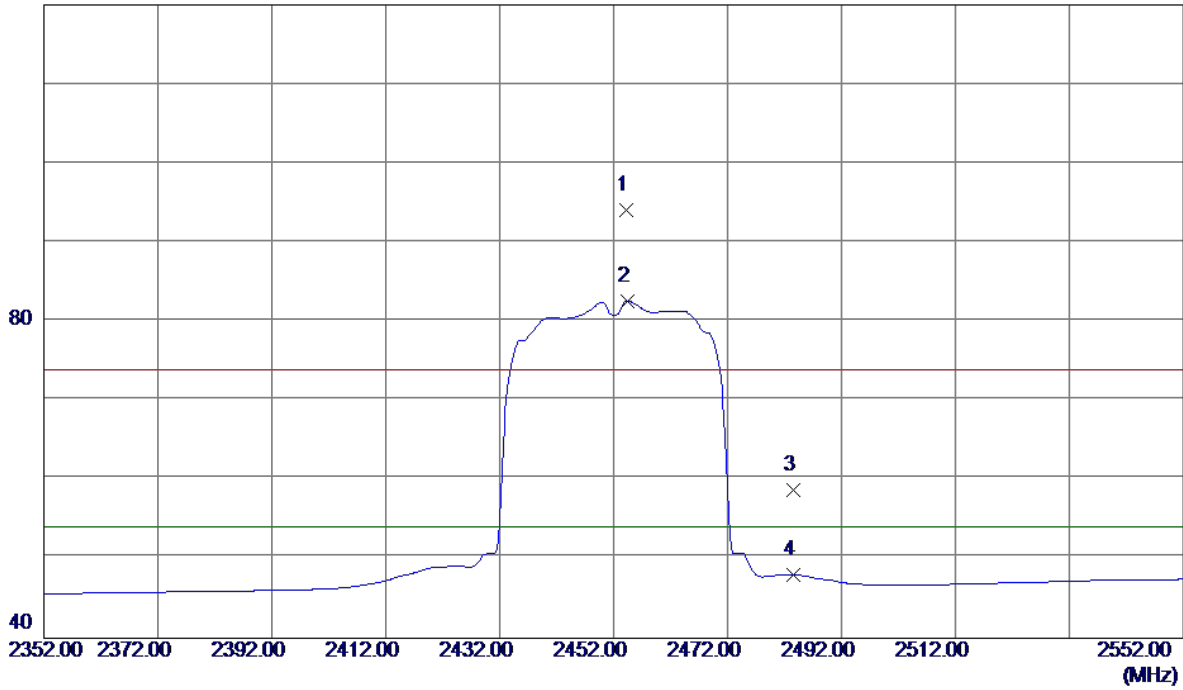

No.	Freq. MHz	Reading Level dBuV/m	Correct Factor dB	Measure ment dBuV/m	Limit dBuV/m	Margin dB	Detector	Comment
1	2454.2000	60.77	33.28	94.05	74.00	20.05	Peak	No Limit
2 *	2454.4000	49.34	33.28	82.62	54.00	28.62	AVG	No Limit
3	2483.5000	25.27	33.40	58.67	74.00	-15.33	Peak	
4	2483.5000	14.59	33.40	47.99	54.00	-6.01	AVG	

Orthogonal Axis :	X
Test Mode :	TX N-40M MODE 2452MHz

Vertical

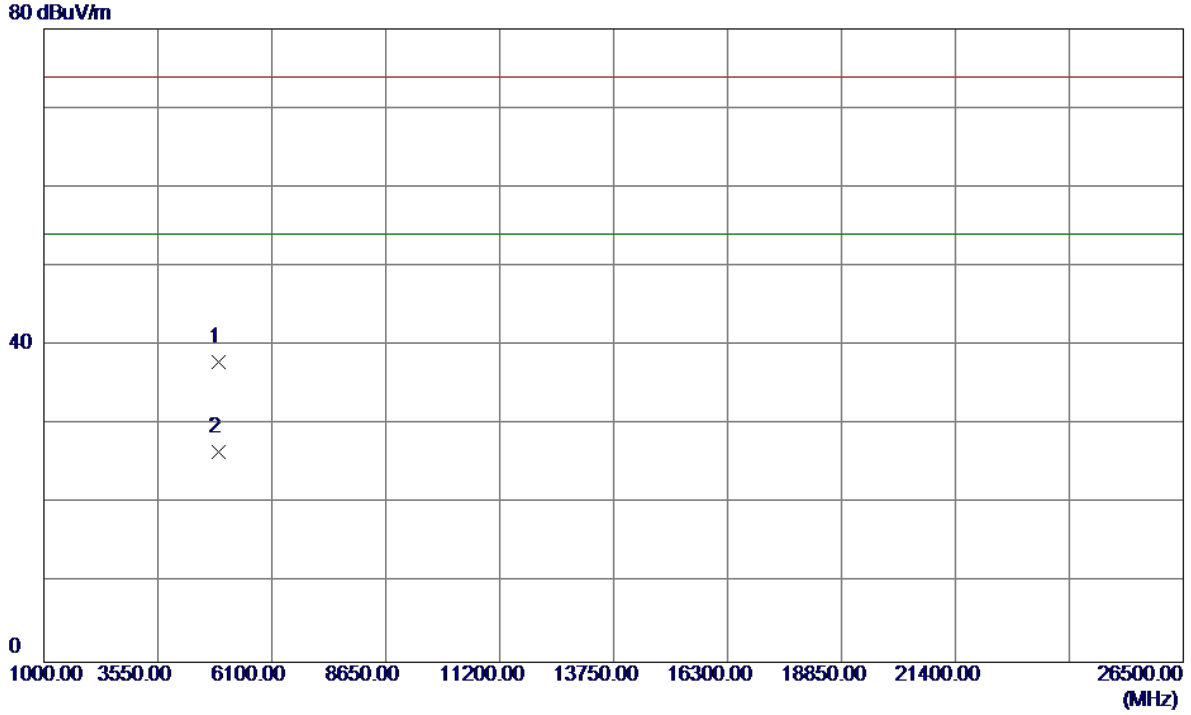

No.	Freq. MHz	Reading Level dBuV/m	Correct Factor dB	Measure ment dBuV/m	Limit dBuV/m	Margin dB	Detector	Comment
1	4899.2799	34.66	3.32	37.98	74.00	-36.02	Peak	
2 *	4902.7200	23.30	3.33	26.63	54.00	-27.37	AVG	

Orthogonal Axis :	X
Test Mode :	TX N-40M MODE 2452MHz

Horizontal

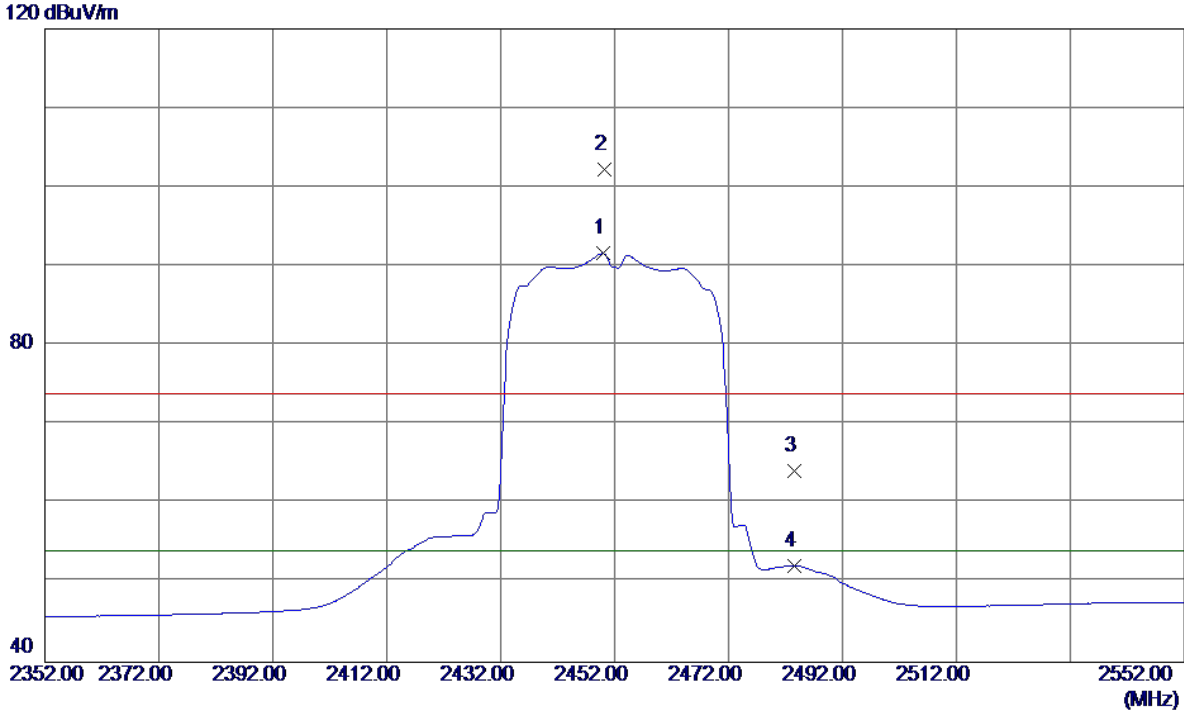

No.	Freq. MHz	Reading Level dBuV/m	Correct Factor dB	Measure ment dBuV/m	Limit dBuV/m	Margin dB	Detector	Comment
1 *	2450.0000	58.37	33.26	91.63	54.00	37.63	AVG	No Limit
2	2450.2000	68.98	33.26	102.24	74.00	28.24	Peak	No Limit
3	2483.5000	30.69	33.40	64.09	74.00	-9.91	Peak	
4	2483.5000	18.80	33.40	52.20	54.00	-1.80	AVG	

Orthogonal Axis :	X
Test Mode :	TX N-40M MODE 2452MHz

Horizontal

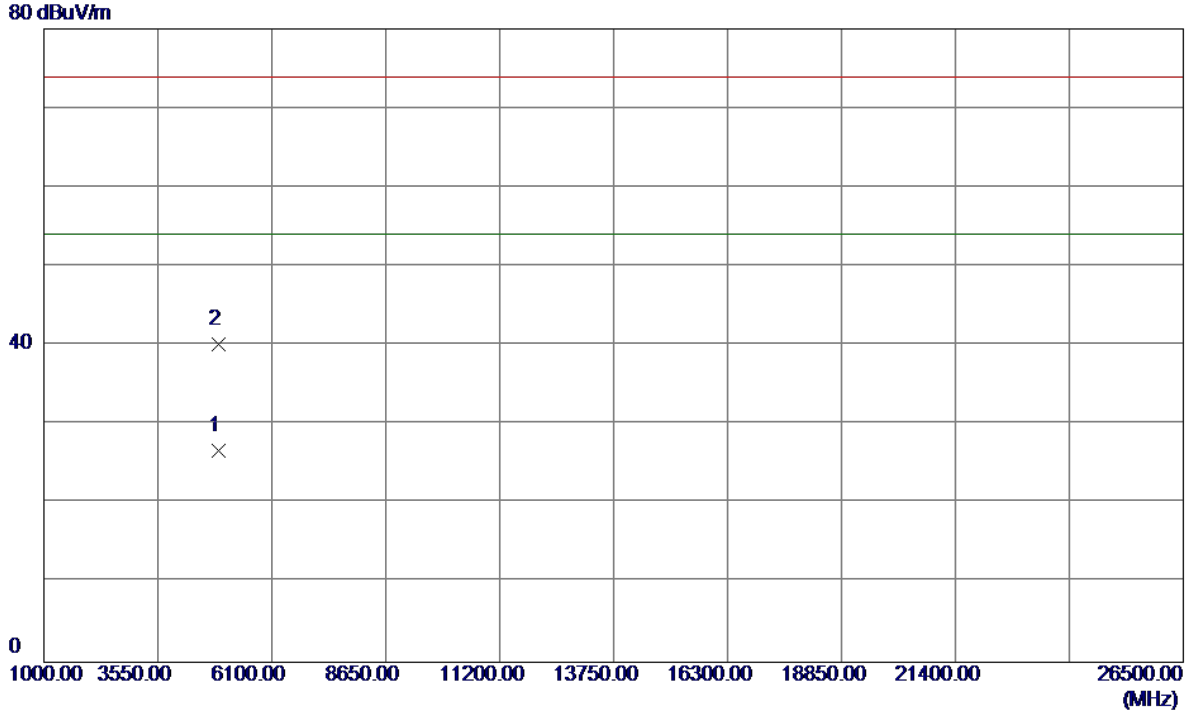

No.	Freq. MHz	Reading Level dBuV/m	Correct Factor dB	Measure ment dBuV/m	Limit dBuV/m	Margin dB	Detector	Comment
1 *	4904.0800	23.43	3.33	26.76	54.00	-27.24	AVG	
2	4904.8000	36.84	3.33	40.17	74.00	-33.83	Peak	

ATTACHMENT E - BANDWIDTH

Test Mode : TX B Mode_CH01/06/11

Frequency (MHz)	6dB Bandwidth (MHz)	99% Occupied BW (MHz)	Min. Limit (kHz)	Test Result
2412	8.12	10.12	500	Complies
2437	8.09	10.12	500	Complies
2462	8.13	10.12	500	Complies

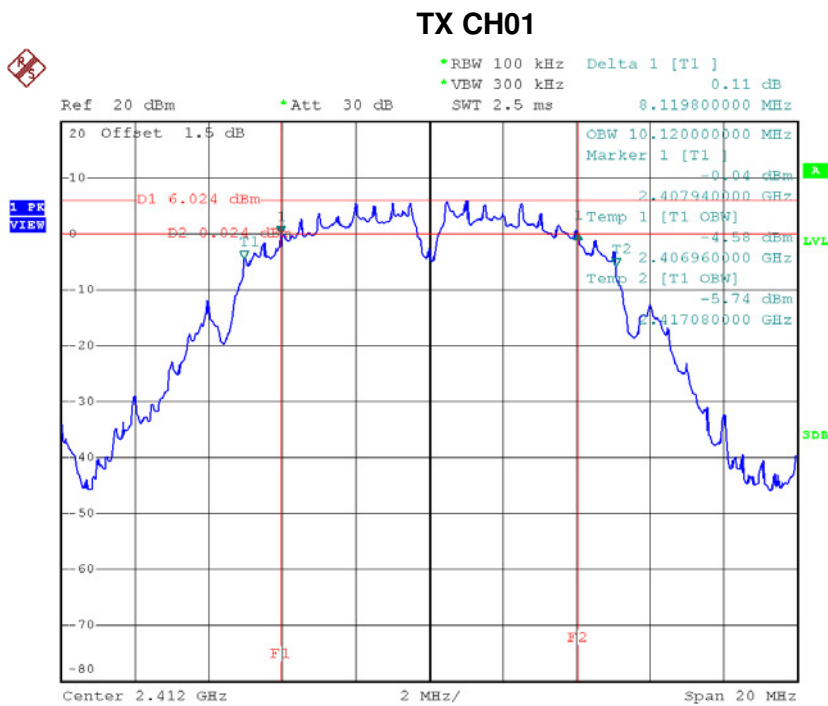

Date: 28.FEB.2017 10:14:44

TX CH06

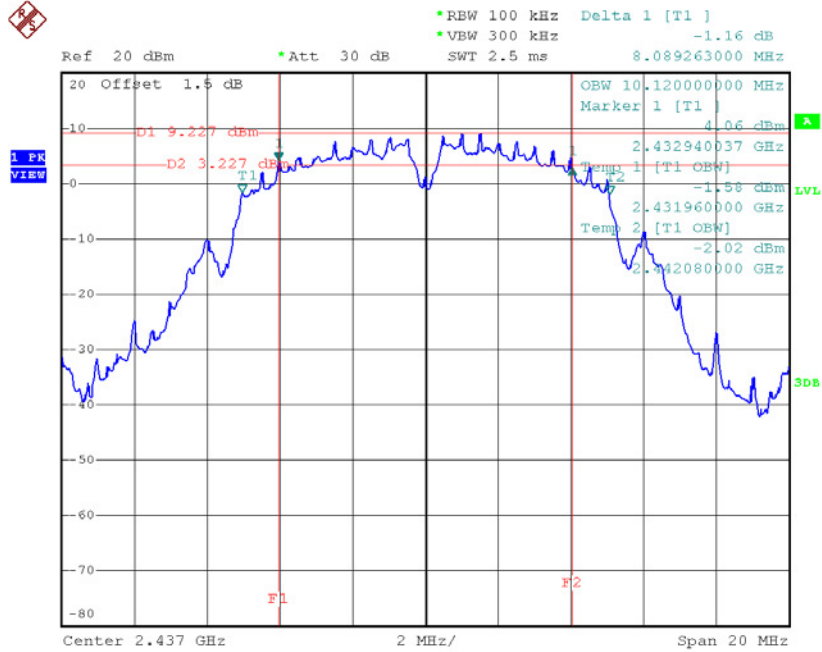

Date: 28.FEB.2017 10:15:55

TX CH11

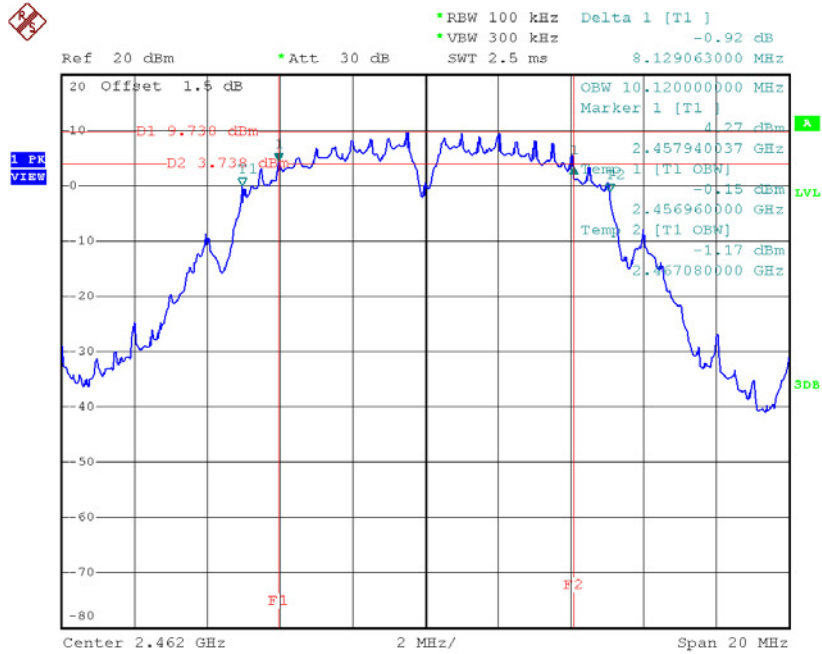

Date: 28.FEB.2017 10:27:39

Test Mode: TX G Mode_CH01/06/11

Frequency (MHz)	6dB Bandwidth (MHz)	99% Occupied BW (MHz)	Min. Limit (kHz)	Test Result
2412	14.72	16.28	500	Complies
2437	14.64	16.36	500	Complies
2462	15.43	16.36	500	Complies

TX CH01

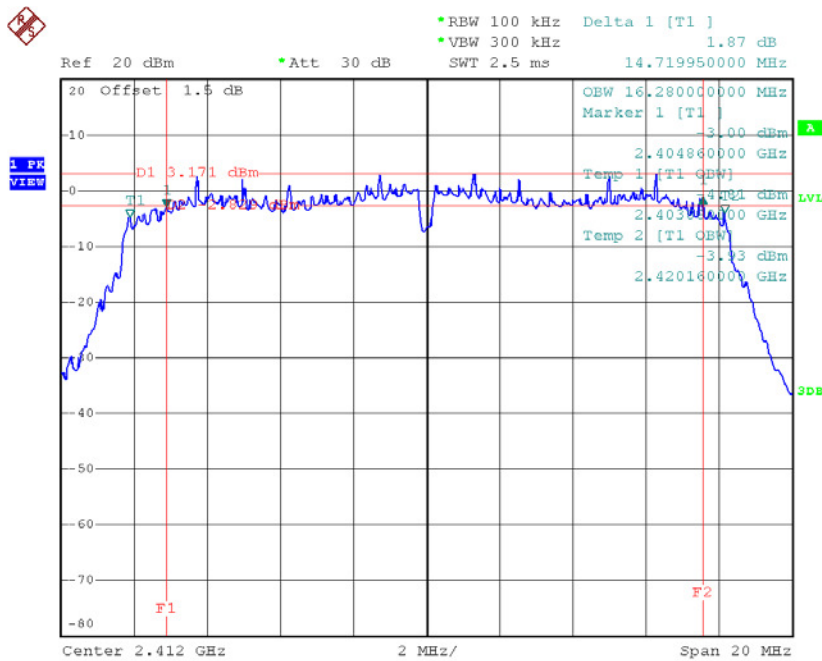

Date: 28.FEB.2017 10:30:55

TX CH06

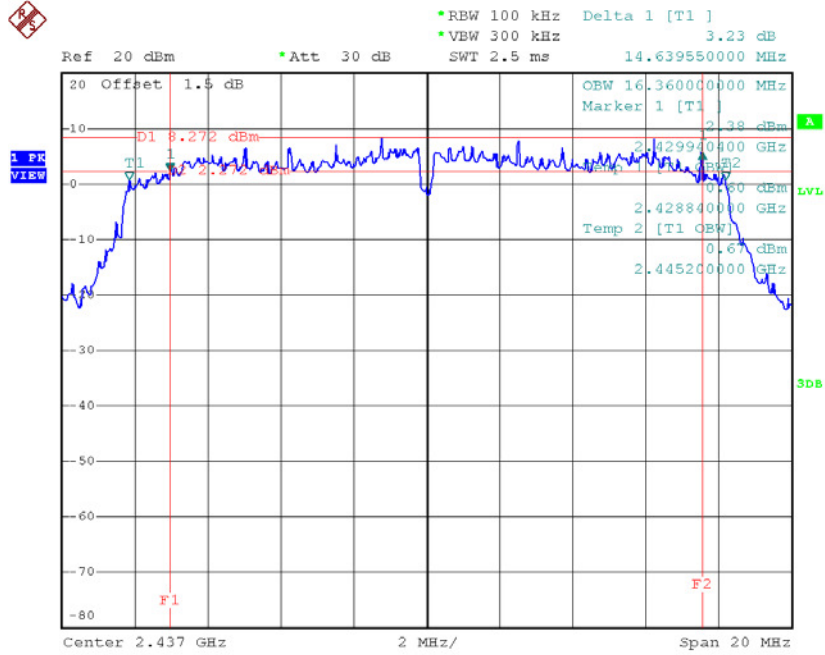

Date: 28.FEB.2017 10:33:32

TX CH11

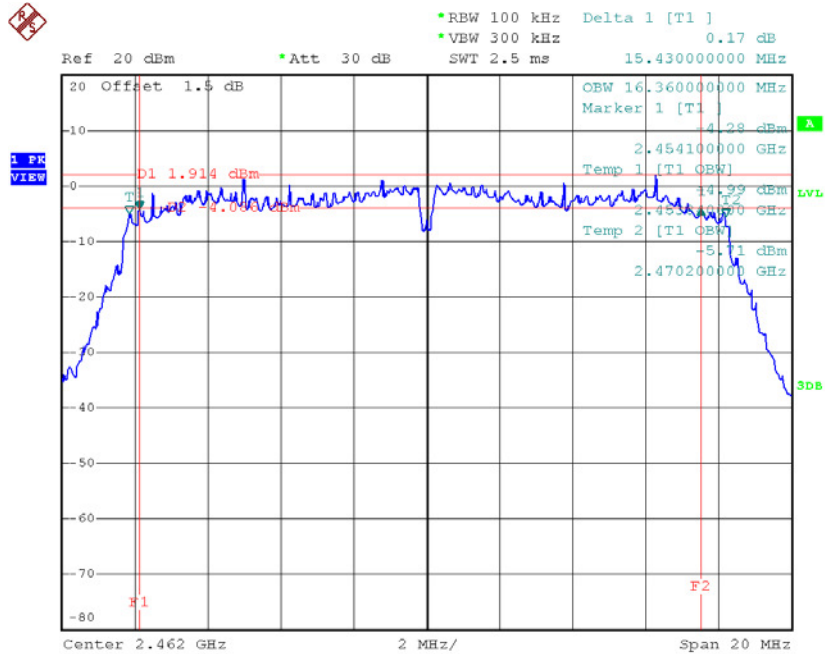

Date: 28.FEB.2017 10:34:56

Test Mode : TX N-20MHz Mode_CH01/06/11

Frequency (MHz)	6dB Bandwidth (MHz)	99% Occupied BW (MHz)	Min. Limit (kHz)	Test Result
2412	15.15	17.44	500	Complies
2437	15.16	17.44	500	Complies
2462	15.11	17.48	500	Complies

TX CH01

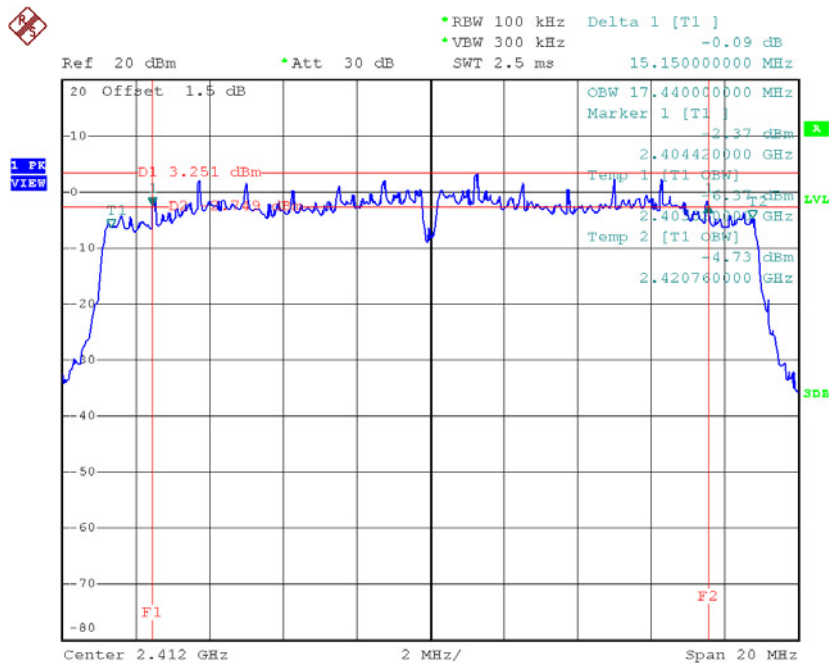

Date: 28.FEB.2017 10:39:23

TX CH06

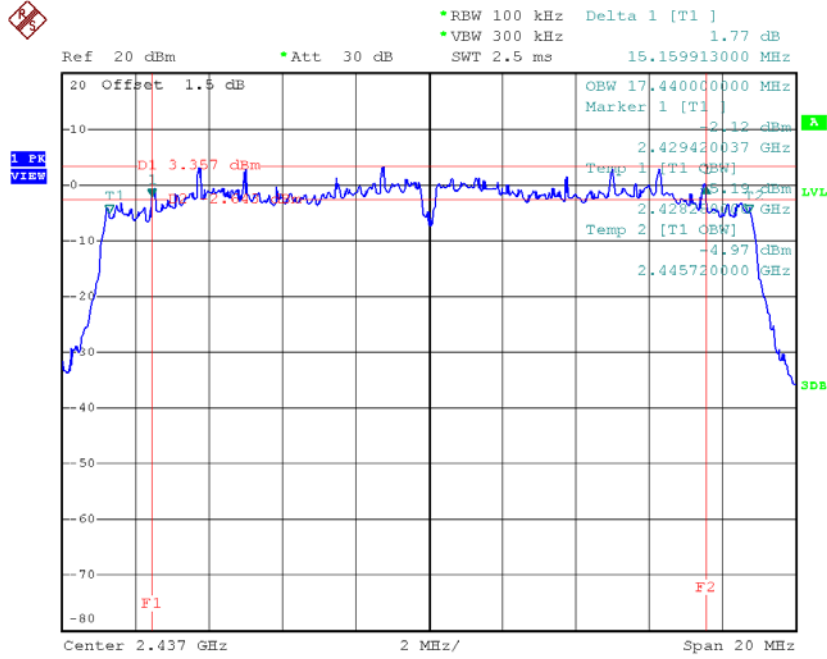

Date: 28.FEB.2017 10:41:07

TX CH11

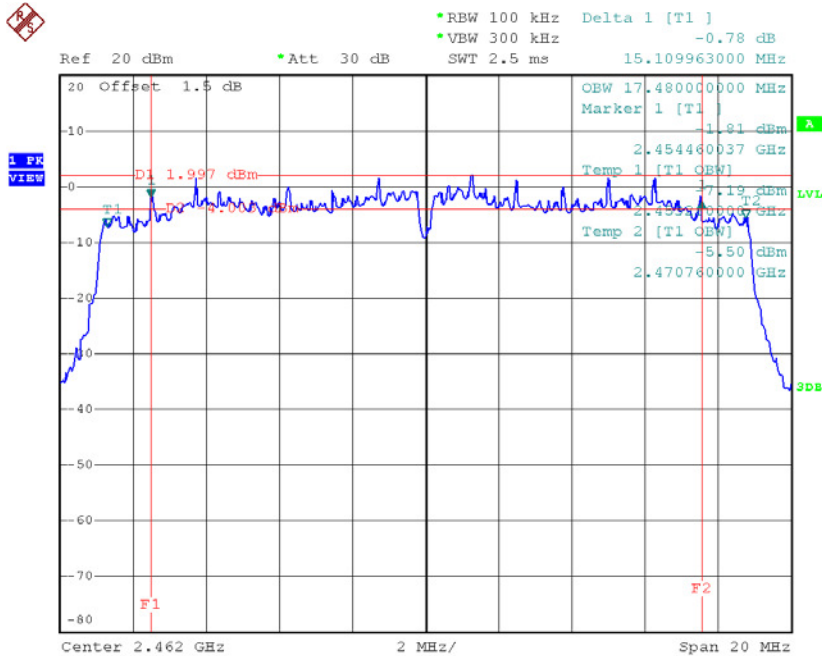

Date: 28.FEB.2017 10:42:24

Test Mode : TX N-40MHz Mode_CH03/06/09

Frequency (MHz)	6dB Bandwidth (MHz)	99% Occupied BW (MHz)	Min. Limit (kHz)	Test Result
2422	35.8	36.16	500	Complies
2437	35.72	36.08	500	Complies
2452	35.48	36.08	500	Complies

TX CH03

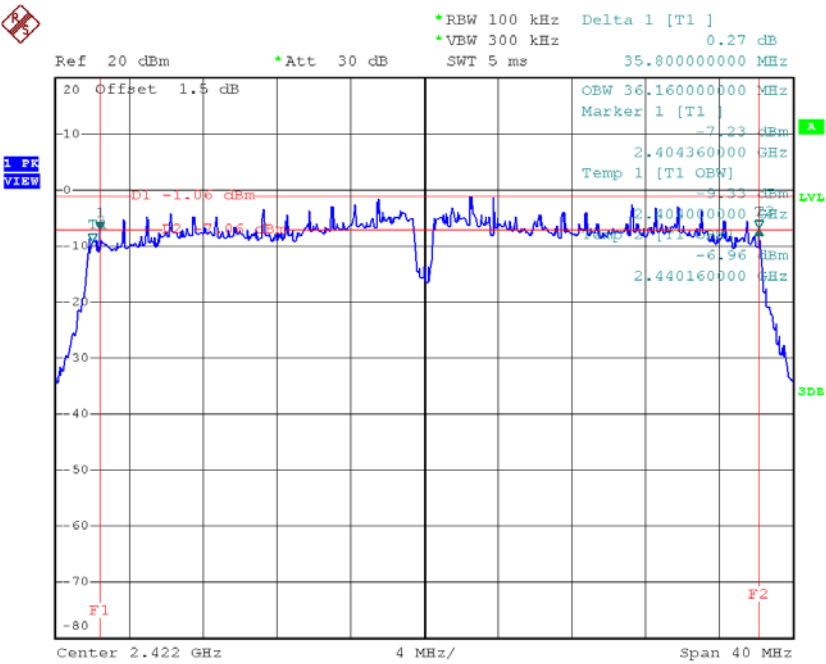

Date: 28.FEB.2017 10:59:10

TX CH06

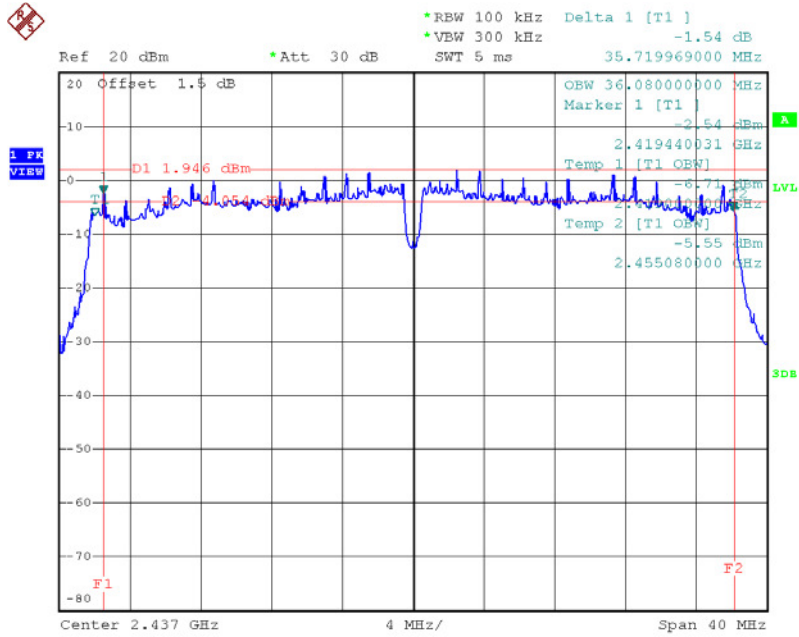

Date: 28.FEB.2017 11:00:44

TX CH09

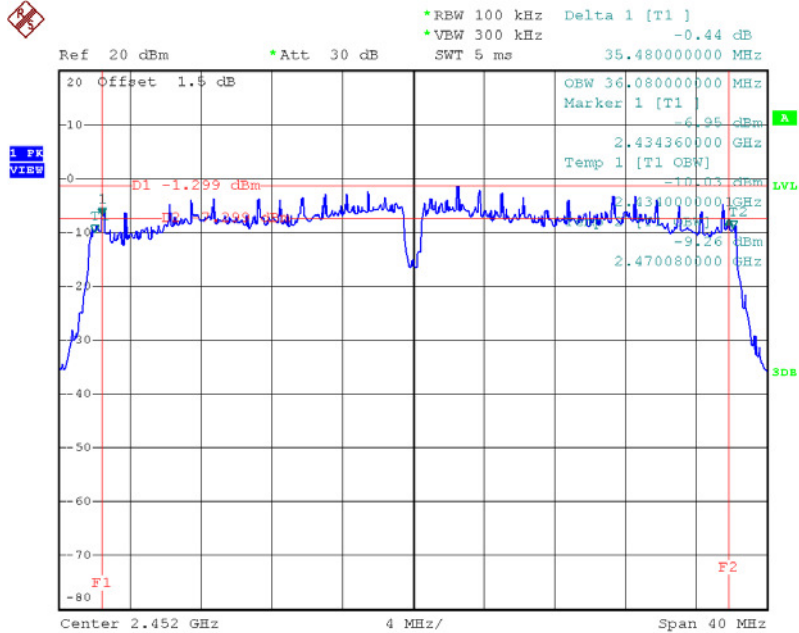

Date: 28.FEB.2017 11:02:10

ATTACHMENT F – MAXIMUM PEAK CONDUCTED OUTPUT POWER

Test Mode :TX B Mode_CH01/06/11					
Frequency (MHz)	Conducted Power (dBm)	Conducted Power (W)	Max. Limit (dBm)	Max. Limit (W)	Result
2412	20.08	0.10	29.99	0.998	Complies
2437	22.59	0.18	29.99	0.998	Complies
2462	23.32	0.21	29.99	0.998	Complies

Test Mode :TX G Mode_CH01/06/11					
Frequency (MHz)	Conducted Power (dBm)	Conducted Power (W)	Max. Limit (dBm)	Max. Limit (W)	Result
2412	26.53	0.45	29.99	0.998	Complies
2437	27.69	0.59	29.99	0.998	Complies
2462	26.55	0.45	29.99	0.998	Complies

Test Mode :TX N20 Mode_CH01/06/11_ANT 1					
Frequency (MHz)	Conducted Power (dBm)	Conducted Power (W)	Max. Limit (dBm)	Max. Limit (W)	Result
2412	25.91	0.39	29.99	0.998	Complies
2437	25.81	0.38	29.99	0.998	Complies
2462	25.18	0.33	29.99	0.998	Complies

Test Mode :TX N20 Mode_CH01/06/11_ANT 2					
Frequency (MHz)	Conducted Power (dBm)	Conducted Power (W)	Max. Limit (dBm)	Max. Limit (W)	Result
2412	25.38	0.35	29.99	0.998	Complies
2437	26.02	0.40	29.99	0.998	Complies
2462	24.87	0.31	29.99	0.998	Complies

Test Mode :TX N20 Mode_CH01/06/11_Total					
Frequency (MHz)	Conducted Power (dBm)	Conducted Power (W)	Max. Limit (dBm)	Max. Limit (W)	Result
2412	28.66	0.74	29.99	0.998	Complies
2437	28.93	0.78	29.99	0.998	Complies
2462	28.04	0.64	29.99	0.998	Complies

Test Mode :TX N40 Mode_CH03/06/09_ANT 1					
Frequency (MHz)	Conducted Power (dBm)	Conducted Power (W)	Max. Limit (dBm)	Max. Limit (W)	Result
2422	22.79	0.19	29.99	0.998	Complies
2437	25.84	0.38	29.99	0.998	Complies
2452	22.15	0.16	29.99	0.998	Complies

Test Mode :TX N40 Mode_CH03/06/09_ANT 2					
Frequency (MHz)	Conducted Power (dBm)	Conducted Power (W)	Max. Limit (dBm)	Max. Limit (W)	Result
2422	22.59	0.18	29.99	0.998	Complies
2437	25.03	0.32	29.99	0.998	Complies
2452	22.19	0.17	29.99	0.998	Complies

Test Mode :TX N40 Mode_CH03/06/09_Total					
Frequency (MHz)	Conducted Power (dBm)	Conducted Power (W)	Max. Limit (dBm)	Max. Limit (W)	Result
2422	25.70	0.37	29.99	0.998	Complies
2437	28.46	0.70	29.99	0.998	Complies
2452	25.18	0.33	29.99	0.998	Complies

ATTACHMENT G - ANTENNA CONDUCTED SPURIOUS EMISSION

Test Mode : TX B Mode

TX B mode CH01

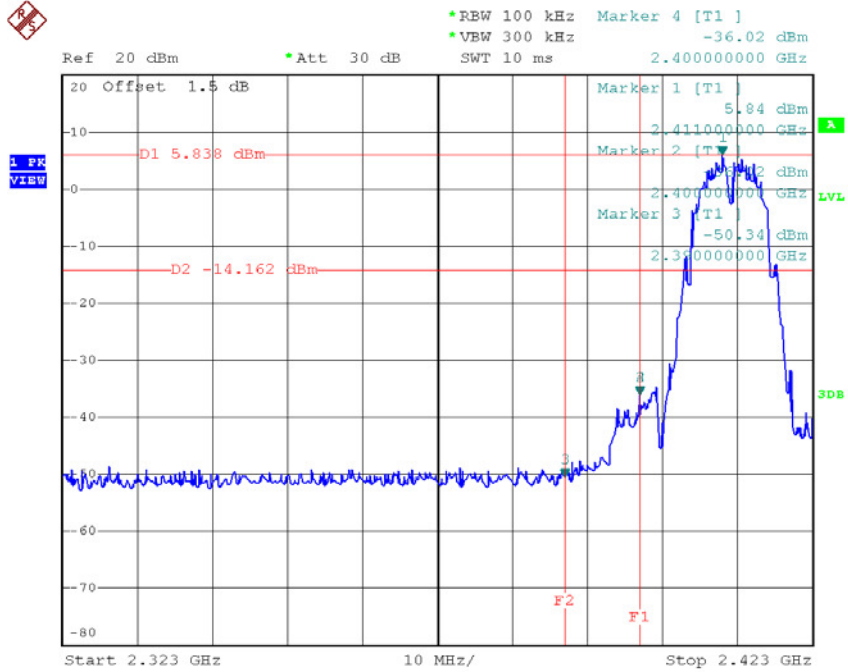

Date: 28.FEB.2017 10:14:12

TX B mode CH11

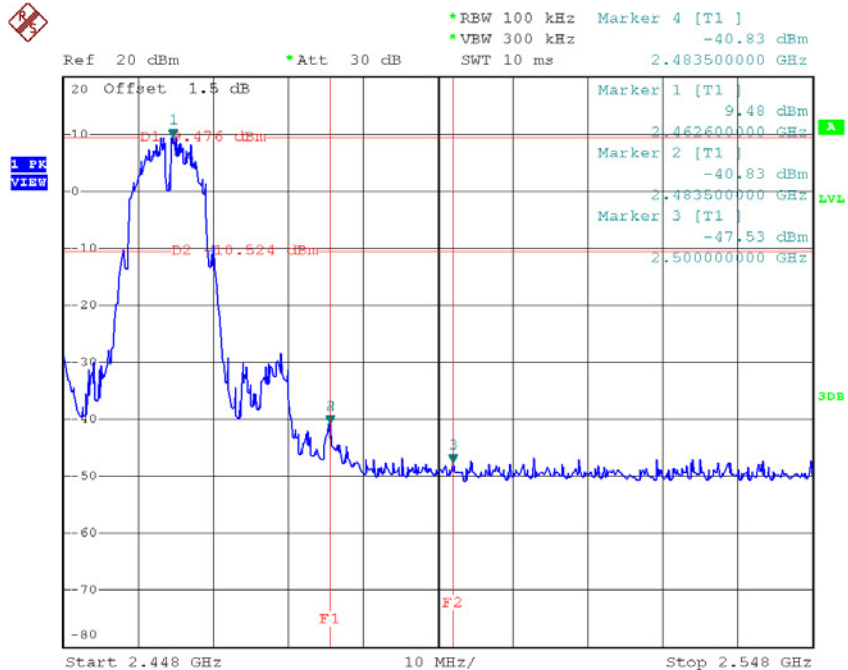

Date: 28.FEB.2017 10:28:17

TX B mode CH01 (10 Harmonic of the frequency)

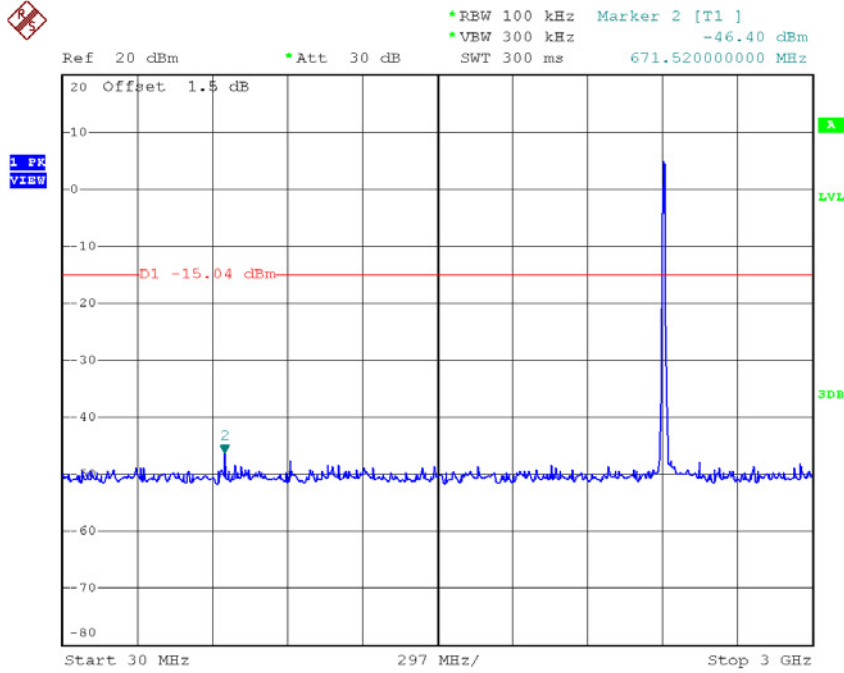

Date: 28.FEB.2017 10:13:48

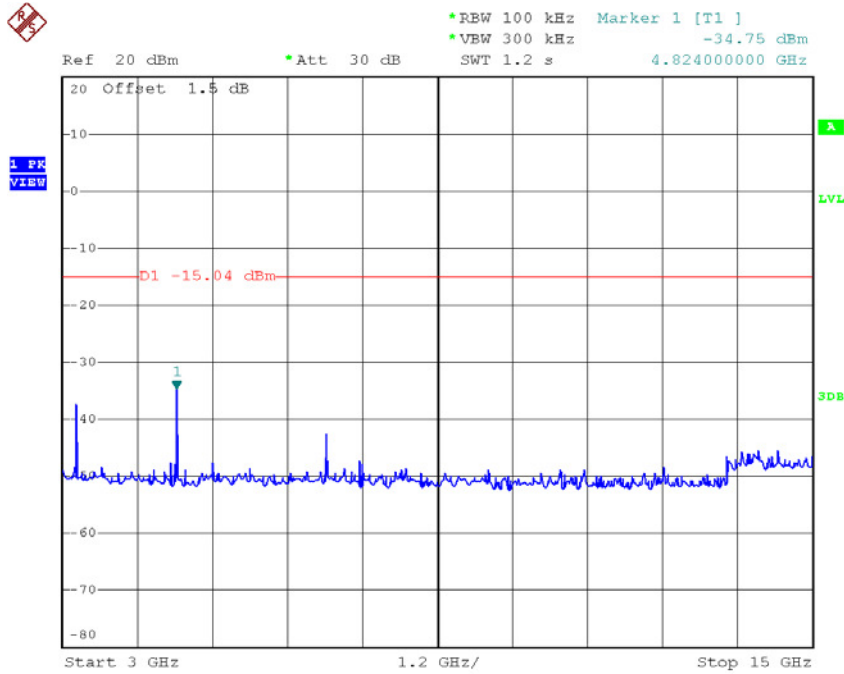

Date: 28.FEB.2017 10:13:57

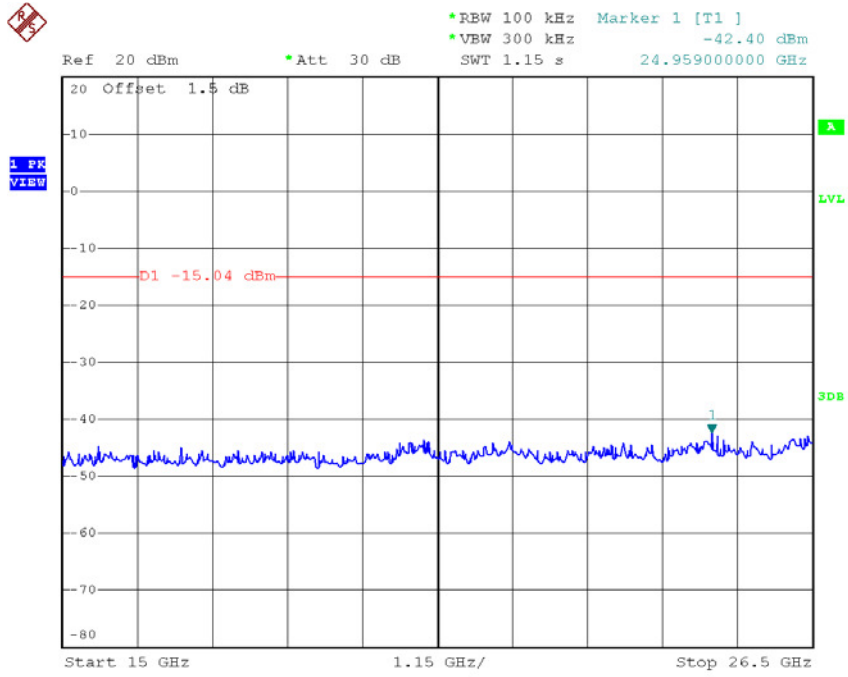

Date: 28.FEB.2017 10:14:05

TX B mode CH06 (10 Harmonic of the frequency)

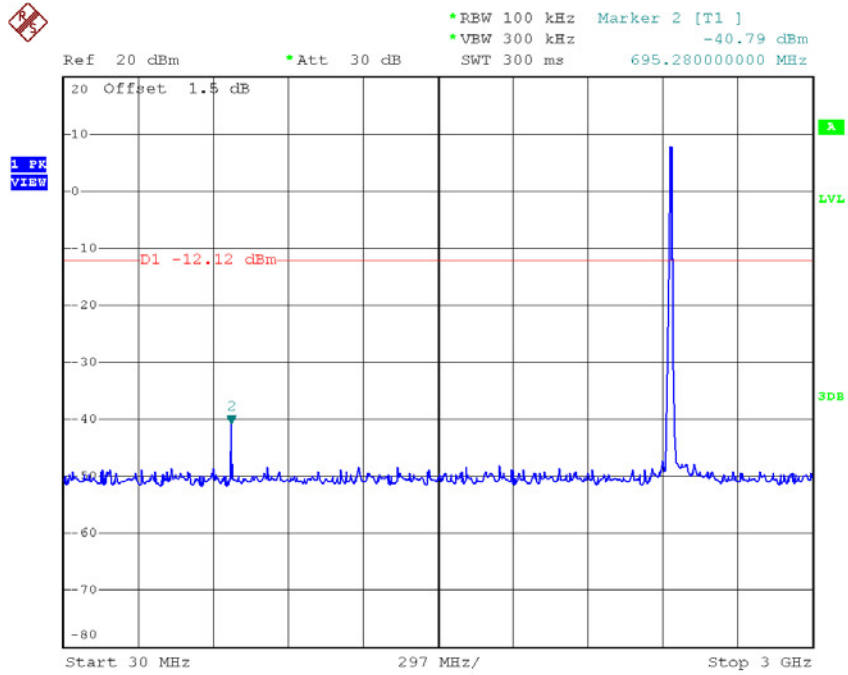

Date: 28.FEB.2017 10:16:08

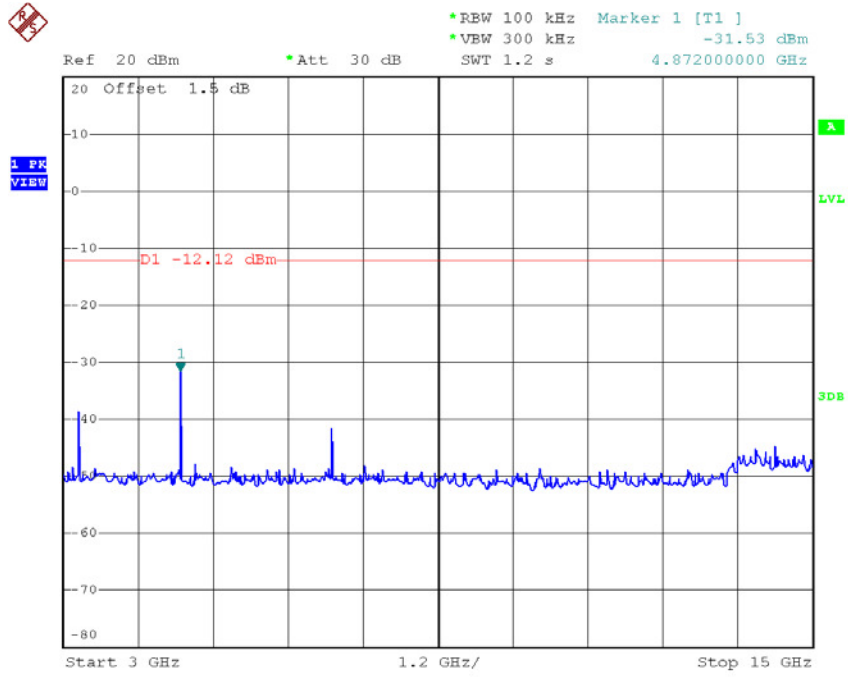

Date: 28.FEB.2017 10:16:16

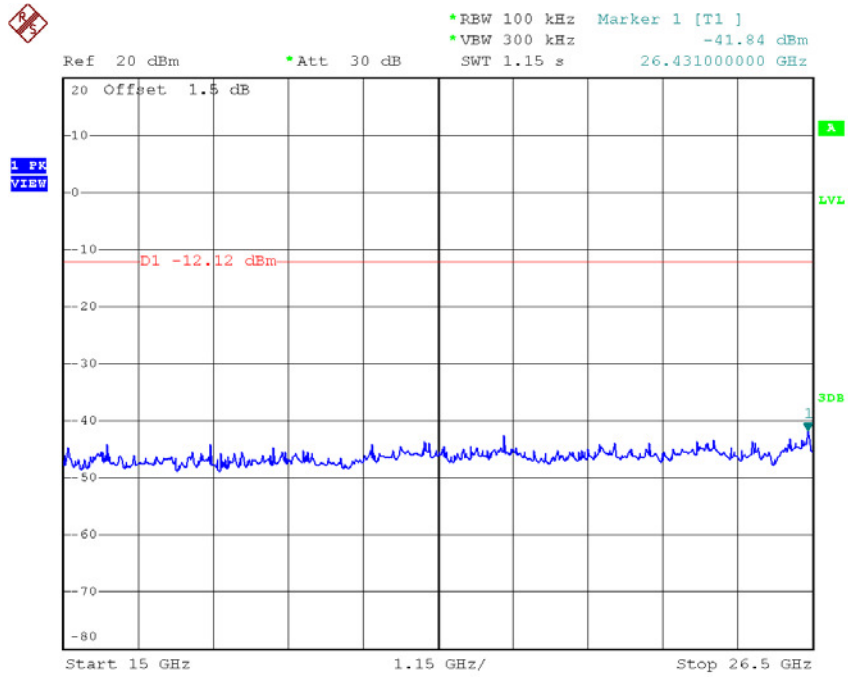

Date: 28.FEB.2017 10:16:24

TX B mode CH11 (10 Harmonic of the frequency)

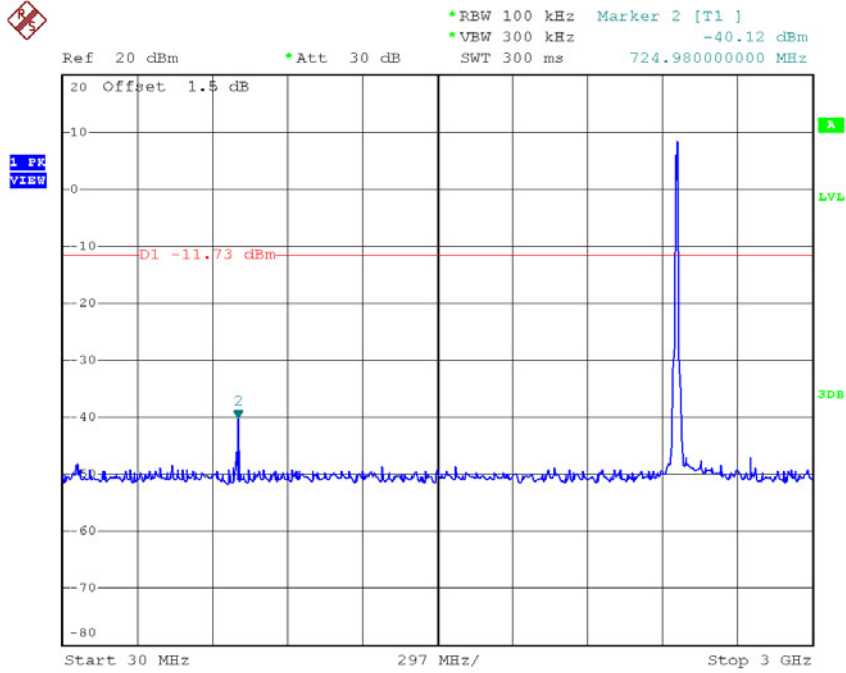

Date: 28.FEB.2017 10:27:53

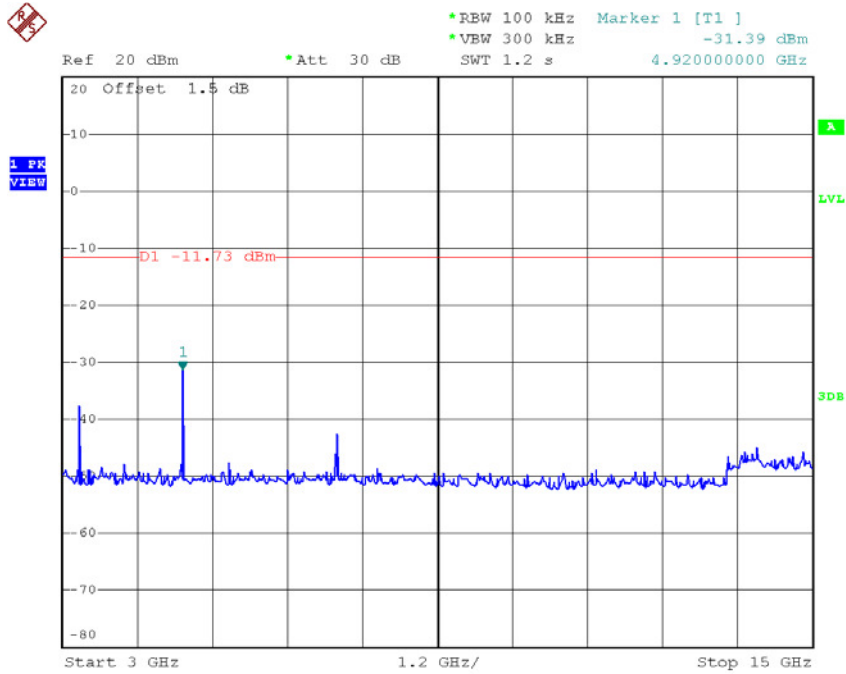

Date: 28.FEB.2017 10:28:01

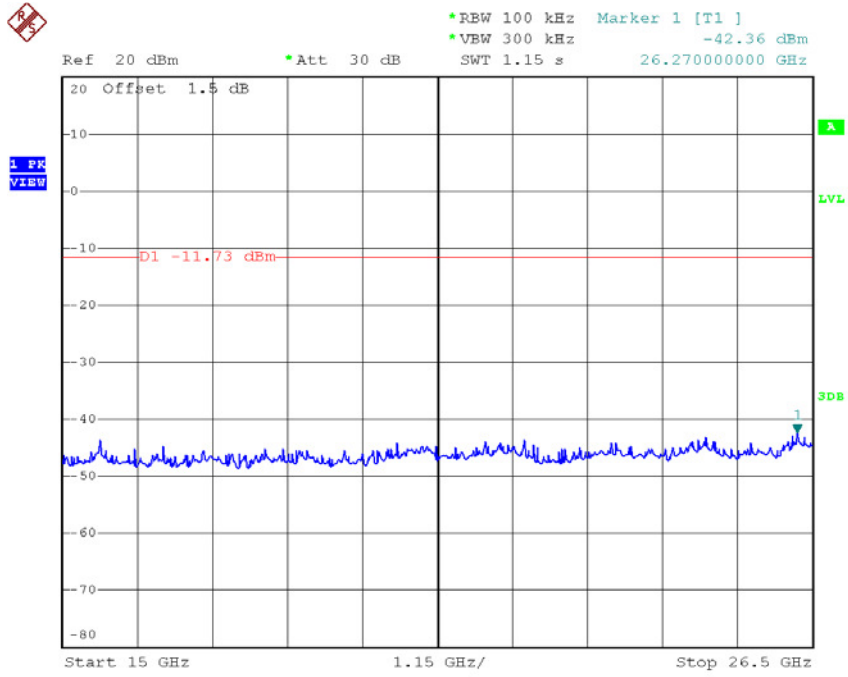

Date: 28.FEB.2017 10:28:09

Test Mode : TX G Mode

TX G mode CH01

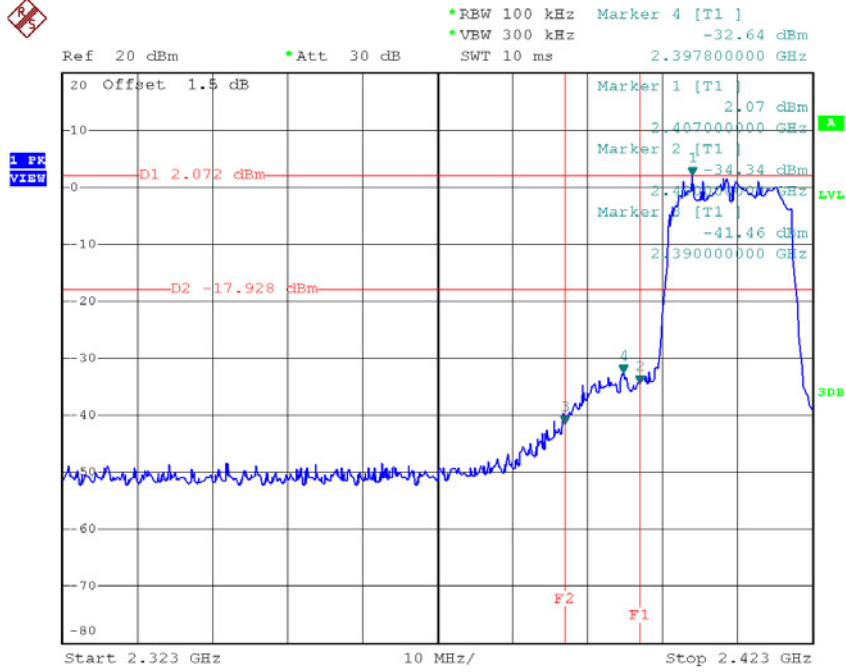

Date: 28.FEB.2017 10:31:33

TX G mode CH11

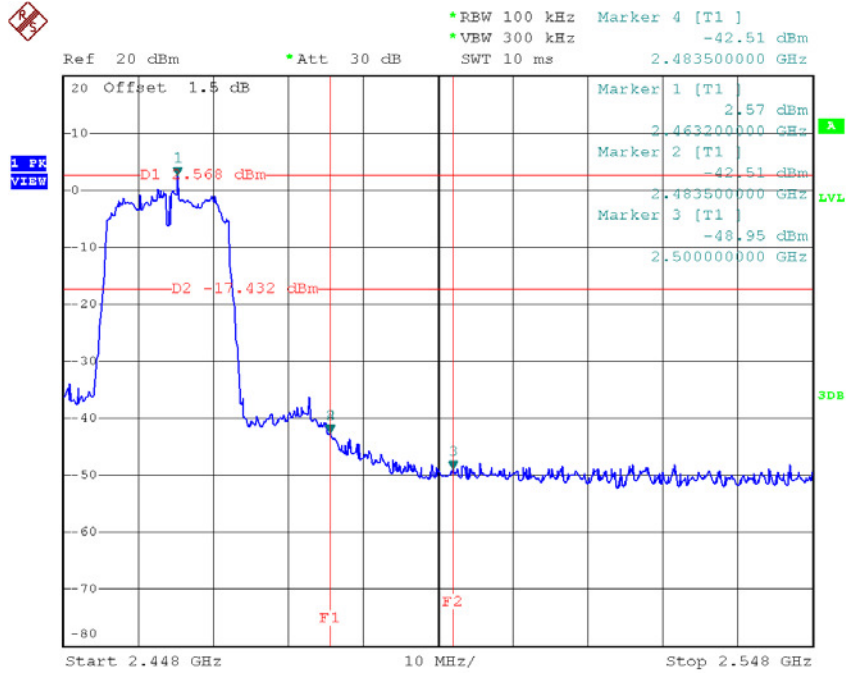

Date: 28.FEB.2017 10:35:34

TX G mode CH01 (10 Harmonic of the frequency)

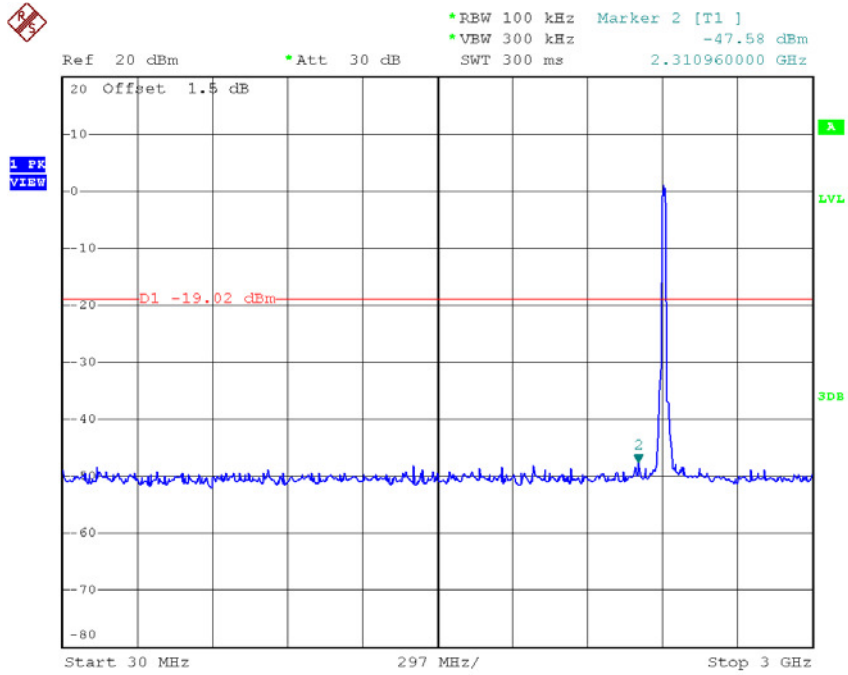

Date: 28.FEB.2017 10:31:09

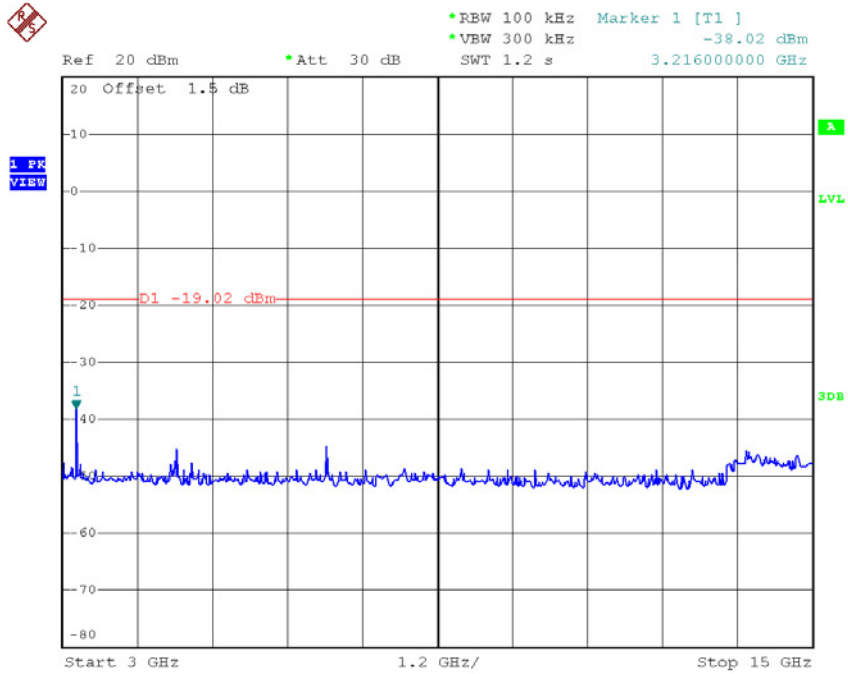

Date: 28.FEB.2017 10:31:17