

ELECTROMAGNETIC EMISSIONS COMPLIANCE REPORT

INTENTIONAL RADIATOR CERTIFICATION TO FCC PART 22 SUBPART H and PART 24 SUBPART E

OF

Product Name: 3.5G PDA phone

Brand / Marketing Name: i-mate™

Model Name: Ultimate 8150

FCC ID: PJO9002

Report No.: EH/2007/60006~7

Issue Date: Oct. 15, 2007

FCC Rule Part: 2, 22H & 24E

Prepared for: ARIMA COMMUNICATIONS CORP.
No.16, Lane 658, Ying Tao Road, Yingko,
Taipei Hsien, Taiwan, R.O.C.

Prepared by: SGS Taiwan Ltd.
No. 134, Wu Kung Rd., Wuku Industrial
Zone, Taipei County, Taiwan.

Note: This report shall not be reproduced except in full, without the written approval of SGS Taiwan Ltd. This document may be altered or revised by SGS Taiwan Ltd. personnel only, and shall be noted in the revision section of the document.

VERIFICATION OF COMPLIANCE

Applicant: ARIMA COMMUNICATIONS CORP.
 No.16, Lane 658, Ying Tao Road, Yingko,
 Taipei Hsien, Taiwan, R.O.C.

Product Name: 3.5G PDA phone

FCC ID Number: PJO9002

Brand / Marketing Name: i-mate™

Model No.: Ultimate 8150

Model Difference: N/A

File Number: EH/2007/60006~7

Date of test: May 28, 2007~Oct. 15, 2007

Date of EUT Received: May 28, 2007

We hereby certify that:

The above equipment was tested by SGS Taiwan Ltd. The test data, data evaluation, test procedures, and equipment configurations shown in this report were made in accordance with the procedures given in TIA/EIA-603-1-1998 and the energy emitted by the sample EUT tested as described in this report is in compliance with conducted and radiated emission limits of FCC Rule FCC PART 22 subpart H and FCC PART 24 subpart E.

The test results of this report relate only to the tested sample identified in this report.

Test By:  **Date** Oct. 15, 2007

Sky Wang / Sr. Engineer

Prepared By:  **Date** Oct. 15, 2007

Eva Kao / Sr. Engineer

Approved By  **Date** Oct. 15, 2007

Vincent Su / Manager

Version

Version No.	Date
00	Jul. 12, 2007
01	Oct. 15, 2007

This document is issued by the Company subject to its General Conditions of Service printed overleaf or available on request and accessible at www.sgs.com. Attention is drawn to the limitations of liability, indemnification, and Jurisdictional issued defined therein. Unless otherwise stated, the results shown in this test report refer only to the sample(s) tested. This document cannot be reproduced except in full, without prior approval of Company. Any unauthorized alteration, forgery or falsification of the content or appearance of this report is unlawful and offenders may be prosecuted to the fullest extent of the law. 此報告是遵循本公司訂定之通用服務條款所製作發放，請注意此條款列印於背面，亦可在www.sgs.com中查閱。將本公司之義務，免責，管轄權皆明確規範之。除非另有說明，此報告結果僅對檢驗之樣品負責。本報告未經本公司書面許可，不可部份複製。對本報告內容或外觀之任何未經授權之變更、偽造、竄改皆屬非法，違犯者將會被依法追訴。

Table of Contents

1. GENERAL INFORMATION	6
1.1 Product Description	6
1.2 Related Submittal(s) / Grant (s)	7
1.3 Test Methodology	8
1.4 Test Facility	8
1.5 Special Accessories	8
1.6 Equipment Modifications	8
2. SYSTEM TEST CONFIGURATION	9
2.1 EUT Configuration	9
2.2 EUT Exercise	9
2.3 Test Procedure	9
2.4 Configuration of Tested System	10
3. SUMMARY OF TEST RESULTS	11
4. DESCRIPTION OF TEST MODES	11
5. RF POWER OUTPUT MEASUREMENT	12
5.1 Standard Applicable	12
5.2 Test Set-up:	12
5.3 Measurement Procedure	12
5.4 Measurement Equipment Used:	13
5.5 Measurement Result	14
6. ERP, EIRP MEASUREMENT	16
6.1 Standard Applicable	16
6.2 Test SET-UP (Block Diagram of Configuration)	16
6.3 Measurement Procedure	18
6.4 Measurement Equipment Used:	19
6.5 Measurement Result	20
7. 99% OCCUPIED BANDWIDTH MEASUREMENT	26
7.1 Standard Applicable	26
7.2 Test Set-up:	26
7.3 Measurement Procedure	26
7.4 Measurement Equipment Used:	27
7.5 Measurement Result:	28
8. OUT OF BAND EMISSION AT ANTENNA TERMINALS	39
8.1 Standard Applicable	39
8.2 Test SET-UP	39

This document is issued by the Company subject to its General Conditions of Service printed overleaf or available on request and accessible at www.sgs.com. Attention is drawn to the limitations of liability, indemnification, and Jurisdictional issued defined therein. Unless otherwise stated, the results shown in this test report refer only to the sample(s) tested. This document cannot be reproduced except in full, without prior approval of Company. Any unauthorized alteration, forgery or falsification of the content or appearance of this report is unlawful and offenders may be prosecuted to the fullest extent of the law. 此報告是遵循本公司訂定之通用服務條款所製作發放，請注意此條款列印於背面，亦可在www.sgs.com中查閱。將本公司之義務，免責，管轄權皆明確規範之。除非另有說明，此報告結果僅對檢驗之樣品負責。本報告未經本公司書面許可，不可部份複製。對本報告內容或外觀之任何未經授權之變更、偽造、竄改皆屬非法，違犯者將會被依法追訴。

8.3	Measurement Procedure.....	39
8.4	Measurement Equipment Used:	40
8.5	Measurement Result.....	41
9.	FIELD STRENGTH OF SPURIOUS RADIATION MEASUREMENT	57
9.1	Standard Applicable	57
9.2	EUT Setup (Block Diagram of Configuration).....	57
9.3	Measurement Procedure.....	59
9.4	Measurement Equipment Used:	60
9.5	Measurement Result.....	60
10.	FREQUENCY STABILITY V.S. TEMPERATURE MEASUREMENT	85
10.1	Standard Applicable	85
10.2	Test Set-up:	85
10.3	Measurement Procedure.....	85
10.4	Measurement Equipment Used:	86
10.5	Measurement Result.....	87
11.	FREQUENCY STABILITY V.S. VOLTAGE MEASUREMENT	90
11.1	Standard Applicable	90
11.2	Test Set-up:	90
11.3	Measurement Procedure.....	90
11.4	Measurement Equipment Used:	91
11.5	Measurement Result.....	92
12.	AC POWER LINE CONDUCTED EMISSION TEST	95
12.1	Standard Applicable	95
12.2	EUT Setup.....	95
12.3	Measurement Procedure.....	95
12.4	Measurement Equipment Used:	96
12.5	Measurement Result.....	96

This document is issued by the Company subject to its General Conditions of Service printed overleaf or available on request and accessible at www.sgs.com. Attention is drawn to the limitations of liability, indemnification, and Jurisdictional issued defined therein. Unless otherwise stated, the results shown in this test report refer only to the sample(s) tested. This document cannot be reproduced except in full, without prior approval of Company. Any unauthorized alteration, forgery or falsification of the content or appearance of this report is unlawful and offenders may be prosecuted to the fullest extent of the law. 此報告是遵循本公司訂定之通用服務條款所製作發放，請注意此條款列印於背面，亦可在www.sgs.com中查閱。將本公司之義務，免責，管轄權皆明確規範之。除非另有說明，此報告結果僅對檢驗之樣品負責。本報告未經本公司書面許可，不可部份複製。對本報告內容或外觀之任何未經授權之變更、偽造、竄改皆屬非法，違犯者將會被依法追訴。

1. GENERAL INFORMATION

1.1 Product Description

Product Name:	3.5G PDA phone	
Brand / Marketing Name:	i-mate™	
Model Name:	Ultimate 8150	
Model Difference:	N/A	
Simple Hands-Free (SHF):	Mode No.: N/A, Supplier: N/A	
Data Cable (USB):	1 cable, model: N/A	
TV out cable	1 cable, model: N/A	
Power Supply	3.7 Vdc re-chargeable battery or 5Vdc by AC/DC power adapter	
	Battery Model:	i-mate™ Ultimate, Supplier: Welldone
	Adapter Model:	PSAA05A-050, Supplier: PHIHONG

GSM and WCDMA:

Cellular Phone Standards Frequency Range and Power	GSM/GPRS 850	824 MHz– 849MHz	33 dBm
	EDGE 850	824 MHz– 849MHz	27 dBm
	GSM/GPRS 1900	824 MHz– 849MHz	30 dBm
	EDGE 1900	824 MHz– 849MHz	26 dBm
	WCDMA Band II	1850MHz – 1910MHz	24 dBm
	WCDMA Band V	824 MHz– 849MHz	24 dBm
Type of Emission	GSM: 300KGXW EDGE: 300KGXW WCDMA: 4M20F9W		
IMEI	35568801048320		
Software Version	9001_RIL_FTA_V03		

This document is issued by the Company subject to its General Conditions of Service printed overleaf or available on request and accessible at www.sgs.com. Attention is drawn to the limitations of liability, indemnification, and Jurisdictional issued defined therein. Unless otherwise stated, the results shown in this test report refer only to the sample(s) tested. This document cannot be reproduced except in full, without prior approval of Company. Any unauthorized alteration, forgery or falsification of the content or appearance of this report is unlawful and offenders may be prosecuted to the fullest extent of the law. 此報告是遵循本公司訂定之通用服務條款所製作發放，請注意此條款列印於背面，亦可在www.sgs.com中查閱。將本公司之義務，免責，管轄權皆明確規範之。除非另有說明，此報告結果僅對檢驗之樣品負責。本報告未經本公司書面許可，不可部份複製。對本報告內容或外觀之任何未經授權之變更、偽造、竄改皆屬非法，違犯者將會被依法追訴。

Hardware Version	EP2
------------------	-----

WLAN:

Frequency Range	2412 – 2462 MHz
Channel number	11 channels
Rated Power	802.11 b: 13.83 dBm 802.11 g: 11.60 dBm
Modulation Technology	DSSS, OFDM
Modulation type	CCK, DQPSK, DBPSK for DSSS 64QAM, 16QAM, QPSK, BPSK for OFDM
Transition Rate:	802.11 b: 1/2/5.5/11/54 Mbps; 802.11 g: 6/9/12/18/24/36/48/54 Mbps
Antenna Designation	PIFA Antenna, -3.79 dBi.

The EUT is compliance with IEEE 802.11 b/g Standard.

Bluetooth:

Frequency Range	2402 – 2480MHz
Channel number	79 channels
Rated Power	2.52 dBm (Peak)
Modulation type	Frequency Hopping Spread Spectrum (FHSS)(FGSK)
Antenna Designation	PIFA Antenna, -3.94 dBi

The EUT is compliance with Bluetooth Standard.

This test report applies for GSM/GPRS/EDGE 850, GSM/GPRS/EDGE 1900, WCDMA Band II, and WCDMA Band V.

1.2 Related Submittal(s) / Grant (s)

This submittal(s) (test report) is intended for **FCC ID: PJO9002** filing to comply with Section Part 22 subpart H and Part 24 subpart E of the FCC CFR 47 Rules.

1.3 Test Methodology

Both conducted and radiated testing were performed according to the procedures document on chapter 13 of ANSI C63.4 (2003) and FCC CFR 47.1046, 2.1047, 2.1049, 2.1051, 2.1053, 2.1055 and 2.1057.

1.4 Test Facility

The open area test site and conducted measurement facility used to collect the radiated data is located on the address of SGS Taiwan Ltd. No. 134, Wu Kung Rd., Wuku Industrial Zone, Taipei Country, Taiwan. The Open Area Test Sites and the Line Conducted labs are constructed and calibrated to meet the FCC requirements in documents ANSI C63.4: 2003 and CISPR 22/EN 55022 requirements. Site No. 1(3 & 10 meters) Registration Number: 94644, Both OATS and Anechoic chamber (3 meters) was accredited by TAF (0513). Canada Registration Number: 4620A-1

1.5 Special Accessories

Not available for this EUT intended for grant.

1.6 Equipment Modifications

Not available for this EUT intended for grant.

2. SYSTEM TEST CONFIGURATION

2.1 EUT Configuration

The EUT configuration for testing is installed on RF field strength measurement to meet the Commissions requirement and operating in a manner which intends to maximize its emission characteristics in a continuous normal application.

2.2 EUT Exercise

The EUT (Transmitter) was operated in the engineering mode to fix the Tx frequency which was for the purpose of the measurements.

2.3 Test Procedure

2.3.1 Conducted Emissions

The EUT is placed on a turn table which is 0.8 m above ground plane. According to the requirements in Section 7 and 13 of ANSI C63.4-2003. Conducted emissions from the EUT measured in the frequency range between 0.15 MHz and 30MHz using CISPR Quasi-Peak and Average detector mode.

2.3.2 Radiated Emissions

The EUT is placed on a turn table which is 1.0 m above ground plane. The turn table shall rotate 360 degrees to determine the position of maximum emission level. EUT is set 3m away from the receiving antenna which varied from 1m to 4m to find out the highest emission. And also, each emission was to be maximized by changing the polarization of receiving antenna both horizontal and vertical. In order to find out the max. emission, the relative positions of this hand-held transmitter (EUT) was rotated through three orthogonal axes according to the requirements in Section 8 and 13 of ANSI C63.4-2003.

2.4 Configuration of Tested System

Fig. 2-1 Configuration of Tested System (Fixed Channel)

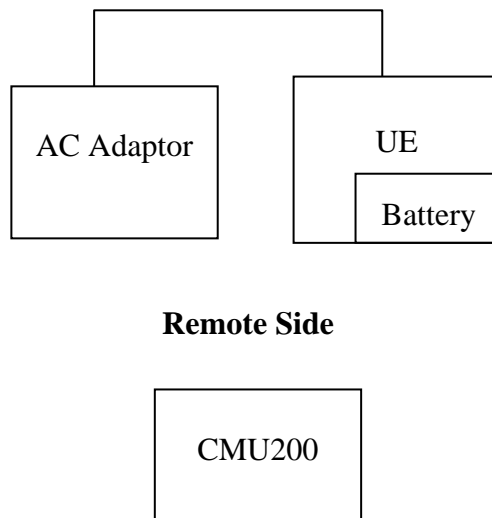

Table 2-1 Equipment Used in Tested System

Item	Equipment	Mfr/Brand	Model/ Type No.	Series No.	Data Cable	Power Cord
1.	Universal Radio Communication Tester	R&S	CMU200	102189	shielded	Un-shielded

3. SUMMARY OF TEST RESULTS

FCC Rules	Description Of Test	Result
§2.1046(a) §22.913(a) §24.232(a)	RF Power Output	Compliant
§2.1046(a) §22.913(a) §24.232(a)	ERP/ EIRP measurement	Compliant
§2.1049(h)	99% Occupied Bandwidth	Compliant
§2.1051 §22.917(a) §24.238(a)	Out of Band Emissions at Antenna Terminals and Band Edge	Compliant
§2.1053 §22.917(a) §24.238(a)	Field Strength of Spurious Radiation	Compliant
§2.1055(a)(1)(b)	Frequency Stability vs. Temperature	Compliant
§2.1055(d)(1)(2)	Frequency Stability vs. Voltage	Compliant
§15.107;§15.207	AC Power Line Conducted Emission	Compliant

4. DESCRIPTION OF TEST MODES

The EUT has been tested under operating condition.

EUT staying in continuous transmitting mode. Channel Low, Mid and High for each type band with rated data rate were chosen for full testing.

The field strength of spurious radiation emission was measured as EUT stand-up position (E1 mode) and lie down position (E1, E2 mode) for both GSM/GPRS/EDGE and WCDMA Band II and V with power adaptors, earphone and Data cable. The worst-case H mode for GSM 850 band, E2 mode for GSM 1900 band, H mode for WCDMA band II and WCDMA Band II with power adaptor for channel Low, Mid and High at each modes were reported.

5. RF POWER OUTPUT MEASUREMENT

5.1 Standard Applicable

According to FCC §2.1046.

FCC 22.913(a) Mobile station are limited to 7W.

FCC 24.232(b) Mobile station are limited to 2W.

5.2 Test Set-up:

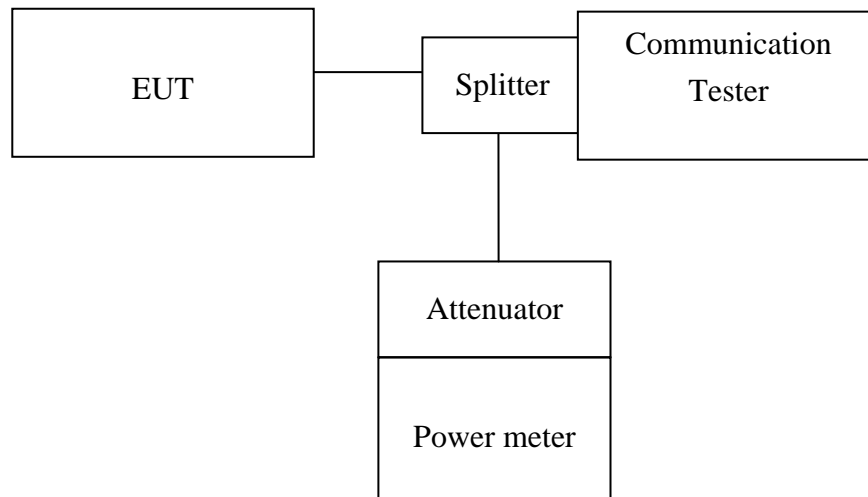

Note: Measurement setup for testing on Antenna connector

5.3 Measurement Procedure

The transmitter output was connected to a calibrated attenuator, the other end of which was connected to a power meter. Transmitter output was read off the power meter in dBm. The power output at the transmitter antenna port was determined by adding the value of the attenuator to the power meter reading.

5.4 Measurement Equipment Used:

Conducted Emission Test Site					
EQUIPMENT TYPE	MFR	MODEL NUMBER	SERIAL NUMBER	LAST CAL.	CAL DUE.
Spectrum Analyzer	Agilent	E4446A	MY43360126	04/27/2007	04/26/2008
Spectrum Analyzer	Agilent	E7405A	US41160416	07/04/2007	07/03/2008
Power Sensor	Anritsu	MA2490A	31431	07/07/2007	07/06/2008
Power Meter	Anritsu	ML2487A	6K00002070	07/07/2007	07/06/2008
Communication Test	R&S	SMU200	N/A	N/A	N/A
Temperature Chamber	TERCHY	MHG-120LF	911009	04/26/2007	04/25/2008
Low Loss Cable	HUBER+SUHNER	SUCOFLEX 104PEA	N/A	N/A	N/A
Attenuator	Mini-Circuit	BW-S10W5	N/A	07/05/2007	07/04/2008
Attenuator	Mini-Circuit	BW-S6W5	N/A	07/05/2007	07/04/2008
Splitter	Agilent	11636B	51728	09/23/2007	09/22/2008
Signal Generator	R&S	SMR40	100210	11/09/2006	11/10/2007
DC Power Supply	Agilent	6038A	2929A-07548	01/06/2007	01/05/2008

This document is issued by the Company subject to its General Conditions of Service printed overleaf or available on request and accessible at www.sgs.com. Attention is drawn to the limitations of liability, indemnification, and Jurisdictional issued defined therein. Unless otherwise stated, the results shown in this test report refer only to the sample(s) tested. This document cannot be reproduced except in full, without prior approval of Company. Any unauthorized alteration, forgery or falsification of the content or appearance of this report is unlawful and offenders may be prosecuted to the fullest extent of the law. 此報告是遵循本公司訂定之通用服務條款所製作發放，請注意此條款列印於背面，亦可在www.sgs.com中查閱。將本公司之義務，免責，管轄權皆明確規範之。除非另有說明，此報告結果僅對檢驗之樣品負責。本報告未經本公司書面許可，不可部份複製。對本報告內容或外觀之任何未經授權之變更、偽造、竄改皆屬非法，違犯者將會被依法追訴。

5.5 Measurement Result

EUT Mode	Frequency (MHz)	CH	Power meter Reading (dBm)	Path Loss (dB)	Peak Power (dBm)
GSM 850	824.20	128	31.20	0.50	31.70
	836.60	190	31.40	0.50	31.90
	848.80	251	31.50	0.50	32.00

EUT Mode	Frequency (MHz)	CH	Power Meter Reading (dBm)	Path Loss (dB)	Peak Power (dBm)
PCS 1900	1850.20	512	28.55	0.50	29.05
	1880.00	661	28.50	0.50	29.00
	1909.80	810	28.60	0.50	29.10

EUT Mode	Frequency (MHz)	CH	Power meter Reading (dBm)	Path Loss (dB)	Peak Power (dBm)
EDGE 850	824.20	128	25.80	0.50	26.30
	836.60	190	25.70	0.50	26.40
	848.80	251	25.70	0.50	26.40

EUT Mode	Frequency (MHz)	CH	Power Meter Reading (dBm)	Path Loss (dB)	Peak Power (dBm)
EDGE 1900	1850.20	512	24.9	0.50	25.4
	1880.00	661	24.8	0.50	25.3
	1909.80	810	24.9	0.50	25.4

This document is issued by the Company subject to its General Conditions of Service printed overleaf or available on request and accessible at www.sgs.com. Attention is drawn to the limitations of liability, indemnification, and Jurisdictional issued defined therein. Unless otherwise stated, the results shown in this test report refer only to the sample(s) tested. This document cannot be reproduced except in full, without prior approval of Company. Any unauthorized alteration, forgery or falsification of the content or appearance of this report is unlawful and offenders may be prosecuted to the fullest extent of the law. 此報告是遵循本公司訂定之通用服務條款所製作發放，請注意此條款列印於背面，亦可在www.sgs.com中查閱。將本公司之義務，免責，管轄權皆明確規範之。除非另有說明，此報告結果僅對檢驗之樣品負責。本報告未經本公司書面許可，不可部份複製。對本報告內容或外觀之任何未經授權之變更、偽造、竄改皆屬非法，違犯者將會被依法追訴。

EUT Mode	Frequency (MHz)	CH	Power Meter Reading (dBm)	Path Loss (dB)	Peak Power (dBm)
WCDMA Band II	1852.40	9262	22.74	0.50	23.24
	1880.00	9400	22.79	0.50	23.29
	1907.60	9538	22.62	0.50	23.12

EUT Mode	Frequency (MHz)	CH	Power meter Reading (dBm)	Path Loss (dB)	Peak Power (dBm)
WCDMA Band V	826.40	4132	22.00	0.50	22.50
	836.00	4180	22.02	0.50	22.52
	846.60	4233	22.52	0.50	23.02

This document is issued by the Company subject to its General Conditions of Service printed overleaf or available on request and accessible at www.sgs.com. Attention is drawn to the limitations of liability, indemnification, and Jurisdictional issued defined therein. Unless otherwise stated, the results shown in this test report refer only to the sample(s) tested. This document cannot be reproduced except in full, without prior approval of Company. Any unauthorized alteration, forgery or falsification of the content or appearance of this report is unlawful and offenders may be prosecuted to the fullest extent of the law. 此報告是遵循本公司訂定之通用服務條款所製作發放，請注意此條款列印於背面，亦可在www.sgs.com中查閱。將本公司之義務，免責，管轄權皆明確規範之。除非另有說明，此報告結果僅對檢驗之樣品負責。本報告未經本公司書面許可，不可部份複製。對本報告內容或外觀之任何未經授權之變更、偽造、竄改皆屬非法，違犯者將會被依法追訴。

6. ERP, EIRP MEASUREMENT

6.1 Standard Applicable

According to FCC §2.1046

FCC 22.913(a) Mobile station are limited to 7W ERP.

FCC 24.232(b) Mobile station are limited to 2W EIRP.

6.2 Test SET-UP (Block Diagram of Configuration)

(A) Radiated Emission Test Set-Up, Frequency Below 1000MHz

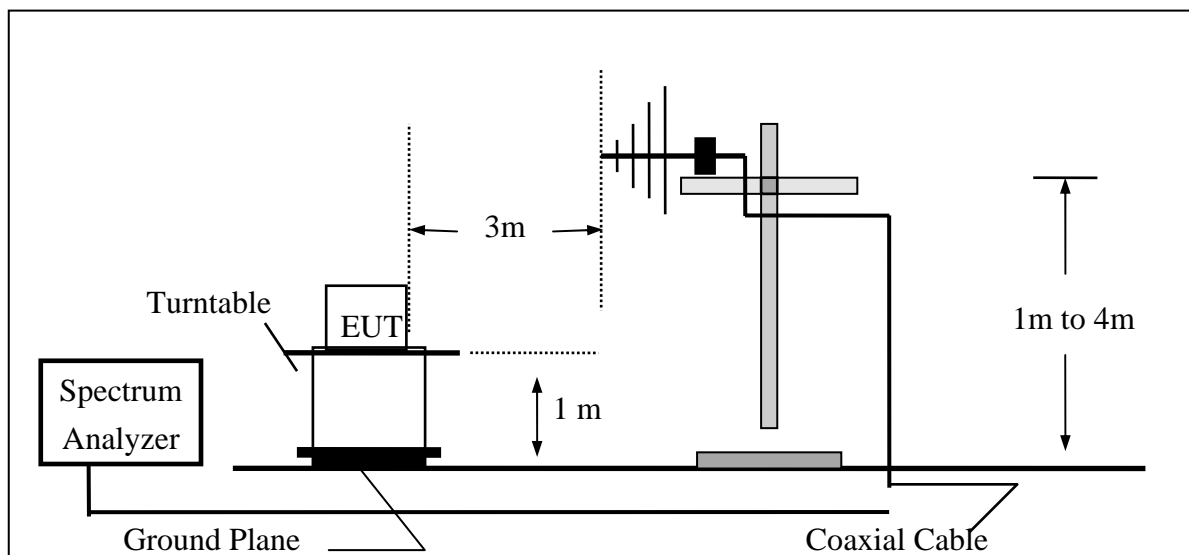

This document is issued by the Company subject to its General Conditions of Service printed overleaf or available on request and accessible at www.sgs.com. Attention is drawn to the limitations of liability, indemnification, and Jurisdictional issued defined therein. Unless otherwise stated, the results shown in this test report refer only to the sample(s) tested. This document cannot be reproduced except in full, without prior approval of Company. Any unauthorized alteration, forgery or falsification of the content or appearance of this report is unlawful and offenders may be prosecuted to the fullest extent of the law. 此報告是遵循本公司訂定之通用服務條款所製作發放，請注意此條款列印於背面，亦可在www.sgs.com中查閱。將本公司之義務，免責，管轄權皆明確規範之。除非另有說明，此報告結果僅對檢驗之樣品負責。本報告未經本公司書面許可，不可部份複製。對本報告內容或外觀之任何未經授權之變更、偽造、竄改皆屬非法，違犯者將會被依法追訴。

(B) Radiated Emission Test Set-UP Frequency Over 1 GHz

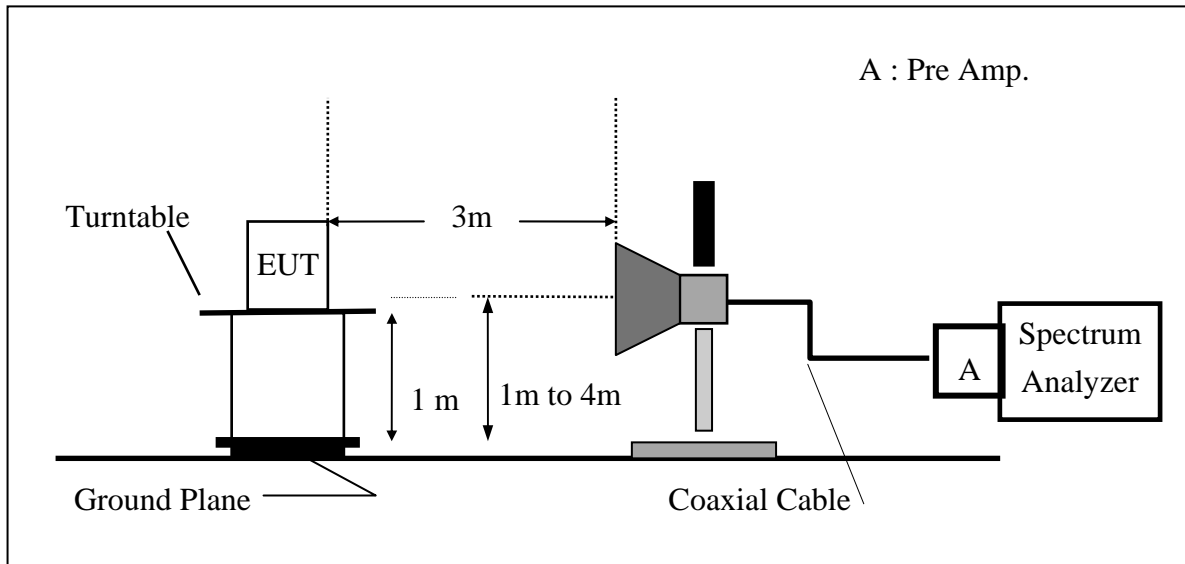

(C) Substituted Method Test Set-UP

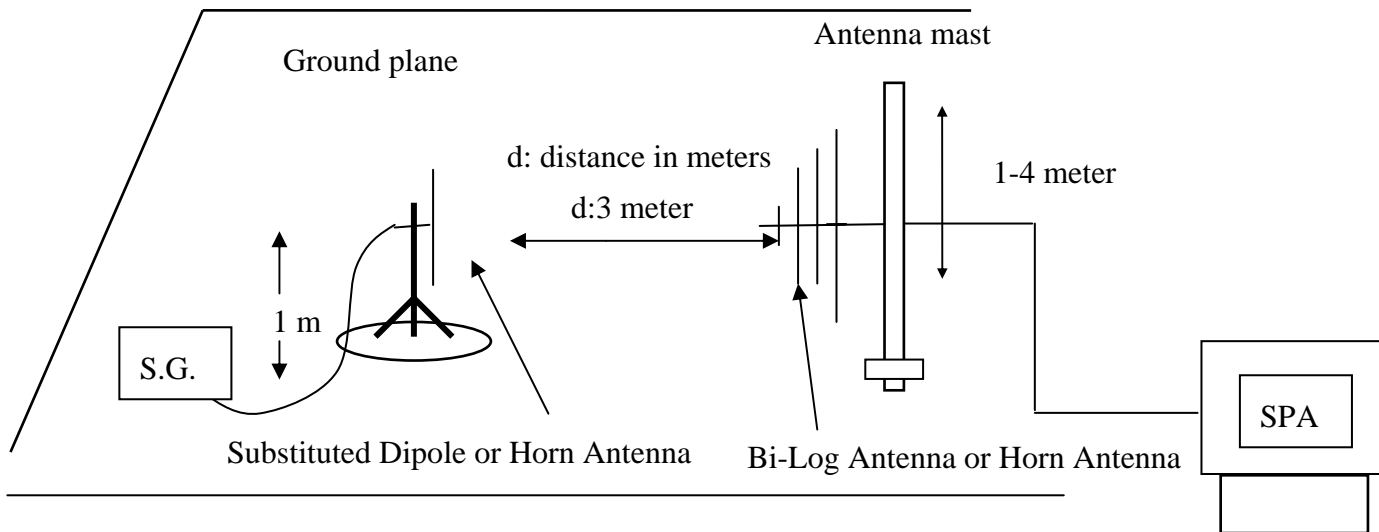

This document is issued by the Company subject to its General Conditions of Service printed overleaf or available on request and accessible at www.sgs.com. Attention is drawn to the limitations of liability, indemnification, and Jurisdictional issued defined therein. Unless otherwise stated, the results shown in this test report refer only to the sample(s) tested. This document cannot be reproduced except in full, without prior approval of Company. Any unauthorized alteration, forgery or falsification of the content or appearance of this report is unlawful and offenders may be prosecuted to the fullest extent of the law. 此報告是遵循本公司訂定之通用服務條款所製作發放，請注意此條款列印於背面，亦可在www.sgs.com中查閱。將本公司之義務，免責，管轄權皆明確規範之。除非另有說明，此報告結果僅對檢驗之樣品負責。本報告未經本公司書面許可，不可部份複製。對本報告內容或外觀之任何未經授權之變更、偽造、竄改皆屬非法，違犯者將會被依法追訴。

6.3 Measurement Procedure

The EUT was placed on a non-conductive turntable using a non-conductive support. The radiated emission at the fundamental frequency was measured at 3 m with a test antenna and EMI spectrum analyzer.

During the measurement, the EUT was in communication with the station. The highest emission was recorded with the rotation of the turntable and the lowering of the test antenna from 4m to 1m. The reading was recorded and the field strength (E in dBuV/m) was calculated.

ERP in frequency band 824.2 –848.80.8MHz were measured using a substitution method. The EUT was replaced by a dipole antenna connected, the S.G. output was recorded and ERP was calculated as follows:

EIRP in frequency band 1850.2 –1909.8MHz were measured using a substitution method. The EUT was replaced by a horn antenna connected, the S.G. output was recorded and EIRP was calculated as follows:

$$\text{ERP} = \text{S.G. output (dBm)} + \text{Antenna Gain (dBd)} - \text{Cable Loss (dB)}$$

$$\text{EIRP} = \text{S.G. output (dBm)} + \text{Antenna Gain (dBi)} - \text{Cable Loss (dB)}$$

6.4 Measurement Equipment Used:

EQUIPMENT TYPE	MFR	MODEL NUMBER	SERIAL NUMBER	LAST CAL.	CAL DUE.
Spectrum Analyzer	Agilent	E4446A	MY43360126	04/27/2007	04/26/2008
Spectrum Analyzer	Agilent	E7405A	US41160416	07/04/2007	07/03/2008
Spectrum Analyzer	R&S	FSP 40	100034	11/09/2006	11/10/2007
Communication Test	R&S	SMU200	N/A	N/A	N/A
Bi-log Antenna	SCHWAZBECK	VULB9160	3224	11/14/2006	11/13/2007
Horn antenna	SCHWAZBECK	BBHA 9120D	309/320	08/16/2007	08/15/2008
Pre-Amplifier	HP	8447D	2944A09469	07/19/2007	07/18/2008
Pre-Amplifier	HP	8494B	3008A00578	02/26/2007	02/25/2008
Signal Generator	R&S	SMR40	100210	02/09/2007	02/10/2008
Turn Table	HD	DT420	N/A	N.C.R	N.C.R
Antenna Tower	HD	MA240-N	240/657	N.C.R	N.C.R
Controller	HD	HD100	N/A	N.C.R	N.C.R
Low Loss Cable	HUBER+SUHNER	SUCOFLEX 104PEA-10M	10m	10/09/2007	10/08/2008
Low Loss Cable	HUBER+SUHNER	SUCOFLEX 104PEA-3M	3m	10/09/2007	10/08/2008
Low Loss Cable	HUBER+SUHNER	SUCOFLEX 104PEA-0.5M	0.5m	10/09/2007	10/08/2008
Site NSA	SGS	966 chamber	N/A	11/17/2006	11/16/2007
Attenuator	Mini-Circuit	BW-S10W5	N/A	09/23/2007	09/22/2008
Dipole Antenna	SCHWAZBECK	VHAP	908/909	06/09/2007	06/10/2008
Dipole Antenna	SCHWAZBECK	UHAP	891/892	06/09/2007	06/10/2008
Horn antenna	SCHWAZBECK	BBHA 9120D	N/A	08/16/2007	08/15/2008

This document is issued by the Company subject to its General Conditions of Service printed overleaf or available on request and accessible at www.sgs.com. Attention is drawn to the limitations of liability, indemnification, and Jurisdictional issued defined therein. Unless otherwise stated, the results shown in this test report refer only to the sample(s) tested. This document cannot be reproduced except in full, without prior approval of Company. Any unauthorized alteration, forgery or falsification of the content or appearance of this report is unlawful and offenders may be prosecuted to the fullest extent of the law. 此報告是遵循本公司訂定之通用服務條款所製作發放，請注意此條款列印於背面，亦可在www.sgs.com中查閱。將本公司之義務，免責，管轄權皆明確規範之。除非另有說明，此報告結果僅對檢驗之樣品負責。本報告未經本公司書面許可，不可部份複製。對本報告內容或外觀之任何未經授權之變更、偽造、竄改皆屬非法，違犯者將會被依法追訴。

6.5 Measurement Result

EUT Mode	Frequency (MHz)	CH	EUT Pol.	Antenna Pol.	SPA Reading (dBuV)	S.G. Output (dBm)	Antenna Gain (dBd)	Cable Loss (dB)	ERP (dBm)	Limit (dBm)
GSM 850	824.20	128	H	V	118.13	31.74	-7.87	3.62	20.24	38.45
				H	124.78	38.51	-7.87	3.62	27.01	38.45
			E1	V	120.76	34.37	-7.87	3.62	22.87	38.45
				H	114.06	27.79	-7.87	3.62	16.29	38.45
			E2	V	115.69	29.30	-7.87	3.62	17.80	38.45
				H	123.14	36.87	-7.87	3.62	25.37	38.45
	836.60	190	H	V	118.99	32.74	-7.88	3.65	21.21	38.45
				H	126.37	40.14	-7.88	3.65	28.61	38.45
			E1	V	122.01	35.76	-7.88	3.65	24.23	38.45
				H	115.00	28.77	-7.88	3.65	17.24	38.45
			E2	V	116.47	30.22	-7.88	3.65	18.69	38.45
				H	124.90	38.67	-7.88	3.65	27.14	38.45
	848.80	251	H	V	120.66	34.54	-7.88	3.68	22.98	38.45
				H	128.10	41.91	-7.88	3.68	30.35	38.45
			E1	V	124.13	38.01	-7.88	3.68	26.45	38.45
				H	115.99	29.80	-7.88	3.68	18.24	38.45
			E2	V	117.76	31.64	-7.88	3.68	20.08	38.45
				H	126.93	40.74	-7.88	3.68	29.18	38.45

Remark :

- (1) The RBW,VBW of SPA for frequency
 Below 1GHz was RBW=100 KHz, VBW=300KHz,
 Above 1GHz was RBW= 1MHz , VBW= 3MHz

6.6 Measurement Result

EUT Mode	Frequency (MHz)	CH	EUT Pol.	Antenna Pol.	SPA Reading (dBuV)	S.G. Output (dBm)	Antenna Gain (dBi)	Cable Loss (dB)	EIRP (dBm)	Limit (dBm)
PCS 1900	1850.20	512	H	V	123.40	19.01	9.90	5.56	23.35	33.00
				H	130.44	26.26	9.90	5.56	30.60	33.00
			E1	V	127.78	23.39	9.90	5.56	27.73	33.00
				H	127.73	23.55	9.90	5.56	27.89	33.00
			E2	V	128.83	24.44	9.90	5.56	28.78	33.00
				H	131.23	27.05	9.90	5.84	31.11	33.00
	1880.00	661	H	V	121.50	17.14	9.99	5.61	21.52	33.00
				H	129.07	24.93	9.99	5.61	29.30	33.00
			E1	V	127.18	22.82	9.99	5.61	27.20	33.00
				H	126.96	22.82	9.99	5.61	27.19	33.00
			E2	V	127.28	22.92	9.99	5.61	27.30	33.00
				H	130.39	26.25	9.99	5.61	30.62	33.00
	1909.80	810	H	V	121.61	17.28	10.08	5.66	21.70	33.00
				H	128.96	24.85	10.08	5.66	29.27	33.00
			E1	V	126.01	21.68	10.08	5.66	26.10	33.00
				H	126.03	21.92	10.08	5.66	26.34	33.00
			E2	V	126.67	22.34	10.08	5.66	26.76	33.00
				H	129.34	25.23	10.08	5.66	29.65	33.00

Remark :

- (1) The RBW,VBW of SPA for frequency
 Below 1GHz was RBW=100 KHz, VBW=300KHz,
 Above 1GHz was RBW= 1MHz , VBW= 3MHz

6.7 Measurement Result

EUT Mode	Frequency (MHz)	CH	EUT Pol.	Antenna Pol.	SPA Reading (dBuV)	S.G. Output (dBm)	Antenna Gain (dBd)	Cable Loss (dB)	ERP (dBm)	Limit (dBm)
EDGE 850	824.20	128	H	V	112.13	25.74	-7.87	3.62	14.24	38.45
				H	118.58	32.31	-7.87	3.62	20.81	38.45
			E1	V	114.46	28.07	-7.87	3.62	16.57	38.45
				H	107.66	21.39	-7.87	3.62	9.89	38.45
			E2	V	109.59	23.20	-7.87	3.62	11.70	38.45
				H	117.24	30.97	-7.87	3.62	19.47	38.45
	836.60	190	H	V	112.69	26.44	-7.88	3.65	14.91	38.45
				H	120.37	34.14	-7.88	3.65	22.61	38.45
			E1	V	115.71	29.46	-7.88	3.65	17.93	38.45
				H	108.80	22.57	-7.88	3.65	11.04	38.45
			E2	V	110.17	23.92	-7.88	3.65	12.39	38.45
				H	118.70	32.47	-7.88	3.65	20.94	38.45
	848.80	251	H	V	114.26	28.14	-7.88	3.68	16.58	38.45
				H	121.80	35.61	-7.88	3.68	24.05	38.45
			E1	V	117.83	31.71	-7.88	3.68	20.15	38.45
				H	109.79	23.60	-7.88	3.68	12.04	38.45
			E2	V	111.76	25.64	-7.88	3.68	14.08	38.45
				H	120.53	34.34	-7.88	3.68	22.78	38.45

Remark :

- (1) The RBW,VBW of SPA for frequency
 Below 1GHz was RBW=100 KHz, VBW=300KHz,
 Above 1GHz was RBW= 1MHz , VBW= 3MHz

6.8 Measurement Result

EUT Mode	Frequency (MHz)	CH	EUT Pol.	Antenna Pol.	SPA Reading (dBUV)	S.G. Output (dBm)	Antenna Gain (dBi)	Cable Loss (dB)	EIRP (dBm)	Limit (dBm)
EDGE 1900	1850.20	512	H	V	117.60	13.21	9.90	5.56	17.55	33.00
				H	124.44	20.26	9.90	5.56	24.60	33.00
			E1	V	121.88	17.49	9.90	5.56	21.83	33.00
				H	121.53	17.35	9.90	5.56	21.69	33.00
			E2	V	122.93	18.54	9.90	5.56	22.88	33.00
				H	125.33	21.15	9.90	5.84	25.21	33.00
	1880.00	661	H	V	115.20	10.84	9.99	5.61	15.22	33.00
				H	123.17	19.03	9.99	5.61	23.40	33.00
			E1	V	120.98	16.62	9.99	5.61	21.00	33.00
				H	120.96	16.82	9.99	5.61	21.19	33.00
			E2	V	121.48	17.12	9.99	5.61	21.50	33.00
				H	124.19	20.05	9.99	5.61	24.42	33.00
	1909.80	810	H	V	115.51	11.18	10.08	5.66	15.60	33.00
				H	122.76	18.65	10.08	5.66	23.07	33.00
			E1	V	120.11	15.78	10.08	5.66	20.20	33.00
				H	120.23	16.12	10.08	5.66	20.54	33.00
			E2	V	120.57	16.24	10.08	5.66	20.66	33.00
				H	123.24	19.13	10.08	5.66	23.55	33.00

Remark :

- (1) The RBW,VBW of SPA for frequency
 Below 1GHz was RBW=100 KHz, VBW=300KHz,
 Above 1GHz was RBW= 1MHz , VBW= 3MHz

6.9 Measurement Result

EUT Mode	Frequency (MHz)	CH	EUT Pol.	Antenna Pol.	SPA Reading (dBuV)	S.G. Output (dBm)	Antenna Gain (dBi)	Cable Loss (dB)	EIRP (dBm)	Limit (dBm)
WCDMA Band II	1852.40	9262	H	V	115.41	11.02	9.90	5.56	15.36	33.00
				H	122.93	18.75	9.90	5.56	23.09	33.00
			E1	V	116.70	12.31	9.90	5.56	16.65	33.00
				H	119.49	15.31	9.90	5.56	19.65	33.00
			E2	V	118.11	13.72	9.90	5.56	18.06	33.00
				H	119.62	15.44	9.90	5.84	19.50	33.00
	1880.00	9400	H	V	114.36	10.00	9.99	5.61	14.38	33.00
				H	122.53	18.39	9.99	5.61	22.76	33.00
			E1	V	116.76	12.40	9.99	5.61	16.78	33.00
				H	119.37	15.23	9.99	5.61	19.60	33.00
			E2	V	117.49	13.13	9.99	5.61	17.51	33.00
				H	120.24	16.10	9.99	5.61	20.47	33.00
	1907.60	9538	H	V	114.36	10.03	10.08	5.66	14.45	33.00
				H	123.27	19.16	10.08	5.66	23.58	33.00
			E1	V	116.40	12.07	10.08	5.66	16.49	33.00
				H	119.27	15.16	10.08	5.66	19.58	33.00
			E2	V	119.04	14.71	10.08	5.66	19.13	33.00
				H	119.92	15.81	10.08	5.66	20.23	33.00

Remark :

- (1) The RBW,VBW of SPA for frequency
 Below 1GHz was RBW=100 KHz, VBW=300KHz,
 Above 1GHz was RBW= 1MHz , VBW= 3MHz

6.10 Measurement Result

EUT Mode	Frequency (MHz)	CH	EUT Pol.	Antenna Pol.	SPA Reading (dBuV)	S.G. Output (dBm)	Antenna Gain (dBd)	Cable Loss (dB)	ERP (dBm)	Limit (dBm)
WCDMA Band V	826.40	4132	H	V	108.54	22.15	-7.87	3.62	10.65	38.45
				H	114.48	28.21	-7.87	3.62	16.71	38.45
			E1	V	109.74	23.35	-7.87	3.62	11.85	38.45
				H	110.46	24.19	-7.87	3.62	12.69	38.45
			E2	V	105.16	18.77	-7.87	3.62	7.27	38.45
				H	112.59	26.32	-7.87	3.62	14.82	38.45
	836.60	4180	H	V	109.68	23.43	-7.88	3.65	11.90	38.45
				H	115.52	29.29	-7.88	3.65	17.76	38.45
			E1	V	111.89	25.64	-7.88	3.65	14.11	38.45
				H	106.46	20.23	-7.88	3.65	8.70	38.45
			E2	V	106.52	20.27	-7.88	3.65	8.74	38.45
				H	114.31	28.08	-7.88	3.65	16.55	38.45
	846.60	4233	H	V	109.35	23.23	-7.88	3.68	11.67	38.45
				H	113.35	27.16	-7.88	3.68	15.60	38.45
			E1	V	111.92	25.80	-7.88	3.68	14.24	38.45
				H	106.07	19.88	-7.88	3.68	8.32	38.45
			E2	V	105.23	19.11	-7.88	3.68	7.55	38.45
				H	111.87	25.68	-7.88	3.68	14.12	38.45

Remark :

- (1) The RBW,VBW of SPA for frequency
 Below 1GHz was RBW=100 KHz, VBW=300KHz,
 Above 1GHz was RBW= 1MHz , VBW= 3MHz

7. 99% OCCUPIED BANDWIDTH MEASUREMENT

7.1 Standard Applicable

According to §FCC 2.1049.

7.2 Test Set-up:

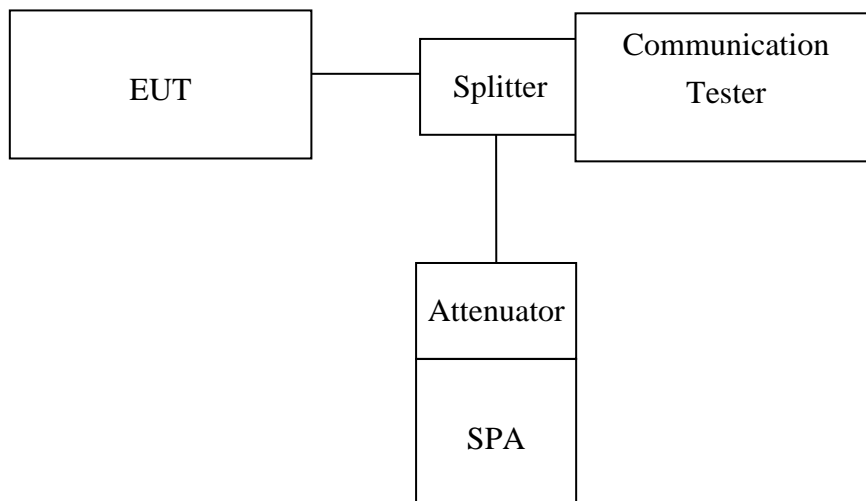

Note: Measurement setup for testing on Antenna connector

7.3 Measurement Procedure

The EUT's output RF connector was connected with a short cable to the spectrum analyzer, RBW (10/47KHz) was set to about 1% of emission BW, VBW= 3 times RBW(30/150KHz), -26dBc display line was placed on the screen (or 99% bandwidth), the occupied bandwidth is the delta frequency between the two points where the display line intersects the signal trace.

7.4 Measurement Equipment Used:

Conducted Emission Test Site					
EQUIPMENT TYPE	MFR	MODEL NUMBER	SERIAL NUMBER	LAST CAL.	CAL DUE.
Spectrum Analyzer	Agilent	E4446A	MY43360126	04/27/2007	04/26/2008
Spectrum Analyzer	Agilent	E7405A	US41160416	07/04/2007	07/03/2008
Power Sensor	Anritsu	MA2490A	31431	07/07/2007	07/06/2008
Power Meter	Anritsu	ML2487A	6K00002070	07/07/2007	07/06/2008
Communication Test	R&S	SMU200	N/A	N/A	N/A
Temperature Chamber	TERCHY	MHG-120LF	911009	04/26/2007	04/25/2008
Low Loss Cable	HUBER+SUHNER	SUCOFLEX 104PEA	N/A	N/A	N/A
Attenuator	Mini-Circuit	BW-S10W5	N/A	07/05/2007	07/04/2008
Attenuator	Mini-Circuit	BW-S6W5	N/A	07/05/2007	07/04/2008
Splitter	Agilent	11636B	51728	09/23/2007	09/22/2008
Signal Generator	R&S	SMR40	100210	11/09/2006	11/10/2007
DC Power Supply	Agilent	6038A	2929A-07548	01/06/2007	01/05/2008

This document is issued by the Company subject to its General Conditions of Service printed overleaf or available on request and accessible at www.sgs.com. Attention is drawn to the limitations of liability, indemnification, and Jurisdictional issued defined therein. Unless otherwise stated, the results shown in this test report refer only to the sample(s) tested. This document cannot be reproduced except in full, without prior approval of Company. Any unauthorized alteration, forgery or falsification of the content or appearance of this report is unlawful and offenders may be prosecuted to the fullest extent of the law. 此報告是遵循本公司訂定之通用服務條款所製作發放，請注意此條款列印於背面，亦可在www.sgs.com中查閱。將本公司之義務，免責，管轄權皆明確規範之。除非另有說明，此報告結果僅對檢驗之樣品負責。本報告未經本公司書面許可，不可部份複製。對本報告內容或外觀之任何未經授權之變更、偽造、竄改皆屬非法，違犯者將會被依法追訴。

7.5 Measurement Result:

EUT Mode	Frequency (MHz)	CH	99% Bandwidth (MHz)
GSM 850	824.20	128	0.2480
	836.60	190	0.2487
	848.80	251	0.2477

EUT Mode	Frequency (MHz)	CH	99% Bandwidth (MHz)
PCS 1900	1850.20	512	0.2441
	1880.00	661	0.2430
	1909.80	810	0.2470

EUT Mode	Frequency (MHz)	CH	99% Bandwidth (MHz)
EDGE 850	824.20	128	0.2454
	836.60	190	0.2464
	848.80	251	0.2433

EUT Mode	Frequency (MHz)	CH	99% Bandwidth (MHz)
EDGE 1900	1850.20	512	0.2434
	1880.00	661	0.2411
	1909.80	810	0.2451

This document is issued by the Company subject to its General Conditions of Service printed overleaf or available on request and accessible at www.sgs.com. Attention is drawn to the limitations of liability, indemnification, and Jurisdictional issued defined therein. Unless otherwise stated, the results shown in this test report refer only to the sample(s) tested. This document cannot be reproduced except in full, without prior approval of Company. Any unauthorized alteration, forgery or falsification of the content or appearance of this report is unlawful and offenders may be prosecuted to the fullest extent of the law. 此報告是遵循本公司訂定之通用服務條款所製作發放，請注意此條款列印於背面，亦可在www.sgs.com中查閱。將本公司之義務，免責，管轄權皆明確規範之。除非另有說明，此報告結果僅對檢驗之樣品負責。本報告未經本公司書面許可，不可部份複製。對本報告內容或外觀之任何未經授權之變更、偽造、竄改皆屬非法，違犯者將會被依法追訴。

EUT Mode	Frequency (MHz)	CH	99% Bandwidth (MHz)
WCDMA Band II	1852.40	9262	4.1517
	1880.00	9400	4.1491
	1907.60	9538	4.1512

EUT Mode	Frequency (MHz)	CH	99% Bandwidth (MHz)
WCDMA Band V	826.40	4132	4.1479
	836.60	4180	4.1522
	846.60	4233	4.1583

This document is issued by the Company subject to its General Conditions of Service printed overleaf or available on request and accessible at www.sgs.com. Attention is drawn to the limitations of liability, indemnification, and Jurisdictional issued defined therein. Unless otherwise stated, the results shown in this test report refer only to the sample(s) tested. This document cannot be reproduced except in full, without prior approval of Company. Any unauthorized alteration, forgery or falsification of the content or appearance of this report is unlawful and offenders may be prosecuted to the fullest extent of the law. 此報告是遵循本公司訂定之通用服務條款所製作發放，請注意此條款列印於背面，亦可在www.sgs.com中查閱。將本公司之義務，免責，管轄權皆明確規範之。除非另有說明，此報告結果僅對檢驗之樣品負責。本報告未經本公司書面許可，不可部份複製。對本報告內容或外觀之任何未經授權之變更、偽造、竄改皆屬非法，違犯者將會被依法追訴。

Figure 7-1: GSM Channel Low

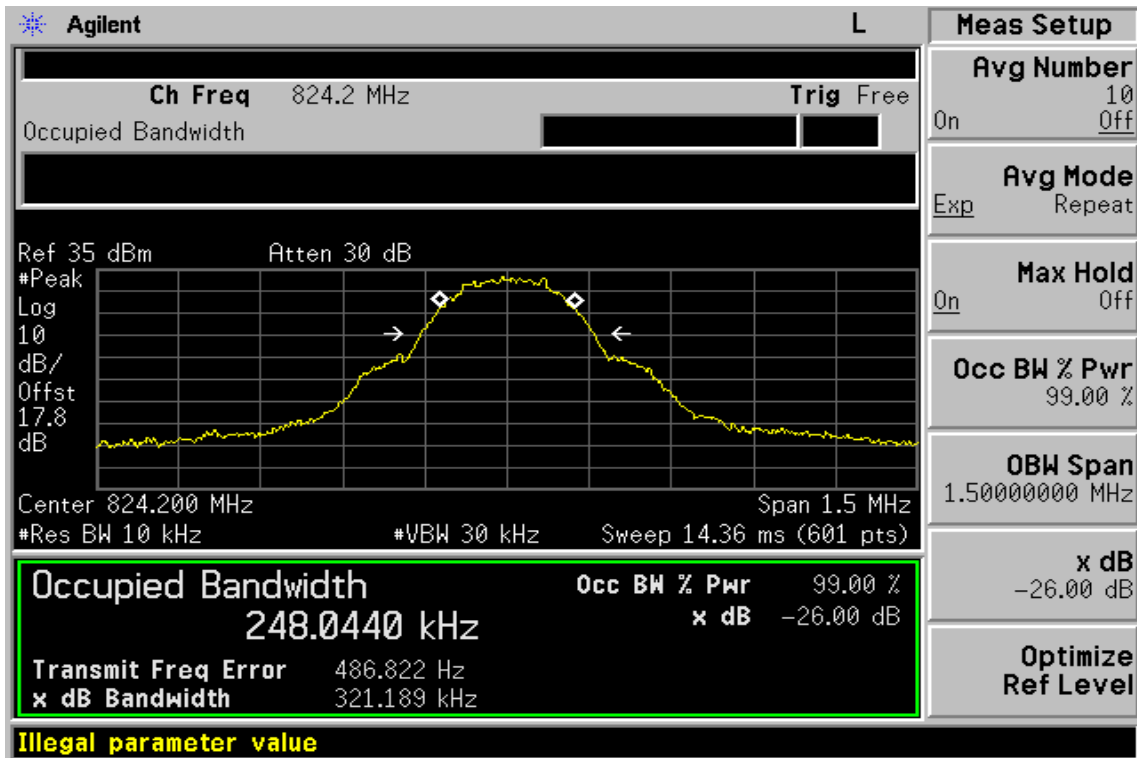
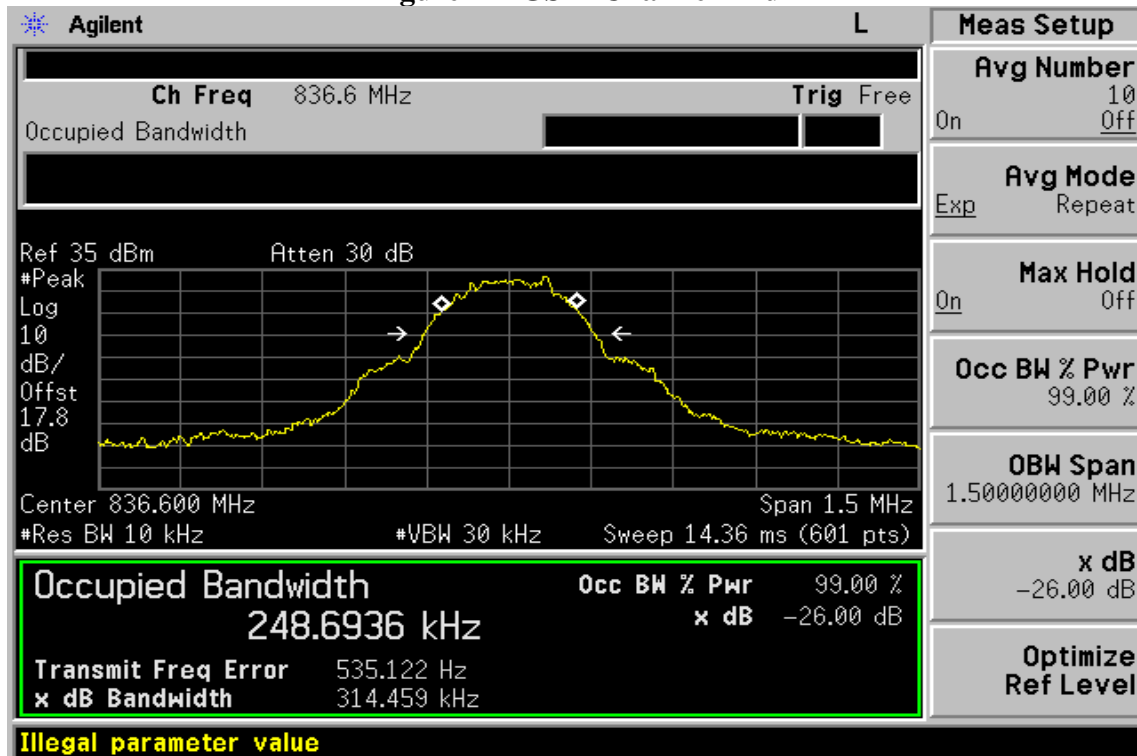

Figure 7-2 GSM Channel Mid



This document is issued by the Company subject to its General Conditions of Service printed overleaf or available on request and accessible at www.sgs.com. Attention is drawn to the limitations of liability, indemnification, and Jurisdictional issued defined therein. Unless otherwise stated, the results shown in this test report refer only to the sample(s) tested. This document cannot be reproduced except in full, without prior approval of Company. Any unauthorized alteration, forgery or falsification of the content or appearance of this report is unlawful and offenders may be prosecuted to the fullest extent of the law. 此報告是遵循本公司訂定之通用服務條款所製作發放，請注意此條款列印於背面，亦可在www.sgs.com中查閱。將本公司之義務，免責，管轄權皆明確規範之。除非另有說明，此報告結果僅對檢驗之樣品負責。本報告未經本公司書面許可，不可部份複製。對本報告內容或外觀之任何未經授權之變更、偽造、竄改皆屬非法，違犯者將會被依法追訴。

Figure 7-3: GSM Channel High

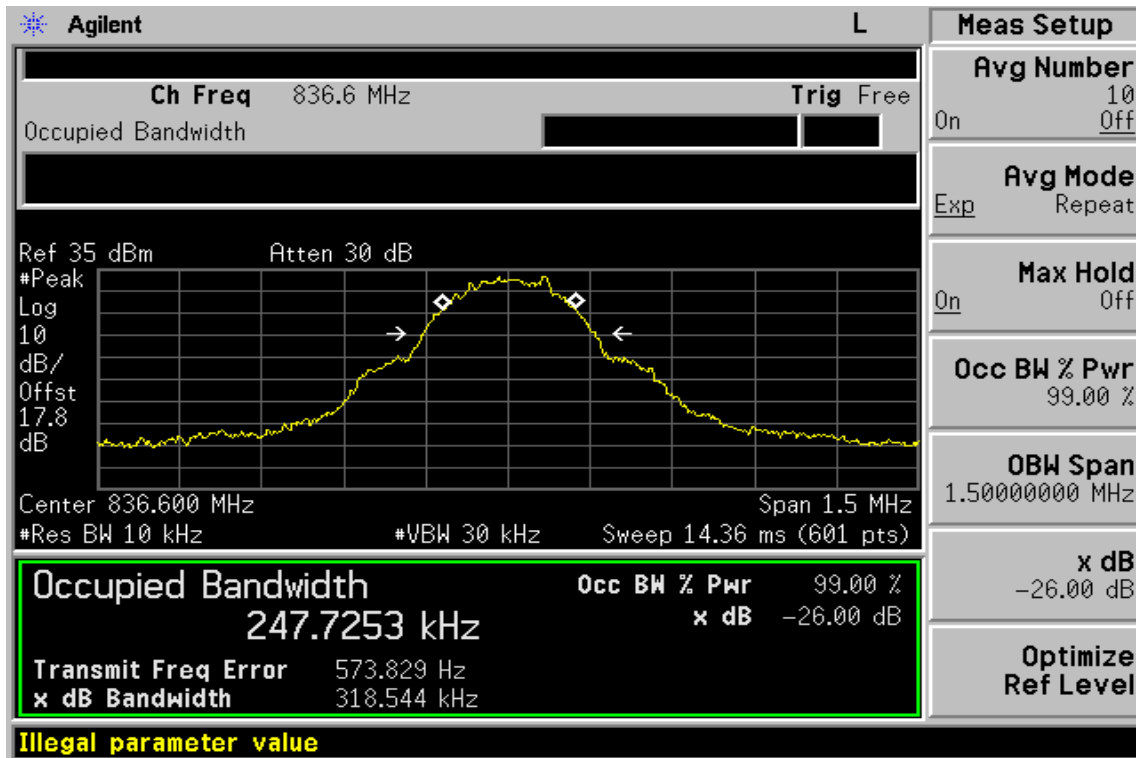
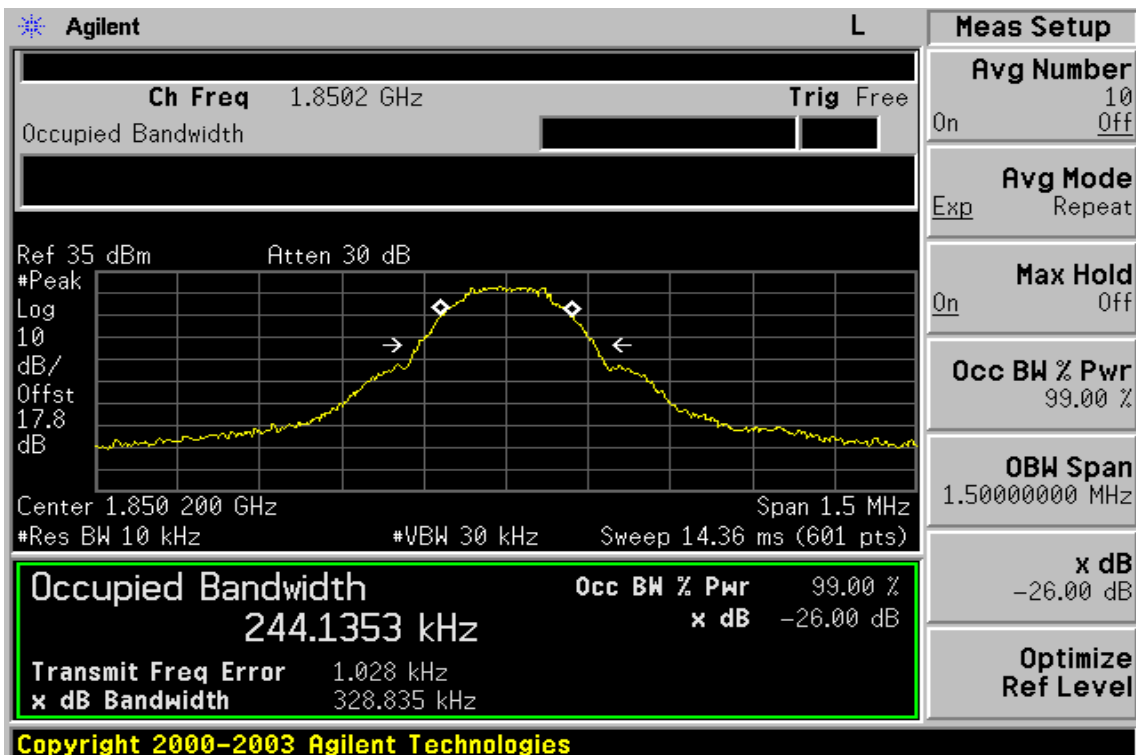

Figure 7-4: PCS Channel Low



This document is issued by the Company subject to its General Conditions of Service printed overleaf or available on request and accessible at www.sgs.com. Attention is drawn to the limitations of liability, indemnification, and Jurisdictional issued defined therein. Unless otherwise stated, the results shown in this test report refer only to the sample(s) tested. This document cannot be reproduced except in full, without prior approval of Company. Any unauthorized alteration, forgery or falsification of the content or appearance of this report is unlawful and offenders may be prosecuted to the fullest extent of the law. 此報告是遵循本公司訂定之通用服務條款所製作發放，請注意此條款列印於背面，亦可在www.sgs.com中查閱。將本公司之義務，免責，管轄權皆明確規範之。除非另有說明，此報告結果僅對檢驗之樣品負責。本報告未經本公司書面許可，不可部份複製。對本報告內容或外觀之任何未經授權之變更、偽造、竄改皆屬非法，違犯者將會被依法追訴。

Figure 7-5 PCS Channel Mid

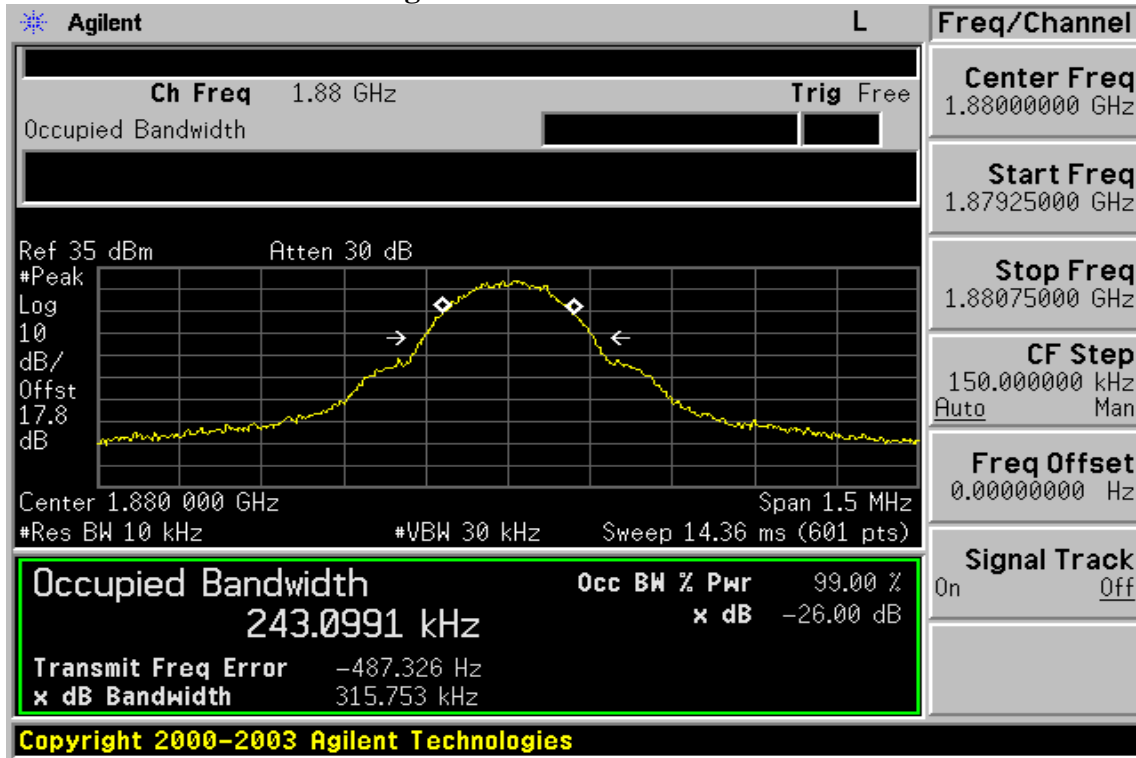
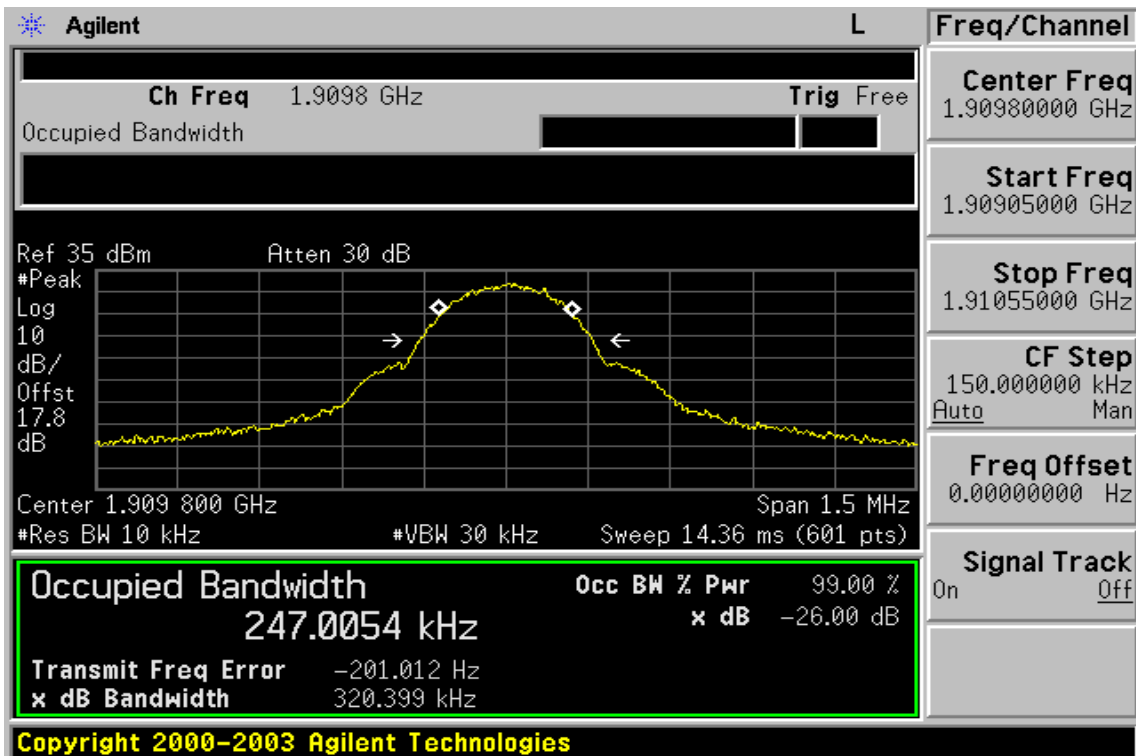

Figure 7-6: PCS Channel High



This document is issued by the Company subject to its General Conditions of Service printed overleaf or available on request and accessible at www.sgs.com. Attention is drawn to the limitations of liability, indemnification, and Jurisdictional issued defined therein. Unless otherwise stated, the results shown in this test report refer only to the sample(s) tested. This document cannot be reproduced except in full, without prior approval of Company. Any unauthorized alteration, forgery or falsification of the content or appearance of this report is unlawful and offenders may be prosecuted to the fullest extent of the law. 此報告是遵循本公司訂定之通用服務條款所製作發放，請注意此條款列印於背面，亦可在www.sgs.com中查閱。將本公司之義務，免責，管轄權皆明確規範之。除非另有說明，此報告結果僅對檢驗之樣品負責。本報告未經本公司書面許可，不可部份複製。對本報告內容或外觀之任何未經授權之變更、偽造、竄改皆屬非法，違犯者將會被依法追訴。

Figure 7-7: EDGE 850 Channel Low

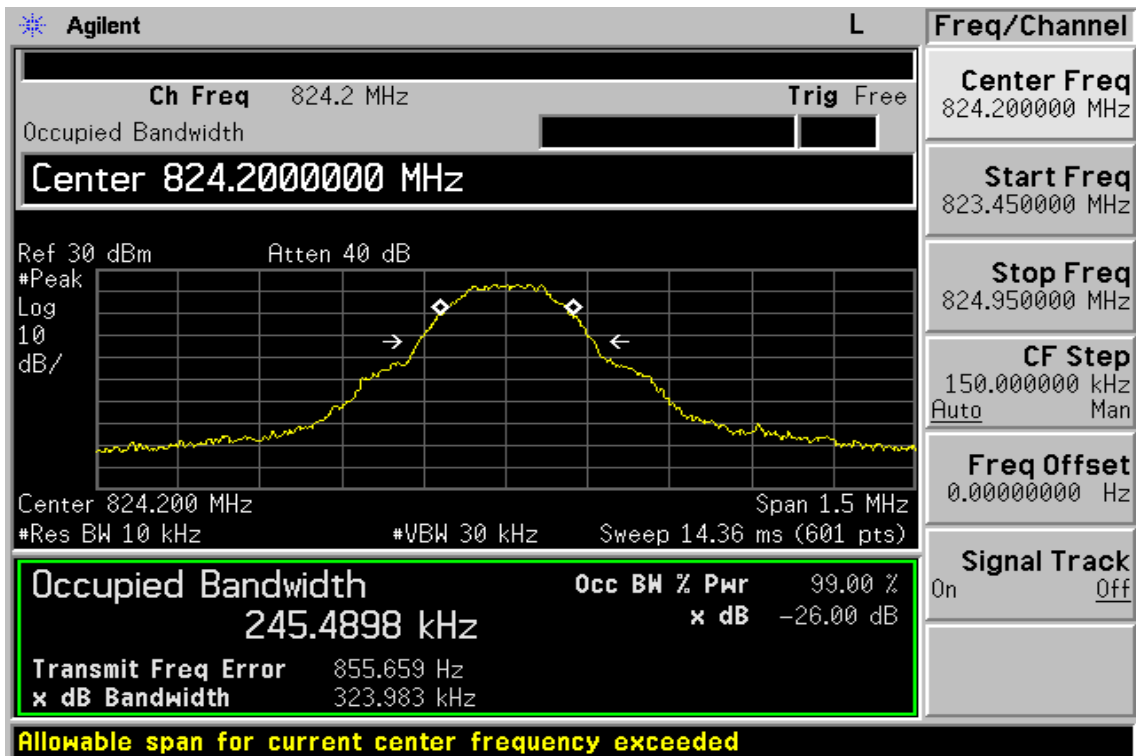
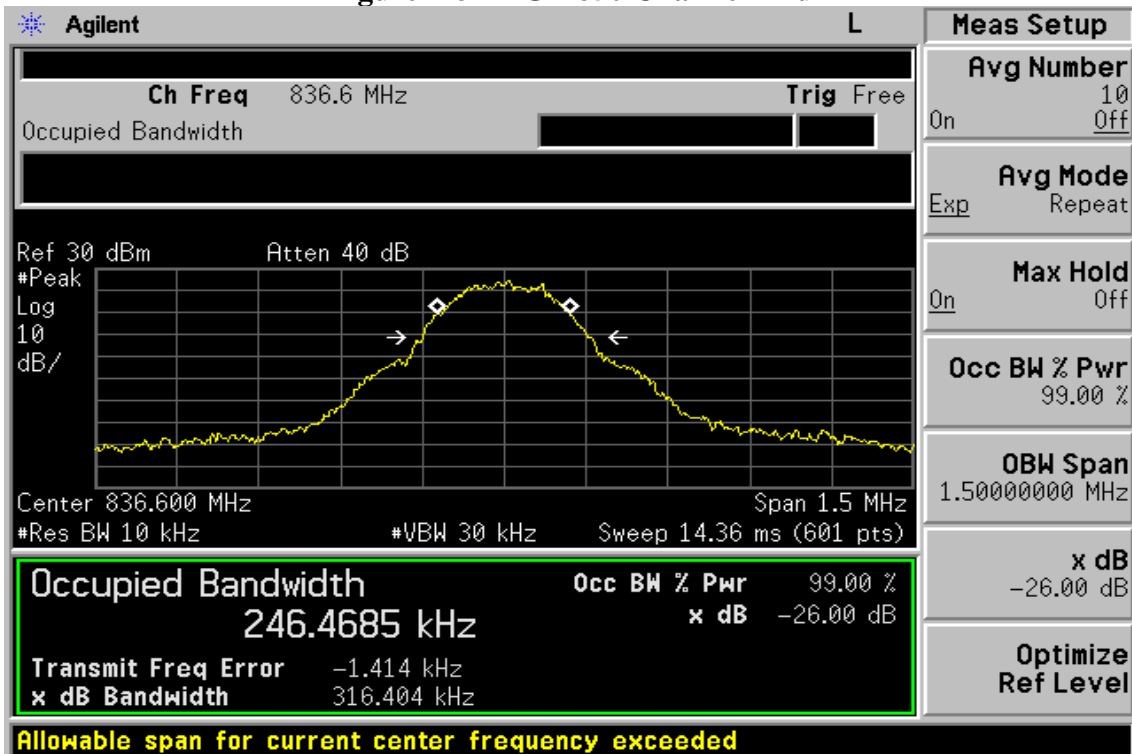

Figure 7-8 EDGE 850 Channel Mid



This document is issued by the Company subject to its General Conditions of Service printed overleaf or available on request and accessible at www.sgs.com. Attention is drawn to the limitations of liability, indemnification, and Jurisdictional issued defined therein. Unless otherwise stated, the results shown in this test report refer only to the sample(s) tested. This document cannot be reproduced except in full, without prior approval of Company. Any unauthorized alteration, forgery or falsification of the content or appearance of this report is unlawful and offenders may be prosecuted to the fullest extent of the law. 此報告是遵循本公司訂定之通用服務條款所製作發放，請注意此條款列印於背面，亦可在www.sgs.com中查閱。將本公司之義務，免責，管轄權皆明確規範之。除非另有說明，此報告結果僅對檢驗之樣品負責。本報告未經本公司書面許可，不可部份複製。對本報告內容或外觀之任何未經授權之變更、偽造、竄改皆屬非法，違犯者將會被依法追訴。

Figure 7-9: EDGE 850 Channel High

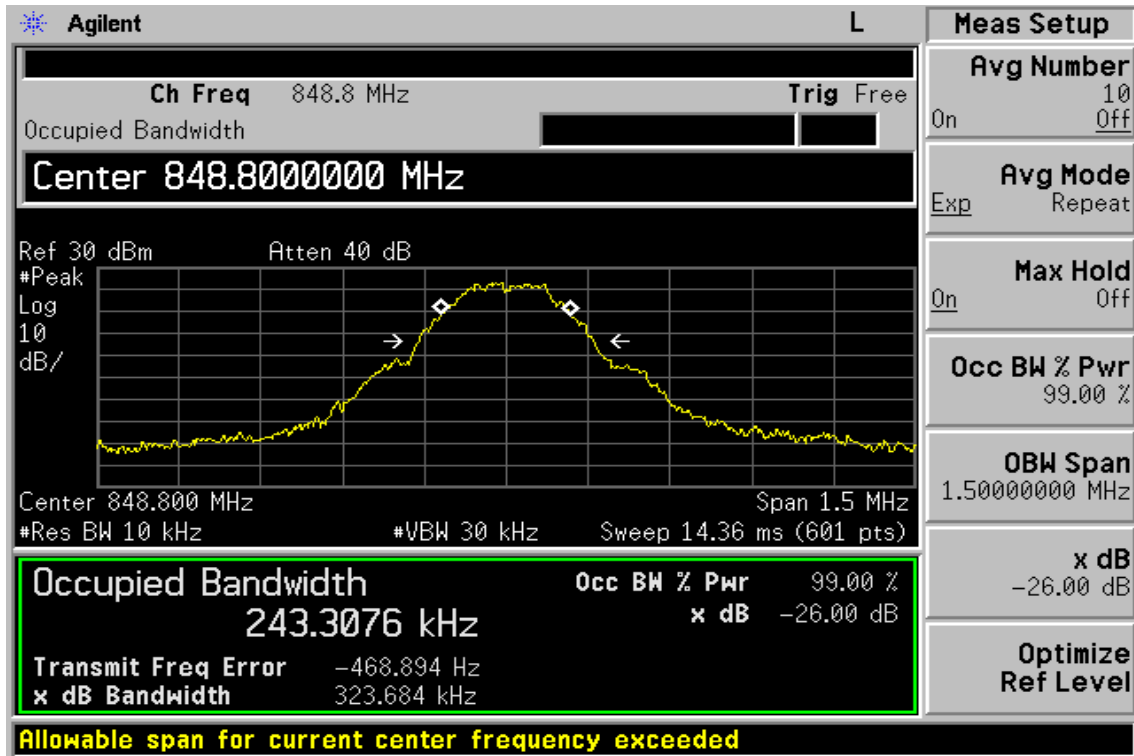
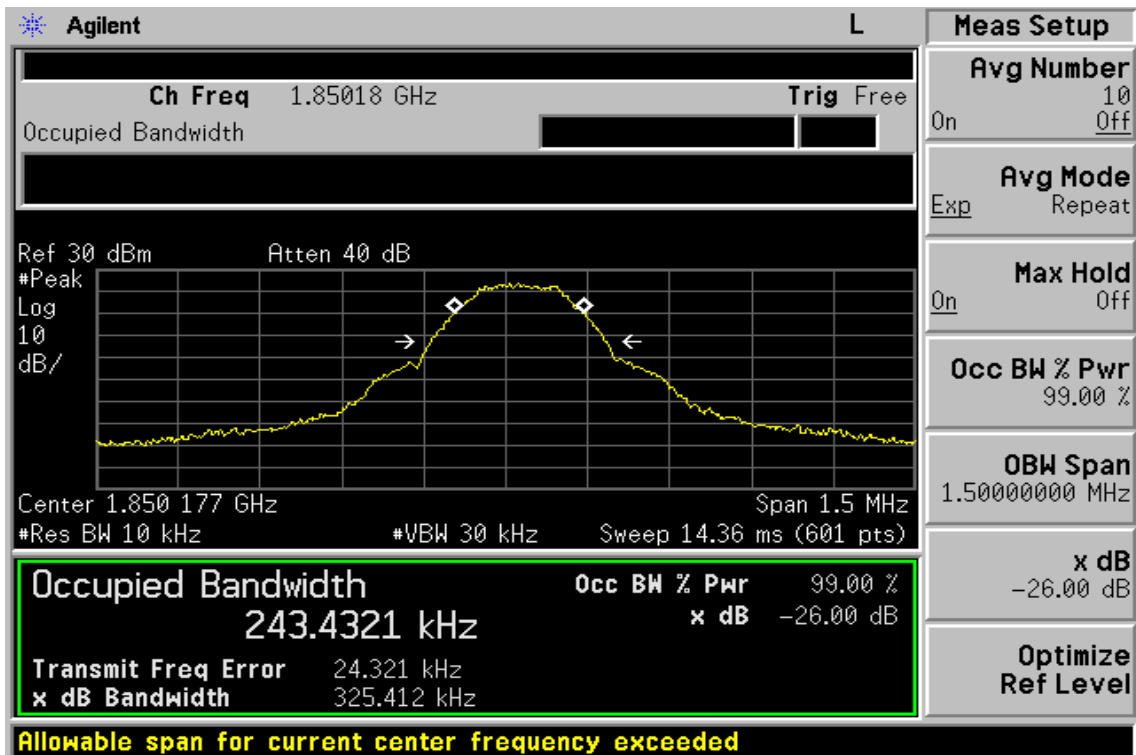

Figure 7-10: EDGE 1900 Channel Low



This document is issued by the Company subject to its General Conditions of Service printed overleaf or available on request and accessible at www.sgs.com. Attention is drawn to the limitations of liability, indemnification, and Jurisdictional issued defined therein. Unless otherwise stated, the results shown in this test report refer only to the sample(s) tested. This document cannot be reproduced except in full, without prior approval of Company. Any unauthorized alteration, forgery or falsification of the content or appearance of this report is unlawful and offenders may be prosecuted to the fullest extent of the law. 此報告是遵循本公司訂定之通用服務條款所製作發放，請注意此條款列印於背面，亦可在www.sgs.com中查閱。將本公司之義務，免責，管轄權皆明確規範之。除非另有說明，此報告結果僅對檢驗之樣品負責。本報告未經本公司書面許可，不可部份複製。對本報告內容或外觀之任何未經授權之變更、偽造、竄改皆屬非法，違犯者將會被依法追訴。

Figure 7-11 EDGE 1900 Channel Mid

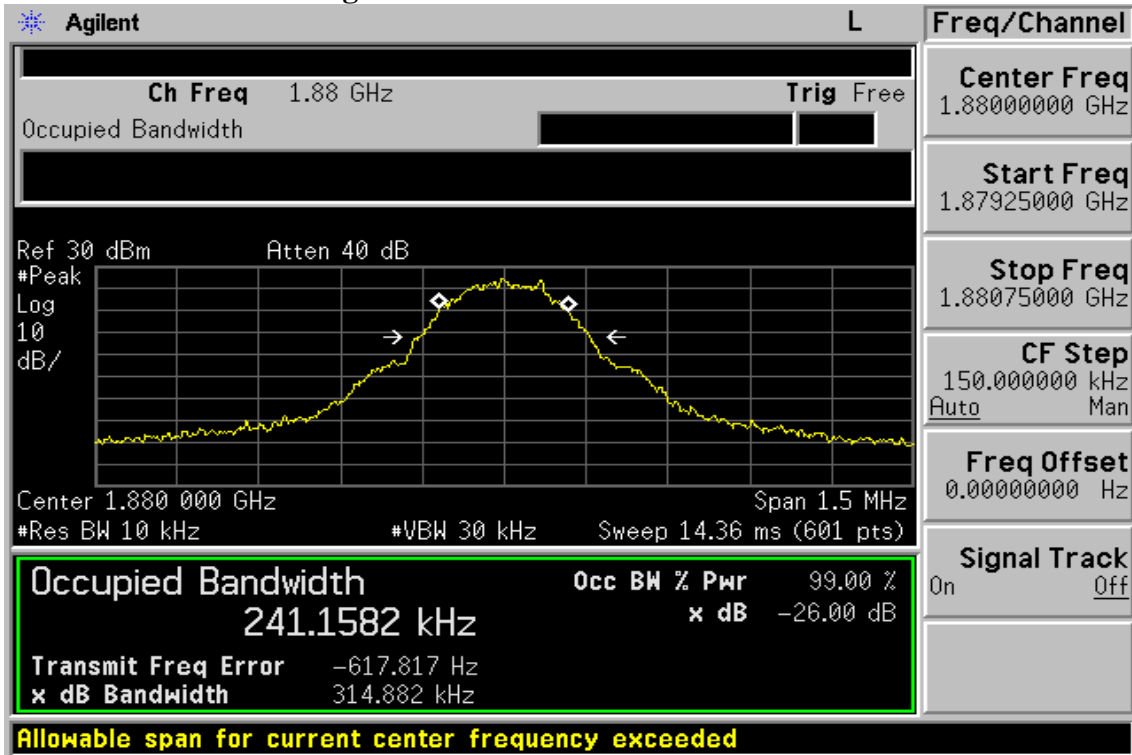
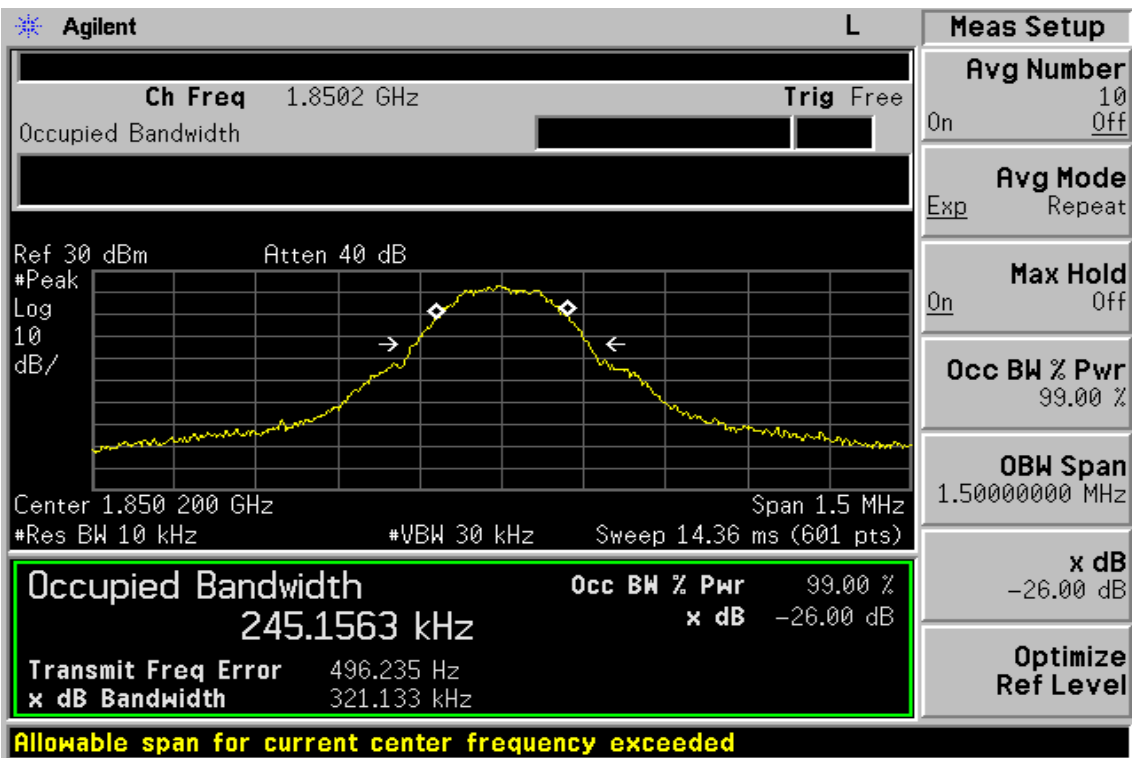

Figure 7-12: EDGE 1900 Channel High



This document is issued by the Company subject to its General Conditions of Service printed overleaf or available on request and accessible at www.sgs.com. Attention is drawn to the limitations of liability, indemnification, and Jurisdictional issued defined therein. Unless otherwise stated, the results shown in this test report refer only to the sample(s) tested. This document cannot be reproduced except in full, without prior approval of Company. Any unauthorized alteration, forgery or falsification of the content or appearance of this report is unlawful and offenders may be prosecuted to the fullest extent of the law. 此報告是遵循本公司訂定之通用服務條款所製作發放，請注意此條款列印於背面，亦可在www.sgs.com中查閱。將本公司之義務，免責，管轄權皆明確規範之。除非另有說明，此報告結果僅對檢驗之樣品負責。本報告未經本公司書面許可，不可部份複製。對本報告內容或外觀之任何未經授權之變更、偽造、竄改皆屬非法，違犯者將會被依法追訴。

Figure 7-13: WCDMA BAND II Channel Low

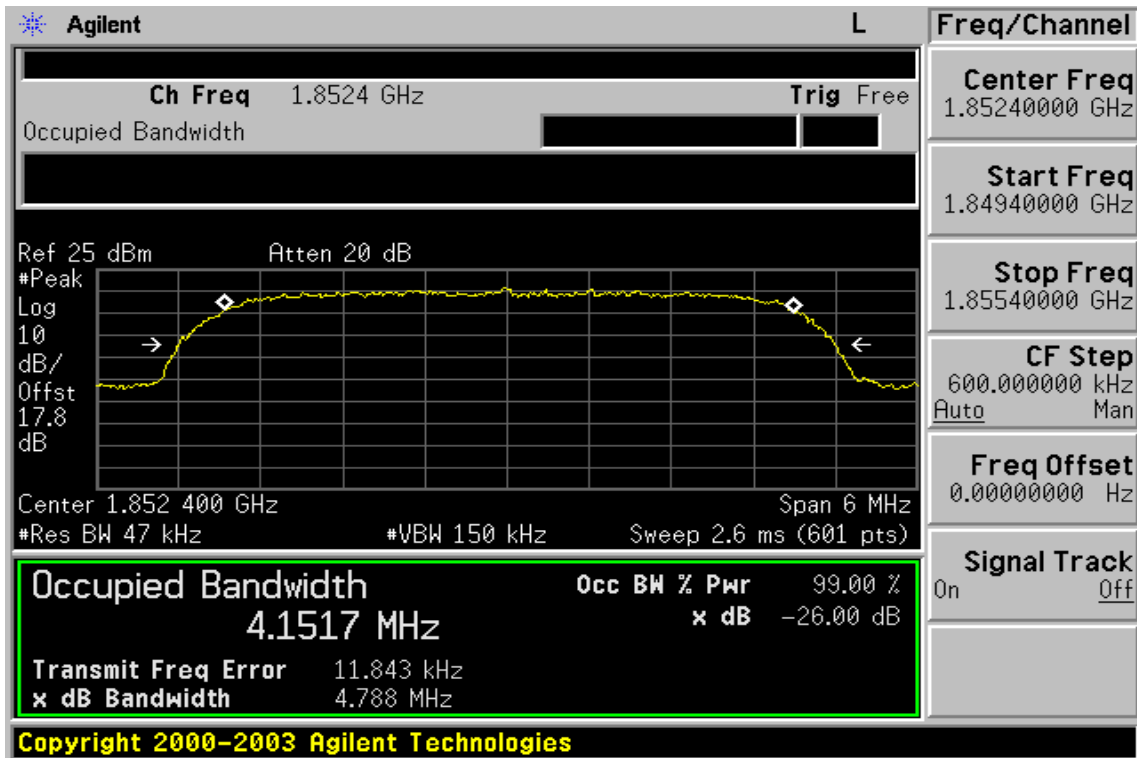
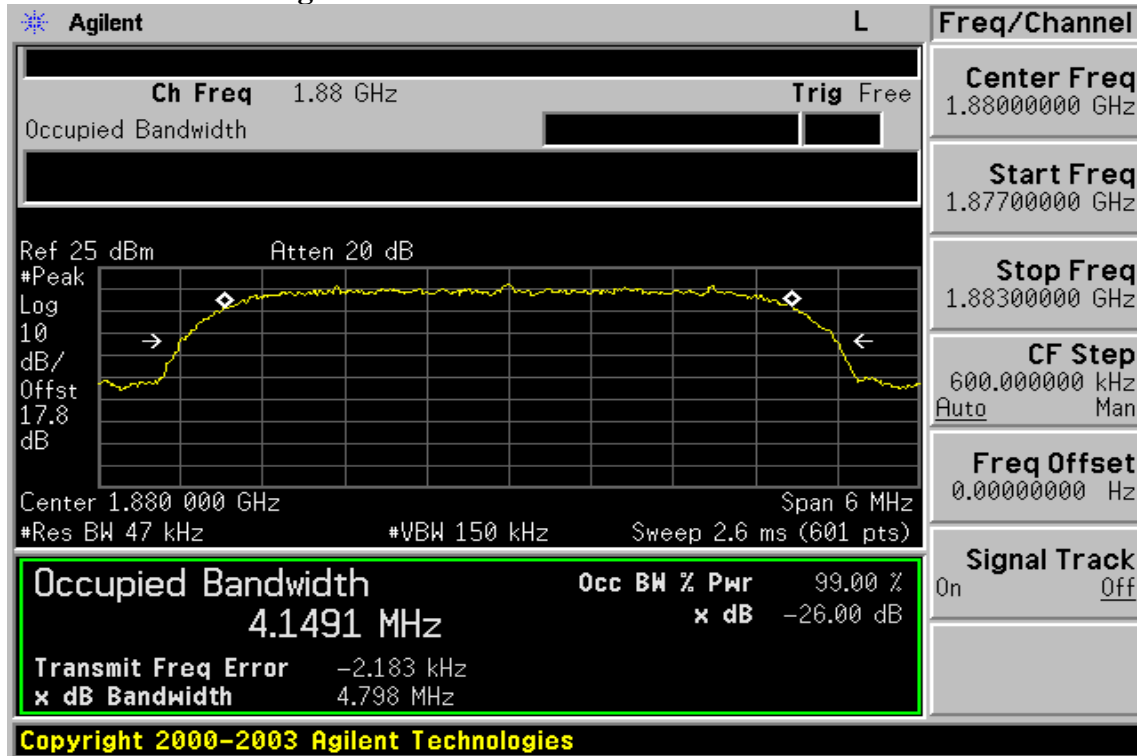

Figure 7-14 WCDMA BAND II Channel Mid



This document is issued by the Company subject to its General Conditions of Service printed overleaf or available on request and accessible at www.sgs.com. Attention is drawn to the limitations of liability, indemnification, and Jurisdictional issued defined therein. Unless otherwise stated, the results shown in this test report refer only to the sample(s) tested. This document cannot be reproduced except in full, without prior approval of Company. Any unauthorized alteration, forgery or falsification of the content or appearance of this report is unlawful and offenders may be prosecuted to the fullest extent of the law. 此報告是遵循本公司訂定之通用服務條款所製作發放，請注意此條款列印於背面，亦可在www.sgs.com中查閱。將本公司之義務，免責，管轄權皆明確規範之。除非另有說明，此報告結果僅對檢驗之樣品負責。本報告未經本公司書面許可，不可部份複製。對本報告內容或外觀之任何未經授權之變更、偽造、竄改皆屬非法，違犯者將會被依法追訴。

Figure 7-15: WCDMA BAND II Channel High

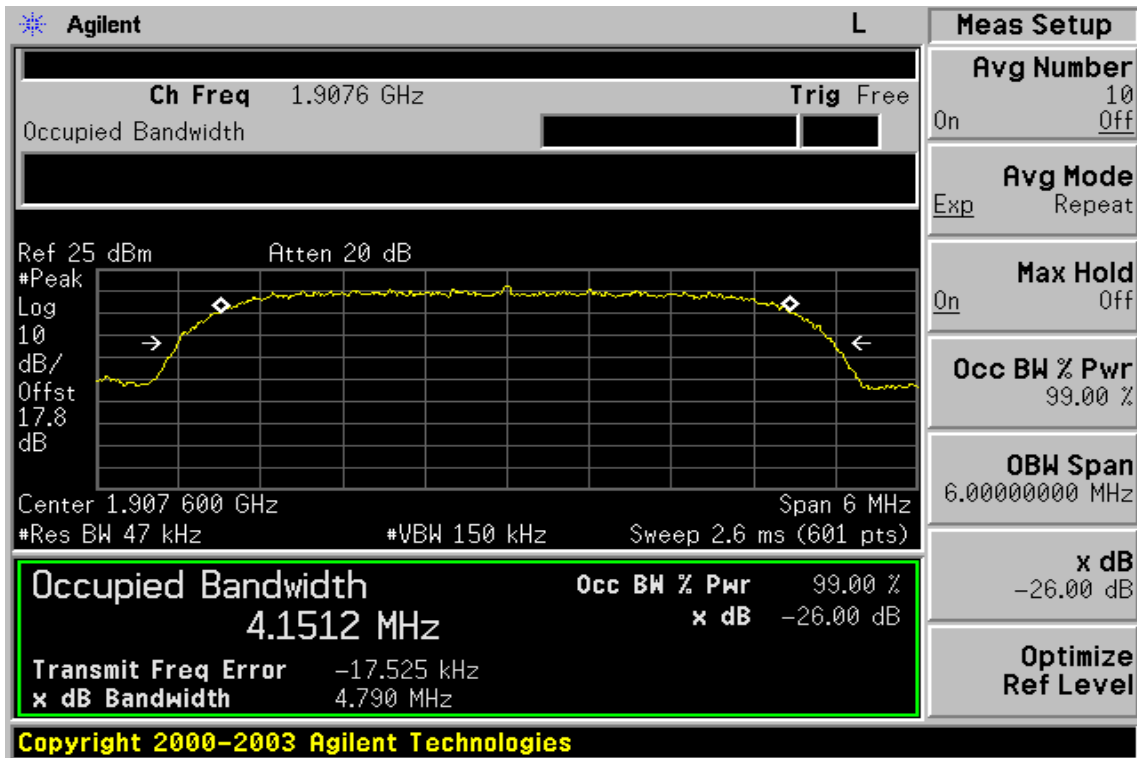
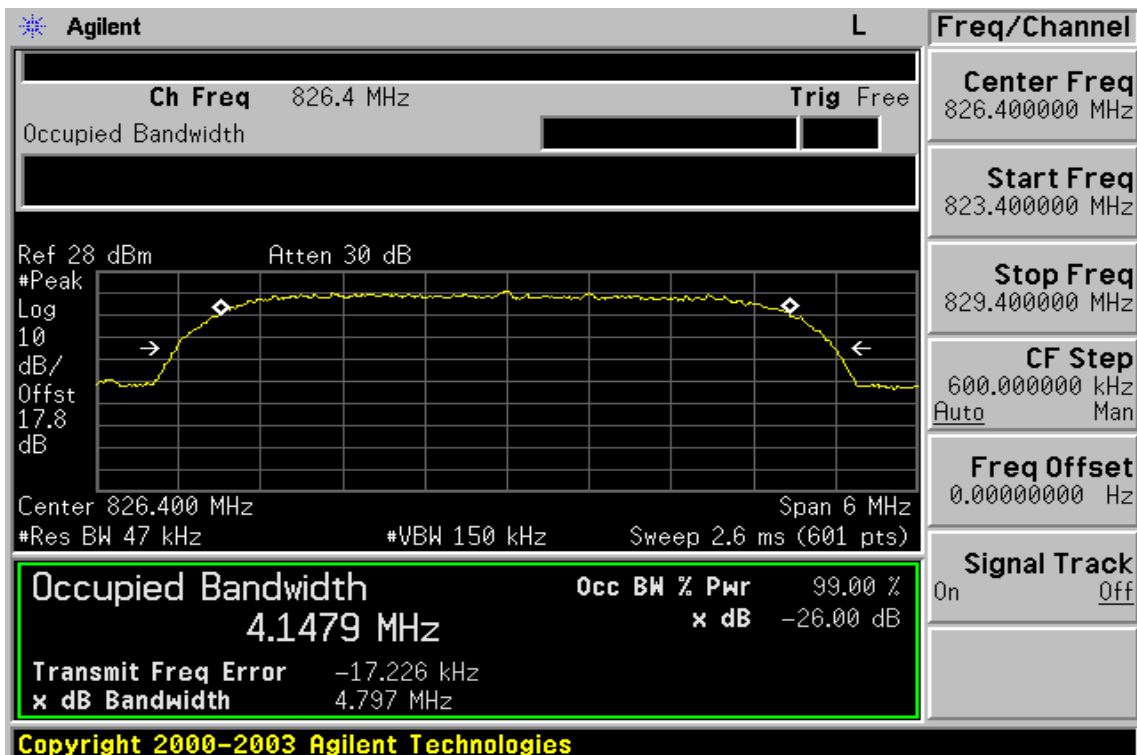

Figure 7-16: WCDMA BAND V Channel Low



This document is issued by the Company subject to its General Conditions of Service printed overleaf or available on request and accessible at www.sgs.com. Attention is drawn to the limitations of liability, indemnification, and Jurisdictional issued defined therein. Unless otherwise stated, the results shown in this test report refer only to the sample(s) tested. This document cannot be reproduced except in full, without prior approval of Company. Any unauthorized alteration, forgery or falsification of the content or appearance of this report is unlawful and offenders may be prosecuted to the fullest extent of the law. 此報告是遵循本公司訂定之通用服務條款所製作發放，請注意此條款列印於背面，亦可在www.sgs.com中查閱。將本公司之義務，免責，管轄權皆明確規範之。除非另有說明，此報告結果僅對檢驗之樣品負責。本報告未經本公司書面許可，不可部份複製。對本報告內容或外觀之任何未經授權之變更、偽造、竄改皆屬非法，違犯者將會被依法追訴。

Figure 7-17 WCDMA BAND V Channel Mid

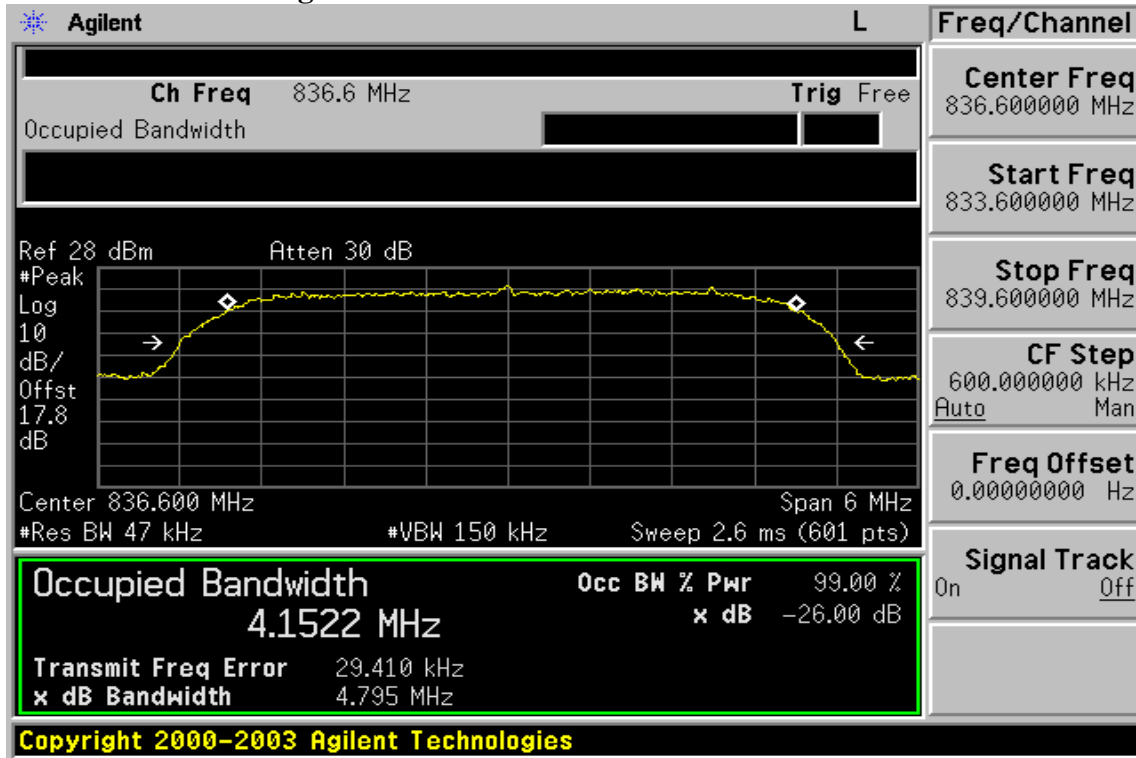
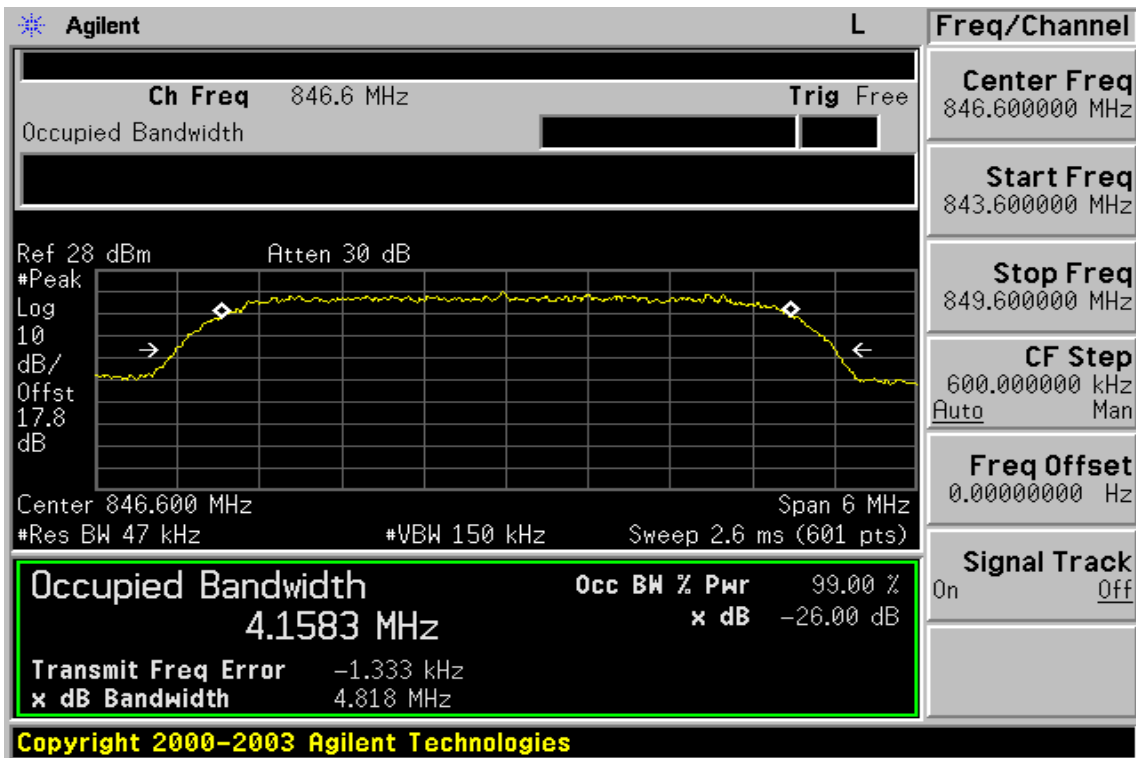

Figure 7-18: WCDMA BAND V Channel High



This document is issued by the Company subject to its General Conditions of Service printed overleaf or available on request and accessible at www.sgs.com. Attention is drawn to the limitations of liability, indemnification, and Jurisdictional issued defined therein. Unless otherwise stated, the results shown in this test report refer only to the sample(s) tested. This document cannot be reproduced except in full, without prior approval of Company. Any unauthorized alteration, forgery or falsification of the content or appearance of this report is unlawful and offenders may be prosecuted to the fullest extent of the law. 此報告是遵循本公司訂定之通用服務條款所製作發放，請注意此條款列印於背面，亦可在www.sgs.com中查閱。將本公司之義務，免責，管轄權皆明確規範之。除非另有說明，此報告結果僅對檢驗之樣品負責。本報告未經本公司書面許可，不可部份複製。對本報告內容或外觀之任何未經授權之變更、偽造、竄改皆屬非法，違犯者將會被依法追訴。

8. OUT OF BAND EMISSION AT ANTENNA TERMINALS

8.1 Standard Applicable

According to FCC §2.1051.

FCC §22.917(a), §24.238(a), the magnitude of each spurious and harmonic emission that can be detected when the equipment is operated under the conditions specified in the instruction manual and/ or alignment procedure, shall not be less than $43 + 10 \log$ (mean output power in watts) dBc below the mean power output outside a license's frequency block (-13dBm)

8.2 Test SET-UP

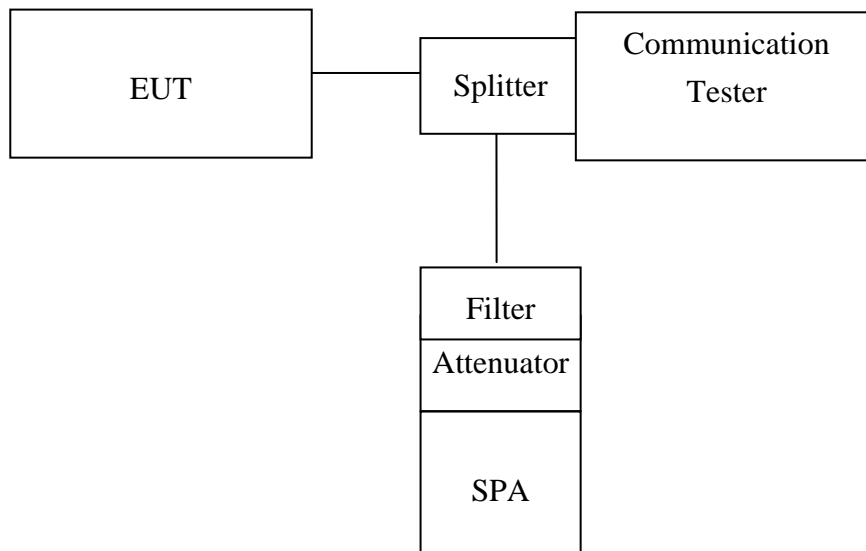

Note: Measurement setup for testing on Antenna connector

8.3 Measurement Procedure

The RF output of the transceiver was connected to a spectrum analyzer through appropriate attenuation. The resolution bandwidth of the spectrum analyzer was set at 1MHz, sufficient scans were taken to show the out of band Emissions if any up to 10th harmonic.

For the out of band: Set the RBW, VBW = 1MHz, Start=30MHz, Stop= 10th harmonic.
Limit = -13dBm

Band Edge Requirements: In the 1 MHz bands immediately outside and adjacent to the frequency block, a resolution bandwidth of at least 1 percent of the emission bandwidth of the fundamental emission of the transmitter may be employed to measure the out of band Emissions. Limit, -13dBm.

8.4 Measurement Equipment Used:

Conducted Emission Test Site					
EQUIPMENT TYPE	MFR	MODEL NUMBER	SERIAL NUMBER	LAST CAL.	CAL DUE.
Spectrum Analyzer	Agilent	E4446A	MY43360126	04/27/2007	04/26/2008
Spectrum Analyzer	Agilent	E7405A	US41160416	07/04/2007	07/03/2008
Power Sensor	Anritsu	MA2490A	31431	07/07/2007	07/06/2008
Power Meter	Anritsu	ML2487A	6K00002070	07/07/2007	07/06/2008
Communication Test	R&S	SMU200	N/A	N/A	N/A
Temperature Chamber	TERCHY	MHG-120LF	911009	04/26/2007	04/25/2008
Low Loss Cable	HUBER+SUHNER	SUCOFLEX 104PEA	N/A	N/A	N/A
Attenuator	Mini-Circuit	BW-S10W5	N/A	07/05/2007	07/04/2008
Attenuator	Mini-Circuit	BW-S6W5	N/A	07/05/2007	07/04/2008
Splitter	Agilent	11636B	51728	09/23/2007	09/22/2008
Signal Generator	R&S	SMR40	100210	11/09/2006	11/10/2007
DC Power Supply	Agilent	6038A	2929A-07548	01/06/2007	01/05/2008

This document is issued by the Company subject to its General Conditions of Service printed overleaf or available on request and accessible at www.sgs.com. Attention is drawn to the limitations of liability, indemnification, and Jurisdictional issued defined therein. Unless otherwise stated, the results shown in this test report refer only to the sample(s) tested. This document cannot be reproduced except in full, without prior approval of Company. Any unauthorized alteration, forgery or falsification of the content or appearance of this report is unlawful and offenders may be prosecuted to the fullest extent of the law. 此報告是遵循本公司訂定之通用服務條款所製作發放，請注意此條款列印於背面，亦可在www.sgs.com中查閱。將本公司之義務，免責，管轄權皆明確規範之。除非另有說明，此報告結果僅對檢驗之樣品負責。本報告未經本公司書面許可，不可部份複製。對本報告內容或外觀之任何未經授權之變更、偽造、竄改皆屬非法，違犯者將會被依法追訴。

8.5 Measurement Result

Figure 8-1: Out of Band emission at antenna terminals– GSM Channel Lowest

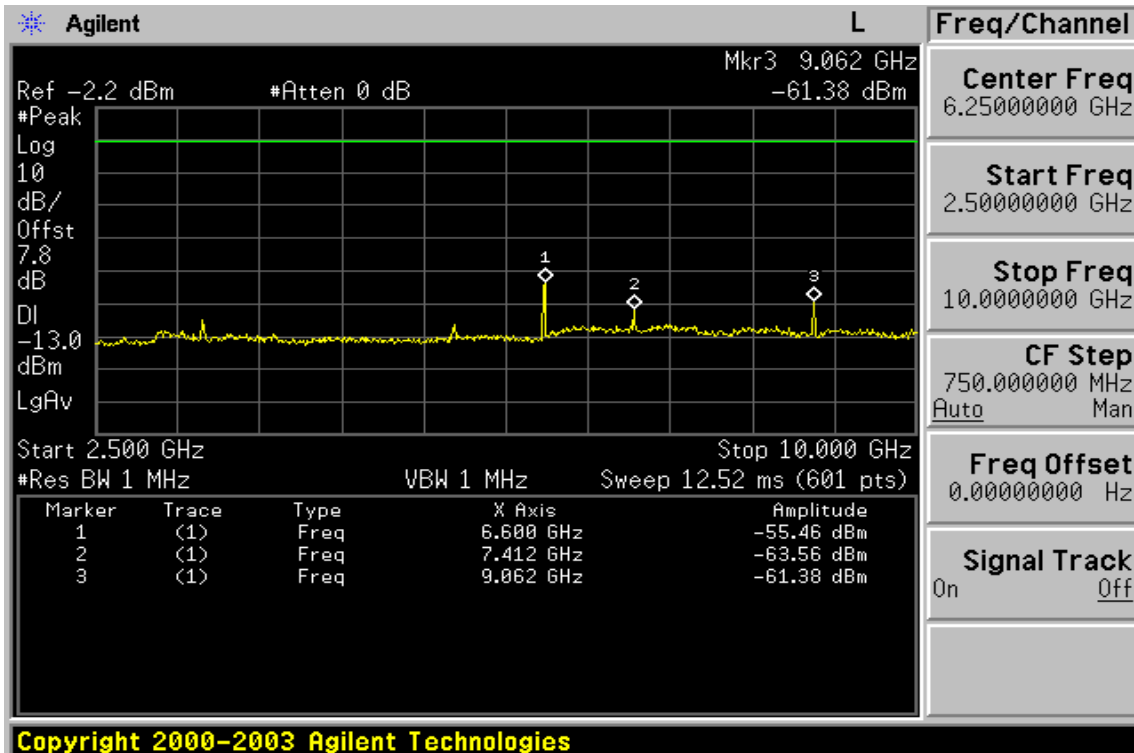
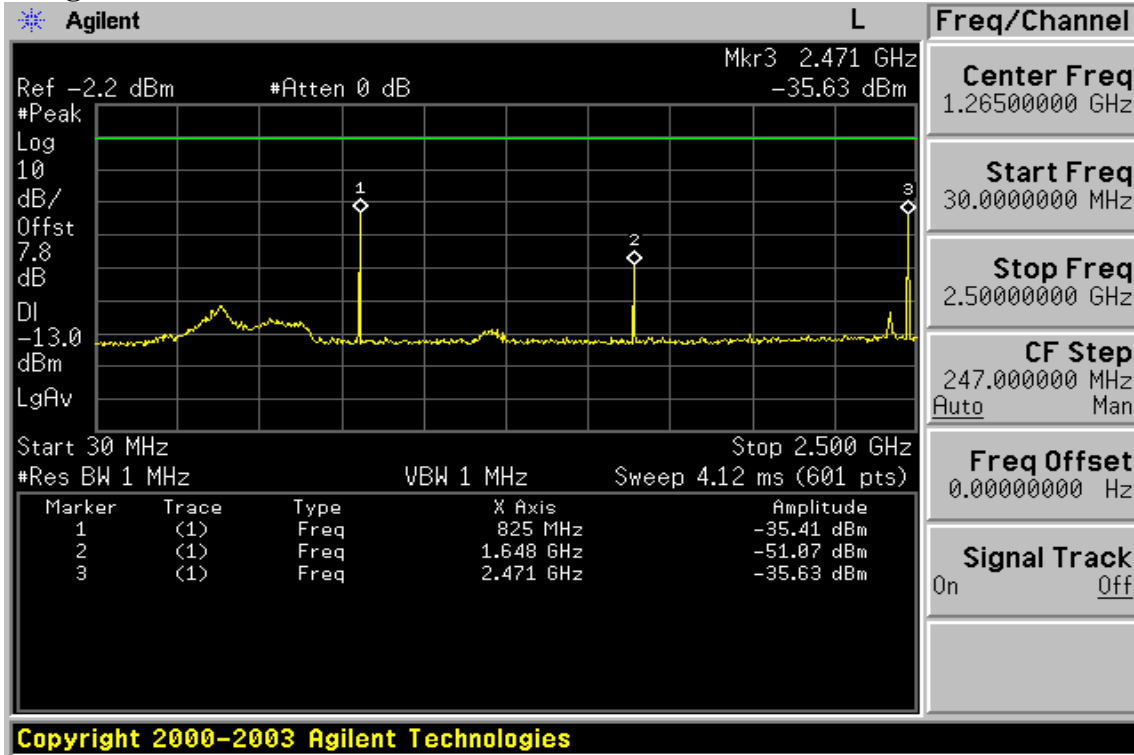

This document is issued by the Company subject to its General Conditions of Service printed overleaf or available on request and accessible at www.sgs.com. Attention is drawn to the limitations of liability, indemnification, and Jurisdictional issued defined therein. Unless otherwise stated, the results shown in this test report refer only to the sample(s) tested. This document cannot be reproduced except in full, without prior approval of Company. Any unauthorized alteration, forgery or falsification of the content or appearance of this report is unlawful and offenders may be prosecuted to the fullest extent of the law. 此報告是遵循本公司訂定之通用服務條款所製作發放，請注意此條款列印於背面，亦可在www.sgs.com中查閱。將本公司之義務，免責，管轄權皆明確規範之。除非另有說明，此報告結果僅對檢驗之樣品負責。本報告未經本公司書面許可，不可部份複製。對本報告內容或外觀之任何未經授權之變更、偽造、竄改皆屬非法，違犯者將會被依法追訴。

Figure 8-2: Out of Band emission at antenna terminals –GSM Channel Mid

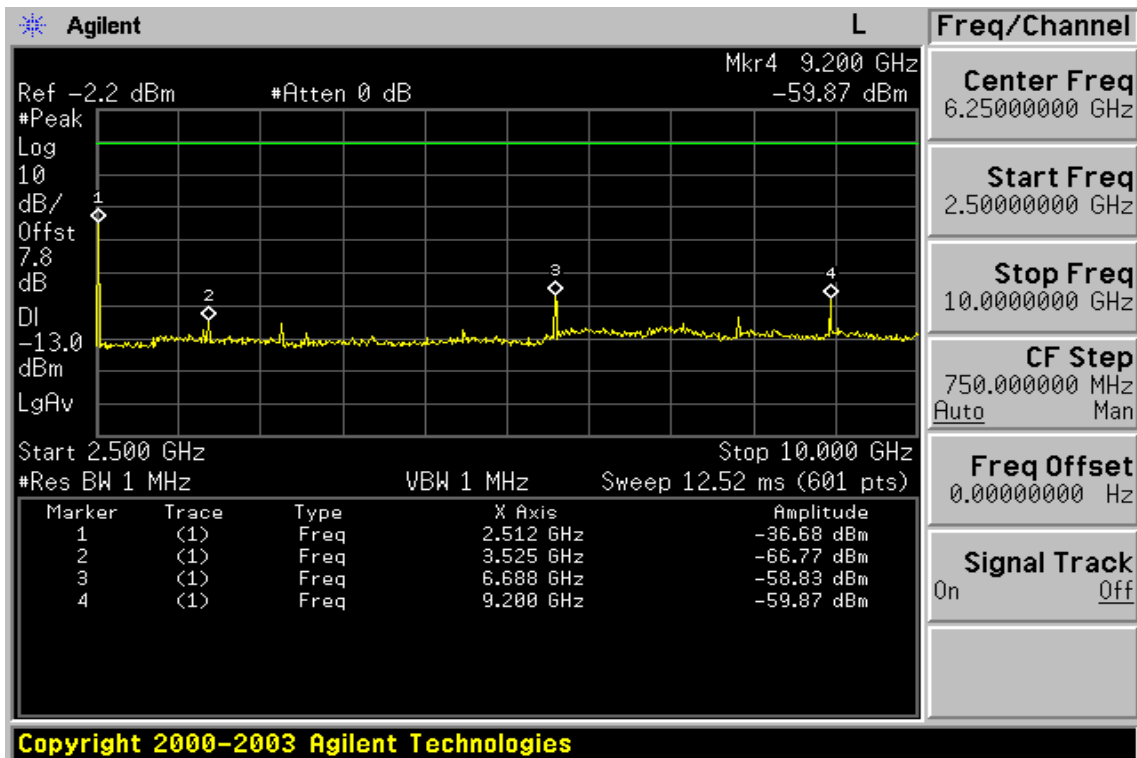
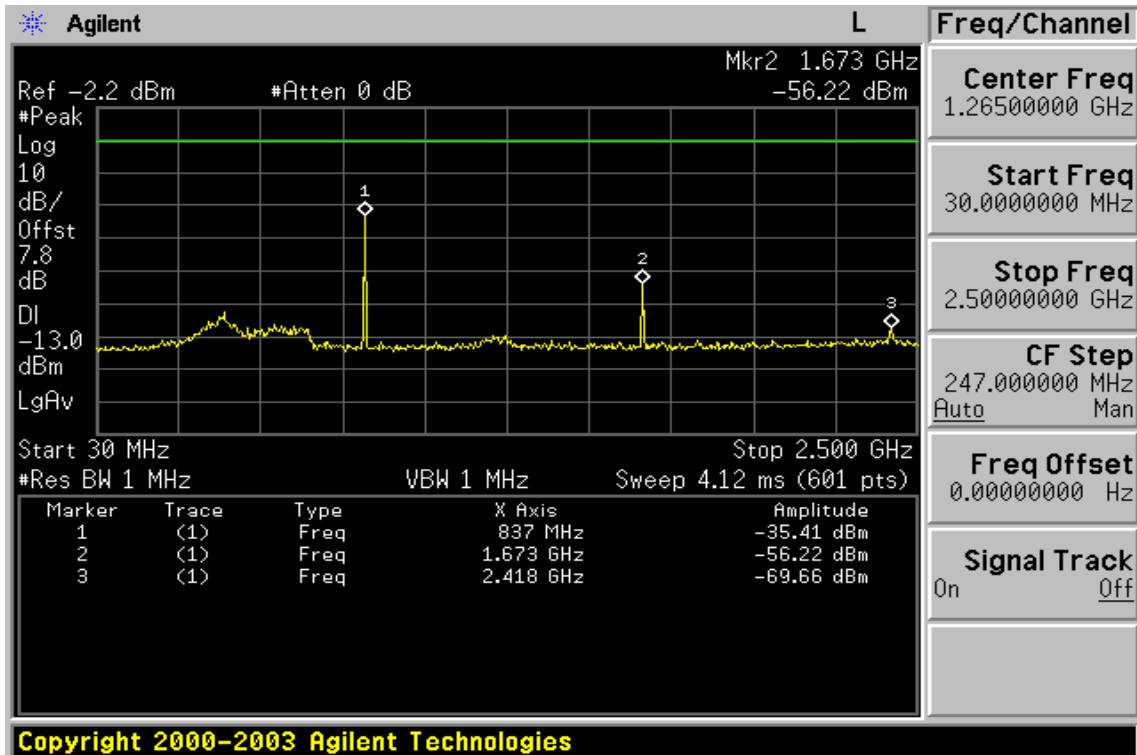

This document is issued by the Company subject to its General Conditions of Service printed overleaf or available on request and accessible at www.sgs.com. Attention is drawn to the limitations of liability, indemnification, and Jurisdictional issued defined therein. Unless otherwise stated, the results shown in this test report refer only to the sample(s) tested. This document cannot be reproduced except in full, without prior approval of Company. Any unauthorized alteration, forgery or falsification of the content or appearance of this report is unlawful and offenders may be prosecuted to the fullest extent of the law. 此報告是遵循本公司訂定之通用服務條款所製作發放，請注意此條款列印於背面，亦可在www.sgs.com中查閱。將本公司之義務，免責，管轄權皆明確規範之。除非另有說明，此報告結果僅對檢驗之樣品負責。本報告未經本公司書面許可，不可部份複製。對本報告內容或外觀之任何未經授權之變更、偽造、竄改皆屬非法，違犯者將會被依法追訴。

Figure 8-3: Out of Band emission at antenna terminals–GSM Channel Highest

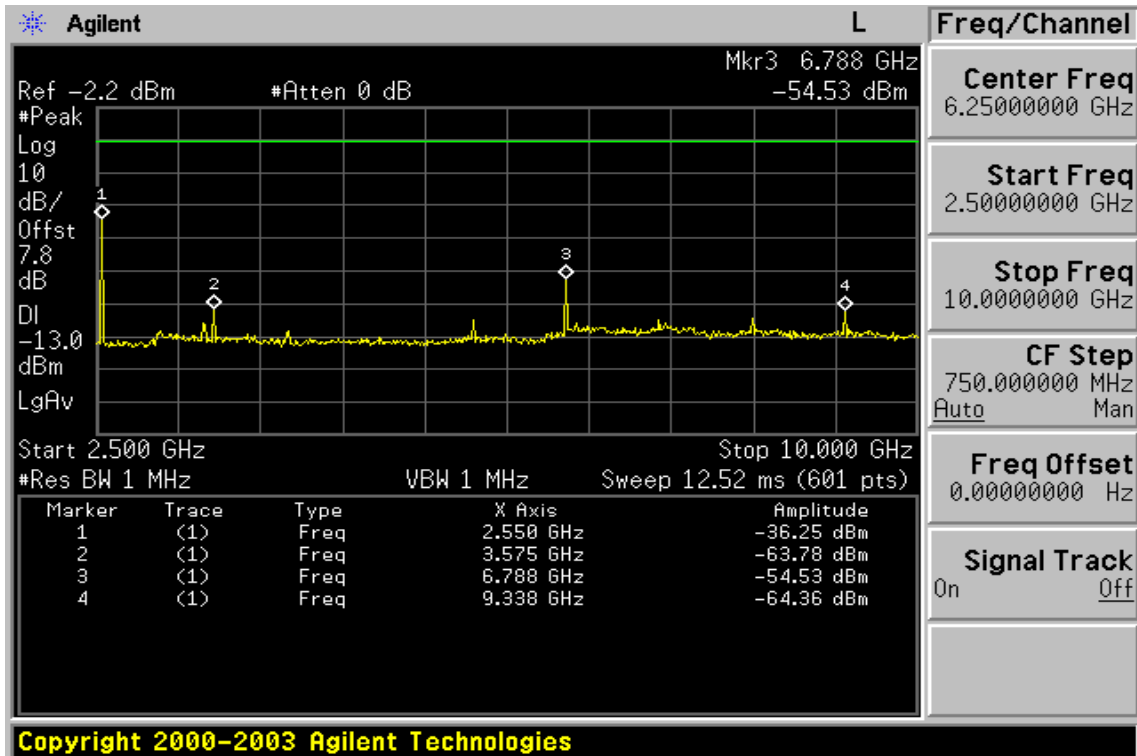
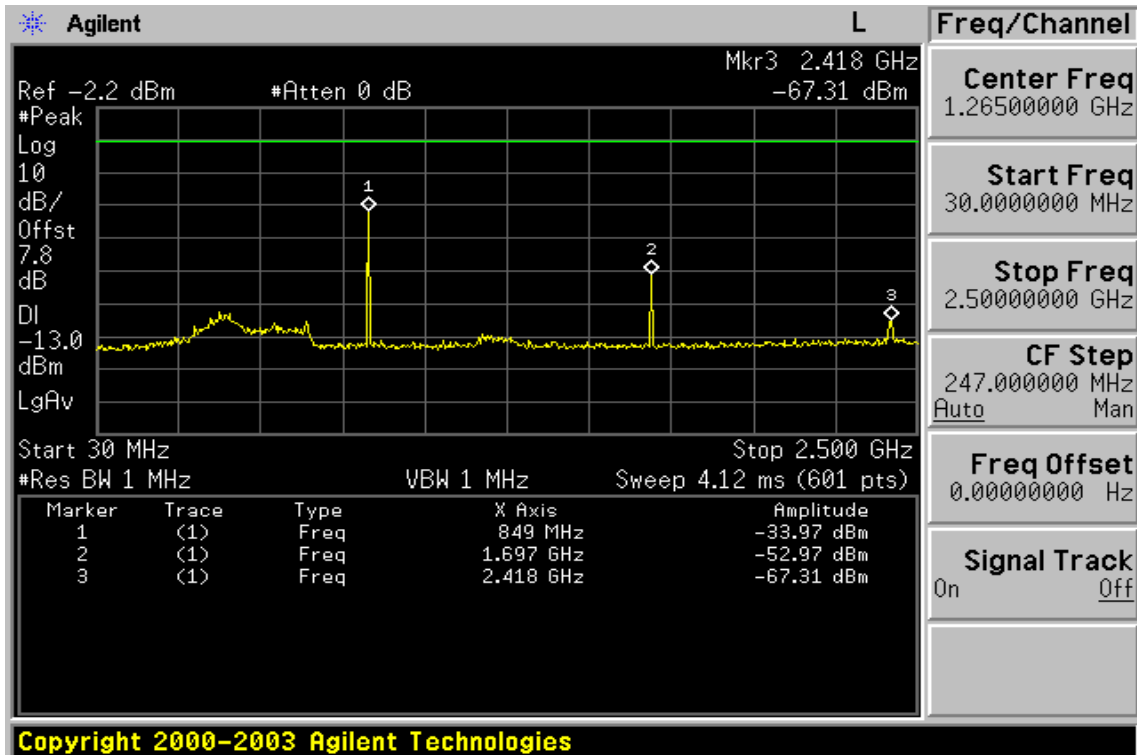

This document is issued by the Company subject to its General Conditions of Service printed overleaf or available on request and accessible at www.sgs.com. Attention is drawn to the limitations of liability, indemnification, and Jurisdictional issued defined therein. Unless otherwise stated, the results shown in this test report refer only to the sample(s) tested. This document cannot be reproduced except in full, without prior approval of Company. Any unauthorized alteration, forgery or falsification of the content or appearance of this report is unlawful and offenders may be prosecuted to the fullest extent of the law. 此報告是遵循本公司訂定之通用服務條款所製作發放，請注意此條款列印於背面，亦可在www.sgs.com中查閱。將本公司之義務，免責，管轄權皆明確規範之。除非另有說明，此報告結果僅對檢驗之樣品負責。本報告未經本公司書面許可，不可部份複製。對本報告內容或外觀之任何未經授權之變更、偽造、竄改皆屬非法，違犯者將會被依法追訴。

Figure 8-4: Band edge emission at antenna terminals – GSM Channel Lowest

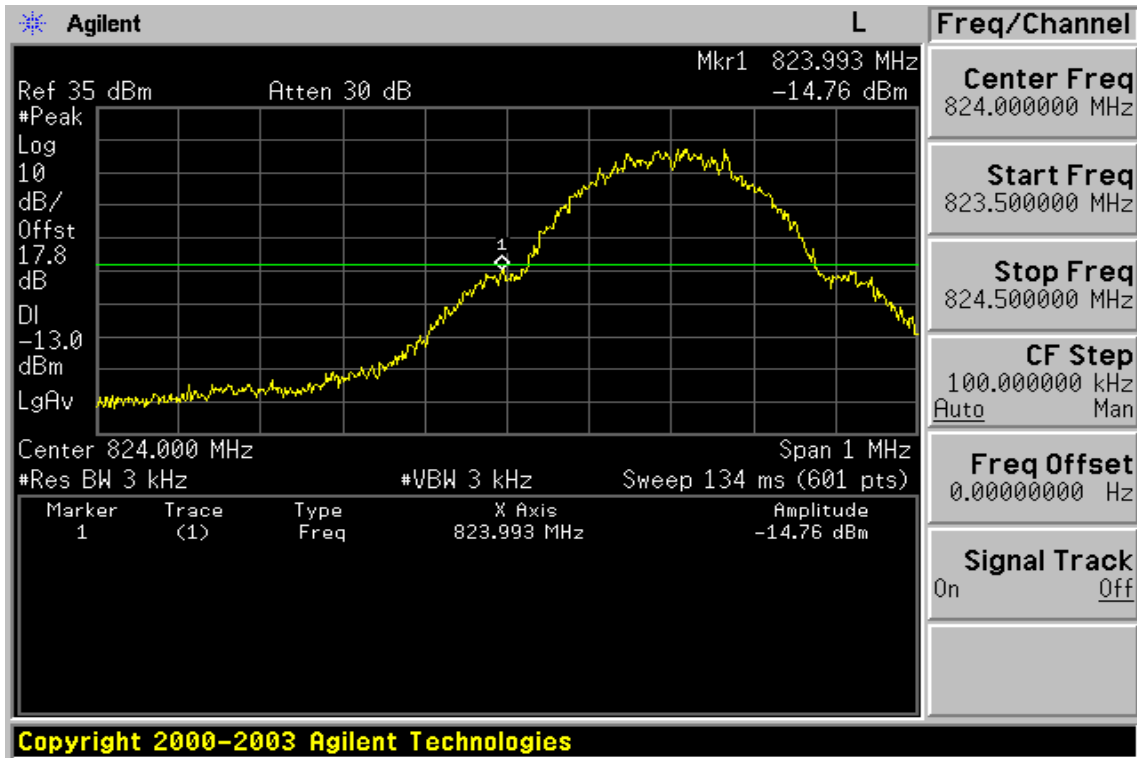
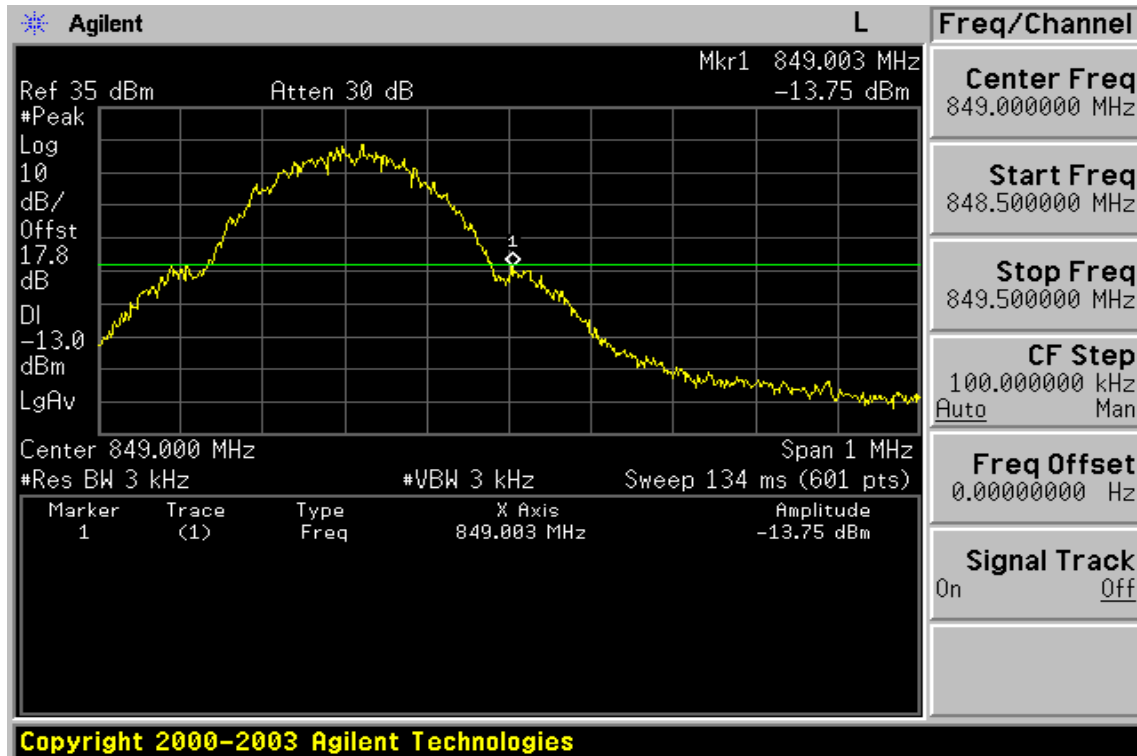
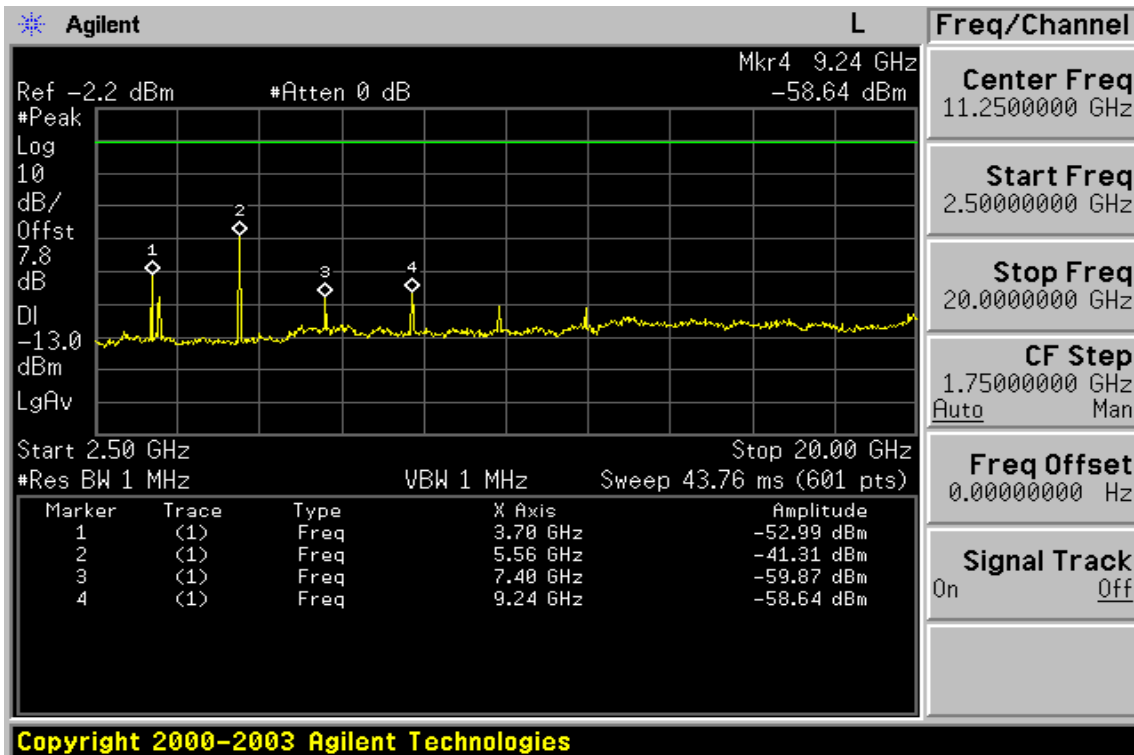
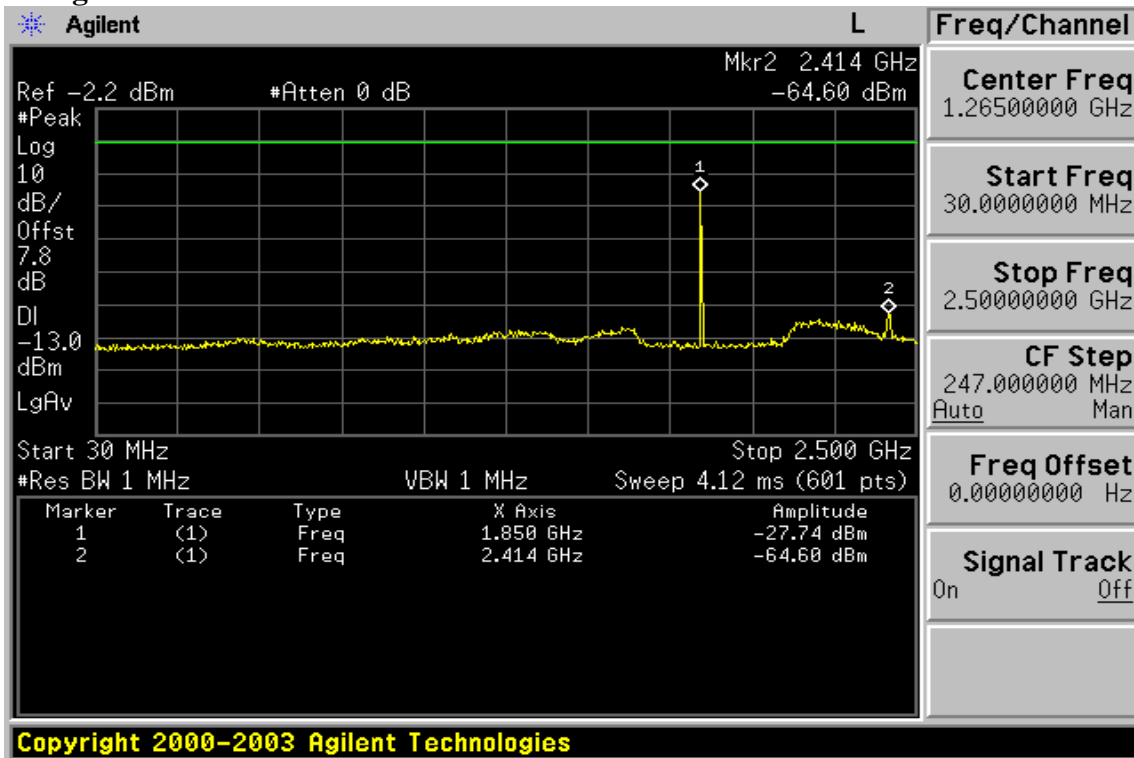

Figure 8-5: Band edge emission at antenna terminals – GSM Channel Highest



This document is issued by the Company subject to its General Conditions of Service printed overleaf or available on request and accessible at www.sgs.com. Attention is drawn to the limitations of liability, indemnification, and Jurisdictional issued defined therein. Unless otherwise stated, the results shown in this test report refer only to the sample(s) tested. This document cannot be reproduced except in full, without prior approval of Company. Any unauthorized alteration, forgery or falsification of the content or appearance of this report is unlawful and offenders may be prosecuted to the fullest extent of the law. 此報告是遵循本公司訂定之通用服務條款所製作發放，請注意此條款列印於背面，亦可在www.sgs.com中查閱。將本公司之義務，免責，管轄權皆明確規範之。除非另有說明，此報告結果僅對檢驗之樣品負責。本報告未經本公司書面許可，不可部份複製。對本報告內容或外觀之任何未經授權之變更、偽造、竄改皆屬非法，違犯者將會被依法追訴。

Figure 8-6: Out of Band emission at antenna terminals– PCS Channel Lowest



This document is issued by the Company subject to its General Conditions of Service printed overleaf or available on request and accessible at www.sgs.com. Attention is drawn to the limitations of liability, indemnification, and Jurisdictional issued defined therein. Unless otherwise stated, the results shown in this test report refer only to the sample(s) tested. This document cannot be reproduced except in full, without prior approval of Company. Any unauthorized alteration, forgery or falsification of the content or appearance of this report is unlawful and offenders may be prosecuted to the fullest extent of the law. 此報告是遵循本公司訂定之通用服務條款所製作發放，請注意此條款列印於背面，亦可在www.sgs.com中查閱。將本公司之義務，免責，管轄權皆明確規範之。除非另有說明，此報告結果僅對檢驗之樣品負責。本報告未經本公司書面許可，不可部份複製。對本報告內容或外觀之任何未經授權之變更、偽造、竄改皆屬非法，違犯者將會被依法追訴。

Figure 8-7: Out of Band emission at antenna terminals –PCS Channel Mid

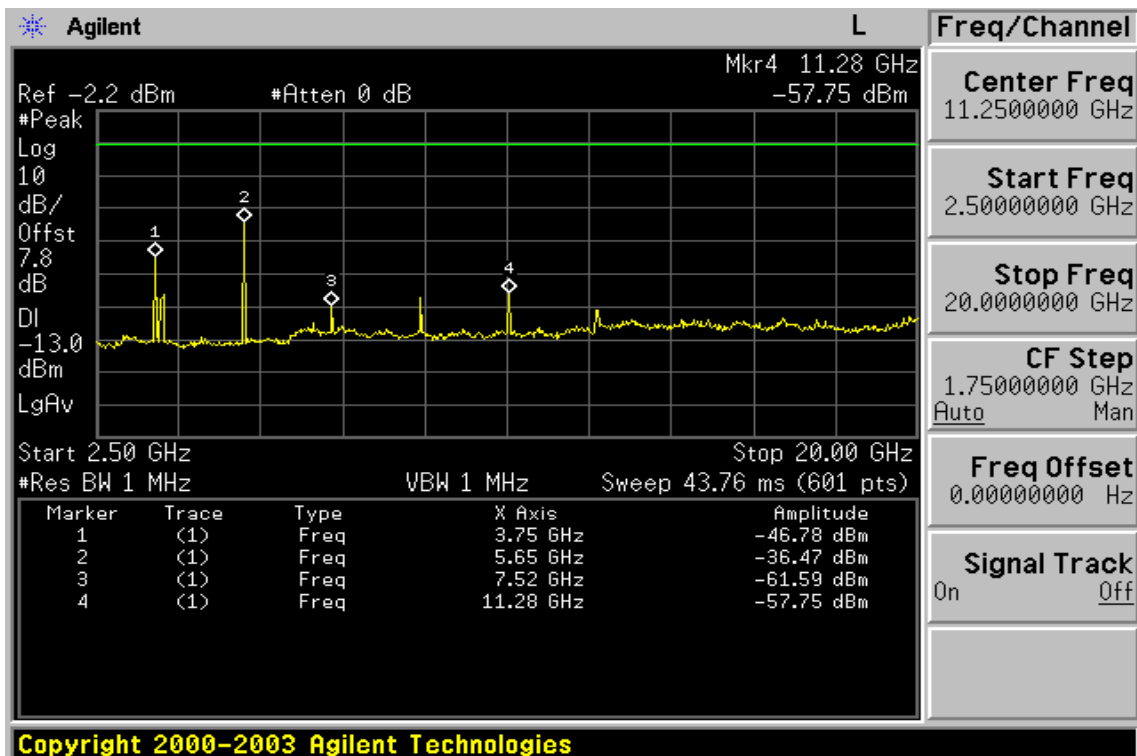
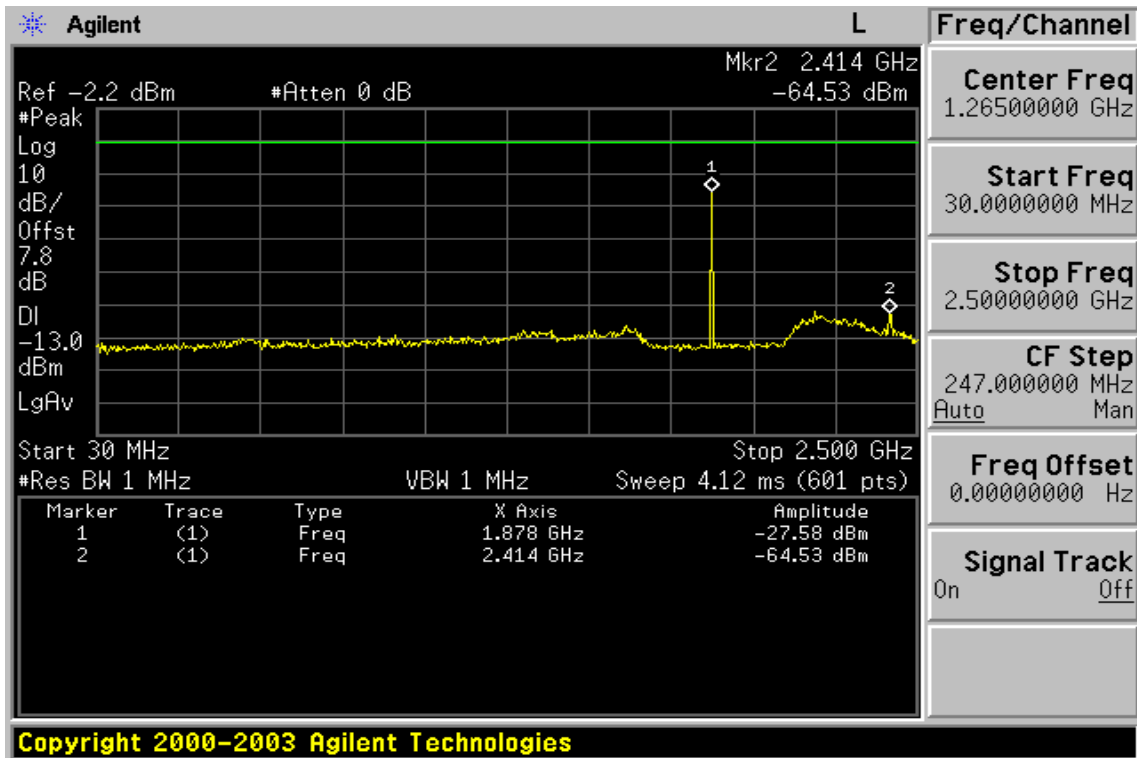

This document is issued by the Company subject to its General Conditions of Service printed overleaf or available on request and accessible at www.sgs.com. Attention is drawn to the limitations of liability, indemnification, and Jurisdictional issued defined therein. Unless otherwise stated, the results shown in this test report refer only to the sample(s) tested. This document cannot be reproduced except in full, without prior approval of Company. Any unauthorized alteration, forgery or falsification of the content or appearance of this report is unlawful and offenders may be prosecuted to the fullest extent of the law. 此報告是遵循本公司訂定之通用服務條款所製作發放，請注意此條款列印於背面，亦可在www.sgs.com中查閱。將本公司之義務，免責，管轄權皆明確規範之。除非另有說明，此報告結果僅對檢驗之樣品負責。本報告未經本公司書面許可，不可部份複製。對本報告內容或外觀之任何未經授權之變更、偽造、竄改皆屬非法，違犯者將會被依法追訴。

Figure 8-8: Out of Band emission at antenna terminals–PCS Channel Highest

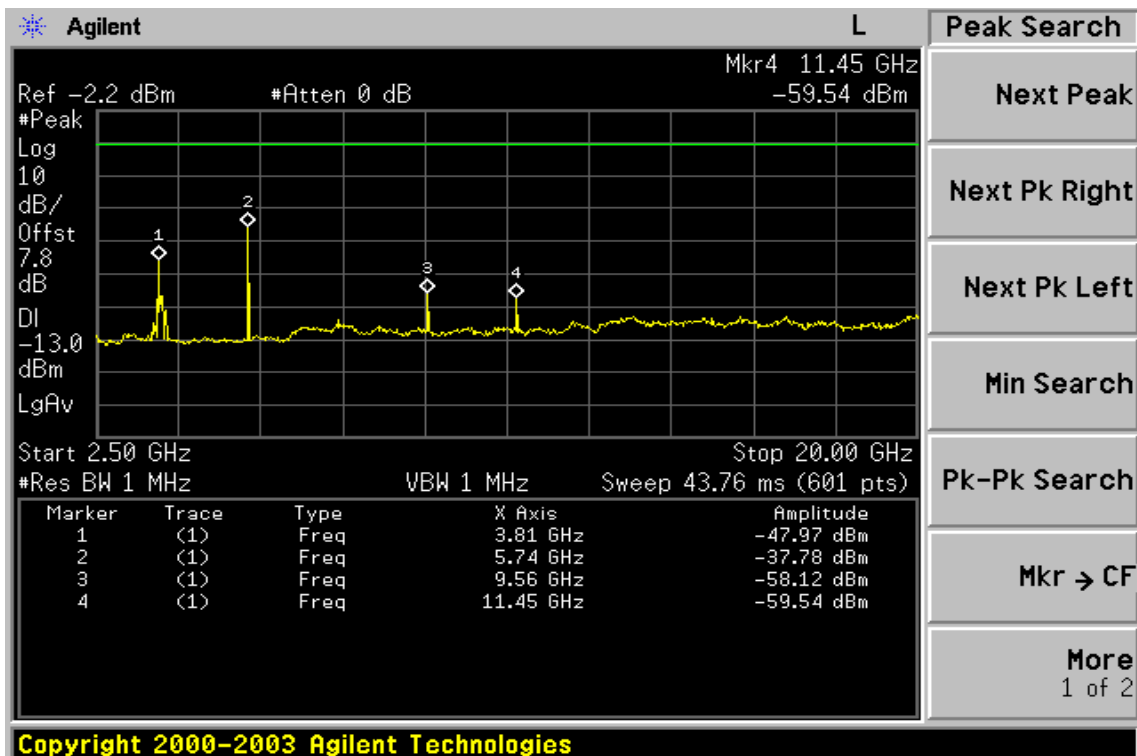
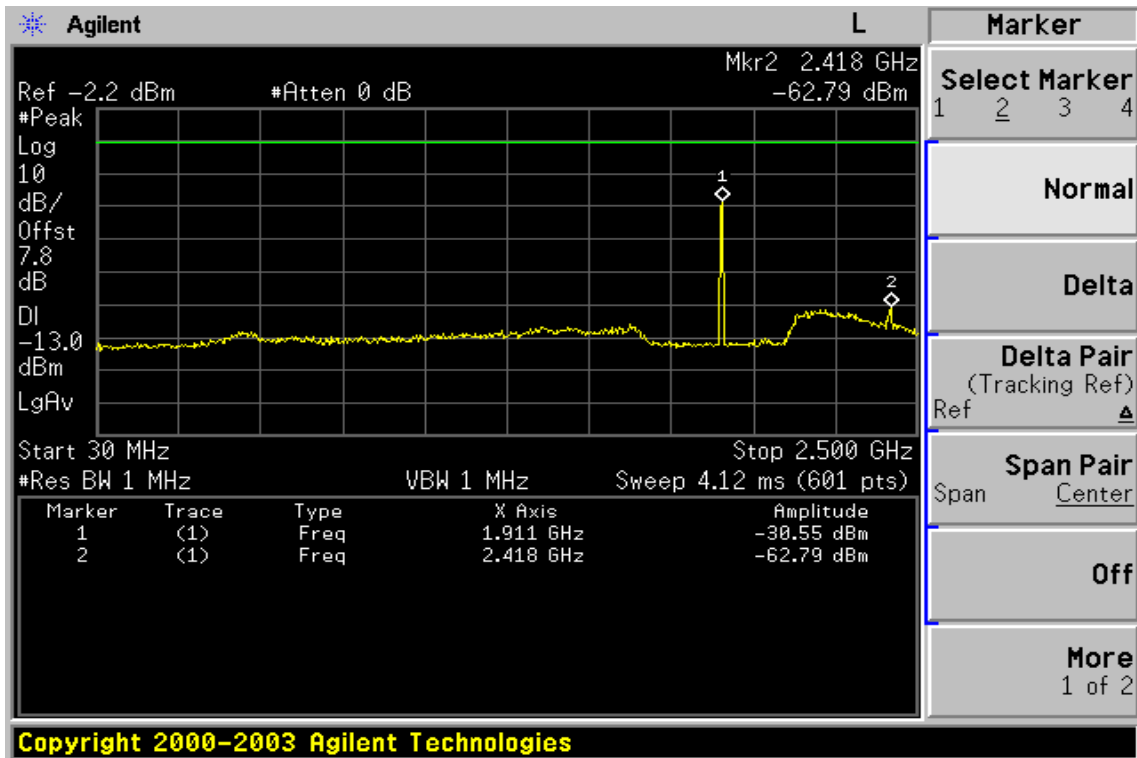

This document is issued by the Company subject to its General Conditions of Service printed overleaf or available on request and accessible at www.sgs.com. Attention is drawn to the limitations of liability, indemnification, and Jurisdictional issued defined therein. Unless otherwise stated, the results shown in this test report refer only to the sample(s) tested. This document cannot be reproduced except in full, without prior approval of Company. Any unauthorized alteration, forgery or falsification of the content or appearance of this report is unlawful and offenders may be prosecuted to the fullest extent of the law. 此報告是遵循本公司訂定之通用服務條款所製作發放，請注意此條款列印於背面，亦可在www.sgs.com中查閱。將本公司之義務，免責，管轄權皆明確規範之。除非另有說明，此報告結果僅對檢驗之樣品負責。本報告未經本公司書面許可，不可部份複製。對本報告內容或外觀之任何未經授權之變更、偽造、竄改皆屬非法，違犯者將會被依法追訴。

Figure 8-9: Band edge emission at antenna terminals – PCS Channel Lowest

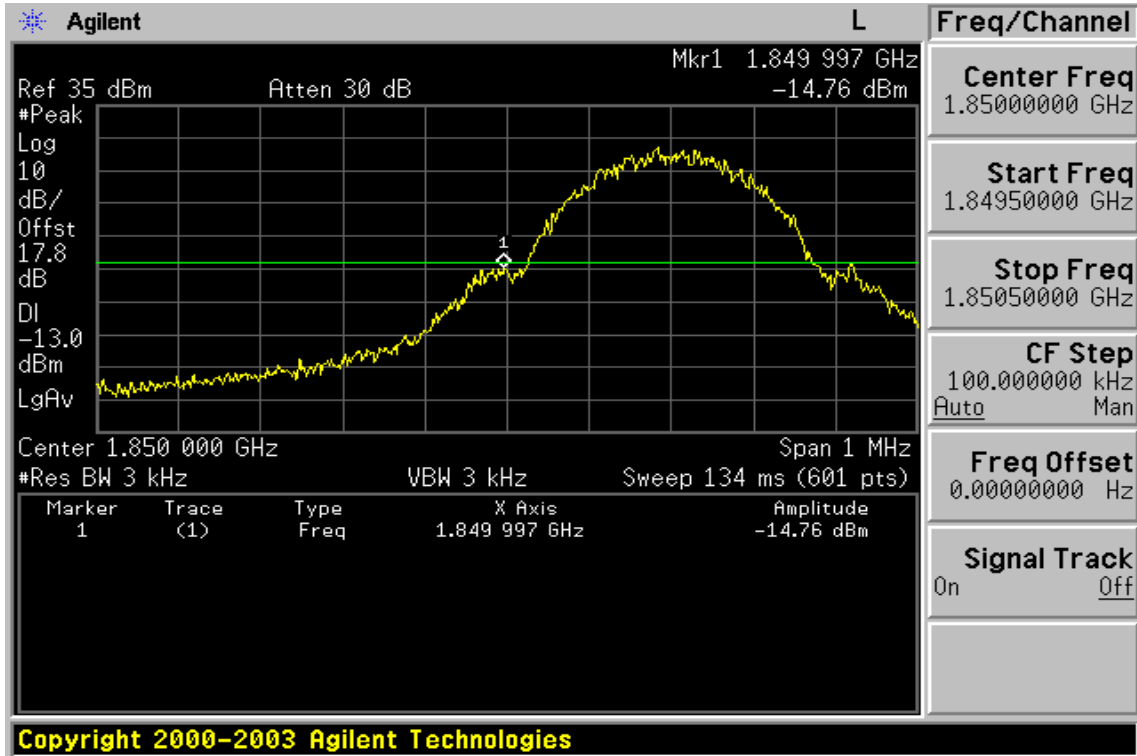
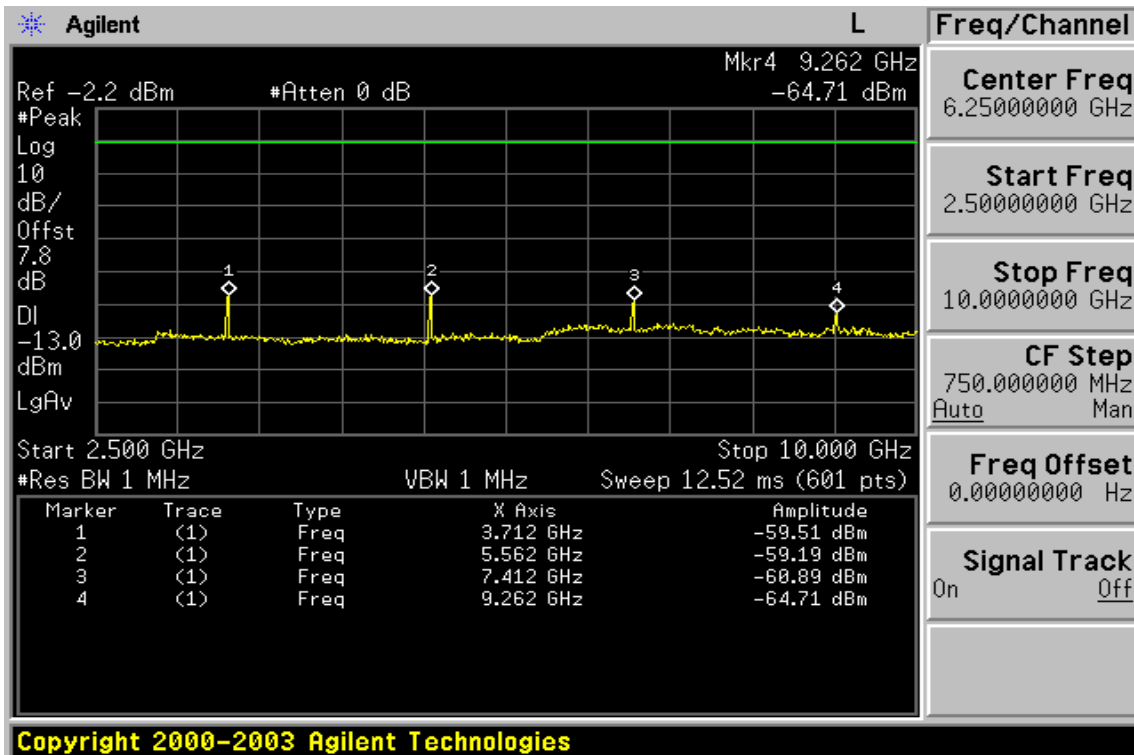
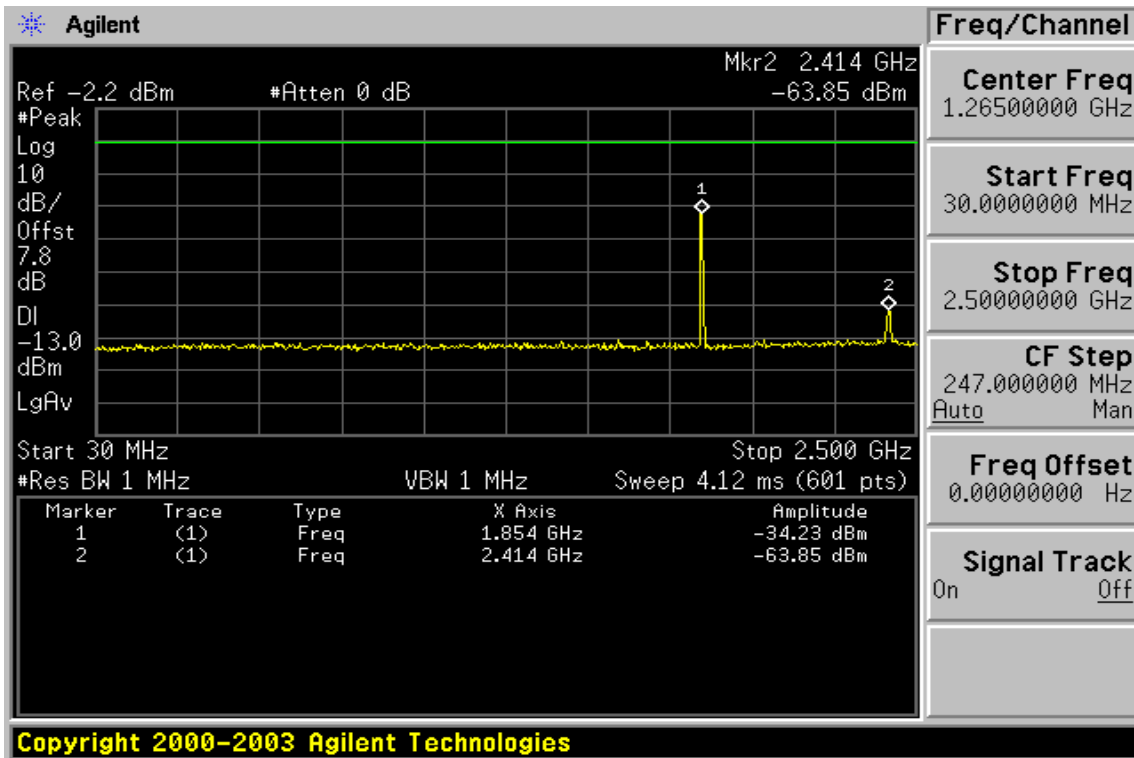

Figure 8-10: Band edge emission at antenna terminals – PCS Channel Highest



This document is issued by the Company subject to its General Conditions of Service printed overleaf or available on request and accessible at www.sgs.com. Attention is drawn to the limitations of liability, indemnification, and Jurisdictional issued defined therein. Unless otherwise stated, the results shown in this test report refer only to the sample(s) tested. This document cannot be reproduced except in full, without prior approval of Company. Any unauthorized alteration, forgery or falsification of the content or appearance of this report is unlawful and offenders may be prosecuted to the fullest extent of the law. 此報告是遵循本公司訂定之通用服務條款所製作發放，請注意此條款列印於背面，亦可在www.sgs.com中查閱。將本公司之義務，免責，管轄權皆明確規範之。除非另有說明，此報告結果僅對檢驗之樣品負責。本報告未經本公司書面許可，不可部份複製。對本報告內容或外觀之任何未經授權之變更、偽造、竄改皆屬非法，違犯者將會被依法追訴。

Figure 8-10: Out of Band emission at antenna terminals– WCDMA Band II Channel Lowest



This document is issued by the Company subject to its General Conditions of Service printed overleaf or available on request and accessible at www.sgs.com. Attention is drawn to the limitations of liability, indemnification, and Jurisdictional issued defined therein. Unless otherwise stated, the results shown in this test report refer only to the sample(s) tested. This document cannot be reproduced except in full, without prior approval of Company. Any unauthorized alteration, forgery or falsification of the content or appearance of this report is unlawful and offenders may be prosecuted to the fullest extent of the law. 此報告是遵循本公司訂定之通用服務條款所製作發放，請注意此條款列印於背面，亦可在www.sgs.com中查閱。將本公司之義務，免責，管轄權皆明確規範之。除非另有說明，此報告結果僅對檢驗之樣品負責。本報告未經本公司書面許可，不可部份複製。對本報告內容或外觀之任何未經授權之變更、偽造、竄改皆屬非法，違犯者將會被依法追訴。

Figure 8-11: Out of Band emission at antenna terminals –WCDMA Band II Channel Mid

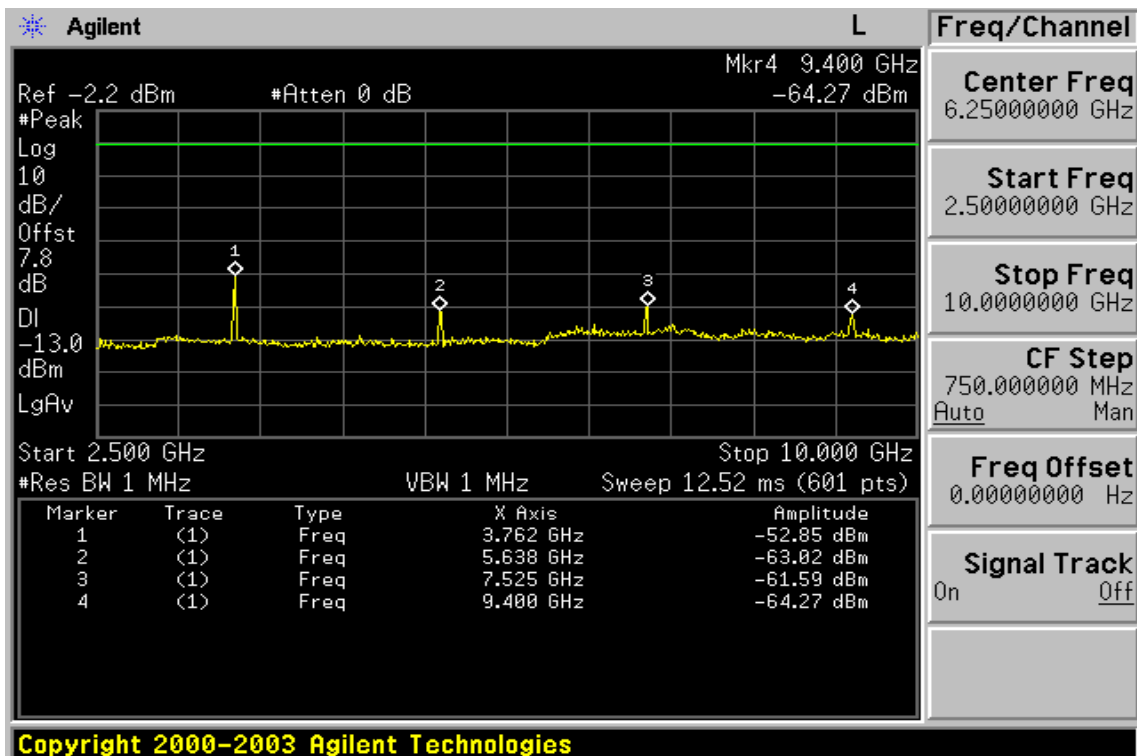
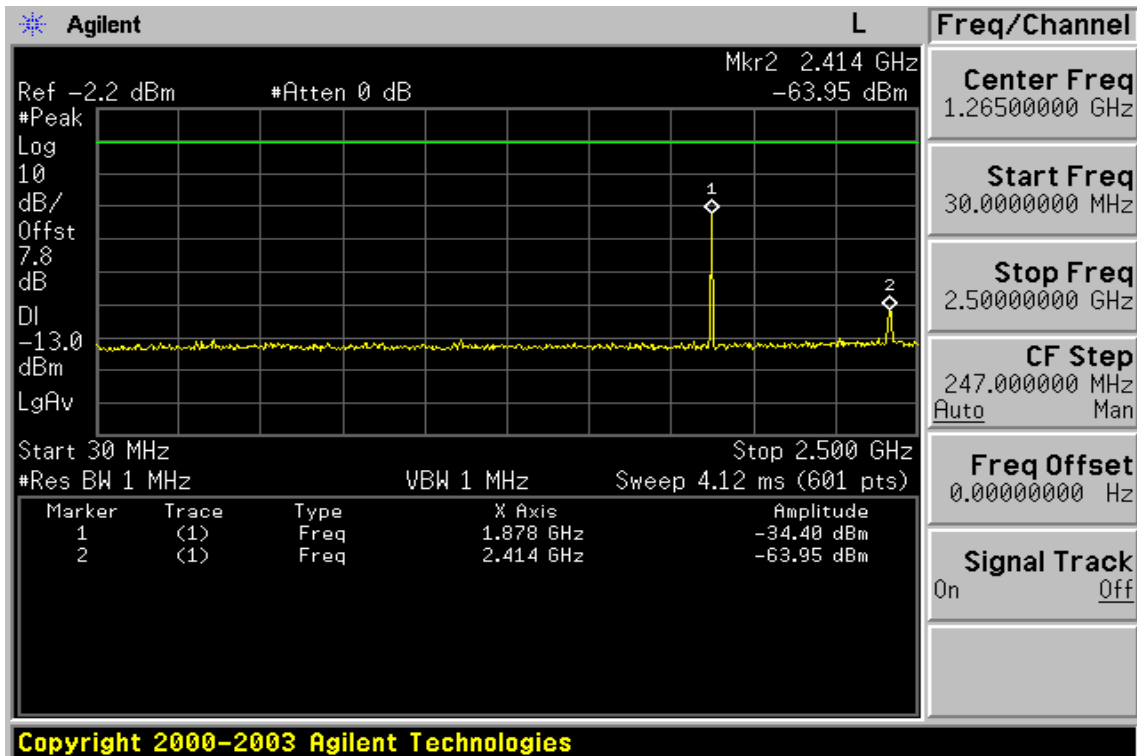

This document is issued by the Company subject to its General Conditions of Service printed overleaf or available on request and accessible at www.sgs.com. Attention is drawn to the limitations of liability, indemnification, and Jurisdictional issued defined therein. Unless otherwise stated, the results shown in this test report refer only to the sample(s) tested. This document cannot be reproduced except in full, without prior approval of Company. Any unauthorized alteration, forgery or falsification of the content or appearance of this report is unlawful and offenders may be prosecuted to the fullest extent of the law. 此報告是遵循本公司訂定之通用服務條款所製作發放，請注意此條款列印於背面，亦可於www.sgs.com中查閱。將本公司之義務，免責，管轄權皆明確規範之。除非另有說明，此報告結果僅對檢驗之樣品負責。本報告未經本公司書面許可，不可部份複製。對本報告內容或外觀之任何未經授權之變更、偽造、竄改皆屬非法，違犯者將會被依法追訴。

Figure 8-12: Out of Band emission at antenna terminals–WCDMA BAND II Channel Highest

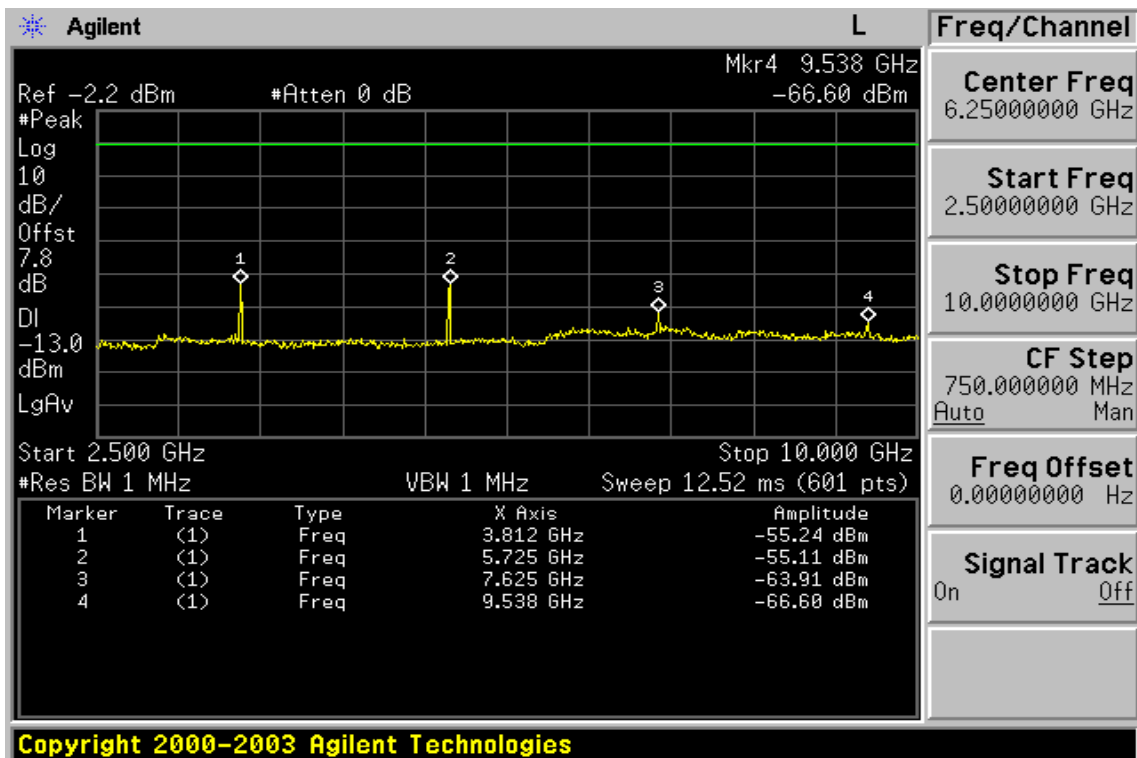
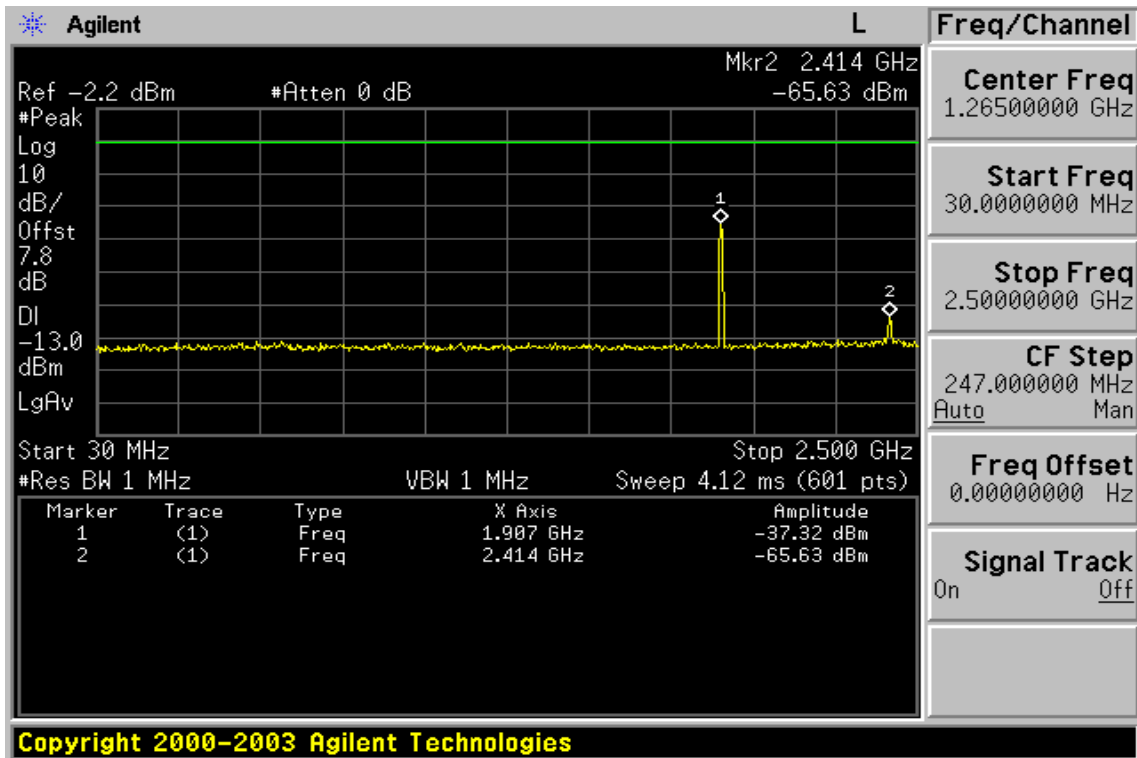

This document is issued by the Company subject to its General Conditions of Service printed overleaf or available on request and accessible at www.sgs.com. Attention is drawn to the limitations of liability, indemnification, and Jurisdictional issued defined therein. Unless otherwise stated, the results shown in this test report refer only to the sample(s) tested. This document cannot be reproduced except in full, without prior approval of Company. Any unauthorized alteration, forgery or falsification of the content or appearance of this report is unlawful and offenders may be prosecuted to the fullest extent of the law. 此報告是遵循本公司訂定之通用服務條款所製作發放，請注意此條款列印於背面，亦可在www.sgs.com中查閱。將本公司之義務，免責，管轄權皆明確規範之。除非另有說明，此報告結果僅對檢驗之樣品負責。本報告未經本公司書面許可，不可部份複製。對本報告內容或外觀之任何未經授權之變更、偽造、竄改皆屬非法，違犯者將會被依法追訴。

Figure 8-13: Band edge emission at antenna terminals – WCDMA BAND II Channel Lowest

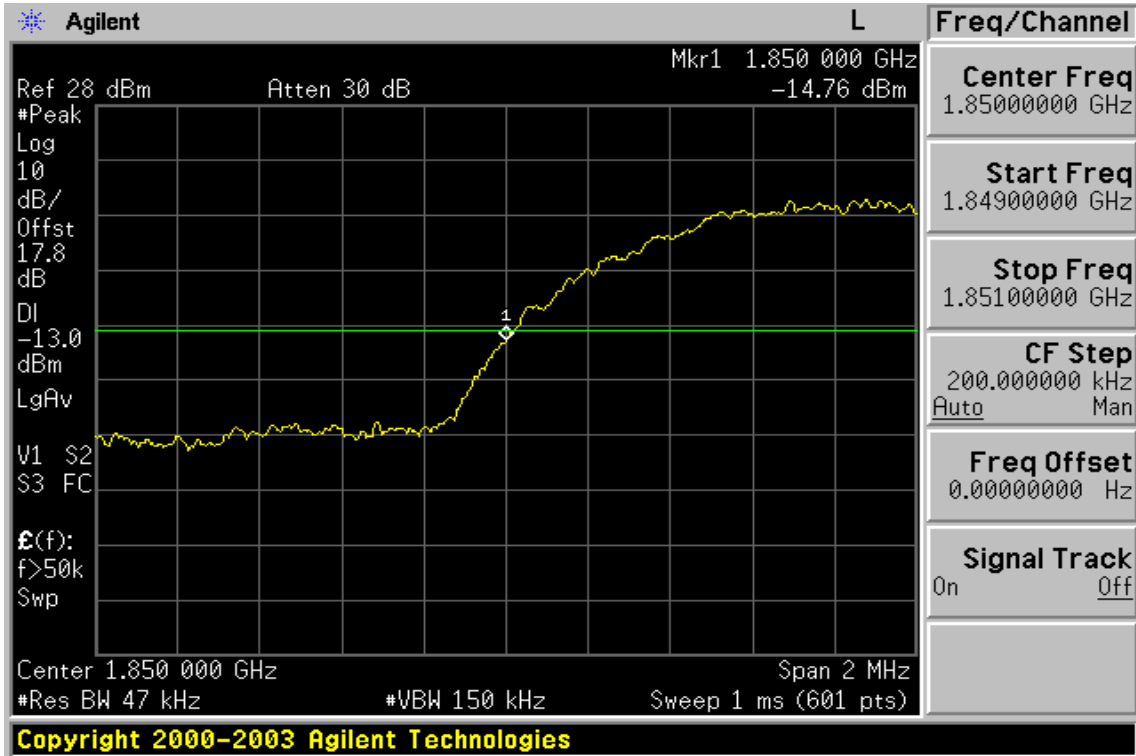
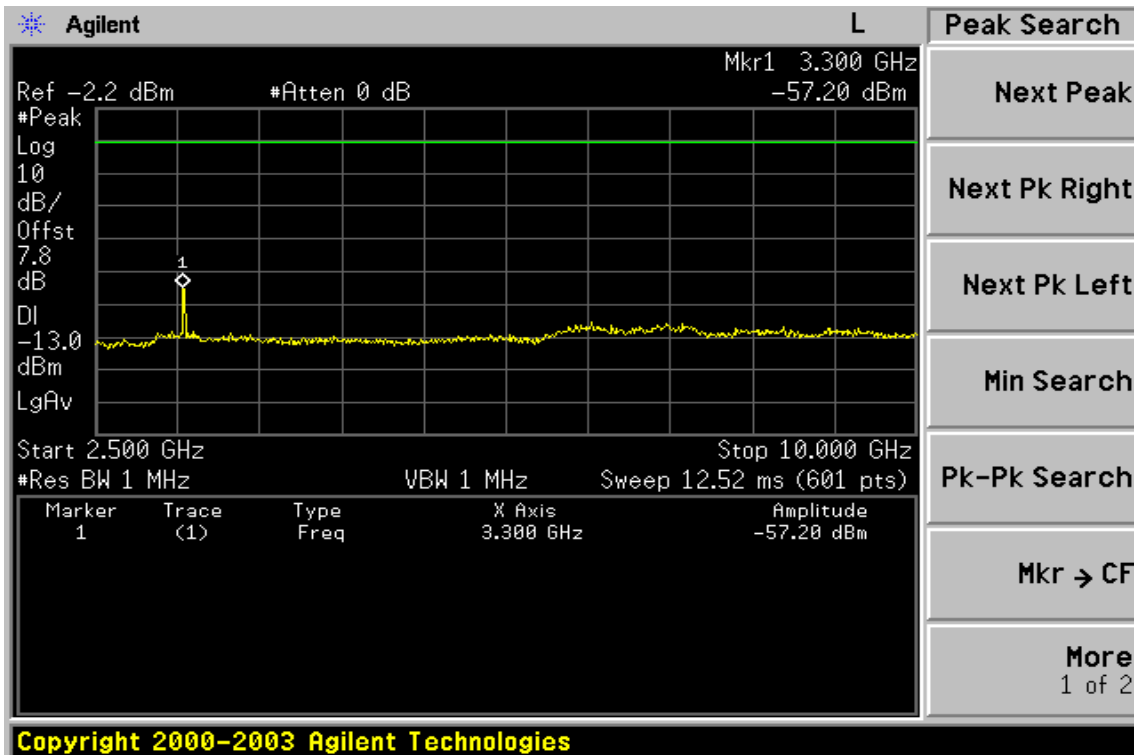
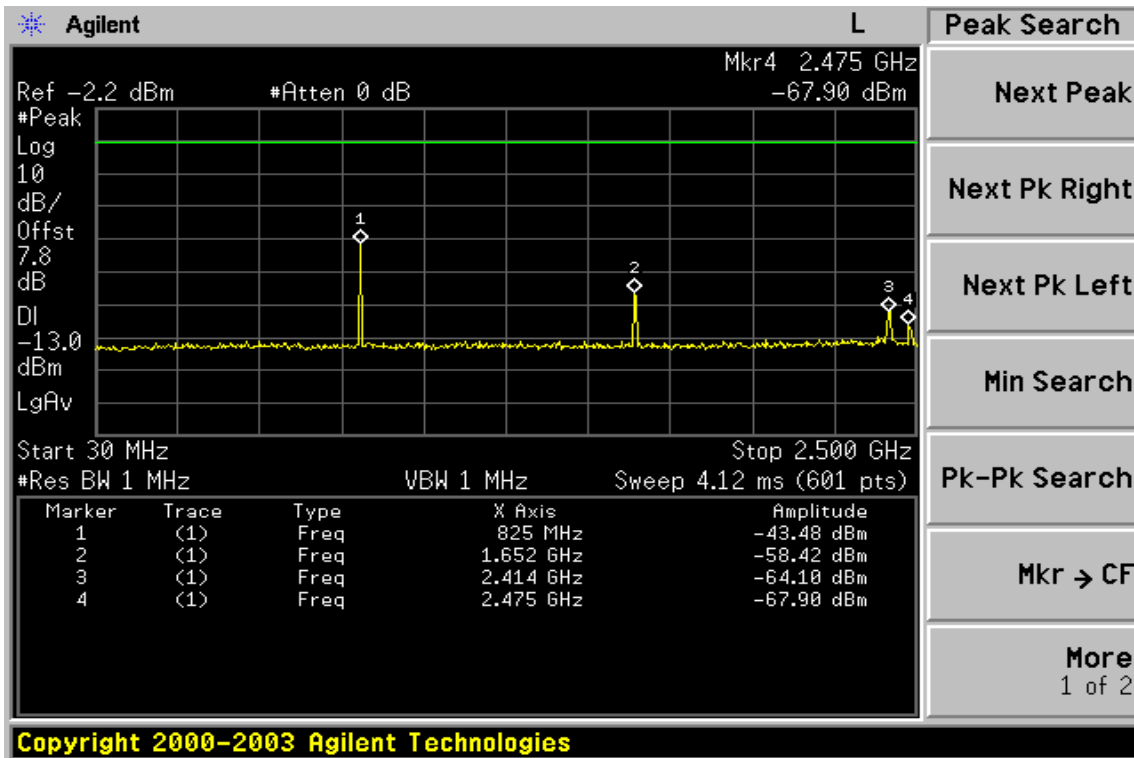

Figure 8-14: Band edge emission at antenna terminals –WCDMA BAND II Channel Highest



This document is issued by the Company subject to its General Conditions of Service printed overleaf or available on request and accessible at www.sgs.com. Attention is drawn to the limitations of liability, indemnification, and Jurisdictional issued defined therein. Unless otherwise stated, the results shown in this test report refer only to the sample(s) tested. This document cannot be reproduced except in full, without prior approval of Company. Any unauthorized alteration, forgery or falsification of the content or appearance of this report is unlawful and offenders may be prosecuted to the fullest extent of the law. 此報告是遵循本公司訂定之通用服務條款所製作發放，請注意此條款列印於背面，亦可在www.sgs.com中查閱。將本公司之義務，免責，管轄權皆明確規範之。除非另有說明，此報告結果僅對檢驗之樣品負責。本報告未經本公司書面許可，不可部份複製。對本報告內容或外觀之任何未經授權之變更、偽造、竄改皆屬非法，違犯者將會被依法追訴。

Figure 8-14: Out of Band emission at antenna terminals– WCDMA Band V Channel Lowest



This document is issued by the Company subject to its General Conditions of Service printed overleaf or available on request and accessible at www.sgs.com. Attention is drawn to the limitations of liability, indemnification, and Jurisdictional issued defined therein. Unless otherwise stated, the results shown in this test report refer only to the sample(s) tested. This document cannot be reproduced except in full, without prior approval of Company. Any unauthorized alteration, forgery or falsification of the content or appearance of this report is unlawful and offenders may be prosecuted to the fullest extent of the law. 此報告是遵循本公司訂定之通用服務條款所製作發放，請注意此條款列印於背面，亦可在www.sgs.com中查閱。將本公司之義務，免責，管轄權皆明確規範之。除非另有說明，此報告結果僅對檢驗之樣品負責。本報告未經本公司書面許可，不可部份複製。對本報告內容或外觀之任何未經授權之變更、偽造、竄改皆屬非法，違犯者將會被依法追訴。

Figure 8-15: Out of Band emission at antenna terminals –WCDMA Band V Channel Mid

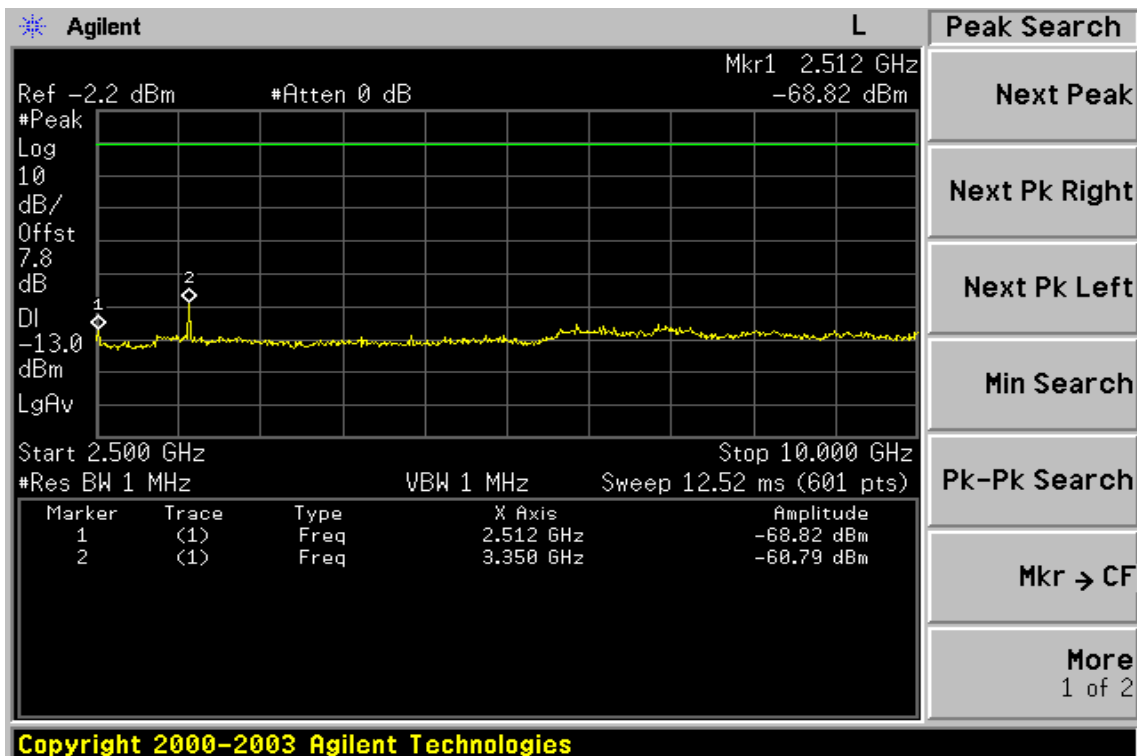
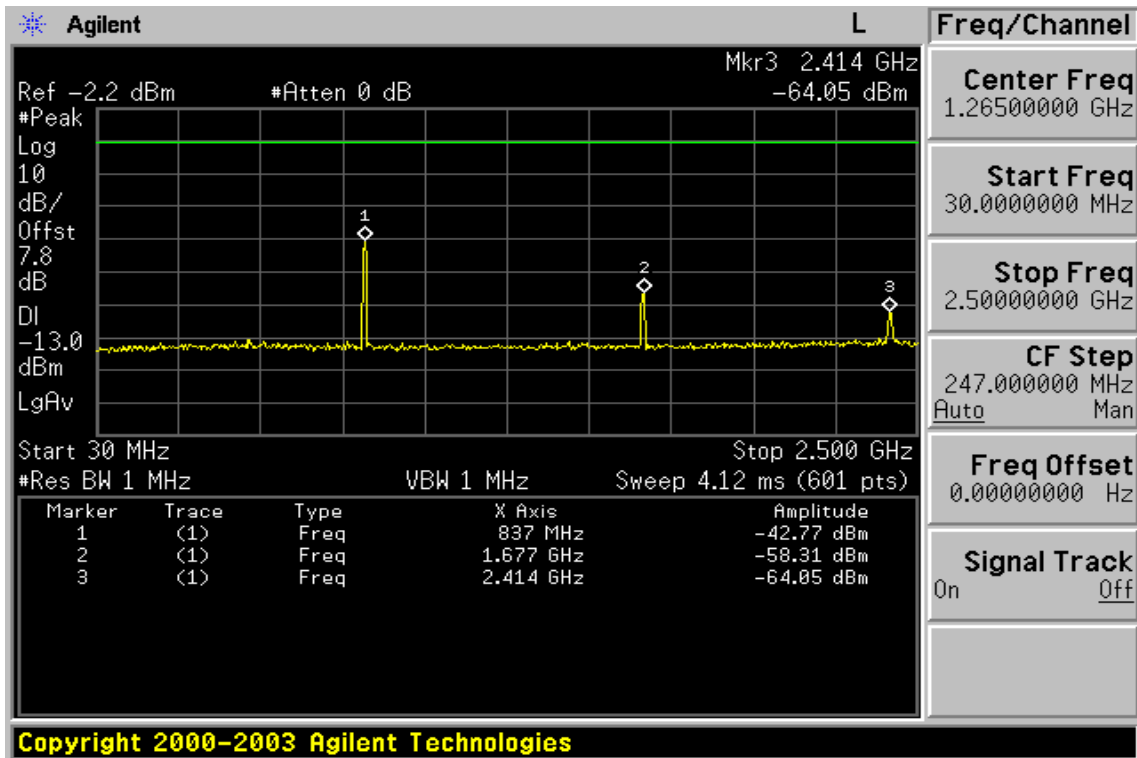

This document is issued by the Company subject to its General Conditions of Service printed overleaf or available on request and accessible at www.sgs.com. Attention is drawn to the limitations of liability, indemnification, and Jurisdictional issued defined therein. Unless otherwise stated, the results shown in this test report refer only to the sample(s) tested. This document cannot be reproduced except in full, without prior approval of Company. Any unauthorized alteration, forgery or falsification of the content or appearance of this report is unlawful and offenders may be prosecuted to the fullest extent of the law. 此報告是遵循本公司訂定之通用服務條款所製作發放，請注意此條款列印於背面，亦可在www.sgs.com中查閱。將本公司之義務，免責，管轄權皆明確規範之。除非另有說明，此報告結果僅對檢驗之樣品負責。本報告未經本公司書面許可，不可部份複製。對本報告內容或外觀之任何未經授權之變更、偽造、竄改皆屬非法，違犯者將會被依法追訴。

Figure 8-16: Out of Band emission at antenna terminals–WCDMA BAND V Channel Highest

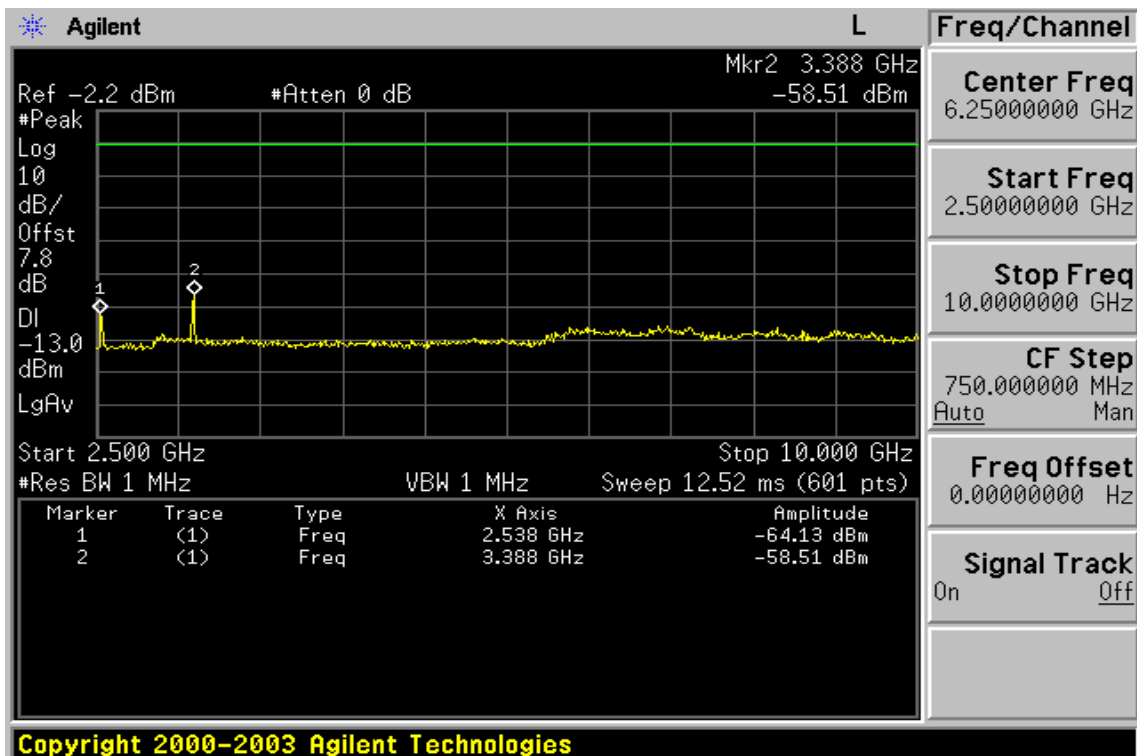
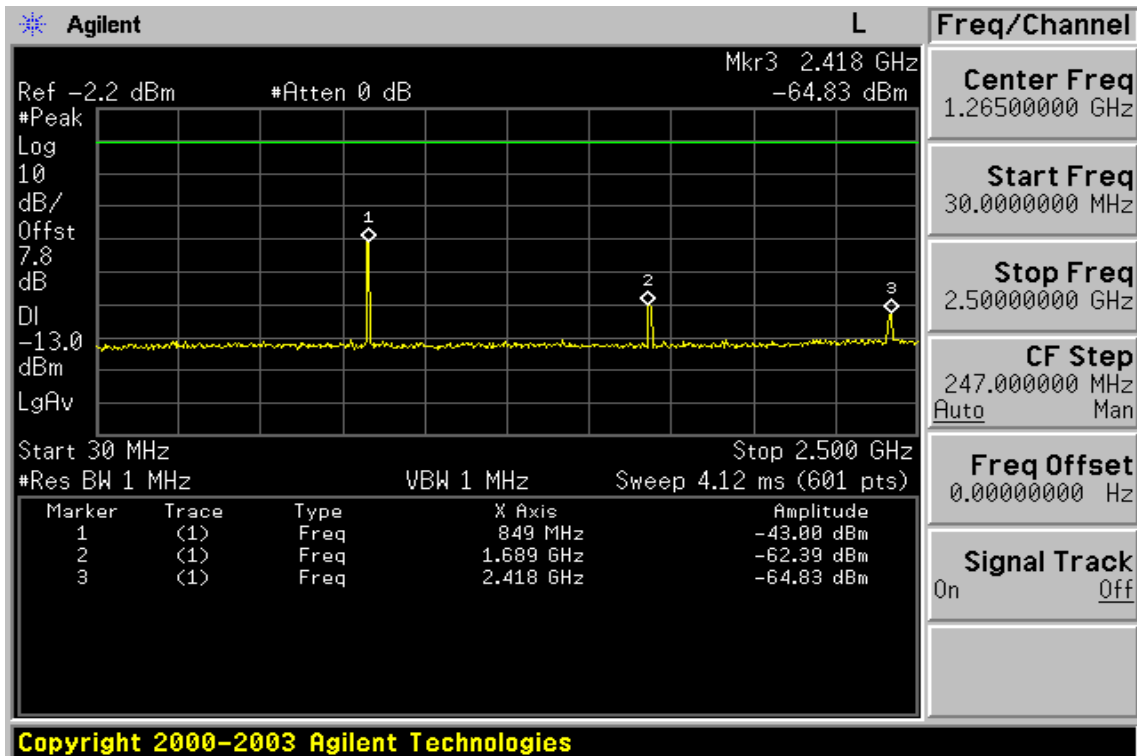

This document is issued by the Company subject to its General Conditions of Service printed overleaf or available on request and accessible at www.sgs.com. Attention is drawn to the limitations of liability, indemnification, and Jurisdictional issued defined therein. Unless otherwise stated, the results shown in this test report refer only to the sample(s) tested. This document cannot be reproduced except in full, without prior approval of Company. Any unauthorized alteration, forgery or falsification of the content or appearance of this report is unlawful and offenders may be prosecuted to the fullest extent of the law. 此報告是遵循本公司訂定之通用服務條款所製作發放，請注意此條款列印於背面，亦可在www.sgs.com中查閱。將本公司之義務，免責，管轄權皆明確規範之。除非另有說明，此報告結果僅對檢驗之樣品負責。本報告未經本公司書面許可，不可部份複製。對本報告內容或外觀之任何未經授權之變更、偽造、竄改皆屬非法，違犯者將會被依法追訴。

Figure 8-17: Band edge emission at antenna terminals – WCDMA BAND V Channel Lowest

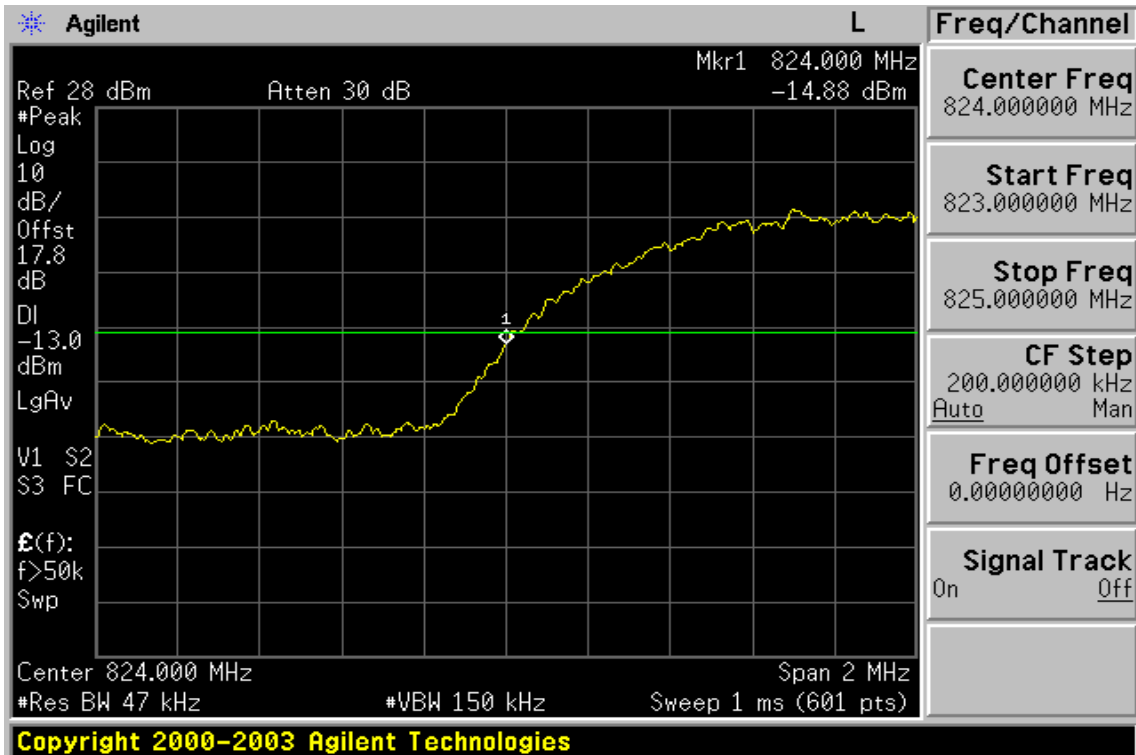
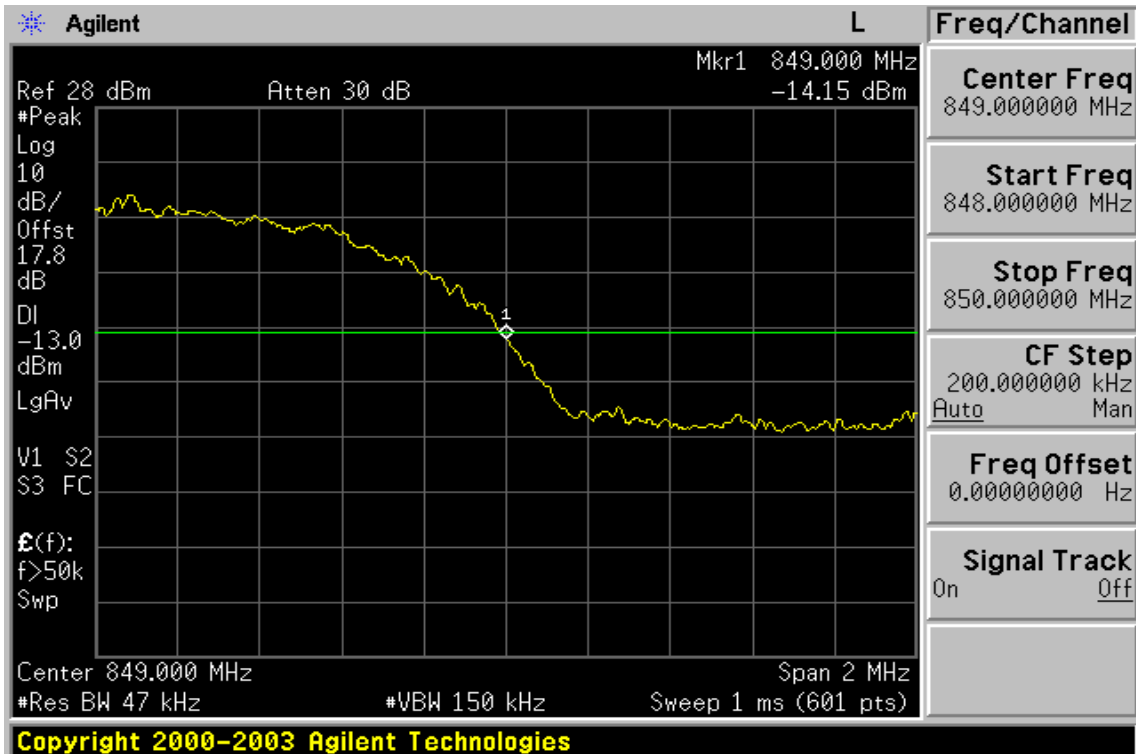

Figure 8-18: Band edge emission at antenna terminals – WCDMA BAND V Channel Highest



This document is issued by the Company subject to its General Conditions of Service printed overleaf or available on request and accessible at www.sgs.com. Attention is drawn to the limitations of liability, indemnification, and Jurisdictional issued defined therein. Unless otherwise stated, the results shown in this test report refer only to the sample(s) tested. This document cannot be reproduced except in full, without prior approval of Company. Any unauthorized alteration, forgery or falsification of the content or appearance of this report is unlawful and offenders may be prosecuted to the fullest extent of the law. 此報告是遵循本公司訂定之通用服務條款所製作發放，請注意此條款列印於背面，亦可在www.sgs.com中查閱。將本公司之義務，免責，管轄權皆明確規範之。除非另有說明，此報告結果僅對檢驗之樣品負責。本報告未經本公司書面許可，不可部份複製。對本報告內容或外觀之任何未經授權之變更、偽造、竄改皆屬非法，違犯者將會被依法追訴。

9. FIELD STRENGTH OF SPURIOUS RADIATION MEASUREMENT

9.1 Standard Applicable

According to FCC §2.1053,

FCC §22.917(a), §24.238(a), the magnitude of each spurious and harmonic emission that can be detected when the equipment is operated under the conditions specified in the instruction manual and/ or alignment procedure, shall not be less than $43 + 10 \log$ (mean output power in watts) dBc below the mean power output outside a license's frequency block (-13dBm)

9.2 EUT Setup (Block Diagram of Configuration)

(A) Radiated Emission Test Set-Up, Frequency Below 1000MHz

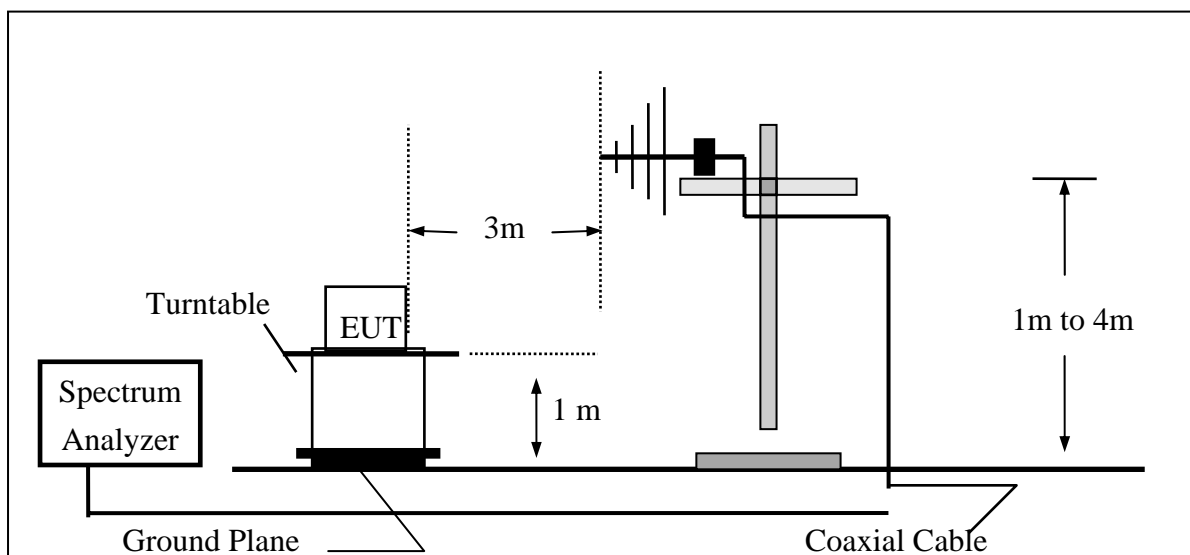

This document is issued by the Company subject to its General Conditions of Service printed overleaf or available on request and accessible at www.sgs.com. Attention is drawn to the limitations of liability, indemnification, and Jurisdictional issued defined therein. Unless otherwise stated, the results shown in this test report refer only to the sample(s) tested. This document cannot be reproduced except in full, without prior approval of Company. Any unauthorized alteration, forgery or falsification of the content or appearance of this report is unlawful and offenders may be prosecuted to the fullest extent of the law. 此報告是遵循本公司訂定之通用服務條款所製作發放，請注意此條款列印於背面，亦可在www.sgs.com中查閱。將本公司之義務，免責，管轄權皆明確規範之。除非另有說明，此報告結果僅對檢驗之樣品負責。本報告未經本公司書面許可，不可部份複製。對本報告內容或外觀之任何未經授權之變更、偽造、竄改皆屬非法，違犯者將會被依法追訴。

(B) Radiated Emission Test Set-UP Frequency Over 1 GHz

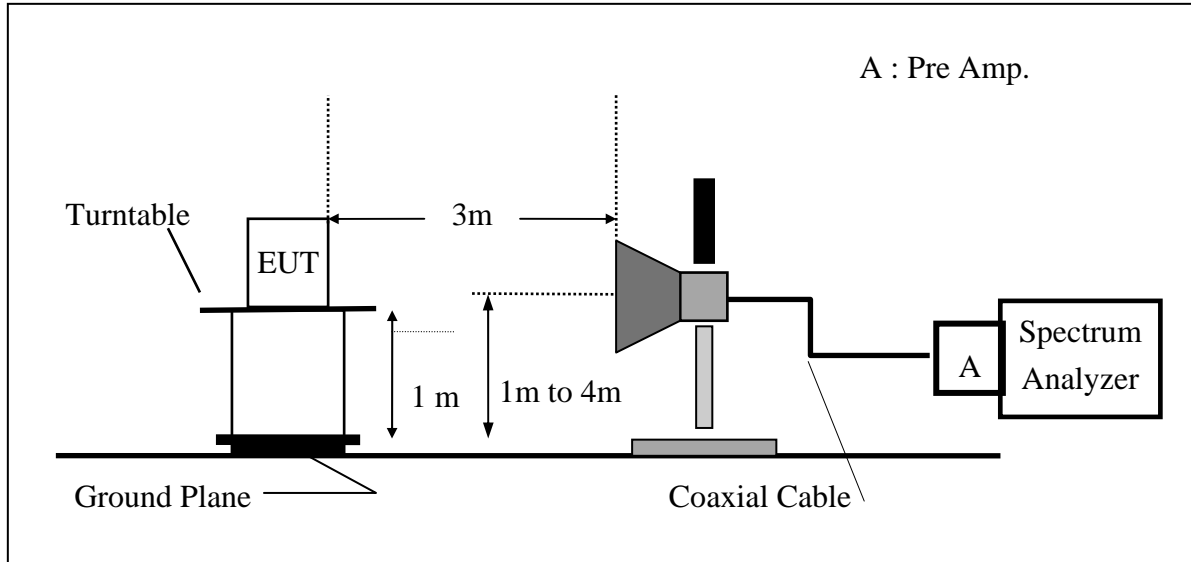

(C) Substituted Method Test Set-UP

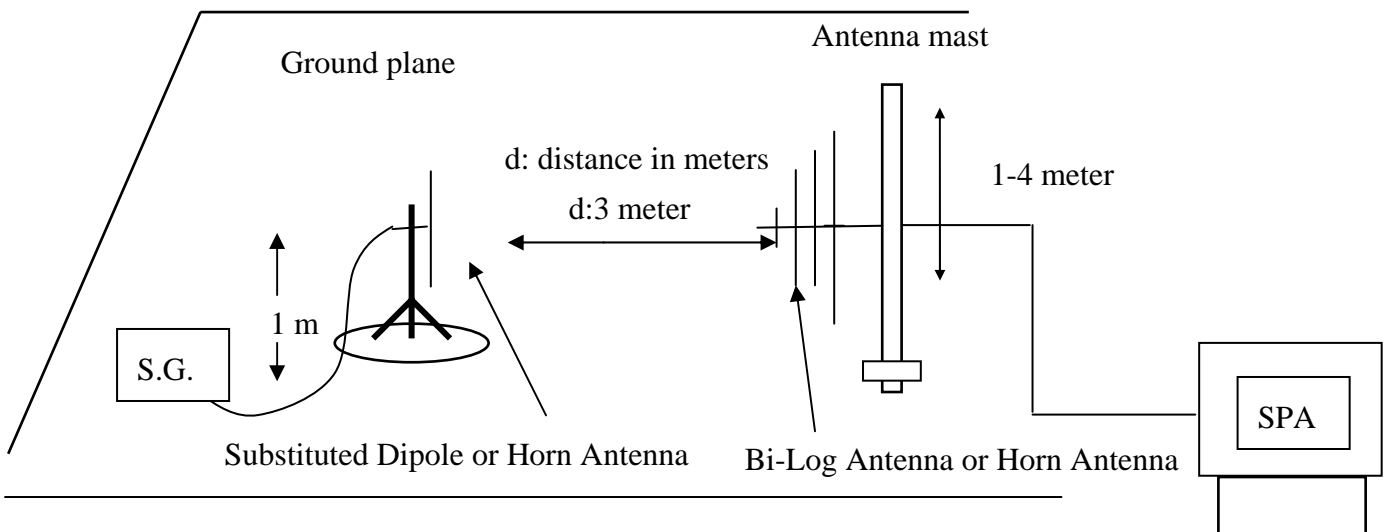

This document is issued by the Company subject to its General Conditions of Service printed overleaf or available on request and accessible at www.sgs.com. Attention is drawn to the limitations of liability, indemnification, and Jurisdictional issued defined therein. Unless otherwise stated, the results shown in this test report refer only to the sample(s) tested. This document cannot be reproduced except in full, without prior approval of Company. Any unauthorized alteration, forgery or falsification of the content or appearance of this report is unlawful and offenders may be prosecuted to the fullest extent of the law. 此報告是遵循本公司訂定之通用服務條款所製作發放，請注意此條款列印於背面，亦可在www.sgs.com中查閱。將本公司之義務，免責，管轄權皆明確規範之。除非另有說明，此報告結果僅對檢驗之樣品負責。本報告未經本公司書面許可，不可部份複製。對本報告內容或外觀之任何未經授權之變更、偽造、竄改皆屬非法，違犯者將會被依法追訴。

9.3 Measurement Procedure

The EUT was placed on a non-conductive, The measurement antenna was placed at a distance of 3 meters from the EUT. During the tests, the antenna height and the EUT azimuth were varied in order to identify the maximum level of emissions from the EUT. This maximization process was repeated with the EUT positioned in each of its three orthogonal orientations.

The frequency range up to tenth harmonic was investigated for each of three fundamental frequency (low, middle and high channels). Once spurious emissions were identified, the power of the emission was determined using the substitution method.

The spurious emissions attenuation was calculated as the difference between radiated power at the fundamental frequency and the spurious emissions frequency.

$$\text{EIRP} = \text{S.G. output (dBm)} + \text{Antenna Gain(dBi)} - \text{Cable Loss (dB)}$$

9.4 Measurement Equipment Used:

EQUIPMENT TYPE	MFR	MODEL NUMBER	SERIAL NUMBER	LAST CAL.	CAL DUE.
Spectrum Analyzer	Agilent	E4446A	MY43360126	04/27/2007	04/26/2008
Spectrum Analyzer	Agilent	E7405A	US41160416	07/04/2007	07/03/2008
Communication Test	R&S	SMU200	N/A	N/A	N/A
Bi-log Antenna	SCHWAZBECK	VULB9160	3224	11/14/2006	11/13/2007
Horn antenna	SCHWAZBECK	BBHA 9120D	309/320	08/16/2007	08/15/2008
Pre-Amplifier	HP	8447D	2944A09469	07/19/2007	07/18/2008
Pre-Amplifier	HP	8494B	3008A00578	02/26/2007	02/25/2008
Signal Generator	R&S	SMR40	100210	02/09/2007	02/10/2008
Turn Table	HD	DT420	N/A	N.C.R	N.C.R
Antenna Tower	HD	MA240-N	240/657	N.C.R	N.C.R
Controller	HD	HD100	N/A	N.C.R	N.C.R
Low Loss Cable	HUBER+SUHNER	SUCOFLEX 104PEA-10M	10m	10/09/2007	10/08/2008
Low Loss Cable	HUBER+SUHNER	SUCOFLEX 104PEA-3M	3m	10/09/2007	10/08/2008
Low Loss Cable	HUBER+SUHNER	SUCOFLEX 104PEA-0.5M	0.5m	10/09/2007	10/08/2008
Site NSA	SGS	966 chamber	N/A	11/17/2006	11/16/2007
Attenuator	Mini-Circuit	BW-S10W5	N/A	09/23/2007	09/22/2008
Dipole Antenna	SCHWAZBECK	VHAP	908/909	06/09/2007	06/10/2008
Dipole Antenna	SCHWAZBECK	UHAP	891/892	06/09/2007	06/10/2008
Horn antenna	SCHWAZBECK	BBHA 9120D	N/A	08/16/2007	08/15/2008

9.5 Measurement Result

Refer to attach tabular data sheets.

Radiated Spurious Emission Measurement Result: GSM 850 Mode

Operation Mode	: TX CH Low H Mode	Test Date:	Jul. 11, 2007
Fundamental Frequency	: 824.20 MHz	Test By:	Jason
Temperature	: 25°C	Pol:	Ver
Humidity	: 65%		

Freq. (MHz)	SPA. Reading (dBuV)	Ant.Pol. H/V	S.G Output (dBm)	Antenna Gain (dB/dBi)	Cable Loss (dB)	ERP/EIRP (dBm)	Limit (dBm)	Safe Margin (dBm)
30.00	50.28	V	-54.42	-7.34	0.95	-62.71	-13.00	-49.71
101.78	45.03	V	-56.73	-7.76	1.37	-65.85	-13.00	-52.85
824.00	71.39	V	-15.00	-7.87	3.62	-26.50	-13.00	-13.50
1648.40	50.73	V	-53.85	9.29	5.23	-49.79	-13.00	-36.79
2472.60	50.47	V	-50.54	10.08	6.53	-46.99	-13.00	-33.99
3296.80	---	V		12.17	7.71		-13.00	
4121.00	45.33	V	-50.79	12.61	8.86	-47.04	-13.00	-34.04
4945.20	38.36	V	-54.11	12.65	9.74	-51.20	-13.00	-38.20
5769.40	39.10	V	-51.10	13.55	10.54	-48.08	-13.00	-35.08
6593.60	---	V		12.05	11.30		-13.00	
7417.80	---	V		11.49	12.10		-13.00	
8242.00	---	V		11.48	12.71		-13.00	

Measurement uncertainty	30MHz - 80MHz: 5.04dB
	80MHz - 1000MHz: 3.76dB
	1GHz - 13GHz: 4.45dB

Remark :

- 1 The emission behaviors belongs to narrowband spurious emission.
- 2 Remark"---" means that the emission level is too low to be measured
- 3 The result basic equation calculation is as follows:
- 4 $ERP/EIRP (dBm) = SG \text{ Setting}(dBm) + Antenna \text{ Gain} (dB/dBi) - Cable \text{ loss} (dB)$

Radiated Spurious Emission Measurement Result: GSM 850 Mode

Operation Mode	: TX CH Low H Mode	Test Date:	Jul. 11, 2007
Fundamental Frequency	: 824.20 MHz	Test By:	Jason
Temperature	: 25°C	Pol:	Hor
Humidity	: 65%		

Freq. (MHz)	SPA. Reading (dBuV)	Ant.Pol. H/V	S.G Out-put (dBm)	Antenna Gain (dB/dBi)	Cable Loss (dB)	ERP/EIRP (dBm)	Limit (dBm)	Safe Margin (dBm)
39.70	41.73	H	-61.16	-2.79	0.89	-64.85	-13.00	-51.85
101.78	44.66	H	-58.15	-7.76	1.37	-67.28	-13.00	-54.28
135.73	40.92	H	-58.34	-7.79	1.52	-67.66	-13.00	-54.66
824.00	78.14	H	-8.13	-7.87	3.62	-19.63	-13.00	-6.63
1648.40	53.31	H	-51.09	9.29	5.23	-47.03	-13.00	-34.03
2472.60	54.17	H	-46.74	10.08	6.53	-43.19	-13.00	-30.19
3296.80	---	H		12.17	7.71		-13.00	
4121.00	40.12	H	-56.13	12.61	8.86	-52.38	-13.00	-39.38
4945.20	---	H		12.65	9.74		-13.00	
5769.40	---	H		13.55	10.54		-13.00	
6593.60	---	H		12.05	11.30		-13.00	
7417.80	---	H		11.49	12.10		-13.00	
8242.00	---	H		11.48	12.71		-13.00	

Measurement uncertainty	30MHz - 80MHz: 5.04dB
	80MHz -1000MHz: 3.76dB
	1GHz - 13GHz: 4.45dB

Remark :

- 1 The emission behaviors belong to narrowband spurious emission.
- 2 Remark"---" means that the emission level is too low to be measured
- 3 The result basic equation calculation is as follows:
- 4 $ERP/EIRP (dBm) = SG \text{ Setting}(dBm) + Antenna \text{ Gain} (dB/dBi) - Cable \text{ loss} (dB)$

Radiated Spurious Emission Measurement Result: GSM 850 Mode

Operation Mode	: TX CH Mid H Mode	Test Date:	Jul. 11, 2007
Fundamental Frequency	: 836.60 MHz	Test By:	Jason
Temperature	: 25°C	Pol:	Ver
Humidity	: 65%		

Freq. (MHz)	SPA. Reading (dBuV)	Ant.Pol. H/V	S.G Output (dBm)	Antenna Gain (dB/dBi)	Cable Loss (dB)	ERP/EIRP (dBm)	Limit (dBm)	Safe Margin (dBm)
30.00	50.27	V	-54.43	-7.34	0.95	-62.72	-13.00	-49.72
38.73	42.33	V	-59.84	-3.25	0.90	-63.98	-13.00	-50.98
51.34	44.23	V	-63.35	-0.58	1.12	-65.05	-13.00	-52.05
101.78	44.30	V	-57.46	-7.76	1.37	-66.58	-13.00	-53.58
1673.20	51.48	V	-53.08	9.36	5.27	-48.98	-13.00	-35.98
2509.80	50.12	V	-50.66	10.09	6.58	-47.16	-13.00	-34.16
3346.40	42.87	V	-55.99	12.28	7.79	-51.51	-13.00	-38.51
4183.00	43.57	V	-52.32	12.62	8.93	-48.63	-13.00	-35.63
5019.60	---	V		12.67	9.81		-13.00	
5856.20	---	V		13.68	10.62		-13.00	
6692.80	36.56	V	-48.46	11.95	11.39	-47.90	-13.00	-34.90
7529.40	39.01	V	-41.64	11.45	12.20	-42.39	-13.00	-29.39
8366.00	---	V		11.59	12.81		-13.00	

Measurement uncertainty	30MHz - 80MHz: 5.04dB
	80MHz - 1000MHz: 3.76dB
	1GHz - 13GHz: 4.45dB

Remark :

- 1 The emission behaviors belong to narrowband spurious emission.
- 2 Remark"---" means that the emission level is too low to be measured
- 3 The result basic equation calculation is as follows:
- 4 $ERP/EIRP (dBm) = SG \text{ Setting}(dBm) + Antenna \text{ Gain} (dB/dBi) - Cable \text{ loss} (dB)$

Radiated Spurious Emission Measurement Result: GSM 850 Mode

Operation Mode	: TX CH Mid H Mode	Test Date:	Jul. 11, 2007
Fundamental Frequency	: 836.60 MHz	Test By:	Jason
Temperature	: 25°C	Pol:	Hor
Humidity	: 65%		

Freq. (MHz)	SPA. Reading (dBuV)	Ant.Pol. H/V	S.G Output (dBm)	Antenna Gain (dB/dBi)	Cable Loss (dB)	ERP/EIRP (dBm)	Limit (dBm)	Safe Margin (dBm)
39.70	41.24	H	-61.65	-2.79	0.89	-65.34	-13.00	-52.34
101.78	44.03	H	-58.78	-7.76	1.37	-67.91	-13.00	-54.91
135.73	40.11	H	-59.15	-7.79	1.52	-68.47	-13.00	-55.47
1673.20	52.85	H	-51.53	9.36	5.27	-47.43	-13.00	-34.43
2509.80	59.20	H	-41.50	10.09	6.58	-38.00	-13.00	-25.00
3346.40	39.63	H	-59.43	12.28	7.79	-54.95	-13.00	-41.95
4183.00	40.89	H	-55.14	12.62	8.93	-51.45	-13.00	-38.45
5019.60	---	H		12.67	9.81		-13.00	
5856.20	---	H		13.68	10.62		-13.00	
6692.80	---	H		11.95	11.39		-13.00	
7529.40	---	H		11.45	12.20		-13.00	
8366.00	---	H		11.59	12.81		-13.00	

Measurement uncertainty	30MHz - 80MHz: 5.04dB
	80MHz - 1000MHz: 3.76dB
	1GHz - 13GHz: 4.45dB

Remark :

- 1 The emission behaviors belong to narrowband spurious emission.
- 2 Remark"---" means that the emission level is too low to be measured
- 3 The result basic equation calculation is as follows:
- 4 $ERP/EIRP (dBm) = SG \text{ Setting}(dBm) + Antenna \text{ Gain} (dB/dBi) - Cable \text{ loss} (dB)$

Radiated Spurious Emission Measurement Result: GSM 850 Mode

Operation Mode	: TX CH High H Mode	Test Date:	Jul. 11, 2007
Fundamental Frequency	: 848.80 MHz	Test By:	Jason
Temperature	: 25°C	Pol:	Ver
Humidity	: 65%		

Freq. (MHz)	SPA. Reading (dBuV)	Ant.Pol. H/V	S.G Output (dBm)	Antenna Gain (dB/dBi)	Cable Loss (dB)	ERP/EIRP (dBm)	Limit (dBm)	Safe Margin (dBm)
30.00	51.34	V	-53.36	-7.34	0.95	-61.65	-13.00	-48.65
38.73	43.02	V	-59.15	-3.25	0.90	-63.29	-13.00	-50.29
48.43	43.24	V	-62.94	-0.92	1.09	-64.96	-13.00	-51.96
101.78	42.85	V	-58.91	-7.76	1.37	-68.03	-13.00	-55.03
849.02	75.12	V	-11.00	-7.88	3.68	-22.56	-13.00	-9.56
1697.60	50.64	V	-53.90	9.44	5.31	-49.77	-13.00	-36.77
2546.40	5.65	V	-94.99	10.20	6.63	-91.43	-13.00	-78.43
3395.20	45.72	V	-53.13	12.38	7.87	-48.62	-13.00	-35.62
4244.00	42.44	V	-53.22	12.63	9.00	-49.59	-13.00	-36.59
5092.80	---	V		12.74	9.88		-13.00	
5941.60	36.42	V	-53.27	13.81	10.70	-50.16	-13.00	-37.16
6790.40	---	V		11.86	11.48		-13.00	
7639.20	40.44	V	-40.04	11.40	12.27	-40.91	-13.00	-27.91
8488.00	---	V		11.70	12.91		-13.00	

Measurement uncertainty	30MHz - 80MHz: 5.04dB
	80MHz - 1000MHz: 3.76dB
	1GHz - 13GHz: 4.45dB

Remark :

- 1 The emission behaviors belong to narrowband spurious emission.
- 2 Remark"---" means that the emission level is too low to be measured
- 3 The result basic equation calculation is as follows:
- 4 $ERP/EIRP (dBm) = SG \text{ Setting}(dBm) + Antenna \text{ Gain} (dB/dBi) - Cable \text{ loss} (dB)$

Radiated Spurious Emission Measurement Result: GSM 850 Mode

Operation Mode	: TX CH High H Mode	Test Date:	Jul. 11, 2007
Fundamental Frequency	: 848.80 MHz	Test By:	Jason
Temperature	: 25°C	Pol:	Hor
Humidity	: 65%		

Freq. (MHz)	SPA. Reading (dBuV)	Ant.Pol. H/V	S.G Out-put (dBm)	Antenna Gain (dB/dBi)	Cable Loss (dB)	ERP/EIRP (dBm)	Limit (dBm)	Safe Margin (dBm)
39.70	40.54	H	-62.35	-2.79	0.89	-66.04	-13.00	-53.04
101.78	44.18	H	-58.63	-7.76	1.37	-67.76	-13.00	-54.76
135.73	39.90	H	-59.36	-7.79	1.52	-68.68	-13.00	-55.68
849.00	81.90	H	-4.29	-7.88	3.68	-15.85	-13.00	-2.85
1697.60	55.96	H	-48.39	9.44	5.31	-44.26	-13.00	-31.26
2546.40	61.12	H	-39.48	10.20	6.63	-35.92	-13.00	-22.92
3395.20	43.23	H	-55.80	12.38	7.87	-51.28	-13.00	-38.28
4244.00	---	H		12.63	9.00		-13.00	
5092.80	---	H		12.74	9.88		-13.00	
5941.60	---	H		13.81	10.70		-13.00	
6790.40	---	H		11.86	11.48		-13.00	
7639.20	---	H		11.40	12.27		-13.00	
8488.00	---	H		11.70	12.91		-13.00	

Measurement uncertainty	30MHz - 80MHz: 5.04dB
	80MHz -1000MHz: 3.76dB
	1GHz - 13GHz: 4.45dB

Remark :

- 1 The emission behaviors belong to narrowband spurious emission.
- 2 Remark"---" means that the emission level is too low to be measured
- 3 The result basic equation calculation is as follows:
- 4 $ERP/EIRP (dBm) = SG \text{ Setting}(dBm) + Antenna \text{ Gain} (dB/dBi) - Cable \text{ loss} (dB)$

Radiated Spurious Emission Measurement Result: PCS 1900 Mode

Operation Mode	: TX CH Low E2 Mode	Test Date:	Jul. 11, 2007
Fundamental Frequency	: 1850.20MHz	Test By:	Jason
Temperature	: 25°C	Pol:	Ver
Humidity	: 65%		

Freq. (MHz)	SPA. Reading (dBuV)	Ant.Pol. H/V	S.G Out-put (dBm)	Antenna Gain (dB/dBi)	Cable Loss (dB)	ERP/EIRP (dBm)	Limit (dBm)	Safe Margin (dBm)
30.00	50.54	V	-54.16	-7.34	0.95	-62.45	-13.00	-49.45
56.19	45.66	V	-64.00	-0.51	1.09	-65.61	-13.00	-52.61
101.78	44.42	V	-57.34	-7.76	1.37	-66.46	-13.00	-53.46
1849.98	82.35	V	-22.04	9.90	5.56	-17.70	-13.00	-4.70
3700.40	49.97	V	-47.96	12.61	8.31	-43.66	-13.00	-30.66
5550.60	54.38	V	-36.46	13.23	10.33	-33.56	-13.00	-20.56
7400.80	---	V		11.50	12.08		-13.00	
9251.00	---	V		11.92	13.50		-13.00	
11101.20	---	V		11.66	15.11		-13.00	
12951.40	---	V		13.63	16.60		-13.00	
14801.60	---	V		12.76	17.95		-13.00	
16651.80	---	V		15.92	19.14		-13.00	
18502.00	---	V		18.75	10.40		-13.00	

Measurement uncertainty	30MHz - 80MHz: 5.04dB
	80MHz -1000MHz: 3.76dB
	1GHz - 13GHz: 4.45dB

Remark :

- 1 The emission behaviors belong to narrowband spurious emission.
- 2 Remark"---" means that the emission level is too low to be measured
- 3 The result basic equation calculation is as follows:
- 4 $ERP/EIRP (dBm) = SG \text{ Setting}(dBm) + Antenna \text{ Gain} (dB/dBi) - Cable \text{ loss} (dB)$

Radiated Spurious Emission Measurement Result: PCS 1900 Mode

Operation Mode	: TX CH Low E2 Mode	Test Date:	Jul. 11, 2007
Fundamental Frequency	: 1850.20MHz	Test By:	Jason
Temperature	: 25°C	Pol:	Hor
Humidity	: 65%		

Freq. (MHz)	SPA. Reading (dBuV)	Ant.Pol. H/V	S.G Out-put (dBm)	Antenna Gain (dB/dBi)	Cable Loss (dB)	ERP/EIRP (dBm)	Limit (dBm)	Safe Margin (dBm)
40.67	40.93	H	-62.16	-2.51	0.91	-65.58	-13.00	-52.58
101.78	44.46	H	-58.35	-7.76	1.37	-67.48	-13.00	-54.48
135.73	41.09	H	-58.17	-7.79	1.52	-67.49	-13.00	-54.49
1849.99	84.39	H	-19.79	9.90	5.56	-15.45	-13.00	-2.45
3700.40	52.04	H	-46.00	12.61	8.31	-41.70	-13.00	-28.70
5550.60	58.66	H	-32.39	13.23	10.33	-29.49	-13.00	-16.49
7400.80	---	H		11.50	12.08		-13.00	
9251.00	---	H		11.92	13.50		-13.00	
11101.20	---	H		11.66	15.11		-13.00	
12951.40	---	H		13.63	16.60		-13.00	
14801.60	---	H		12.76	17.95		-13.00	
16651.80	---	H		15.92	19.14		-13.00	
18502.00	---	H		18.75	10.40		-13.00	

Measurement uncertainty	30MHz - 80MHz: 5.04dB
	80MHz -1000MHz: 3.76dB
	1GHz - 13GHz: 4.45dB

Remark :

- 1 The emission behaviors belong to narrowband spurious emission.
- 2 Remark”---“ means that the emission level is too low to be measured
- 3 The result basic equation calculation is as follows:
- 4 $ERP/EIRP (dBm) = SG \text{ Setting}(dBm) + Antenna \text{ Gain} (dB/dBi) - Cable \text{ loss} (dB)$

Radiated Spurious Emission Measurement Result: PCS 1900 Mode

Operation Mode	: TX CH Mid E2 Mode	Test Date:	Jul. 11, 2007
Fundamental Frequency	: 1880MHz	Test By:	Jason
Temperature	: 25°C	Pol:	Ver
Humidity	: 65%		

Freq. (MHz)	SPA Reading (dBuV)	Ant.Pol. H/V	S.G Output (dBm)	Antenna Gain (dB/dBi)	Cable Loss (dB)	ERP/EIRP (dBm)	Limit (dBm)	Safe Margin (dBm)
30.00	50.01	V	-54.69	-7.34	0.95	-62.98	-13.00	-49.98
38.73	42.43	V	-59.74	-3.25	0.90	-63.88	-13.00	-50.88
53.28	45.32	V	-63.09	-0.55	1.11	-64.75	-13.00	-51.75
3760.00	50.43	V	-47.23	12.60	8.39	-43.01	-13.00	-30.01
5640.00	47.51	V	-43.07	13.36	10.41	-40.12	-13.00	-27.12
7520.00	---	V		11.45	12.19		-13.00	
9400.00	---	V		11.93	13.61		-13.00	
11280.00	---	V		11.92	15.27		-13.00	
13160.00	---	V		13.33	16.71		-13.00	
15040.00	---	V		13.76	18.15		-13.00	
16920.00	---	V		15.27	19.32		-13.00	
18800.00	---	V		18.68	16.58		-13.00	

Measurement uncertainty	30MHz - 80MHz: 5.04dB
	80MHz - 1000MHz: 3.76dB
	1GHz - 13GHz: 4.45dB

Remark :

- 1 The emission behaviors belong to narrowband spurious emission.
- 2 Remark"---" means that the emission level is too low to be measured
- 3 The result basic equation calculation is as follows:
- 4 $ERP/EIRP (dBm) = SG \text{ Setting}(dBm) + Antenna \text{ Gain} (dB/dBi) - Cable \text{ loss} (dB)$

Radiated Spurious Emission Measurement Result: PCS 1900 Mode

Operation Mode	: TX CH Mid E2 Mode	Test Date:	Jul. 11, 2007
Fundamental Frequency	: 1880MHz	Test By:	Jason
Temperature	: 25°C	Pol:	Hor
Humidity	: 65%		

Freq. (MHz)	SPA. Reading (dBuV)	Ant.Pol. H/V	S.G Output (dBm)	Antenna Gain (dB/dBi)	Cable Loss (dB)	ERP/EIRP (dBm)	Limit (dBm)	Safe Margin (dBm)
40.67	40.76	H	-62.33	-2.51	0.91	-65.75	-13.00	-52.75
101.78	45.70	H	-57.11	-7.76	1.37	-66.24	-13.00	-53.24
133.79	41.59	H	-57.88	-7.79	1.52	-67.18	-13.00	-54.18
3760.00	53.58	H	-44.19	12.60	8.39	-39.98	-13.00	-26.98
5640.00	49.26	H	-41.49	13.36	10.41	-38.54	-13.00	-25.54
7520.00	---	H		11.45	12.19		-13.00	
9400.00	---	H		11.93	13.61		-13.00	
11280.00	---	H		11.92	15.27		-13.00	
13160.00	---	H		13.33	16.71		-13.00	
15040.00	---	H		13.76	18.15		-13.00	
16920.00	---	H		15.27	19.32		-13.00	
18800.00	---	H		18.68	16.58		-13.00	

Measurement uncertainty	30MHz - 80MHz: 5.04dB
	80MHz - 1000MHz: 3.76dB
	1GHz - 13GHz: 4.45dB

Remark :

- 1 The emission behaviors belong to narrowband spurious emission.
- 2 Remark"---" means that the emission level is too low to be measured
- 3 The result basic equation calculation is as follows:
- 4 $ERP/EIRP (dBm) = SG \text{ Setting}(dBm) + Antenna \text{ Gain} (dB/dBi) - Cable \text{ loss} (dB)$

Radiated Spurious Emission Measurement Result: PCS 1900 Mode

Operation Mode	: TX CH High E2 Mode	Test Date:	Jul. 11, 2007
Fundamental Frequency	: 1909.8 MHz	Test By:	Jason
Temperature	: 25°C	Pol:	Ver
Humidity	: 65%		

Freq. (MHz)	SPA Reading (dBuV)	Ant.Pol. H/V	S.G Output (dBm)	Antenna Gain (dB/dBi)	Cable Loss (dB)	ERP/EIRP (dBm)	Limit (dBm)	Safe Margin (dBm)
30.00	50.02	V	-54.68	-7.34	0.95	-62.97	-13.00	-49.97
39.70	41.82	V	-60.07	-2.79	0.89	-63.75	-13.00	-50.75
56.19	46.08	V	-63.58	-0.51	1.09	-65.19	-13.00	-52.19
101.78	45.24	V	-56.52	-7.76	1.37	-65.64	-13.00	-52.64
1910.02	80.87	V	-23.46	10.08	5.66	-19.04	-13.00	-6.04
3981.60	53.26	V	-43.40	12.60	8.69	-39.50	-13.00	-26.50
5972.40	46.62	V	-42.98	13.86	10.73	-39.86	-13.00	-26.86
7963.20	---	V		11.27	12.49		-13.00	
9954.00	---	V		12.08	14.24		-13.00	
11944.80	---	V		13.08	15.87		-13.00	
13935.60	---	V		11.82	17.21		-13.00	
15926.40	---	V		17.08	18.70		-13.00	
17917.20	---	V		9.63	19.97		-13.00	
19908.00	---	V		18.88	21.24		-13.00	

Measurement uncertainty	30MHz - 80MHz: 5.04dB
	80MHz -1000MHz: 3.76dB
	1GHz - 13GHz: 4.45dB

Remark :

- 1 The emission behaviors belong to narrowband spurious emission.
- 2 Remark"---" means that the emission level is too low to be measured
- 3 The result basic equation calculation is as follows:
- 4 $ERP/EIRP (dBm) = SG \text{ Setting}(dBm) + Antenna \text{ Gain} (dB/dBi) - Cable \text{ loss} (dB)$

Radiated Spurious Emission Measurement Result: PCS 1900 Mode

Operation Mode	: TX CH High E2 Mode	Test Date:	Jul. 11, 2007
Fundamental Frequency	: 1909.8 MHz	Test By:	Jason
Temperature	: 25°C	Pol:	Hor
Humidity	: 65%		

Freq. (MHz)	SPA Reading (dBuV)	Ant.Pol. H/V	S.G Output (dBm)	Antenna Gain (dB/dBi)	Cable Loss (dB)	ERP/EIRP (dBm)	Limit (dBm)	Safe Margin (dBm)
40.67	41.58	H	-61.51	-2.51	0.91	-64.93	-13.00	-51.93
101.78	46.27	H	-56.54	-7.76	1.37	-65.67	-13.00	-52.67
135.73	41.60	H	-57.66	-7.79	1.52	-66.98	-13.00	-53.98
1910.02	81.98	H	-22.13	10.08	5.66	-17.71	-13.00	-4.71
3981.60	54.22	H	-42.55	12.60	8.69	-38.65	-13.00	-25.65
5972.40	43.83	H	-45.80	13.86	10.73	-42.68	-13.00	-29.68
7963.20	---	H		11.27	12.49		-13.00	
9954.00	---	H		12.08	14.24		-13.00	
11944.80	---	H		13.08	15.87		-13.00	
13935.60	---	H		11.82	17.21		-13.00	
15926.40	---	H		17.08	18.70		-13.00	
17917.20	---	H		9.63	19.97		-13.00	
17188.20	---	H		14.47	19.52		-13.00	

Measurement uncertainty	30MHz - 80MHz: 5.04dB
	80MHz -1000MHz: 3.76dB
	1GHz - 13GHz: 4.45dB

Remark :

- 1 The emission behaviors belong to narrowband spurious emission.
- 2 Remark"---" means that the emission level is too low to be measured
- 3 The result basic equation calculation is as follows:
- 4 $ERP/EIRP (dBm) = SG \text{ Setting}(dBm) + Antenna \text{ Gain} (dB/dBi) - Cable \text{ loss} (dB)$

Radiated Spurious Emission Measurement Result: WCDMA BAND II Mode

Operation Mode	: TX CH Low H Mode	Test Date:	Jul. 11, 2007
Fundamental Frequency	: 1852.40MHz	Test By:	Jason
Temperature	: 25°C	Pol:	Ver
Humidity	: 65%		

Freq. (MHz)	SPA Reading (dBuV)	Ant.Pol. H/V	S.G Output (dBm)	Antenna Gain (dB/dBi)	Cable Loss (dB)	ERP/EIRP (dBm)	Limit (dBm)	Safe Margin (dBm)
36.79	46.71	V	-56.02	-4.16	0.91	-61.09	-13.00	-48.09
153.19	32.33	V	-65.25	-7.80	1.60	-74.65	-13.00	-61.65
1850.00	81.86	V	-22.53	9.90	5.56	-18.19	-13.00	-5.19
3700.40	---	V		12.61	8.31		-13.00	
5550.60	---	V		13.23	10.33		-13.00	
7400.80	---	V		11.50	12.08		-13.00	
9251.00	---	V		11.92	13.50		-13.00	
11101.20	---	V		11.66	15.11		-13.00	
12951.40	---	V		13.63	16.60		-13.00	
14801.60	---	V		12.76	17.95		-13.00	
16651.80	---	V		15.92	19.14		-13.00	
18502.00	---	V		18.75	10.40		-13.00	

Measurement uncertainty	30MHz - 80MHz: 5.04dB
	80MHz -1000MHz: 3.76dB
	1GHz - 13GHz: 4.45dB

Remark :

- 1 The emission behaviors belong to narrowband spurious emission.
- 2 Remark"---" means that the emission level is too low to be measured
- 3 The result basic equation calculation is as follows:
- 4 $ERP/EIRP (dBm) = SG \text{ Setting}(dBm) + Antenna \text{ Gain} (dB/dBi) - Cable \text{ loss} (dB)$

Radiated Spurious Emission Measurement Result: WCDMA BAND II Mode

Operation Mode	: TX CH Low H Mode	Test Date:	Jul. 11, 2007
Fundamental Frequency	: 1852.40MHz	Test By:	Jason
Temperature	: 25°C	Pol:	Hor
Humidity	: 65%		

Freq. (MHz)	SPA Reading (dBuV)	Ant.Pol. H/V	S.G Output (dBm)	Antenna Gain (dB/dBi)	Cable Loss (dB)	ERP/EIRP (dBm)	Limit (dBm)	Safe Margin (dBm)
40.67	42.06	H	-61.03	-2.51	0.91	-64.45	-13.00	-51.45
101.78	47.09	H	-55.72	-7.76	1.37	-64.85	-13.00	-51.85
1850.00	86.29	H	-17.89	9.90	5.56	-13.55	-13.00	-0.55
3700.40	---	H		12.61	8.31		-13.00	
5550.60	---	H		13.23	10.33		-13.00	
7400.80	---	H		11.50	12.08		-13.00	
9251.00	---	H		11.92	13.50		-13.00	
11101.20	---	H		11.66	15.11		-13.00	
12951.40	---	H		13.63	16.60		-13.00	
14801.60	---	H		12.76	17.95		-13.00	
16651.80	---	H		15.92	19.14		-13.00	
18502.00	---	H		18.75	10.40		-13.00	

Measurement uncertainty	30MHz - 80MHz: 5.04dB
	80MHz - 1000MHz: 3.76dB
	1GHz - 13GHz: 4.45dB

Remark :

- 1 The emission behaviors belong to narrowband spurious emission.
- 2 Remark"---" means that the emission level is too low to be measured
- 3 The result basic equation calculation is as follows:
- 4 $ERP/EIRP (dBm) = SG \text{ Setting}(dBm) + Antenna \text{ Gain} (dB/dBi) - Cable \text{ loss} (dB)$

Radiated Spurious Emission Measurement Result: WCDMA BAND II Mode

Operation Mode	: TX CH Mid H Mode	Test Date:	Jul. 11, 2007
Fundamental Frequency	: 1880MHz	Test By:	Jason
Temperature	: 25°C	Pol:	Ver
Humidity	: 65%		

Freq. (MHz)	SPA Reading (dBuV)	Ant.Pol. H/V	S.G Output (dBm)	Antenna Gain (dB/dBi)	Cable Loss (dB)	ERP/EIRP (dBm)	Limit (dBm)	Safe Margin (dBm)
101.78	45.00	V	-56.76	-7.76	1.37	-65.88	-13.00	-52.88
3408.00	36.64	V	-62.21	12.41	7.89	-57.69	-13.00	-44.69
3760.00	---	V		12.60	8.39		-13.00	
5640.00	---	V		13.36	10.41		-13.00	
7520.00	---	V		11.45	12.19		-13.00	
9400.00	---	V		11.93	13.61		-13.00	
11280.00	---	V		11.92	15.27		-13.00	
13160.00	---	V		13.33	16.71		-13.00	
15040.00	---	V		13.76	18.15		-13.00	
16920.00	---	V		15.27	19.32		-13.00	
18800.00	---	V		18.68	16.58		-13.00	

Measurement uncertainty	30MHz - 80MHz: 5.04dB
	80MHz -1000MHz: 3.76dB
	1GHz - 13GHz: 4.45dB

Remark :

- 1 The emission behaviors belong to narrowband spurious emission.
- 2 Remark"---" means that the emission level is too low to be measured
- 3 The result basic equation calculation is as follows:
- 4 $ERP/EIRP (dBm) = SG \text{ Setting}(dBm) + Antenna \text{ Gain} (dB/dBi) - Cable \text{ loss} (dB)$

Radiated Spurious Emission Measurement Result: WCDMA BAND II Mode

Operation Mode	: TX CH Mid H Mode	Test Date:	Jul. 11, 2007
Fundamental Frequency	: 1880MHz	Test By:	Jason
Temperature	: 25°C	Pol:	Hor
Humidity	: 65%		

Freq. (MHz)	SPA. Reading (dBuV)	Ant.Pol. H/V	S.G Output (dBm)	Antenna Gain (dB/dBi)	Cable Loss (dB)	ERP/EIRP (dBm)	Limit (dBm)	Safe Margin (dBm)
397.63	37.35	H	-59.12	-7.66	2.50	-69.28	-13.00	-56.28
2939.00	37.76	H	-61.72	11.34	7.17	-57.55	-13.00	-44.55
3760.00	---	H		12.60	8.39		-13.00	
5640.00	---	H		13.36	10.41		-13.00	
7520.00	---	H		11.45	12.19		-13.00	
9400.00	---	H		11.93	13.61		-13.00	
11280.00	---	H		11.92	15.27		-13.00	
13160.00	---	H		13.33	16.71		-13.00	
15040.00	---	H		13.76	18.15		-13.00	
16920.00	---	H		15.27	19.32		-13.00	
18800.00	---	H		18.68	16.58		-13.00	

Measurement uncertainty	30MHz - 80MHz: 5.04dB
	80MHz -1000MHz: 3.76dB
	1GHz - 13GHz: 4.45dB

Remark :

- 1 The emission behaviors belong to narrowband spurious emission.
- 2 Remark"---" means that the emission level is too low to be measured
- 3 The result basic equation calculation is as follows:
- 4 $ERP/EIRP (dBm) = SG \text{ Setting}(dBm) + Antenna \text{ Gain} (dB/dBi) - Cable \text{ loss} (dB)$

Radiated Spurious Emission Measurement Result: WCDMA BAND II Mode

Operation Mode	: TX CH High H Mode	Test Date:	Jul. 11, 2007
Fundamental Frequency	: 1907.6 MHz	Test By:	Jason
Temperature	: 25°C	Pol:	Ver
Humidity	: 65%		

Freq. (MHz)	SPA Reading (dBuV)	Ant.Pol. H/V	S.G Output (dBm)	Antenna Gain (dB/dBi)	Cable Loss (dB)	ERP/EIRP (dBm)	Limit (dBm)	Safe Margin (dBm)
36.79	46.71	V	-56.02	-4.16	0.91	-61.09	-13.00	-48.09
58.13	42.41	V	-68.09	-0.49	1.08	-69.65	-13.00	-56.65
1910.00	75.19	V	-29.14	10.08	5.66	-24.72	-13.00	-11.72
3981.60	---	V		12.60	8.69		-13.00	
5972.40	---	V		13.86	10.73		-13.00	
7963.20	---	V		11.27	12.49		-13.00	
9954.00	---	V		12.08	14.24		-13.00	
11944.80	---	V		13.08	15.87		-13.00	
13935.60	---	V		11.82	17.21		-13.00	
15926.40	---	V		17.08	18.70		-13.00	
17917.20	---	V		9.63	19.97		-13.00	
19908.00	---	V		18.88	21.24		-13.00	

Measurement uncertainty	30MHz - 80MHz: 5.04dB
	80MHz -1000MHz: 3.76dB
	1GHz - 13GHz: 4.45dB

Remark :

- 1 The emission behaviors belong to narrowband spurious emission.
- 2 Remark"---" means that the emission level is too low to be measured
- 3 The result basic equation calculation is as follows:
- 4 $ERP/EIRP (dBm) = SG \text{ Setting}(dBm) + Antenna \text{ Gain} (dB/dBi) - Cable \text{ loss} (dB)$

Radiated Spurious Emission Measurement Result: WCDMA BAND II Mode

Operation Mode	: TX CH High H Mode	Test Date:	Jul. 11, 2007
Fundamental Frequency	: 1907.6 MHz	Test By:	Jason
Temperature	: 25°C	Pol:	Hor
Humidity	: 65%		

Freq. (MHz)	SPA. Reading (dBuV)	Ant.Pol. H/V	S.G Output (dBm)	Antenna Gain (dB/dBi)	Cable Loss (dB)	ERP/EIRP (dBm)	Limit (dBm)	Safe Margin (dBm)
40.67	42.06	H	-61.03	-2.51	0.91	-64.45	-13.00	-51.45
1910.00	82.91	H	-21.20	10.08	5.66	-16.78	-13.00	-3.78
3981.60	---	H		12.60	8.69		-13.00	
5972.40	---	H		13.86	10.73		-13.00	
7963.20	---	H		11.27	12.49		-13.00	
9954.00	---	H		12.08	14.24		-13.00	
11944.80	---	H		13.08	15.87		-13.00	
13935.60	---	H		11.82	17.21		-13.00	
15926.40	---	H		17.08	18.70		-13.00	
17917.20	---	H		9.63	19.97		-13.00	
19908.00	---	H		18.88	21.24		-13.00	

Measurement uncertainty	30MHz - 80MHz: 5.04dB
	80MHz - 1000MHz: 3.76dB
	1GHz - 13GHz: 4.45dB

Remark :

- 1 The emission behaviors belong to narrowband spurious emission.
- 2 Remark”---“ means that the emission level is too low to be measured
- 3 The result basic equation calculation is as follows:
- 4 $ERP/EIRP (dBm) = SG \text{ Setting}(dBm) + Antenna \text{ Gain} (dB/dBi) - Cable \text{ loss} (dB)$

Radiated Spurious Emission Measurement Result: WCDMA BAND V Mode

Operation Mode	: TX CH Low H Mode	Test Date:	Jul. 11, 2007
Fundamental Frequency	: 826.4MHz	Test By:	Jason
Temperature	: 25°C	Pol:	Ver
Humidity	: 65%		

Freq. (MHz)	SPA. Reading (dBuV)	Ant.Pol. H/V	S.G Output (dBm)	Antenna Gain (dB/dBi)	Cable Loss (dB)	ERP/EIRP (dBm)	Limit (dBm)	Safe Margin (dBm)
36.79	46.11	V	-56.62	-4.16	0.91	-61.69	-13.00	-48.69
101.78	43.30	V	-58.46	-7.76	1.37	-67.58	-13.00	-54.58
824.00	81.47	V	-4.92	-7.87	3.62	-16.42	-13.00	-3.42
1434.00	41.75	V	-63.26	8.46	4.32	-59.12	-13.00	-46.12
1648.40	---	V		9.29	5.23		-13.00	
2472.60	---	V		10.08	6.53		-13.00	
3296.80	---	V		12.17	7.71		-13.00	
4121.00	---	V		12.61	8.86		-13.00	
4945.20	---	V		12.65	9.74		-13.00	
5769.40	---	V		13.55	10.54		-13.00	
6593.60	---	V		12.05	11.30		-13.00	
7417.80	---	V		11.49	12.10		-13.00	
8242.00	---	V		11.48	12.71		-13.00	
Measurement uncertainty	30MHz - 80MHz: 5.04dB							
	80MHz -1000MHz: 3.76dB							
	1GHz - 13GHz: 4.45dB							

Remark :

- 1 The emission behaviors belong to narrowband spurious emission.
- 2 Remark"---" means that the emission level is too low to be measured
- 3 The result basic equation calculation is as follows:
- 4 $ERP/EIRP (dBm) = SG \text{ Setting}(dBm) + Antenna \text{ Gain} (dB/dBi) - Cable \text{ loss} (dB)$

Radiated Spurious Emission Measurement Result: WCDMA BAND V Mode

Operation Mode	: TX CH Low H Mode	Test Date:	Jul. 11, 2007
Fundamental Frequency	: 826.4MHz	Test By:	Jason
Temperature	: 25°C	Pol:	Hor
Humidity	: 65%		

Freq. (MHz)	SPA. Reading (dBuV)	Ant.Pol. H/V	S.G Output (dBm)	Antenna Gain (dB/dBi)	Cable Loss (dB)	ERP/EIRP (dBm)	Limit (dBm)	Safe Margin (dBm)
39.70	41.97	H	-60.92	-2.79	0.89	-64.61	-13.00	-51.61
824.00	82.11	H	-4.16	-7.87	3.62	-15.66	-13.00	-2.66
1378.00	44.54	H	-60.59	8.14	3.76	-56.21	-13.00	-43.21
1648.40	---	H		9.29	5.23		-13.00	
2472.60	---	H		10.08	6.53		-13.00	
3296.80	---	H		12.17	7.71		-13.00	
4121.00	---	H		12.61	8.86		-13.00	
4945.20	---	H		12.65	9.74		-13.00	
5769.40	---	H		13.55	10.54		-13.00	
6593.60	---	H		12.05	11.30		-13.00	
7417.80	---	H		11.49	12.10		-13.00	
8242.00	---	H		11.48	12.71		-13.00	
Measurement uncertainty	30MHz - 80MHz: 5.04dB							
	80MHz - 1000MHz: 3.76dB							
	1GHz - 13GHz: 4.45dB							

Remark :

- 1 The emission behaviors belong to narrowband spurious emission.
- 2 Remark"---" means that the emission level is too low to be measured
- 3 The result basic equation calculation is as follows:
- 4 $ERP/EIRP (dBm) = SG \text{ Setting}(dBm) + Antenna \text{ Gain} (dB/dBi) - Cable \text{ loss} (dB)$

Radiated Spurious Emission Measurement Result: WCDMA BAND V Mode

Operation Mode	: TX CH Mid H Mode	Test Date:	Jul. 11, 2007
Fundamental Frequency	: 836.0MHz	Test By:	Jason
Temperature	: 25°C	Pol:	Ver
Humidity	: 65%		

Freq. (MHz)	SPA. Reading (dBuV)	Ant.Pol. H/V	S.G Output (dBm)	Antenna Gain (dB/dBi)	Cable Loss (dB)	ERP/EIRP (dBm)	Limit (dBm)	Safe Margin (dBm)
106.63	43.60	V	-57.71	-7.77	1.39	-66.86	-13.00	-53.86
1378.00	43.12	V	-62.12	8.14	3.76	-57.75	-13.00	-44.75
1673.20	---	V		9.36	5.27		-13.00	
2509.80	---	V		10.09	6.58		-13.00	
3346.40	---	V		12.28	7.79		-13.00	
4183.00	---	V		12.62	8.93		-13.00	
5019.60	---	V		12.67	9.81		-13.00	
5856.20	---	V		13.68	10.62		-13.00	
6692.80	---	V		11.95	11.39		-13.00	
7529.40	---	V		11.45	12.20		-13.00	
8366.00	---	V		11.59	12.81		-13.00	

Measurement uncertainty	30MHz - 80MHz: 5.04dB
	80MHz -1000MHz: 3.76dB
	1GHz - 13GHz: 4.45dB

Remark :

- 1 The emission behaviors belong to narrowband spurious emission.
- 2 Remark"---" means that the emission level is too low to be measured
- 3 The result basic equation calculation is as follows:
- 4 $ERP/EIRP (dBm) = SG \text{ Setting}(dBm) + Antenna \text{ Gain} (dB/dBi) - Cable \text{ loss} (dB)$

Radiated Spurious Emission Measurement Result: WCDMA BAND V Mode

Operation Mode	: TX CH Mid H Mode	Test Date:	Jul. 11, 2007
Fundamental Frequency	: 836.0MHz	Test By:	Jason
Temperature	: 25°C	Pol:	Hor
Humidity	: 65%		

Freq. (MHz)	SPA. Reading (dBuV)	Ant.Pol. H/V	S.G Output (dBm)	Antenna Gain (dB/dBi)	Cable Loss (dB)	ERP/EIRP (dBm)	Limit (dBm)	Safe Margin (dBm)
101.78	46.49	H	-56.32	-7.76	1.37	-65.45	-13.00	-52.45
1434.00	46.60	H	-58.27	8.46	4.32	-54.13	-13.00	-41.13
1673.20	---	H		9.36	5.27		-13.00	
2509.80	---	H		10.09	6.58		-13.00	
3346.40	---	H		12.28	7.79		-13.00	
4183.00	---	H		12.62	8.93		-13.00	
5019.60	---	H		12.67	9.81		-13.00	
5856.20	---	H		13.68	10.62		-13.00	
6692.80	---	H		11.95	11.39		-13.00	
7529.40	---	H		11.45	12.20		-13.00	
8366.00	---	H		11.59	12.81		-13.00	

Measurement uncertainty	30MHz - 80MHz: 5.04dB
	80MHz -1000MHz: 3.76dB
	1GHz - 13GHz: 4.45dB

Remark :

- 1 The emission behaviors belong to narrowband spurious emission.
- 2 Remark"---" means that the emission level is too low to be measured
- 3 The result basic equation calculation is as follows:
- 4 $ERP/EIRP (dBm) = SG \text{ Setting}(dBm) + Antenna \text{ Gain} (dB/dBi) - Cable \text{ loss} (dB)$

Radiated Spurious Emission Measurement Result: WCDMA BAND V Mode

Operation Mode	: TX CH High H Mode	Test Date:	Jul. 11, 2007
Fundamental Frequency	: 846.6 MHz	Test By:	Jason
Temperature	: 25°C	Pol:	Ver
Humidity	: 65%		

Freq. (MHz)	SPA. Reading (dBuV)	Ant.Pol. H/V	S.G Out-put (dBm)	Antenna Gain (dB/dBi)	Cable Loss (dB)	ERP/EIRP (dBm)	Limit (dBm)	Safe Margin (dBm)
36.79	46.11	V	-56.62	-4.16	0.91	-61.69	-13.00	-48.69
106.63	43.60	V	-57.71	-7.77	1.39	-66.86	-13.00	-53.86
849.00	76.05	V	-10.07	-7.88	3.68	-21.63	-13.00	-8.63
1378.00	43.12	V	-62.12	8.14	3.76	-57.75	-13.00	-44.75
1434.00	41.75	V	-63.26	8.46	4.32	-59.12	-13.00	-46.12
1697.60	---	V		9.44	5.31		-13.00	
2546.40	---	V		10.20	6.63		-13.00	
3395.20	---	V		12.38	7.87		-13.00	
4244.00	---	V		12.63	9.00		-13.00	
5092.80	---	V		12.74	9.88		-13.00	
5941.60	---	V		13.81	10.70		-13.00	
6790.40	---	V		11.86	11.48		-13.00	
7639.20	---	V		11.40	12.27		-13.00	
8488.00	---	V		11.70	12.91		-13.00	

Measurement uncertainty	30MHz - 80MHz: 5.04dB
	80MHz - 1000MHz: 3.76dB
	1GHz - 13GHz: 4.45dB

Remark :

- 1 The emission behaviors belong to narrowband spurious emission.
- 2 Remark"---" means that the emission level is too low to be measured
- 3 The result basic equation calculation is as follows:
- 4 $ERP/EIRP (dBm) = SG \text{ Setting}(dBm) + Antenna \text{ Gain} (dB/dBi) - Cable \text{ loss} (dB)$

Radiated Spurious Emission Measurement Result: WCDMA BAND V Mode

Operation Mode	: TX CH High H Mode	Test Date:	Jul. 11, 2007
Fundamental Frequency	: 846.60 MHz	Test By:	Jason
Temperature	: 25°C	Pol:	Hor
Humidity	: 65%		

Freq. (MHz)	SPA. Reading (dBuV)	Ant.Pol. H/V	S.G Out-put (dBm)	Antenna Gain (dB/dBi)	Cable Loss (dB)	ERP/EIRP (dBm)	Limit (dBm)	Safe Margin (dBm)
39.70	41.97	H	-60.92	-2.79	0.89	-64.61	-13.00	-51.61
101.78	46.49	H	-56.32	-7.76	1.37	-65.45	-13.00	-52.45
849.00	79.62	H	-6.57	-7.88	3.68	-18.13	-13.00	-5.13
1434.00	46.60	H	-58.27	8.46	4.32	-54.13	-13.00	-41.13
1483.00	42.92	H	-61.73	8.74	4.81	-57.80	-13.00	-44.80
1697.60	---	H		9.44	5.31		-13.00	
2546.40	---	H		10.20	6.63		-13.00	
3395.20	---	H		12.38	7.87		-13.00	
4244.00	---	H		12.63	9.00		-13.00	
5092.80	---	H		12.74	9.88		-13.00	
5941.60	---	H		13.81	10.70		-13.00	
6790.40	---	H		11.86	11.48		-13.00	
7639.20	---	H		11.40	12.27		-13.00	
8488.00	---	H		11.70	12.91		-13.00	

Measurement uncertainty	30MHz - 80MHz: 5.04dB
	80MHz - 1000MHz: 3.76dB
	1GHz - 13GHz: 4.45dB

Remark :

- 1 The emission behaviors belong to narrowband spurious emission.
- 2 Remark"---" means that the emission level is too low to be measured
- 3 The result basic equation calculation is as follows:
- 4 $ERP/EIRP (dBm) = SG \text{ Setting}(dBm) + Antenna \text{ Gain} (dB/dBi) - Cable \text{ loss} (dB)$

10. FREQUENCY STABILITY V.S. TEMPERATURE MEASUREMENT

10.1 Standard Applicable

According to FCC §2.1055(a)(1)(b).

Frequency Tolerance: 2.5 ppm

10.2 Test Set-up:

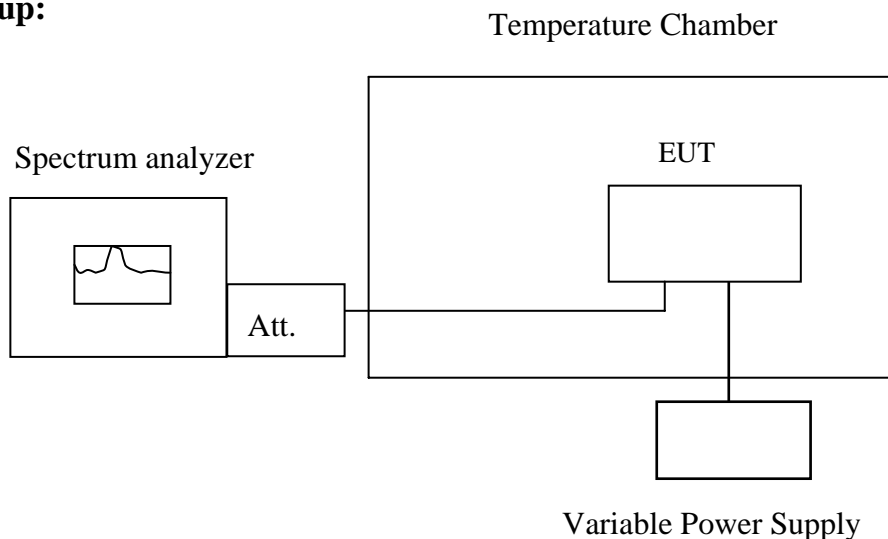

Note : Measurement setup for testing on Antenna connector

10.3 Measurement Procedure

The equipment under test was connected to an external AC or DC power supply and input rated voltage. RF output was connected to a frequency counter or spectrum analyzer via feed through attenuators. The EUT was placed inside the temperature chamber. Set the spectrum analyzer RBW low enough to obtain the desired frequency resolution and measure EUT 25°C operating frequency as reference frequency. Turn EUT off and set the chamber temperature to -30°C. After the temperature stabilized for approximately 30 minutes recorded the frequency. Repeat step measure with 10°C increased per stage until the highest temperature of +50°C reached.

10.4 Measurement Equipment Used:

Conducted Emission Test Site					
EQUIPMENT TYPE	MFR	MODEL NUMBER	SERIAL NUMBER	LAST CAL.	CAL DUE.
Spectrum Analyzer	Agilent	E4446A	MY43360126	04/27/2007	04/26/2008
Spectrum Analyzer	Agilent	E7405A	US41160416	07/04/2007	07/03/2008
Power Sensor	Anritsu	MA2490A	31431	07/07/2007	07/06/2008
Power Meter	Anritsu	ML2487A	6K00002070	07/07/2007	07/06/2008
Communication Test	R&S	SMU200	N/A	N/A	N/A
Temperature Chamber	TERCHY	MHG-120LF	911009	04/26/2007	04/25/2008
Low Loss Cable	HUBER+SUHNER	SUCOFLEX 104PEA	N/A	N/A	N/A
Attenuator	Mini-Circuit	BW-S10W5	N/A	07/05/2007	07/04/2008
Attenuator	Mini-Circuit	BW-S6W5	N/A	07/05/2007	07/04/2008
Splitter	Agilent	11636B	51728	09/23/2007	09/22/2008
Signal Generator	R&S	SMR40	100210	11/09/2006	11/10/2007
DC Power Supply	Agilent	6038A	2929A-07548	01/06/2007	01/05/2008

This document is issued by the Company subject to its General Conditions of Service printed overleaf or available on request and accessible at www.sgs.com. Attention is drawn to the limitations of liability, indemnification, and Jurisdictional issued defined therein. Unless otherwise stated, the results shown in this test report refer only to the sample(s) tested. This document cannot be reproduced except in full, without prior approval of Company. Any unauthorized alteration, forgery or falsification of the content or appearance of this report is unlawful and offenders may be prosecuted to the fullest extent of the law. 此報告是遵循本公司訂定之通用服務條款所製作發放，請注意此條款列印於背面，亦可在www.sgs.com中查閱。將本公司之義務，免責，管轄權皆明確規範之。除非另有說明，此報告結果僅對檢驗之樣品負責。本報告未經本公司書面許可，不可部份複製。對本報告內容或外觀之任何未經授權之變更、偽造、竄改皆屬非法，違犯者將會被依法追訴。

10.5 Measurement Result

Reference Frequency: GSM Mid Channel 836.6 MHz @ 25°C				
Limit: +/- 2.5 ppm = 2091 Hz				
Power Supply	Environment	Frequency	Delta (Hz)	Limit (Hz)
Vdc	Temperature (°C)	(MHz)		
3.7	-30	836.600014	-12.00	2091
3.7	-20	836.600017	-15.00	2091
3.7	-10	836.600023	-21.00	2091
3.7	0	836.600024	-22.00	2091
3.7	10	836.600016	-14.00	2091
3.7	20	836.600002	0.00	2091
3.7	30	836.600001	1.00	2091
3.7	40	836.600002	0.00	2091
3.7	50	836.600010	-8.00	2091

Reference Frequency: PCS Mid Channel 1880 MHz @ 25°C				
Limit: +/- 2.5 ppm = 4700 Hz				
Power Supply	Environment	Frequency	Delta (Hz)	Limit (Hz)
Vdc	Temperature (°C)	(MHz)		
3.7	-30	1879.999885	75.00	4700
3.7	-20	1879.999862	98.00	4700
3.7	-10	1879.999834	126.00	4700
3.7	0	1879.999820	140.00	4700
3.7	10	1879.999785	175.00	4700
3.7	20	1879.999960	0.00	4700
3.7	30	1879.999925	35.00	4700
3.7	40	1880.000025	-65.00	4700
3.7	50	1880.000045	-85.00	4700

Note: The battery is rated 3.7V dc.

Measurement Result

Reference Frequency: EDGE 850 Mid Channel 836.6 MHz @ 25°C				
Limit: +/- 2.5 ppm = 2091 Hz				
Power Supply	Environment	Frequency	Delta (Hz)	Limit (Hz)
Vdc	Temperature (°C)	(MHz)		
3.7	-30	836.599955	26.00	2091
3.7	-20	836.599963	18.00	2091
3.7	-10	836.599988	-7.00	2091
3.7	0	836.599985	-4.00	2091
3.7	10	836.599973	8.00	2091
3.7	20	836.599981	0.00	2091
3.7	30	836.599971	10.00	2091
3.7	40	836.599986	-5.00	2091
3.7	50	836.599992	-11.00	2091

Reference Frequency: EDGE 1900 Mid Channel 1880 MHz @ 25°C				
Limit: +/- 2.5 ppm = 4700 Hz				
Power Supply	Environment	Frequency	Delta (Hz)	Limit (Hz)
Vdc	Temperature (°C)	(MHz)		
3.7	25	1879.999931	49.00	4700
3.7	-30	1879.999954	26.00	4700
3.7	-20	1879.999962	18.00	4700
3.7	-10	1879.999978	2.00	4700
3.7	0	1879.999981	-1.00	4700
3.7	10	1879.999980	0.00	4700
3.7	20	1879.999989	-9.00	4700
3.7	30	1880.000003	-23.00	4700
3.7	40	1880.000036	-56.00	4700
3.7	50	1879.999931	49.00	4700

Note: The battery is rated 3.7V dc.

Reference Frequency: WCDMA BAND II Mid Channel 1880 MHz @ 25°C				
Limit: +/- 2.5 ppm = 4700 Hz				
Power Supply	Environment	Frequency	Delta (Hz)	Limit (Hz)
Vdc	Temperature (°C)	(MHz)		
3.7	-30	1880.000095	1.00	4700
3.7	-20	1880.000099	-3.00	4700
3.7	-10	1880.000108	-12.00	4700
3.7	0	1880.000101	-5.00	4700
3.7	10	1880.000087	9.00	4700
3.7	20	1880.000096	0.00	4700
3.7	30	1880.000072	24.00	4700
3.7	40	1880.000108	-12.00	4700
3.7	50	1880.000089	7.00	4700

Reference Frequency: WCDMA BAND V Mid Channel 836.6 MHz @ 25°C				
Limit: +/- 2.5 ppm = 2091 Hz				
Power Supply	Environment	Frequency	Delta (Hz)	Limit (Hz)
Vdc	Temperature (°C)	(MHz)		
3.7	-30	836.000031	-9.00	2091
3.7	-20	836.000035	-13.00	2091
3.7	-10	836.000039	-17.00	2091
3.7	0	836.000046	-24.00	2091
3.7	10	836.000041	-19.00	2091
3.7	20	836.000022	0.00	2091
3.7	30	836.000052	-30.00	2091
3.7	40	836.000046	-24.00	2091
3.7	50	836.000036	-14.00	2091

Note: The battery is rated 3.7V dc.

11. FREQUENCY STABILITY V.S. VOLTAGE MEASUREMENT

11.1 Standard Applicable

According to FCC §2.1055(d)(1)(2)

Frequency Tolerance: 2.5 ppm

11.2 Test Set-up:

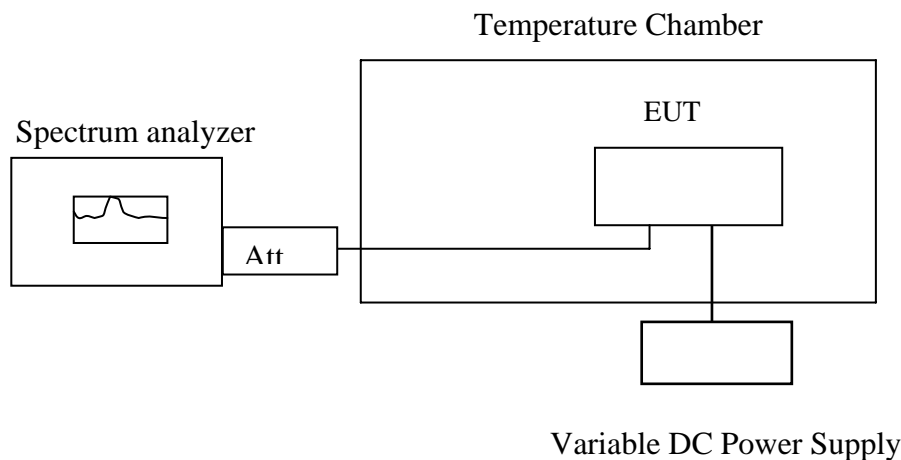

Note: Measurement setup for testing on Antenna connector

11.3 Measurement Procedure

Set chamber temperature to 25°C. Use a variable AC power supply / DC power source to power the EUT and set the voltage to rated voltage. Set the spectrum analyzer RBW low enough to obtain the desired frequency resolution and recorded the frequency.

Reduce the input voltage to specified extreme voltage variation (+/- 15%) and endpoint, record the maximum frequency change.

11.4 Measurement Equipment Used:

Conducted Emission Test Site					
EQUIPMENT TYPE	MFR	MODEL NUMBER	SERIAL NUMBER	LAST CAL.	CAL DUE.
Spectrum Analyzer	Agilent	E4446A	MY43360126	04/27/2007	04/26/2008
Spectrum Analyzer	Agilent	E7405A	US41160416	07/04/2007	07/03/2008
Power Sensor	Anritsu	MA2490A	31431	07/07/2007	07/06/2008
Power Meter	Anritsu	ML2487A	6K00002070	07/07/2007	07/06/2008
Communication Test	R&S	SMU200	N/A	N/A	N/A
Temperature Chamber	TERCHY	MHG-120LF	911009	04/26/2007	04/25/2008
Low Loss Cable	HUBER+SUHNER	SUCOFLEX 104PEA	N/A	N/A	N/A
Attenuator	Mini-Circuit	BW-S10W5	N/A	07/05/2007	07/04/2008
Attenuator	Mini-Circuit	BW-S6W5	N/A	07/05/2007	07/04/2008
Splitter	Agilent	11636B	51728	09/23/2007	09/22/2008
Signal Generator	R&S	SMR40	100210	11/09/2006	11/10/2007
DC Power Supply	Agilent	6038A	2929A-07548	01/06/2007	01/05/2008

This document is issued by the Company subject to its General Conditions of Service printed overleaf or available on request and accessible at www.sgs.com. Attention is drawn to the limitations of liability, indemnification, and Jurisdictional issued defined therein. Unless otherwise stated, the results shown in this test report refer only to the sample(s) tested. This document cannot be reproduced except in full, without prior approval of Company. Any unauthorized alteration, forgery or falsification of the content or appearance of this report is unlawful and offenders may be prosecuted to the fullest extent of the law. 此報告是遵循本公司訂定之通用服務條款所製作發放，請注意此條款列印於背面，亦可在www.sgs.com中查閱。將本公司之義務，免責，管轄權皆明確規範之。除非另有說明，此報告結果僅對檢驗之樣品負責。本報告未經本公司書面許可，不可部份複製。對本報告內容或外觀之任何未經授權之變更、偽造、竄改皆屬非法，違犯者將會被依法追訴。

11.5 Measurement Result

Reference Frequency: GSM Mid Channel 836.6 MHz @ 25°C				
Limit: +/- 2.5 ppm = 2091 Hz				
Power Supply	Environment	Frequency	Delta (Hz)	Limit (Hz)
Vdc	Temperature (°C)	(MHz)		
4.25	25.00	836.600000	2.00	2091.00
3.70	25.00	836.600002	0.00	2091.00
3.40	25.00	836.600001	1.00	2091.00
3.40 (Endpoint)	25.00	836.600001	1.00	2091.00

Reference Frequency: PCS Mid Channel 1880 MHz @ 25°C				
Limit: +/- 2.5 ppm = 4700 Hz				
Power Supply	Environment	Frequency	Delta (Hz)	Limit (Hz)
Vdc	Temperature (°C)	(MHz)		
4.25	25	1879.999920	40.00	4700
3.70	25	1879.999960	0.00	4700
3.40	25	1879.999945	15.00	4700
3.40 (Endpoint)	25	1879.999945	15.00	4700

Note: The battery is rated 3.7V dc.

Reference Frequency: EDGE 850 Mid Channel 836.6 MHz @ 25°C				
Limit: +/- 2.5 ppm = 2091 Hz				
Power Supply	Environment	Frequency	Delta (Hz)	Limit (Hz)
Vdc	Temperature (°C)	(MHz)		
4.26	25.00	836.599993	0.00	2091.00
3.70	25.00	836.599986	-7.00	2091.00
3.38	25.00	836.599978	-15.00	2091.00
3.38 (End Point)	25.00	836.599978	-15.0	2091.00

Reference Frequency: EDGE 1900 Mid Channel 1880 MHz @ 25°C				
Limit: +/- 2.5 ppm = 4700 Hz				
Power Supply	Environment	Frequency	Delta (Hz)	Limit (Hz)
Vdc	Temperature (°C)	(MHz)		
4.26	25	1879.999991	0.00	4700
3.70	25	1879.999987	-4.00	4700
3.38	25	1879.999982	-9.00	4700
3.38 (Endpoint)	25	1879.999982	-9.00	4700

Note: The battery is rated 3.7V dc.

Reference Frequency: WCDMA Band II Mid Channel 1880 MHz @ 25°C				
Limit: +/- 2.5 ppm = 4700 Hz				
Power Supply	Environment	Frequency	Delta (Hz)	Limit (Hz)
Vdc	Temperature (°C)	(MHz)		
4.25	25	1880.000076	20.00	4700
3.70	25	1880.000096	0.00	4700
3.40	25	1880.000099	-3.00	4700
3.40 (Endpoint)	25	1880.000099	-3.00	4700

Reference Frequency: WCDMA Band V Mid Channel 836.6 MHz @ 25°C				
Limit: +/- 2.5 ppm = 2091 Hz				
Power Supply	Environment	Frequency	Delta (Hz)	Limit (Hz)
Vdc	Temperature (°C)	(MHz)		
4.25	25.00	836.000013	9.00	2091.00
3.70	25.00	836.000022	0.00	2091.00
3.40	25.00	836.000020	2.00	2091.00
3.40 (Endpoint)	25.00	836.000018	4.00	2091.00

Note: The battery is rated 3.7V dc.

12. AC POWER LINE CONDUCTED EMISSION TEST

12.1 Standard Applicable

According to §15.207. The emission value for frequency within 150KHz to 30MHz shall not exceed criteria of below chart.

Frequency range MHz	Limits dB(uV)	
	Quasi-peak	Average
0.15 to 0.50	66 to 56	56 to 46
0.50 to 5	56	46
5 to 30	60	50

Note

- 1.The lower limit shall apply at the transition frequencies
- 2.The limit decreases linearly with the logarithm of the frequency in the range 0.15 MHz to 0.50 MHz.

12.2 EUT Setup

1. The conducted emission tests were performed in the test site, using the setup in accordance with the ANSI C63.4-2001.
2. The EUT was plug-in DC power adaptor and was placed on the center of the back edge on the test table. The peripherals like earphone was placed on the side of the EUT. The rear of the EUT and peripherals were placed flushed with the rear of the tabletop.
3. The Power adaptor was connected with 110Vac/60Hz power source.

12.3 Measurement Procedure

1. The EUT was placed on a table which is 0.8m above ground plane.
2. Maximum procedure was performed on the six highest emissions to ensure EUT compliance.
3. Repeat above procedures until all frequency measured were complete.

12.4 Measurement Equipment Used:

Conducted Emission Test Site					
EQUIPMENT TYPE	MFR	MODEL NUMBER	SERIAL NUMBER	LAST CAL.	CAL DUE.
EMC Analyzer	HP	8594EM	3624A00203	09/02/2006	09/03/2007
EMI Test Receiver	R&S	ESCS30	828985/004	06/09/2007	06/10/2008
Transient Limiter	HP	11947A	3107A02062	09/02/2006	09/03/2007
LISN	Rolf-Heine	NNB-2/16Z	99012	12/31/2006	12/30/2007
LISN	Rolf-Heine	NNB-2/16Z	99013	12/24/2006	12/23/2007
Coaxial Cables	N/A	No. 3, 4	N/A	12/24/2006	12/23/2007

12.5 Measurement Result

The initial step in collecting conducted data is a spectrum analyzer peak scan of the measurement range. Significant peaks are then marked as shown on the following data page, and these signals are then quasi-peaked.

AC POWER LINE CONDUCTED EMISSION TEST DATA

Operation Mode:	GSM 850 LINK			Test Date:	Jul. 04, 2007
Temperature:	25 °C	Humidity:	62 %	Test By:	Jason

File :EH-2007-60004(Arima Ulti

Data :#13

Date: 2007/07/04

Time: 下午 10:54:41

80.0 dBuV

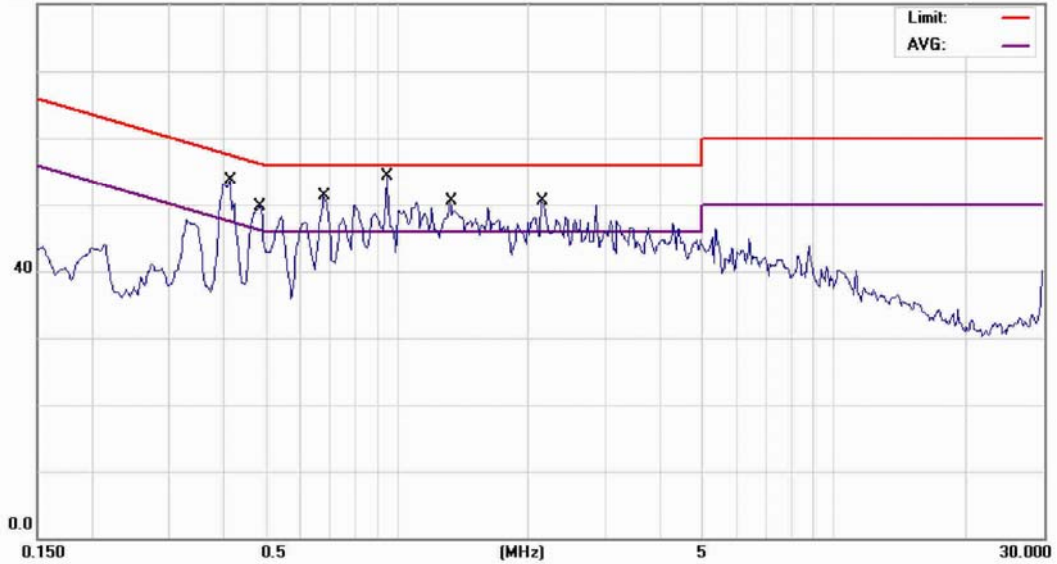

Site SGS CONDUCTED #1	Phase: L1	Temperature: 25 °C
Limit: CISPR22 Class B Conduction(QP)	Power: AC 120V/60Hz	Humidity: 62 %
EUT: Mobile Phone (iMate)	Distance:	Air Pressure: hpa
M/N: Ultimate8150		
Note: GSM 850 Link/BT+WLAN Link Mode		

No.	Mk.	Freq.	Reading Level	Factor	Measurement	Limit	Over	Detector	Comment
		MHz	dBuV	dB	dBuV	dBuV	dB		
1		0.4150	52.30	0.02	52.32	57.55	-5.23	QP	
2	*	0.4150	43.80	0.02	43.82	47.55	-3.73	AVG	
3		0.4850	48.90	0.02	48.92	56.25	-7.33	QP	
4		0.4850	39.70	0.02	39.72	46.25	-6.53	AVG	
5		0.6800	49.70	0.02	49.72	56.00	-6.28	QP	
6		0.6800	37.40	0.02	37.42	46.00	-8.58	AVG	
7		0.9500	48.60	0.01	48.61	56.00	-7.39	QP	
8		0.9500	36.50	0.01	36.51	46.00	-9.49	AVG	
9		1.3250	46.70	0.02	46.72	56.00	-9.28	QP	
10		1.3250	36.40	0.02	36.42	46.00	-9.58	AVG	
11		2.1500	47.50	0.04	47.54	56.00	-8.46	QP	
12		2.1500	36.91	0.04	36.95	46.00	-9.05	AVG	

This document is issued by the Company subject to its General Conditions of Service printed overleaf or available on request and accessible at www.sgs.com. Attention is drawn to the limitations of liability, indemnification, and Jurisdictional issued defined therein. Unless otherwise stated, the results shown in this test report refer only to the sample(s) tested. This document cannot be reproduced except in full, without prior approval of Company. Any unauthorized alteration, forgery or falsification of the content or appearance of this report is unlawful and offenders may be prosecuted to the fullest extent of the law. 此報告是遵循本公司訂定之通用服務條款所製作發放，請注意此條款列印於背面，亦可在www.sgs.com中查閱。將本公司之義務，免責，管轄權皆明確規範之。除非另有說明，此報告結果僅對檢驗之樣品負責。本報告未經本公司書面許可，不可部份複製。對本報告內容或外觀之任何未經授權之變更、偽造、竄改皆屬非法，違犯者將會被依法追訴。

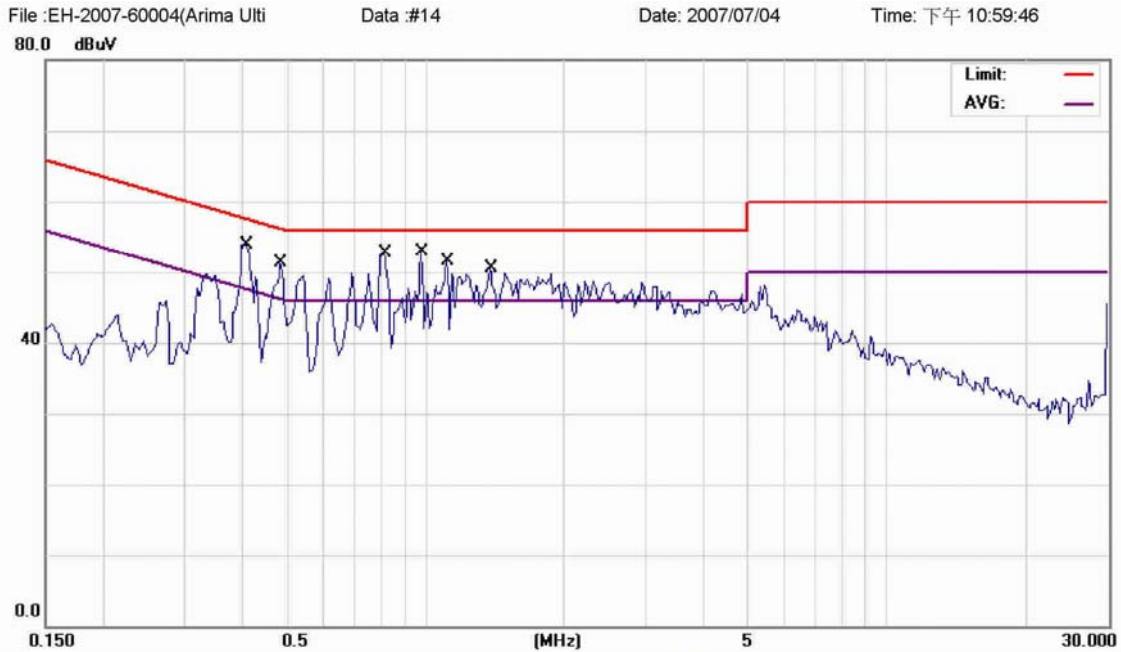

Site SGS CONDUCTED #1 Phase: **N** Temperature: 25 °C
 Limit: CISPR22 Class B Conduction(QP) Power: AC 120V/60Hz Humidity: 62 %
 EUT: Mobile Phone (iMate) Distance: Air Pressure: hpa
 M/N: Ultimate8150
 Note: GSM 850 Link//BT+WLAN Link Mode

No.	Mk.	Freq.	Reading Level	Factor	Measurement	Limit	Over	Detector	Comment
		MHz	dBuV	dB	dBuV	dBuV	dB		
1	*	0.4100	51.70	0.02	51.72	57.65	-5.93	QP	
2		0.4100	40.10	0.02	40.12	47.65	-7.53	AVG	
3		0.4850	47.80	0.02	47.82	56.25	-8.43	QP	
4		0.4850	36.90	0.02	36.92	46.25	-9.33	AVG	
5		0.8150	48.70	0.01	48.71	56.00	-7.29	QP	
6		0.8150	36.80	0.01	36.81	46.00	-9.19	AVG	
7		0.9800	49.60	0.01	49.61	56.00	-6.39	QP	
8		0.9800	37.80	0.01	37.81	46.00	-8.19	AVG	
9		1.1150	47.30	0.01	47.31	56.00	-8.69	QP	
10		1.1150	35.80	0.01	35.81	46.00	-10.19	AVG	
11		1.3850	47.90	0.02	47.92	56.00	-8.08	QP	
12		1.3850	37.51	0.02	37.53	46.00	-8.47	AVG	

This document is issued by the Company subject to its General Conditions of Service printed overleaf or available on request and accessible at www.sgs.com. Attention is drawn to the limitations of liability, indemnification, and Jurisdictional issued defined therein. Unless otherwise stated, the results shown in this test report refer only to the sample(s) tested. This document cannot be reproduced except in full, without prior approval of Company. Any unauthorized alteration, forgery or falsification of the content or appearance of this report is unlawful and offenders may be prosecuted to the fullest extent of the law. 此報告是遵循本公司訂定之通用服務條款所製作發放，請注意此條款列印於背面，亦可在www.sgs.com中查閱。將本公司之義務，免責，管轄權皆明確規範之。除非另有說明，此報告結果僅對檢驗之樣品負責。本報告未經本公司書面許可，不可部份複製。對本報告內容或外觀之任何未經授權之變更、偽造、竄改皆屬非法，違犯者將會被依法追訴。

AC POWER LINE CONDUCTED EMISSION TEST DATA

Operation Mode:	GSM 1900 Link		Test Date:	Jul. 04, 2007	
Temperature:	25 °C	Humidity:	62 %	Test By:	Jason

File :EH-2007-60004(Arima Ulti) Data :#16 Date: 2007/07/04 Time: 下午 11:11:27

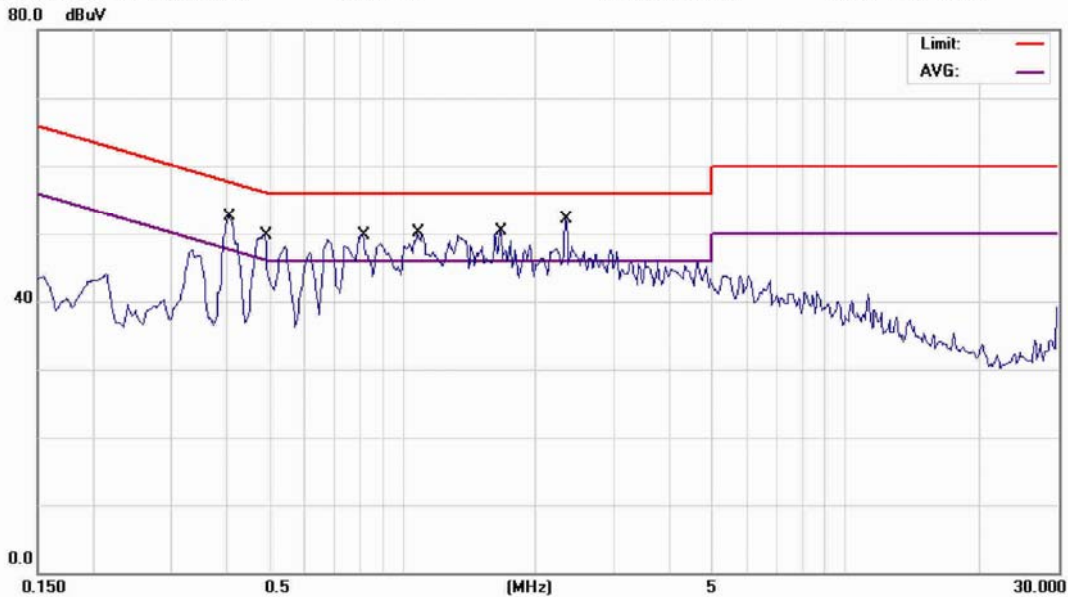

Site SGS CONDUCTED #1 Phase: **L1** Temperature: 25 °C
 Limit: CISPR22 Class B Conduction(QP) Power: AC 120V/60Hz Humidity: 62 %
 EUT: Mobile Phone (iMate) Distance: Air Pressure: hpa
 M/N: Ultimate8150
 Note: GSM 1900 Link/BT+WLAN Link Mode

No.	Mk.	Freq. MHz	Reading Level dBuV	Factor dB	Measure- ment dBuV	Limit dBuV	Over dB	Detector	Comment
1		0.4050	51.60	0.02	51.62	57.75	-6.13	QP	
2	*	0.4050	42.80	0.02	42.82	47.75	-4.93	AVG	
3		0.4900	49.60	0.02	49.62	56.17	-6.55	QP	
4		0.4900	40.10	0.02	40.12	46.17	-6.05	AVG	
5		0.8150	49.10	0.01	49.11	56.00	-6.89	QP	
6		0.8150	39.90	0.01	39.91	46.00	-6.09	AVG	
7		1.0850	48.60	0.01	48.61	56.00	-7.39	QP	
8		1.0850	38.80	0.01	38.81	46.00	-7.19	AVG	
9		1.6700	47.50	0.03	47.53	56.00	-8.47	QP	
10		1.6700	37.40	0.03	37.43	46.00	-8.57	AVG	
11		2.3450	44.80	0.05	44.85	56.00	-11.15	QP	
12		2.3450	36.41	0.05	36.46	46.00	-9.54	AVG	

This document is issued by the Company subject to its General Conditions of Service printed overleaf or available on request and accessible at www.sgs.com. Attention is drawn to the limitations of liability, indemnification, and Jurisdictional issued defined therein. Unless otherwise stated, the results shown in this test report refer only to the sample(s) tested. This document cannot be reproduced except in full, without prior approval of Company. Any unauthorized alteration, forgery or falsification of the content or appearance of this report is unlawful and offenders may be prosecuted to the fullest extent of the law. 此報告是遵循本公司訂定之通用服務條款所製作發放，請注意此條款列印於背面，亦可在www.sgs.com中查閱。將本公司之義務，免責，管轄權皆明確規範之。除非另有說明，此報告結果僅對檢驗之樣品負責。本報告未經本公司書面許可，不可部份複製。對本報告內容或外觀之任何未經授權之變更、偽造、竄改皆屬非法，違犯者將會被依法追訴。

File :EH-2007-60004(Arima Ulti) Data :#15 Date: 2007/07/04 Time: 下午 11:07:02

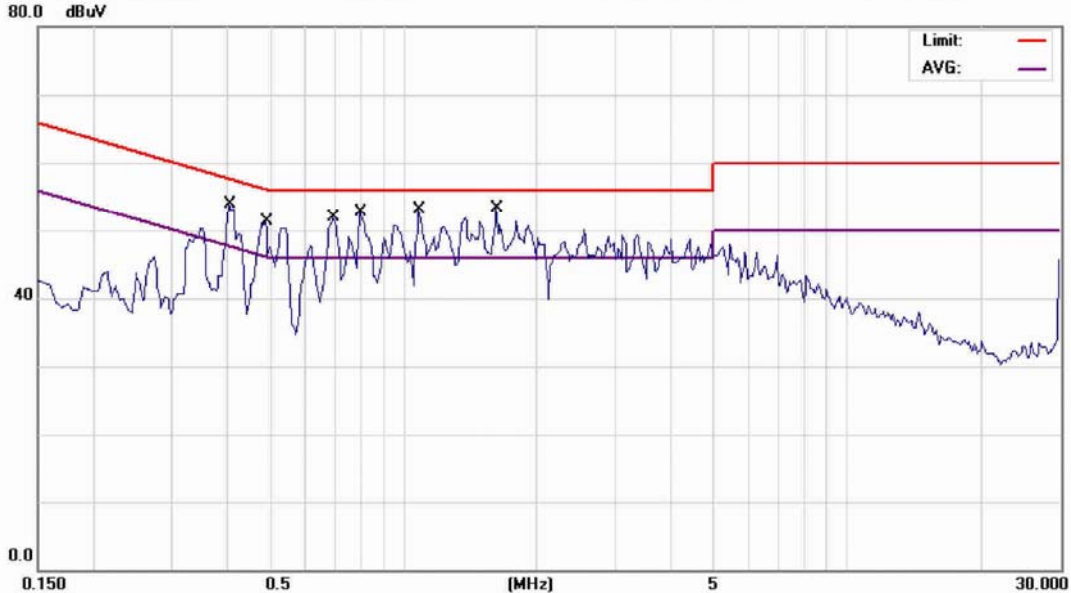

Site SGS CONDUCTED #1 Phase: **N** Temperature: 25 °C
 Limit: CISPR22 Class B Conduction(QP) Power: AC 120V/60Hz Humidity: 62 %
 EUT: Mobile Phone (iMate) Distance: Air Pressure: hpa
 M/N: Ultimate8150
 Note: GSM 1900 Link//BT+WLAN Link Mode

No.	Mk.	Freq. MHz	Reading Level dBuV	Factor dB	Measure- ment dBuV	Limit dBuV	Over dB	Detector	Comment
1	*	0.4050	51.70	0.02	51.72	57.75	-6.03	QP	
2		0.4050	40.60	0.02	40.62	47.75	-7.13	AVG	
3		0.4900	47.80	0.02	47.82	56.17	-8.35	QP	
4		0.4900	35.70	0.02	35.72	46.17	-10.45	AVG	
5		0.6950	47.90	0.02	47.92	56.00	-8.08	QP	
6		0.6950	36.80	0.02	36.82	46.00	-9.18	AVG	
7		0.8000	48.70	0.01	48.71	56.00	-7.29	QP	
8		0.8000	36.80	0.01	36.81	46.00	-9.19	AVG	
9		1.0850	47.60	0.01	47.61	56.00	-8.39	QP	
10		1.0850	36.80	0.01	36.81	46.00	-9.19	AVG	
11		1.6250	47.50	0.03	47.53	56.00	-8.47	QP	
12		1.6250	37.91	0.03	37.94	46.00	-8.06	AVG	

This document is issued by the Company subject to its General Conditions of Service printed overleaf or available on request and accessible at www.sgs.com. Attention is drawn to the limitations of liability, indemnification, and Jurisdiction issued defined therein. Unless otherwise stated, the results shown in this test report refer only to the sample(s) tested. This document cannot be reproduced except in full, without prior approval of Company. Any unauthorized alteration, forgery or falsification of the content or appearance of this report is unlawful and offenders may be prosecuted to the fullest extent of the law. 此報告是遵循本公司訂定之通用服務條款所製作發放，請注意此條款列印於背面，亦可在www.sgs.com中查閱。將本公司之義務，免責，管轄權皆明確規範之。除非另有說明，此報告結果僅對檢驗之樣品負責。本報告未經本公司書面許可，不可部份複製。對本報告內容或外觀之任何未經授權之變更、偽造、竄改皆屬非法，違犯者將會被依法追訴。

AC POWER LINE CONDUCTED EMISSION TEST DATA

Operation Mode:	WCDMAII Link		Test Date:	Jul. 04, 2007	
Temperature:	25 °C	Humidity:	62 %	Test By:	Jason

File :EH-2007-60004(Arima Ulti) Data :#17 Date: 2007/07/04 Time: 下午 11:20:03

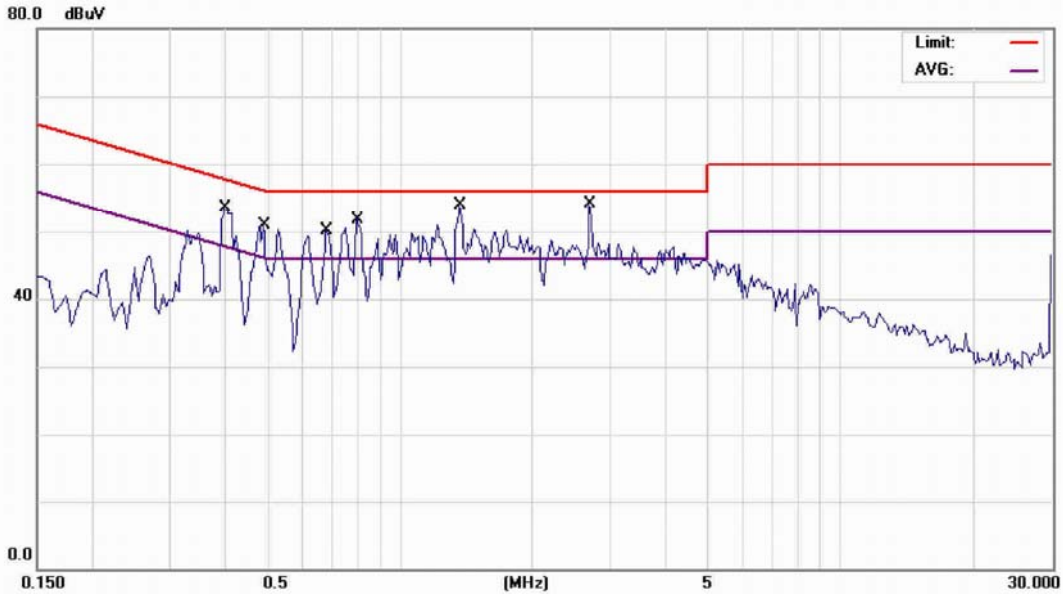

Site SGS CONDUCTED #1	Phase: L1	Temperature: 25 °C
Limit: CISPR22 Class B Conduction(QP)	Power: AC 120V/60Hz	Humidity: 62 %
EUT: Mobile Phone (iMate)	Distance:	Air Pressure: hpa
M/N: Ultimate8150		
Note: WCDMA B2 Link+/BT+WLAN Link Mode		

No.	Mk.	Freq. MHz	Reading Level dBuV	Factor dB	Measure- ment dBuV	Limit dBuV	Over dB	Detector	Comment
1	*	0.4000	51.60	0.02	51.62	57.85	-6.23	QP	
2		0.4000	41.20	0.02	41.22	47.85	-6.63	AVG	
3		0.4900	47.80	0.02	47.82	56.17	-8.35	QP	
4		0.4900	36.40	0.02	36.42	46.17	-9.75	AVG	
5		0.6890	35.93	0.02	35.95	46.00	-10.05	AVG	
6		0.6890	35.83	0.02	35.85	46.00	-10.15	AVG	
7		0.8000	48.60	0.01	48.61	56.00	-7.39	QP	
8		0.8000	37.40	0.01	37.41	46.00	-8.59	AVG	
9		1.3700	46.70	0.02	46.72	56.00	-9.28	QP	
10		1.3700	36.90	0.02	36.92	46.00	-9.08	AVG	
11		2.7050	45.20	0.05	45.25	56.00	-10.75	QP	
12		2.7050	46.21	0.05	46.26	56.00	-9.74	QP	

This document is issued by the Company subject to its General Conditions of Service printed overleaf or available on request and accessible at www.sgs.com. Attention is drawn to the limitations of liability, indemnification, and Jurisdictional issued defined therein. Unless otherwise stated, the results shown in this test report refer only to the sample(s) tested. This document cannot be reproduced except in full, without prior approval of Company. Any unauthorized alteration, forgery or falsification of the content or appearance of this report is unlawful and offenders may be prosecuted to the fullest extent of the law. 此報告是遵循本公司訂定之通用服務條款所製作發放，請注意此條款列印於背面，亦可在www.sgs.com中查閱。將本公司之義務，免責，管轄權皆明確規範之。除非另有說明，此報告結果僅對檢驗之樣品負責。本報告未經本公司書面許可，不可部份複製。對本報告內容或外觀之任何未經授權之變更、偽造、竄改皆屬非法，違犯者將會被依法追訴。

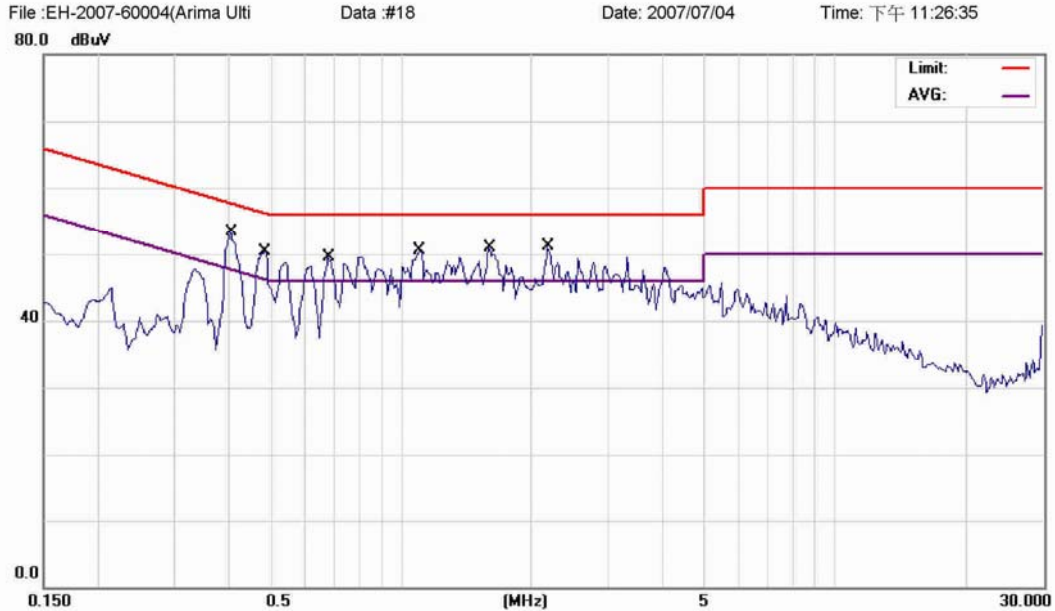

Site SGS CONDUCTED #1	Phase: N	Temperature: 25 °C
Limit: CISPR22 Class B Conduction(QP)	Power: AC 120V/60Hz	Humidity: 62 %
EUT: Mobile Phone (iMate)	Distance:	Air Pressure: hpa
M/N: Ultimate8150		
Note: WCDMA B2 Link//BT+WLAN Link Mode		

No.	Mk.	Freq. MHz	Reading Level dBuV	Factor dB	Measure- ment dBuV	Limit dBuV	Over dB	Detector	Comment
1		0.4050	52.70	0.02	52.72	57.75	-5.03	QP	
2	*	0.4050	43.20	0.02	43.22	47.75	-4.53	AVG	
3		0.4850	48.90	0.02	48.92	56.25	-7.33	QP	
4		0.4850	39.80	0.02	39.82	46.25	-6.43	AVG	
5		0.6800	49.20	0.02	49.22	56.00	-6.78	QP	
6		0.6800	38.80	0.02	38.82	46.00	-7.18	AVG	
7		1.1000	48.70	0.01	48.71	56.00	-7.29	QP	
8		1.1000	38.40	0.01	38.41	46.00	-7.59	AVG	
9		1.5950	45.90	0.03	45.93	56.00	-10.07	QP	
10		1.5950	36.40	0.03	36.43	46.00	-9.57	AVG	
11		2.1800	46.70	0.04	46.74	56.00	-9.26	QP	
12		2.1800	35.81	0.04	35.85	46.00	-10.15	AVG	

This document is issued by the Company subject to its General Conditions of Service printed overleaf or available on request and accessible at www.sgs.com. Attention is drawn to the limitations of liability, indemnification, and Jurisdictional issued defined therein. Unless otherwise stated, the results shown in this test report refer only to the sample(s) tested. This document cannot be reproduced except in full, without prior approval of Company. Any unauthorized alteration, forgery or falsification of the content or appearance of this report is unlawful and offenders may be prosecuted to the fullest extent of the law. 此報告是遵循本公司訂定之通用服務條款所製作發放，請注意此條款列印於背面，亦可在www.sgs.com中查閱。將本公司之義務，免責，管轄權皆明確規範之。除非另有說明，此報告結果僅對檢驗之樣品負責。本報告未經本公司書面許可，不可部份複製。對本報告內容或外觀之任何未經授權之變更、偽造、竄改皆屬非法，違犯者將會被依法追訴。

AC POWER LINE CONDUCTED EMISSION TEST DATA

Operation Mode:	WCDMAV Link			Test Date:	Jul. 04, 2007
Temperature:	25 °C	Humidity:	62 %	Test By:	Jason

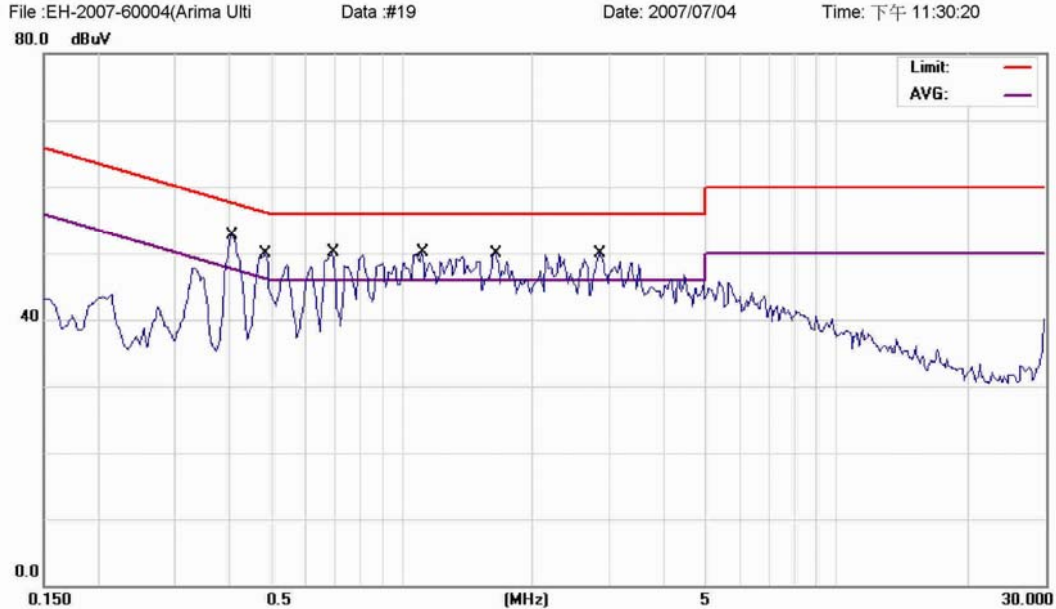

Site	SGS CONDUCTED #1	Phase:	L1	Temperature:	25 °C
Limit:	CISPR22 Class B Conduction(QP)	Power:	AC 120V/60Hz	Humidity:	62 %
EUT:	Mobile Phone (iMate)	Distance:		Air Pressure:	hpa
M/N:	Ultimate8150				
Note:	WCDMA B5 Link//BT+WLAN Link Mode				

No.	Mk.	Freq. MHz	Reading Level dBuV	Factor dB	Measure- ment dBuV	Limit dBuV	Over dB	Detector	Comment
1		0.4050	52.10	0.02	52.12	57.75	-5.63	QP	
2	*	0.4050	43.20	0.02	43.22	47.75	-4.53	AVG	
3		0.4850	48.40	0.02	48.42	56.25	-7.83	QP	
4		0.4850	39.80	0.02	39.82	46.25	-6.43	AVG	
5		0.6950	49.10	0.02	49.12	56.00	-6.88	QP	
6		0.6950	39.20	0.02	39.22	46.00	-6.78	AVG	
7		1.1150	48.70	0.01	48.71	56.00	-7.29	QP	
8		1.1150	36.90	0.01	36.91	46.00	-9.09	AVG	
9		1.6400	46.90	0.03	46.93	56.00	-9.07	QP	
10		1.6400	36.10	0.03	36.13	46.00	-9.87	AVG	
11		2.8550	46.70	0.05	46.75	56.00	-9.25	QP	
12		2.8550	36.51	0.05	36.56	46.00	-9.44	AVG	

This document is issued by the Company subject to its General Conditions of Service printed overleaf or available on request and accessible at www.sgs.com. Attention is drawn to the limitations of liability, indemnification, and Jurisdictional issued defined therein. Unless otherwise stated, the results shown in this test report refer only to the sample(s) tested. This document cannot be reproduced except in full, without prior approval of Company. Any unauthorized alteration, forgery or falsification of the content or appearance of this report is unlawful and offenders may be prosecuted to the fullest extent of the law. 此報告是遵循本公司訂定之通用服務條款所製作發放，請注意此條款列印於背面，亦可在www.sgs.com中查閱。將本公司之義務，免責，管轄權皆明確規範之。除非另有說明，此報告結果僅對檢驗之樣品負責。本報告未經本公司書面許可，不可部份複製。對本報告內容或外觀之任何未經授權之變更、偽造、竄改皆屬非法，違犯者將會被依法追訴。

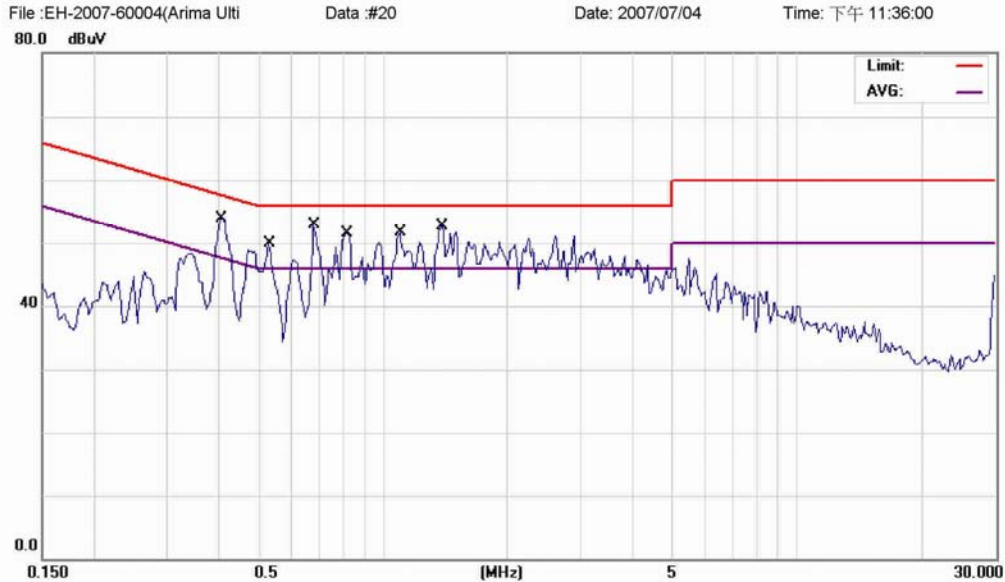

Site SGS CONDUCTED #1 Phase: **N** Temperature: 25 °C
 Limit: CISPR22 Class B Conduction(QP) Power: AC 120V/60Hz Humidity: 62 %
 EUT: Mobile Phone (iMate) Distance: Air Pressure: hpa
 M/N: Ultimate8150
 Note: WCDMA B5 Link/BT+WLAN Link Mode

No.	Mk.	Freq.	Reading Level	Factor	Measurement	Limit	Over	Detector	Comment
		MHz	dBuV	dB	dBuV	dBuV	dB		
1	*	0.4050	51.60	0.02	51.62	57.75	-6.13	QP	
2		0.4050	41.20	0.02	41.22	47.75	-6.53	AVG	
3		0.5300	49.70	0.02	49.72	56.00	-6.28	QP	
4		0.5300	39.50	0.02	39.52	46.00	-6.48	AVG	
5		0.6800	48.70	0.02	48.72	56.00	-7.28	QP	
6		0.6800	36.90	0.02	36.92	46.00	-9.08	AVG	
7		0.8150	47.90	0.01	47.91	56.00	-8.09	QP	
8		0.8150	36.70	0.01	36.71	46.00	-9.29	AVG	
9		1.1000	48.60	0.01	48.61	56.00	-7.39	QP	
10		1.1000	36.70	0.01	36.71	46.00	-9.29	AVG	
11		1.3850	47.90	0.02	47.92	56.00	-8.08	QP	
12		1.3850	35.80	0.02	35.82	46.00	-10.18	AVG	

This document is issued by the Company subject to its General Conditions of Service printed overleaf or available on request and accessible at www.sgs.com. Attention is drawn to the limitations of liability, indemnification, and Jurisdictional issued defined therein. Unless otherwise stated, the results shown in this test report refer only to the sample(s) tested. This document cannot be reproduced except in full, without prior approval of Company. Any unauthorized alteration, forgery or falsification of the content or appearance of this report is unlawful and offenders may be prosecuted to the fullest extent of the law. 此報告是遵循本公司訂定之通用服務條款所製作發放，請注意此條款列印於背面，亦可在www.sgs.com中查閱。將本公司之義務，免責，管轄權皆明確規範之。除非另有說明，此報告結果僅對檢驗之樣品負責。本報告未經本公司書面許可，不可部份複製。對本報告內容或外觀之任何未經授權之變更、偽造、竄改皆屬非法，違犯者將會被依法追訴。