



FCC 47 CFR PART 22 SUBPART H AND PART 24 SUBPART E

TEST REPORT

For

3.5G Pocket PC Phone

Brand Name: MWG

Model: ZINC II

Issued to

**Arima Communication Corp.
6F, No. 866, Jhongheng Rd., Jhonghe City,
Taipei County 23586, Taiwan**

Issued by

**Compliance Certification Services Inc.
No. 81-1, Lane 210, Bade Rd. 2, Luchu Hsiang,
Taoyuan Hsien, (338) Taiwan, R.O.C.
<http://www.ccsemc.com.tw>
service@tw.ccsemc.com**



***Note:** This report shall not be reproduced except in full, without the written approval of Compliance Certification Services Inc. This document may be altered or revised by Compliance Certification Services Inc. personnel only, and shall be noted in the revision section of the document.*



TABLE OF CONTENTS

1. TEST RESULT CERTIFICATION.....	3
2. EUT DESCRIPTION	4
3. TEST METHODOLOGY	6
3.1 EUT CONFIGURATION	6
3.2 EUT EXERCISE	6
3.3 GENERAL TEST PROCEDURES	6
3.4 DESCRIPTION OF TEST MODES	7
4. INSTRUMENT CALIBRATION.....	8
4.1 MEASURING INSTRUMENT CALIBRATION	8
4.2 MEASUREMENT EQUIPMENT USED	8
5. FACILITIES AND ACCREDITATIONS	10
5.1 FACILITIES	10
5.2 EQUIPMENT	10
5.3 TABLE OF ACCREDITATIONS AND LISTINGS	11
6. SETUP OF EQUIPMENT UNDER TEST	12
6.1 SETUP CONFIGURATION OF EUT	12
6.2 SUPPORT EQUIPMENT	12
7. FCC PART 22 & 24 REQUIREMENTS	13
7.1 AVERAGE POWER	13
7.2 ERP & EIRP MEASUREMENT	16
7.3 OCCUPIED BANDWIDTH MEASUREMENT	28
7.4 OUT OF BAND EMISSION AT ANTENNA TERMINALS	46
7.5 FIELD STRENGTH OF SPURIOUS RADIATION MEASUREMENT	75
7.6 FREQUENCY STABILITY V.S. TEMPERATURE MEASUREMENT	137
7.7 FREQUENCY STABILITY V.S. VOLTAGE MEASUREMENT	143
7.8 POWERLINE CONDUCTED EMISSIONS	149
APPENDIX I PHOTOGRAPHS OF TEST SETUP.....	152
APPENDIX II WCDMA SETTING	157



1. TEST RESULT CERTIFICATION

Applicant: Arima Communication Corp.
6F, No. 866, Jhongheng Rd., Jhonghe City,
Taipei County 23586, Taiwan

Equipment Under Test: 3.5G Pocket PC Phone

Brand Name: MWG

Model Number: ZINC II

Date of Test: March 11 ~ 19, 2008

APPLICABLE STANDARDS	
STANDARD	TEST RESULT
FCC 47 CFR PART 22 SUBPART H AND PART 24 SUBPART E	No non-compliance noted

We hereby certify that:

The above equipment was tested by Compliance Certification Services Inc. The test data, data evaluation, test procedures, and equipment configurations shown in this report were made in accordance with the procedures given in ANSI/TIA/EIA-603-A-2001 and the energy emitted by the sample EUT tested as described in this report is in compliance with conducted and radiated emission limits of FCC Rule FCC PART 22 Subpart H and PART 24 Subpart E.

The test results of this report relate only to the tested sample identified in this report.

Approved by:

Rex Lai
Section Manager
Compliance Certification Services Inc.

Reviewed by:

Amanda Wu
Section Manager
Compliance Certification Services Inc.



2. EUT DESCRIPTION

Product	3.5G Pocket PC Phone
Brand Name	MWG
Model Number	ZINC II
Model Discrepancy	N/A
Power Supply	<ol style="list-style-type: none">1. Power Adapter: Brand Name / Model Number: PHIHONG / PSAA05R-050 I/P: AC 100-240V, 50-60Hz, 0.3A, 13-16VA O/P: DC 5V, 1A MAX2. Rechargeable Lithium Battery: Model: XP-16 Rating: 3.7VDC, 1530mAh3. Powered from Host device via USB cable.
Accessories	<ol style="list-style-type: none">1. HandsFree: FOXCONN (model name: AC0801001), Unshielded, 1.65 m2. USB cable: FOXCONN (model name: CUHD005B-S13-EF), Unshielded, 1.25 m
Frequency Range	GSM / GPRS / EDGE: 850: 824 ~ 849 MHz GSM / GPRS / EDGE: 1900: 1850 ~ 1910 MHz WCDMA Band II: 1852.4 ~ 1907.6 MHz WCDMA Band V: 826.4 ~ 846.6 MHz
Modulation Technique	GSM: GMSK GPRS: GMSK EDGE: 8PSK WCDMA: Quadrature Phase Shift Keying (QPSK) with Root-raised cosine pulse shaping filters (roll off = 0.22)



Transmit Power (ERP & EIRP Power)	GSM 850: 31.85dBm (Slide Mode) GSM 1900: 25.24 dBm (Slide Mode) GPRS 850: 30.78 dBm (Close Mode) GPRS 1900: 24.73 dBm (Slide Mode) EDGE 850: 27.47 dBm (Close Mode) EDGE 1900: 22.99 dBm (Slide Mode) WCDMA Band II: 21.47 dBm (Slide Mode) HSDPA Band II: 22.68 dBm (Slide Mode) WCDMA Band V: 23.69 dBm (Close Mode) HSDPA Band V: 23.37 dBm (Close Mode)
Cellular Phone Protocol	GSM: Class A GPRS: Class 10 EDGE: Class 10
Type of Emission	GSM 850 MHz: 248KGXW--- GPRS 850 MHz: 248KGXW--- EDGE 850 MHz: 248KG7W--- GSM 1900 MHz: 250KGXW--- GPRS 1900 MHz: 248KGXW--- EDGE 1900 MHz: 248KG7W--- WCDMA Band II: 4M17F9W--- WCDMA Band V: 4M17F9W--- WCDMA HSDPA Band II: 4M18F9W--- WCDMA HSDPA Band V: 4M18F9W---
Antenna Gain	GSM / GPRS / EDGE 850 MHz: -3.20 dBi GSM / GPRS / EDGE 1900 MHz: 1.39 dBi WCDMA band II: 1.39 dBi WCDMA band V: -3.20 dBi
Antenna Type	PIFA Antenna

Remark:

1. The sample selected for test was engineering sample that approximated to production product and was provided by manufacturer.
2. This submittal(s) (test report) is intended for FCC ID: **PJO3617** filing to comply with Part 22 and Part 24 of the FCC 47 CFR Rules.



3. TEST METHODOLOGY

Both conducted and radiated testing were performed according to the procedures document on chapter 13 of ANSI C63.4 and FCC CFR 47, 2.1046, 2.1047, 2.1049, 2.1051, 2.1053, 2.1055 and 2.1057.

3.1 EUT CONFIGURATION

The EUT configuration for testing is installed on RF field strength measurement to meet the Commissions requirement and operating in a manner that intends to maximize its emission characteristics in a continuous normal application.

3.2 EUT EXERCISE

The EUT was operated in the engineering mode to fix the TX frequency that was for the purpose of the measurements.

3.3 GENERAL TEST PROCEDURES

Conducted Emissions

The EUT is placed on the turntable, which is 0.8 m above ground plane. According to the requirements in Section 13.1.4.1 of ANSI C63.4. Conducted emissions from the EUT measured in the frequency range between 0.15 MHz and 30MHz using CISPR Quasi-peak and average detector modes.

Radiated Emissions

The EUT is placed on a turn table, which is 0.8 m above ground plane. The turntable shall rotate 360 degrees to determine the position of maximum emission level. EUT is set 3m away from the receiving antenna, which varied from 1m to 4m to find out the highest emission. And also, each emission was to be maximized by changing the polarization of receiving antenna both horizontal and vertical. In order to find out the maximum emissions, exploratory radiated emission measurements were made according to the requirements in Section 13.1.4.1 of ANSI C63.4.



3.4 DESCRIPTION OF TEST MODES

The EUT (model: ZINC II) had been tested under operating condition.

EUT staying in continuous transmitting mode was programmed.

After verification, all tests were carried out with the worst case test modes as shown below except radiated spurious emission below 1GHz and power line conducted emissions below 30MHz, which worst case was in normal link mode only.

GSM / GPRS / EDGE 850:

Channel Low (CH128), Channel Mid (CH190) and Channel High (CH251) were chosen for full testing.

GSM / GPRS / EDGE 1900:

Channel Low (CH512), Channel Mid (CH661) and Channel High (CH810) were chosen for full testing.

WCDMA Band II:

Channel Low (CH9262), Channel Mid (CH9400) and Channel High (CH9538) were chosen for full testing.

WCDMA Band V:

Channel Low (CH4132), Channel Mid (CH4183) and Channel High (CH4233) were chosen for full testing.

WCDMA / HSDPA Band II:

Channel Low (CH9262), Channel Mid (CH9400) and Channel High (CH9538) were chosen for full testing.

WCDMA / HSDPA Band V:

Channel Low (CH4132), Channel Mid (CH4183) and Channel High (CH4233) were chosen for full testing.

The field strength of spurious emission was measured in the following position: EUT stand-up position (Z axis), lie-down position (X, Y axis). The worst emission was found in lie-down position (X axis) for power line conducted emission testing and the worst case was recorded.

Based on the above results from the different modulations, GSM850 / GSM1900 / GPRS 850 / GPRS1900 / EDGE 850 / EDGE 1900 / WCDMA Band II / WCDMA Band V / HSDPA Band II / HSDPA Band V were determined to be the worst-case scenario for all tests.

The worst emission was found:

in lie-down (X axis) for GPRS 850 closed mode.

in lie-down (X axis) for GSM 850 slide mode

in lie-down (Y axis) for EDGE 850 / WCDMA Band V closed mode.

in lie-down (Y axis) for GSM 1900 / GRPS 1900 / EDGE 1900 / WCDMA Band II / HSDPA Band II slide mode.

in stand-up (Z axis) for HSDPA Band V closed mode.



4. INSTRUMENT CALIBRATION

4.1 MEASURING INSTRUMENT CALIBRATION

The measuring equipment, which was utilized in performing the tests documented herein, has been calibrated in accordance with the manufacturer's recommendations for utilizing calibration equipment, which is traceable to recognized national standards.

4.2 MEASUREMENT EQUIPMENT USED

Equipment Used for Emissions Measurement

Remark: Each piece of equipment is scheduled for calibration once a year.

Conducted Emissions Test Site				
Name of Equipment	Manufacturer	Model	Serial Number	Calibration Due
Spectrum Analyzer	Agilent	E4446A	MY43360131	01/29/2009
Power Meter	Agilent	E4416A	GB41291611	03/19/2009
Power Sensor	Agilent	E9327A	US40441097	05/23/2008
Temp. / Humidity Chamber	Terchy	MHG-150LF	930619	08/08/2008
DC Power Source	Agilent	E3640A	MY40001774	01/10/2009

3M Semi Anechoic Chamber				
Name of Equipment	Manufacturer	Model	Serial Number	Calibration Due
Spectrum Analyzer	Agilent	E4446A	US42510252	08/01/2008
Test Receiver	Rohde & Schwarz	ESCI	100064	11/12/2008
Switch Controller	TRC	Switch Controller	SC94050010	05/03/2008
4 Port Switch	TRC	4 Port Switch	SC94050020	05/03/2008
Horn-Antenna	TRC	HA-0502	06	05/31/2008
Horn-Antenna	TRC	HA-0801	04	05/03/2008
Bilog- Antenna	Sunol Sciences	JB3	A030205	03/28/2009
Turn Table	Max-Full	MFT-120S	T120S940302	N.C.R.
Antenna Tower	Max-Full	MFA-430	A440940302	N.C.R.
Controller	Max-Full	MF-CM886	CC-C-1F-13	N.C.R.
Site NSA	N/A	FCC: 965860 IC: IC 6106	09/25/2008	09/25/2008
Reject Filter	Micro-Tronics	HPM13194	003	04/25/2008
S.G.	HP	83630B	3844A01022	04/08/2008
Substituted Dipole	Schwazbeck	VHAP/UHAP	998 +999/ 981+982	06/10/2008
Substituted Horn	EMCO	3115	00022257	12/17/2008
Test S/W	LABVIEW (V 6.1)			

Remark: The measurement uncertainty is less than +/-2.0dB (30MHz ~ 1GHz), +/-3.1dB (Above 1GHz) which is evaluated as per the NAMAS NIS 81 and CISPR/A/291/CDV.



Powerline Conducted Emissions Test Site				
Name of Equipment	Manufacturer	Model	Serial Number	Calibration Due
EMI Test Receiver 9kHz-30MHz	Rohde & Schwarz	ESHS30	828144/003	10/30/2008
Two-Line V-Network 9kHz-30MHz	Schaffner	NNB41	03/10013	06/12/2008
LISN 10kHz-100MHz	EMCO	3825/2	9106-1809	03/31/2009
Test S/W	LABVIEW (V 6.1)			

Remark: The measurement uncertainty is less than +/- 2.8dB, which is evaluated as per the NAMAS NIS 81 and CISPR/A/291/CDV.



5. FACILITIES AND ACCREDITATIONS

5.1 FACILITIES

No.199, Chunghsen Road, Hsintien City, Taipei Hsien, Taiwan, R.O.C.

Tel: 886-2-2217-0894 / Fax: 886-2-2217-1029

No.11, Wugong 6th Rd., Wugu Industrial Park, Taipei Hsien 248, Taiwan

Tel: 886-2-2299-9720 / Fax: 886-2-2298-4045

No.81-1, Lane 210, Bade 2nd Rd., Luchu Hsiang, Taoyuan Hsien 338, Taiwan

Tel: 886-3-324-0332 / Fax: 886-3-324-5235

The sites are constructed in conformance with the requirements of ANSI C63.7, ANSI C63.4 and CISPR Publication 22.

5.2 EQUIPMENT





Radiated emissions are measured with one or more of the following types of linearly polarized antennas: tuned dipole, biconical, log periodic, bi-log, and/or ridged waveguide, horn. Spectrum analyzers with pre-selectors and quasi-peak detectors are used to perform radiated measurements.

Conducted emissions are measured with Line Impedance Stabilization Networks and EMI Test Receivers.

Calibrated wideband preamplifiers, coaxial cables, and coaxial attenuators are also used for making measurements.

All receiving equipment conforms to CISPR Publication 16-1, "Radio Interference Measuring Apparatus and Measurement Methods."

5.3 TABLE OF ACCREDITATIONS AND LISTINGS

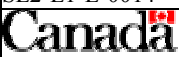
Country	Agency	Scope of Accreditation	Logo
USA	A2LA	EN 55011, EN 55014-1/2, CISPR 11, CISPR 14-1/2, EN 55022, EN 55015, CISPR 22, CISPR 15, AS/NZS 3548, VCCI V3 (2001), CFR 47, FCC Part 15/18, CNS 13783-1, CNS 13439, CNS 13438, CNS 13803, CNS 14115, EN 55024, IEC 801-2, IEC 801-3, IEC 801-4, IEC/EN 61000-3-2, IEC/EN 61000-3-3, IEC/EN 61000-4-2/3/4/5/6/8/11, EN 50081-1/ EN 61000-6-3, EN 50081-2/EN 61000-6-4, EN 50081-2/EN 61000-6-1: 2001	 ACCREDITED TESTING CERT #0824.01
USA	FCC	3/10 meter Open Area Test Sites (93105, 90471) / 3M Semi Anechoic Chamber (965860) to perform FCC Part 15/18 measurements	 93105, 90471 965860
Japan	VCCI	3/10 meter Open Area Test Sites to perform conducted/radiated measurements	VCCI R-393/1066/725/879 C-402/747/912
Norway	NEMKO	EN 50081-1/2, EN 50082-1/2, IEC 61000-6-1/2, EN 50091-2, EN 50130-4, EN 55011, EN 55013, EN 55014-1/2, EN 55015, EN 55022, EN 55024, EN 61000-3-2/3, EN 61326-1, IEC 61000-4-2/3/4/5/6/8/11, EN 60601-1-2, EN 300 328, EN 300 422-2, EN 301 419-1, EN 301 489-01/03/07/08/09/17, EN 301 419-2/3, EN 300 454-2, EN 301 357-2	 ELA 124a ELA 124b ELA 124c
Taiwan	TAF	EN 300 328, EN 300 220-1, EN 300 220-2, EN 300 220-3, 47 CFR FCC Part 15 Subpart C, EN 61000-3-2, EN 61000-3-3, CNS 13439, CNS 13783-1, CNS 14115, CNS 13438, AS/NZS CISPR 22, CNS 13022-1, IEC 61000-4-2/3/4/5/6/8/11, CNS 13022-2/3	 TAF Testing Laboratory 0363
Taiwan	BSMI	CNS 13438, CNS 13783-1, CNS 13439, CNS 14115	 SL2-IS-E-0014 SL2-IN-E-0014 SL2-A1-E-0014 SL2-R1-E-0014 SL2-R2-E-0014 SL2-L1-E-0014
Canada	Industry Canada	3/10 meter Open Area Test Sites (IC 2324C-3, IC 2324C-5) / 3M Semi Anechoic Chamber (IC 6106)	 Canada IC 2324C-3 IC 2324C-5 IC 6106

* No part of this report may be used to claim or imply product endorsement by A2LA or any agency of the US Government.



6. SETUP OF EQUIPMENT UNDER TEST

6.1 SETUP CONFIGURATION OF EUT

See test photographs attached in Appendix I for the actual connections between EUT and support equipment.

6.2 SUPPORT EQUIPMENT

No.	Device Type	Brand	Model	Series No.	FCC ID	Data Cable	Power Cord
1.	Universal Radio Communication tester	R&S	CMU 200	1100.000.8.02	N/A	N/A	Unshielded, 1.8m

Remark:

- 1. All the equipment/cables were placed in the worst-case configuration to maximize the emission during the test.*
- 2. Grounding was established in accordance with the manufacturer's requirements and conditions for the intended use.*



7. FCC PART 22 & 24 REQUIREMENTS

7.1 AVERAGE POWER

LIMIT

According to FCC §2.1046.

Test Configuration

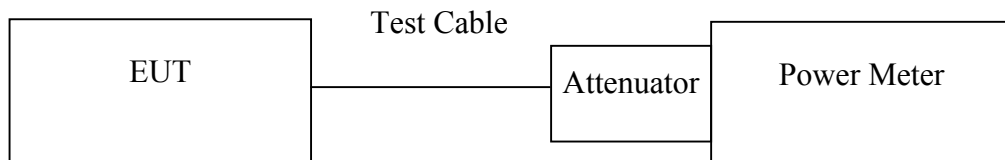

Remark: Measurement setup for testing on Antenna connector

TEST PROCEDURE

The transmitter output was connected to a calibrated attenuator, the other end of which was connected to a power meter. Transmitter output was read off the power meter in dBm. The power output at the transmitter antenna port was determined by adding the value of the attenuator to the power meter reading.



TEST RESULTS

No non-compliance noted.

Test Data

Test Mode	CH	Frequency (MHz)	Power Meter Reading (dBm)	Attenuator (dB)	Average Power (dBm)
GSM 850 (Class A)	128	824.20	12.13	20.50	32.63
	190	836.60	12.29		32.79
	251	848.80	12.45		32.95
GPRS 850 (Class 10)	128	824.20	12.12		32.62
	190	836.60	12.27		32.77
	251	848.80	12.48		32.98
EDGE 850 (Class 10)	128	824.20	6.48	20.50	26.98
	190	836.60	6.42		26.92
	251	848.80	6.40		26.90

Test Mode	CH	Frequency (MHz)	Power Meter Reading (dBm)	Attenuator (dB)	Average Power (dBm)
GSM 1900 (Class A)	512	1850.20	7.64	20.50	28.14
	661	1880.00	7.62		28.12
	810	1910.00	8.11		28.61
GPRS 1900 (Class 10)	512	1850.20	7.65		28.15
	661	1880.00	7.61		28.11
	810	1910.00	8.10		28.60
EDGE 1900 (Class 10)	512	1850.20	4.95	20.50	25.45
	661	1880.00	4.72		25.22
	810	1910.00	5.27		25.77

Remark: *The value of factor includes both the loss of cable and external attenuator*



Test Mode	CH	Frequency (MHz)	Power Meter Reading (dBm)	Attenuator (dB)	Average Power (dBm)
WCDMA (BAND II)	9262	1852.40	3.58	24.50	24.08
	9400	1880.00	3.48		23.98
	9538	1907.60	3.52		24.02
WCDMA (BAND V)	4132	826.40	4.77		25.27
	4183	836.60	5.83		26.33
	4233	846.60	5.38		25.88
Test Mode	CH	Frequency (MHz)	Power Meter Reading (dBm)	Attenuator (dB)	Average Power (dBm)
WCDMA / HSDPA (BAND II)	9262	1852.40	4.88	24.50	25.38
	9400	1880.00	4.62		25.12
	9538	1907.60	4.96		25.46
WCDMA / HSDPA (BAND V)	4132	826.40	6.14		26.64
	4183	836.60	6.83		27.33
	4233	846.60	6.45		26.95

Remark: The value of factor includes both the loss of cable and external attenuator

7.2 ERP & EIRP MEASUREMENT

LIMIT

According to FCC §2.1046

FCC 22.913(b): The Effective Radiated Power (ERP) of mobile transmitters must not exceed 7 Watts.

FCC 24.232(b): The equivalent Isotropic Radiated Power (EIRP) must not exceed 2 Watts.

TEST CONFIGURATION

Below 1 GHz

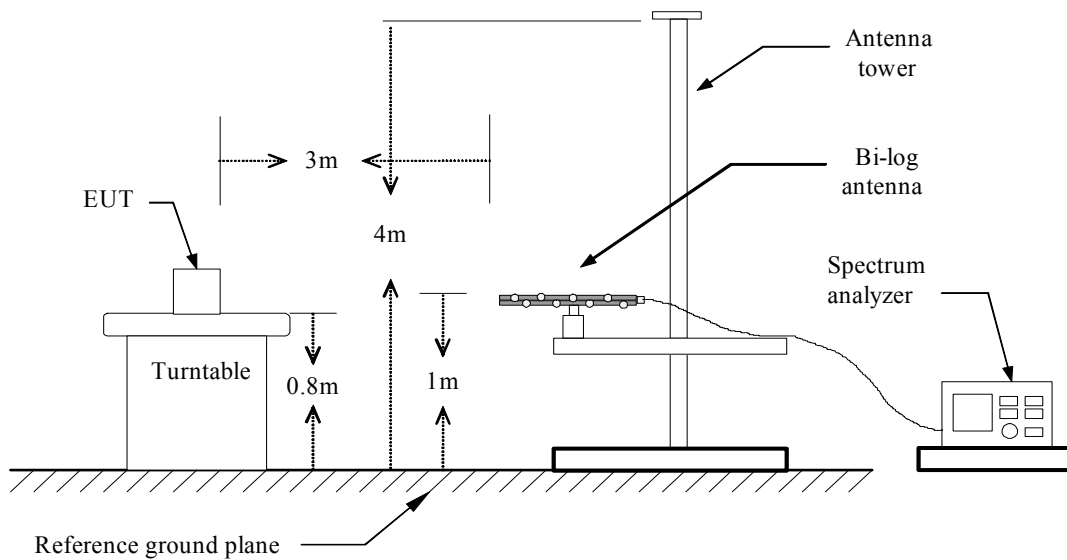

Above 1 GHz

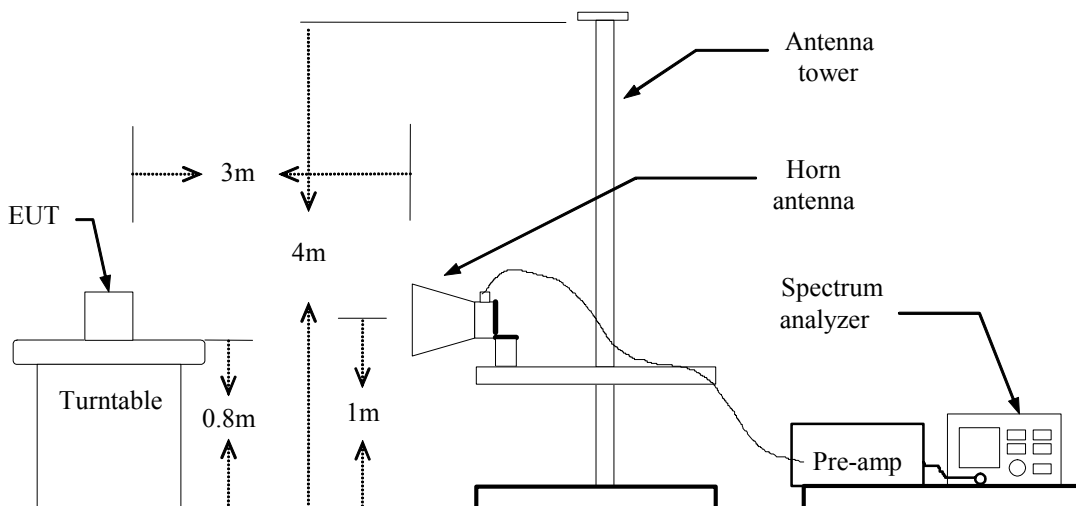

For Substituted Method Test Set-UP

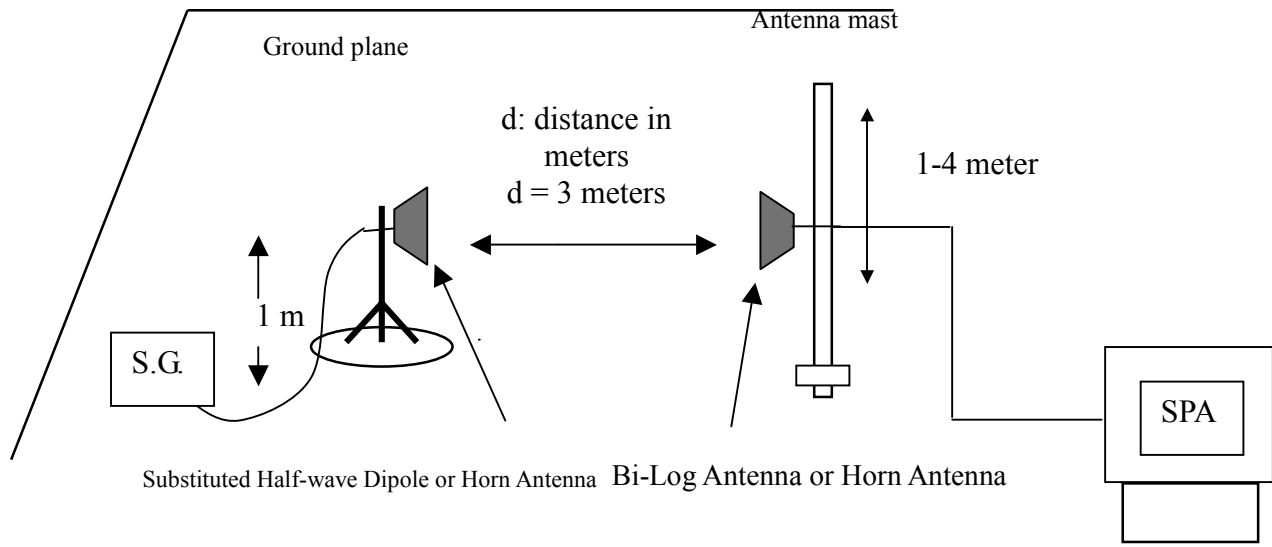

TEST PROCEDURE

The EUT was placed on a non-conductive turntable using a non-conductive support. The radiated emission at the fundamental frequency was measured at 3 m with a test antenna and EMI spectrum analyzer.

During the measurement of the EUT, the resolution bandwidth was set to 3MHz and the average bandwidth was set to 3MHz. The highest emission was recorded with the rotation of the turntable and the lowering of the test antenna. The reading was recorded and the field strength (E in dBuV/m) was calculated.

ERP in frequency band 824-849MHz, and EIRP in frequency band 1851.25 –1910MHz were measured using a substitution method. The EUT was replaced by half-wave dipole (824-849MHz) or horn antenna (1851.25-1910MHz) connected to a signal generator. The spectrum analyzer reading was recorded and ERP/EIRP was calculated as follows:

$$ERP = \text{S.G. output (dBm)} + \text{Antenna Gain (dBd)} - \text{Cable (dB)}$$

$$EIRP = \text{S.G. output (dBm)} + \text{Antenna Gain (dBi)} - \text{Cable (dB)}$$

**TEST RESULTS***No non-compliance noted.***Close Mode****GSM 850 Test Data (Class A)**

EUT Pol.	Channel	Frequency (MHz)	Antenna Pol.	Reading level (dBuV)	Correction Factor (dB)	Emission level (dBm)	Limit (dBm)	Margin (dB)
X	128	824.20	V	-12.76	36.41	23.65	38.45	-14.80
		824.20	H	-7.21	36.21	29.00	38.45	-9.45
	190	836.55	V	-9.79	36.54	26.75	38.45	-11.70
		836.80	H	-4.64	36.48	31.85	38.45	-6.60
	251	848.85	V	-9.87	36.67	26.80	38.45	-11.65
		848.95	H	-5.29	36.65	31.36	38.45	-7.09
Y	128	824.30	V	-12.84	36.41	23.57	38.45	-14.88
		824.30	H	-8.14	36.21	28.07	38.45	-10.38
	190	836.50	V	-10.00	36.54	26.53	38.45	-11.92
		836.55	H	-5.43	36.48	31.05	38.45	-7.40
	251	848.85	V	-10.18	36.67	26.48	38.45	-11.97
		848.85	H	-5.64	36.65	31.01	38.45	-7.44
Z	128	824.20	V	-8.92	36.41	27.49	38.45	-10.96
		824.20	H	-15.27	36.21	20.94	38.45	-17.51
	190	836.60	V	-6.35	36.54	30.19	38.45	-8.26
		836.60	H	-11.73	36.48	24.75	38.45	-13.70
	251	848.85	V	-6.63	36.67	30.03	38.45	-8.42
		848.85	H	-11.40	36.65	25.24	38.45	-13.21

GPRS 850 Test Data (Class 10)

EUT Pol.	Channel	Frequency (MHz)	Antenna Pol.	Reading level (dBuV)	Correction Factor (dB)	Emission level (dBm)	Limit (dBm)	Margin (dB)
X	128	824.20	V	-13.25	36.41	23.16	38.45	-15.29
		824.20	H	-7.29	36.21	28.92	38.45	-9.53
	190	836.55	V	-10.00	36.54	26.54	38.45	-11.91
		836.55	H	-5.70	36.48	30.78	38.45	-7.67
	251	848.75	V	-10.99	36.67	25.68	38.45	-12.77
		848.75	H	-6.32	36.65	30.33	38.45	-8.12
Y	128	824.20	V	-12.67	36.41	23.74	38.45	-14.71
		824.20	H	-8.57	36.21	27.63	38.45	-10.82
	190	836.75	V	-9.47	36.54	27.07	38.45	-11.38
		836.75	H	-6.79	36.48	29.69	38.45	-8.76
	251	848.95	V	-9.26	36.67	27.41	38.45	-11.04
		848.70	H	-7.24	36.65	29.41	38.45	-9.04
Z	128	824.20	V	-8.42	36.41	27.99	38.45	-10.46
		824.20	H	-14.94	36.21	21.26	38.45	-17.19
	190	836.65	V	-6.26	36.54	30.28	38.45	-8.17
		836.65	H	-11.66	36.48	24.82	38.45	-13.63
	251	848.75	V	-6.66	36.67	30.00	38.45	-8.45
		848.75	H	-11.69	36.65	24.95	38.45	-13.50



GSM 1900 Test Data (Class A)

EUT Pol.	Channel	Frequency (MHz)	Antenna Pol.	Reading level (dBuV)	Correction Factor (dB)	Emission level (dBm)	Limit (dBm)	Margin (dB)
X	512	1850.40	V	-21.96	44.22	22.25	33.00	-10.75
		1850.10	H	-19.21	42.89	23.67	33.00	-9.33
	661	1880.00	V	-24.43	44.02	19.59	33.00	-13.41
		1880.30	H	-19.72	43.01	23.29	33.00	-9.71
	810	1909.90	V	-26.51	43.88	17.37	33.00	-15.63
		1909.90	H	-19.90	43.10	23.19	33.00	-9.81
Y	512	1850.10	V	-18.98	44.22	25.24	33.00	-7.76
		1850.10	H	-17.82	42.89	25.07	33.00	-7.93
	661	1879.80	V	-20.32	44.02	23.70	33.00	-9.30
		1879.80	H	-20.06	43.01	22.95	33.00	-10.05
	810	1909.60	V	-18.69	43.88	25.19	33.00	-7.81
		1909.90	H	-22.62	43.10	20.47	33.00	-12.53
Z	512	1850.10	V	-22.08	44.22	22.14	33.00	-10.86
		1850.10	H	-20.78	42.89	22.10	33.00	-10.90
	661	1880.10	V	-21.49	44.02	22.53	33.00	-10.47
		1880.30	H	-21.20	43.01	21.81	33.00	-11.19
	810	1909.70	V	-20.12	43.10	22.98	33.00	-10.02
		1909.70	H	-20.07	43.10	23.03	33.00	-9.97

GPRS 1900 Test Data (Class 10)

EUT Pol.	Channel	Frequency (MHz)	Antenna Pol.	Reading level (dBuV)	Correction Factor (dB)	Emission level (dBm)	Limit (dBm)	Margin (dB)
X	512	1850.20	V	-23.58	44.22	20.64	33.00	-12.36
		1850.20	H	-20.32	42.89	22.56	33.00	-10.44
	661	1879.80	V	-23.97	44.02	20.04	33.00	-12.96
		1879.80	H	-19.84	43.01	23.16	33.00	-9.84
	810	1909.40	V	-26.59	43.88	17.29	33.00	-15.71
		1909.70	H	-19.95	43.10	23.14	33.00	-9.86
Y	512	1850.40	V	-19.49	44.22	24.73	33.00	-8.27
		1850.40	H	-18.22	42.89	24.67	33.00	-8.33
	661	1880.10	V	-19.30	44.02	24.71	33.00	-8.29
		1880.10	H	-19.34	43.01	23.67	33.00	-9.33
	810	1909.90	V	-19.80	43.88	24.08	33.00	-8.92
		1909.90	H	-21.49	43.10	21.61	33.00	-11.39
Z	512	1850.20	V	-20.57	44.22	23.65	33.00	-9.35
		1850.20	H	-21.20	42.89	21.68	33.00	-11.32
	661	1880.10	V	-21.20	44.02	22.82	33.00	-10.18
		1880.10	H	-22.80	44.02	21.22	33.00	-11.79
	810	1909.90	V	-22.43	43.88	21.45	33.00	-11.55
		1909.70	H	-21.82	43.10	21.28	33.00	-11.72

**EDGE 850 Test Data (Class 10)**

EUT Pol.	Channel	Frequency (MHz)	Antenna Pol.	Reading level (dBuV)	Correction Factor (dB)	Emission level (dBm)	Limit (dBm)	Margin (dB)
X	128	824.22	V	-14.97	36.41	21.44	38.45	-17.01
		824.18	H	-10.11	36.21	26.10	38.45	-12.35
	190	836.64	V	-15.63	36.54	20.91	38.45	-17.54
		836.42	H	-9.37	36.48	27.10	38.45	-11.35
	251	848.88	V	-18.05	36.67	18.62	38.45	-19.83
		849.24	H	-10.80	36.65	25.86	38.45	-12.59
Y	128	824.27	V	-15.54	36.41	20.87	38.45	-17.58
		824.27	H	-9.71	36.21	26.50	38.45	-11.95
	190	836.51	V	-15.92	36.54	20.62	38.45	-17.83
		836.51	H	-9.01	36.48	27.47	38.45	-10.98
	251	848.88	V	-17.71	36.67	18.96	38.45	-19.49
		848.88	H	-10.48	36.65	26.17	38.45	-12.28
Z	128	824.27	V	-10.78	36.41	25.63	38.45	-12.82
		824.27	H	-17.68	36.21	18.53	38.45	-19.92
	190	836.64	V	-10.22	36.54	26.32	38.45	-12.13
		836.64	H	-17.15	36.48	19.33	38.45	-19.12
	251	848.93	V	-11.29	36.67	25.38	38.45	-13.07
		848.93	H	-18.60	36.65	18.05	38.45	-20.40

EDGE 1900 Test Data (Class 10)

EUT Pol.	Channel	Frequency (MHz)	Antenna Pol.	Reading level (dBuV)	Correction Factor (dB)	Emission level (dBm)	Limit (dBm)	Margin (dB)
X	512	1850.50	V	-26.38	44.22	17.83	33.00	-15.17
		1850.20	H	-23.95	42.89	18.93	33.00	-14.07
	661	1879.80	V	-27.23	44.02	16.78	33.00	-16.22
		1879.80	H	-23.61	43.01	19.39	33.00	-13.61
	810	1909.90	V	-28.30	43.88	15.58	33.00	-17.42
		1909.90	H	-23.61	43.10	19.48	33.00	-13.52
Y	512	1850.40	V	-22.67	44.22	21.55	33.00	-11.45
		1850.40	H	-22.59	42.89	20.30	33.00	-12.70
	661	1880.10	V	-22.53	44.02	21.48	33.00	-11.52
		1880.30	H	-23.77	43.01	19.24	33.00	-13.76
	810	1910.10	V	-23.04	43.88	20.85	33.00	-12.15
		1909.90	H	-25.69	43.10	17.40	33.00	-15.60
Z	512	1850.20	V	-21.46	44.22	22.76	33.00	-10.24
		1850.10	H	-20.45	42.89	22.44	33.00	-10.56
	661	1880.10	V	-23.43	44.02	20.58	33.00	-12.42
		1880.10	H	-20.02	43.01	22.99	33.00	-10.01
	810	1909.70	V	-27.25	43.88	16.63	33.00	-16.37
		1909.70	H	-24.16	43.10	18.94	33.00	-14.06

**WCDMA Test Data (BAND II)**

EUT Pol.	Channel	Frequency (MHz)	Antenna Pol.	Reading level (dBuV)	Correction Factor (dB)	Emission level (dBm)	Limit (dBm)	Margin (dB)
X	9262	1853.20	V	-29.30	44.20	14.90	33.00	-18.10
		1852.96	H	-24.08	42.90	18.81	33.00	-14.19
	9400	1879.76	V	-31.93	44.02	12.09	33.00	-20.91
		1880.48	H	-24.61	43.01	18.40	33.00	-14.60
	9538	1907.20	V	-33.91	43.88	9.97	33.00	-23.03
		1906.72	H	-24.18	43.09	18.91	33.00	-14.09
Y	9262	1852.96	V	-24.91	44.20	19.29	33.00	-13.71
		1853.36	H	-25.62	42.90	17.27	33.00	-15.73
	9400	1880.56	V	-25.20	44.01	18.81	33.00	-14.19
		1879.52	H	-27.53	43.01	15.47	33.00	-17.53
	9538	1908.16	V	-25.55	43.88	18.33	33.00	-14.67
		1906.72	H	-28.83	43.09	14.27	33.00	-18.73
Z	9262	1853.52	V	-27.71	44.20	16.48	33.00	-16.52
		1852.72	H	-23.95	42.90	18.95	33.00	-14.05
	9400	1880.80	V	-29.78	44.01	14.23	33.00	-18.77
		1880.96	H	-24.98	43.01	18.03	33.00	-14.97
	9538	1906.32	V	-28.69	43.88	15.19	33.00	-17.81
		1907.44	H	-25.73	43.10	17.37	33.00	-15.63

WCDMA Test Data (BAND V)

EUT Pol.	Channel	Frequency (MHz)	Antenna Pol.	Reading level (dBuV)	Correction Factor (dB)	Emission level (dBm)	Limit (dBm)	Margin (dB)
X	4132	826.61	V	-18.85	36.43	17.59	38.45	-20.86
		826.65	H	-14.18	36.26	22.08	38.45	-16.37
	4183	837.81	V	-19.89	36.55	16.66	38.45	-21.79
		837.95	H	-13.88	36.51	22.63	38.45	-15.82
	4233	845.42	V	-19.80	36.63	16.83	38.45	-21.62
		845.42	H	-13.44	36.61	23.17	38.45	-15.28
Y	4132	826.74	V	-22.62	36.44	13.81	38.45	-24.64
		826.74	H	-14.35	36.26	21.91	38.45	-16.54
	4183	837.81	V	-22.30	36.55	14.25	38.45	-24.20
		838.04	H	-14.08	36.51	22.43	38.45	-16.02
	4233	845.64	V	-20.76	36.63	15.87	38.45	-22.58
		845.78	H	-12.92	36.61	23.69	38.45	-14.76
Z	4132	826.74	V	-14.82	36.44	21.62	38.45	-16.83
		827.06	H	-25.02	36.27	11.26	38.45	-27.19
	4183	837.59	V	-14.46	36.55	22.09	38.45	-16.36
		837.81	H	-24.62	36.51	11.88	38.45	-26.57
	4233	845.64	V	-13.27	36.63	23.37	38.45	-15.08
		845.73	H	-23.94	36.61	12.68	38.45	-25.77

**WCDMA / HSDPA BAND II Test Data**

EUT Pol.	Channel	Frequency (MHz)	Antenna Pol.	Reading level (dBuV)	Correction Factor (dB)	Emission level (dBm)	Limit (dBm)	Margin (dB)
X	9262	1853.92	V	-29.33	44.19	14.87	33.00	-18.13
		1851.44	H	-23.87	42.89	19.02	33.00	-13.98
	9400	1881.36	V	-29.24	44.01	14.77	33.00	-18.23
		1879.20	H	-24.67	43.00	18.33	33.00	-14.67
	9538	1906.80	V	-31.53	43.88	12.35	33.00	-20.65
		1906.72	H	-24.76	43.09	18.33	33.00	-14.67
Y	9262	1853.60	V	-25.16	44.20	19.03	33.00	-13.97
		1853.52	H	-27.24	42.90	15.66	33.00	-17.34
	9400	1881.36	V	-25.67	44.01	18.34	33.00	-14.66
		1881.44	H	-26.88	43.01	16.13	33.00	-16.87
	9538	1906.72	V	-25.35	43.88	18.53	33.00	-14.47
		1906.72	H	-28.98	43.09	14.11	33.00	-18.89
Z	9262	1853.60	V	-28.05	44.20	16.15	33.00	-16.85
		1853.60	H	-25.38	42.90	17.52	33.00	-15.48
	9400	1881.36	V	-29.46	44.01	14.55	33.00	-18.45
		1880.96	H	-23.72	43.01	19.29	33.00	-13.71
	9538	1906.88	V	-27.72	43.88	16.16	33.00	-16.84
		1906.80	H	-25.96	43.09	17.13	33.00	-15.87

WCDMA / HSDPA BAND V Test Data

EUT Pol.	Channel	Frequency (MHz)	Antenna Pol.	Reading level (dBuV)	Correction Factor (dB)	Emission level (dBm)	Limit (dBm)	Margin (dB)
X	4132	827.55	V	-20.77	36.44	15.68	38.45	-22.77
		827.64	H	-17.96	36.28	18.32	38.45	-20.13
	4183	837.86	V	-21.48	36.55	15.07	38.45	-23.38
		837.90	H	-16.62	36.51	19.88	38.45	-18.57
	4233	845.73	V	-20.13	36.63	16.51	38.45	-21.94
		845.42	H	-15.24	36.61	21.37	38.45	-17.08
Y	4132	827.55	V	-23.77	36.44	12.67	38.45	-25.78
		827.46	H	-15.99	36.28	20.29	38.45	-18.16
	4183	837.86	V	-24.39	36.55	12.16	38.45	-26.29
		837.54	H	-15.66	36.50	20.84	38.45	-17.61
	4233	846.54	V	-23.01	36.64	13.63	38.45	-24.82
		845.19	H	-14.22	36.61	22.39	38.45	-16.06
Z	4132	827.51	V	-14.96	36.44	21.48	38.45	-16.97
		827.33	H	-25.70	36.28	10.58	38.45	-27.87
	4183	837.45	V	-14.44	36.55	22.11	38.45	-16.34
		837.81	H	-25.69	36.51	10.82	38.45	-27.63
	4233	845.55	V	-13.26	36.63	23.37	38.45	-15.08
		845.55	H	-24.86	36.61	11.76	38.45	-26.69

**Slide Mode****GSM 850 Test Data (Class A)**

EUT Pol.	Channel	Frequency (MHz)	Antenna Pol.	Reading level (dBuV)	Correction Factor (dB)	Emission level (dBm)	Limit (dBm)	Margin (dB)
X	128	824.20	V	-13.11	36.41	23.30	38.45	-15.15
		824.20	H	-6.24	36.21	29.96	38.45	-8.49
	190	836.65	V	-10.74	36.54	25.80	38.45	-12.65
		836.65	H	-4.06	36.48	32.42	38.45	-6.03
	251	848.70	V	-11.00	36.67	25.66	38.45	-12.79
		848.95	H	-5.69	36.65	30.96	38.45	-7.49
Y	128	824.30	V	-11.79	36.41	24.62	38.45	-13.83
		824.30	H	-8.01	36.21	28.20	38.45	-10.25
	190	836.75	V	-8.79	36.54	27.75	38.45	-10.70
		836.50	H	-6.72	36.48	29.76	38.45	-8.69
	251	848.85	V	-8.96	36.67	27.71	38.45	-10.74
		848.85	H	-7.51	36.65	29.14	38.45	-9.31
Z	128	824.30	V	-8.71	36.41	27.70	38.45	-10.75
		824.30	H	-16.85	36.21	19.36	38.45	-19.09
	190	836.65	V	-6.39	36.54	30.15	38.45	-8.30
		836.55	H	-14.37	36.48	22.11	38.45	-16.34
	251	848.85	V	-7.25	36.67	29.42	38.45	-9.03
		848.85	H	-15.52	36.65	21.12	38.45	-17.33

GPRS 850 Test Data (Class 10)

EUT Pol.	Channel	Frequency (MHz)	Antenna Pol.	Reading level (dBuV)	Correction Factor (dB)	Emission level (dBm)	Limit (dBm)	Margin (dB)
X	128	824.20	V	-13.89	36.41	22.52	38.45	-15.93
		824.20	H	-7.99	36.21	28.21	38.45	-10.24
	190	836.70	V	-11.41	36.54	25.13	38.45	-13.32
		836.70	H	-6.39	36.48	30.09	38.45	-8.36
	251	848.75	V	-11.96	36.67	24.71	38.45	-13.74
		848.75	H	-7.16	36.65	29.49	38.45	-8.96
Y	128	824.35	V	-12.77	36.41	23.64	38.45	-14.81
		824.45	H	-8.50	36.21	27.71	38.45	-10.74
	190	836.75	V	-10.15	36.54	26.39	38.45	-12.06
		836.75	H	-6.75	36.48	29.73	38.45	-8.72
	251	848.85	V	-11.07	36.67	25.60	38.45	-12.85
		849.15	H	-7.25	36.65	29.40	38.45	-9.05
Z	128	824.35	V	-8.54	36.41	27.87	38.45	-10.58
		824.35	H	-16.73	36.21	19.49	38.45	-18.96
	190	836.80	V	-6.34	36.54	30.20	38.45	-8.25
		836.80	H	-14.45	36.48	22.03	38.45	-16.42
	251	848.85	V	-7.26	36.67	29.41	38.45	-9.04
		848.75	H	-15.48	36.65	21.17	38.45	-17.28

**GSM 1900 Test Data (Class A)**

EUT Pol.	Channel	Frequency (MHz)	Antenna Pol.	Reading level (dBuV)	Correction Factor (dB)	Emission level (dBm)	Limit (dBm)	Margin (dB)
X	512	1850.40	V	-26.45	44.22	17.77	33.00	-15.23
		1850.20	H	-17.55	42.89	25.34	33.00	-7.66
	661	1880.00	V	-26.42	44.02	17.60	33.00	-15.40
		1880.00	H	-17.31	43.01	25.70	33.00	-7.30
	810	1909.70	V	-27.39	43.88	16.49	33.00	-16.51
		1909.70	H	-16.73	43.10	26.36	33.00	-6.64
Y	512	1850.20	V	-16.11	44.22	28.11	33.00	-4.89
		1849.90	H	-20.99	42.88	21.89	33.00	-11.11
	661	1880.00	V	-16.91	44.02	27.11	33.00	-5.89
		1880.30	H	-22.09	43.01	20.92	33.00	-12.08
	810	1909.90	V	-16.15	43.88	27.73	33.00	-5.27
		1909.90	H	-21.58	43.10	21.52	33.00	-11.48
Z	512	1850.10	V	-17.96	44.22	26.26	33.00	-6.74
		1850.40	H	-18.86	42.89	24.02	33.00	-8.98
	661	1879.90	V	-20.06	44.02	23.96	33.00	-9.04
		1880.00	H	-19.23	43.01	23.77	33.00	-9.23
	810	1909.70	V	-20.58	43.88	23.30	33.00	-9.70
		1909.50	H	-18.56	43.10	24.54	33.00	-8.46

GPRS 1900 Test Data (Class 10)

EUT Pol.	Channel	Frequency (MHz)	Antenna Pol.	Reading level (dBuV)	Correction Factor (dB)	Emission level (dBm)	Limit (dBm)	Margin (dB)
X	512	1850.40	V	-25.86	44.22	18.35	33.00	-14.65
		1849.90	H	-17.61	42.88	25.27	33.00	-7.73
	661	1879.80	V	-26.26	44.02	17.75	33.00	-15.25
		1879.80	H	-17.49	43.01	25.51	33.00	-7.49
	810	1909.70	V	-26.22	43.88	17.66	33.00	-15.34
		1909.70	H	-16.64	43.10	26.46	33.00	-6.54
Y	512	1850.40	V	-16.31	44.22	27.90	33.00	-5.10
		1850.40	H	-20.61	42.89	22.28	33.00	-10.72
	661	1880.10	V	-17.16	44.02	26.86	33.00	-6.14
		1880.00	H	-22.23	43.01	20.78	33.00	-12.22
	810	1909.70	V	-17.00	43.88	26.88	33.00	-6.12
		1909.90	H	-22.66	43.10	20.43	33.00	-12.57
Z	512	1850.20	V	-17.85	44.22	26.37	33.00	-6.63
		1850.20	H	-19.59	42.89	23.30	33.00	-9.70
	661	1880.00	V	-19.95	44.02	24.07	33.00	-8.93
		1879.80	H	-19.08	43.01	23.93	33.00	-9.07
	810	1910.10	V	-20.40	43.88	23.48	33.00	-9.52
		1909.80	H	-17.94	43.10	25.16	33.00	-7.84

**EDGE 850 Test Data (Class 10)**

EUT Pol.	Channel	Frequency (MHz)	Antenna Pol.	Reading level (dBuV)	Correction Factor (dB)	Emission level (dBm)	Limit (dBm)	Margin (dB)
X	128	824.58	V	-16.54	36.41	19.88	38.45	-18.57
		824.40	H	-10.94	36.21	25.28	38.45	-13.17
	190	836.37	V	-17.00	36.54	19.53	38.45	-18.92
		836.64	H	-10.30	36.48	26.18	38.45	-12.27
	251	848.88	V	-18.81	36.67	17.86	38.45	-20.59
		848.70	H	-11.17	36.65	25.47	38.45	-12.98
Y	128	824.36	V	-13.33	36.41	23.09	38.45	-15.36
		824.63	H	-11.37	36.22	24.85	38.45	-13.60
	190	836.69	V	-13.57	36.54	22.97	38.45	-15.48
		836.55	H	-10.53	36.48	25.95	38.45	-12.50
	251	848.57	V	-15.46	36.66	21.20	38.45	-17.25
		848.70	H	-11.99	36.65	24.65	38.45	-13.80
Z	128	824.27	V	-10.41	36.41	26.00	38.45	-12.45
		824.27	H	-19.41	36.21	16.80	38.45	-21.65
	190	836.51	V	-10.07	36.54	26.47	38.45	-11.98
		836.51	H	-19.32	36.48	17.16	38.45	-21.29
	251	848.93	V	-11.34	36.67	25.33	38.45	-13.12
		848.93	H	-21.31	36.65	15.33	38.45	-23.12

EDGE 1900 Test Data (Class 10)

EUT Pol.	Channel	Frequency (MHz)	Antenna Pol.	Reading level (dBuV)	Correction Factor (dB)	Emission level (dBm)	Limit (dBm)	Margin (dB)
X	512	1850.40	V	-29.74	44.22	14.48	33.00	-18.52
		1850.50	H	-21.48	42.89	21.41	33.00	-11.59
	661	1880.10	V	-30.08	44.02	13.94	33.00	-19.06
		1880.10	H	-21.23	43.01	21.78	33.00	-11.22
	810	1909.90	V	-31.07	43.88	12.81	33.00	-20.19
		1909.60	H	-19.93	43.10	23.17	33.00	-9.83
Y	512	1850.00	V	-19.89	44.22	24.33	33.00	-8.67
		1850.10	H	-24.75	42.89	18.13	33.00	-14.87
	661	1880.30	V	-20.34	44.01	23.67	33.00	-9.33
		1880.30	H	-25.21	43.01	17.80	33.00	-15.20
	810	1910.20	V	-20.58	43.88	23.30	33.00	-9.70
		1910.20	H	-26.05	43.10	17.05	33.00	-15.95
Z	512	1850.20	V	-22.42	44.22	21.80	33.00	-11.20
		1849.90	H	-22.59	42.88	20.29	33.00	-12.71
	661	1880.10	V	-23.67	44.02	20.34	33.00	-12.66
		1880.10	H	-21.96	43.01	21.05	33.00	-11.95
	810	1910.10	V	-24.25	43.88	19.63	33.00	-13.37
		1910.10	H	-21.58	43.10	21.52	33.00	-11.48

**WCDMA Test Data (BAND II)**

EUT Pol.	Channel	Frequency (MHz)	Antenna Pol.	Reading level (dBuV)	Correction Factor (dB)	Emission level (dBm)	Limit (dBm)	Margin (dB)
X	9262	1853.12	V	-32.36	44.20	11.84	33.00	-21.16
		1853.36	H	-22.70	42.90	20.19	33.00	-12.81
	9400	1880.56	V	-33.80	44.01	10.21	33.00	-22.79
		1880.24	H	-22.22	43.01	20.79	33.00	-12.21
	9538	1906.88	V	-35.56	43.88	8.32	33.00	-24.68
		1907.20	H	-22.54	43.10	20.56	33.00	-12.44
Y	9262	1853.28	V	-23.00	44.20	21.20	33.00	-11.80
		1853.04	H	-25.86	42.90	17.04	33.00	-15.96
	9400	1880.00	V	-22.54	44.02	21.47	33.00	-11.53
		1880.00	H	-27.78	43.01	15.23	33.00	-17.77
	9538	1906.56	V	-22.77	43.88	21.11	33.00	-11.89
		1906.56	H	-27.88	43.09	15.21	33.00	-17.79
Z	9262	1853.04	V	-23.71	44.20	20.49	33.00	-12.51
		1854.00	H	-30.55	42.90	12.35	33.00	-20.65
	9400	1881.28	V	-26.33	44.01	17.68	33.00	-15.32
		1881.28	H	-24.22	43.01	18.79	33.00	-14.21
	9538	1908.00	V	-27.26	43.88	16.62	33.00	-16.38
		1908.00	H	-24.49	43.10	18.61	33.00	-14.39

WCDMA Test Data (BAND V)

EUT Pol.	Channel	Frequency (MHz)	Antenna Pol.	Reading level (dBuV)	Correction Factor (dB)	Emission level (dBm)	Limit (dBm)	Margin (dB)
X	4132	826.56	V	-20.64	36.43	15.79	38.45	-22.66
		826.61	H	-14.44	36.26	21.82	38.45	-16.63
	4183	837.68	V	-21.43	36.55	15.12	38.45	-23.33
		837.68	H	-14.02	36.50	22.48	38.45	-15.97
	4233	846.00	V	-21.70	36.64	14.94	38.45	-23.51
		845.64	H	-13.30	36.61	23.31	38.45	-15.14
Y	4132	826.34	V	-19.80	36.43	16.64	38.45	-21.81
		826.74	H	-14.54	36.26	21.73	38.45	-16.72
	4183	838.17	V	-20.34	36.56	16.22	38.45	-22.23
		837.50	H	-14.84	36.50	21.66	38.45	-16.79
	4233	845.78	V	-18.89	36.63	17.74	38.45	-20.71
		845.87	H	-14.35	36.62	22.27	38.45	-16.18
Z	4132	826.70	V	-16.60	36.44	19.84	38.45	-18.61
		827.06	H	-18.28	36.27	17.99	38.45	-20.46
	4183	837.81	V	-16.69	36.55	19.86	38.45	-18.59
		837.68	H	-18.09	36.50	18.41	38.45	-20.04
	4233	845.51	V	-15.45	36.63	21.19	38.45	-17.26
		845.51	H	-17.44	36.61	19.17	38.45	-19.28

**WCDMA / HSDPA BAND II Test Data**

EUT Pol.	Channel	Frequency (MHz)	Antenna Pol.	Reading level (dBuV)	Correction Factor (dB)	Emission level (dBm)	Limit (dBm)	Margin (dB)
X	9262	1853.52	V	-32.66	44.20	11.54	33.00	-21.46
		1853.52	H	-22.43	42.90	20.47	33.00	-12.53
	9400	1880.88	V	-33.20	44.01	10.81	33.00	-22.19
		1880.88	H	-22.03	43.01	20.99	33.00	-12.01
	9538	1906.64	V	-33.71	43.88	10.17	33.00	-22.83
		1906.64	H	-22.25	43.09	20.84	33.00	-12.16
Y	9262	1853.36	V	-22.35	44.20	21.84	33.00	-11.16
		1853.52	H	-26.30	42.90	16.59	33.00	-16.41
	9400	1881.12	V	-22.91	44.01	21.10	33.00	-11.90
		1880.96	H	-27.48	43.01	15.53	33.00	-17.47
	9538	1906.80	V	-21.20	43.88	22.68	33.00	-10.32
		1906.32	H	-27.31	43.09	15.79	33.00	-17.21
Z	9262	1853.76	V	-22.45	44.19	21.75	33.00	-11.25
		1853.68	H	-22.50	42.90	20.40	33.00	-12.60
	9400	1881.04	V	-26.04	44.01	17.97	33.00	-15.03
		1881.20	H	-24.14	43.01	18.88	33.00	-14.12
	9538	1906.80	V	-27.24	43.88	16.64	33.00	-16.36
		1908.96	H	-24.39	43.10	18.71	33.00	-14.29

WCDMA / HSDPA BAND V Test Data

EUT Pol.	Channel	Frequency (MHz)	Antenna Pol.	Reading level (dBuV)	Correction Factor (dB)	Emission level (dBm)	Limit (dBm)	Margin (dB)
X	4132	827.46	V	-20.31	36.44	16.14	38.45	-22.31
		827.69	H	-14.48	36.28	21.80	38.45	-16.65
	4183	837.81	V	-21.10	36.55	15.45	38.45	-23.00
		837.90	H	-15.80	36.51	20.71	38.45	-17.74
	4233	845.33	V	-20.37	36.63	16.26	38.45	-22.19
		845.73	H	-14.92	36.61	21.70	38.45	-16.75
Y	4132	827.51	V	-25.13	36.44	11.31	38.45	-27.14
		827.46	H	-18.83	36.28	17.45	38.45	-21.00
	4183	837.90	V	-16.62	36.55	19.93	38.45	-18.52
		837.59	H	-17.85	36.50	18.65	38.45	-19.80
	4233	845.51	V	-19.17	36.63	17.46	38.45	-20.99
		845.42	H	-16.50	36.61	20.11	38.45	-18.34
Z	4132	826.70	V	-16.48	36.44	19.95	38.45	-18.50
		827.51	H	-18.80	36.28	17.48	38.45	-20.97
	4183	837.90	V	-16.66	36.55	19.90	38.45	-18.55
		837.77	H	-18.38	36.51	18.13	38.45	-20.32
	4233	845.64	V	-15.49	36.63	21.14	38.45	-17.31
		845.64	H	-17.86	36.61	18.75	38.45	-19.70

7.3 OCCUPIED BANDWIDTH MEASUREMENT

LIMIT

According to §FCC 2.1049.

Test Configuration

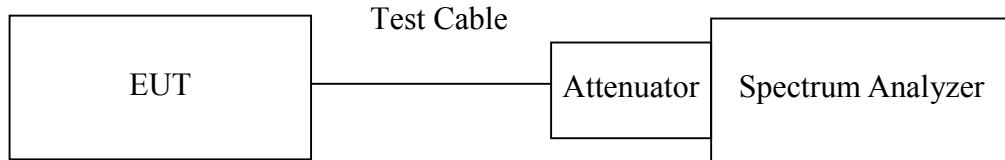

Remark: Measurement setup for testing on Antenna connector

TEST PROCEDURE

The EUT's output RF connector was connected with a short cable to the spectrum analyzer, RBW was set to about 1% of emission BW, VBW is set to 3 times the RBW, -26dBc display line was placed on the screen (or 99% bandwidth), the occupied bandwidth is the delta frequency between the two points where the display line intersects the signal trace.



TEST RESULTS

No non-compliance noted.

Test Data

Test Mode	CH	Frequency (MHz)	99% Bandwidth (kHz)
GSM 850 (Class A)	128	824.187	246.5601
	190	836.590	248.1062
	251	848.813	248.7921
GPRS 850 (Class 10)	128	824.187	248.5309
	190	836.590	244.9259
	251	848.787	242.7308
EDGE 850 (Class 10)	128	824.183	248.5942
	190	836.580	246.7300
	251	848.787	247.0904
GSM 1900 (Class A)	512	1850.217	249.6680
	661	1880.023	246.4414
	810	1909.790	250.1930
GPRS 1900 (Class 10)	512	1850.213	245.0721
	661	1879.997	246.8409
	810	1909.807	248.1252
EDGE 1900 (Class 10)	512	1850.187	248.5687
	661	1879.970	247.2705
	810	1909.773	244.8105



Test Mode	CH	Frequency (MHz)	99% Bandwidth (MHz)
WCDMA (Band II)	9262	1852.25	4.1572
	9400	1880.00	4.1694
	9538	1907.55	4.1714
WCDMA (Band V)	4132	826.40	4.1746
	4183	836.60	4.1541
	4233	846.65	4.1733
WCDMA / HSDPA (BAND II)	9262	1852.40	4.1603
	9400	1880.00	4.1694
	9538	1907.60	4.1812
WCDMA / HSDPA (BAND V)	4132	826.40	4.1627
	4183	836.50	4.1711
	4233	846.55	4.1897



Test Plot

GSM 850 (CH Low)

Agilent 14:00:35 Mar 11, 2008

R T

Mkr1 824.187 MHz

25.67 dBm

Ref 36.5 dBm

#Atten 26 dB

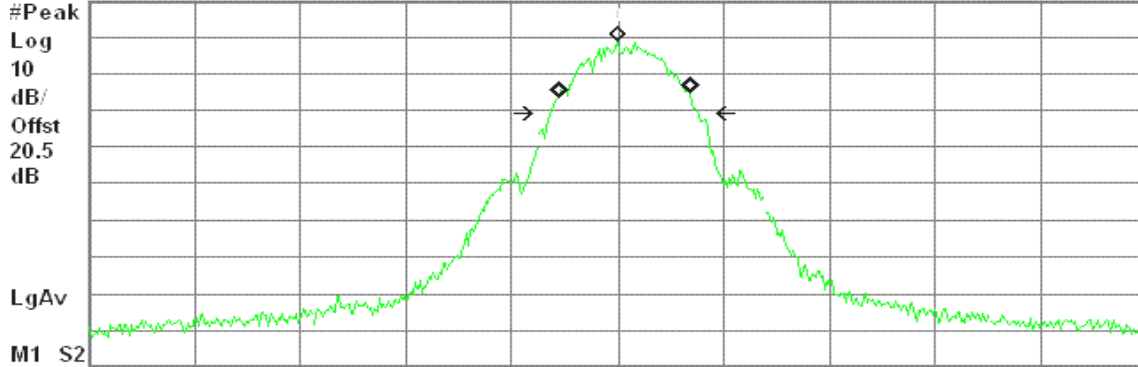

Center 824.187 MHz

Span 2 MHz

#Res BW 3 kHz

#VBW 10 kHz

Sweep 210.9 ms (601 pts)

Occupied Bandwidth
246.5601 kHz

Occ BW % Pwr 99.00 %

x dB -20.00 dB

Transmit Freq Error 13.152 kHz
x dB Bandwidth 278.604 kHz

GSM 850 (CH Mid)

Agilent 14:01:58 Mar 11, 2008

R T

Mkr1 836.590 MHz

22.26 dBm

Ref 36.5 dBm

#Atten 26 dB

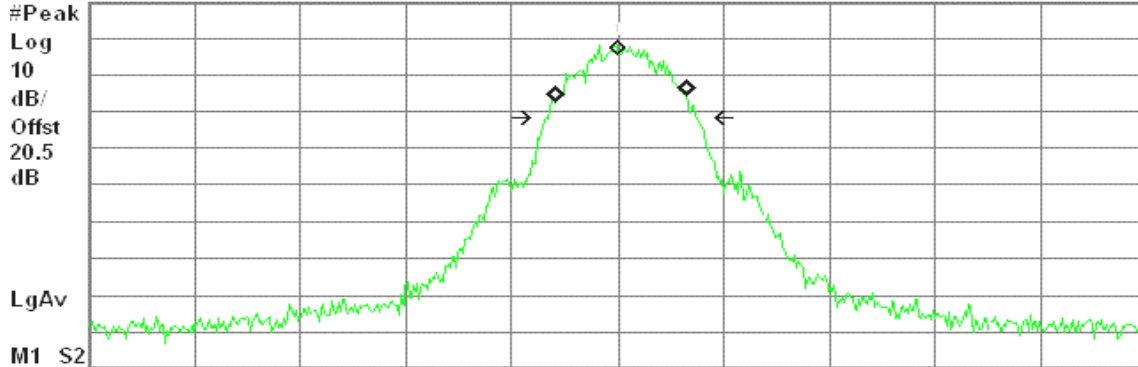

Center 836.590 MHz

Span 2 MHz

#Res BW 3 kHz

#VBW 10 kHz

Sweep 210.9 ms (601 pts)

Occupied Bandwidth
248.1062 kHz

Occ BW % Pwr 99.00 %

x dB -20.00 dB

Transmit Freq Error 6.998 kHz
x dB Bandwidth 278.906 kHz



GSM 850 (CH High)

Agilent 14:02:36 Mar 11, 2008

R T

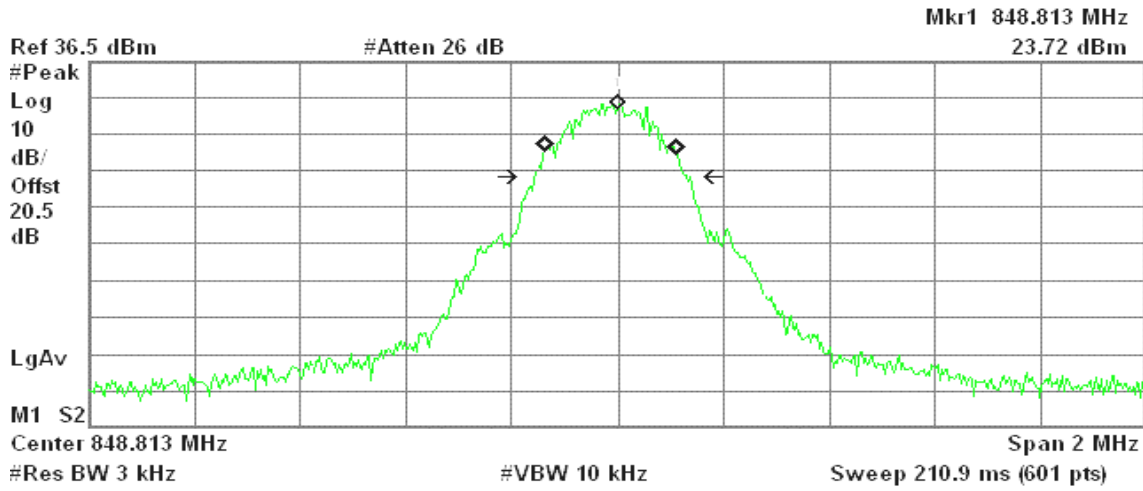

Occupied Bandwidth
248.7921 kHz

Occ BW % Pwr 99.00 %
x dB -20.00 dB

Transmit Freq Error -13.000 kHz
x dB Bandwidth 286.059 kHz

GPRS 850 (CH Low)

Agilent 14:01:02 Mar 11, 2008

R T

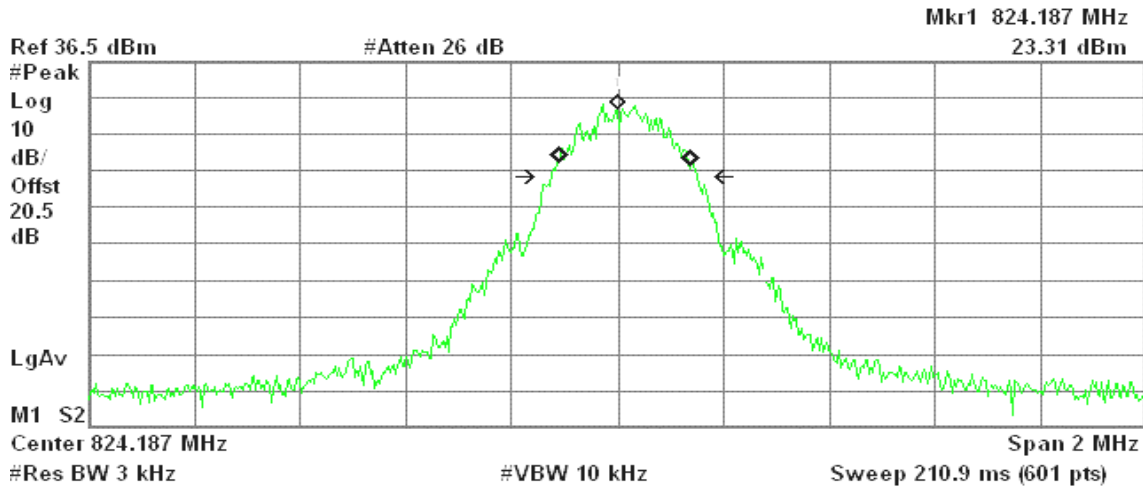

Occupied Bandwidth
248.5309 kHz

Occ BW % Pwr 99.00 %
x dB -20.00 dB

Transmit Freq Error 13.316 kHz
x dB Bandwidth 275.895 kHz



GPRS 850 (CH Mid)

Agilent 14:01:36 Mar 11, 2008

R T

Mkr1 836.590 MHz
24.65 dBm

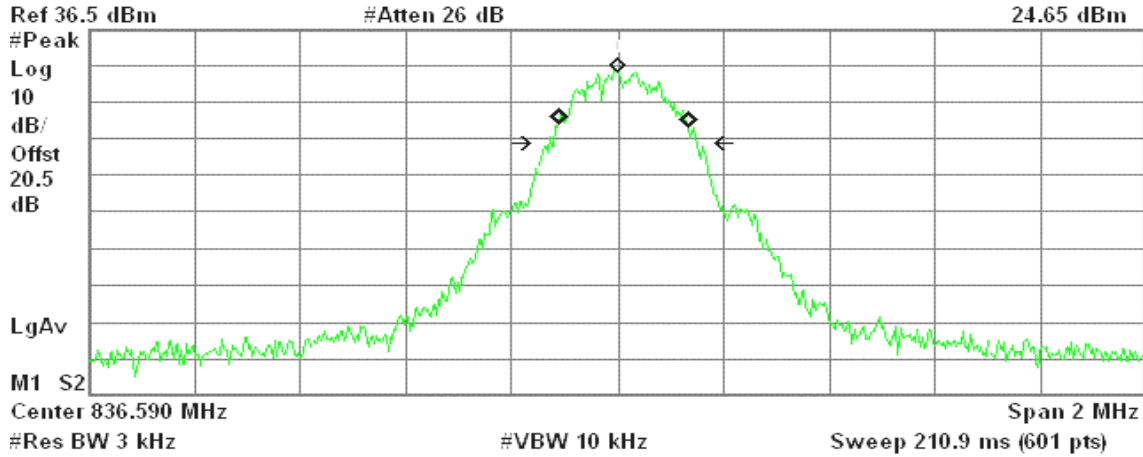

Occupied Bandwidth
244.9259 kHz

Occ BW % Pwr 99.00 %
x dB -20.00 dB

Transmit Freq Error 10.925 kHz
x dB Bandwidth 278.304 kHz

GPRS 850(CH High)

Agilent 14:02:51 Mar 11, 2008

R T

Mkr1 848.787 MHz
25.42 dBm

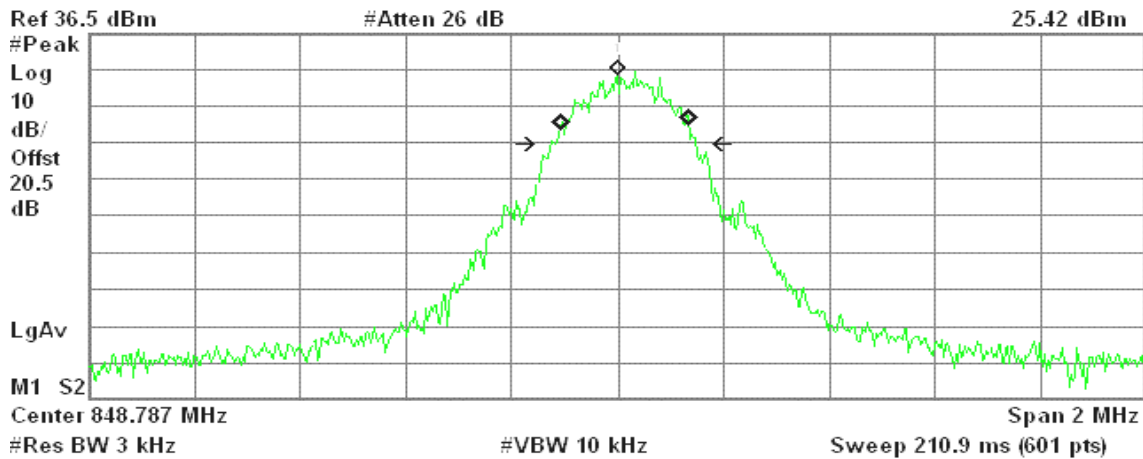

Occupied Bandwidth
242.7308 kHz

Occ BW % Pwr 99.00 %
x dB -20.00 dB

Transmit Freq Error 13.376 kHz
x dB Bandwidth 273.244 kHz



GSM 1900 (CH Low)

Agilent 15:21:31 Mar 11, 2008

R T

Mkr1 1.850 217 GHz
16.54 dBm

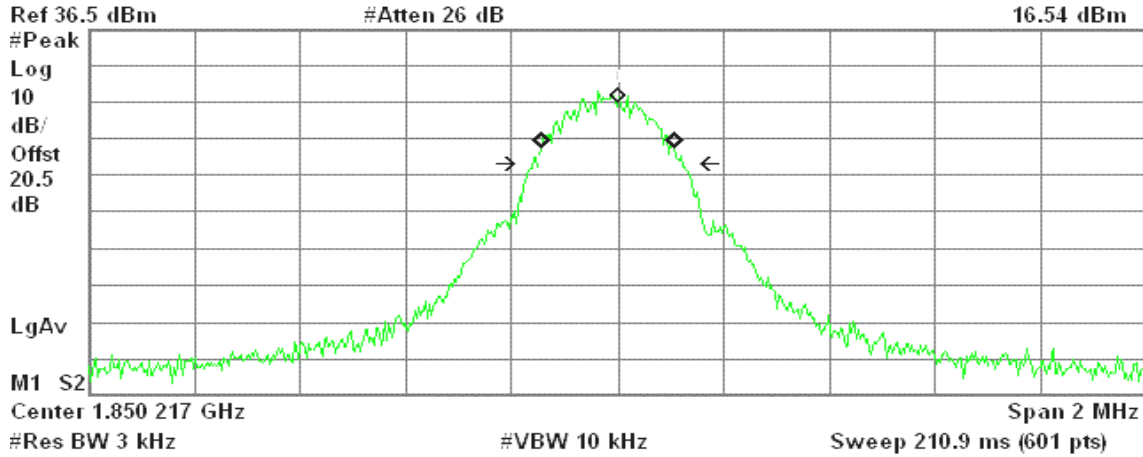

Occupied Bandwidth
249.6680 kHz

Occ BW % Pwr 99.00 %
x dB -20.00 dB

Transmit Freq Error -17.490 kHz
x dB Bandwidth 281.649 kHz

GSM 1900 (CH Mid)

Agilent 15:39:24 Mar 11, 2008

R T

Mkr1 1.880 023 GHz
18.22 dBm

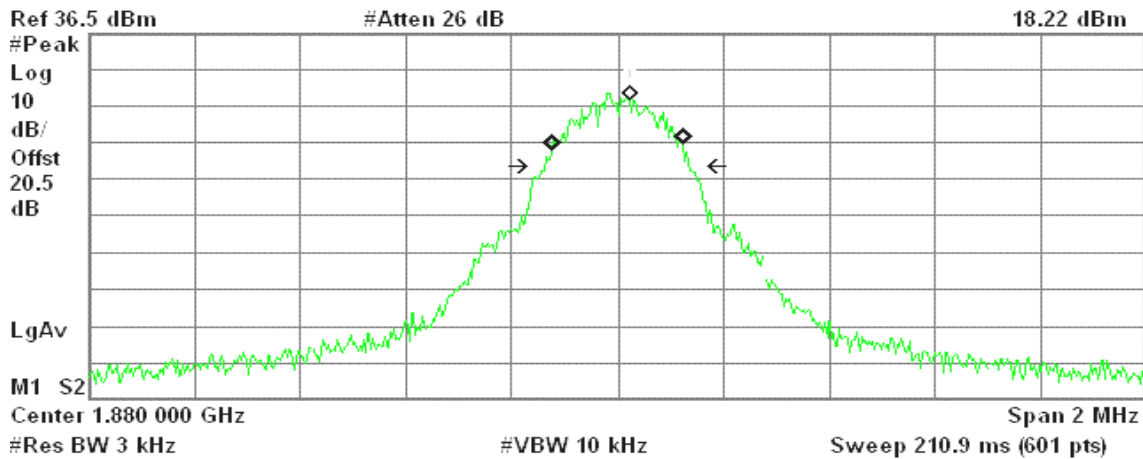

Occupied Bandwidth
246.4414 kHz

Occ BW % Pwr 99.00 %
x dB -20.00 dB

Transmit Freq Error 403.112 Hz
x dB Bandwidth 271.585 kHz



GSM 1900 (CH High)

Agilent 15:40:22 Mar 11, 2008

R T

Mkr1 1.909 790 GHz
20.30 dBm

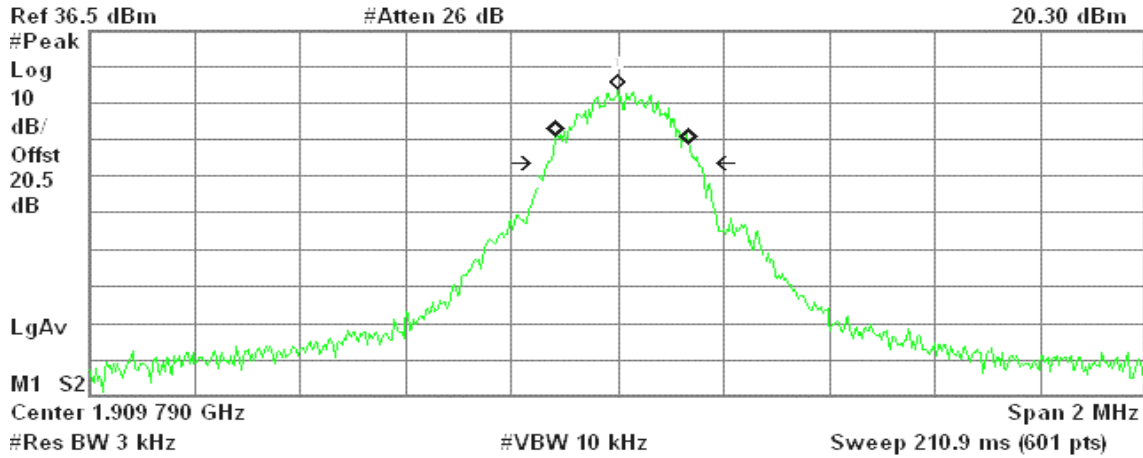

Occupied Bandwidth
250.1930 kHz

Occ BW % Pwr 99.00 %
x dB -20.00 dB

Transmit Freq Error 9.365 kHz
x dB Bandwidth 283.036 kHz

GPRS 1900 (CH Low)

Agilent 15:38:37 Mar 11, 2008

R T

Mkr1 1.850 213 GHz
20.66 dBm

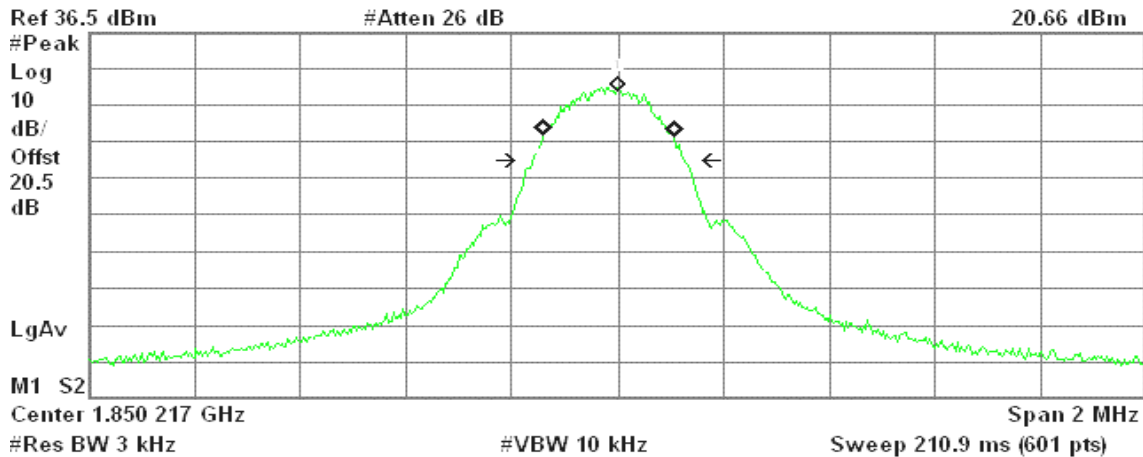

Occupied Bandwidth
245.0721 kHz

Occ BW % Pwr 99.00 %
x dB -20.00 dB

Transmit Freq Error -16.224 kHz
x dB Bandwidth 285.350 kHz



GPRS 1900 (CH Mid)

Agilent 15:39:06 Mar 11, 2008

R T

Mkr1 1.879 997 GHz

16.83 dBm

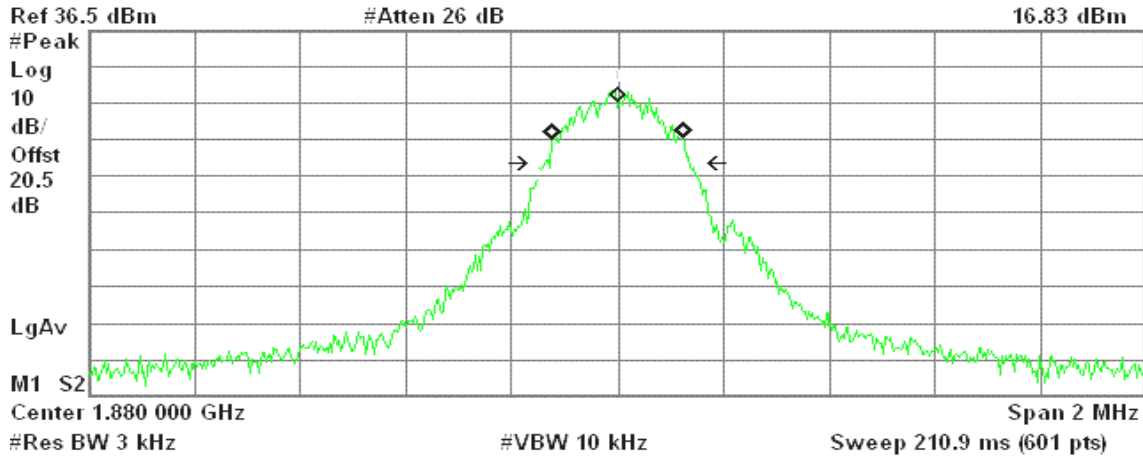

Occupied Bandwidth
246.8409 kHz

Occ BW % Pwr 99.00 %
x dB -20.00 dB

Transmit Freq Error 1.147 kHz
x dB Bandwidth 270.781 kHz

GPRS 1900 (CH High)

Agilent 15:40:48 Mar 11, 2008

R T

Mkr1 1.909 807 GHz

18.31 dBm

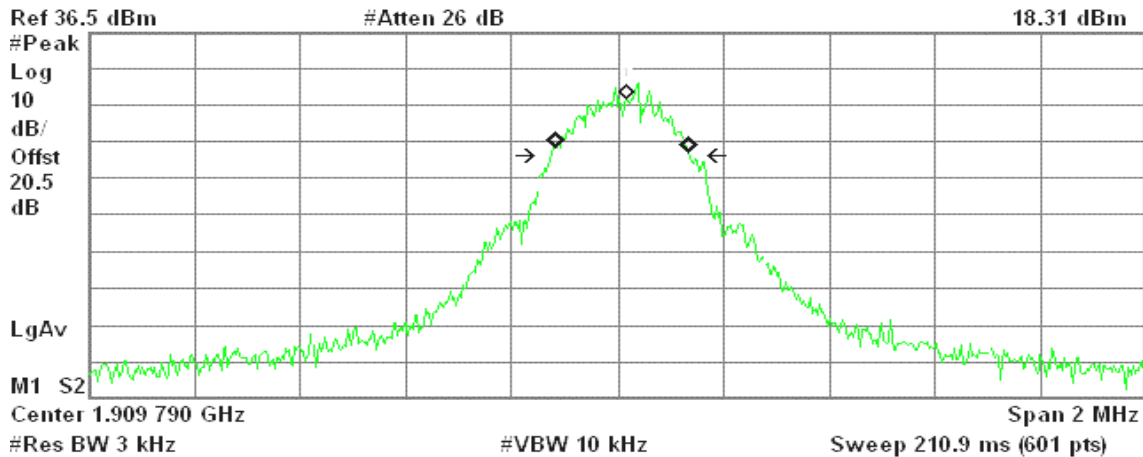

Occupied Bandwidth
248.1252 kHz

Occ BW % Pwr 99.00 %
x dB -20.00 dB

Transmit Freq Error 8.367 kHz
x dB Bandwidth 261.166 kHz



EDGE 850 (CH Low)

Agilent 10:35:46 Mar 12, 2008

R T

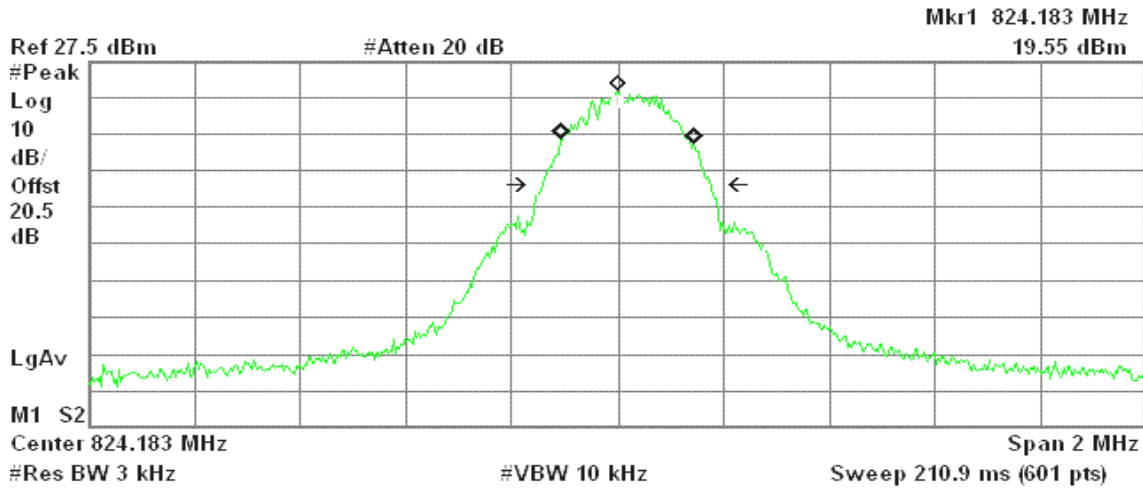

Occupied Bandwidth
248.5942 kHz

Occ BW % Pwr 99.00 %
x dB -26.00 dB

Transmit Freq Error 18.121 kHz
x dB Bandwidth 316.850 kHz

EDGE 850 (CH Mid)

Agilent 10:42:12 Mar 12, 2008

R T

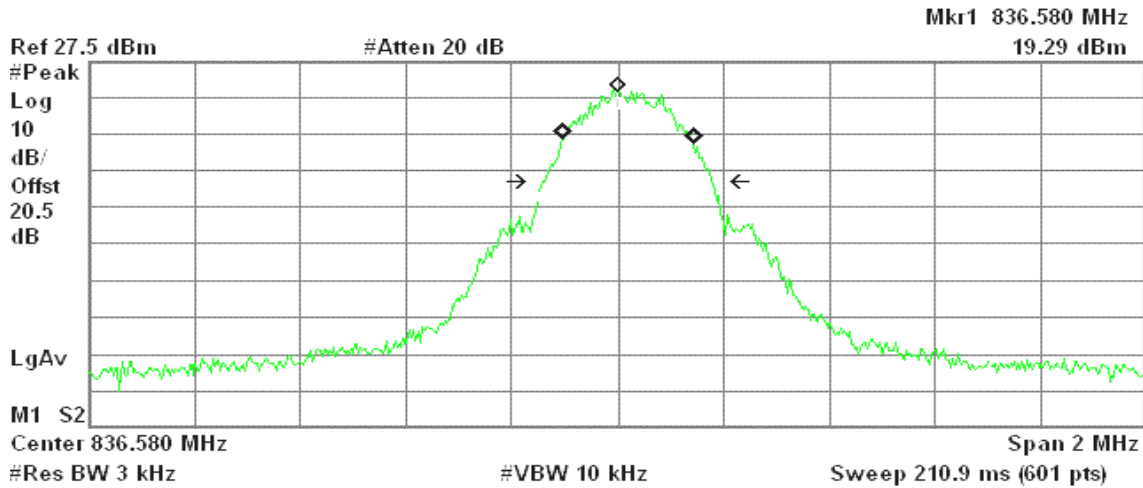

Occupied Bandwidth
246.7300 kHz

Occ BW % Pwr 99.00 %
x dB -26.00 dB

Transmit Freq Error 20.056 kHz
x dB Bandwidth 320.042 kHz



EDGE 850 (CH High)

Agilent 10:42:35 Mar 12, 2008

R T

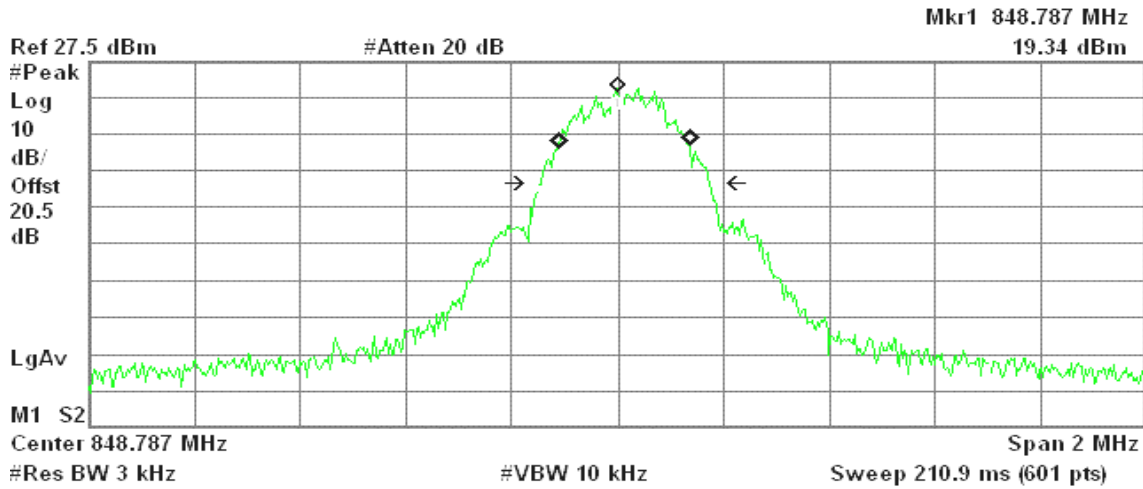

Occupied Bandwidth
247.0904 kHz

Occ BW % Pwr 99.00 %
x dB -26.00 dB

Transmit Freq Error 12.763 kHz
x dB Bandwidth 316.011 kHz

EDGE 1900 (CH Low)

Agilent 10:58:07 Mar 12, 2008

R T

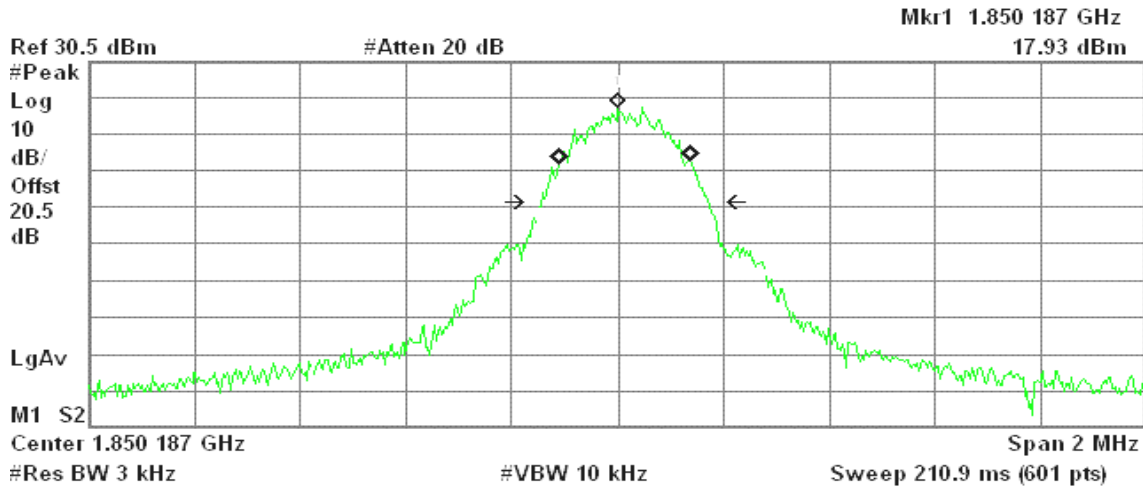

Occupied Bandwidth
248.5687 kHz

Occ BW % Pwr 99.00 %
x dB -26.00 dB

Transmit Freq Error 13.866 kHz
x dB Bandwidth 314.965 kHz



EDGE 1900 (CH Mid)

Agilent 10:58:27 Mar 12, 2008

R T

Mkr1 1.879 970 GHz
18.49 dBm

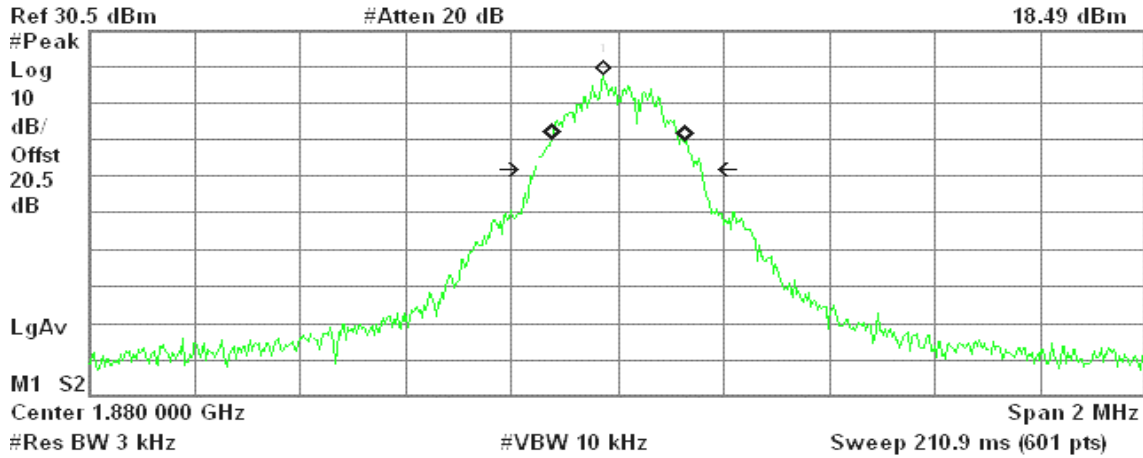

Occupied Bandwidth
247.2705 kHz

Occ BW % Pwr 99.00 %
x dB -26.00 dB

Transmit Freq Error 487.972 Hz
x dB Bandwidth 308.718 kHz

EDGE 1900 (CH High)

Agilent 10:58:56 Mar 12, 2008

R T

Mkr1 1.909 773 GHz
14.05 dBm

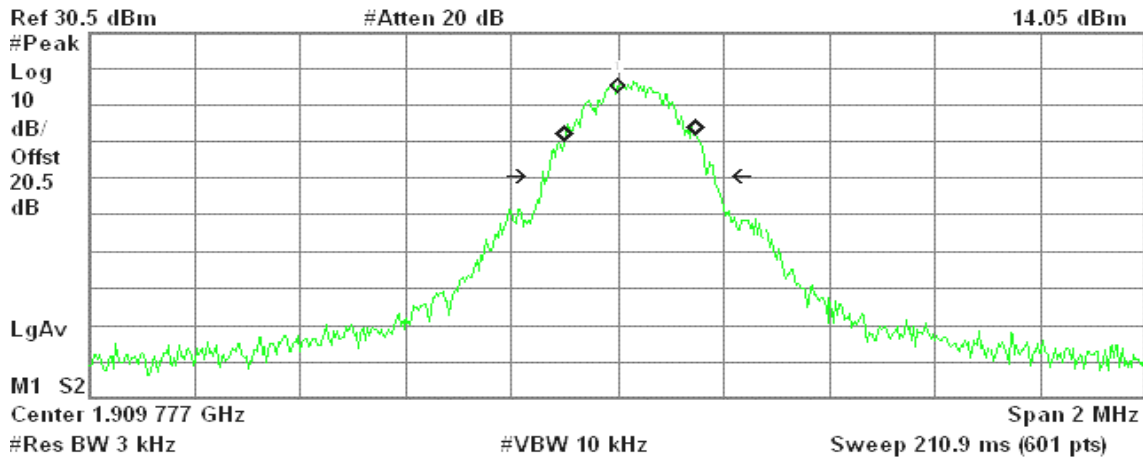

Occupied Bandwidth
244.8105 kHz

Occ BW % Pwr 99.00 %
x dB -26.00 dB

Transmit Freq Error 23.892 kHz
x dB Bandwidth 322.405 kHz



WCDMA Band II (CH Low)

Agilent 10:37:45 Mar 13, 2008

R T

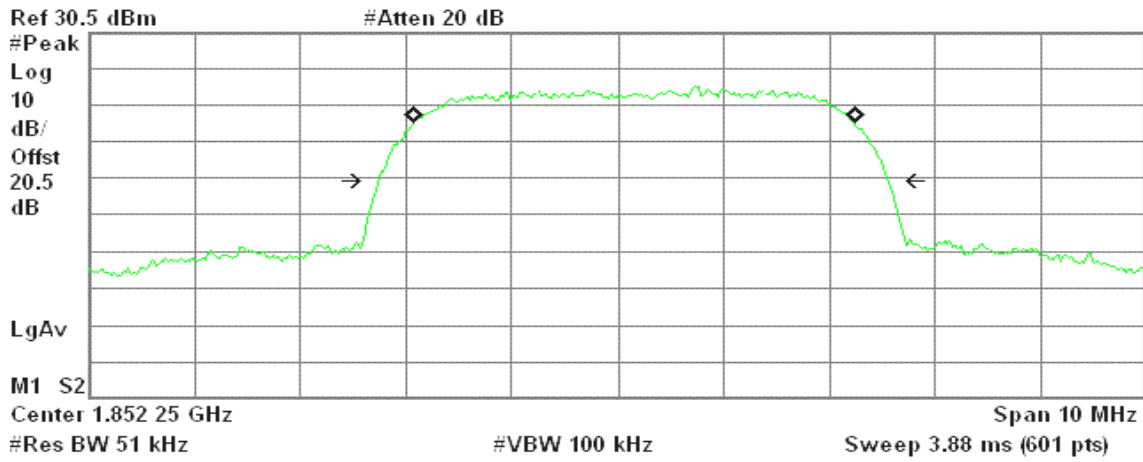

Occupied Bandwidth
4.1572 MHz

Occ BW % Pwr 99.00 %
x dB -26.00 dB

Transmit Freq Error 163.104 kHz
x dB Bandwidth 4.830 MHz

WCDMA Band II (CH Mid)

Agilent 10:39:11 Mar 13, 2008

R T

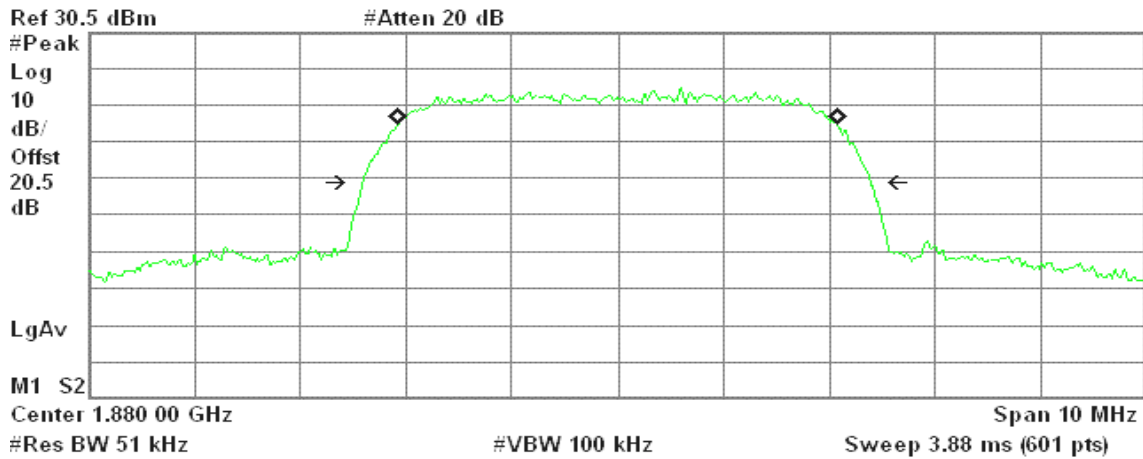

Occupied Bandwidth
4.1694 MHz

Occ BW % Pwr 99.00 %
x dB -26.00 dB

Transmit Freq Error 3.118 kHz
x dB Bandwidth 4.810 MHz



WCDMA Band II (CH High)

Agilent 10:39:37 Mar 13, 2008

R T

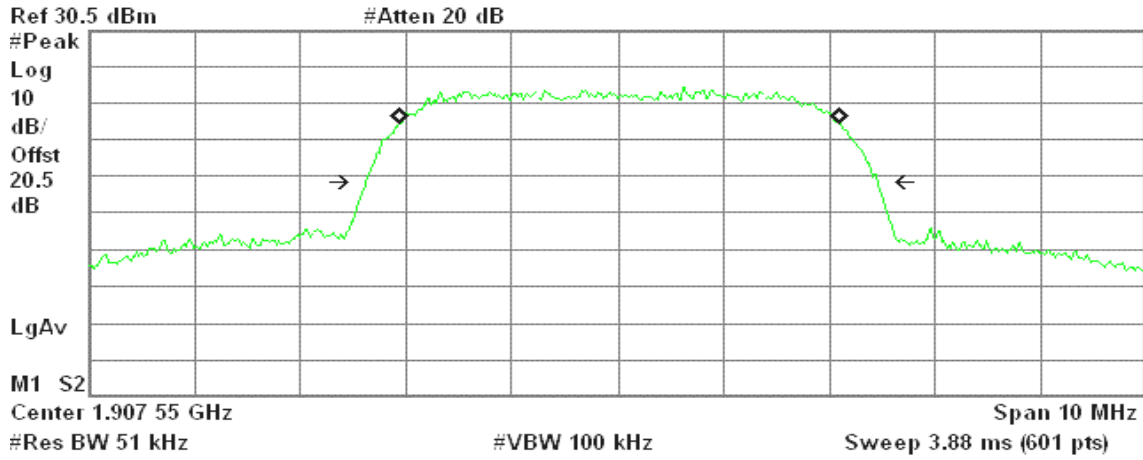

Occupied Bandwidth
4.1714 MHz

Occ BW % Pwr 99.00 %
x dB -26.00 dB

Transmit Freq Error 22.833 kHz
x dB Bandwidth 4.840 MHz

WCDMA Band V (CH Low)

Agilent 11:25:01 Mar 13, 2008

R T

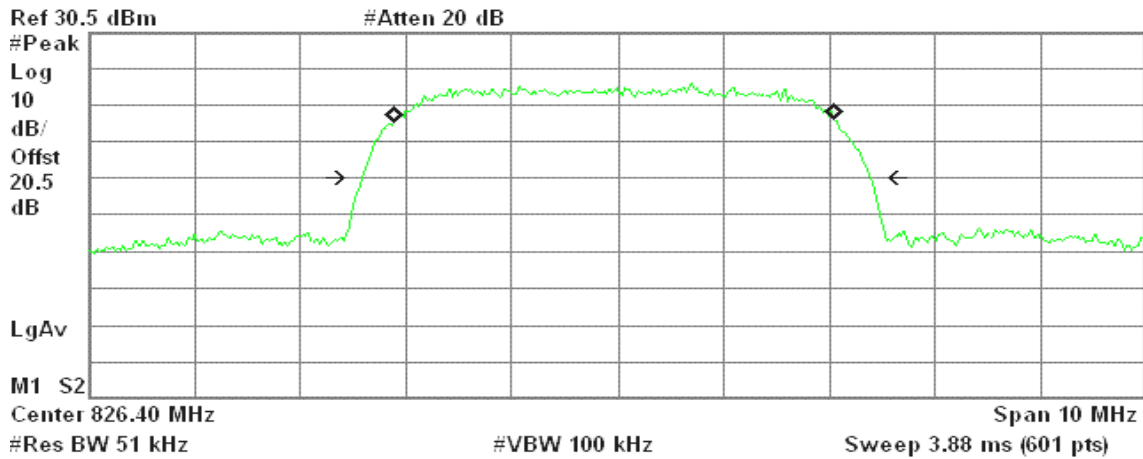

Occupied Bandwidth
4.1746 MHz

Occ BW % Pwr 99.00 %
x dB -26.00 dB

Transmit Freq Error -31.189 kHz
x dB Bandwidth 4.814 MHz



WCDMA Band V (CH Mid)

Agilent 11:25:46 Mar 13, 2008

R T

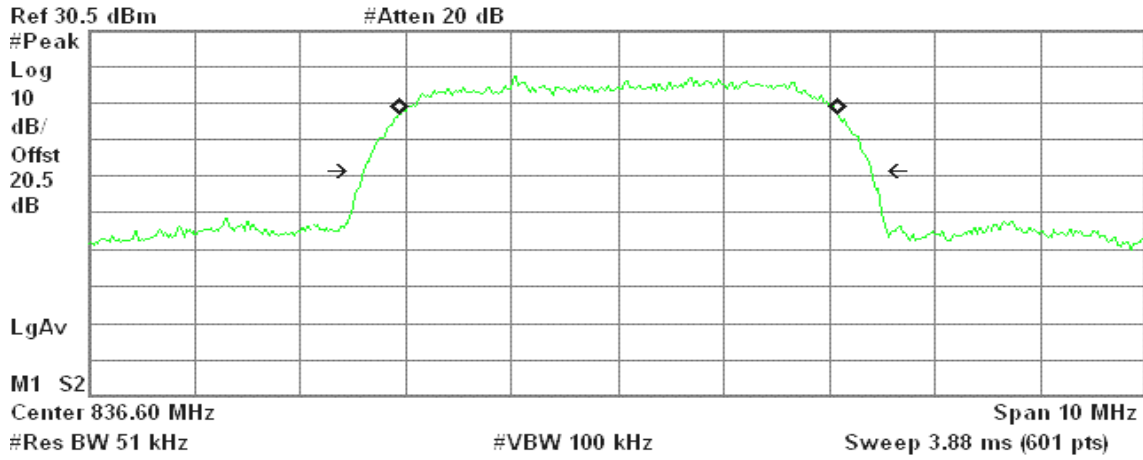

Occupied Bandwidth
4.1541 MHz

Occ BW % Pwr 99.00 %
x dB -26.00 dB

Transmit Freq Error 10.418 kHz
x dB Bandwidth 4.802 MHz

WCDMA Band V (CH High)

Agilent 11:26:22 Mar 13, 2008

R T

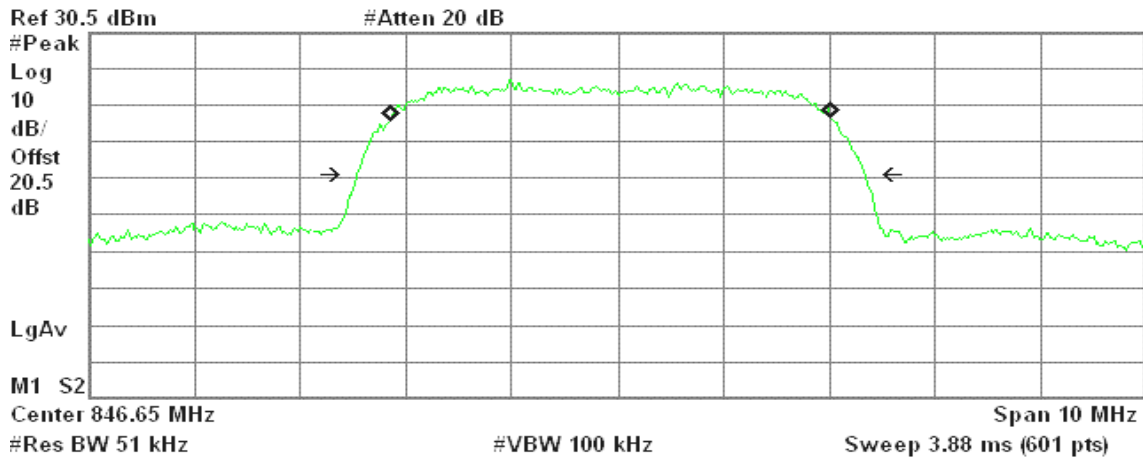

Occupied Bandwidth
4.1733 MHz

Occ BW % Pwr 99.00 %
x dB -26.00 dB

Transmit Freq Error -66.988 kHz
x dB Bandwidth 4.817 MHz



WCDMA / HSDPA Band II (CH Low)

Agilent 16:44:01 Mar 13, 2008

R T

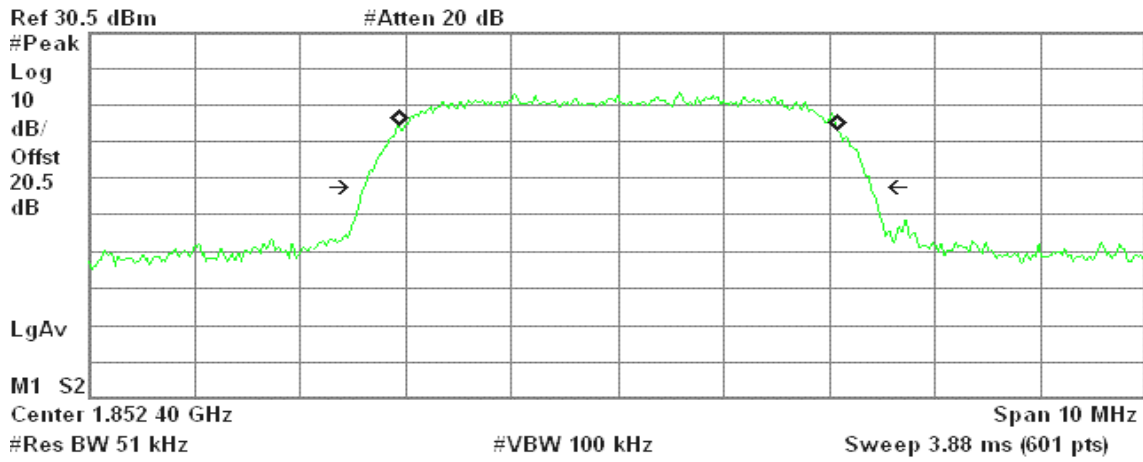

Occupied Bandwidth
4.1603 MHz

Occ BW % Pwr 99.00 %
x dB -26.00 dB

Transmit Freq Error 6.979 kHz
x dB Bandwidth 4.791 MHz

WCDMA / HSDPA Band II (CH Mid)

Agilent 16:44:16 Mar 13, 2008

R T

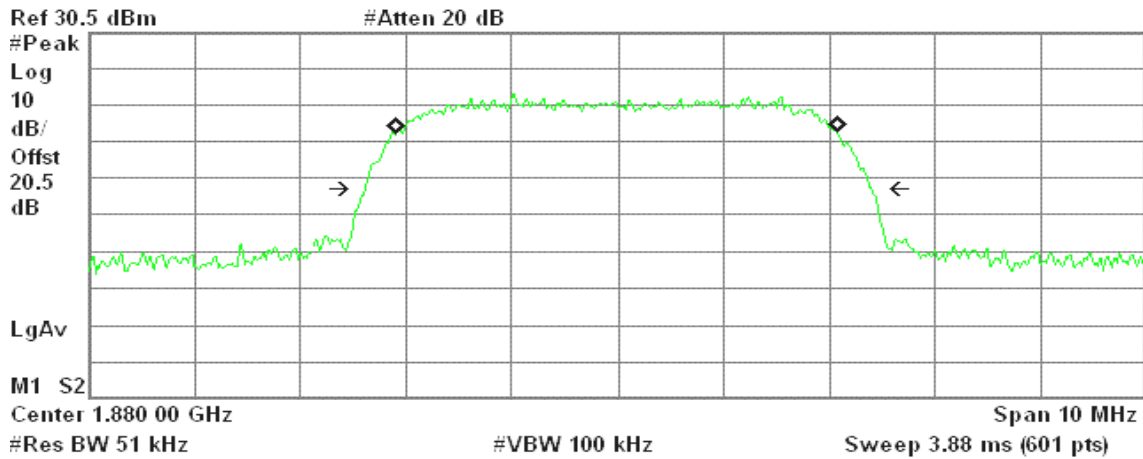

Occupied Bandwidth
4.1694 MHz

Occ BW % Pwr 99.00 %
x dB -26.00 dB

Transmit Freq Error -8.361 kHz
x dB Bandwidth 4.792 MHz



WCDMA / HSDPA Band II (CH High)

Agilent 16:44:37 Mar 13, 2008

R T

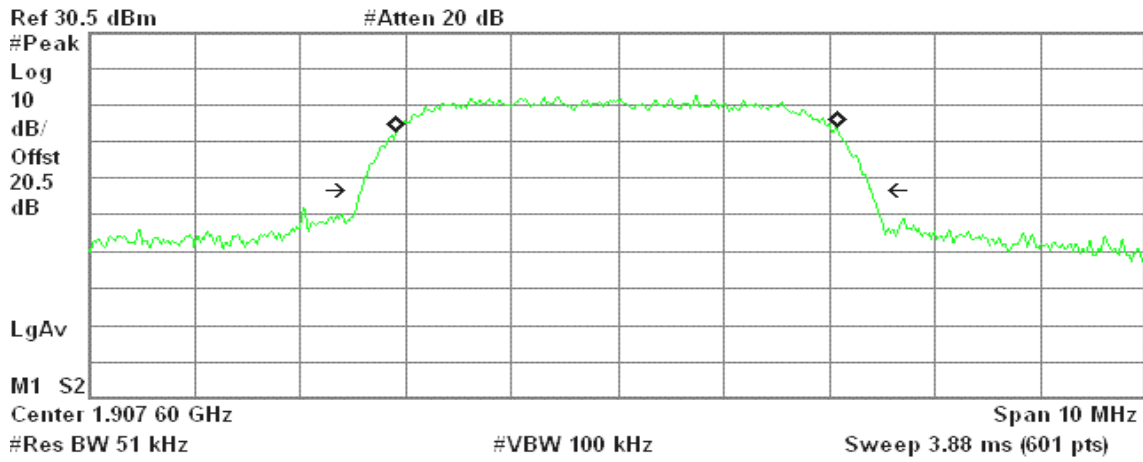

Occupied Bandwidth
4.1812 MHz

Occ BW % Pwr 99.00 %
x dB -26.00 dB

Transmit Freq Error -11.011 kHz
x dB Bandwidth 4.831 MHz

WCDMA / HSDPA Band V (CH Low)

Agilent 16:35:48 Mar 13, 2008

R T

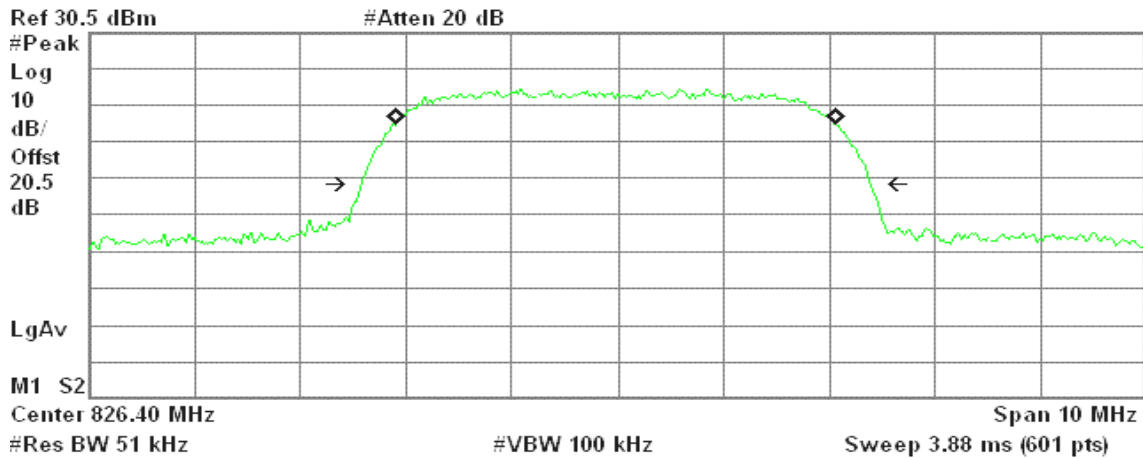

Occupied Bandwidth
4.1627 MHz

Occ BW % Pwr 99.00 %
x dB -26.00 dB

Transmit Freq Error -14.908 kHz
x dB Bandwidth 4.827 MHz



WCDMA / HSDPA Band V (CH Mid)

Agilent 16:36:33 Mar 13, 2008

R T

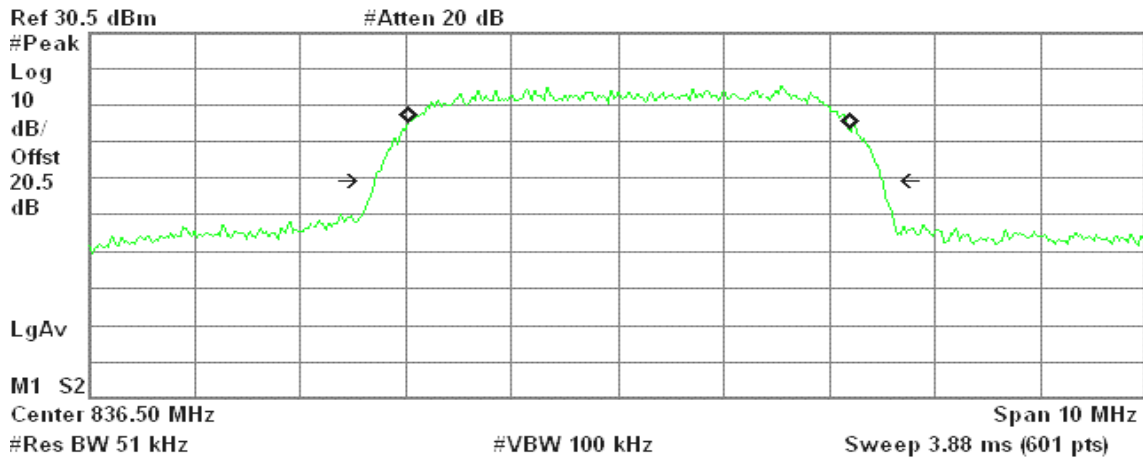

Occupied Bandwidth
4.1711 MHz

Occ BW % Pwr 99.00 %
x dB -26.00 dB

Transmit Freq Error 118.095 kHz
x dB Bandwidth 4.804 MHz

WCDMA / HSDPA Band V (CH High)

Agilent 16:36:53 Mar 13, 2008

R T

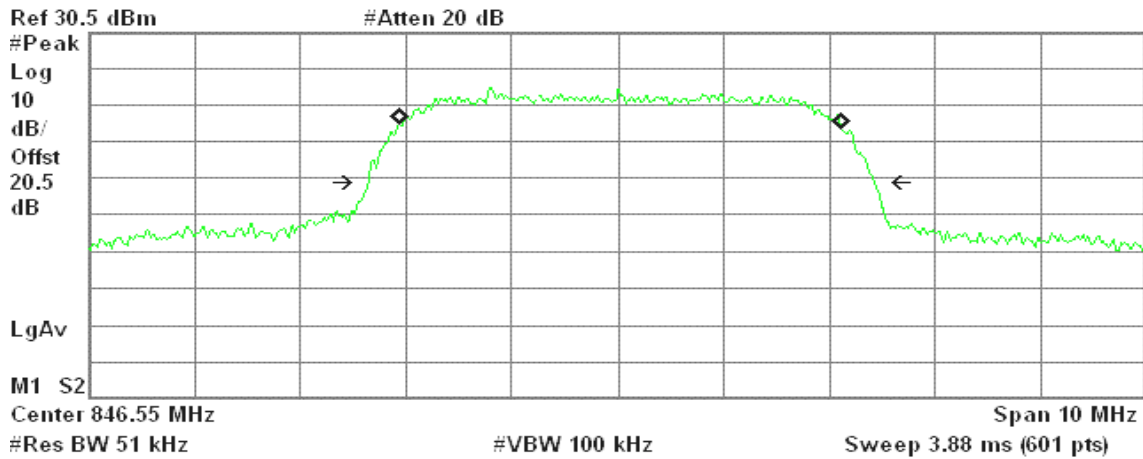

Occupied Bandwidth
4.1897 MHz

Occ BW % Pwr 99.00 %
x dB -26.00 dB

Transmit Freq Error 26.306 kHz
x dB Bandwidth 4.789 MHz



7.4 OUT OF BAND EMISSION AT ANTENNA TERMINALS

LIMIT

According to FCC §2.1051, FCC §22.917, FCC §24.238(a).

Out of Band Emissions: The mean power of emission must be attenuated below the mean power of the non-modulated carrier (P) on any frequency twice or more than twice the fundamental frequency by at least $43 + 10 \log P$ dB.

Mobile Emissions in Base Frequency Range: The mean power of any emissions appearing in the base station frequency range from cellular mobile transmitters operated must be attenuated to a level not exceed -80 dBm at the transmit antenna connector.

Band Edge Requirements: In the 1MHz bands immediately outside and adjacent to the frequency block, a resolution bandwidth of at least 1% of the emission bandwidth of the fundamental emission of the transmitter may be employed to measure the Out of band Emission

TEST CONFIGURATION

Out of band emission at antenna terminals:

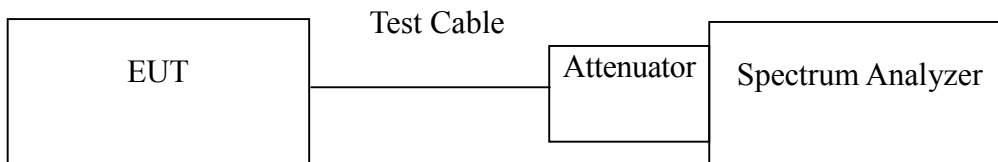

TEST PROCEDURE

The RF output of the transceiver was connected to a spectrum analyzer through appropriate attenuation. The resolution bandwidth of the spectrum analyzer was set at 1MHz, sufficient scans were taken to show the out of band Emissions if any up to 10th harmonic.

For the out of band: Set the RBW, VBW = 1MHz, Start=30MHz, Stop= 10 th harmonic. Limit = -13dBm

Band Edge Requirements (824 MHz and 849 MHz /1850MHz and 1910MHz): In the 1 MHz bands immediately outside and adjacent to the frequency block, a resolution bandwidth of at least 1 percent of the emission bandwidth of the fundamental emission of the transmitter may be employed to measure the out of band Emissions. Limit, -13dBm.



TEST RESULTS

No non-compliance noted.

Test Data

Mode	CH	Location	Description
GSM 850 (Class A)	128	Figure 7-1	Conducted spurious emissions, 30MHz - 20GHz
	190	Figure 7-2	Conducted spurious emissions, 30MHz - 20GHz
	251	Figure 7-3	Conducted spurious emissions, 30MHz - 20GHz
GPRS 850 (Class 10)	128	Figure 7-4	Conducted spurious emissions, 30MHz - 20GHz
	190	Figure 7-5	Conducted spurious emissions, 30MHz - 20GHz
	251	Figure 7-6	Conducted spurious emissions, 30MHz - 20GHz

Mode	CH	Location	Description
GSM 1900 (Class A)	512	Figure 8-1	Conducted spurious emissions, 30MHz - 20GHz
	661	Figure 8-2	Conducted spurious emissions, 30MHz - 20GHz
	810	Figure 8-3	Conducted spurious emissions, 30MHz - 20GHz
GPRS 1900 (Class 10)	512	Figure 8-4	Conducted spurious emissions, 30MHz - 20GHz
	661	Figure 8-5	Conducted spurious emissions, 30MHz - 20GHz
	810	Figure 8-6	Conducted spurious emissions, 30MHz - 20GHz

Mode	CH	Location	Description
GSM 850 (Class A)	128	Figure 9-1	Band Edge emissions
	251	Figure 9-2	Band Edge emissions
GPRS 850 (Class 10)	128	Figure 9-3	Band Edge emissions
	251	Figure 9-4	Band Edge emissions

Mode	CH	Location	Description
GSM 1900 (Class A)	512	Figure 10-1	Band Edge emissions
	810	Figure 10-2	Band Edge emissions
GPRS 1900 (Class 10)	512	Figure 10-3	Band Edge emissions
	810	Figure 10-4	Band Edge emissions



Mode	CH	Location	Description
EDGE 850 (Class 10)	128	Figure 11-1	Conducted spurious emissions, 30MHz - 20GHz
	190	Figure 11-2	Conducted spurious emissions, 30MHz - 20GHz
	251	Figure 11-3	Conducted spurious emissions, 30MHz - 20GHz
EDGE 1900 (Class 10)	512	Figure 11-4	Conducted spurious emissions, 30MHz - 20GHz
	661	Figure 11-5	Conducted spurious emissions, 30MHz - 20GHz
	810	Figure 11-6	Conducted spurious emissions, 30MHz - 20GHz

Mode	CH	Location	Description
EDGE 850 (Class 10)	128	Figure 12-1	Band Edge emissions
	251	Figure 12-2	Band Edge emissions
EDGE 1900 (Class 10)	512	Figure 12-3	Band Edge emissions
	810	Figure 12-4	Band Edge emissions



Mode	CH	Location	Description
WCDMA (Band II)	9262	Figure 13-1	Conducted spurious emissions, 30MHz - 20GHz
	9400	Figure 13-2	Conducted spurious emissions, 30MHz - 20GHz
	9538	Figure 13-3	Conducted spurious emissions, 30MHz - 20GHz
WCDMA (Band V)	4132	Figure 13-4	Conducted spurious emissions, 30MHz - 20GHz
	4183	Figure 13-5	Conducted spurious emissions, 30MHz - 20GHz
	4233	Figure 13-6	Conducted spurious emissions, 30MHz - 20GHz

Mode	CH	Location	Description
WCDMA (Band II)	9262	Figure 14-1	Band Edge emissions
	9538	Figure 14-2	Band Edge emissions
WCDMA (Band V)	4132	Figure 14-3	Band Edge emissions
	4233	Figure 14-4	Band Edge emissions

Mode	CH	Location	Description
HSDPA WCDMA (Band II)	9262	Figure 15-1	Conducted spurious emissions, 30MHz - 20GHz
	9400	Figure 15-2	Conducted spurious emissions, 30MHz - 20GHz
	9538	Figure 15-3	Conducted spurious emissions, 30MHz - 20GHz
HSDPA WCDMA (Band V)	4132	Figure 15-4	Conducted spurious emissions, 30MHz - 20GHz
	4183	Figure 15-5	Conducted spurious emissions, 30MHz - 20GHz
	4233	Figure 15-6	Conducted spurious emissions, 30MHz - 20GHz

Mode	CH	Location	Description
HSDPA WCDMA (Band II)	9262	Figure 16-1	Band Edge emissions
	9538	Figure 16-2	Band Edge emissions
HSDPA WCDMA (Band V)	4132	Figure 16-3	Band Edge emissions
	4233	Figure 16-4	Band Edge emissions



Test Plot

GSM 850

Figure 7-1: Out of Band emission at antenna terminals – GSM CH Low

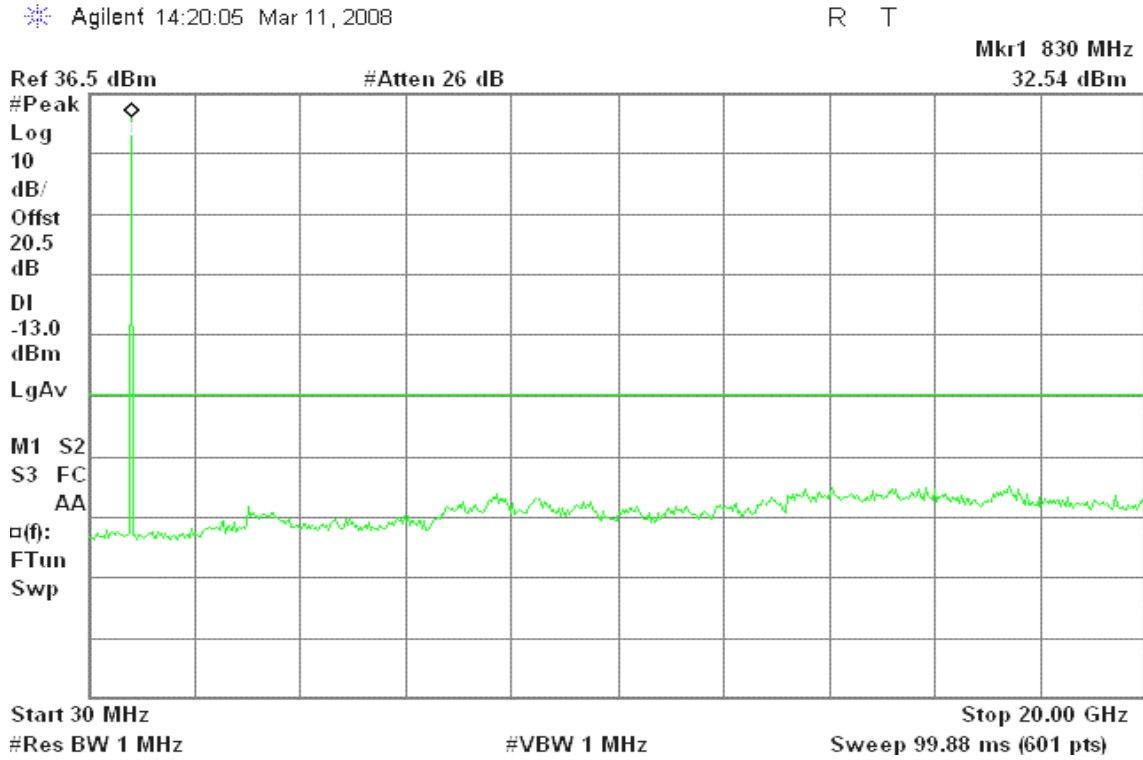

Figure 7-2: Out of Band emission at antenna terminals – GSM CH Mid

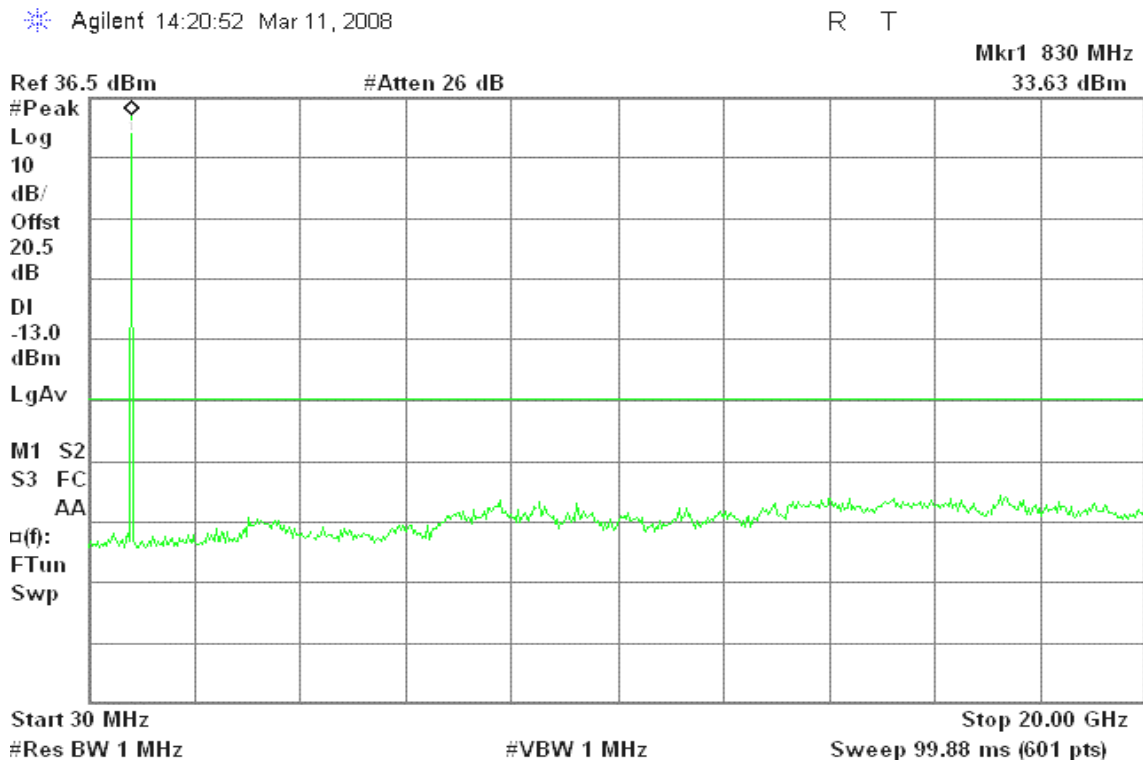
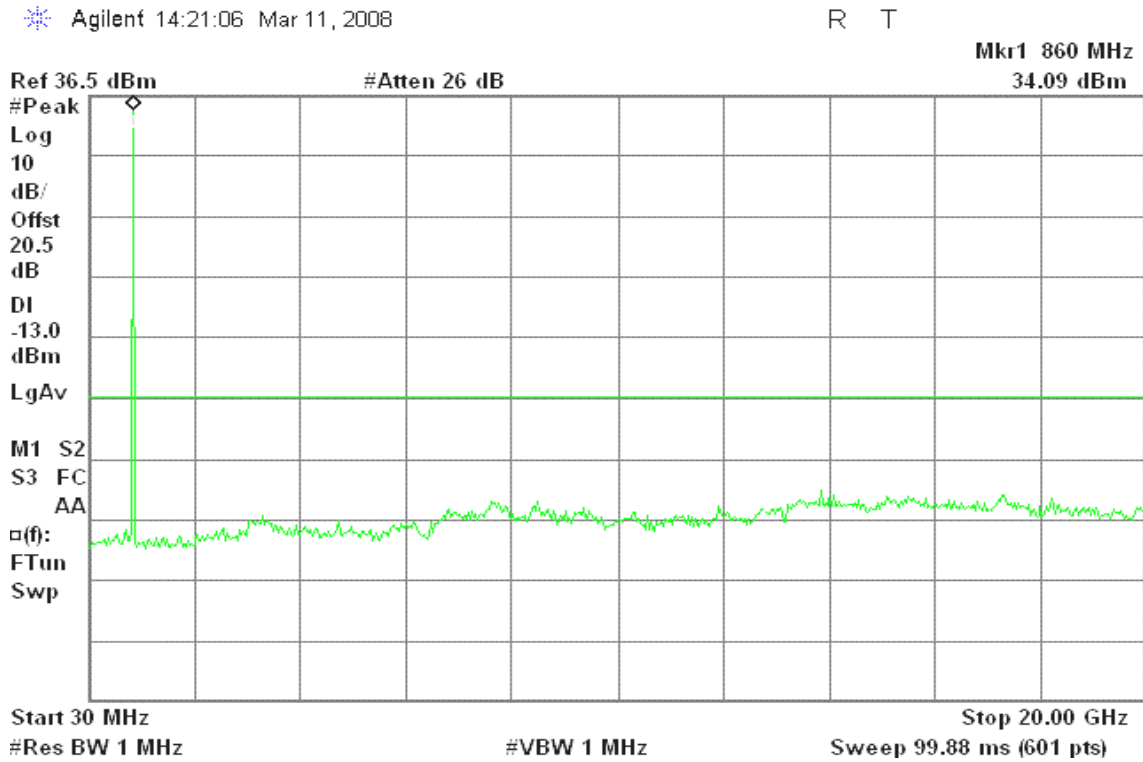



Figure 7-3: Out of Band emission at antenna terminals – GSM CH High



GPRS 850

Figure 7-4: Out of Band emission at antenna terminals – GPRS CH Low

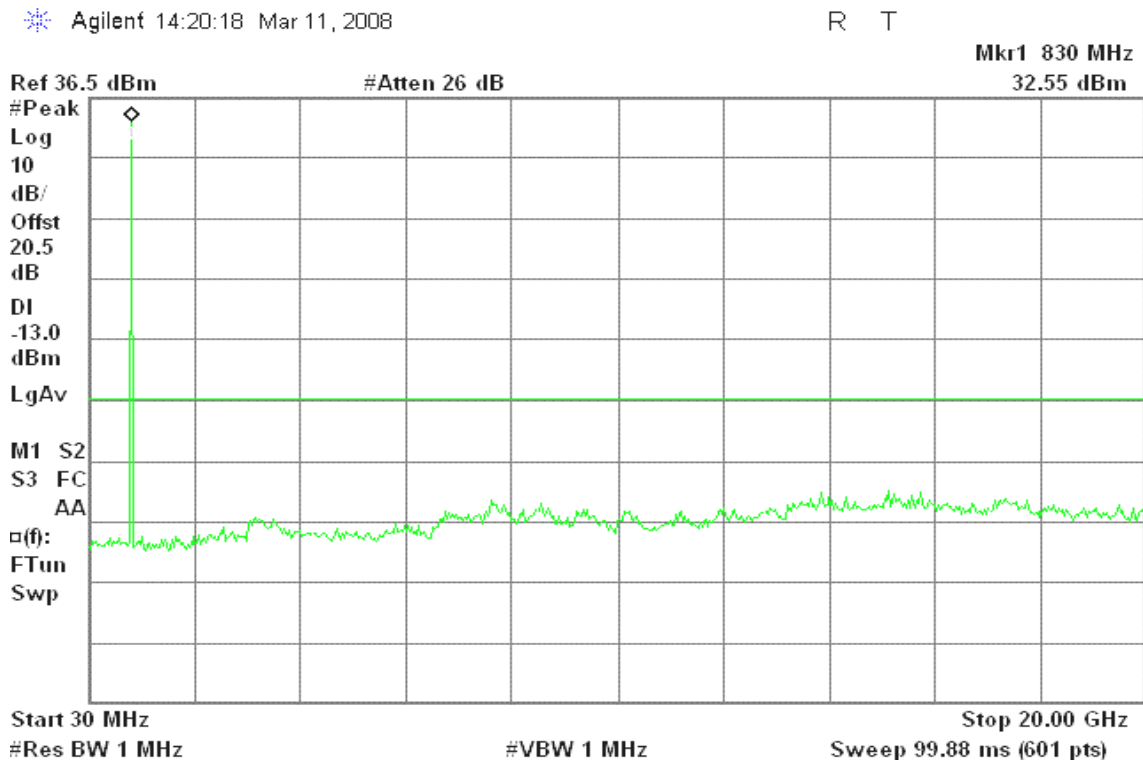



Figure 7-5: Out of Band emission at antenna terminals – GPRS CH Mid

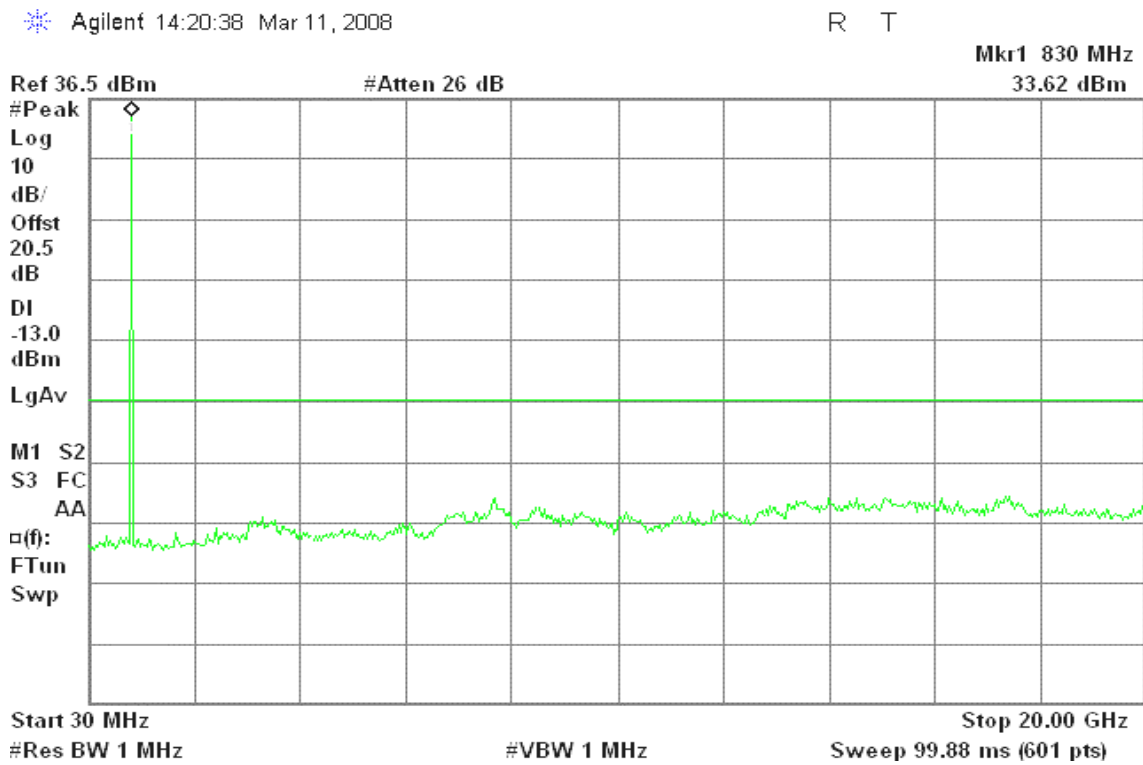
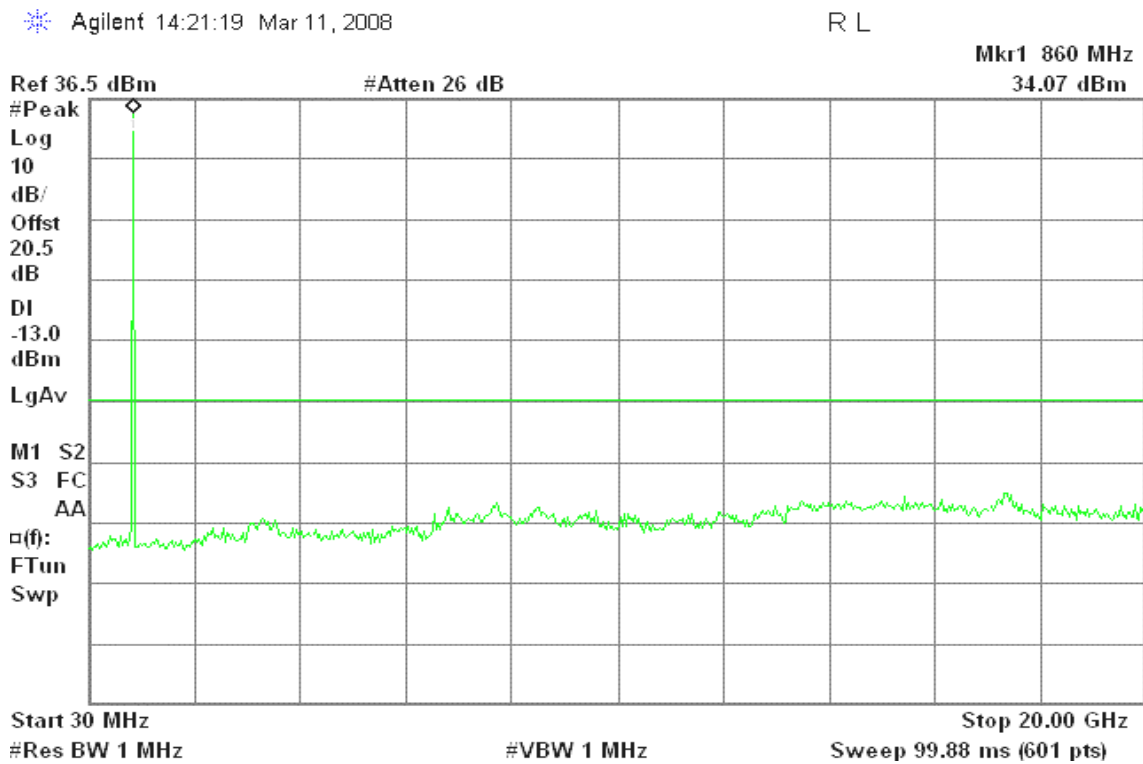

Figure 7-6: Out of Band emission at antenna terminals – GPRS CH High





GSM 1900

Figure 8-1: Out of Band emission at antenna terminals – GSM CH Low

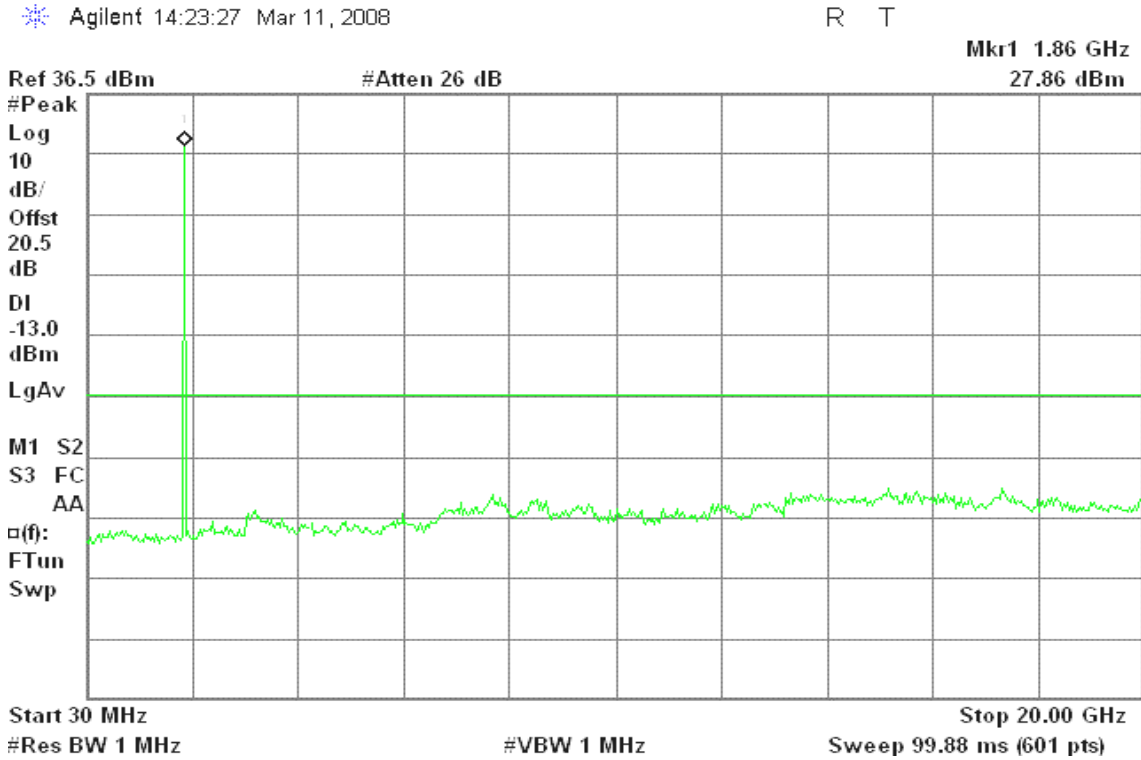

Figure 8-2: Out of Band emission at antenna terminals – GSM CH Mid

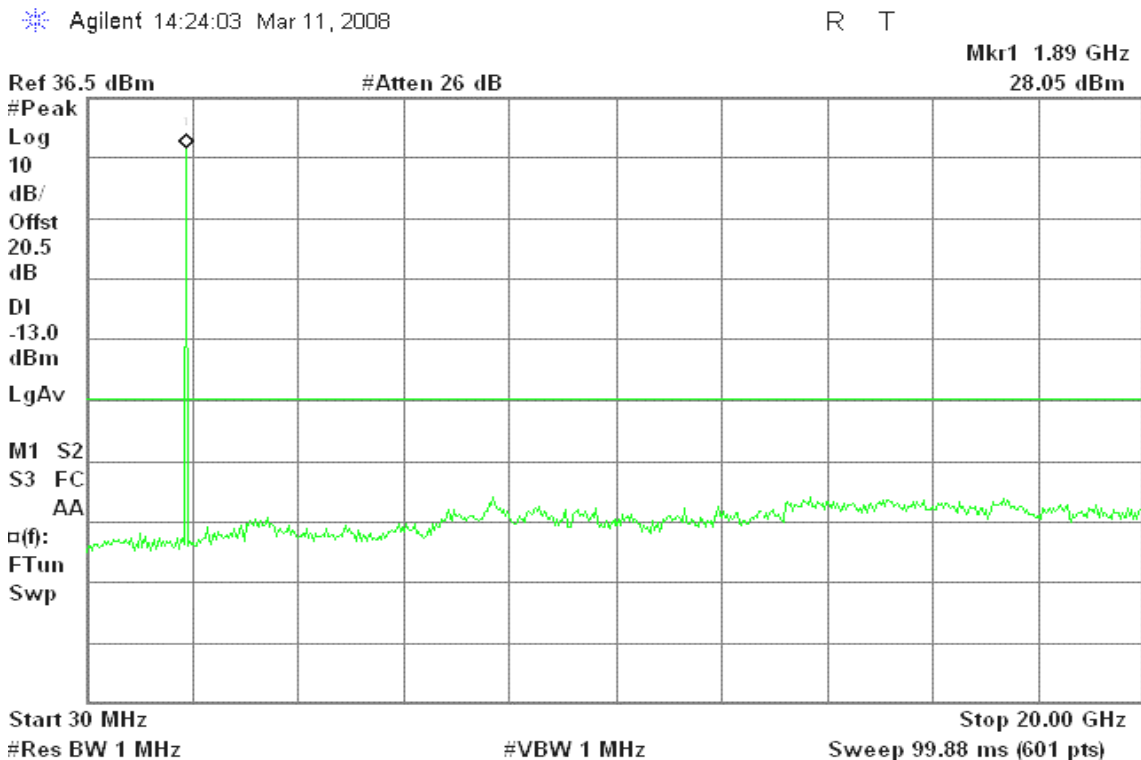
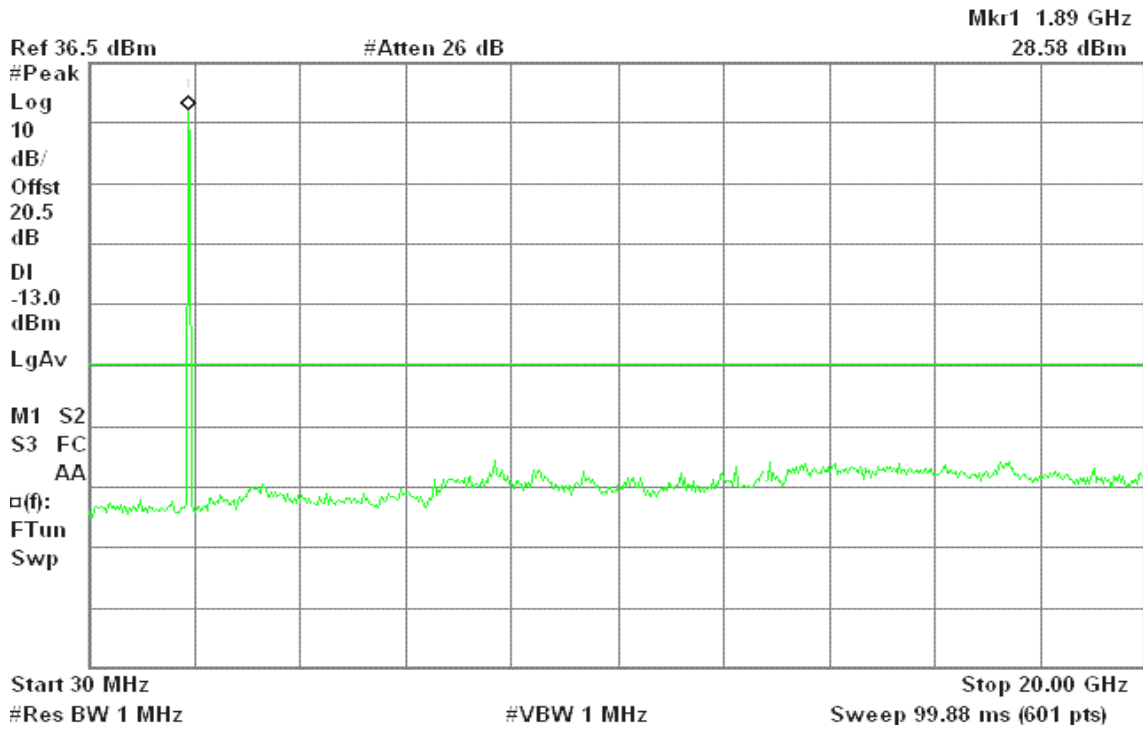



Figure 8-3: Out of Band emission at antenna terminals – GSM CH High

Agilent 14:24:16 Mar 11, 2008

R T



GPRS 1900

Figure 8-4: Out of Band emission at antenna terminals – GPRS CH Low

Agilent 14:23:38 Mar 11, 2008

R T

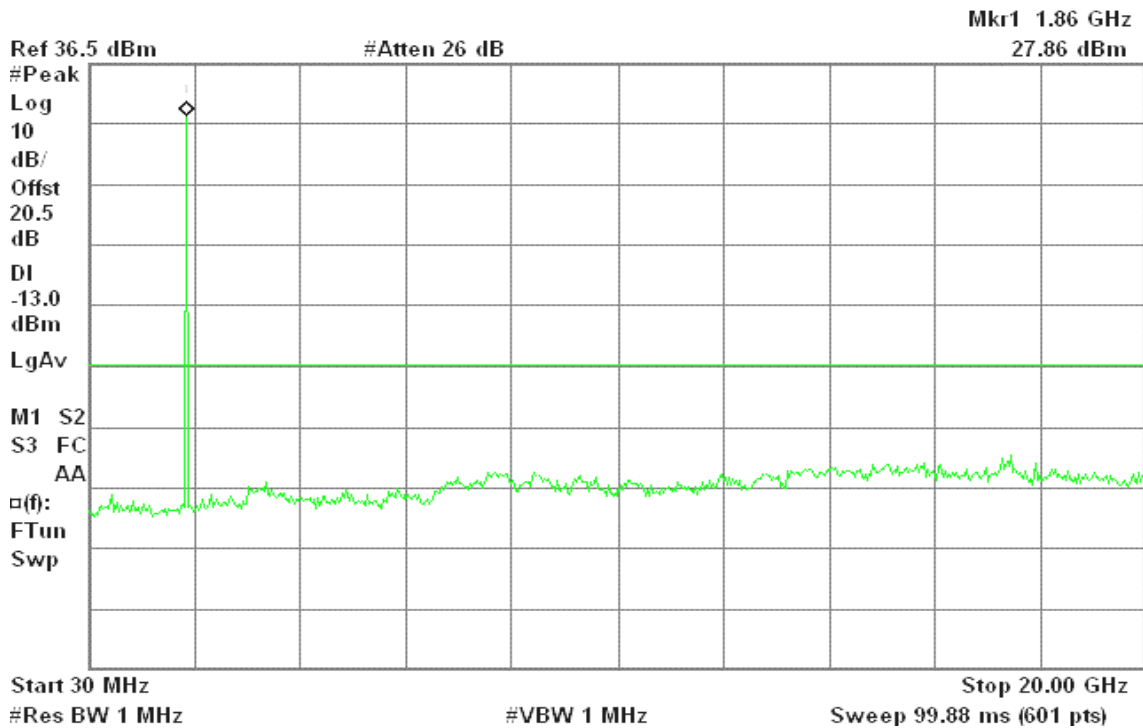



Figure 8-5: Out of Band emission at antenna terminals – GPRS CH Mid

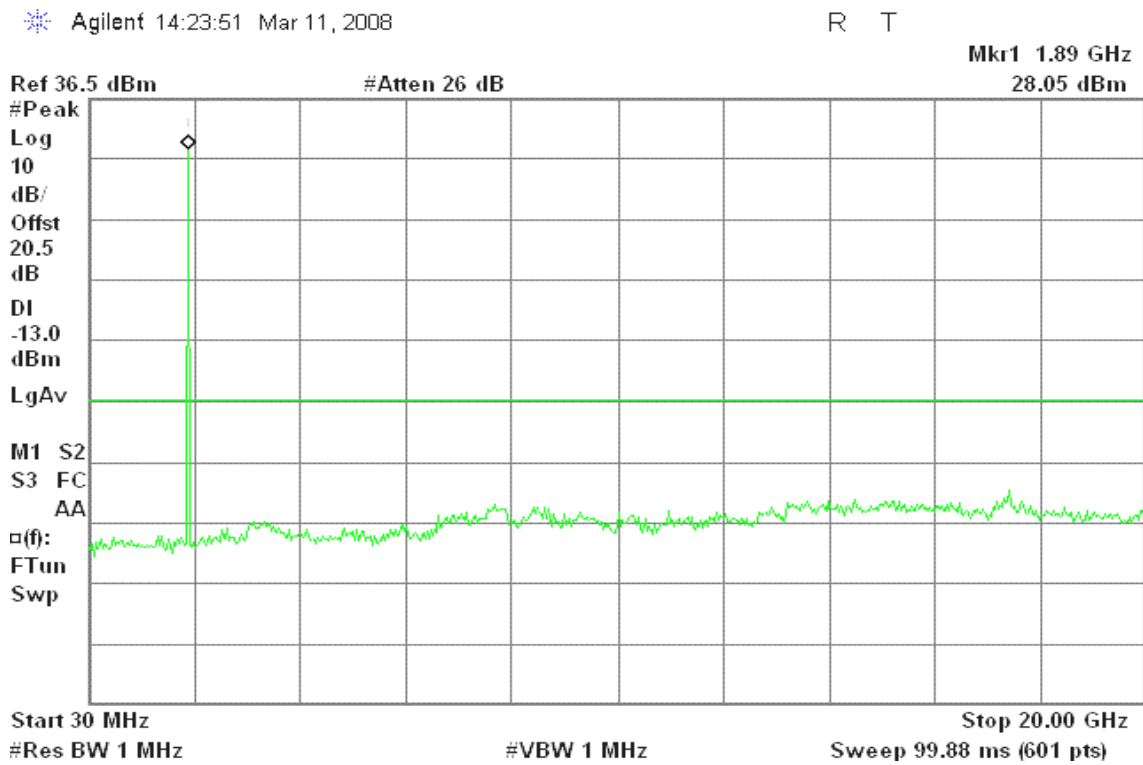
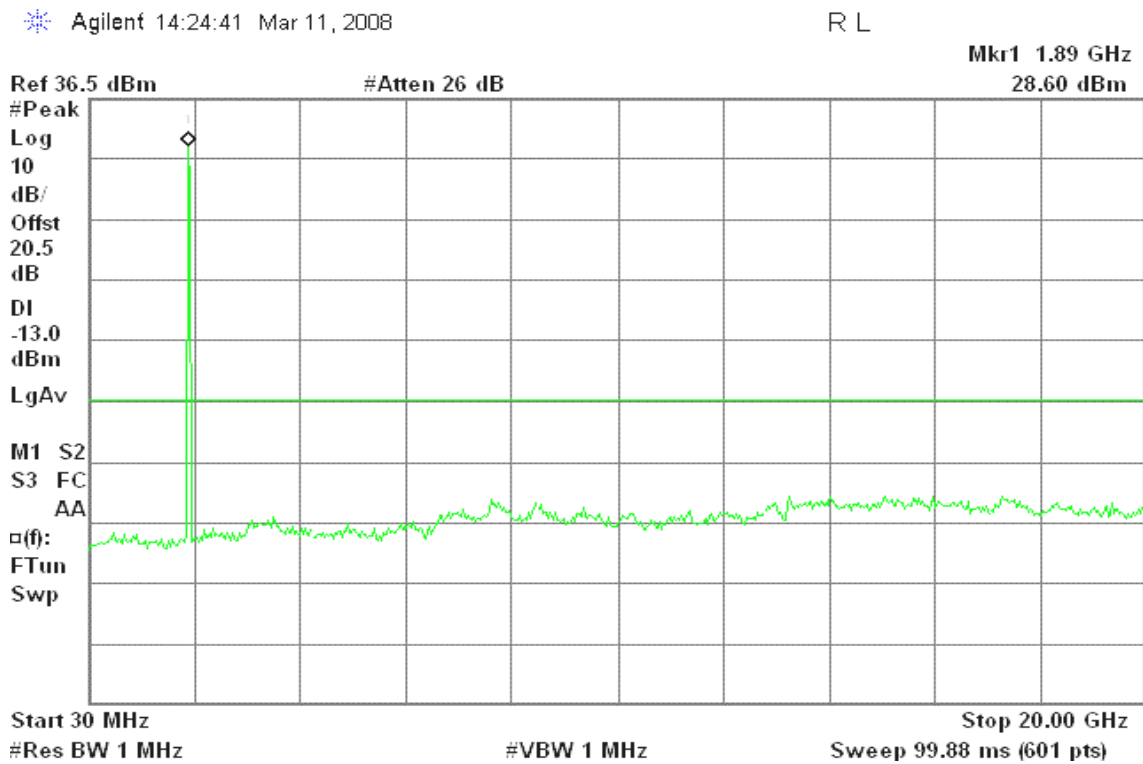

Figure 8-6: Out of Band emission at antenna terminals – GPRS CH High





GSM 850

Figure 9-1: Band Edge emissions – GSM CH Low

Agilent 14:13:37 Mar 11, 2008

R T

Mkr1 823.997 MHz
-14.80 dBm

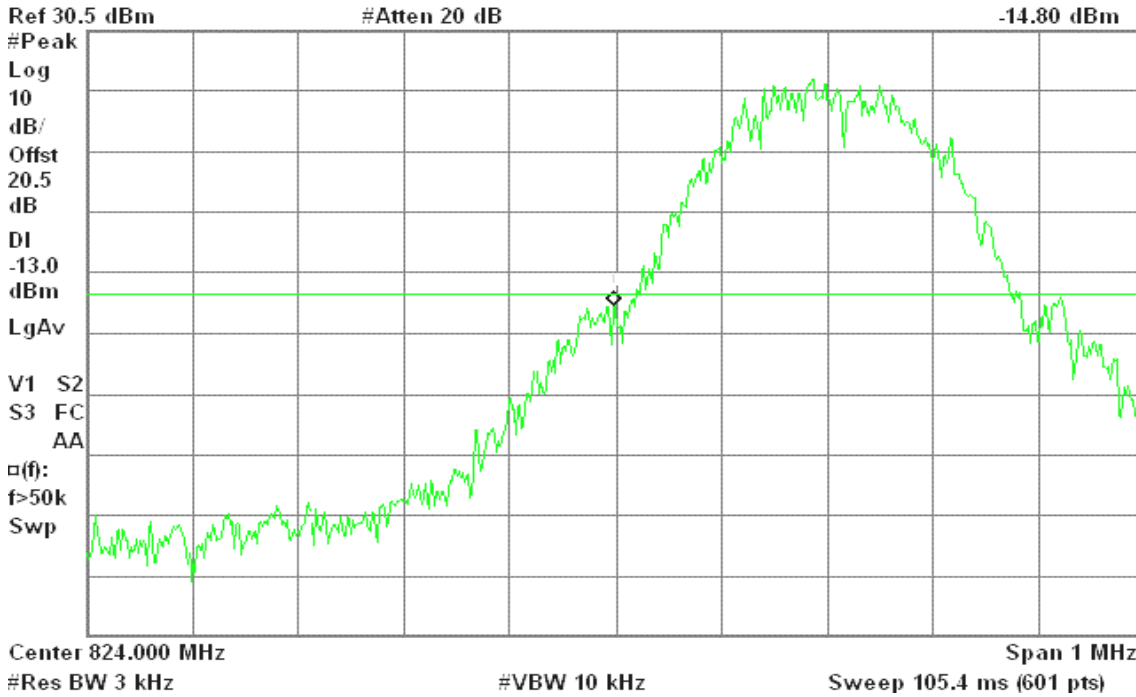
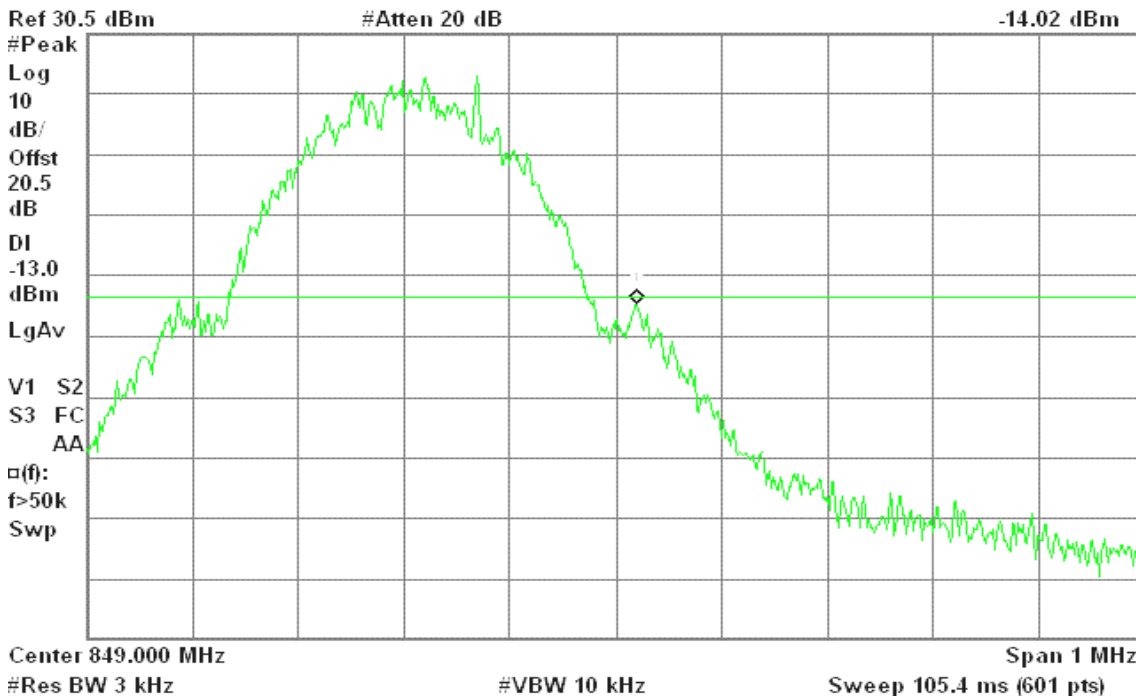

Figure 9-2: Band Edge emissions – GSM CH High

Agilent 14:10:52 Mar 11, 2008

R T

Mkr1 849.020 MHz
-14.02 dBm





GPRS 850

Figure 9-3: Band Edge emissions – GPRS CH Low

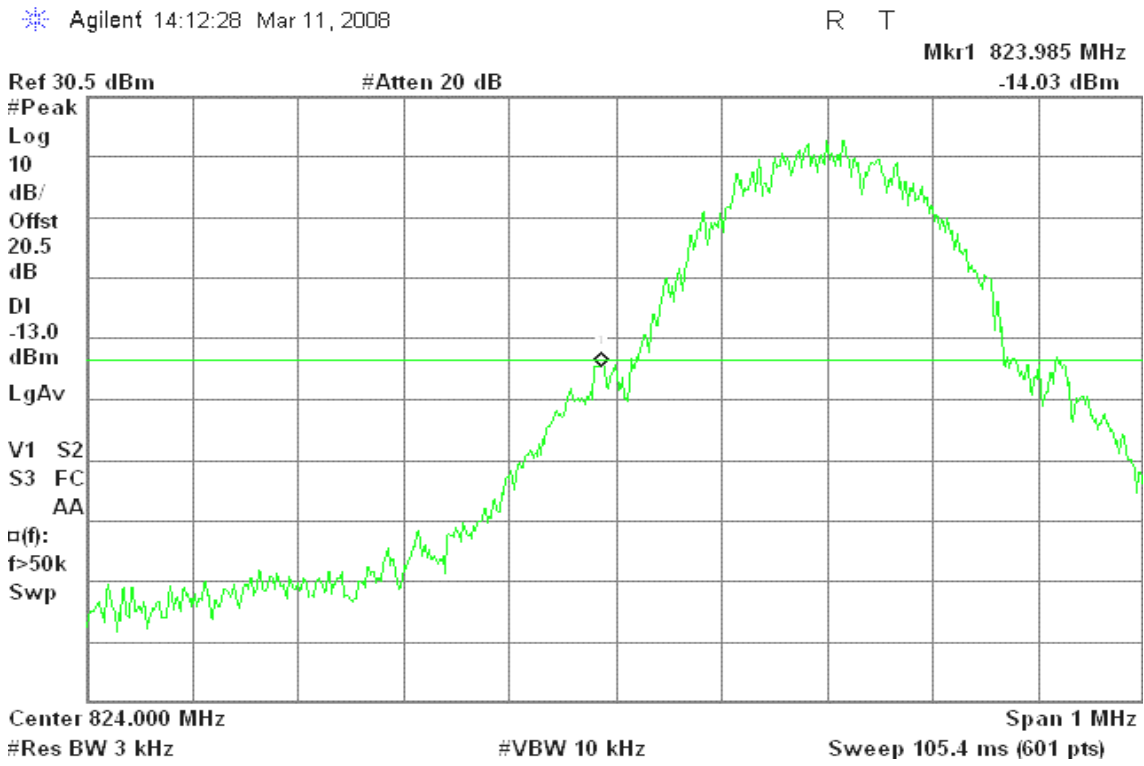
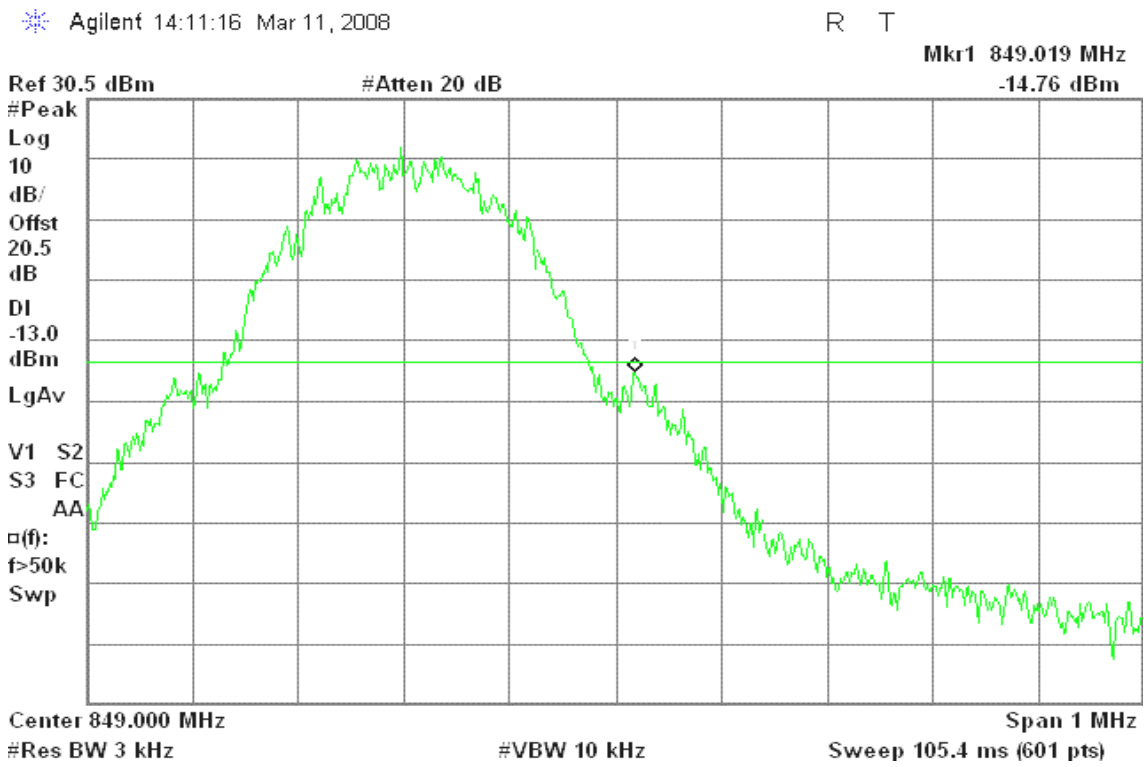

Figure 9-4: Band Edge emissions –GPRS CH High





GSM 1900

Figure 10-1: Band Edge emissions – GSM CH Low

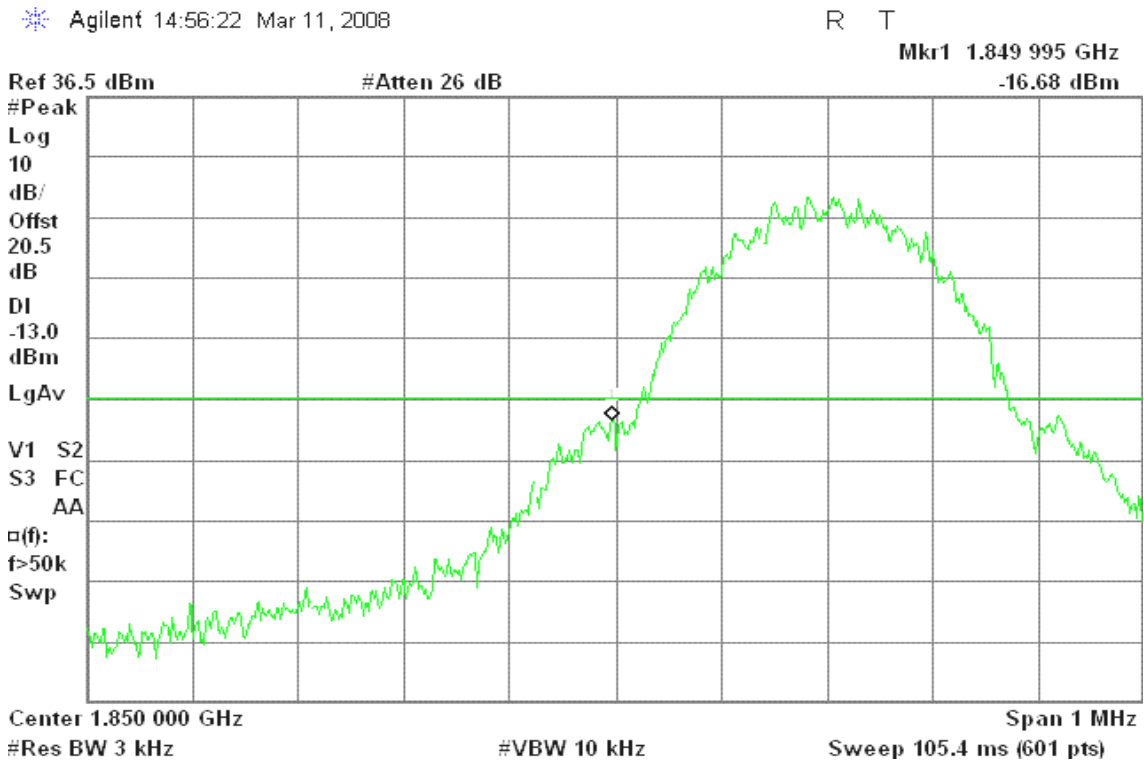
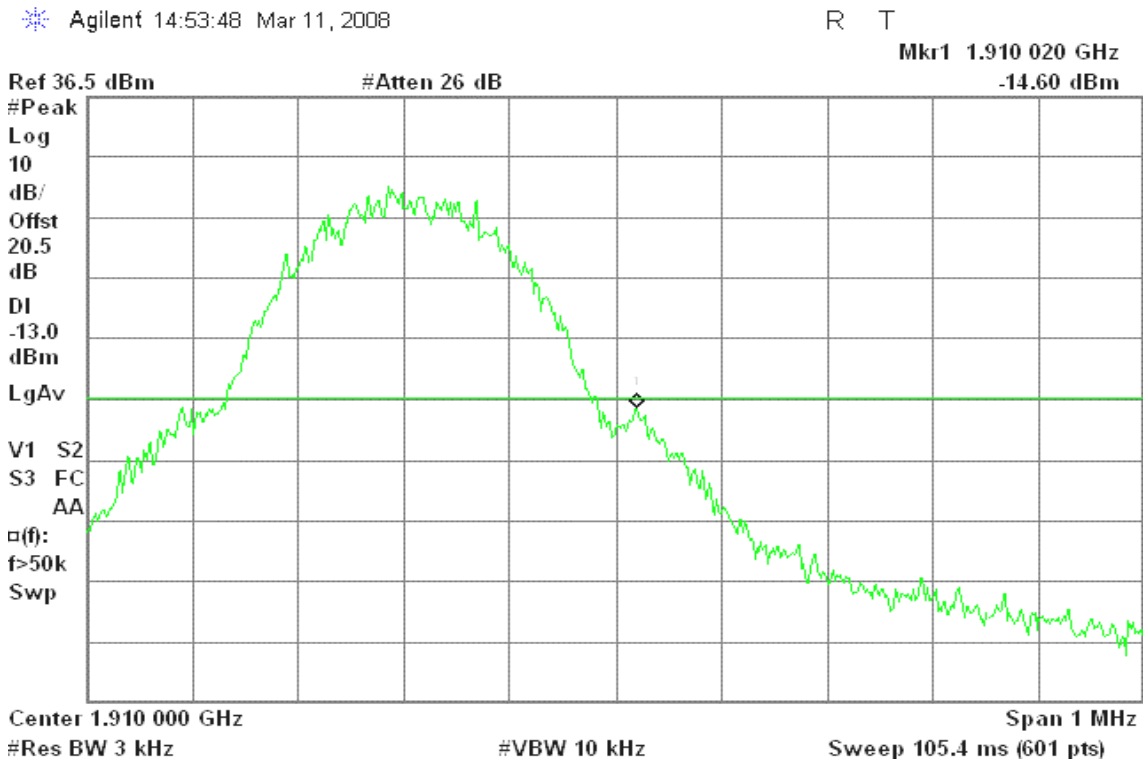

Figure 10-2: Band Edge emissions – GSM CH High





GPRS 1900

Figure 10-3: Band Edge emissions – GPRS CH Low

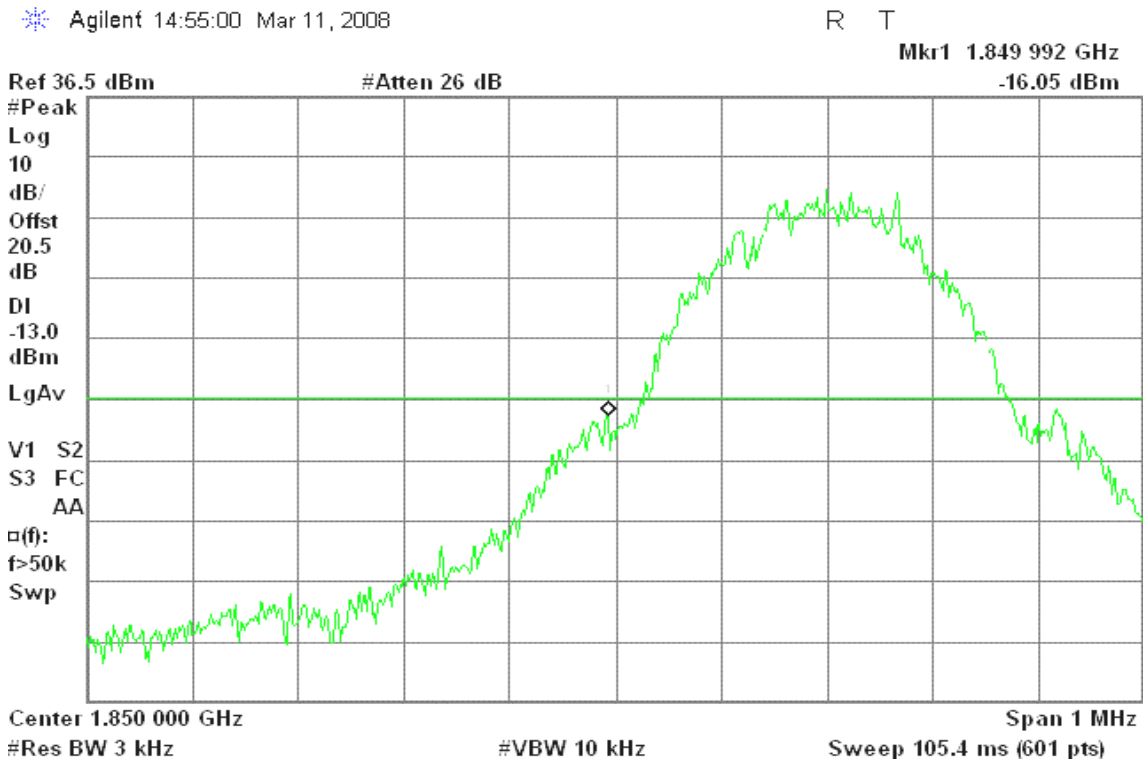
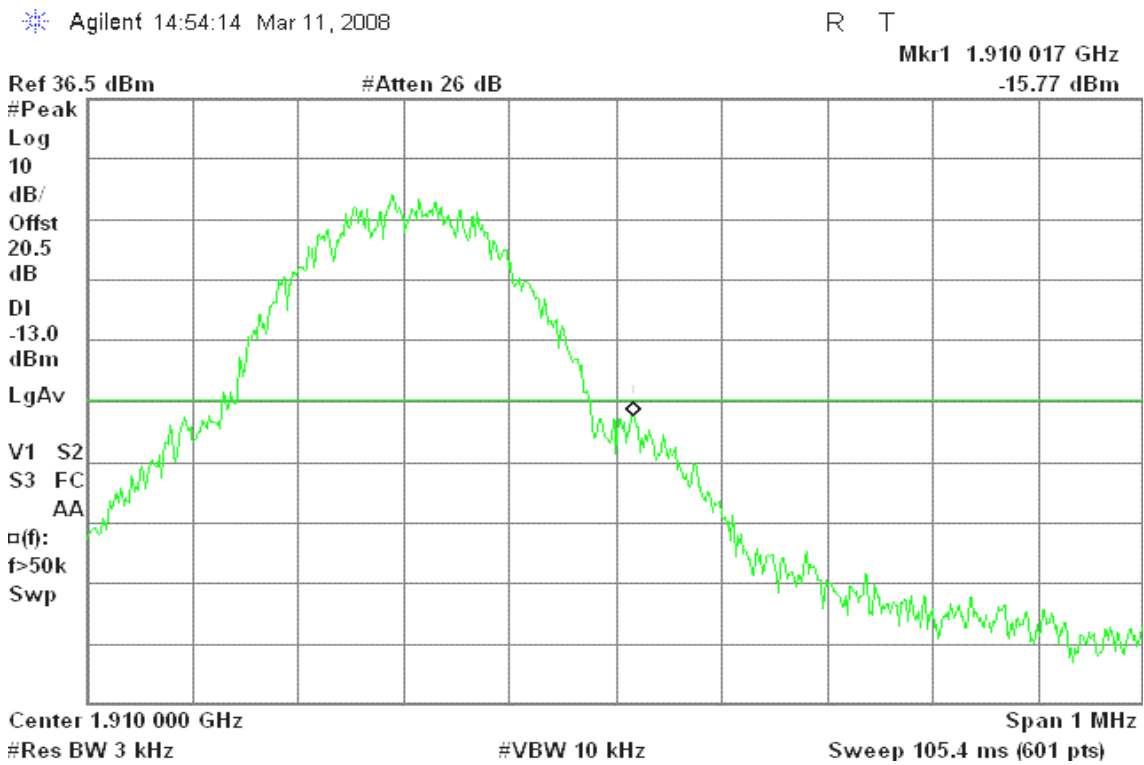

Figure 10-4: Band Edge emissions – GPRS CH High





EDGE 850

Figure 11-1: Out of Band emission at antenna terminals –EDGE CH Low

Agilent 10:45:31 Mar 12, 2008

R T

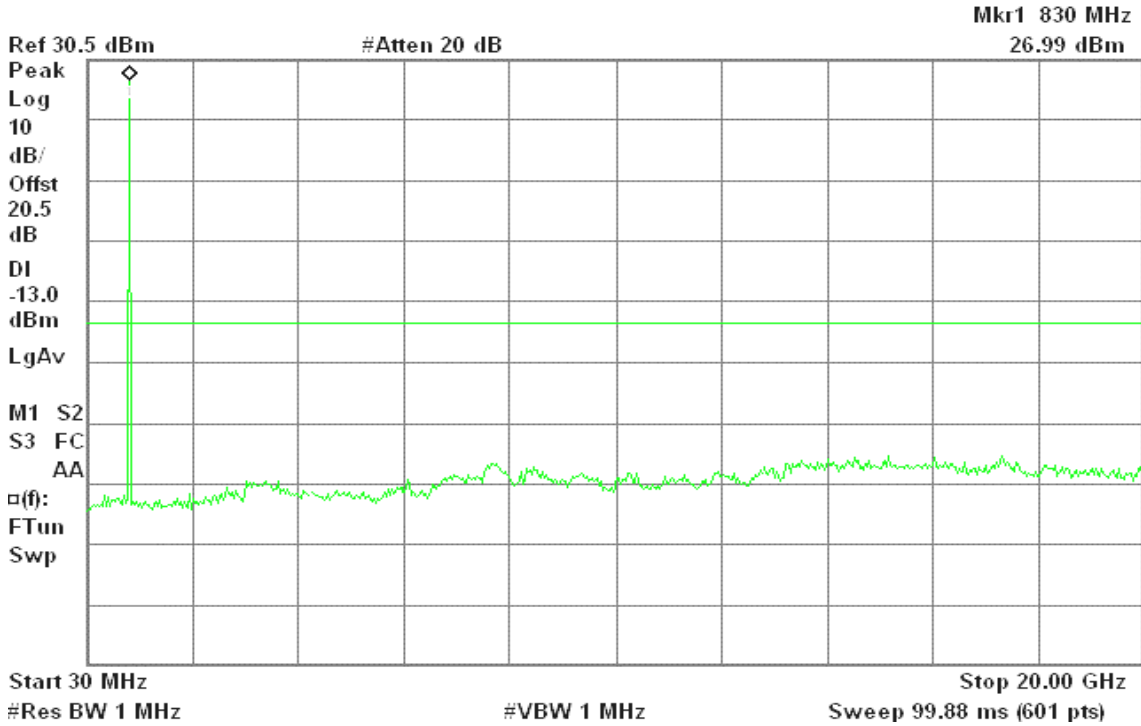

Figure 11-2: Out of Band emission at antenna terminals –EDGE CH Mid

Agilent 10:45:45 Mar 12, 2008

R T

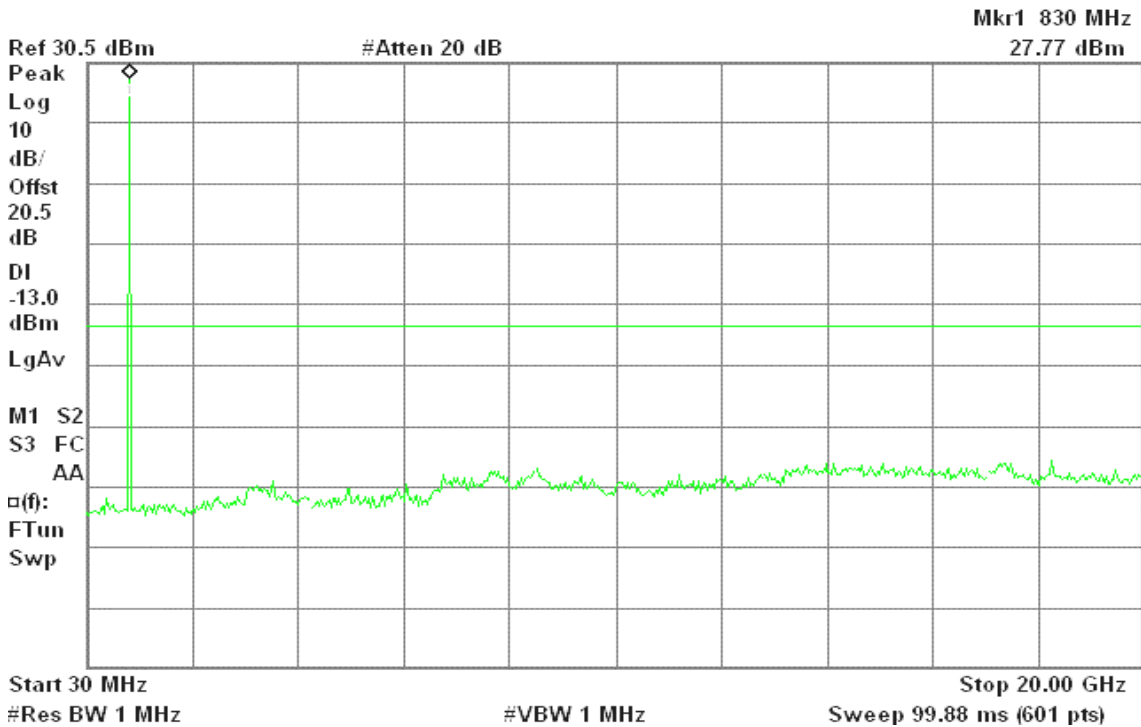
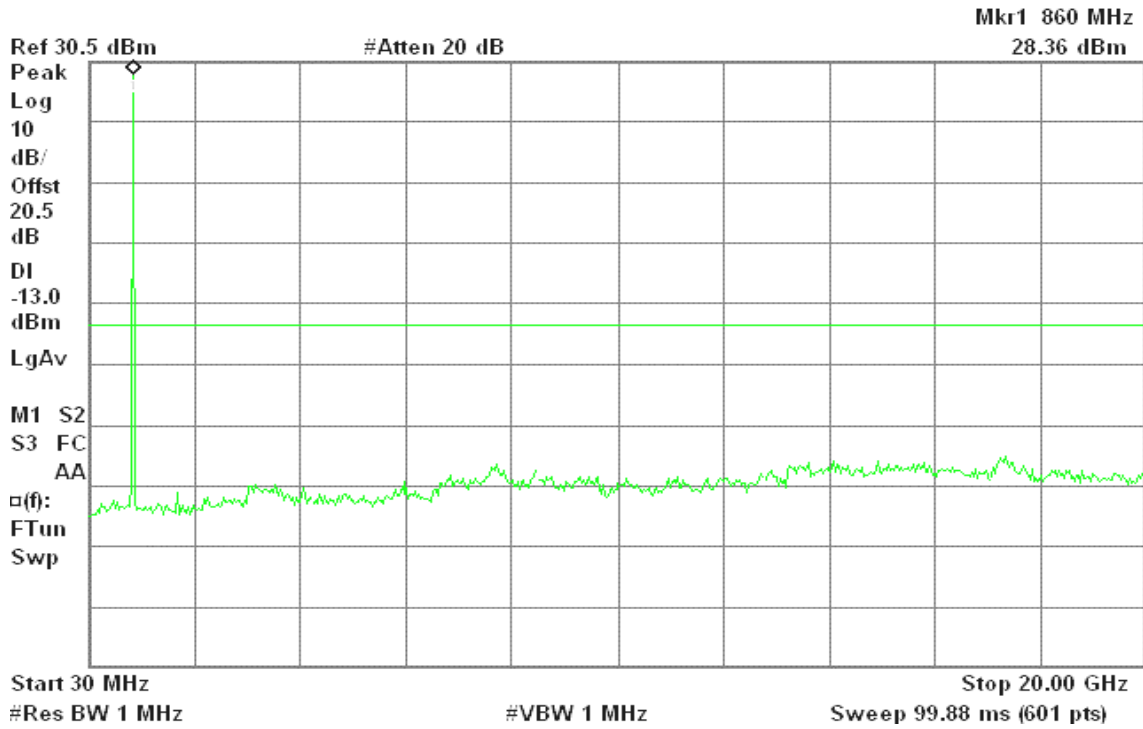



Figure 11-3: Out of Band emission at antenna terminals –EDGE CH High

Agilent 10:46:03 Mar 12, 2008

R T



EDGE 1900

Figure 11-4: Out of Band emission at antenna terminals –EDGE CH Low

Agilent 11:01:04 Mar 12, 2008

R T

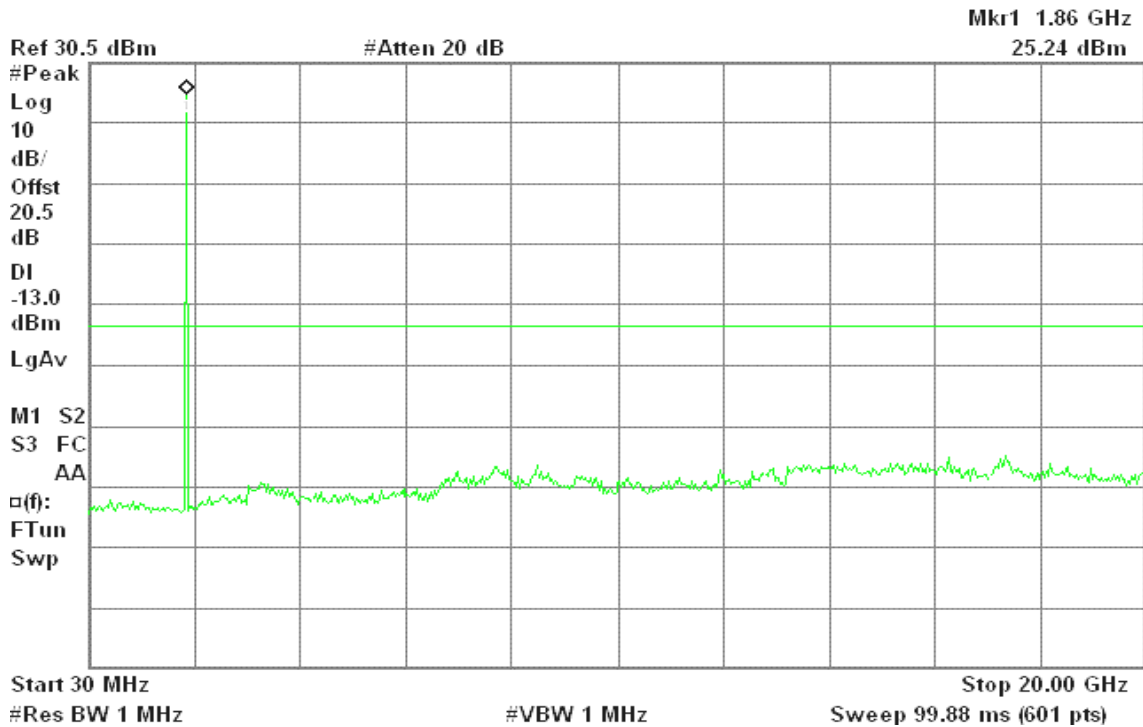



Figure 11-5: Out of Band emission at antenna terminals –EDGE CH Mid

Agilent 11:01:23 Mar 12, 2008

R T

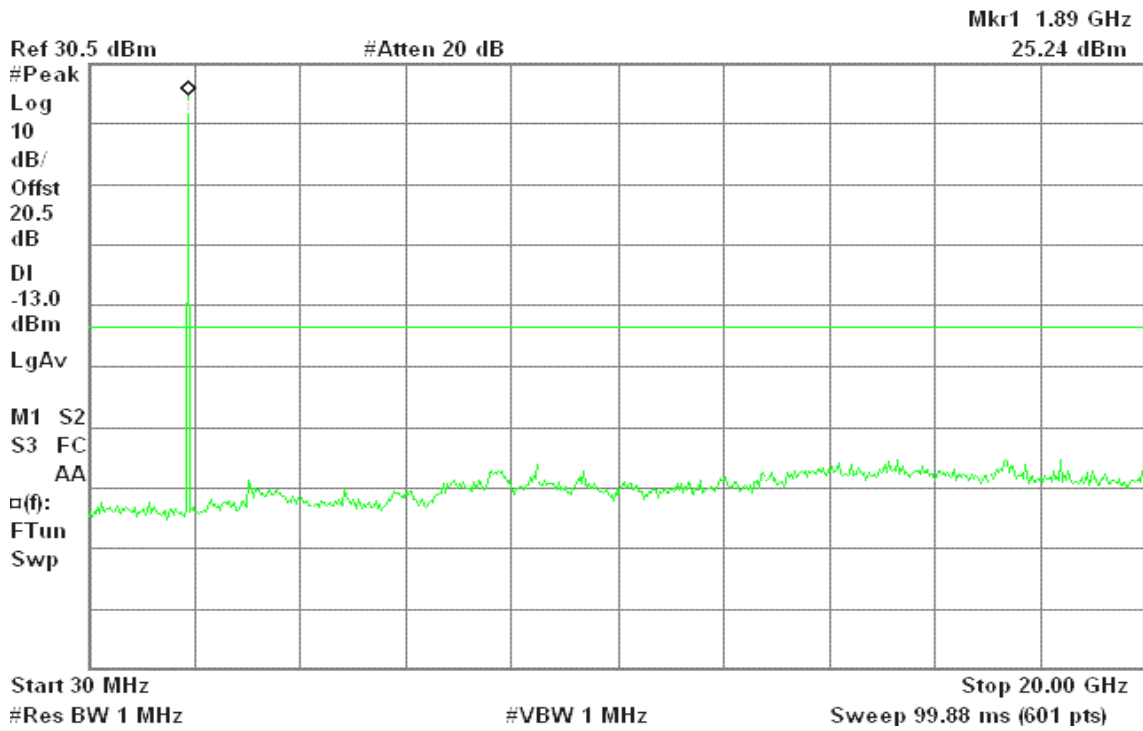
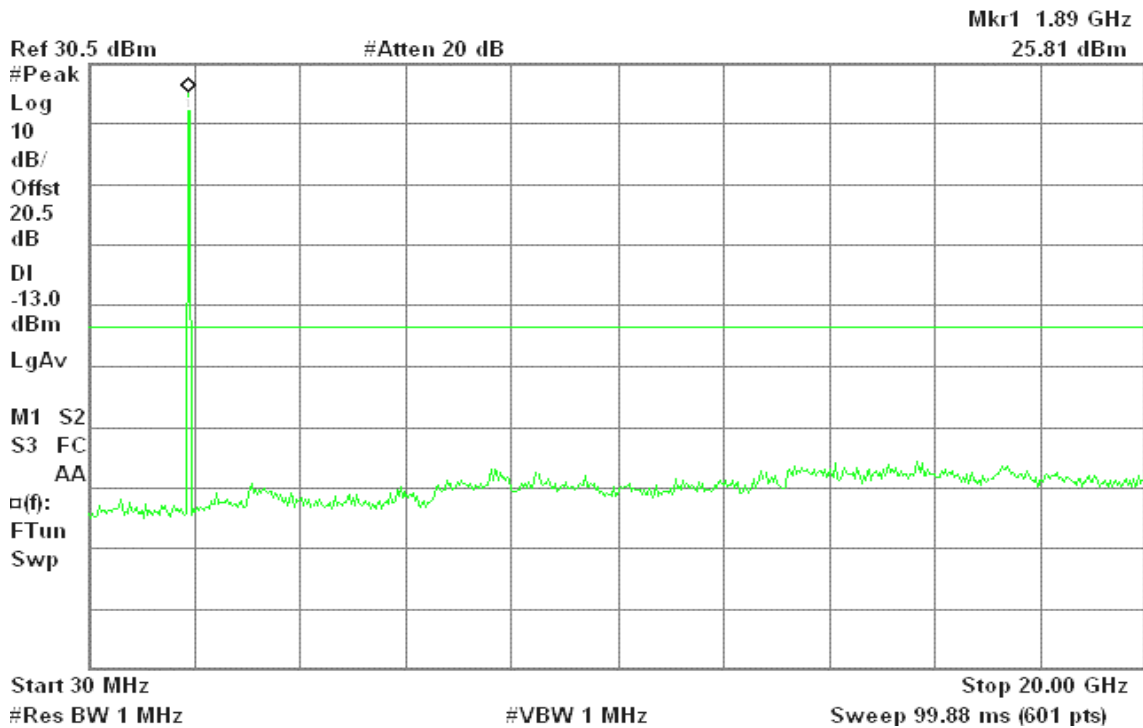

Figure 11-6: Out of Band emission at antenna terminals –EDGE CH High

Agilent 11:01:37 Mar 12, 2008

R T





EDGE 850

Figure 12-1: Band Edge emissions – EDGE CH Low

Agilent 10:44:42 Mar 12, 2008

R T

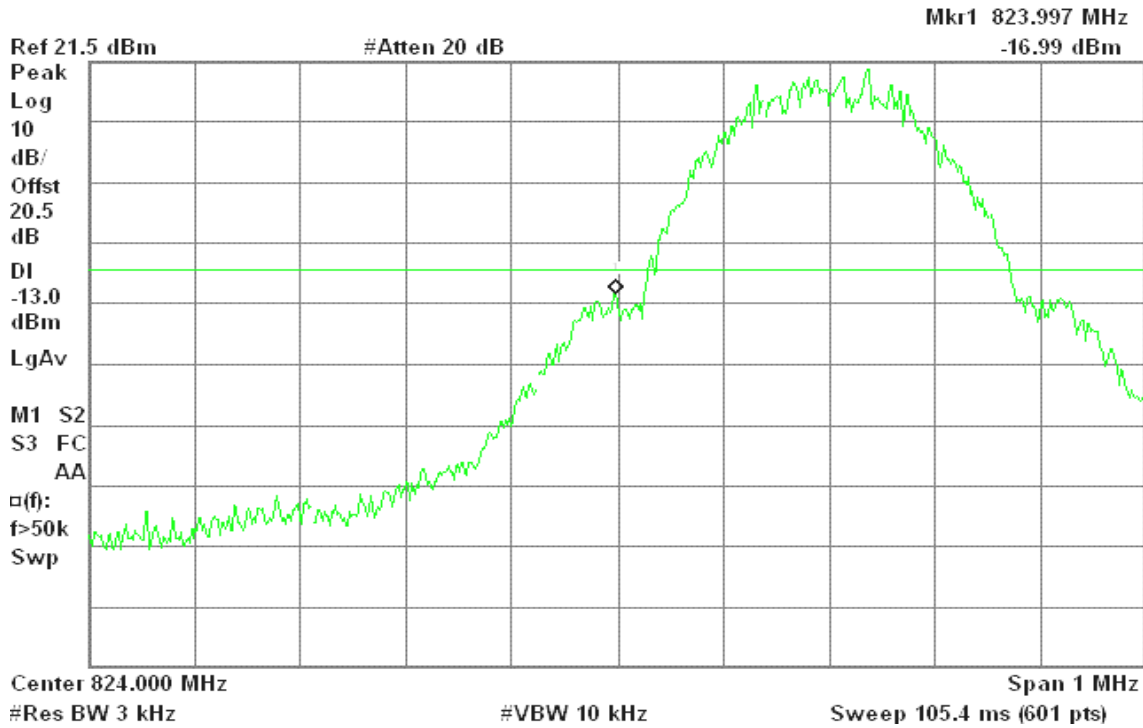
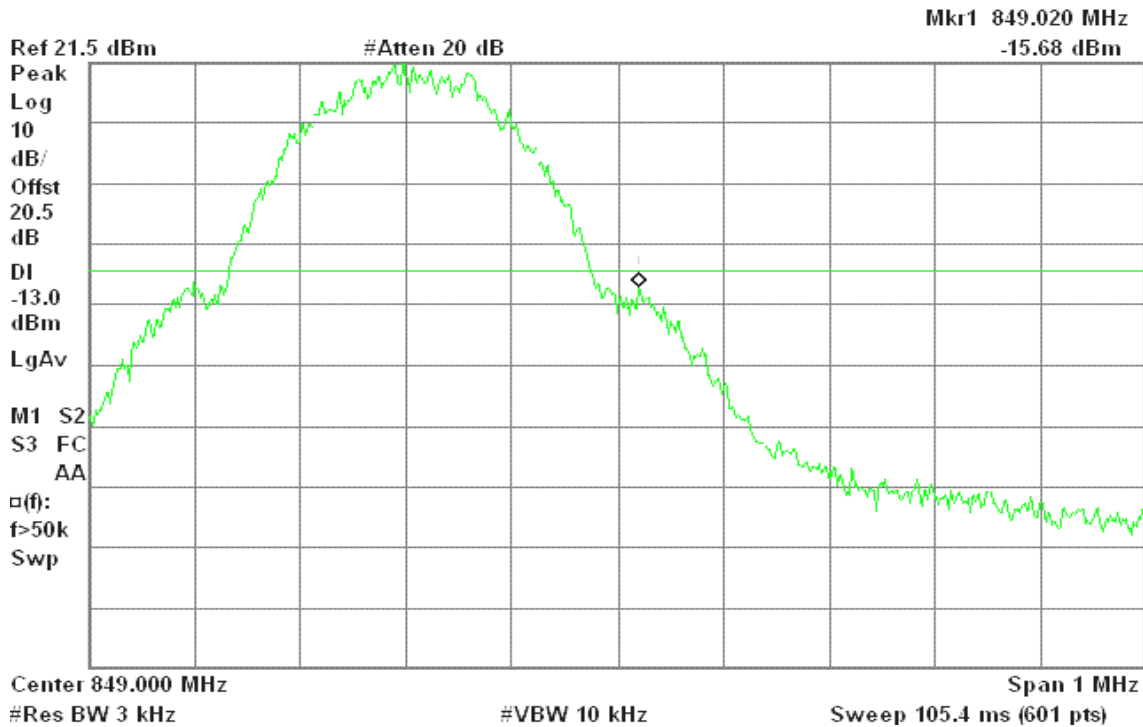

Figure 12-2: Band Edge emissions – EDGE CH High

Agilent 10:43:32 Mar 12, 2008

R T





EDGE 1900

Figure 12-3: Band Edge emissions – EDGE CH Low

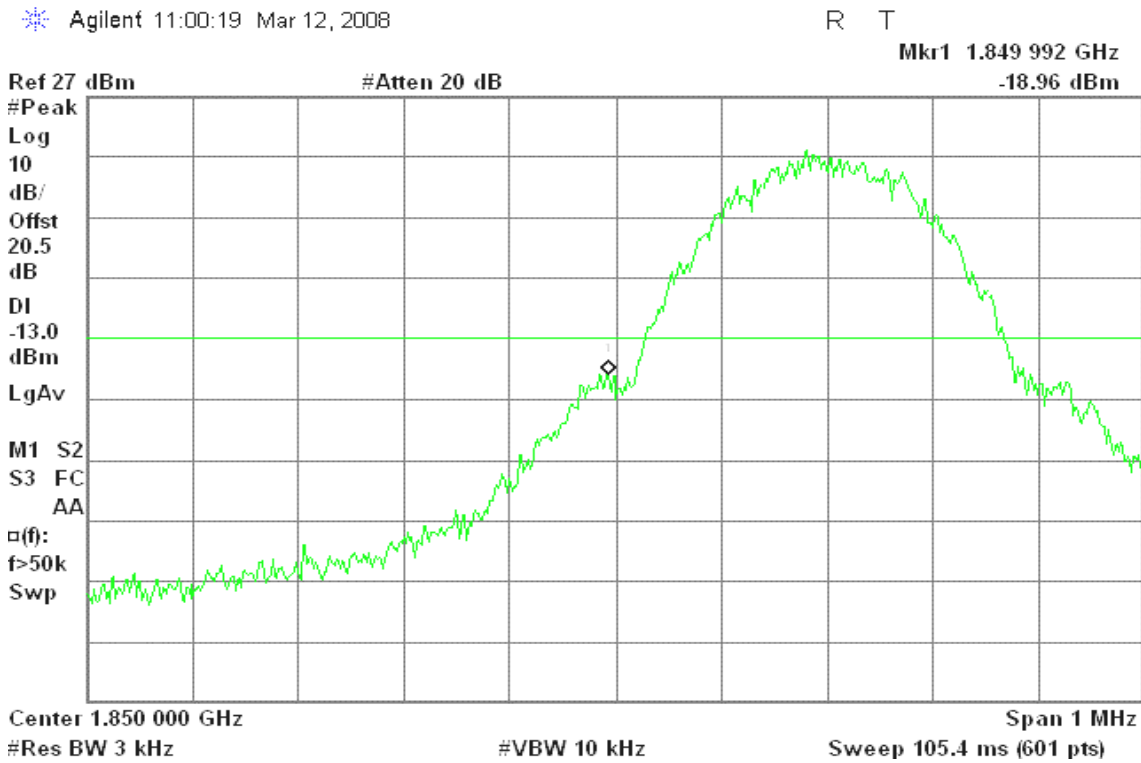
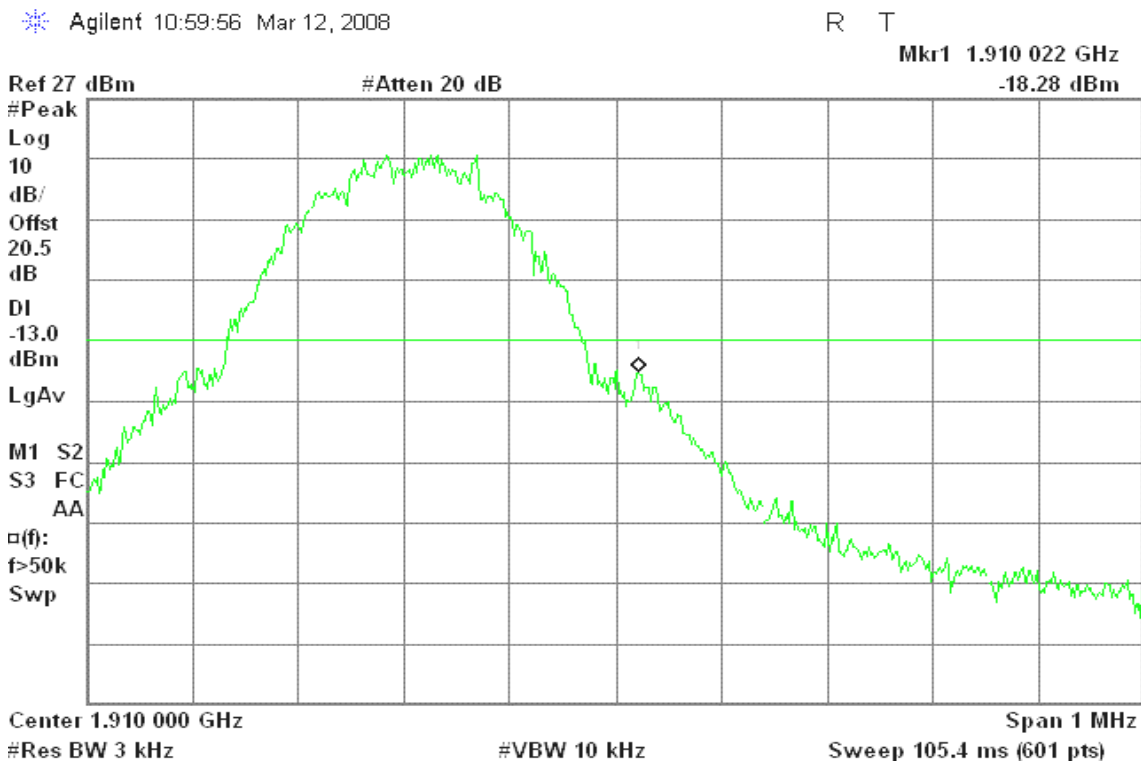

Figure 12-4: Band Edge emissions – EDGE CH High





WCDMA Band II

Figure 13-1: Out of Band emission at antenna terminals – WCDMA CH Low

Agilent 10:48:42 Mar 13, 2008

R T

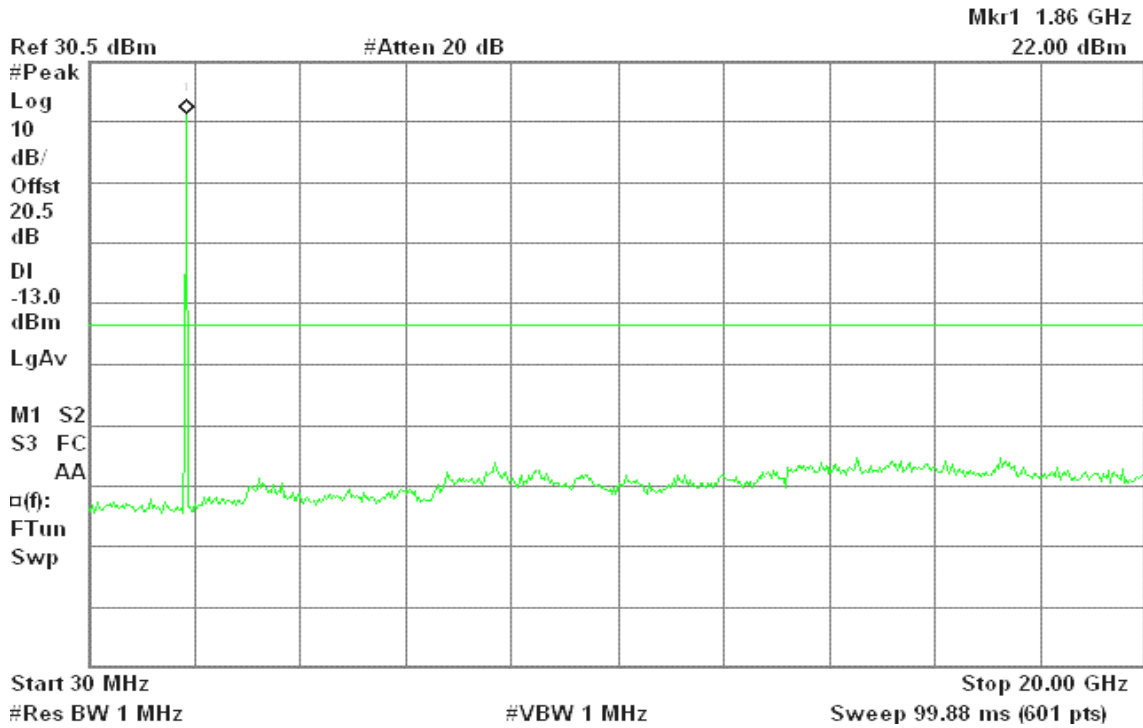

Figure 13-2: Out of Band emission at antenna terminals – WCDMA CH Mid

Agilent 10:48:58 Mar 13, 2008

R T

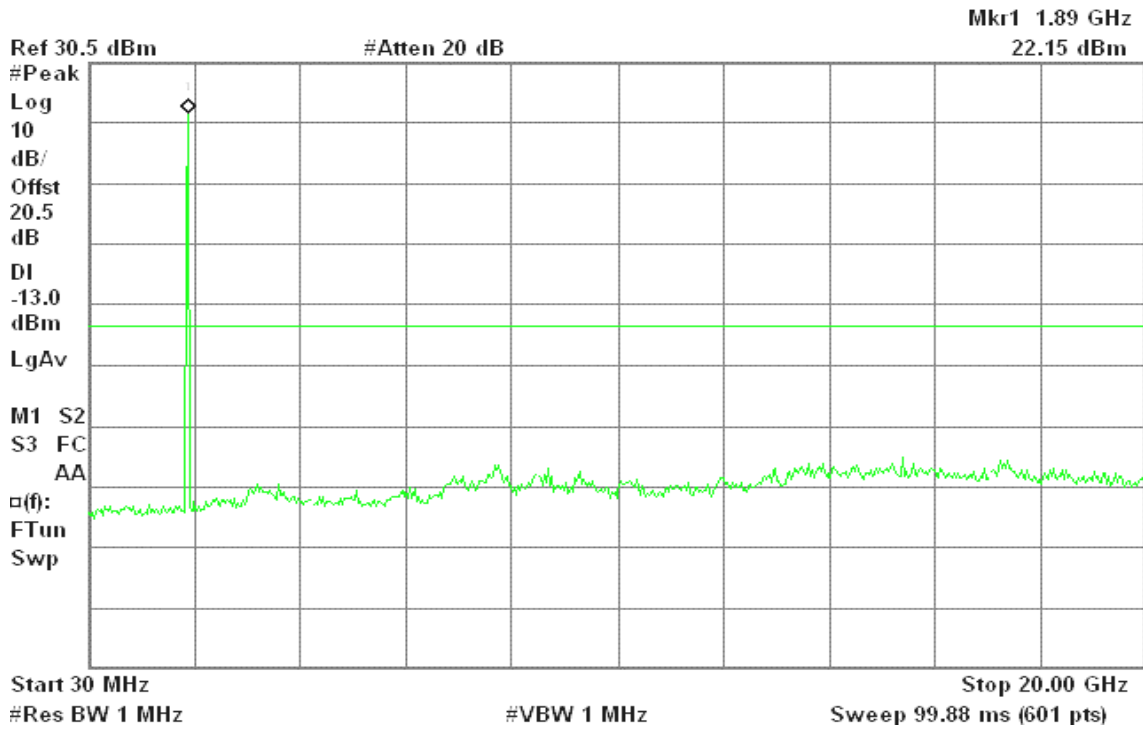
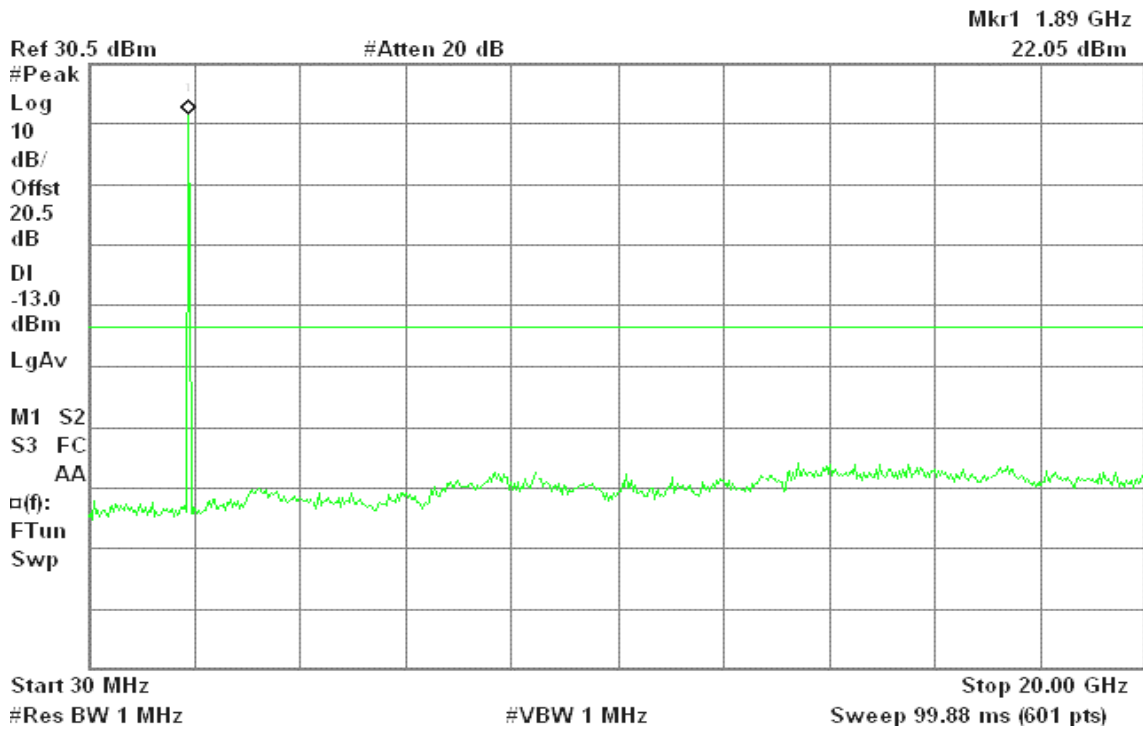



Figure 13-3: Out of Band emission at antenna terminals – WCDMA CH High

Agilent 10:49:09 Mar 13, 2008

R T



WCDMA Band V

Figure 13-4: Out of Band emission at antenna terminals – WCDMA CH Low

Agilent 11:29:25 Mar 13, 2008

R T

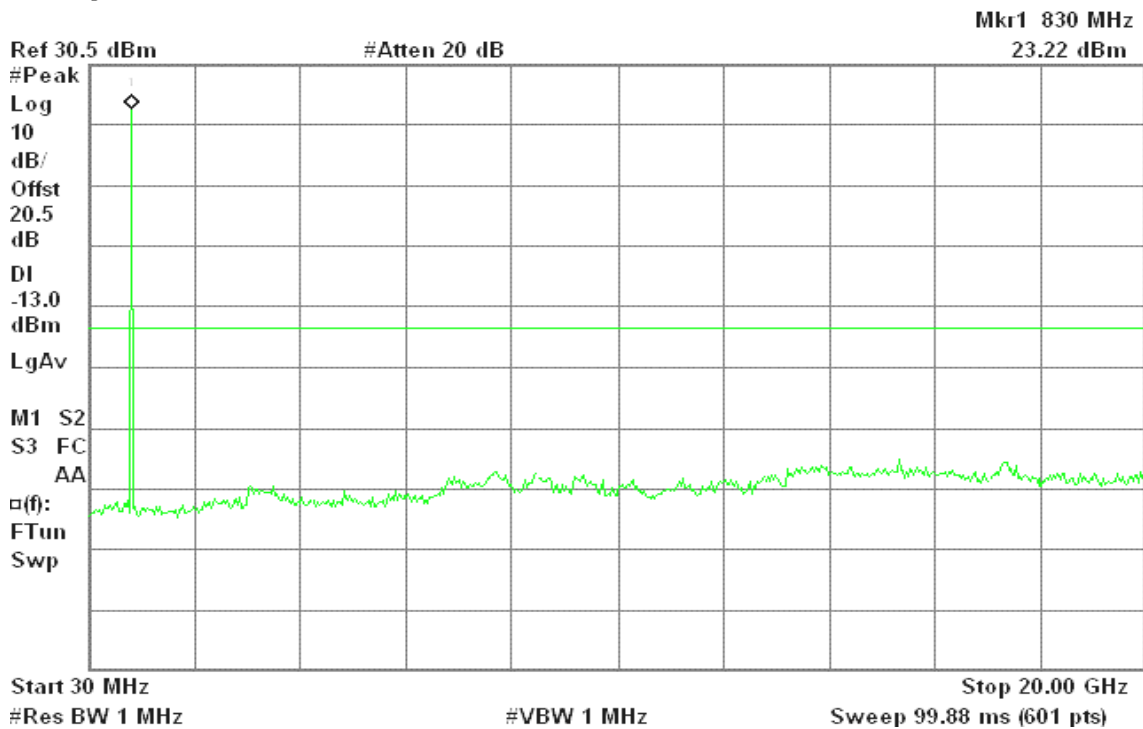



Figure 13-5: Out of Band emission at antenna terminals – WCDMA CH Mid

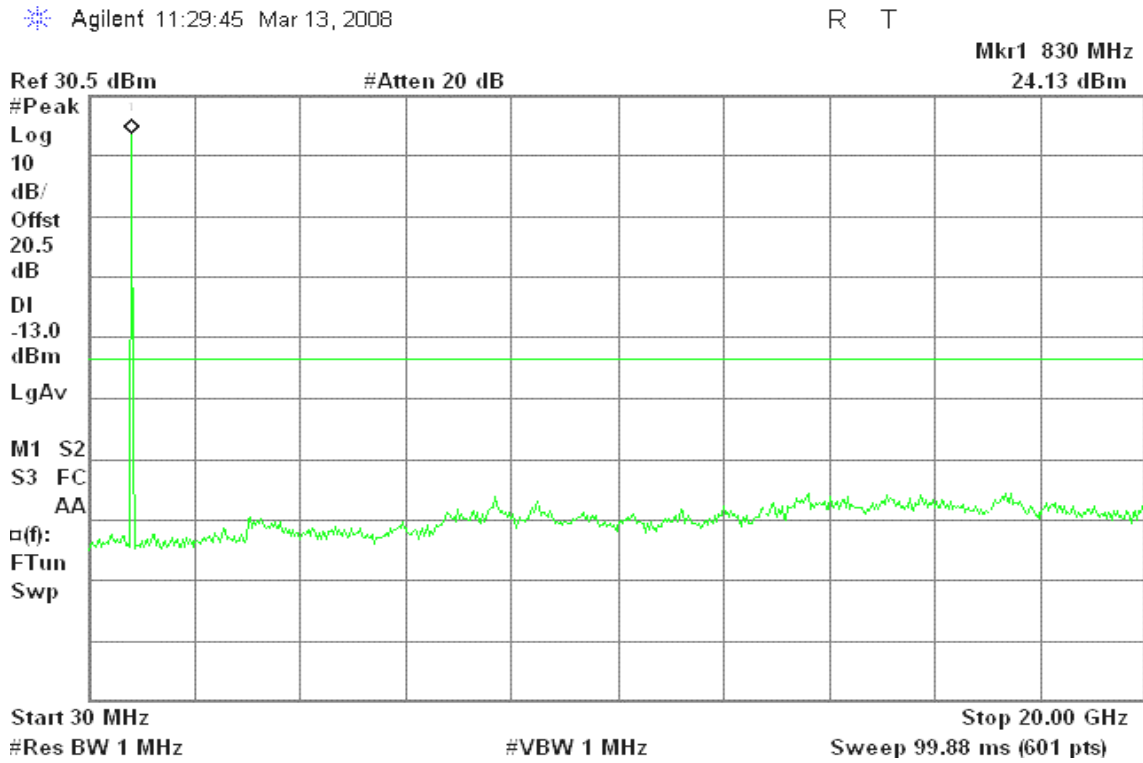
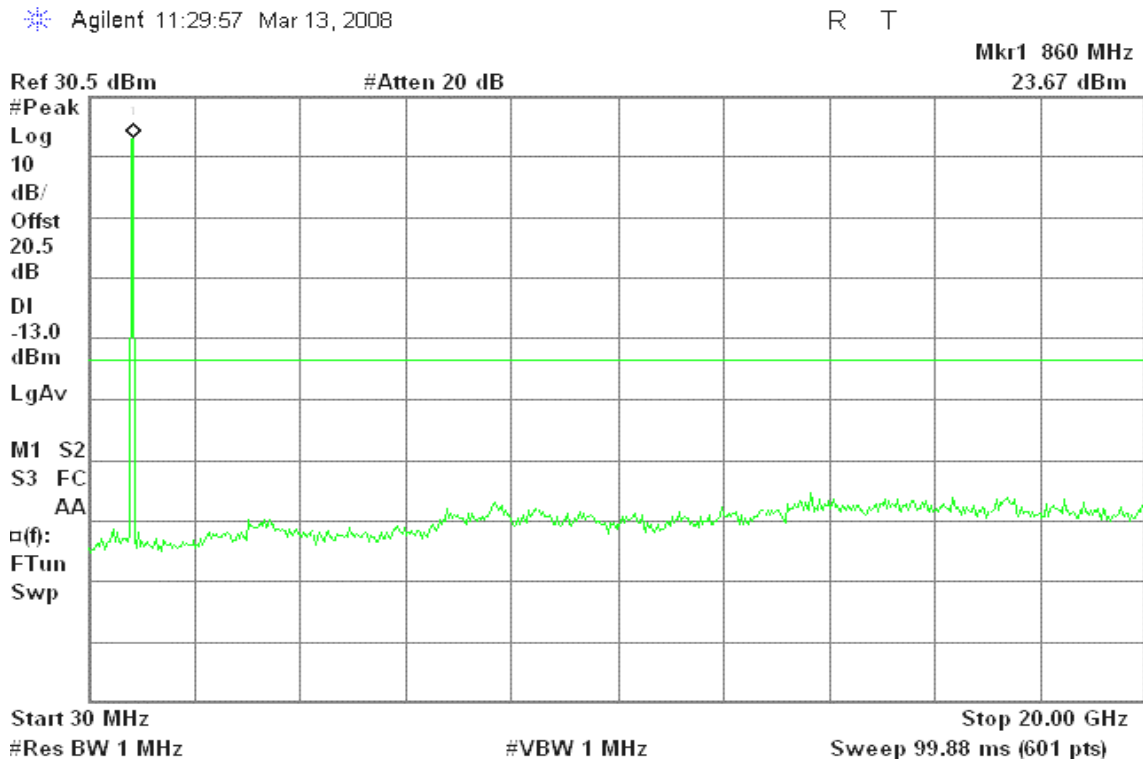

Figure 13-6: Out of Band emission at antenna terminals – WCDMA CH High





WCDMA Band II

Figure 14-1: Band Edge emissions – WCDMA CH Low

Agilent 10:48:02 Mar 13, 2008

R T

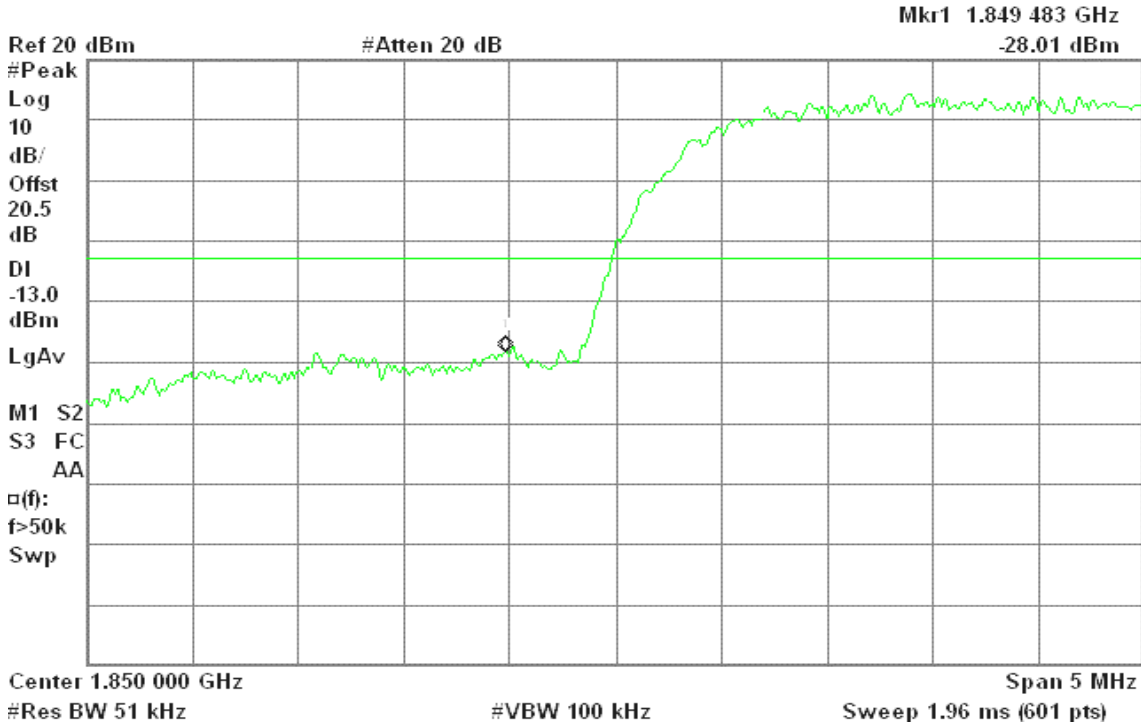
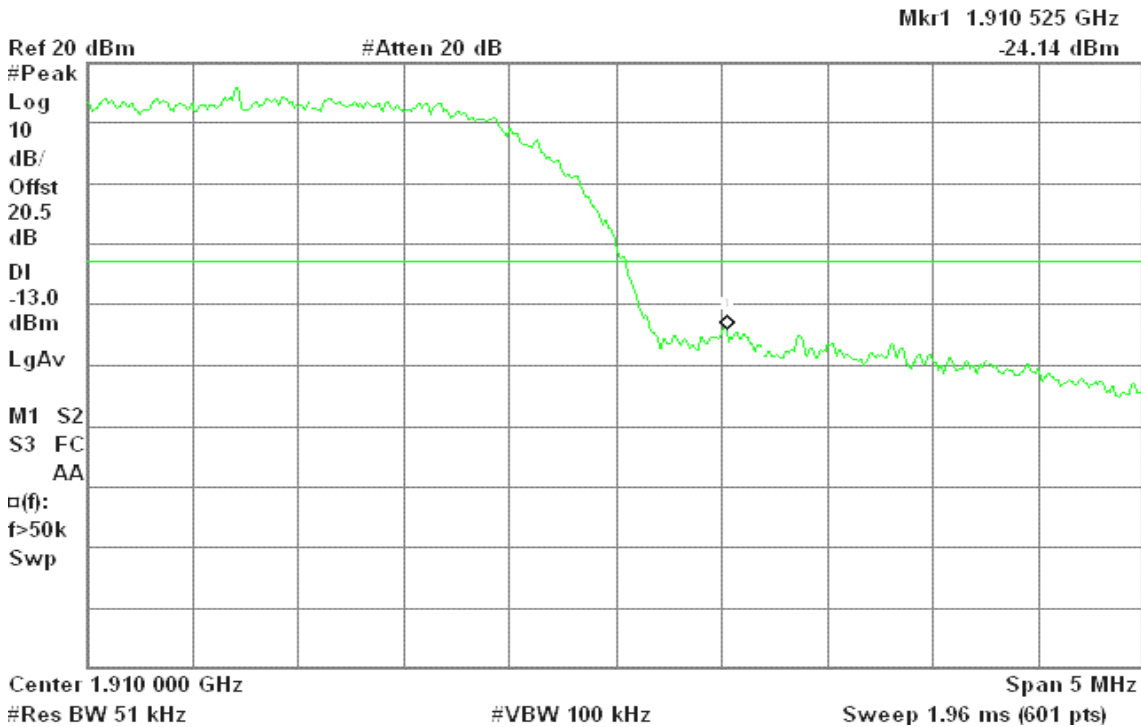

Figure 14-2: Band Edge emissions –WCDMA CH High

Agilent 10:47:34 Mar 13, 2008

R T





WCDMA Band V

Figure 14-3: Band Edge emissions –WCDMA CH Low

Agilent 11:29:25 Mar 13, 2008

R T

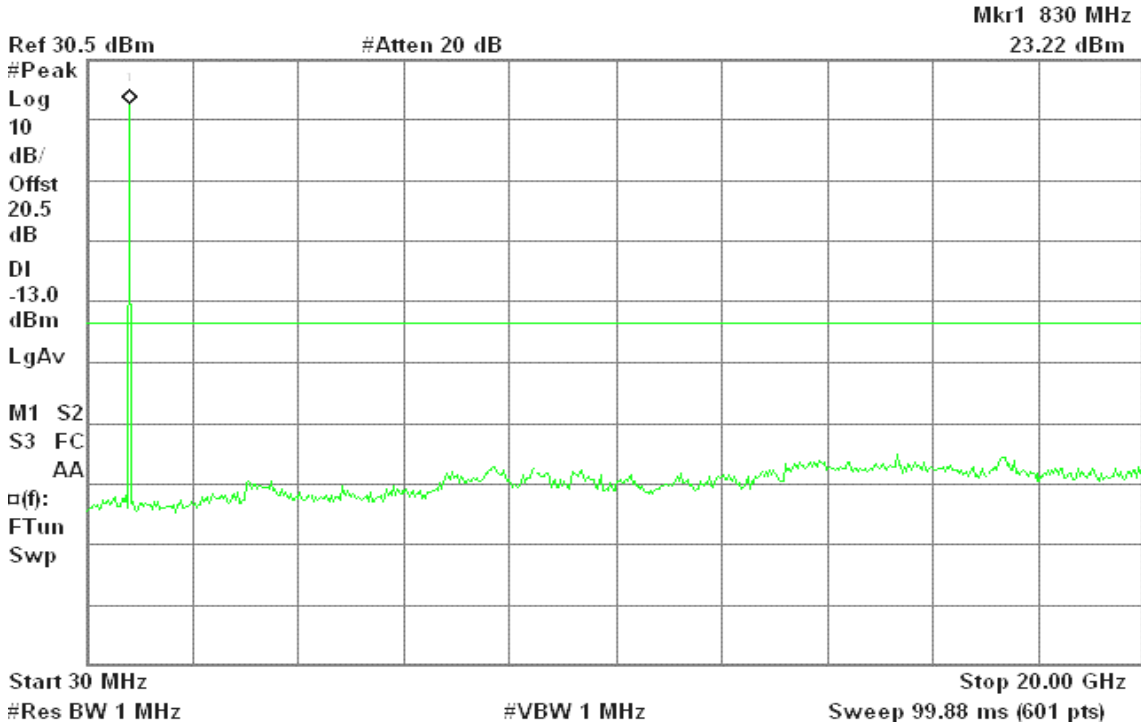
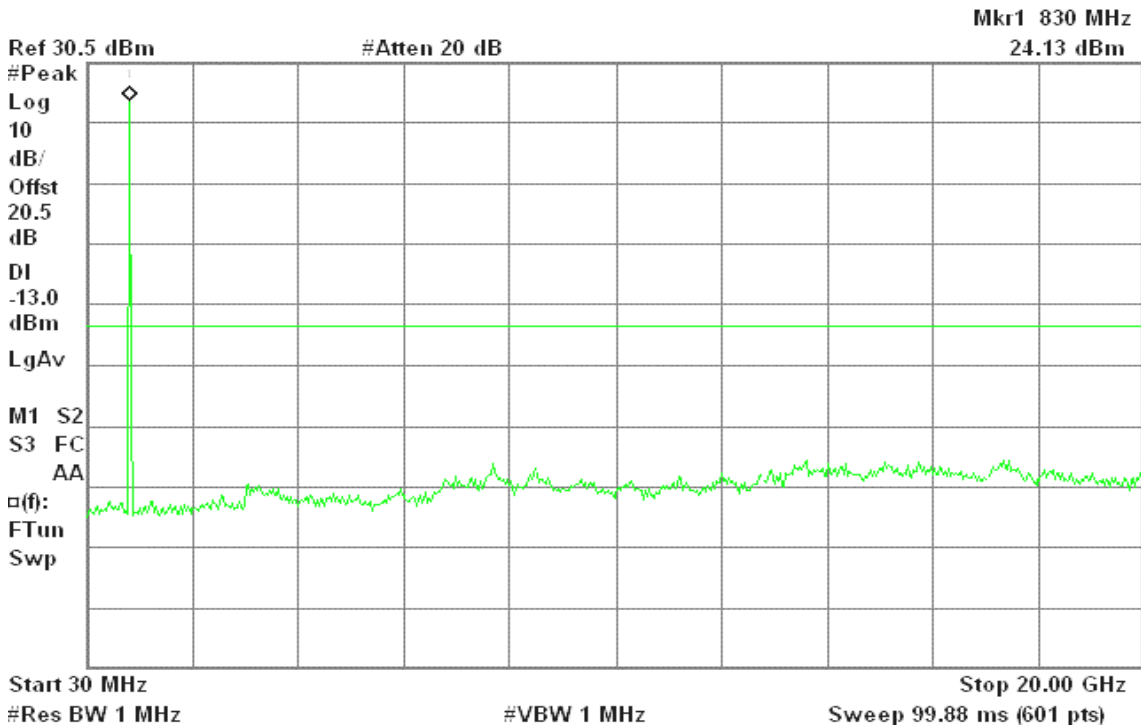

Figure 14-4: Band Edge emissions –WCDMA CH High

Agilent 11:29:45 Mar 13, 2008

R T





WCDMA / HSDPA Band II

Figure 15-1: Out of Band emission at antenna terminals – HSDPA CH Low

Agilent 16:41:12 Mar 13, 2008

R T

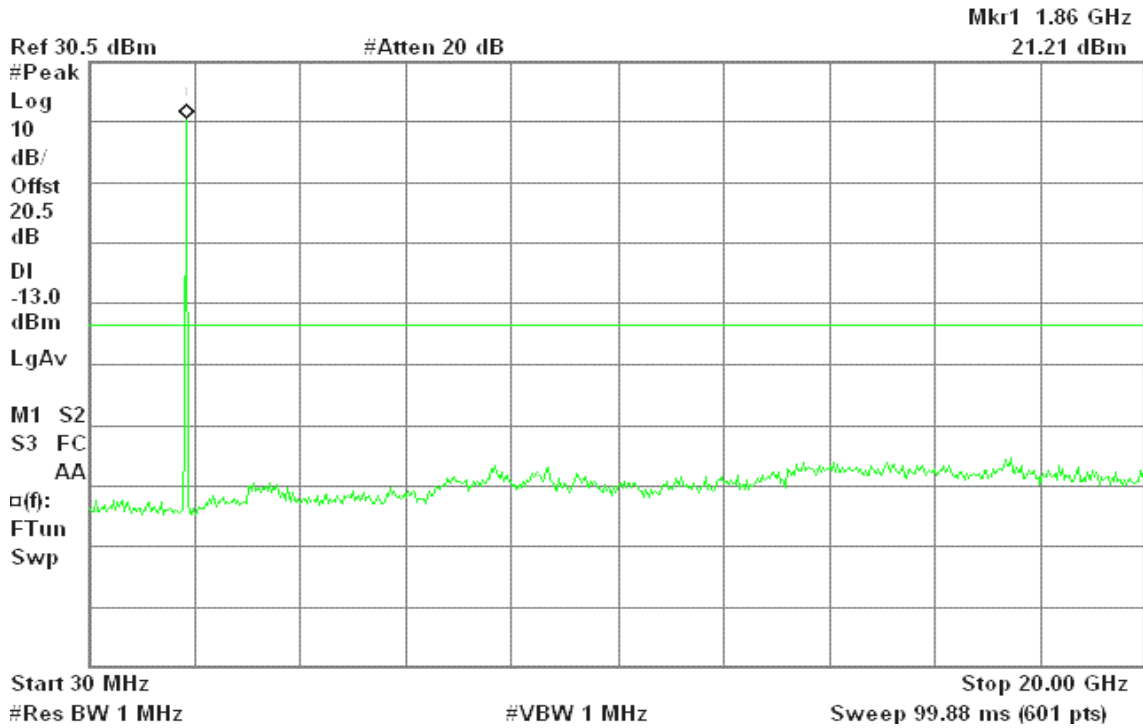

Figure 15-2: Out of Band emission at antenna terminals – HSDPA CH Mid

Agilent 16:41:25 Mar 13, 2008

R T

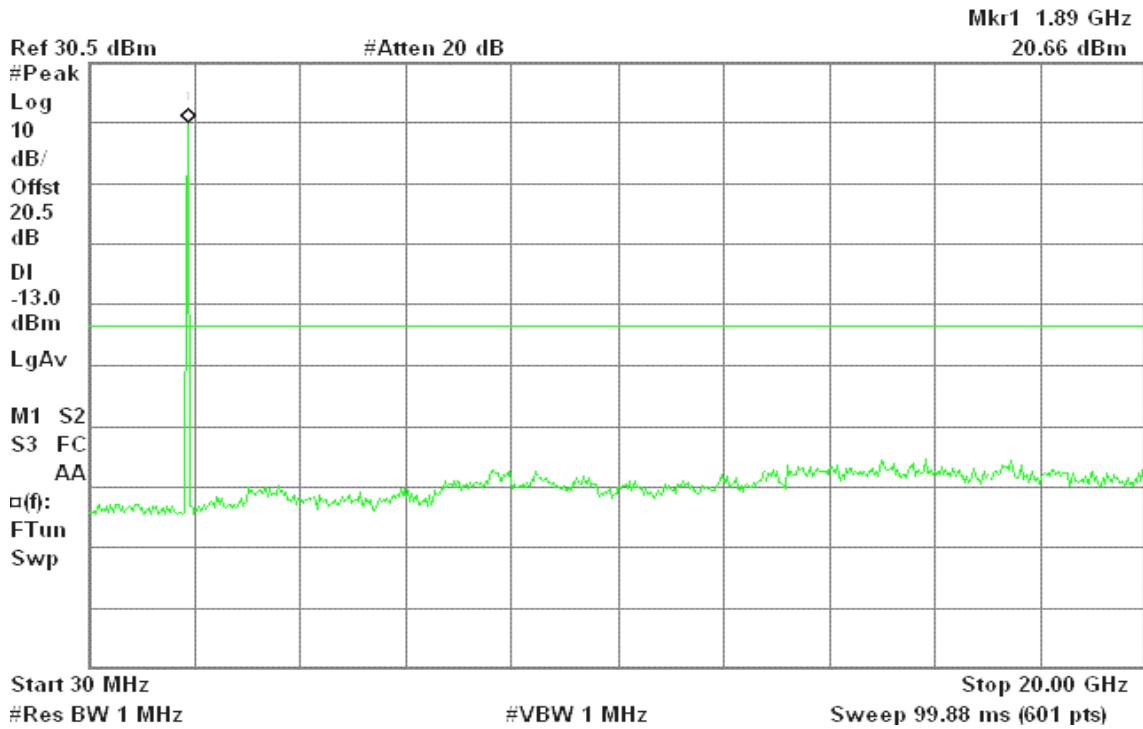
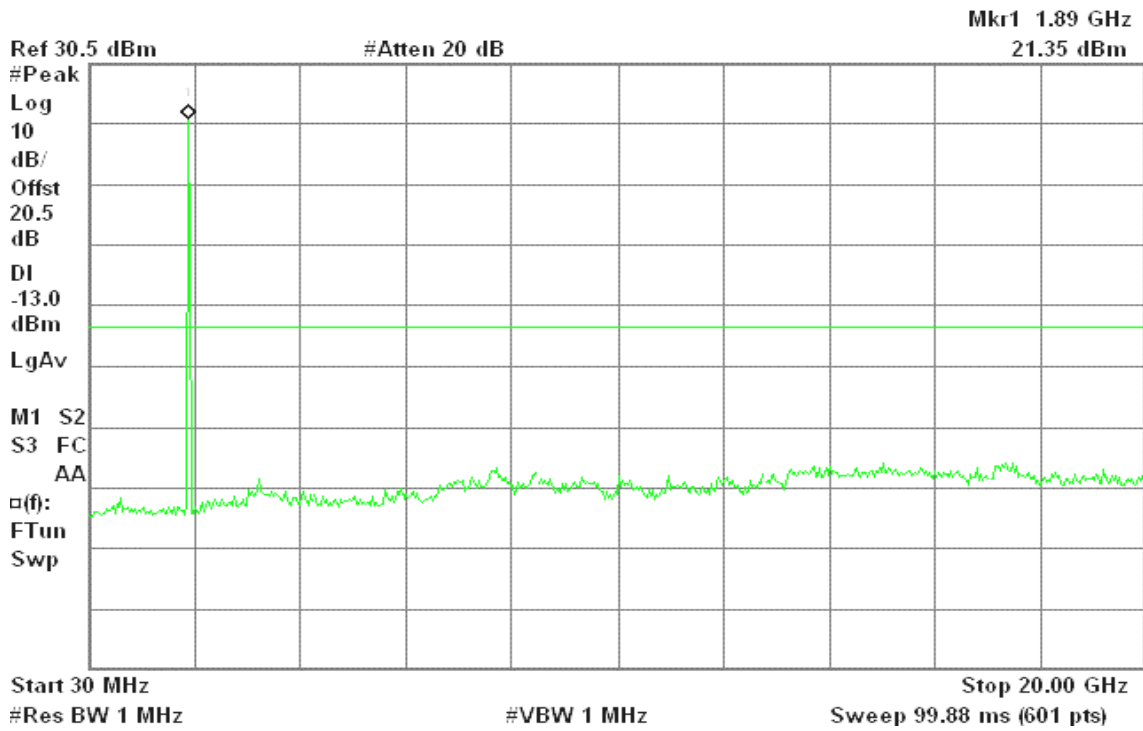



Figure 15-3: Out of Band emission at antenna terminals – HSDPA CH High

Agilent 16:41:39 Mar 13, 2008

R T



WCDMA / HSDPA Band V

Figure 15-4: Out of Band emission at antenna terminals – HSDPA CH Low

Agilent 16:39:59 Mar 13, 2008

R T

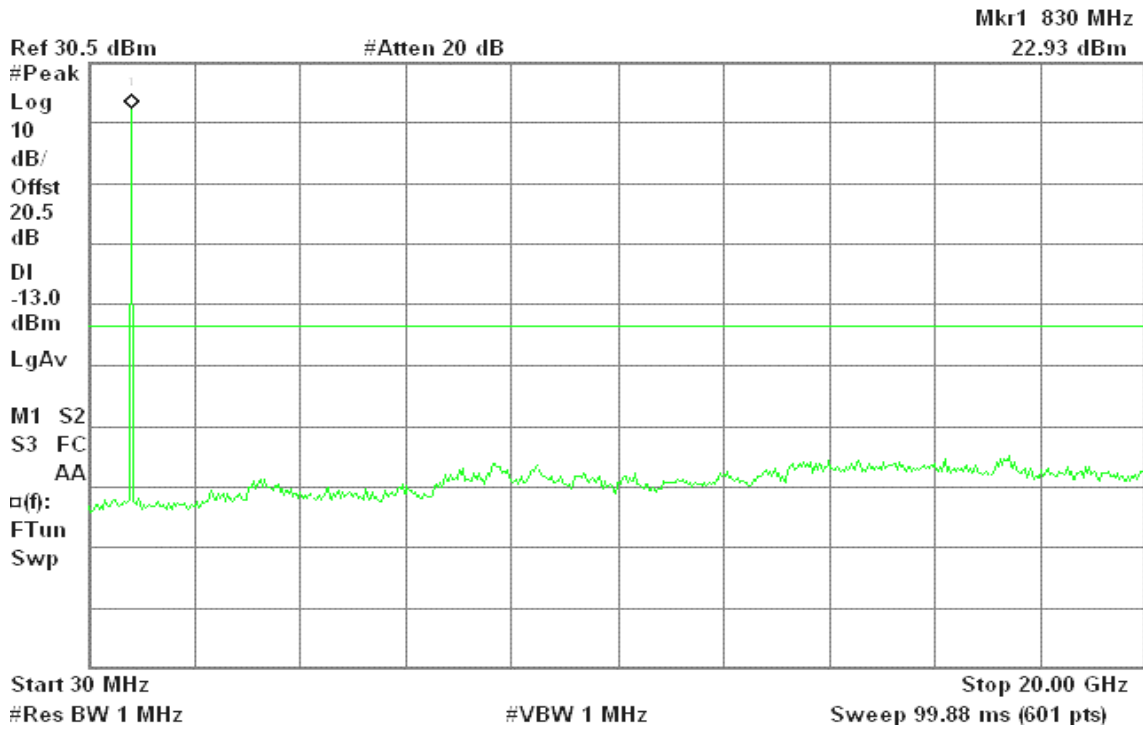



Figure 15-5: Out of Band emission at antenna terminals – HSDPA CH Mid

Agilent 16:40:17 Mar 13, 2008

R T

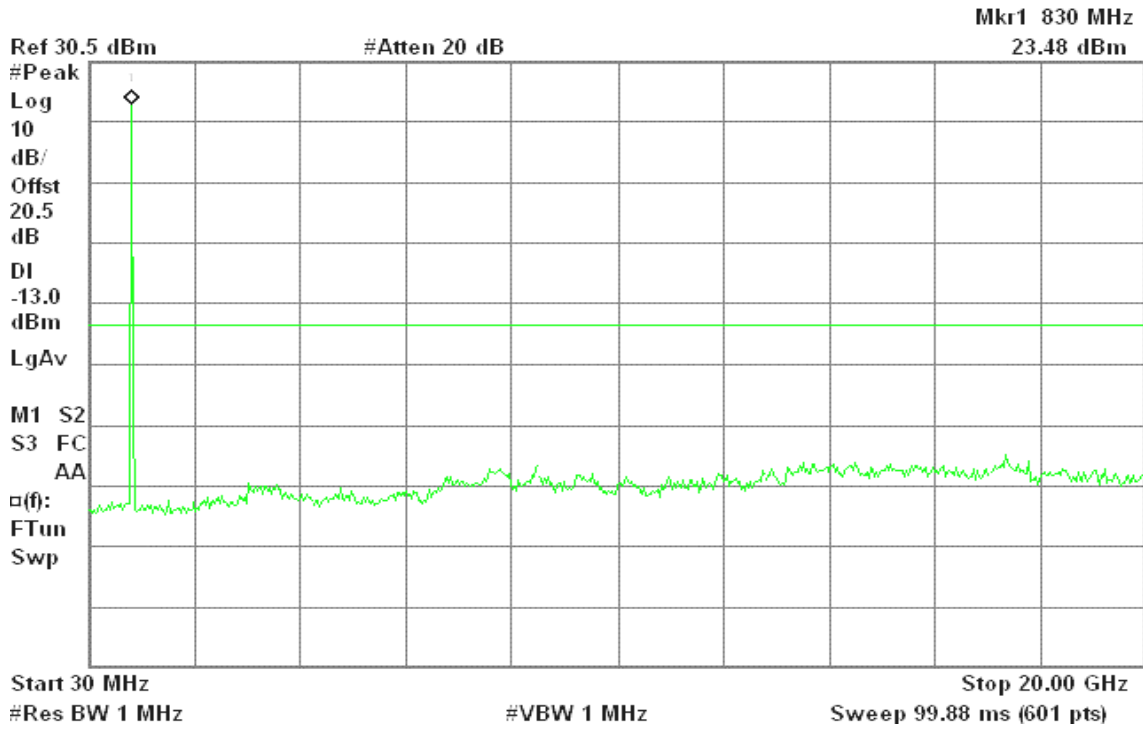
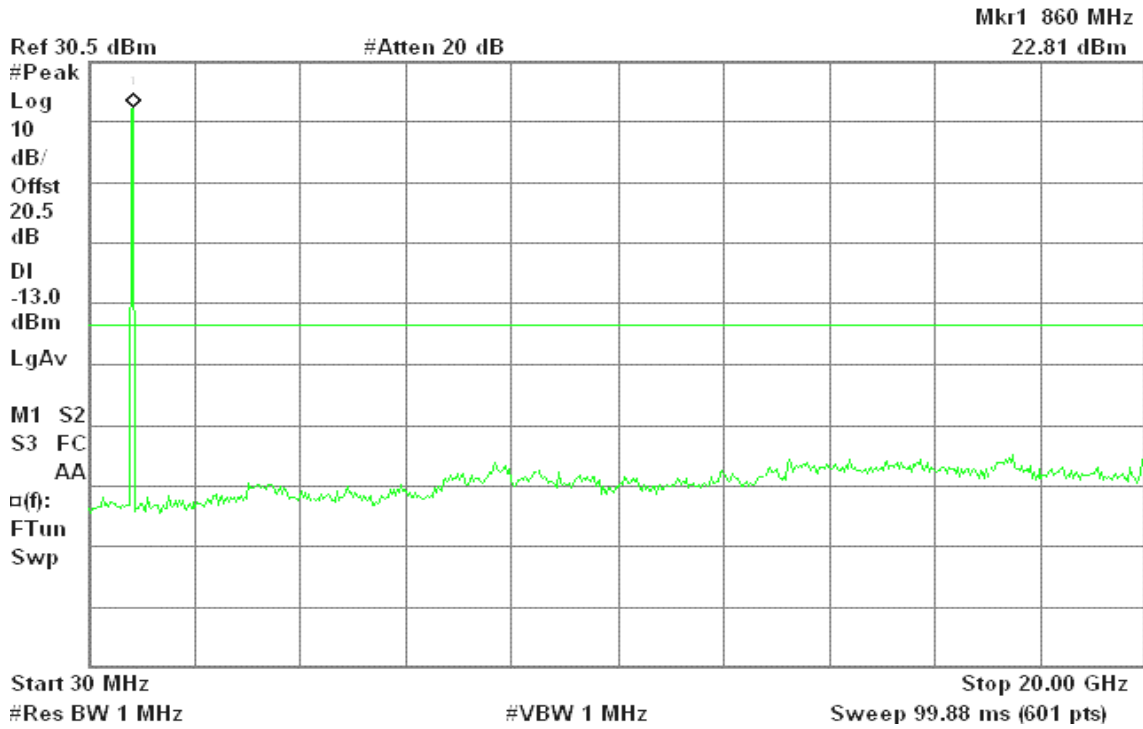

Figure 15-6: Out of Band emission at antenna terminals – HSDPA CH High

Agilent 16:40:45 Mar 13, 2008

R T





WCDMA / HSDPA Band II

Figure 16-1: Band Edge emissions – HSDPA CH Low

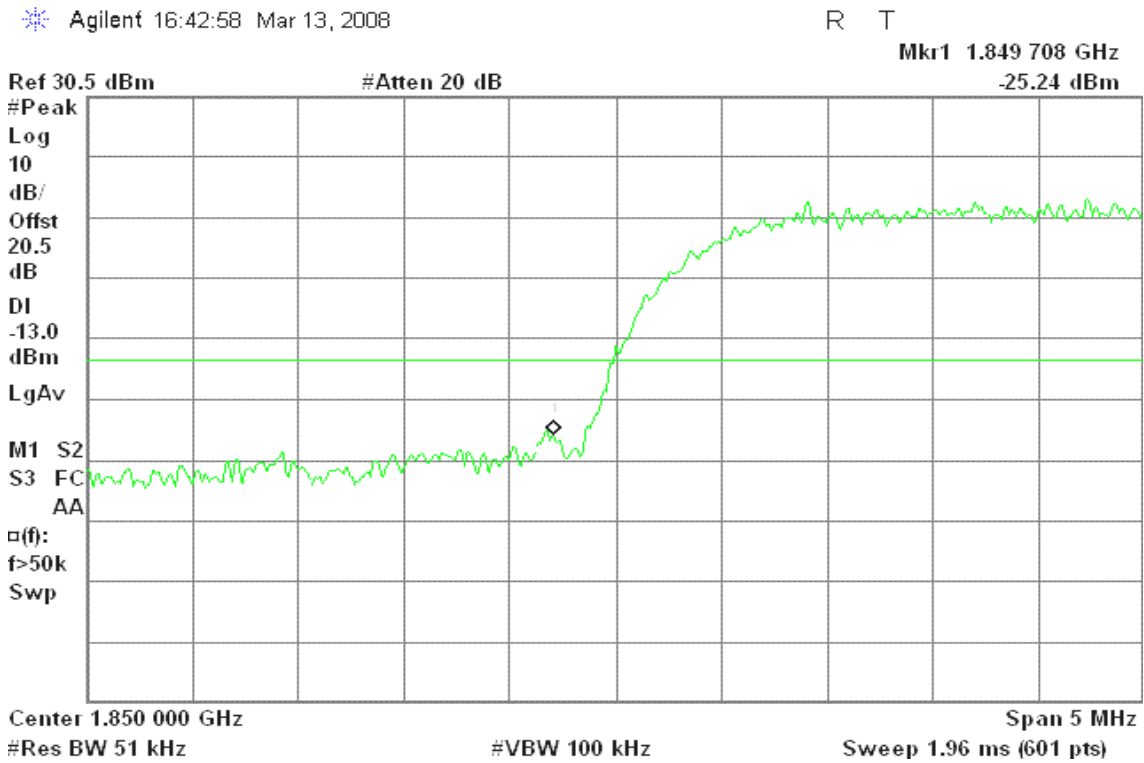
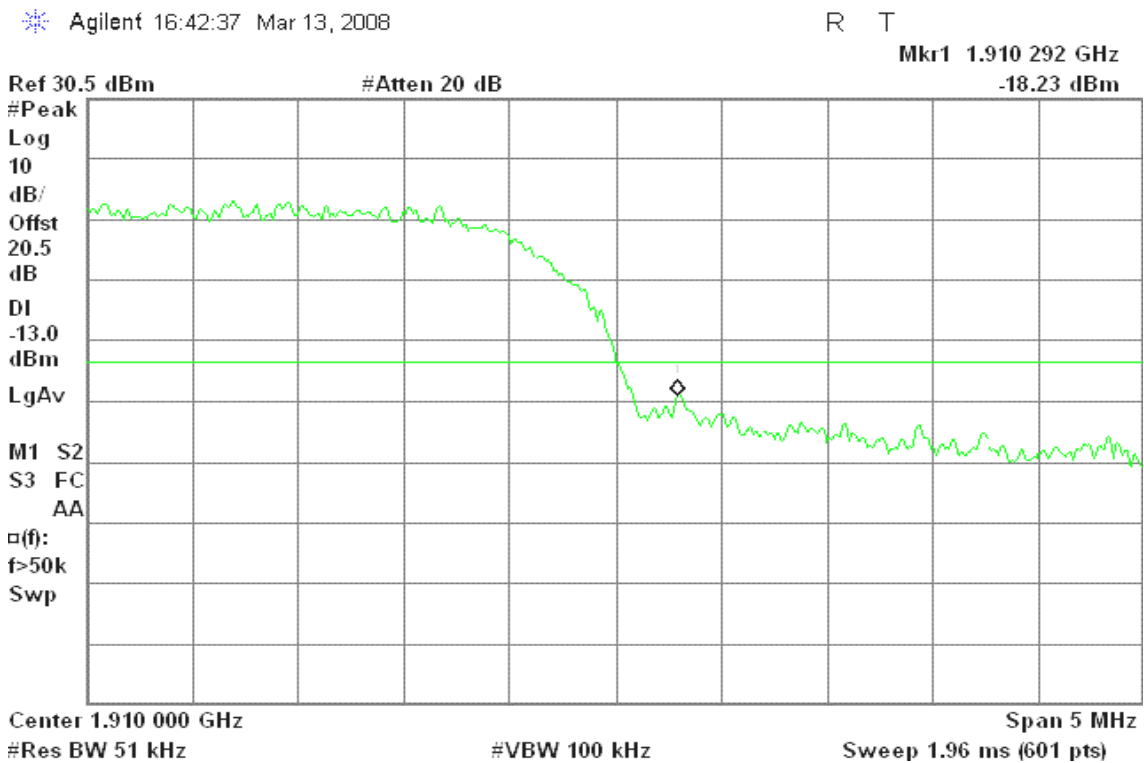

Figure 16-2: Band Edge emissions – HSDPA CH High





WCDMA / HSDPA Band V

Figure 16-3: Band Edge emissions – HSDPA CH Low

Agilent 16:38:42 Mar 13, 2008

R T

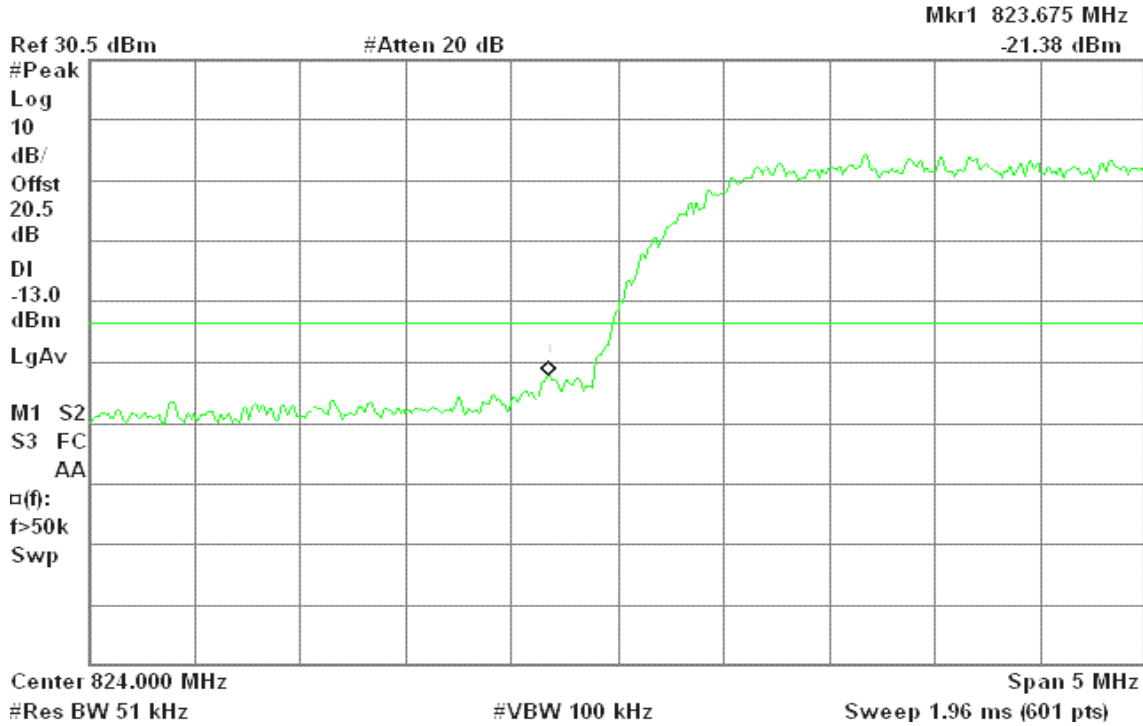
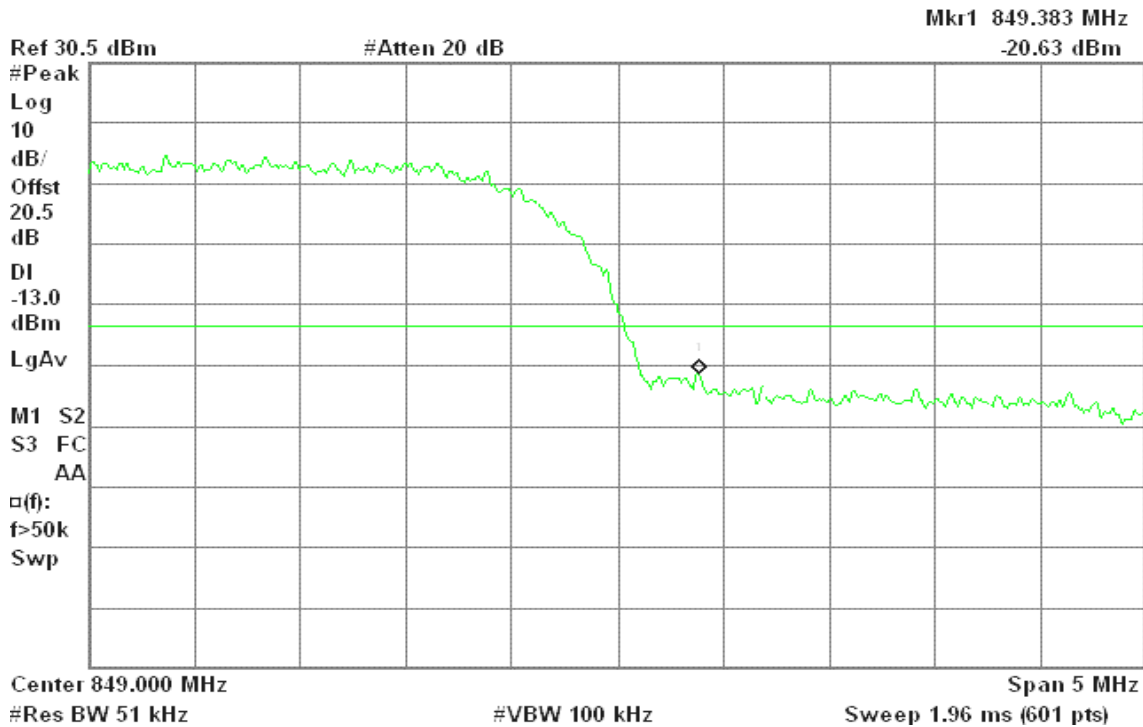

Figure 16-4: Band Edge emissions – HSDPA CH High

Agilent 16:38:14 Mar 13, 2008

R T



7.5 FIELD STRENGTH OF SPURIOUS RADIATION MEASUREMENT

LIMIT

According to FCC §2.1053

Test Configuration

Below 1 GHz

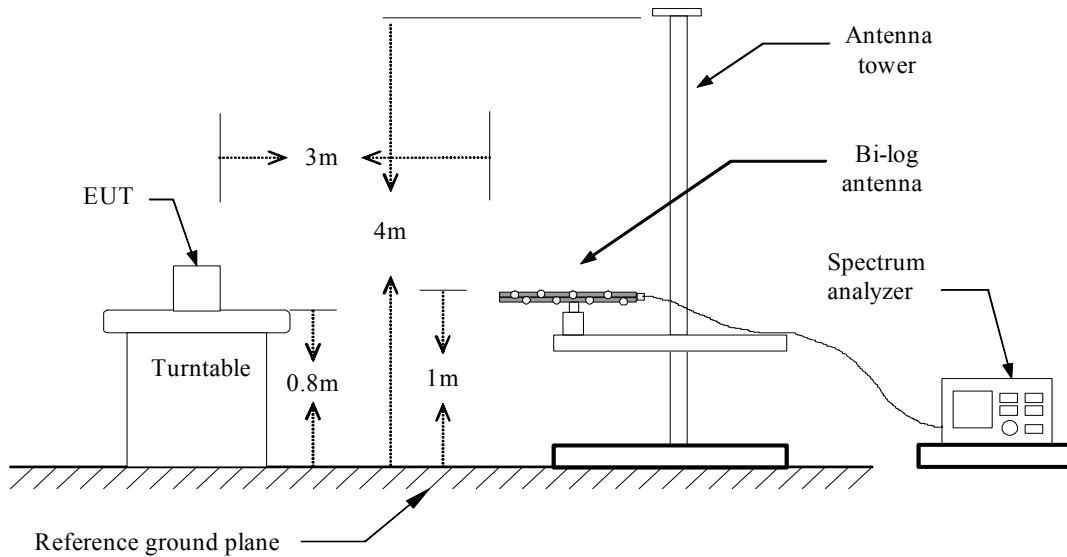

Above 1 GHz

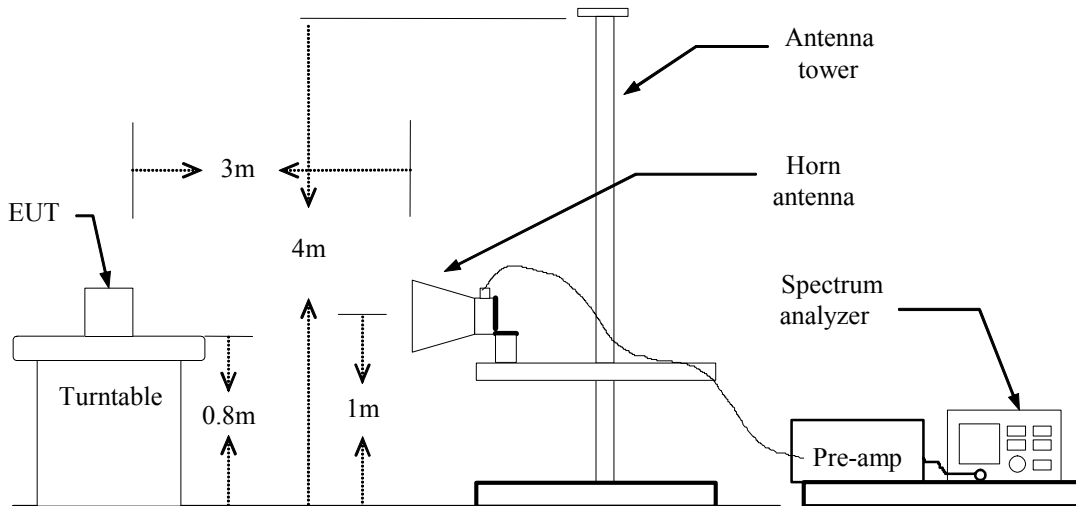

Substituted Method Test Set-up

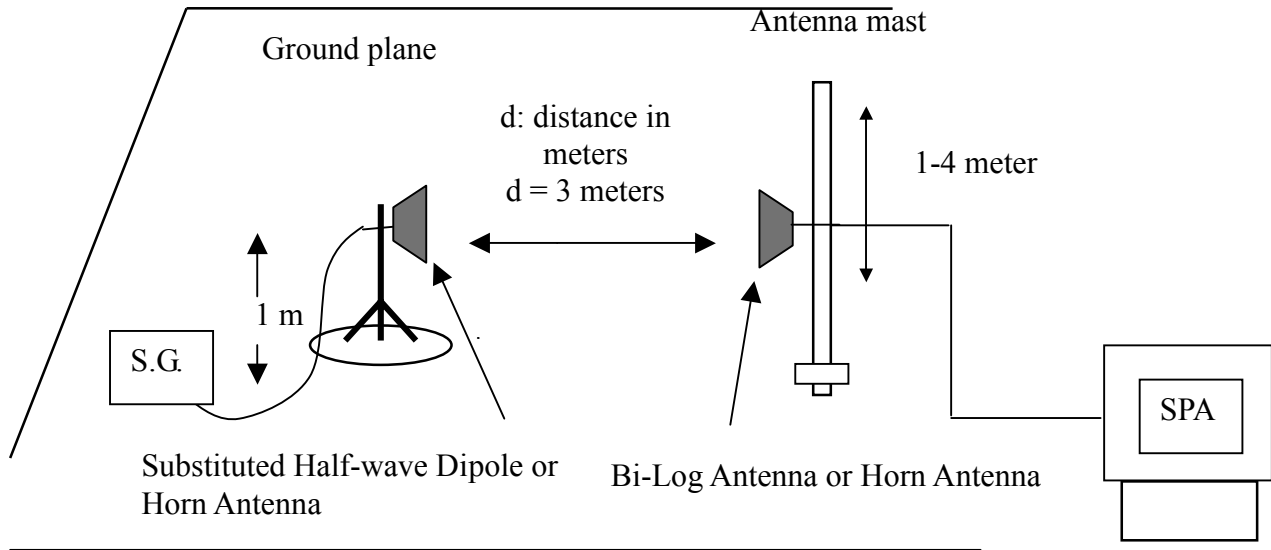

TEST PROCEDURE

The EUT was placed on a non-conductive, the measurement antenna was placed at a distance of 3 meters from the EUT. During the tests, the antenna height and the EUT azimuth were varied in order to identify the maximum level of emissions from the EUT. This maximization process was repeated with the EUT positioned in each of its three orthogonal orientations.

The frequency range up to tenth harmonic was investigated for each of three fundamental frequency (low, middle and high channels). Once spurious emission were identified, the power of the emission was determined using the substitution method.

The spurious emissions attenuation was calculated as the difference between radiated power at the fundamental frequency and the spurious emissions frequency.

$$ERP = \text{S.G. output (dBm)} + \text{Antenna Gain (dBd)} - \text{Cable (dB)}$$

$$EIRP = \text{S.G. output (dBm)} + \text{Antenna Gain (dBi)} - \text{Cable (dB)}$$

TEST RESULTS

Refer to the attached tabular data sheets.

**Radiated Spurious Emission Measurement Result / Below 1GHz****Operation Mode:** GSM 850 / TX / CH 128**Test Date:** March 16, 2008**Temperature:** 25°C**Tested by:** Ryan Chen**Humidity:** 55 % RH**Polarity:** Ver. / Hor.

Frequency (MHz)	Antenna Polarization (V/H)	Reading (dBm)	Correction Factor (dB)	Emission level (dBm)	Limit (dBm)	Margin (dB)
99.84	V	-46.27	-21.68	-67.95	-13.00	-54.95
136.70	V	-59.08	-19.65	-78.73	-13.00	-65.73
181.32	V	-61.11	-18.78	-79.89	-13.00	-66.89
399.57	V	-53.56	-12.55	-66.11	-13.00	-53.11
512.09	V	-63.97	-9.20	-73.16	-13.00	-60.16
682.81	V	-62.18	-6.60	-68.78	-13.00	-55.78
48.43	H	-61.57	-4.22	-65.79	-13.00	-52.79
99.84	H	-44.61	-22.39	-67.00	-13.00	-54.00
199.75	H	-57.76	-16.31	-74.08	-13.00	-61.08
250.19	H	-59.61	-15.19	-74.80	-13.00	-61.80
399.57	H	-52.14	-12.07	-64.21	-13.00	-51.21
512.09	H	-60.07	-9.33	-69.40	-13.00	-56.40

Remark:

1. *The emission behaviour belongs to narrowband spurious emission.*
2. *Measurements above show only up to 6 maximum emissions noted, or would be lesser; with " N/A " remark, if no specific emissions from the EUT are recorded (ie: margin > 20dB from the applicable limit) and considered that's already beyond the background noise floor.*



Operation Mode: GSM 850 / TX / CH 190

Test Date: March 16, 2008

Temperature: 25°C

Tested by: Ryan Chen

Humidity: 55 % RH

Polarity: Ver. / Hor.

Frequency (MHz)	Antenna Polarization (V/H)	Reading (dBm)	Correction Factor (dB)	Emission level (dBm)	Limit (dBm)	Margin (dB)
39.70	V	-62.47	-0.63	-63.10	-13.00	-50.10
130.88	V	-46.30	-20.49	-66.79	-13.00	-53.79
187.14	V	-61.32	-18.58	-79.90	-13.00	-66.90
374.35	V	-62.15	-12.94	-75.09	-13.00	-62.09
453.89	V	-59.97	-10.80	-70.77	-13.00	-57.77
522.76	V	-59.27	-8.88	-68.16	-13.00	-55.16
38.73	H	-62.80	-3.30	-66.11	-13.00	-53.11
130.88	H	-45.22	-21.60	-66.82	-13.00	-53.82
155.13	H	-57.57	-18.14	-75.71	-13.00	-62.71
453.89	H	-54.98	-11.11	-66.09	-13.00	-53.09
523.73	H	-57.21	-8.76	-65.98	-13.00	-52.98
825.40	H	-43.09	-4.98	-48.07	-13.00	-35.07

Remark:

1. The emission behaviour belongs to narrowband spurious emission.
2. Measurements above show only up to 6 maximum emissions noted, or would be lesser, with " N/A " remark, if no specific emissions from the EUT are recorded (ie: margin > 20dB from the applicable limit) and considered that's already beyond the background noise floor.



Operation Mode: GSM 850 / TX / CH 251

Test Date: March 16, 2008

Temperature: 25°C

Tested by: Ryan Chen

Humidity: 55 % RH

Polarity: Ver. / Hor.

Frequency (MHz)	Antenna Polarization (V/H)	Reading (dBm)	Correction Factor (dB)	Emission level (dBm)	Limit (dBm)	Margin (dB)
34.85	V	-61.50	-0.96	-62.47	-13.00	-49.47
113.42	V	-60.04	-21.05	-81.09	-13.00	-68.09
149.31	V	-64.13	-16.20	-80.33	-13.00	-67.33
181.32	V	-59.96	-18.78	-78.74	-13.00	-65.74
235.64	V	-63.68	-16.14	-79.82	-13.00	-66.82
838.01	V	-51.38	-4.59	-55.97	-13.00	-42.97
37.76	H	-62.56	-3.55	-66.11	-13.00	-53.11
89.17	H	-56.59	-22.11	-78.70	-13.00	-65.70
136.70	H	-57.99	-20.62	-78.61	-13.00	-65.61
181.32	H	-57.92	-18.11	-76.03	-13.00	-63.03
374.35	H	-62.71	-12.37	-75.08	-13.00	-62.08
838.01	H	-45.50	-4.53	-50.03	-13.00	-37.03

Remark:

1. The emission behaviour belongs to narrowband spurious emission.
2. Measurements above show only up to 6 maximum emissions noted, or would be lesser, with " N/A " remark, if no specific emissions from the EUT are recorded (ie: margin > 20dB from the applicable limit) and considered that's already beyond the background noise floor.



Operation Mode: GPRS 850 / TX / CH 128

Test Date: March 16, 2008

Temperature: 25°C

Tested by: Ryan Chen

Humidity: 55 % RH

Polarity: Ver. / Hor.

Frequency (MHz)	Antenna Polarization (V/H)	Reading (dBm)	Correction Factor (dB)	Emission level (dBm)	Limit (dBm)	Margin (dB)
99.84	V	-45.17	-21.68	-66.84	-13.00	-53.84
132.82	V	-55.64	-20.21	-75.85	-13.00	-62.85
185.20	V	-59.23	-18.65	-77.88	-13.00	-64.88
398.60	V	-51.61	-12.57	-64.18	-13.00	-51.18
408.30	V	-56.17	-12.32	-68.49	-13.00	-55.49
512.09	V	-59.44	-9.20	-68.63	-13.00	-55.63
38.73	H	-61.14	-3.30	-64.45	-13.00	-51.45
99.84	H	-44.50	-22.39	-66.89	-13.00	-53.89
192.96	H	-53.92	-17.00	-70.93	-13.00	-57.93
399.57	H	-51.66	-12.07	-63.73	-13.00	-50.73
408.30	H	-52.59	-11.88	-64.47	-13.00	-51.47
512.09	H	-60.63	-9.33	-69.96	-13.00	-56.96

Remark:

1. The emission behaviour belongs to narrowband spurious emission.
2. Measurements above show only up to 6 maximum emissions noted, or would be lesser, with " N/A " remark, if no specific emissions from the EUT are recorded (ie: margin > 20dB from the applicable limit) and considered that's already beyond the background noise floor.



Operation Mode: GPRS 850 / TX / CH 190

Test Date: March 16, 2008

Temperature: 25°C

Tested by: Ryan Chen

Humidity: 55 % RH

Polarity: Ver. / Hor.

Frequency (MHz)	Antenna Polarization (V/H)	Reading (dBm)	Correction Factor (dB)	Emission level (dBm)	Limit (dBm)	Margin (dB)
34.85	V	-60.70	-0.96	-61.66	-13.00	-48.66
130.88	V	-45.44	-20.49	-65.93	-13.00	-52.93
184.23	V	-59.36	-18.68	-78.04	-13.00	-65.04
453.89	V	-58.89	-10.80	-69.69	-13.00	-56.69
523.73	V	-59.74	-8.84	-68.58	-13.00	-55.58
548.95	V	-64.75	-8.21	-72.96	-13.00	-59.96
39.70	H	-63.49	-3.06	-66.55	-13.00	-53.55
130.88	H	-45.01	-21.60	-66.62	-13.00	-53.62
189.08	H	-55.94	-17.39	-73.33	-13.00	-60.33
453.89	H	-56.61	-11.11	-67.72	-13.00	-54.72
522.76	H	-57.09	-8.82	-65.92	-13.00	-52.92
544.10	H	-59.91	-7.68	-67.59	-13.00	-54.59

Remark:

1. The emission behaviour belongs to narrowband spurious emission.
2. Measurements above show only up to 6 maximum emissions noted, or would be lesser, with " N/A " remark, if no specific emissions from the EUT are recorded (ie: margin > 20dB from the applicable limit) and considered that's already beyond the background noise floor.



Operation Mode: GPRS 850 / TX / CH 251

Test Date: March 16, 2008

Temperature: 25°C

Tested by: Ryan Chen

Humidity: 55 % RH

Polarity: Ver. / Hor.

Frequency (MHz)	Antenna Polarization (V/H)	Reading (dBm)	Correction Factor (dB)	Emission level (dBm)	Limit (dBm)	Margin (dB)
35.82	V	-62.55	-0.74	-63.29	-13.00	-50.29
113.42	V	-55.69	-21.05	-76.75	-13.00	-63.75
136.70	V	-60.09	-19.65	-79.74	-13.00	-66.74
181.32	V	-59.21	-18.78	-77.99	-13.00	-64.99
626.55	V	-66.55	-7.15	-73.70	-13.00	-60.70
838.01	V	-51.15	-4.59	-55.74	-13.00	-42.74
37.76	H	-61.33	-3.55	-64.88	-13.00	-51.88
110.51	H	-56.68	-21.43	-78.11	-13.00	-65.11
155.13	H	-56.96	-18.14	-75.10	-13.00	-62.10
192.96	H	-56.10	-17.00	-73.10	-13.00	-60.10
321.97	H	-64.29	-14.34	-78.63	-13.00	-65.63
355.92	H	-64.46	-13.47	-77.93	-13.00	-64.93

Remark:

1. The emission behaviour belongs to narrowband spurious emission.
2. Measurements above show only up to 6 maximum emissions noted, or would be lesser, with " N/A " remark, if no specific emissions from the EUT are recorded (ie: margin > 20dB from the applicable limit) and considered that's already beyond the background noise floor.



Operation Mode: GSM 1900 / TX / CH 512

Test Date: March 16, 2008

Temperature: 25°C

Tested by: Ryan Chen

Humidity: 55 % RH

Polarity: Ver. / Hor.

Frequency (MHz)	Antenna Polarization (V/H)	Reading (dBm)	Correction Factor (dB)	Emission level (dBm)	Limit (dBm)	Margin (dB)
47.46	V	-47.06	-4.58	-51.64	-13.00	-38.64
84.32	V	-46.22	-19.76	-65.98	-13.00	-52.98
113.42	V	-40.89	-21.05	-61.94	-13.00	-48.94
189.08	V	-44.34	-18.52	-62.86	-13.00	-49.86
242.43	V	-47.37	-15.79	-63.15	-13.00	-50.15
348.16	V	-55.26	-13.21	-68.47	-13.00	-55.47
40.67	H	-52.55	-3.21	-55.76	-13.00	-42.76
113.42	H	-46.03	-21.53	-67.57	-13.00	-54.57
153.19	H	-55.27	-17.35	-72.62	-13.00	-59.62
189.08	H	-44.01	-17.39	-61.40	-13.00	-48.40
204.60	H	-47.56	-15.67	-63.23	-13.00	-50.23
255.04	H	-51.32	-15.60	-66.92	-13.00	-53.92

Remark:

1. *Measuring frequencies from 1 GHz to the 10th harmonic of highest fundamental frequency.*
2. *Measurements above show only up to 6 maximum emissions noted, or would be lesser, with " N/A " remark, if no specific emissions from the EUT are recorded (ie: margin > 20dB from the applicable limit) and considered that's already beyond the background noise floor.*



Operation Mode: GSM 1900 / TX / CH 661

Test Date: March 16, 2008

Temperature: 25°C

Tested by: Ryan Chen

Humidity: 55 % RH

Polarity: Ver. / Hor.

Frequency (MHz)	Antenna Polarization (V/H)	Reading (dBm)	Correction Factor (dB)	Emission level (dBm)	Limit (dBm)	Margin (dB)
37.76	V	-52.18	-0.68	-52.86	-13.00	-39.86
51.34	V	-48.00	-5.59	-53.60	-13.00	-40.60
100.81	V	-44.38	-21.63	-66.01	-13.00	-53.01
189.08	V	-48.14	-18.52	-66.65	-13.00	-53.65
234.67	V	-50.75	-16.21	-66.96	-13.00	-53.96
257.95	V	-53.40	-15.73	-69.13	-13.00	-56.13
40.67	H	-50.69	-3.21	-53.89	-13.00	-40.89
65.89	H	-50.97	-11.85	-62.81	-13.00	-49.81
116.33	H	-49.56	-21.63	-71.20	-13.00	-58.20
155.13	H	-52.13	-18.14	-70.27	-13.00	-57.27
195.87	H	-49.77	-16.71	-66.48	-13.00	-53.48
234.67	H	-51.19	-15.39	-66.58	-13.00	-53.58

Remark:

1. *Measuring frequencies from 1 GHz to the 10th harmonic of highest fundamental frequency.*
2. *Measurements above show only up to 6 maximum emissions noted, or would be lesser, with " N/A " remark, if no specific emissions from the EUT are recorded (ie: margin > 20dB from the applicable limit) and considered that's already beyond the background noise floor.*



Operation Mode: GSM 1900 / TX / CH 810

Test Date: March 16, 2008

Temperature: 25°C

Tested by: Ryan Chen

Humidity: 55 % RH

Polarity: Ver. / Hor.

Frequency (MHz)	Antenna Polarization (V/H)	Reading (dBm)	Correction Factor (dB)	Emission level (dBm)	Limit (dBm)	Margin (dB)
48.43	V	-47.55	-4.80	-52.36	-13.00	-39.36
61.04	V	-46.16	-8.72	-54.88	-13.00	-41.88
110.51	V	-41.37	-21.03	-62.40	-13.00	-49.40
186.17	V	-44.77	-18.62	-63.38	-13.00	-50.38
207.51	V	-46.82	-16.96	-63.78	-13.00	-50.78
242.43	V	-48.38	-15.79	-64.16	-13.00	-51.16
35.82	H	-52.51	-4.05	-56.56	-13.00	-43.56
113.42	H	-43.29	-21.53	-64.82	-13.00	-51.82
185.20	H	-45.99	-17.75	-63.74	-13.00	-50.74
241.46	H	-46.39	-15.29	-61.68	-13.00	-48.68
341.37	H	-55.52	-14.06	-69.57	-13.00	-56.57
544.10	H	-57.72	-7.68	-65.40	-13.00	-52.40

Remark:

1. *Measuring frequencies from 1 GHz to the 10th harmonic of highest fundamental frequency.*
2. *Measurements above show only up to 6 maximum emissions noted, or would be lesser, with " N/A " remark, if no specific emissions from the EUT are recorded (ie: margin > 20dB from the applicable limit) and considered that's already beyond the background noise floor.*



Operation Mode: GPRS 1900 / TX / CH 512

Test Date: March 16, 2008

Temperature: 25°C

Tested by: Ryan Chen

Humidity: 55 % RH

Polarity: Ver. / Hor.

Frequency (MHz)	Antenna Polarization (V/H)	Reading (dBm)	Correction Factor (dB)	Emission level (dBm)	Limit (dBm)	Margin (dB)
50.37	V	-47.91	-5.28	-53.20	-13.00	-40.20
100.81	V	-44.53	-21.63	-66.15	-13.00	-53.15
113.42	V	-46.59	-21.05	-67.65	-13.00	-54.65
186.17	V	-48.35	-18.62	-66.96	-13.00	-53.96
253.10	V	-52.21	-15.61	-67.82	-13.00	-54.82
625.58	V	-57.60	-7.14	-64.74	-13.00	-51.74
38.73	H	-52.82	-3.30	-56.12	-13.00	-43.12
114.39	H	-43.28	-21.57	-64.84	-13.00	-51.84
190.05	H	-42.80	-17.30	-60.10	-13.00	-47.10
242.43	H	-46.73	-15.28	-62.01	-13.00	-49.01
267.65	H	-52.11	-15.60	-67.71	-13.00	-54.71
321.97	H	-55.38	-14.34	-69.73	-13.00	-56.73

Remark:

1. *Measuring frequencies from 1 GHz to the 10th harmonic of highest fundamental frequency.*
2. *Measurements above show only up to 6 maximum emissions noted, or would be lesser, with " N/A " remark, if no specific emissions from the EUT are recorded (ie: margin > 20dB from the applicable limit) and considered that's already beyond the background noise floor.*



Operation Mode: GPRS 1900 / TX / CH 661

Test Date: March 16, 2008

Temperature: 25°C

Tested by: Ryan Chen

Humidity: 55 % RH

Polarity: Ver. / Hor.

Frequency (MHz)	Antenna Polarization (V/H)	Reading (dBm)	Correction Factor (dB)	Emission level (dBm)	Limit (dBm)	Margin (dB)
40.67	V	-46.88	-1.07	-47.95	-13.00	-34.95
96.93	V	-44.77	-21.69	-66.46	-13.00	-53.46
111.48	V	-47.23	-21.04	-68.27	-13.00	-55.27
185.20	V	-48.44	-18.65	-67.08	-13.00	-54.08
238.55	V	-49.57	-15.96	-65.53	-13.00	-52.53
381.14	V	-56.28	-12.84	-69.12	-13.00	-56.12
40.67	H	-51.09	-3.21	-54.29	-13.00	-41.29
112.45	H	-41.78	-21.50	-63.28	-13.00	-50.28
190.05	H	-43.28	-17.30	-60.58	-13.00	-47.58
231.76	H	-46.63	-15.44	-62.07	-13.00	-49.07
252.13	H	-48.47	-15.36	-63.82	-13.00	-50.82
321.97	H	-55.70	-14.34	-70.04	-13.00	-57.04

Remark:

1. *Measuring frequencies from 1 GHz to the 10th harmonic of highest fundamental frequency.*
2. *Measurements above show only up to 6 maximum emissions noted, or would be lesser, with " N/A " remark, if no specific emissions from the EUT are recorded (ie: margin > 20dB from the applicable limit) and considered that's already beyond the background noise floor.*



Operation Mode: GPRS 1900 / TX / CH 810

Test Date: March 16, 2008

Temperature: 25°C

Tested by: Ryan Chen

Humidity: 55 % RH

Polarity: Ver. / Hor.

Frequency (MHz)	Antenna Polarization (V/H)	Reading (dBm)	Correction Factor (dB)	Emission level (dBm)	Limit (dBm)	Margin (dB)
48.43	V	-47.41	-4.80	-52.21	-13.00	-39.21
61.04	V	-45.12	-8.72	-53.84	-13.00	-40.84
111.48	V	-43.13	-21.04	-64.17	-13.00	-51.17
186.17	V	-45.48	-18.62	-64.10	-13.00	-51.10
241.46	V	-50.12	-15.82	-65.94	-13.00	-52.94
267.65	V	-53.75	-15.45	-69.20	-13.00	-56.20
40.67	H	-53.09	-3.21	-56.30	-13.00	-43.30
64.92	H	-50.10	-11.27	-61.37	-13.00	-48.37
111.48	H	-44.17	-21.46	-65.63	-13.00	-52.63
155.13	H	-54.32	-18.14	-72.46	-13.00	-59.46
189.08	H	-43.27	-17.39	-60.67	-13.00	-47.67
208.48	H	-48.06	-15.16	-63.21	-13.00	-50.21

Remark:

1. *Measuring frequencies from 1 GHz to the 10th harmonic of highest fundamental frequency.*
2. *Measurements above show only up to 6 maximum emissions noted, or would be lesser, with " N/A " remark, if no specific emissions from the EUT are recorded (ie: margin>20dB from the applicable limit) and considered that's already beyond the background noise floor.*



Operation Mode: EDGE 850 / TX / CH 128

Test Date: March 16, 2008

Temperature: 25°C

Tested by: Mimic Yang

Humidity: 50 % RH

Polarity: Ver. / Hor.

Frequency (MHz)	Antenna Polarization (V/H)	Reading (dBm)	Correction Factor (dB)	Emission level (dBm)	Limit (dBm)	Margin (dB)
36.79	V	-61.48	-0.71	-62.19	-13.00	-49.19
99.84	V	-45.57	-21.68	-67.25	-13.00	-54.25
181.32	V	-54.34	-18.78	-73.12	-13.00	-60.12
399.57	V	-52.50	-12.55	-65.05	-13.00	-52.05
681.84	V	-59.61	-6.63	-66.24	-13.00	-53.24
813.76	V	-42.90	-4.86	-47.76	-13.00	-34.76
38.73	H	-62.66	-3.30	-65.97	-13.00	-52.97
99.84	H	-44.11	-22.39	-66.50	-13.00	-53.50
181.32	H	-52.07	-18.11	-70.18	-13.00	-57.18
399.57	H	-50.81	-12.07	-62.88	-13.00	-49.88
681.84	H	-57.64	-6.44	-64.08	-13.00	-51.08
813.76	H	-42.64	-5.20	-47.84	-13.00	-34.84

Remark:

1. *Measuring frequencies from 1 GHz to the 10th harmonic of highest fundamental frequency.*
2. *Measurements above show only up to 6 maximum emissions noted, or would be lesser, with " N/A " remark, if no specific emissions from the EUT are recorded (ie: margin>20dB from the applicable limit) and considered that's already beyond the background noise floor.*



Operation Mode: EDGE 850 / TX / CH 190

Test Date: March 16, 2008

Temperature: 25°C

Tested by: Mimic Yang

Humidity: 50 % RH

Polarity: Ver. / Hor.

Frequency (MHz)	Antenna Polarization (V/H)	Reading (dBm)	Correction Factor (dB)	Emission level (dBm)	Limit (dBm)	Margin (dB)
37.76	V	-62.28	-0.68	-62.97	-13.00	-49.97
119.24	V	-55.13	-21.10	-76.23	-13.00	-63.23
130.88	V	-52.36	-20.49	-72.85	-13.00	-59.85
181.32	V	-55.20	-18.78	-73.98	-13.00	-60.98
374.35	V	-63.35	-12.94	-76.29	-13.00	-63.29
826.37	V	-44.73	-4.76	-49.49	-13.00	-36.49
38.73	H	-61.93	-3.30	-65.24	-13.00	-52.24
130.88	H	-44.17	-21.60	-65.77	-13.00	-52.77
181.32	H	-49.86	-18.11	-67.97	-13.00	-54.97
453.89	H	-57.05	-11.11	-68.16	-13.00	-55.16
523.73	H	-54.51	-8.76	-63.27	-13.00	-50.27
825.40	H	-42.90	-4.98	-47.88	-13.00	-34.88

Remark:

1. Measuring frequencies from 1 GHz to the 10th harmonic of highest fundamental frequency.
2. Measurements above show only up to 6 maximum emissions noted, or would be lesser; with " N/A " remark, if no specific emissions from the EUT are recorded (ie: margin > 20dB from the applicable limit) and considered that's already beyond the background noise floor.



Operation Mode: EDGE 850 / TX / CH 251

Test Date: March 16, 2008

Temperature: 25°C

Tested by: Mimic Yang

Humidity: 50 % RH

Polarity: Ver. / Hor.

Frequency (MHz)	Antenna Polarization (V/H)	Reading (dBm)	Correction Factor (dB)	Emission level (dBm)	Limit (dBm)	Margin (dB)
36.79	V	-61.78	-0.71	-62.49	-13.00	-49.49
82.38	V	-56.64	-19.09	-75.73	-13.00	-62.73
138.64	V	-54.52	-19.37	-73.88	-13.00	-60.88
181.32	V	-52.77	-18.78	-71.55	-13.00	-58.55
321.97	V	-63.50	-13.35	-76.85	-13.00	-63.85
838.01	V	-54.00	-4.59	-58.59	-13.00	-45.59
37.76	H	-61.62	-3.55	-65.17	-13.00	-52.17
90.14	H	-53.93	-22.27	-76.19	-13.00	-63.19
181.32	H	-49.73	-18.11	-67.85	-13.00	-54.85
374.35	H	-62.41	-12.37	-74.78	-13.00	-61.78
686.69	H	-63.85	-6.32	-70.18	-13.00	-57.18
838.01	H	-47.38	-4.53	-51.90	-13.00	-38.90

Remark:

1. Measuring frequencies from 1 GHz to the 10th harmonic of highest fundamental frequency.
2. Measurements above show only up to 6 maximum emissions noted, or would be lesser; with " N/A " remark, if no specific emissions from the EUT are recorded (ie: margin > 20dB from the applicable limit) and considered that's already beyond the background noise floor.



Operation Mode: EDGE 1900 / TX / CH 512

Test Date: March 16, 2008

Temperature: 25°C

Tested by: Mimic Yang

Humidity: 50 % RH

Polarity: Ver. / Hor.

Frequency (MHz)	Antenna Polarization (V/H)	Reading (dBm)	Correction Factor (dB)	Emission level (dBm)	Limit (dBm)	Margin (dB)
36.79	V	-51.88	-0.71	-52.59	-13.00	-39.59
56.19	V	-49.15	-7.14	-56.29	-13.00	-43.29
101.78	V	-40.28	-21.56	-61.84	-13.00	-48.84
170.65	V	-42.73	-19.01	-61.75	-13.00	-48.75
238.55	V	-48.09	-15.96	-64.05	-13.00	-51.05
327.79	V	-52.62	-13.32	-65.94	-13.00	-52.94
37.76	H	-52.09	-3.55	-55.65	-13.00	-42.65
96.93	H	-39.45	-22.36	-61.81	-13.00	-48.81
116.33	H	-46.53	-21.63	-68.17	-13.00	-55.17
185.20	H	-48.16	-17.75	-65.91	-13.00	-52.91
244.37	H	-50.57	-15.25	-65.82	-13.00	-52.82
387.93	H	-46.57	-12.03	-58.60	-13.00	-45.60

Remark:

1. Measuring frequencies from 1 GHz to the 10th harmonic of highest fundamental frequency.
2. Measurements above show only up to 6 maximum emissions noted, or would be lesser; with " N/A " remark, if no specific emissions from the EUT are recorded (ie: margin > 20dB from the applicable limit) and considered that's already beyond the background noise floor.



Operation Mode: EDGE 1900 / TX / CH 661

Test Date: March 16, 2008

Temperature: 25°C

Tested by: Mimic Yang

Humidity: 50 % RH

Polarity: Ver. / Hor.

Frequency (MHz)	Antenna Polarization (V/H)	Reading (dBm)	Correction Factor (dB)	Emission level (dBm)	Limit (dBm)	Margin (dB)
34.85	V	-51.76	-0.96	-52.73	-13.00	-39.73
123.12	V	-41.82	-20.95	-62.77	-13.00	-49.77
164.83	V	-41.59	-19.50	-61.09	-13.00	-48.09
224.97	V	-50.53	-16.53	-67.06	-13.00	-54.06
327.79	V	-53.58	-13.32	-66.90	-13.00	-53.90
377.26	V	-50.58	-12.90	-63.48	-13.00	-50.48
39.70	H	-52.78	-3.06	-55.84	-13.00	-42.84
98.87	H	-40.80	-22.38	-63.18	-13.00	-50.18
186.17	H	-48.23	-17.66	-65.89	-13.00	-52.89
245.34	H	-51.26	-15.24	-66.50	-13.00	-53.50
378.23	H	-55.08	-12.12	-67.20	-13.00	-54.20
709.97	H	-57.29	-6.08	-63.37	-13.00	-50.37

Remark:

1. Measuring frequencies from 1 GHz to the 10th harmonic of highest fundamental frequency.
2. Measurements above show only up to 6 maximum emissions noted, or would be lesser; with " N/A " remark, if no specific emissions from the EUT are recorded (ie: margin > 20dB from the applicable limit) and considered that's already beyond the background noise floor.



Operation Mode: EDGE 1900 / TX / CH 810

Test Date: March 16, 2008

Temperature: 25°C

Tested by: Mimic Yang

Humidity: 50 % RH

Polarity: Ver. / Hor.

Frequency (MHz)	Antenna Polarization (V/H)	Reading (dBm)	Correction Factor (dB)	Emission level (dBm)	Limit (dBm)	Margin (dB)
37.76	V	-52.87	-0.68	-53.55	-13.00	-40.55
95.96	V	-42.27	-21.70	-63.97	-13.00	-50.97
170.65	V	-42.66	-19.01	-61.68	-13.00	-48.68
239.52	V	-50.05	-15.90	-65.95	-13.00	-52.95
327.79	V	-53.15	-13.32	-66.48	-13.00	-53.48
394.72	V	-49.84	-12.63	-62.47	-13.00	-49.47
38.73	H	-52.52	-3.30	-55.83	-13.00	-42.83
59.10	H	-49.01	-7.94	-56.95	-13.00	-43.95
96.93	H	-39.08	-22.36	-61.44	-13.00	-48.44
140.58	H	-41.95	-19.83	-61.78	-13.00	-48.78
232.73	H	-50.55	-15.42	-65.98	-13.00	-52.98
408.30	H	-52.48	-11.88	-64.36	-13.00	-51.36

Remark:

1. Measuring frequencies from 1 GHz to the 10th harmonic of highest fundamental frequency.
2. Measurements above show only up to 6 maximum emissions noted, or would be lesser; with " N/A " remark, if no specific emissions from the EUT are recorded (ie: margin > 20dB from the applicable limit) and considered that's already beyond the background noise floor.



Operation Mode: WCDMA Band II / TX / CH 9262

Test Date: March 19, 2008

Temperature: 25°C

Tested by: Ryan Chen

Humidity: 50 % RH

Polarity: Ver. / Hor.

Frequency (MHz)	Antenna Polarization (V/H)	Reading (dBm)	Correction Factor (dB)	Emission level (dBm)	Limit (dBm)	Margin (dB)
34.85	V	-61.67	-0.96	-62.63	-13.00	-49.63
113.42	V	-59.70	-21.05	-80.76	-13.00	-67.76
151.25	V	-65.03	-16.47	-81.51	-13.00	-68.51
181.32	V	-59.01	-18.78	-77.79	-13.00	-64.79
236.61	V	-57.98	-16.08	-74.06	-13.00	-61.06
355.92	V	-65.19	-13.16	-78.35	-13.00	-65.35
37.76	H	-62.36	-3.55	-65.91	-13.00	-52.91
89.17	H	-56.77	-22.11	-78.88	-13.00	-65.88
113.42	H	-57.74	-21.53	-79.27	-13.00	-66.27
155.13	H	-57.67	-18.14	-75.81	-13.00	-62.81
185.20	H	-57.87	-17.75	-75.63	-13.00	-62.63
624.61	H	-62.20	-7.55	-69.75	-13.00	-56.75

Remark:

1. Measuring frequencies from 1 GHz to the 10th harmonic of highest fundamental frequency.
2. Measurements above show only up to 6 maximum emissions noted, or would be lesser; with " N/A " remark, if no specific emissions from the EUT are recorded (ie: margin > 20dB from the applicable limit) and considered that's already beyond the background noise floor.



Operation Mode: WCDMA Band II / TX / CH 9400

Test Date: March 19, 2008

Temperature: 25°C

Tested by: Ryan Chen

Humidity: 50 % RH

Polarity: Ver. / Hor.

Frequency (MHz)	Antenna Polarization (V/H)	Reading (dBm)	Correction Factor (dB)	Emission level (dBm)	Limit (dBm)	Margin (dB)
40.67	V	-62.39	-1.07	-63.47	-13.00	-50.47
113.42	V	-58.84	-21.05	-79.90	-13.00	-66.90
136.70	V	-61.28	-19.65	-80.93	-13.00	-67.93
181.32	V	-59.02	-18.78	-77.80	-13.00	-64.80
234.67	V	-64.67	-16.21	-80.88	-13.00	-67.88
355.92	V	-63.55	-13.16	-76.70	-13.00	-63.70
39.70	H	-62.79	-3.06	-65.85	-13.00	-52.85
90.14	H	-56.64	-22.27	-78.91	-13.00	-65.91
114.39	H	-43.53	-21.57	-65.09	-13.00	-52.09
155.13	H	-60.25	-18.14	-78.39	-13.00	-65.39
185.20	H	-58.32	-17.75	-76.07	-13.00	-63.07
374.35	H	-58.04	-12.37	-70.40	-13.00	-57.40

Remark:

1. Measuring frequencies from 1 GHz to the 10th harmonic of highest fundamental frequency.
2. Measurements above show only up to 6 maximum emissions noted, or would be lesser; with " N/A " remark, if no specific emissions from the EUT are recorded (ie: margin > 20dB from the applicable limit) and considered that's already beyond the background noise floor.



Operation Mode: WCDMA Band II / TX / CH 9538

Test Date: March 19, 2008

Temperature: 25°C

Tested by: Ryan Chen

Humidity: 50 % RH

Polarity: Ver. / Hor.

Frequency (MHz)	Antenna Polarization (V/H)	Reading (dBm)	Correction Factor (dB)	Emission level (dBm)	Limit (dBm)	Margin (dB)
39.70	V	-62.54	-0.63	-63.17	-13.00	-50.17
113.42	V	-59.58	-21.05	-80.63	-13.00	-67.63
136.70	V	-60.37	-19.65	-80.02	-13.00	-67.02
181.32	V	-60.26	-18.78	-79.04	-13.00	-66.04
374.35	V	-62.89	-12.94	-75.82	-13.00	-62.82
543.13	V	-66.97	-8.17	-75.13	-13.00	-62.13
36.79	H	-61.58	-3.80	-65.37	-13.00	-52.37
90.14	H	-56.40	-22.27	-78.66	-13.00	-65.66
113.42	H	-58.14	-21.53	-79.67	-13.00	-66.67
155.13	H	-58.99	-18.14	-77.13	-13.00	-64.13
181.32	H	-56.60	-18.11	-74.71	-13.00	-61.71
407.33	H	-63.36	-11.90	-75.26	-13.00	-62.26

Remark:

1. Measuring frequencies from 1 GHz to the 10th harmonic of highest fundamental frequency.
2. Measurements above show only up to 6 maximum emissions noted, or would be lesser; with " N/A " remark, if no specific emissions from the EUT are recorded (ie: margin > 20dB from the applicable limit) and considered that's already beyond the background noise floor.



Operation Mode: WCDMA Band V / TX / CH 4132

Test Date: March 19, 2008

Temperature: 25°C

Tested by: Ryan Chen

Humidity: 50 % RH

Polarity: Ver. / Hor.

Frequency (MHz)	Antenna Polarization (V/H)	Reading (dBm)	Correction Factor (dB)	Emission level (dBm)	Limit (dBm)	Margin (dB)
38.73	V	-61.21	-0.66	-61.87	-13.00	-48.87
65.89	V	-59.01	-10.39	-69.40	-13.00	-56.40
115.36	V	-56.22	-21.07	-77.29	-13.00	-64.29
136.70	V	-60.59	-19.65	-80.24	-13.00	-67.24
181.32	V	-56.94	-18.78	-75.72	-13.00	-62.72
355.92	V	-64.95	-13.16	-78.11	-13.00	-65.11
37.76	H	-62.23	-3.55	-65.78	-13.00	-52.78
102.75	H	-53.26	-22.12	-75.38	-13.00	-62.38
155.13	H	-61.05	-18.14	-79.19	-13.00	-66.19
185.20	H	-57.95	-17.75	-75.70	-13.00	-62.70
230.79	H	-63.59	-15.45	-79.04	-13.00	-66.04
411.21	H	-62.47	-11.81	-74.28	-13.00	-61.28

Remark:

1. Measuring frequencies from 1 GHz to the 10th harmonic of highest fundamental frequency.
2. Measurements above show only up to 6 maximum emissions noted, or would be lesser; with " N/A " remark, if no specific emissions from the EUT are recorded (ie: margin > 20dB from the applicable limit) and considered that's already beyond the background noise floor.

**Operation Mode:** WCDMA Band V / TX / CH 4183**Test Date:** March 19, 2008**Temperature:** 25°C**Tested by:** Ryan Chen**Humidity:** 50 % RH**Polarity:** Ver. / Hor.

Frequency (MHz)	Antenna Polarization (V/H)	Reading (dBm)	Correction Factor (dB)	Emission level (dBm)	Limit (dBm)	Margin (dB)
36.79	V	-61.96	-0.71	-62.67	-13.00	-49.67
113.42	V	-55.61	-21.05	-76.66	-13.00	-63.66
132.82	V	-53.92	-20.21	-74.13	-13.00	-61.13
181.32	V	-57.62	-18.78	-76.40	-13.00	-63.40
213.33	V	-63.48	-16.65	-80.14	-13.00	-67.14
239.52	V	-64.16	-15.90	-80.05	-13.00	-67.05
39.70	H	-62.52	-3.06	-65.58	-13.00	-52.58
57.16	H	-56.72	-7.10	-63.82	-13.00	-50.82
109.54	H	-53.52	-21.46	-74.98	-13.00	-61.98
157.07	H	-58.45	-18.93	-77.38	-13.00	-64.38
187.14	H	-56.16	-17.57	-73.73	-13.00	-60.73
402.48	H	-62.49	-12.02	-74.51	-13.00	-61.51

Remark:

1. Measuring frequencies from 1 GHz to the 10th harmonic of highest fundamental frequency.
2. Measurements above show only up to 6 maximum emissions noted, or would be lesser; with " N/A " remark, if no specific emissions from the EUT are recorded (ie: margin > 20dB from the applicable limit) and considered that's already beyond the background noise floor.



Operation Mode: WCDMA Band V / TX / CH 4233

Test Date: March 19, 2008

Temperature: 25°C

Tested by: Ryan Chen

Humidity: 50 % RH

Polarity: Ver. / Hor.

Frequency (MHz)	Antenna Polarization (V/H)	Reading (dBm)	Correction Factor (dB)	Emission level (dBm)	Limit (dBm)	Margin (dB)
37.76	V	-62.09	-0.68	-62.78	-13.00	-49.78
87.23	V	-58.30	-20.77	-79.07	-13.00	-66.07
115.36	V	-54.23	-21.07	-75.30	-13.00	-62.30
147.37	V	-62.93	-16.82	-79.75	-13.00	-66.75
181.32	V	-57.07	-18.78	-75.85	-13.00	-62.85
321.97	V	-65.01	-13.35	-78.36	-13.00	-65.36
57.16	H	-56.97	-7.10	-64.07	-13.00	-51.07
65.89	H	-58.23	-11.85	-70.08	-13.00	-57.08
99.84	H	-51.23	-22.39	-73.62	-13.00	-60.62
120.21	H	-55.35	-21.76	-77.11	-13.00	-64.11
185.20	H	-53.75	-17.75	-71.50	-13.00	-58.50
374.35	H	-57.54	-12.37	-69.91	-13.00	-56.91

Remark:

1. Measuring frequencies from 1 GHz to the 10th harmonic of highest fundamental frequency.
2. Measurements above show only up to 6 maximum emissions noted, or would be lesser; with " N/A " remark, if no specific emissions from the EUT are recorded (ie: margin > 20dB from the applicable limit) and considered that's already beyond the background noise floor.



Operation Mode: WCDMA / HSDPA Band II / TX / CH 9262

Test Date: March 19, 2008

Temperature: 25°C

Tested by: Ryan Chen

Humidity: 50 % RH

Polarity: Ver. / Hor.

Frequency (MHz)	Antenna Polarization (V/H)	Reading (dBm)	Correction Factor (dB)	Emission level (dBm)	Limit (dBm)	Margin (dB)
35.82	V	-61.46	-0.74	-62.20	-13.00	-49.20
113.42	V	-59.38	-21.05	-80.43	-13.00	-67.43
153.19	V	-64.36	-17.24	-81.60	-13.00	-68.60
181.32	V	-59.86	-18.78	-78.64	-13.00	-65.64
233.70	V	-63.83	-16.27	-80.09	-13.00	-67.09
321.97	V	-65.24	-13.35	-78.59	-13.00	-65.59
38.73	H	-61.62	-3.30	-64.92	-13.00	-51.92
113.42	H	-57.01	-21.53	-78.54	-13.00	-65.54
155.13	H	-60.71	-18.14	-78.85	-13.00	-65.85
181.32	H	-58.64	-18.11	-76.75	-13.00	-63.75
321.97	H	-64.28	-14.34	-78.62	-13.00	-65.62
374.35	H	-60.58	-12.37	-72.94	-13.00	-59.94

Remark:

1. Measuring frequencies from 1 GHz to the 10th harmonic of highest fundamental frequency.
2. Measurements above show only up to 6 maximum emissions noted, or would be lesser, with " N/A " remark, if no specific emissions from the EUT are recorded (ie: margin > 20dB from the applicable limit) and considered that's already beyond the background noise floor.



Operation Mode: WCDMA / HSDPA Band II / TX / CH 9400

Test Date: March 19, 2008

Temperature: 25°C

Tested by: Ryan Chen

Humidity: 50 % RH

Polarity: Ver. / Hor.

Frequency (MHz)	Antenna Polarization (V/H)	Reading (dBm)	Correction Factor (dB)	Emission level (dBm)	Limit (dBm)	Margin (dB)
34.85	V	-62.07	-0.96	-63.03	-13.00	-50.03
113.42	V	-59.28	-21.05	-80.34	-13.00	-67.34
150.28	V	-65.14	-16.09	-81.23	-13.00	-68.23
181.32	V	-59.14	-18.78	-77.92	-13.00	-64.92
238.55	V	-64.41	-15.96	-80.37	-13.00	-67.37
359.80	V	-64.49	-13.13	-77.62	-13.00	-64.62
37.76	H	-62.69	-3.55	-66.24	-13.00	-53.24
113.42	H	-56.76	-21.53	-78.29	-13.00	-65.29
155.13	H	-60.77	-18.14	-78.91	-13.00	-65.91
181.32	H	-58.19	-18.11	-76.31	-13.00	-63.31
394.72	H	-64.49	-12.05	-76.54	-13.00	-63.54
563.50	H	-66.44	-7.57	-74.02	-13.00	-61.02

Remark:

1. Measuring frequencies from 1 GHz to the 10th harmonic of highest fundamental frequency.
2. Measurements above show only up to 6 maximum emissions noted, or would be lesser, with " N/A " remark, if no specific emissions from the EUT are recorded (ie: margin > 20dB from the applicable limit) and considered that's already beyond the background noise floor.



Operation Mode: WCDMA / HSDPA Band II / TX / CH 9538

Test Date: March 19, 2008

Temperature: 25°C

Tested by: Ryan Chen

Humidity: 50 % RH

Polarity: Ver. / Hor.

Frequency (MHz)	Antenna Polarization (V/H)	Reading (dBm)	Correction Factor (dB)	Emission level (dBm)	Limit (dBm)	Margin (dB)
36.79	V	-61.90	-0.71	-62.61	-13.00	-49.61
113.42	V	-59.65	-21.05	-80.70	-13.00	-67.70
136.70	V	-61.76	-19.65	-81.41	-13.00	-68.41
181.32	V	-58.94	-18.78	-77.72	-13.00	-64.72
566.41	V	-66.60	-8.15	-74.75	-13.00	-61.75
614.91	V	-65.97	-7.21	-73.18	-13.00	-60.18
39.70	H	-62.22	-3.06	-65.28	-13.00	-52.28
90.14	H	-55.57	-22.27	-77.84	-13.00	-64.84
113.42	H	-56.68	-21.53	-78.21	-13.00	-65.21
155.13	H	-59.98	-18.14	-78.13	-13.00	-65.13
181.32	H	-56.95	-18.11	-75.07	-13.00	-62.07
374.35	H	-61.65	-12.37	-74.01	-13.00	-61.01

Remark:

1. Measuring frequencies from 1 GHz to the 10th harmonic of highest fundamental frequency.
2. Measurements above show only up to 6 maximum emissions noted, or would be lesser, with " N/A " remark, if no specific emissions from the EUT are recorded (ie: margin > 20dB from the applicable limit) and considered that's already beyond the background noise floor.



Operation Mode: WCDMA / HSDPA Band V / TX / CH 4132

Test Date: March 19, 2008

Temperature: 25°C

Tested by: Ryan Chen

Humidity: 50 % RH

Polarity: Ver. / Hor.

Frequency (MHz)	Antenna Polarization (V/H)	Reading (dBm)	Correction Factor (dB)	Emission level (dBm)	Limit (dBm)	Margin (dB)
36.79	V	-62.37	-0.71	-63.08	-13.00	-50.08
102.75	V	-57.62	-21.50	-79.12	-13.00	-66.12
155.13	V	-62.43	-18.01	-80.44	-13.00	-67.44
181.32	V	-61.77	-18.78	-80.55	-13.00	-67.55
221.09	V	-65.38	-16.55	-81.93	-13.00	-68.93
355.92	V	-65.67	-13.16	-78.82	-13.00	-65.82
36.79	H	-61.77	-3.80	-65.57	-13.00	-52.57
102.75	H	-54.72	-22.12	-76.84	-13.00	-63.84
136.70	H	-59.91	-20.62	-80.52	-13.00	-67.52
181.32	H	-60.04	-18.11	-78.15	-13.00	-65.15
374.35	H	-63.85	-12.37	-76.22	-13.00	-63.22
410.24	H	-64.11	-11.84	-75.95	-13.00	-62.95

Remark:

1. Measuring frequencies from 1 GHz to the 10th harmonic of highest fundamental frequency.
2. Measurements above show only up to 6 maximum emissions noted, or would be lesser, with " N/A " remark, if no specific emissions from the EUT are recorded (ie: margin > 20dB from the applicable limit) and considered that's already beyond the background noise floor.



Operation Mode: WCDMA / HSDPA Band V / TX / CH 4183

Test Date: March 19, 2008

Temperature: 25°C

Tested by: Ryan Chen

Humidity: 50 % RH

Polarity: Ver. / Hor.

Frequency (MHz)	Antenna Polarization (V/H)	Reading (dBm)	Correction Factor (dB)	Emission level (dBm)	Limit (dBm)	Margin (dB)
36.79	V	-61.88	-0.71	-62.59	-13.00	-49.59
113.42	V	-60.12	-21.05	-81.17	-13.00	-68.17
155.13	V	-64.58	-18.01	-82.58	-13.00	-69.58
181.32	V	-60.32	-18.78	-79.10	-13.00	-66.10
237.58	V	-63.74	-16.02	-79.76	-13.00	-66.76
559.62	V	-66.72	-8.29	-75.01	-13.00	-62.01
38.73	H	-62.82	-3.30	-66.13	-13.00	-53.13
136.70	H	-59.78	-20.62	-80.40	-13.00	-67.40
155.13	H	-61.39	-18.14	-79.53	-13.00	-66.53
181.32	H	-59.08	-18.11	-77.19	-13.00	-64.19
374.35	H	-63.89	-12.37	-76.25	-13.00	-63.25
569.32	H	-66.46	-7.62	-74.08	-13.00	-61.08

Remark:

1. Measuring frequencies from 1 GHz to the 10th harmonic of highest fundamental frequency.
2. Measurements above show only up to 6 maximum emissions noted, or would be lesser, with " N/A " remark, if no specific emissions from the EUT are recorded (ie: margin > 20dB from the applicable limit) and considered that's already beyond the background noise floor.



Operation Mode: WCDMA / HSDPA Band V / TX / CH 4233

Test Date: March 19, 2008

Temperature: 25°C

Tested by: Ryan Chen

Humidity: 50 % RH

Polarity: Ver. / Hor.

Frequency (MHz)	Antenna Polarization (V/H)	Reading (dBm)	Correction Factor (dB)	Emission level (dBm)	Limit (dBm)	Margin (dB)
39.70	V	-62.05	-0.63	-62.67	-13.00	-49.67
113.42	V	-58.27	-21.05	-79.33	-13.00	-66.33
151.25	V	-64.36	-16.47	-80.83	-13.00	-67.83
181.32	V	-58.69	-18.78	-77.47	-13.00	-64.47
237.58	V	-63.93	-16.02	-79.95	-13.00	-66.95
374.35	V	-63.68	-12.94	-76.62	-13.00	-63.62
36.79	H	-61.18	-3.80	-64.98	-13.00	-51.98
113.42	H	-57.68	-21.53	-79.22	-13.00	-66.22
155.13	H	-58.99	-18.14	-77.13	-13.00	-64.13
181.32	H	-56.43	-18.11	-74.54	-13.00	-61.54
321.97	H	-64.64	-14.34	-78.99	-13.00	-65.99
374.35	H	-60.02	-12.37	-72.39	-13.00	-59.39

Remark:

1. Measuring frequencies from 1 GHz to the 10th harmonic of highest fundamental frequency.
2. Measurements above show only up to 6 maximum emissions noted, or would be lesser, with " N/A " remark, if no specific emissions from the EUT are recorded (ie: margin > 20dB from the applicable limit) and considered that's already beyond the background noise floor.



Above 1GHz

Operation Mode: GSM 850 / TX / CH 128

Test Date: March 16, 2008

Temperature: 25°C

Tested by: Ryan Chen

Humidity: 55 % RH

Polarity: Ver. / Hor.

Frequency (MHz)	Antenna Polarization	Reading level (dBuV)	Correction Factor (dB)	Emission level (dBm)	Limit (dBm)	Margin (dB)
1651.00	V	-52.57	4.23	-48.34	-13.00	-35.34
2470.00	V	-51.40	8.88	-42.52	-13.00	-29.52
N/A						
1651.00	H	-46.78	4.19	-42.59	-13.00	-29.59
2470.00	H	-49.58	8.63	-40.95	-13.00	-27.95
N/A						

Remark:

1. *Measuring frequencies from 1 GHz to the 10th harmonic of highest fundamental frequency.*
2. *Measurements above show only up to 6 maximum emissions noted, or would be lesser; with " N/A " remark, if no specific emissions from the EUT are recorded (ie: margin > 20dB from the applicable limit) and considered that's already beyond the background noise floor.*



Operation Mode: GSM 850 / TX / CH 190

Test Date: March 16, 2008

Temperature: 25°C

Tested by: Ryan Chen

Humidity: 55 % RH

Polarity: Ver. / Hor.

Frequency (MHz)	Antenna Polarization	Reading level (dBuV)	Correction Factor (dB)	Emission level (dBm)	Limit (dBm)	Margin (dB)
1672.00	V	-53.01	4.35	-48.66	-13.00	-35.66
2512.00	V	-48.20	9.06	-39.14	-13.00	-26.14
N/A						
1672.00	H	-48.15	4.33	-43.81	-13.00	-30.81
2512.00	H	-44.40	8.78	-35.62	-13.00	-22.62
N/A						

Remark:

1. Measuring frequencies from 1 GHz to the 10th harmonic of highest fundamental frequency.
2. Measurements above show only up to 6 maximum emissions noted, or would be lesser, with " N/A " remark, if no specific emissions from the EUT are recorded (ie: margin > 20dB from the applicable limit) and considered that's already beyond the background noise floor.



Operation Mode: GSM 850 / TX / CH 251

Test Date: March 16, 2008

Temperature: 25°C

Tested by: Ryan Chen

Humidity: 55 % RH

Polarity: Ver. / Hor.

Frequency (MHz)	Antenna Polarization	Reading level (dBuV)	Correction Factor (dB)	Emission level (dBm)	Limit (dBm)	Margin (dB)
1700.00	V	-51.11	4.51	-46.60	-13.00	-33.60
2547.00	V	-51.83	9.10	-42.72	-13.00	-29.72
N/A						
1700.00	H	-50.09	4.52	-45.57	-13.00	-32.57
2547.00	H	-45.27	8.84	-36.43	-13.00	-23.43
N/A						

Remark:

1. Measuring frequencies from 1 GHz to the 10th harmonic of highest fundamental frequency.
2. Measurements above show only up to 6 maximum emissions noted, or would be lesser; with " N/A " remark, if no specific emissions from the EUT are recorded (ie: margin > 20dB from the applicable limit) and considered that's already beyond the background noise floor.



Operation Mode: GPRS 850 / TX / CH 128

Test Date: March 16, 2008

Temperature: 25°C

Tested by: Ryan Chen

Humidity: 55 % RH

Polarity: Ver. / Hor.

Frequency (MHz)	Antenna Polarization	Reading level (dBuV)	Correction Factor (dB)	Emission level (dBm)	Limit (dBm)	Margin (dB)
1651.00	V	-51.48	4.23	-47.25	-13.00	-34.25
2470.00	V	-49.51	8.88	-40.63	-13.00	-27.63
N/A						
1651.00	H	-47.56	4.19	-43.37	-13.00	-30.37
2470.00	H	-49.03	8.63	-40.40	-13.00	-27.40
N/A						

Remark:

1. Measuring frequencies from 1 GHz to the 10th harmonic of highest fundamental frequency.
2. Measurements above show only up to 6 maximum emissions noted, or would be lesser, with " N/A " remark, if no specific emissions from the EUT are recorded (ie: margin > 20dB from the applicable limit) and considered that's already beyond the background noise floor.



Operation Mode: GPRS 850 / TX / CH 190

Test Date: March 16, 2008

Temperature: 25°C

Tested by: Ryan Chen

Humidity: 55 % RH

Polarity: Ver. / Hor.

Frequency (MHz)	Antenna Polarization	Reading level (dBuV)	Correction Factor (dB)	Emission level (dBm)	Limit (dBm)	Margin (dB)
1672.00	V	-49.51	4.35	-45.16	-13.00	-32.16
2512.00	V	-47.14	9.06	-38.07	-13.00	-25.07
N/A						
1672.00	H	-47.97	4.33	-43.63	-13.00	-30.63
2512.00	H	-41.73	8.78	-32.95	-13.00	-19.95
N/A						

Remark:

1. Measuring frequencies from 1 GHz to the 10th harmonic of highest fundamental frequency.
2. Measurements above show only up to 6 maximum emissions noted, or would be lesser, with " N/A " remark, if no specific emissions from the EUT are recorded (ie: margin > 20dB from the applicable limit) and considered that's already beyond the background noise floor.



Operation Mode: GPRS 850 / TX / CH 251

Test Date: March 16, 2008

Temperature: 25°C

Tested by: Ryan Chen

Humidity: 55 % RH

Polarity: Ver. / Hor.

Frequency (MHz)	Antenna Polarization	Reading level (dBuV)	Correction Factor (dB)	Emission level (dBm)	Limit (dBm)	Margin (dB)
1700.00	V	-50.19	4.51	-45.68	-13.00	-32.68
2547.00	V	-50.07	9.10	-40.96	-13.00	-27.96
N/A						
1700.00	H	-49.69	4.52	-45.16	-13.00	-32.16
2547.00	H	-44.74	8.84	-35.90	-13.00	-22.90
N/A						

Remark:

1. Measuring frequencies from 1 GHz to the 10th harmonic of highest fundamental frequency.
2. Measurements above show only up to 6 maximum emissions noted, or would be lesser, with " N/A " remark, if no specific emissions from the EUT are recorded (ie: margin>20dB from the applicable limit) and considered that's already beyond the background noise floor.



Operation Mode: GSM 1900 / TX / CH 512

Test Date: March 16, 2008

Temperature: 25°C

Tested by: Ryan Chen

Humidity: 55 % RH

Polarity: Ver. / Hor.

Frequency (MHz)	Antenna Polarization	Reading level (dBuV)	Correction Factor (dB)	Emission level (dBm)	Limit (dBm)	Margin (dB)
5550.00	V	-52.94	10.06	-42.88	-13.00	-29.88
N/A						
5550.00	H	-54.27	9.81	-44.46	-13.00	-31.46
N/A						

Remark:

1. Measuring frequencies from 1 GHz to the 10th harmonic of highest fundamental frequency.
2. Measurements above show only up to 6 maximum emissions noted, or would be lesser, with " N/A " remark, if no specific emissions from the EUT are recorded (ie: margin > 20dB from the applicable limit) and considered that's already beyond the background noise floor.



Operation Mode: GSM 1900 / TX / CH 661

Test Date: March 16, 2008

Temperature: 25°C

Tested by: Ryan Chen

Humidity: 55 % RH

Polarity: Ver. / Hor.

Frequency (MHz)	Antenna Polarization	Reading level (dBuV)	Correction Factor (dB)	Emission level (dBm)	Limit (dBm)	Margin (dB)
5641.00	V	-53.87	10.14	-43.72	-13.00	-30.72
N/A						
5641.00	H	-56.83	9.92	-46.91	-13.00	-33.91
N/A						

Remark:

1. Measuring frequencies from 1 GHz to the 10th harmonic of highest fundamental frequency.
2. Measurements above show only up to 6 maximum emissions noted, or would be lesser, with " N/A " remark, if no specific emissions from the EUT are recorded (ie: margin>20dB from the applicable limit) and considered that's already beyond the background noise floor.



Operation Mode: GSM 1900 / TX / CH 810

Test Date: March 16, 2008

Temperature: 25°C

Tested by: Ryan Chen

Humidity: 55 % RH

Polarity: Ver. / Hor.

Frequency (MHz)	Antenna Polarization	Reading level (dBuV)	Correction Factor (dB)	Emission level (dBm)	Limit (dBm)	Margin (dB)
5732.00	V	-53.67	10.22	-43.45	-13.00	-30.45
N/A						
5732.00	H	-51.89	10.03	-41.87	-13.00	-28.87
N/A						

Remark:

1. Measuring frequencies from 1 GHz to the 10th harmonic of highest fundamental frequency.
2. Measurements above show only up to 6 maximum emissions noted, or would be lesser, with " N/A " remark, if no specific emissions from the EUT are recorded (ie: margin>20dB from the applicable limit) and considered that's already beyond the background noise floor.



Operation Mode: GPRS 1900 / TX / CH 512

Test Date: March 16, 2008

Temperature: 25°C

Tested by: Ryan Chen

Humidity: 55 % RH

Polarity: Ver. / Hor.

Frequency (MHz)	Antenna Polarization	Reading level (dBuV)	Correction Factor (dB)	Emission level (dBm)	Limit (dBm)	Margin (dB)
5550.00	V	-55.18	10.06	-45.12	-13.00	-32.12
N/A						
5550.00	H	-55.50	9.81	-45.69	-13.00	-32.69
N/A						

Remark:

1. Measuring frequencies from 1 GHz to the 10th harmonic of highest fundamental frequency.
2. Measurements above show only up to 6 maximum emissions noted, or would be lesser, with " N/A " remark, if no specific emissions from the EUT are recorded (ie: margin>20dB from the applicable limit) and considered that's already beyond the background noise floor.



Operation Mode: GPRS 1900 / TX / CH 661

Test Date: March 16, 2008

Temperature: 25°C

Tested by: Ryan Chen

Humidity: 55 % RH

Polarity: Ver. / Hor.

Frequency (MHz)	Antenna Polarization	Reading level (dBuV)	Correction Factor (dB)	Emission level (dBm)	Limit (dBm)	Margin (dB)
5641.00	V	-56.07	10.14	-45.93	-13.00	-32.93
N/A						
5641.00	H	-53.83	9.92	-43.92	-13.00	-30.92
N/A						

Remark:

1. Measuring frequencies from 1 GHz to the 10th harmonic of highest fundamental frequency.
2. Measurements above show only up to 6 maximum emissions noted, or would be lesser, with " N/A " remark, if no specific emissions from the EUT are recorded (ie: margin>20dB from the applicable limit) and considered that's already beyond the background noise floor.



Operation Mode: GPRS 1900 / TX / CH 810

Test Date: March 16, 2008

Temperature: 25°C

Tested by: Ryan Chen

Humidity: 55 % RH

Polarity: Ver. / Hor.

Frequency (MHz)	Antenna Polarization	Reading level (dBuV)	Correction Factor (dB)	Emission level (dBm)	Limit (dBm)	Margin (dB)
5732.00	V	-52.53	10.22	-42.31	-13.00	-29.31
N/A						
5732.00	H	-53.78	10.03	-43.75	-13.00	-30.75
N/A						

Remark:

1. Measuring frequencies from 1 GHz to the 10th harmonic of highest fundamental frequency.
2. Measurements above show only up to 6 maximum emissions noted, or would be lesser, with " N/A " remark, if no specific emissions from the EUT are recorded (ie: margin > 20dB from the applicable limit) and considered that's already beyond the background noise floor.



Operation Mode: EDGE 850 / TX / CH 128

Test Date: March 16, 2008

Temperature: 25°C

Tested by: Mimic Yang

Humidity: 50 % RH

Polarity: Ver. / Hor.

Frequency (MHz)	Antenna Polarization (V/H)	Reading (dBm)	Correction Factor (dB)	Emission level (dBm)	Limit (dBm)	Margin (dB)
1651.00	V	-49.93	4.23	-45.70	-13.00	-32.70
2470.00	V	-53.30	8.88	-44.42	-13.00	-31.42
N/A						
1651.00	H	-49.55	4.19	-45.36	-13.00	-32.36
2470.00	H	-53.64	8.63	-45.01	-13.00	-32.01
N/A						

Remark:

1. Measuring frequencies from 1 GHz to the 10th harmonic of highest fundamental frequency.
2. Measurements above show only up to 6 maximum emissions noted, or would be lesser; with " N/A " remark, if no specific emissions from the EUT are recorded (ie: margin > 20dB from the applicable limit) and considered that's already beyond the background noise floor.



Operation Mode: EDGE 850 / TX / CH 190

Test Date: March 16, 2008

Temperature: 25°C

Tested by: Mimic Yang

Humidity: 50 % RH

Polarity: Ver. / Hor.

Frequency (MHz)	Antenna Polarization (V/H)	Reading (dBm)	Correction Factor (dB)	Emission level (dBm)	Limit (dBm)	Margin (dB)
1672.00	V	-48.42	4.35	-44.08	-13.00	-31.08
2512.00	V	-47.87	9.06	-38.81	-13.00	-25.81
N/A						
1672.00	H	-47.30	4.33	-42.96	-13.00	-29.96
2512.00	H	-46.47	8.78	-37.69	-13.00	-24.69
N/A						

Remark:

1. Measuring frequencies from 1 GHz to the 10th harmonic of highest fundamental frequency.
2. Measurements above show only up to 6 maximum emissions noted, or would be lesser; with " N/A " remark, if no specific emissions from the EUT are recorded (ie: margin > 20dB from the applicable limit) and considered that's already beyond the background noise floor.



Operation Mode: EDGE 850 / TX / CH 251

Test Date: March 16, 2008

Temperature: 25°C

Tested by: Mimic Yang

Humidity: 50 % RH

Polarity: Ver. / Hor.

Frequency (MHz)	Antenna Polarization (V/H)	Reading (dBm)	Correction Factor (dB)	Emission level (dBm)	Limit (dBm)	Margin (dB)
1700.00	V	-49.85	4.51	-45.35	-13.00	-32.35
2547.00	V	-47.21	9.10	-38.10	-13.00	-25.10
N/A						
1700.00	H	-50.94	4.52	-46.41	-13.00	-33.41
2547.00	H	-48.02	8.84	-39.18	-13.00	-26.18
N/A						

Remark:

1. Measuring frequencies from 1 GHz to the 10th harmonic of highest fundamental frequency.
2. Measurements above show only up to 6 maximum emissions noted, or would be lesser; with " N/A " remark, if no specific emissions from the EUT are recorded (ie: margin > 20dB from the applicable limit) and considered that's already beyond the background noise floor.



Operation Mode: EDGE 1900 / TX / CH 512

Test Date: March 16, 2008

Temperature: 25°C

Tested by: Mimic Yang

Humidity: 50 % RH

Polarity: Ver. / Hor.

Frequency (MHz)	Antenna Polarization (V/H)	Reading (dBm)	Correction Factor (dB)	Emission level (dBm)	Limit (dBm)	Margin (dB)
5550.00	V	-57.72	10.06	-47.65	-13.00	-34.65
N/A						
5550.00	H	-55.92	9.81	-46.11	-13.00	-33.11
N/A						

Remark:

1. Measuring frequencies from 1 GHz to the 10th harmonic of highest fundamental frequency.
2. Measurements above show only up to 6 maximum emissions noted, or would be lesser; with " N/A " remark, if no specific emissions from the EUT are recorded (ie: margin > 20dB from the applicable limit) and considered that's already beyond the background noise floor.



Operation Mode: EDGE 1900 / TX / CH 661

Test Date: March 16, 2008

Temperature: 25°C

Tested by: Mimic Yang

Humidity: 50 % RH

Polarity: Ver. / Hor.

Frequency (MHz)	Antenna Polarization (V/H)	Reading (dBm)	Correction Factor (dB)	Emission level (dBm)	Limit (dBm)	Margin (dB)
5641.00	V	-54.96	10.14	-44.81	-13.00	-31.81
N/A						
5641.00	H	-53.42	9.92	-43.50	-13.00	-30.50
N/A						

Remark:

1. Measuring frequencies from 1 GHz to the 10th harmonic of highest fundamental frequency.
2. Measurements above show only up to 6 maximum emissions noted, or would be lesser; with " N/A " remark, if no specific emissions from the EUT are recorded (ie: margin > 20dB from the applicable limit) and considered that's already beyond the background noise floor.



Operation Mode: EDGE 1900 / TX / CH 810

Test Date: March 16, 2008

Temperature: 25°C

Tested by: Mimic Yang

Humidity: 50 % RH

Polarity: Ver. / Hor.

Frequency (MHz)	Antenna Polarization (V/H)	Reading (dBm)	Correction Factor (dB)	Emission level (dBm)	Limit (dBm)	Margin (dB)
5732.00	V	-53.46	10.22	-43.24	-13.00	-30.24
N/A						
5732.00	H	-51.19	10.03	-41.17	-13.00	-28.17
N/A						

Remark:

1. Measuring frequencies from 1 GHz to the 10th harmonic of highest fundamental frequency.
2. Measurements above show only up to 6 maximum emissions noted, or would be lesser; with " N/A " remark, if no specific emissions from the EUT are recorded (ie: margin > 20dB from the applicable limit) and considered that's already beyond the background noise floor.



Operation Mode: WCDMA Band II / TX / CH 9262

Test Date: March 19, 2008

Temperature: 25°C

Tested by: Ryan Chen

Humidity: 50 % RH

Polarity: Ver. / Hor.

Frequency (MHz)	Antenna Polarization (V/H)	Reading (dBm)	Correction Factor (dB)	Emission level (dBm)	Limit (dBm)	Margin (dB)
3709.00	V	-49.30	9.44	-39.86	-13.00	-26.86
N/A						
3702.00	H	-49.45	9.29	-40.16	-13.00	-27.16
N/A						

Remark:

1. Measuring frequencies from 1 GHz to the 10th harmonic of highest fundamental frequency.
2. Measurements above show only up to 6 maximum emissions noted, or would be lesser; with " N/A " remark, if no specific emissions from the EUT are recorded (ie: margin > 20dB from the applicable limit) and considered that's already beyond the background noise floor.



Operation Mode: WCDMA Band II / TX / CH 9400

Test Date: March 19, 2008

Temperature: 25°C

Tested by: Ryan Chen

Humidity: 50 % RH

Polarity: Ver. / Hor.

Frequency (MHz)	Antenna Polarization (V/H)	Reading (dBm)	Correction Factor (dB)	Emission level (dBm)	Limit (dBm)	Margin (dB)
3758.00	V	-50.86	9.46	-41.41	-13.00	-28.41
N/A						
3765.00	H	-49.17	9.36	-39.81	-13.00	-26.81
5508.00	H	-59.39	9.76	-49.63	-13.00	-36.63
N/A						

Remark:

1. Measuring frequencies from 1 GHz to the 10th harmonic of highest fundamental frequency.
2. Measurements above show only up to 6 maximum emissions noted, or would be lesser; with " N/A " remark, if no specific emissions from the EUT are recorded (ie: margin > 20dB from the applicable limit) and considered that's already beyond the background noise floor.



Operation Mode: WCDMA Band II / TX / CH 9538

Test Date: March 19, 2008

Temperature: 25°C

Tested by: Ryan Chen

Humidity: 50 % RH

Polarity: Ver. / Hor.

Frequency (MHz)	Antenna Polarization (V/H)	Reading (dBm)	Correction Factor (dB)	Emission level (dBm)	Limit (dBm)	Margin (dB)
3821.00	V	-54.87	9.48	-45.39	-13.00	-32.39
N/A						
3814.00	H	-49.11	9.41	-39.70	-13.00	-26.70
N/A						

Remark:

1. Measuring frequencies from 1 GHz to the 10th harmonic of highest fundamental frequency.
2. Measurements above show only up to 6 maximum emissions noted, or would be lesser; with " N/A " remark, if no specific emissions from the EUT are recorded (ie: margin > 20dB from the applicable limit) and considered that's already beyond the background noise floor.



Operation Mode: WCDMA Band V / TX / CH 4132

Test Date: March 19, 2008

Temperature: 25°C

Tested by: Ryan Chen

Humidity: 50 % RH

Polarity: Ver. / Hor.

Frequency (MHz)	Antenna Polarization (V/H)	Reading (dBm)	Correction Factor (dB)	Emission level (dBm)	Limit (dBm)	Margin (dB)
2414.00	V	-59.32	8.56	-50.76	-13.00	-37.76
N/A						
1651.00	H	-58.17	4.19	-53.98	-13.00	-40.98
N/A						

Remark:

1. Measuring frequencies from 1 GHz to the 10th harmonic of highest fundamental frequency.
2. Measurements above show only up to 6 maximum emissions noted, or would be lesser; with " N/A " remark, if no specific emissions from the EUT are recorded (ie: margin > 20dB from the applicable limit) and considered that's already beyond the background noise floor.



Operation Mode: WCDMA Band V / TX / CH 4183

Test Date: March 19, 2008

Temperature: 25°C

Tested by: Ryan Chen

Humidity: 50 % RH

Polarity: Ver. / Hor.

Frequency (MHz)	Antenna Polarization (V/H)	Reading (dBm)	Correction Factor (dB)	Emission level (dBm)	Limit (dBm)	Margin (dB)
2379.00	V	-58.97	8.36	-50.60	-13.00	-37.60
N/A						
1679.00	H	-54.99	4.38	-50.61	-13.00	-37.61
N/A						

Remark:

1. Measuring frequencies from 1 GHz to the 10th harmonic of highest fundamental frequency.
2. Measurements above show only up to 6 maximum emissions noted, or would be lesser; with " N/A " remark, if no specific emissions from the EUT are recorded (ie: margin > 20dB from the applicable limit) and considered that's already beyond the background noise floor.



Operation Mode: WCDMA Band V / TX / CH 4233

Test Date: March 19, 2008

Temperature: 25°C

Tested by: Ryan Chen

Humidity: 50 % RH

Polarity: Ver. / Hor.

Frequency (MHz)	Antenna Polarization (V/H)	Reading (dBm)	Correction Factor (dB)	Emission level (dBm)	Limit (dBm)	Margin (dB)
2407.00	V	-59.63	8.52	-51.11	-13.00	-38.11
N/A						
1693.00	H	-57.37	4.48	-52.90	-13.00	-39.90
N/A						

Remark:

1. Measuring frequencies from 1 GHz to the 10th harmonic of highest fundamental frequency.
2. Measurements above show only up to 6 maximum emissions noted, or would be lesser; with " N/A " remark, if no specific emissions from the EUT are recorded (ie: margin > 20dB from the applicable limit) and considered that's already beyond the background noise floor.



Operation Mode: WCDMA / HSDPA Band II / TX / CH 9262

Test Date: March 19, 2008

Temperature: 25°C

Tested by: Ryan Chen

Humidity: 50 % RH

Polarity: Ver. / Hor.

Frequency (MHz)	Antenna Polarization (V/H)	Reading (dBm)	Correction Factor (dB)	Emission level (dBm)	Limit (dBm)	Margin (dB)
3709.00	V	-51.16	9.44	-41.72	-13.00	-28.72
N/A						
3702.00	H	-55.56	9.29	-46.26	-13.00	-33.26
6152.00		-59.49	10.64	-48.85	-13.00	-35.85
N/A						

Remark:

1. Measuring frequencies from 1 GHz to the 10th harmonic of highest fundamental frequency.
2. Measurements above show only up to 6 maximum emissions noted, or would be lesser, with " N/A " remark, if no specific emissions from the EUT are recorded (ie: margin > 20dB from the applicable limit) and considered that's already beyond the background noise floor.



Operation Mode: WCDMA / HSDPA Band II / TX / CH 9400

Test Date: March 19, 2008

Temperature: 25°C

Tested by: Ryan Chen

Humidity: 50 % RH

Polarity: Ver. / Hor.

Frequency (MHz)	Antenna Polarization (V/H)	Reading (dBm)	Correction Factor (dB)	Emission level (dBm)	Limit (dBm)	Margin (dB)
3758.00	V	-53.76	9.46	-44.30	-13.00	-31.30
N/A						
3765.00	H	-55.93	9.36	-46.57	-13.00	-33.57
N/A						

Remark:

1. Measuring frequencies from 1 GHz to the 10th harmonic of highest fundamental frequency.
2. Measurements above show only up to 6 maximum emissions noted, or would be lesser, with " N/A " remark, if no specific emissions from the EUT are recorded (ie: margin > 20dB from the applicable limit) and considered that's already beyond the background noise floor.



Operation Mode: WCDMA / HSDPA Band II / TX / CH 9538

Test Date: March 19, 2008

Temperature: 25°C

Tested by: Ryan Chen

Humidity: 50 % RH

Polarity: Ver. / Hor.

Frequency (MHz)	Antenna Polarization (V/H)	Reading (dBm)	Correction Factor (dB)	Emission level (dBm)	Limit (dBm)	Margin (dB)
3814.00	V	-55.88	9.48	-46.40	-13.00	-33.40
N/A						
3814.00	H	-56.89	9.41	-47.48	-13.00	-34.48
N/A						

Remark:

1. Measuring frequencies from 1 GHz to the 10th harmonic of highest fundamental frequency.
2. Measurements above show only up to 6 maximum emissions noted, or would be lesser, with " N/A " remark, if no specific emissions from the EUT are recorded (ie: margin > 20dB from the applicable limit) and considered that's already beyond the background noise floor.



Operation Mode: WCDMA / HSDPA Band V / TX / CH 4132

Test Date: March 19, 2008

Temperature: 25°C

Tested by: Ryan Chen

Humidity: 50 % RH

Polarity: Ver. / Hor.

Frequency (MHz)	Antenna Polarization (V/H)	Reading (dBm)	Correction Factor (dB)	Emission level (dBm)	Limit (dBm)	Margin (dB)
1735.00	V	-59.48	4.71	-54.78	-13.00	-41.78
N/A						
1651.00	H	-57.02	4.19	-52.83	-13.00	-39.83
N/A						

Remark:

1. Measuring frequencies from 1 GHz to the 10th harmonic of highest fundamental frequency.
2. Measurements above show only up to 6 maximum emissions noted, or would be lesser, with " N/A " remark, if no specific emissions from the EUT are recorded (ie: margin > 20dB from the applicable limit) and considered that's already beyond the background noise floor.



Operation Mode: WCDMA / HSDPA Band V / TX / CH 4183

Test Date: March 19, 2008

Temperature: 25°C

Tested by: Ryan Chen

Humidity: 50 % RH

Polarity: Ver. / Hor.

Frequency (MHz)	Antenna Polarization (V/H)	Reading (dBm)	Correction Factor (dB)	Emission level (dBm)	Limit (dBm)	Margin (dB)
1672.00	V	-59.51	4.35	-55.16	-13.00	-42.16
N/A						
1672.00	H	-54.95	4.33	-50.62	-13.00	-37.62
N/A						

Remark:

1. Measuring frequencies from 1 GHz to the 10th harmonic of highest fundamental frequency.
2. Measurements above show only up to 6 maximum emissions noted, or would be lesser, with " N/A " remark, if no specific emissions from the EUT are recorded (ie: margin > 20dB from the applicable limit) and considered that's already beyond the background noise floor.



Operation Mode: WCDMA / HSDPA Band V / TX / CH 4233

Test Date: March 19, 2008

Temperature: 25°C

Tested by: Ryan Chen

Humidity: 50 % RH

Polarity: Ver. / Hor.

Frequency (MHz)	Antenna Polarization (V/H)	Reading (dBm)	Correction Factor (dB)	Emission level (dBm)	Limit (dBm)	Margin (dB)
2491.00	V	-59.69	9.00	-50.69	-13.00	-37.69
N/A						
1693.00	H	-58.24	4.48	-53.76	-13.00	-40.76
N/A						

Remark:

1. Measuring frequencies from 1 GHz to the 10th harmonic of highest fundamental frequency.
2. Measurements above show only up to 6 maximum emissions noted, or would be lesser, with " N/A " remark, if no specific emissions from the EUT are recorded (ie: margin > 20dB from the applicable limit) and considered that's already beyond the background noise floor.

7.6 FREQUENCY STABILITY V.S. TEMPERATURE MEASUREMENT

LIMIT

According to FCC §2.1055, FCC §24.235.

Frequency Tolerance: 2.5 ppm

Test Configuration

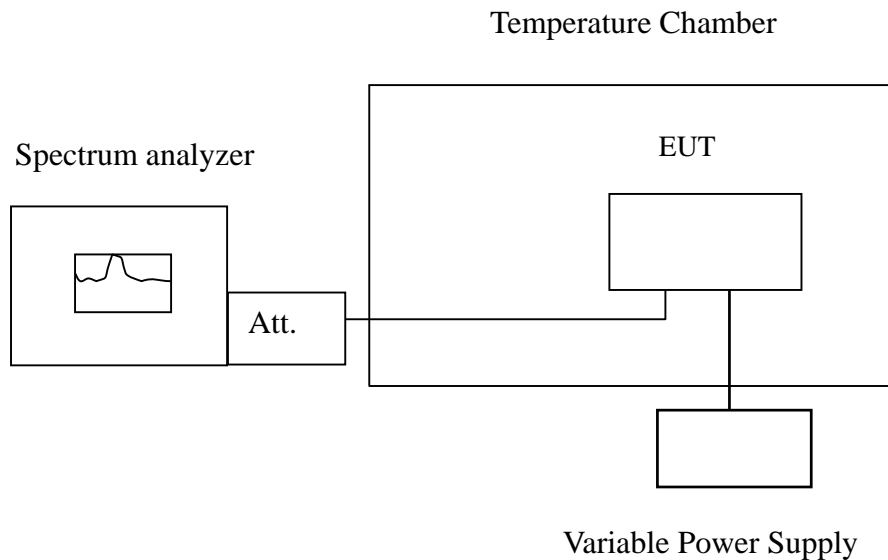

Remark: Measurement setup for testing on Antenna connector.



TEST PROCEDURE

The equipment under test was connected to an external AC or DC power supply and input rated voltage. RF output was connected to a frequency counter or spectrum analyzer via feed through attenuators. The EUT was placed inside the temperature chamber. Set the spectrum analyzer RBW low enough to obtain the desired frequency resolution and measure EUT 20°C operating frequency as reference frequency. Turn EUT off and set the chamber temperature to -30°C. After the temperature stabilized for approximately 30 minutes recorded the frequency. Repeat step measure with 10°C increased per stage until the highest temperature of +50°C reached.

TEST RESULTS

No non-compliance noted.

Reference Frequency: GSM Mid Channel 836.6 MHz @ 20°C				
Limit: +/- 2.5 ppm = 2090 Hz				
Power Supply Vdc	Environment Temperature (°C)	Frequency (Hz)	Delta (Hz)	Limit (Hz)
3.7	50	83599992	13	2090
	40	83599986	7	
	30	83599990	11	
	20	83599979	0	
	10	83599998	19	
	0	83600000	21	
	-10	83600002	23	
	-20	83600004	25	
	-30	83600007	28	

Reference Frequency: GSM Mid Channel 1880 MHz @ 20°C				
Limit = 90 Hz				
Power Supply Vdc	Environment Temperature (°C)	Frequency (Hz)	Delta (Hz)	Limit (Hz)
3.7	50	1880000004	19	90
	40	1880000000	15	
	30	1880000001	16	
	20	1879999985	0	
	10	1880000003	18	
	0	1880000001	16	
	-10	1880000008	23	
	-20	1880000005	20	
	-30	1880000007	22	



Reference Frequency: GPRS Mid Channel 836.6 MHz @ 20°C				
Limit: +/- 2.5 ppm = 2090 Hz				
Power Supply Vdc	Environment Temperature (°C)	Frequency (Hz)	Delta (Hz)	Limit (Hz)
3.7	50	83600008	16	2090
	40	83600010	18	
	30	83600012	20	
	20	83599992	0	
	10	83600001	9	
	0	83600005	13	
	-10	83599998	6	
	-20	83599999	7	
	-30	83599997	5	

Reference Frequency: GPRS Mid Channel 1880 MHz @ 20°C				
Limit = 90 Hz				
Power Supply Vdc	Environment Temperature (°C)	Frequency (Hz)	Delta (Hz)	Limit (Hz)
3.7	50	1880000001	26	90
	40	1880000005	30	
	30	1880000002	27	
	20	1879999975	0	
	10	1879999997	22	
	0	1880000008	33	
	-10	1880000012	37	
	-20	1880000028	53	
	-30	1880000029	54	



Reference Frequency: EDGE Mid Channel 836.6 MHz @ 20°C				
Limit: +/- 2.5 ppm = 2090 Hz				
Power Supply Vdc	Environment Temperature (°C)	Frequency (Hz)	Delta (Hz)	Limit (Hz)
3.7	50	83600008	4	2090
	40	83600011	7	
	30	83600009	5	
	20	83600004	0	
	10	83600015	11	
	0	83599994	-10	
	-10	83599985	-19	
	-20	83599982	-22	
	-30	83600019	15	

Reference Frequency: EDGE Mid Channel 1880 MHz @ 20°C				
Limit = 90 Hz				
Power Supply Vdc	Environment Temperature (°C)	Frequency (Hz)	Delta (Hz)	Limit (Hz)
3.7	50	1880000047	59	90
	40	1880000043	55	
	30	1880000040	52	
	20	1879999988	0	
	10	1880000048	60	
	0	1880000051	63	
	-10	1880000056	68	
	-20	1880000055	67	
	-30	1880000060	72	



Reference Frequency: WCDMA Band V Mid Channel 836.6 MHz @ 20°C				
Limit: +/- 2.5 ppm = 2090 Hz				
Power Supply Vdc	Environment Temperature (°C)	Frequency (Hz)	Delta (Hz)	Limit (Hz)
3.7	50	83599999	-32	2090
	40	83600004	-27	
	30	83600000	-31	
	20	83600031	0	
	10	83599988	-43	
	0	83599987	-44	
	-10	83599983	-48	
	-20	83599971	-60	
	-30	83599983	-48	

Reference Frequency: WCDMA Band II Mid Channel 1880 MHz @ 20°C				
Limit = 90 Hz				
Power Supply Vdc	Environment Temperature (°C)	Frequency (Hz)	Delta (Hz)	Limit (Hz)
3.7	50	1879999974	-59	90
	40	1879999963	-70	
	30	1879999967	-66	
	20	1880000033	0	
	10	1879999955	-78	
	0	1879999944	-89	
	-10	1879999954	-79	
	-20	1879999949	-84	
	-30	1879999939	-94	



Reference Frequency: WCDMA / HSDPA Band V Mid Channel 836.6 MHz @ 20°C				
Limit: +/- 2.5 ppm = 2090 Hz				
Power Supply Vdc	Environment Temperature (°C)	Frequency (Hz)	Delta (Hz)	Limit (Hz)
3.7	50	83599988	-12	2090
	40	83599990	-10	
	30	83599993	-7	
	20	83600000	0	
	10	83599981	-19	
	0	83599980	-20	
	-10	83599978	-22	
	-20	83599985	-15	
	-30	83599977	-23	

Reference Frequency: WCDMA / HSDPA Band II Mid Channel 1880 MHz @ 20°C				
Limit = 90 Hz				
Power Supply Vdc	Environment Temperature (°C)	Frequency (Hz)	Delta (Hz)	Limit (Hz)
3.7	50	1879999996	76	90
	40	1879999995	75	
	30	1879999997	77	
	20	1879999920	0	
	10	1879999998	78	
	0	1879999999	79	
	-10	1880000000	80	
	-20	1879999997	77	
	-30	1879999999	79	

7.7 FREQUENCY STABILITY V.S. VOLTAGE MEASUREMENT

LIMIT

According to FCC §2.1055, FCC §24.235,

Frequency Tolerance: 2.5 ppm.

Test Configuration

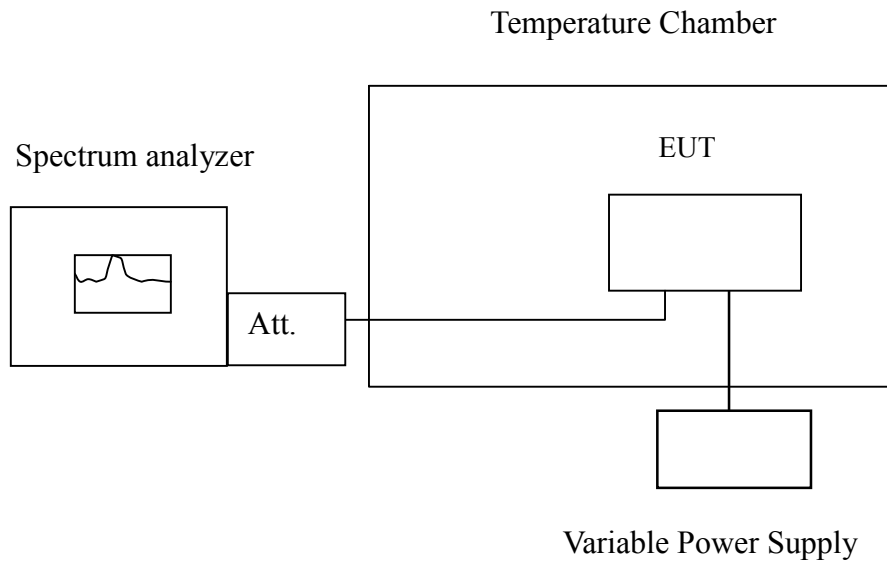

Remark: Measurement setup for testing on Antenna connector.



TEST PROCEDURE

Set chamber temperature to 20°C. Use a variable AC power supply / DC power source to power the EUT and set the voltage to rated voltage. Set the spectrum analyzer RBW low enough to obtain the desired frequency resolution and recorded the frequency.

Reduce the input voltage to specify extreme voltage variation (± 15%) and endpoint, record the maximum frequency change.

TEST RESULTS

No non-compliance noted.

Reference Frequency: GSM Mid Channel 836.6 MHz @ 20°C				
Limit: ± 2.5 ppm = 2090Hz				
Power Supply Vdc	Environment Temperature (°C)	Frequency (Hz)	Delta (Hz)	Limit (Hz)
4.07	20	83599980	1	2090
3.7		83599979	0	
3.33		83599977	-2	
3.1END		83599871	-106	

Reference Frequency: GSM Mid Channel 1880 MHz @ 20°C				
Limit: ± 2.5 ppm = 4700 Hz				
Power Supply Vdc	Environment Temperature (°C)	Frequency (Hz)	Delta (Hz)	Limit (Hz)
4.07	20	1879999988	3	4700
3.7		1879999985	0	
3.33		1879999983	-2	
3.1END		1879999716	-269	



Reference Frequency: GPRS Mid Channel 836.6 MHz @ 20°C				
Limit: ± 2.5 ppm = 2090Hz				
Power Supply Vdc	Environment Temperature (°C)	Frequency (Hz)	Delta (Hz)	Limit (Hz)
4.07	20	83599988	-4	2090
3.7		83599992	0	
3.33		83600008	16	
3.1END		83599974	-34	

Reference Frequency: GPRS Mid Channel 1880 MHz @ 20°C				
Limit: ± 2.5 ppm = 4700 Hz				
Power Supply Vdc	Environment Temperature (°C)	Frequency (Hz)	Delta (Hz)	Limit (Hz)
4.07	20	187999973	-2	4700
3.7		187999975	0	
3.33		187999974	-1	
3.1END		1879999577	-398	



Reference Frequency: EDGE Mid Channel 836.6 MHz @ 20°C				
Limit: ± 2.5 ppm = 2090Hz				
Power Supply Vdc	Environment Temperature (°C)	Frequency (Hz)	Delta (Hz)	Limit (Hz)
4.07	20	83600009	5	2090
3.7		83600004	0	
3.33		83600003	-1	
3.0END		83600024	21	

Reference Frequency: EDGE Mid Channel 1880 MHz @ 20°C				
Limit: ± 2.5 ppm = 4700 Hz				
Power Supply Vdc	Environment Temperature (°C)	Frequency (Hz)	Delta (Hz)	Limit (Hz)
4.07	20	1879999990	2	4700
3.7		1879999988	0	
3.33		1879999947	-41	
3.1END		1879999474	-514	



Reference Frequency: WCDMA Band II Mid Channel 1880 MHz @ 20°C				
Limit: ± 2.5 ppm = 4700 Hz				
Power Supply Vdc	Environment Temperature (°C)	Frequency (Hz)	Delta (Hz)	Limit (Hz)
4	20	188000018	-15	4700
3.7		188000033	0	
3.3		188000026	-7	
3.1END		1879999541	-492	

Reference Frequency: WCDMA Band V Mid Channel 836.6 MHz @ 20°C				
Limit: ± 2.5 ppm = 2090Hz				
Power Supply Vdc	Environment Temperature (°C)	Frequency (Hz)	Delta (Hz)	Limit (Hz)
4	20	83600017	-14	2090
3.7		83600031	0	
3.3		83600025	-6	
3.2END		83600278	253	



Reference Frequency: WCDMA HSDPA Band II Mid Channel 1880 MHz @ 20°C				
Limit: ± 2.5 ppm = 4700 Hz				
Power Supply Vdc	Environment Temperature (°C)	Frequency (Hz)	Delta (Hz)	Limit (Hz)
4	20	1879999943	23	4700
3.7		1879999920	0	
3.3		1879999938	18	
3.0END		1879999642	-278	

Reference Frequency: WCDMA HSDPA Band V Mid Channel 836.6 MHz @ 20°C				
Limit: ± 2.5 ppm = 2090Hz				
Power Supply Vdc	Environment Temperature (°C)	Frequency (Hz)	Delta (Hz)	Limit (Hz)
4	20	83600001	1	2090
3.7		83600000	0	
3.3		83599994	-6	
3.1END		83599256	-738	



7.8 POWERLINE CONDUCTED EMISSIONS

LIMIT

For an intentional radiator which is designed to be connected to the public utility (AC) power line, the radio frequency voltage that is conducted back onto the AC power line on any frequency or frequencies within the band 150 kHz to 30 MHz shall not exceed 250 microvolts (The limit decreases linearly with the logarithm of the frequency in the range 0.15 MHz to 0.50 MHz). The limits at specific frequency range is listed as follows:

Frequency Range (MHz)	Limits (dB μ V)	
	Quasi-peak	Average
0.15 to 0.50	66 to 56	56 to 46
0.50 to 5	56	46
5 to 30	60	50

Compliance with this provision shall be based on the measurement of the radio frequency voltage between each power line (LINE and NEUTRAL) and ground at the power terminals.

Test Configuration

See test photographs attached in Appendix I for the actual connections between EUT and support equipment.

TEST PROCEDURE

1. The EUT was placed on a table, which is 0.8m above ground plane.
2. Maximum procedure was performed on the six highest emissions to ensure EUT compliance.
3. Repeat above procedures until all frequency measured were complete.

**TEST RESULTS**

The initial step in collecting conducted data is a spectrum analyzer peak scan of the measurement range. Significant peaks are then marked as shown on the following data page, and these signals are then quasi-peaked.

Operation Mode: Normal Link mode **Test Date:** March 12, 2008
Temperature: 22°C **Tested by:** Ryan Chen
Humidity: 45% RH

Freq. (MHz)	QP Reading (dBuV)	AV Reading (dBuV)	Corr. factor (dB)	QP Result (dBuV)	AV Result (dBuV)	QP Limit (dBuV)	AV Limit (dBuV)	QP Margin (dB)	AV Margin (dB)	Note
0.2000	48.90	43.50	0.10	49.00	43.60	63.61	53.61	-14.61	-10.01	L1
0.2650	42.82	37.62	0.08	42.90	37.70	61.27	51.27	-18.37	-13.57	L1
0.3300	40.64	36.44	0.06	40.70	36.50	59.45	49.45	-18.75	-12.95	L1
0.4650	37.19	35.29	0.01	37.20	35.30	56.60	46.60	-19.40	-11.30	L1
0.6600	28.90	26.50	0.00	28.90	26.50	56.00	46.00	-27.10	-19.50	L1
5.2450	30.69	10.29	0.11	30.80	10.40	60.00	50.00	-29.20	-39.60	L1
0.2000	49.50	44.60	0.10	49.60	44.70	63.61	53.61	-14.01	-8.91	L2
0.2650	44.32	38.52	0.08	44.40	38.60	61.27	51.27	-16.87	-12.67	L2
0.3300	40.84	36.34	0.06	40.90	36.40	59.45	49.45	-18.55	-13.05	L2
0.4600	36.19	34.09	0.01	36.20	34.10	56.69	46.69	-20.49	-12.59	L2
0.6600	32.10	30.40	0.00	32.10	30.40	56.00	46.00	-23.90	-15.60	L2
5.2300	28.49	11.39	0.11	28.60	11.50	60.00	50.00	-31.40	-38.50	L2

Remark:

1. Measuring frequencies from 0.15 MHz to 30MHz.
2. The emissions measured in frequency range from 0.15 MHz to 30MHz were made with an instrument using Quasi-peak detector and average detector.
3. The IF bandwidth of SPA between 0.15MHz to 30MHz was 10kHz; the IF bandwidth of Test Receiver between 0.15MHz to 30MHz was 9kHz;
4. L1 = Line One (Live Line) / L2 = Line Two (Neutral Line)



Test Plots

Conducted emissions (Line 1)

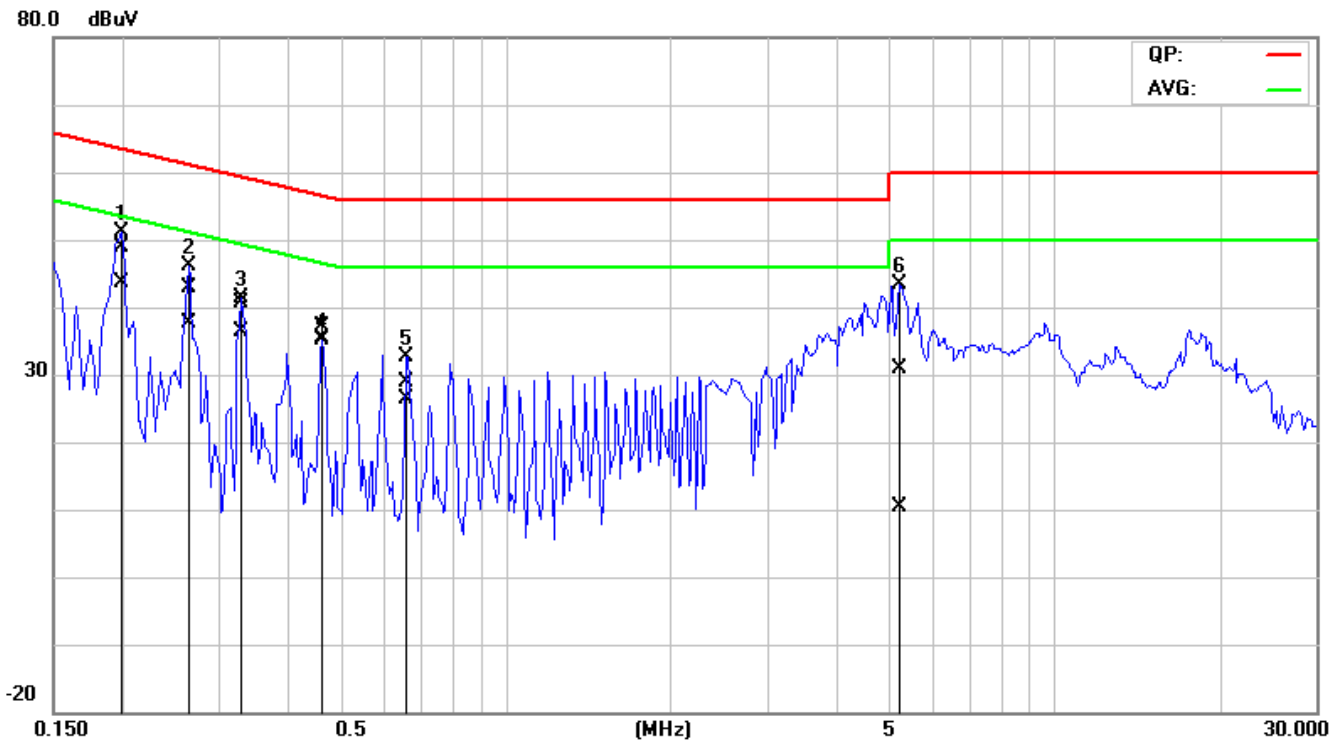

Conducted emissions (Line 2)

