

INSTALLATION MANUAL

ID CPR74

RFID Reader Module

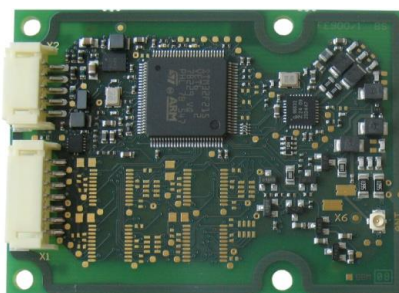
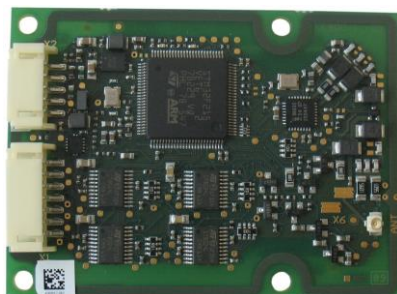

Model	Article-No.
ID CPR74-4SCUSB	4607.000.00
ID CPR74-CUSB	4606.000.00

Note

© Copyright by
FEIG ELECTRONIC GmbH
Industriestraße 1a
D-35781 Weilburg (Germany)
Tel.: +49 6471 3109-0
[https://www.feig.de/en/
identification-support@feig.de](https://www.feig.de/en/identification-support@feig.de)

With the edition of this document, all previous editions become void. Indications made in this manual may be changed without previous notice.

Copying of this document and giving it to others and the use or communication of the contents thereof are forbidden without express authority. Offenders are liable to the payment of damages. All rights are reserved in the event of the grant of a patent or the registration of a utility model or design.

Composition of the information in this document has been done to the best of our knowledge. FEIG ELECTRONIC GmbH does not guarantee the correctness and completeness of the details given in this manual and may not be held liable for damages ensuing from incorrect or incomplete information. Since, despite all our efforts, errors may not be completely avoided, we are always grateful for your useful tips. The instructions given in this manual are based on advantageous boundary conditions. FEIG ELECTRONIC GmbH does not give any guarantee promise for perfect function in cross environments and does not give any guarantee for the functionality of the complete system which incorporates the subject of this document. FEIG ELECTRONIC GmbH calls explicit attention that devices which are subject of this document are not designed with components and testing methods for a level of reliability suitable for use in or in connection with surgical implants or as critical components in any life support systems whose failure to perform can reasonably be expected to cause significant injury to human health. To avoid damage, injury or death the user or application designer must take reasonably prudent steps to protect against system failures. FEIG ELECTRONIC GmbH assumes no responsibility for the use of any information contained in this document and makes no representation that they are free of patent infringement. FEIG ELECTRONIC GmbH does not convey any license under its patent rights nor the rights of others.

Content

1	Safety Instructions	4
2	Characterization ID CPR74	5
2.1	Scope of delivery	6
2.2	Available Accessories.....	6
2.3	Available Software Tools, USB Driver and Firmware.....	6
3	Dimensions	7
4	Installation and wiring	8
4.1	Connector X1, X2.....	8
4.2	Digital Outputs.....	10
4.3	Connection of an external Antenna.....	11
4.4	SAM Slots.....	12
4.4.1	Installation of a SAM Card in a SAM Socket.....	13
5	Power supply	14
5.1	Power via USB Interface	14
5.2	Standby- / Wake-up-by-Card-Mode	14
6	Indicators / LEDs	15
7	Installation notes	16
7.1	Metallic surroundings	16
7.2	EMC effects on cables.....	16
7.3	EMC effects from magnetic fields	17
8	Technical Data	18
9	Radio Approvals	20
9.1	Declaration of Conformity (CE), (UKCA), (PJM CPR40), (6633A-CPR40).....	20
9.2	USA (FCC) and Canada (IC)	20

1 Safety Instructions

- ▶ The device may only be used for the intended purpose designed by for the manufacturer.
- ▶ The operation manual should be conveniently kept available at all times for each user.
- ▶ Unauthorized changes and the use of spare parts and additional devices which have not been sold or recommended by the manufacturer may cause fire, electric shocks or injuries. Such unauthorized measures shall exclude any liability by the manufacturer.
- ▶ The liability-prescriptions of the manufacturer in the issue valid at the time of purchase are valid for the device. The manufacturer shall not be held legally responsible for inaccuracies, errors, or omissions in the manual or automatically set parameters for a device or for an incorrect application of a device.
- ▶ Repairs may only be executed by the manufacturer.
- ▶ Installation, operation, and maintenance procedures should only be carried out by qualified personnel.
- ▶ Use of the device and its installation must be in accordance with national legal requirements and local electrical codes.
- ▶ When working on devices the valid safety regulations must be observed.
- ▶ Before touching the device, the power supply must always be interrupted. Make sure that the device is without voltage by measuring. The fading of an operation control (LED) is no indicator for an interrupted power supply or the device being out of voltage!
- ▶ Special advice for wearers of cardiac pacemakers:
Although this device doesn't exceed the valid limits for electromagnetic fields you should keep a minimum distance of 25 cm between the device and your cardiac pacemaker and not stay in the immediate proximity of the device's antenna for any length of time.

2 Characterization ID CPR74

The reader modules ID CPR74 are designed for data exchange (read and write) with passive transponder according ISO14443 type A and type B, ISO15693, ISO18000-3M3 and are capable for communication with NFC devices (ISO18092). The small dimensions and the different available interfaces (RS232-TTL or USB) make it suitable for an easy integration into terminals, housings and other devices.

The following different types of reader modules are available:

	ID CPR74-4SCUSB	ID CPR74-CUSB
Dimensions L x B x H	50 mm x 68 mm x 10 mm	50 mm x 68 mm x 8 mm
Power supply	5 V DC \pm 5 %	
Antenna:		
internal	●	●
external	●	●
SAM Socket	4	-
Digital outputs	3	
Interface		
● RS232-TTL	●	
● USB full-speed (12Mbit/s)	●	

The variant ID CPR74-4SCUSB is equipped with 4 sockets for Security Access Modules (SAM) in the ID000 format. Because of the SAM current consumption the reader module is designed as Self-Powered-Device and need a separate power supply. The voltage supply from a USB port is not sufficient in this case.

Because of their high performance and a wide range of different configuration parameters the reader modules ID CPR74 is suitable for a lot of applications like eTicketing, ePayment, eDocument, eMobility and medical devices.

With the help of the integrated antenna multiplexer an external antenna can be used additional to the internal antenna. In Scan Mode the reader can switch between both antenna automatically.

The implemented SoftCrypto and SAMCrypto high level functions offer a comfortable and fast interface for the access to the encrypted data of an mifare Desfire, mifare Plus or mifare Ultralight transponder.

The reader module with a corresponding external antenna is ready for a EMVCo Contactless Level 1 certification as well as a VDV-KA certification (corresponding to BSI TR-03105 Part 4) or in the future CEN/TS 16794 approval.

The certification suitability need to be evaluate for each individual case because of the used external antenna and the installation situation.

The SAM Sockets have been approved according the EMVCo Contact Level 1 and they are eligible for the certification.

2.1 Scope of delivery

The delivery contains the following parts:

- 1 x RFID Reader module ID CPR74

2.2 Available Accessories

Tab. 1 Available Accessories and spare parts

Part Number	Part name	Description
3674.000.00	ID ISC.ANT40/30-U.FL-A	50 Ohm Antennae with U.FL-connector for the connection on the ID CPR74 Dimensions: 40 mm x 30 mm
3673.000.00	ID ISC.ANT100/100-U.FL-A	50 Ohm Antennae with U.FL-connector for the connection on the ID CPR74 Dimensions: 100 mm x 100 mm
3540.000.00	ID ISC.ANT.C05-A	50 Ohm Antenna cable with U.FL connector on both sides for the connection of an external antenna on the ID CPR74 Dimension : 500 mm; Color: black
3541.000.00	ID CAB.USB-B	USB-cable for the connection of the ID CPR74 on an external host Dimension: 2,75 m

2.3 Available Software Tools, USB Driver and Firmware

The USB driver and the test and configuration tool "CPRStart" and in future "ISOSTart+" are available on our Feig download area:

<https://www.feig.de/en/login/>

Username: CPR74

Password : FE900

For firmware updates we are providing a Firmware Update Tool and a external firmware xml-file.

3 Dimensions

The ID CPR74 reader module has been designed for the integration into terminals, printers or handheld devices and so on.

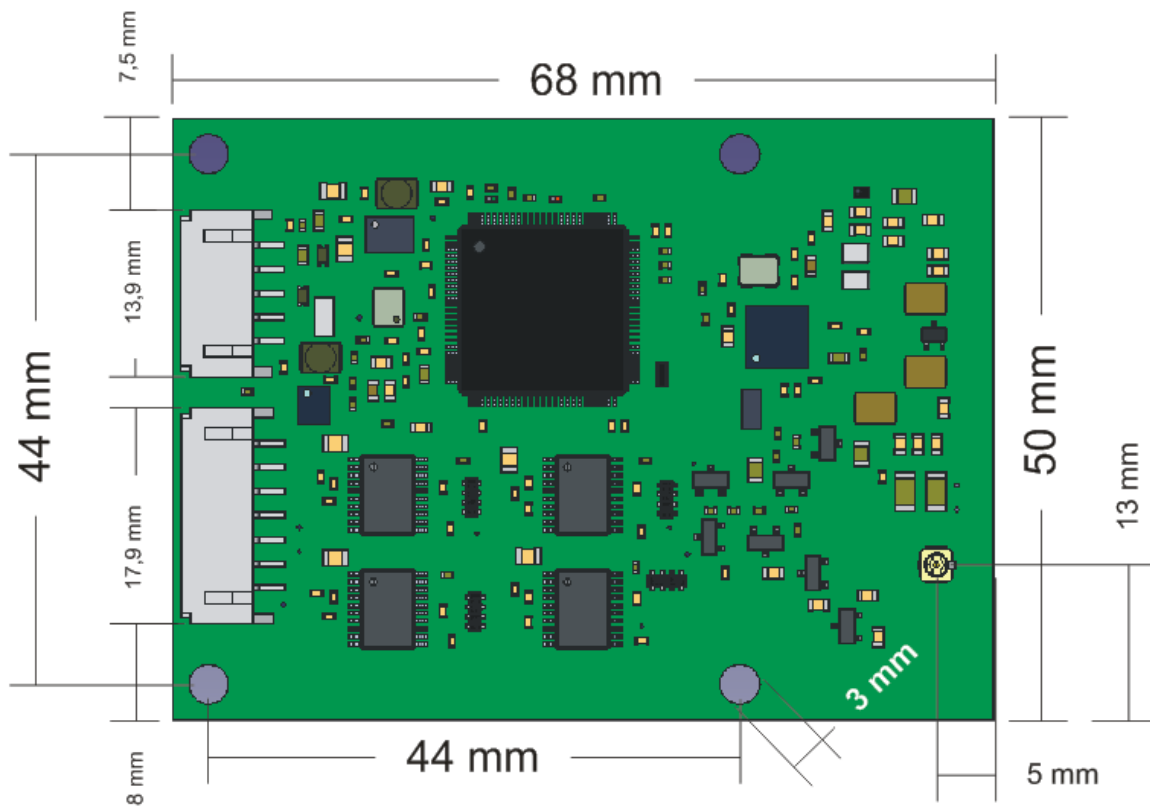

Figure 1: Dimension (Top View)

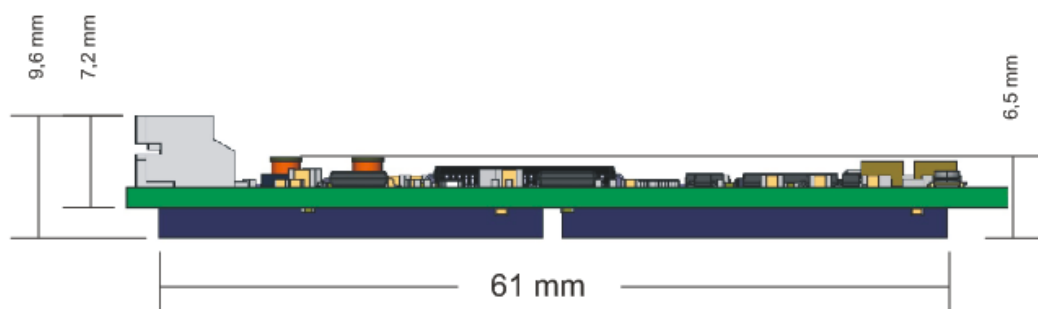

Figure 2: Dimension (Side View)

4 Installation and wiring

4.1 Connector X1, X2

The reader can be connected to a RS232-TTL interface and the power supply by using the multi-pin connector X1. The multi-pin connector X2 provide the connection for the USB interface. The device with SAM Sockets is a self-powered USB device which requires a separate power supply.

The following figure 4 and the table shows the assignment of the pins X1 (7pol.) and X2 (5pol.) Typ "JST PH" RM 2 mm (horizontal).

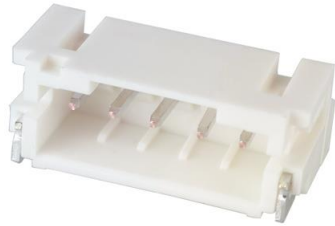

Figure 3: Plug „JST PH“

X2

X1

1

5

1

7



Figure 4: ID CPR74 - plug and connections

Tab. 2 Assignment of the pins on X1 and X2

X1 Pin-No.	Symbol	ID CPR74
1	OUT1	Digital Output 1
2	OUT2	Digital Output 2
3	OUT3	Digital Output 3
4	GND*	
5	RxD	RS232-TTL
6	TxD	RS232-TTL
7	VCC**	+ 5 V DC \pm 5 %
X2 Pin-No.		
1	Shielding	USB-Cable Shielding
2	GND*	
3	USB-D PLUS	
4	USB-D MINUS	
5	VCC**	+ 5 V DC \pm 5 %

* GND are connected internal directly

** VCC are connected internal directly. Feed-In VCC only at one pin! This is especially important if the reader is connected to a USB port. Please take care!

NOTICE:

- **Only one host interface can be used at the same time. Using several host interfaces at the same time can force malfunctions.**
- **The reader has to be supplied by a limited power supply according to EN 62368-1 PS1, only!**
- **Use only regulated power supply's.**
- **The connection cable (RS232TTL, USB, VCC) should be as short as possible and must be shorter than 3 m to reduce the influence of noise.**
- **Reversing the polarity of the supply voltage may destroy the device.**
- **Supply voltages outside the specifications may destroy the device.**
- **If switching power supplies are used with the module, be sure that there is adequate filtering.**
- **Noise from the power supply can result in a reduction of the read/write range of the module.**

4.2 Digital Outputs

The Figure 5 shows the circuit diagram of the digital outputs OUT1 – OUT3. The digital outputs are intended for the connection of external LED's.

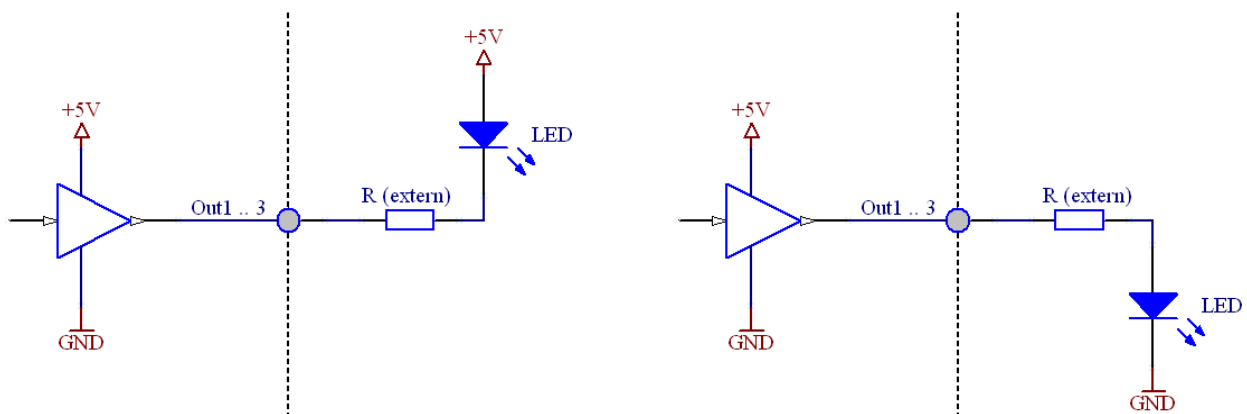

Figure 5: Wiring of digital outputs OUT1...3

4.3 Connection of an external Antenna

The ID CPR74 modules are equipped with an internal 50 Ω -antenna and have an additionally connector for an external 50 Ω -antenna.

In Scan mode it is possible to switch between the two antennas automatically. In the ISOHost Mode the switching of the antenna can be performed by commands.

The use of the external antenna is configurable in the reader settings.

The connection of the external antenna is possible via the U.FL connector „ANT“. Optional it is possible to integrate a 2-pin SMD connector (spacing 2,54 mm) on position X6.

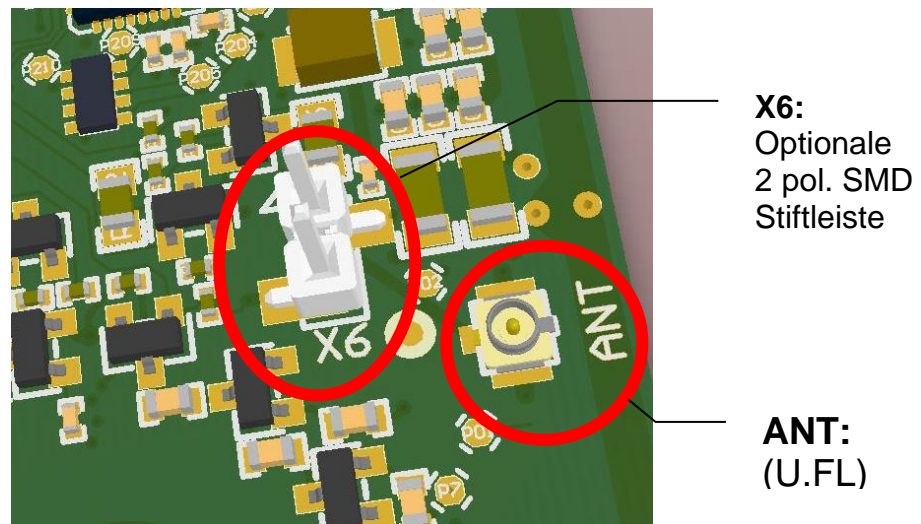

Figure 6: Connection of an external antenna

The technical description and hints for building external 50 Ω -antennas can be taken from the application note N20901-#d-ID-B.pdf.

Name	Description
ANT	Subminiature – Coaxial connector for an external 50 Ω -antenna
X6	Optional 2pin. connector for an external 50 Ω -antenna

NOTICE:

- Only for use with 50 Ω matched external antennas. The permanent usage of unmatched antennas can damage the reader electronic.
- The antenna output is neither permanent short circuit protected nor permanent no-load protected.
- The antenna cable should be no longer than 1m. The use of other cable length are possible after consulting the manufacturer.

4.4 SAM Slots

Figure 7 shows the position of the 4 SAM slots (S1-4). Each SAM slot is designed for a ID000 formatted SAM Card.

NOTICE

- *Wrong inserted SAM cards and forcefully opening or closing can damage the SAM slot. See chapter: [Installation of a SAM Card in a SAM](#)*

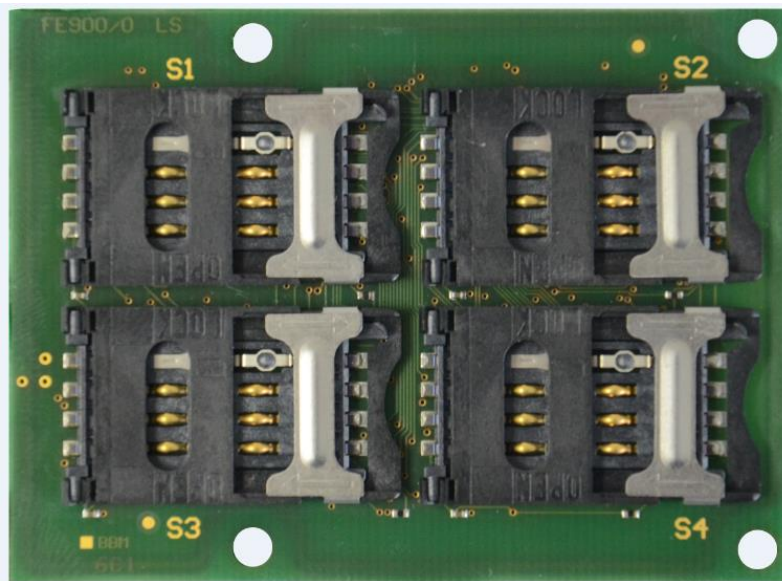

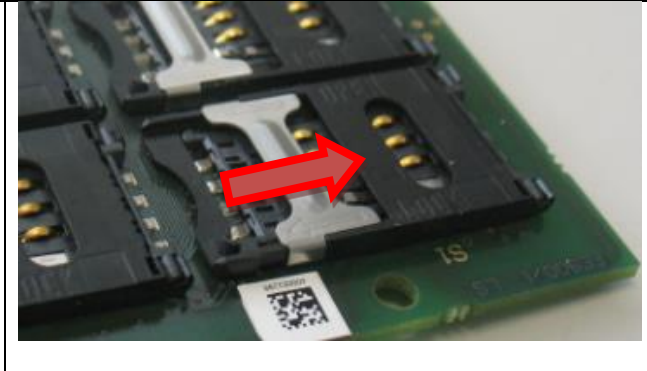

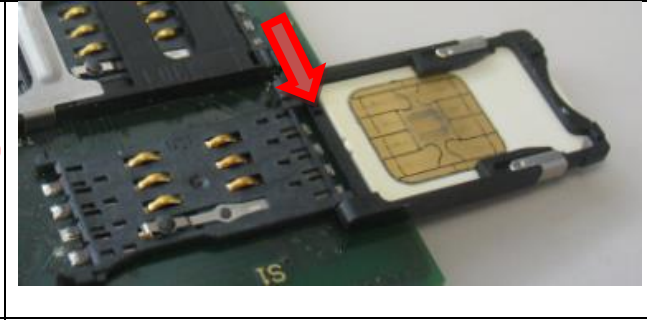
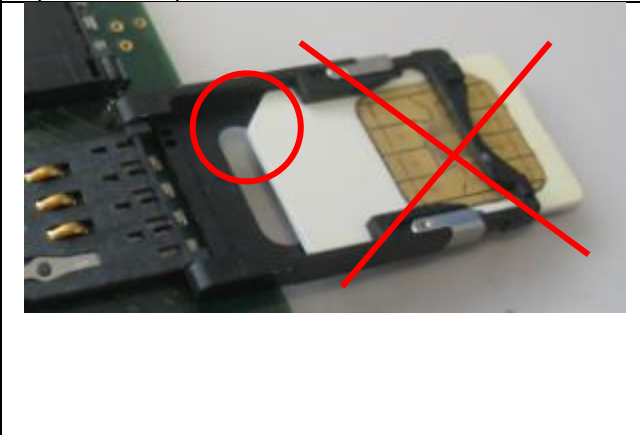
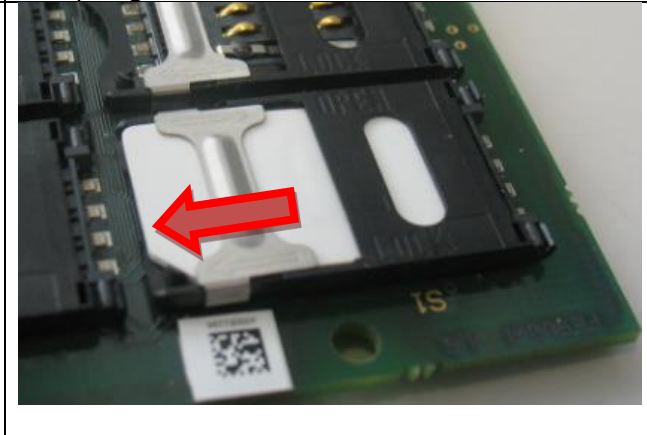

Figure 7: Position of the 4 SAM Sockets

4.4.1 Installation of a SAM Card in a SAM Socket

The following step by step instruction shows the installation of a SAM Card into the SAM socket S1.

	
<p>1. Closed SAM socket without SAM card.</p>	<p>2. Push the latch to the right side and open the cover carefully.</p>
	
<p>3. Put the SAM card into the cover. The contact plate face up and the beveled corner outside</p>	<p>4. The SAM card must be pushed up against the stop angle.</p>
	
<p>5. The SAM card must not be inserted with the beveled corner first.</p>	<p>6. Close the top cover with carefully pressure to snap into place. Push the latch to the left side.</p>

5 Power supply

The reader ID CPR74-SCUSB with 4 SAM slots is designed as a “Self-Powered USB Device” and needs an additional 5 V DC power supply.

The power supply must meet the following specification:

+5 V DC \pm 5 %

Ripple:

0...250 kHz < 10 mVpp

from 250 kHz < 0,1 mVpp

Note:

- ***On both device variants you need to take care that the voltage supply of the USB port is not connected in the case if an external power supply is connected.***

5.1 Power via USB Interface

The reader ID CPR74-CUSB (without SAM-Sockets) can be optional powered via a High Powered USB port (500mA).

5.2 Standby- / Wake-up-by-Card-Mode

The Standby mode or the Wake-up-by-Card function can be configured in the reader configuration. See system manual „H60410-xe-ID-B.pdf“.

NOTICE:

- ***The reader can be set into the Standby mode or the Wake-up-by-Card mode with the command 0x64 System Reset, see system manual H60410-xe-ID-B. The command can be executed via the RS232-TTL interface only and not via the USB interface.***

6 Indicators / LEDs

The reader modules has two LED indicators on board (green and red)

After power on or after a CPU Reset both LED's starts blinking synchronously for about 2s. While operation the LED's signalizes the following operating status:

LED - green

flashes

→ Reader is ready for operation but has no host communication

shine:

→ Polling-Mode: Reader is ready for work and has communication with the host.

→ Scan-Mode: Reader is working in Scan-Mode.

LED - rot

Communication with the Transponder (Tag detect).

The picture shows the position of the green and red LED.

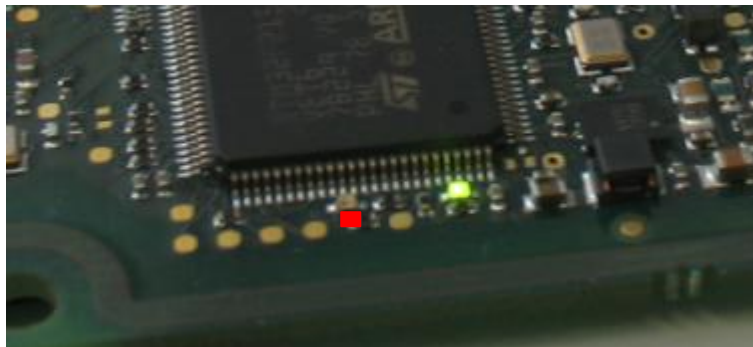

Figure 8: Position of the green and red LED

7 Installation notes

Be aware of the following possible environmental factors when installing an ID CPR74 into another device :

- Effects from nearby metal objects
 - ⇒ Detuning of the integrated antenna
 - ⇒ Impaired communication of the antenna's magnetic field
- EMC effects on cables
 - ⇒ Impaired communication between reader and transponder
- EMC effects from magnetic fields
 - ⇒ Impaired communication between reader and transponder

7.1 Metallic surroundings

When installing an ID CPR74 into another device, be sure that there are no metal surfaces or objects in the direct vicinity of the reader if possible. These can detune the antenna and thus reduce the magnetic field of the integrated antenna. This will in turn result in reduced read distances for the reader.

The distance between the reader and a metal surface should be at least 3 cm. Note that even other circuit boards may act like metal objects depending on how much copper they contain.

If a metallic surrounding cannot be avoided, stable function should at least be ensured by keeping the distance as great as possible.

The area between the antenna and transponder as well as the area on the other side of the transponder should also be kept clear of metal parts.

Since any change in the metallic environment will result in detuning of the integrated antenna and therefore to impaired function, no moving metal parts, such as metallic fans, should be allowed in the vicinity of the reader.

7.2 EMC effects on cables

In spite of the internal EMC filters inside the reader, high levels of noise on the supply voltage can result in impairment of the communication between the reader and transponder.

When installing an ID CPR74 into another device, be sure therefore that a clean, noise-free power supply is used.

7.3 EMC effects from magnetic fields

The communication principle of RFID- Technology is based on the modulation of electromagnetic fields. Alternating magnetic fields in the vicinity of the antenna can have a negative influence on the reader function.

Sources of such magnetic interference fields include coils within a primary or secondary switching power supply.

When determining the position of the reader and antenna within a device, check the device for any possible sources of interference as described above. If necessary, use shielding to suppress such interference.

8 Technical Data



Tab. 3: Technical data

		ID CPR74
Weight		approx. 20 g
Temperature Range	Operating	-25 °C up to +70 °C (-13 °F up to +158 °F)
	Storage	-40 °C up to +85 °C (-40 °F up to +185 °F)
Humidity		max. 95 % (not condensing)
MTBF		500 000 h
Power Supply		+5 V DC ± 5 % Ripple: 0...250 kHz < 10 mVpp from 250 kHz < 0,1 mVpp
Current Consumption		< 500 mA (without SAM) Standby-Mode/Sleep-Mode
Interfaces	USB	Full-Speed (12 Mbit/s), Self-Powered Device
	RS232-TTL	4 800 – 230 400 Baud
Driver		Windows Server 2012 and 2016 Windows 7, 8 and 10 32/64 Bit
Software Development Kits		Windows (C++, .NET, Java), Linux (C++, Java), Raspberry Pi
I/Os		3 digital outputs; max. 20 mA 2 LED's (green, red)
RFID Interface		ISO 14443-A/B (106 ... 848 kBit/s) ISO 15693, ISO 18000-3M3
Operating Frequency		13,56 MHz
Output Power		450 mW
Antenna Connection		U.FL-Socket for external antenna
Supported Transponder Types (contactless)		ISO/IEC 14443-4, mifare® classic, mifare® UltraLight, mifare® DESFire, mifare® PLUS, mifare® UltraLight C, my-d® move, Jewel™, FeliCa. Tag-It HFI, Fujitsu MB89R11x, STM24LRx, STMLR12k, I-Code SLI/SLIX, I-Code ILT NFC Devices in Card Emulation Mode (Tag Type 1...4), NFC Peer-to-Peer (P2P)
Contact Interface		4 SAM-Module (size ID000) according to ISO 7816 T=0 and T=1 Protocol, Power Class A, B & C

Operating Modes		ISOHost Mode (Polling Mode), Scan-Mode
Radio Approval	Europe	EN 300 330
	UK	EN 300 330
	USA	FCC 47 CFR Part 15
	Canada	IC RSS-210
EMV		EN 301 489 ISO 11452-2/-4 (Functional status C)
Safety and Health		EN 62368-1 EN 50364
Waste and Hazardous Substances		WEEE - 2002/96/EC RoHS - 2011/65/EC
Miscellaneous		Tested according EMVCo Contact Level 1 Certification suitability according EMVCo Contactless Level 1, VDV-KA,ITSO and in the future CEN/TS 16794 (see chapter: Characterization ID CPR74)

9 Radio Approvals

9.1 Declaration of Conformity (CE), (UKCA), (PJM CPR40), (6633A-CPR40)

	<p>CE Konformitätserklärung</p> <p>Hiermit erklärt FEIG ELECTRONIC GmbH, dass der Funkanlagentyp ID CPR74 der Richtlinie 2014/53/EU entspricht.</p> <p>Der vollständige Text der EU-Konformitätserklärung ist unter der folgenden Internetadresse verfügbar: https://www.feig.de/en/service/eu-declarations-of-conformity/</p>	<p>CE Declaration of Conformity</p> <p>Hereby FEIG ELECTRONIC GmbH declares that the radio equipment type ID CPR74 is in compliance with directive 2014/53/EU.</p> <p>The full text of the EU declaration of conformity is available at the following internet address: https://www.feig.de/en/service/eu-declarations-of-conformity/</p>
	<p>UKCA Declaration of Conformity</p> <p>Hereby FEIG ELECTRONIC GmbH declares that the radio equipment type ID ID CPR74 is in compliance with directive No. 1206 Radio Equipment Regulations 2017.</p> <p>The full text of the UKCA declaration of conformity is available at the following internet address: https://www.feig.de/en/service/ukca-declarations-of-conformity/</p>	

9.2 USA (FCC) and Canada (IC)

Product name:	ID CPR74
FCC ID:	PJM CPR74
IC:	6633A-CPR74
Notice for USA and Canada	<p>This device complies with Part 15 of the FCC Rules and with RSS-210 of Industry Canada.</p> <p>Operation is subject to the following two conditions.</p> <p>(1) this device may not cause harmful interference, and</p> <p>(2) this device must accept any interference received, including interference that may cause undesired operation.</p> <p>Unauthorized modifications may void the authority granted under Federal communications Commission Rules permitting the operation of this device.</p> <p>This equipment has been tested and found to comply with the limits for a Class A digital device, pursuant to Part 15 of the FCC Rules. These limits are designed to provide reasonable protection against harmful interference when the equipment is operated in a commercial environment. This equipment generates, uses, and can radiate radio frequency energy and, if not installed and used in accordance with the instruction manual, may cause harmful interference to radio communications. Operation of this equipment in a residential area is likely to cause harmful interference in which case the user will be required to correct the interference at his own expense.</p> <p>Le présent appareil est conforme aux CNR d'Industrie Canada applicables aux appareils radio exempts de licence. L'exploitation est autorisée aux deux conditions suivantes :</p> <p>(1) l'appareil ne doit pas produire de brouillage, et</p> <p>(2) l'utilisateur de l'appareil doit accepter tout brouillage radioélectrique subi, même si le brouillage est susceptible d'en compromettre le fonctionnement.</p>
<p>Warning: Changes or modification made to this equipment not expressly approved by FEIG ELECTRONIC GmbH may void the FCC authorization to operate this equipment.</p>	

Installation with FCC / IC Approval:

FCC-/IC-NOTICE: To comply with FCC Part 15 Rules in the United States / with IC Radio Standards in Canada, the system must be professionally installed to ensure compliance with the Part 15 certification / IC certification. It is the responsibility of the operator and professional installer to ensure that only certified systems are deployed in the United States / Canada.