

# TEST REPORT

Test report no.: 1-2432/16-01-03-A



## Testing laboratory

**CETECOM ICT Services GmbH**  
 Untertuerkheimer Strasse 6 – 10  
 66117 Saarbruecken / Germany  
 Phone: + 49 681 5 98 - 0  
 Fax: + 49 681 5 98 - 9075  
 Internet: <http://www.cetecom.com>  
 e-mail: [ict@cetecom.com](mailto:ict@cetecom.com)

### Accredited Testing Laboratory:

The testing laboratory (area of testing) is accredited according to DIN EN ISO/IEC 17025 (2005) by the Deutsche Akkreditierungsstelle GmbH (DAKKS). The accreditation is valid for the scope of testing procedures as stated in the accreditation certificate with the registration number: D-PL-12076-01-01

## Applicant

**FEIG ELECTRONIC GmbH**  
 Lange Str. 4  
 35781 Weilburg-Waldhausen / GERMANY  
 Phone: +49 6471 31 09-0  
 Fax: +49 6471 310-999  
 Contact: Andreas Wennrich  
 e-mail: [andreas.wennrich@feig.de](mailto:andreas.wennrich@feig.de)  
 Phone: +49 6471 310-9468

## Manufacturer

**FEIG ELECTRONIC GmbH**  
 Lange Str. 4  
 35781 Weilburg-Waldhausen / GERMANY

## Test standard/s

47 CFR Part 15	Title 47 of the Code of Federal Regulations; Chapter I; Part 15 - Radio frequency devices
RSS - 210 Issue 8	Spectrum Management and Telecommunications Radio Standards Specification - Licence-exempt Radio Apparatus (All Frequency Bands): Category I Equipment
RSS - 210 Issue 8 Amendment 1	RSS-210, Amendment 1 — Licence-Exempt, Low-Power Radio Apparatus Operating in the Television Bands (February 2015)

For further applied test standards please refer to section 3 of this test report.

## Test Item

**Kind of test item:** RFID Reader  
**Model name:** CPR74  
**FCC ID:** PJMCPR74  
**IC:** 6633A-CPR74  
**Frequency:** 13.56 MHz  
**Technology tested:** RFID  
**Antenna:** Integrated loop antenna  
**Power supply:** 5.00 V DC by external power supply  
**Temperature range:** -25°C to +70°C

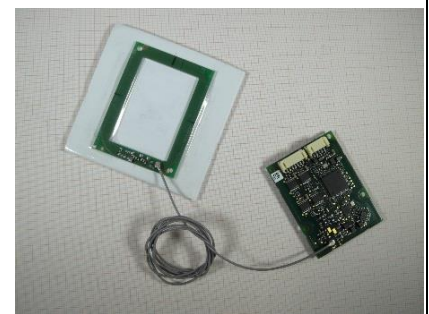

This test report is electronically signed and valid without handwriting signature. For verification of the electronic signatures, the public keys can be requested at the testing laboratory.

## Test report authorized:

Marco Bertolino  
 Lab Manager  
 Radio Communications & EMC

## Test performed:

Christoph Schneider  
 Testing Manager  
 Radio Communications & EMC

## 1 Table of contents

1	Table of contents .....	2
2	General information .....	3
2.1	Notes and disclaimer .....	3
2.2	Application details.....	3
3	Test standard/s and references .....	4
4	Test environment.....	5
5	Test item .....	5
5.1	General description .....	5
5.2	Additional information .....	5
6	Test laboratories sub-contracted .....	5
7	Description of the test setup .....	6
7.1	Shielded semi anechoic chamber .....	7
7.2	Shielded fully anechoic chamber .....	8
7.3	Frequency error .....	9
8	Sequence of testing .....	10
8.1	Sequence of testing radiated spurious 9 kHz to 30 MHz.....	10
8.2	Sequence of testing radiated spurious 30 MHz to 1 GHz.....	11
9	Measurement uncertainty .....	12
10	Summary of measurement results.....	13
11	Additional comments .....	13
12	Measurement results .....	14
12.1	Occupied bandwidth.....	14
12.2	Field strength of the fundamental .....	16
12.3	Field strength of the harmonics and spurious .....	17
12.4	Frequency error .....	21
13	Observations .....	29
Annex A	Document history .....	29
Annex B	Further information.....	29
Annex C	Accreditation Certificate .....	30

## 2 General information

### 2.1 Notes and disclaimer

The test results of this test report relate exclusively to the test item specified in this test report. CETECOM ICT Services GmbH does not assume responsibility for any conclusions and generalizations drawn from the test results with regard to other specimens or samples of the type of the equipment represented by the test item.

The test report may only be reproduced or published in full. Reproduction or publication of extracts from the report requires the prior written approval of CETECOM ICT Services GmbH.

The testing service provided by CETECOM ICT Services GmbH has been rendered under the current "General Terms and Conditions for CETECOM ICT Services GmbH".

CETECOM ICT Services GmbH will not be liable for any loss or damage resulting from false, inaccurate, inappropriate or incomplete product information provided by the customer.

Under no circumstances does the CETECOM ICT Services GmbH test report include any endorsement or warranty regarding the functionality, quality or performance of any other product or service provided.

Under no circumstances does the CETECOM ICT Services GmbH test report include or imply any product or service warranties from CETECOM ICT Services GmbH, including, without limitation, any implied warranties of merchantability, fitness for purpose, or non-infringement, all of which are expressly disclaimed by CETECOM ICT Services GmbH.

All rights and remedies regarding vendor's products and services for which CETECOM ICT Services GmbH has prepared this test report shall be provided by the party offering such products or services and not by CETECOM ICT Services GmbH.

In no case this test report can be considered as a Letter of Approval.

This test report is electronically signed and valid without handwritten signature. For verification of the electronic signatures, the public keys can be requested at the testing laboratory.

**This test report replaces the test report with the number 1-2432/16-01-03 and dated 2016-10-13.**

### 2.2 Application details

Date of receipt of order:	2016-09-07
Date of receipt of test item:	2016-09-08
Start of test:	2016-09-13
End of test:	2016-09-14
Person(s) present during the test:	-/-

### 3 Test standard/s and references

Test standard	Date	Description
47 CFR Part 15	-/-	Title 47 of the Code of Federal Regulations; Chapter I; Part 15 - Radio frequency devices
RSS - 210 Issue 8	December 2010	Spectrum Management and Telecommunications Radio Standards Specification - Licence-exempt Radio Apparatus (All Frequency Bands): Category I Equipment
RSS - 210 Issue 8 Amendment 1	February 2015	RSS-210, Amendment 1 — Licence-Exempt, Low-Power Radio Apparatus Operating in the Television Bands (February 2015)

Guidance	Version	Description
ANSI C63.4-2014	-/-	American national standard for methods of measurement of radio-noise emissions from low-voltage electrical and electronic equipment in the range of 9 kHz to 40 GHz
ANSI C63.10-2013	-/-	American national standard of procedures for compliance testing of unlicensed wireless devices

## 4 Test environment

Temperature	:	T <sub>nom</sub> T <sub>max</sub> T <sub>min</sub>	+24 °C during room temperature tests +70 °C during high temperature tests -25 °C during low temperature tests
Relative humidity content	:		55 %
Barometric pressure	:		1021 hpa
Power supply	:	V <sub>nom</sub> V <sub>max</sub> V <sub>min</sub>	5.00 V DC by external power supply 5.25 V 4.75 V

## 5 Test item

### 5.1 General description

Kind of test item	:	RFID Reader
Type identification	:	CPR74
HMN	:	-/-
PMN	:	ID CPR74
HVIN	:	ID CPR74
FVIN	:	-/-
S/N serial number	:	-/-
HW hardware status	:	-/-
SW software status	:	-/-
Frequency	:	13.56 MHz
Type of radio transmission	:	single carrier
Use of frequency spectrum	:	
Type of modulation	:	N1N
Number of channels	:	1
Antenna	:	Integrated loop antenna
Power supply	:	5.0 V DC by external power supply
Temperature range	:	-25°C to +70°C

### 5.2 Additional information

The content of the following annexes is defined in the QA. It may be that not all of the listed annexes are necessary for this report, thus some values in between may be missing.

Test setup- and EUT-photos are included in test report: 1-2432/16-01-1\_AnnexB  
1-2432/16-01-1\_AnnexD

## 6 Test laboratories sub-contracted

None

## 7 Description of the test setup

Typically, the calibrations of the test apparatus are commissioned to and performed by an accredited calibration laboratory. The calibration intervals are determined in accordance with the DIN EN ISO/IEC 17025. In addition to the external calibrations, the laboratory executes comparison measurements with other calibrated test systems or effective verifications. Weekly chamber inspections and range calibrations are performed. Where possible, RF generating and signaling equipment as well as measuring receivers and analyzers are connected to an external high-precision 10 MHz reference (GPS-based or rubidium frequency standard).

In order to simplify the identification of the equipment used at some special tests, some items of test equipment and ancillaries can be provided with an identifier or number in the equipment list below (Lab/Item).

**Agenda:** Kind of Calibration

k	calibration / calibrated	EK	limited calibration
ne	not required (k, ev, izw, zw not required)	zw	cyclical maintenance (external cyclical maintenance)
ev	periodic self verification	izw	internal cyclical maintenance
Ve	long-term stability recognized	g	blocked for accredited testing
v/k!	Attention: extended calibration interval		
NK!	Attention: not calibrated	*)	next calibration ordered / currently in progress

## 7.1 Shielded semi anechoic chamber

The radiated measurements are performed in vertical and horizontal plane in the frequency range from 9 kHz to 1 GHz in semi-anechoic chambers. The EUT is positioned on a non-conductive support with a height of 0.80 m above a conductive ground plane that covers the whole chamber. The receiving antennas are confirmed with specifications ANSI C63. These antennas can be moved over the height range between 1.0 m and 4.0 m in order to search for maximum field strength emitted from EUT. The measurement distances between EUT and receiving antennas are indicated in the test setups for the various frequency ranges. For each measurement, the EUT is rotated in all three axes until the maximum field strength is received. The wanted and unwanted emissions are received by spectrum analyzers where the detector modes and resolution bandwidths over various frequency ranges are set according to requirement ANSI C63.

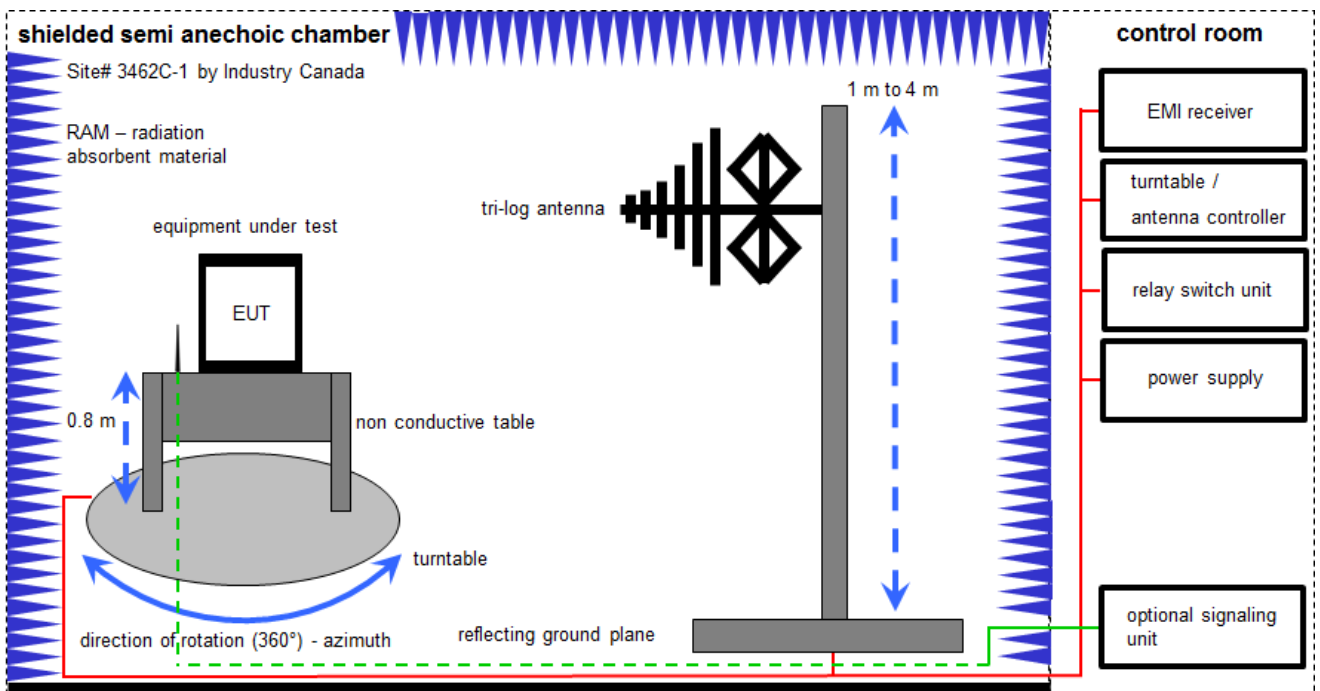

Measurement distance: tri-log antenna 10 meter

$$FS = UR + CL + AF$$

(FS-field strength; UR-voltage at the receiver; CL-loss of the cable; AF-antenna factor)

Example calculation:

$$FS [dB\mu V/m] = 12.35 [dB\mu V/m] + 1.90 [dB] + 16.80 [dB/m] = 31.05 [dB\mu V/m] (35.69 \mu V/m)$$

### Equipment table:

No.	Lab / Item	Equipment	Type	Manufacturer	Serial No.	INV. No Cetecom	Kind of Calibration	Last Calibration	Next Calibration
1	A	Switch-Unit	3488A	HP	2719A14505	300000368	ev	-/-	-/-
2	A	DC power supply, 60Vdc, 50A, 1200 W	6032A	HP	2920A04466	300000580	ne	-/-	-/-
3	A	EMI Test Receiver	ESCI 3	R&S	100083	300003312	k	08.03.2016	08.03.2017
4	A	Analyzer-Reference-System (Harmonics and Flicker)	ARS 16/1	SPS	A3509 07/0 0205	300003314	Ve	02.02.2016	02.02.2018
5	A	Antenna Tower	Model 2175	ETS-Lindgren	64762	300003745	izw	-/-	-/-
6	A	Positioning Controller	Model 2090	ETS-Lindgren	64672	300003746	izw	-/-	-/-
7	A	Turntable Interface-Box	Model 105637	ETS-Lindgren	44583	300003747	izw	-/-	-/-
8	A	TRILOG Broadband Test-Antenna 30 MHz - 3 GHz	VULB9163	Schwarzbeck	295	300003787	k	25.04.2016	25.04.2018
9	A	Spectrum-Analyzer	FSU26	R&S	200809	300003874	k	29.01.2016	29.01.2017

## 7.2 Shielded fully anechoic chamber

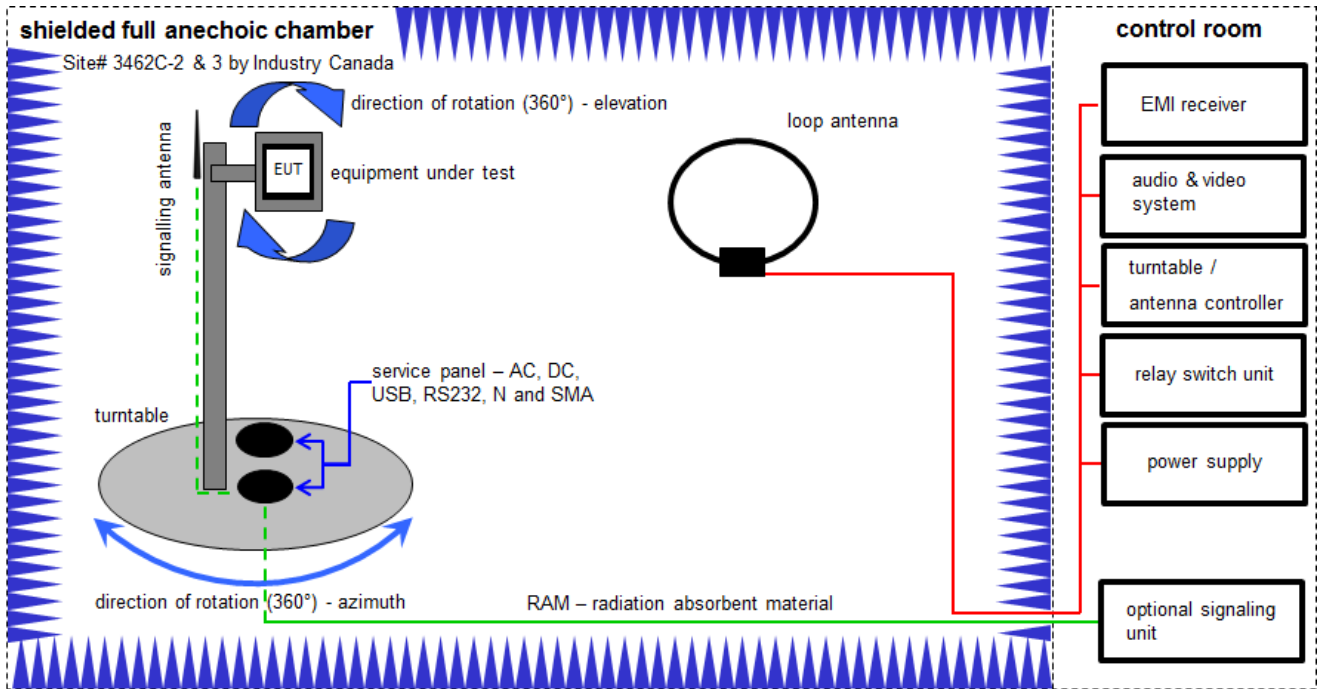

Measurement distance: loop antenna 3 meter

$$FS = UR + CA + AF$$

(FS-field strength; UR-voltage at the receiver; CA-loss of the signal path; AF-antenna factor)

Example calculation:

$$FS [dB\mu V/m] = 40.0 [dB\mu V/m] + (-35.8) [dB] + 32.9 [dB/m] = 37.1 [dB\mu V/m] (71.61 \mu V/m)$$

**Equipment table:**

No.	Lab / Item	Equipment	Type	Manufacturer	Serial No.	INV. No Cetecom	Kind of Calibration	Last Calibration	Next Calibration
1	A	DC power supply, 60Vdc, 50A, 1200 W	6032A	HP	2818A03450	300001040	Ve	20.01.2015	20.01.2018
2	A	Anechoic chamber	FAC 3/5m	MWB / TDK	87400/02	300000996	ev	-/-	-/-
3	A	Switch / Control Unit	3488A	HP	*	300000199	ne	-/-	-/-
4	A	Active Loop Antenna 10 kHz to 30 MHz	6502	EMCO/2	8905-2342	300000256	k	24.06.2015	24.06.2017
5	A	4U RF Switch Platform	L4491A	Agilent Technologies	MY50000037	300004509	ne	-/-	-/-
6	A	EMI Test Receiver 9kHz-26.5GHz	ESR26	R&S	101376	300005063	vIK!	13.09.2016	13.03.2018



### 7.3 Frequency error

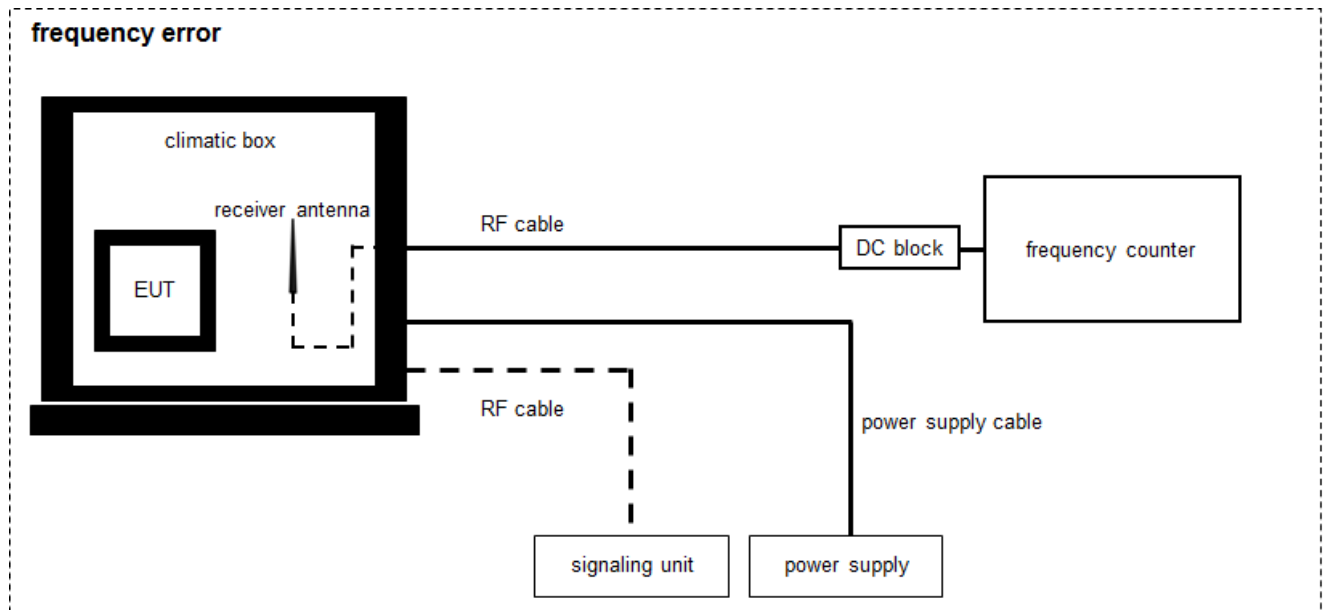

**Equipment table:**

No.	Lab / Item	Equipment	Type	Manufacturer	Serial No.	INV. No Cetecom	Kind of Calibration	Last Calibration	Next Calibration
1	A	DC Power Supply 0 - 32V	1108-32	Heiden Elektronik	001802	300001383	Ve	29.01.2014	29.01.2017
2	A	Temperature Test Chamber	T-40/50	CTS GmbH	064023	300003540	ev	03.09.2015	03.09.2017
3	A	EMI Test Receiver 9 kHz - 3 GHz incl. Preselector	ESPI3	R&S	101713	300004059	k	26.01.2016	26.01.2017
4	A	Loop Antenna	ESPI3	ZEG TS Steinfurt	101713	400001208	ev	-/-	-/-

## 8 Sequence of testing

### 8.1 Sequence of testing radiated spurious 9 kHz to 30 MHz

#### Setup

- The equipment is set up to simulate normal operation mode as described in the user manual or defined by the manufacturer.
- If the EUT is a tabletop system, a 2-axis positioner with 1.5 m height is used.
- If the EUT is a floor standing device, it is placed directly on the turn table.
- Auxiliary equipment and cables are positioned to simulate normal operation conditions as described in ANSI C 63.4.
- The AC power port of the EUT (if available) is connected to a power outlet below the turntable.
- Measurement distance is 3 m (see ANSI C 63.4) – see test details.
- EUT is set into operation.

#### Premeasurement

- The turntable rotates from 0° to 315° using 45° steps.
- The antenna height is 1.5 m.
- At each turntable position the analyzer sweeps with positive-peak detector to find the maximum of all emissions.

#### Final measurement

- Identified emissions during the premeasurement are maximized by the software by rotating the turntable from 0° to 360°. In case of the 2-axis positioner is used the elevation axis is also rotated from 0° to 360°.
- The final measurement is done in the position (turntable and elevation) causing the highest emissions with quasi-peak (as described in ANSI C 63.4).
- Final levels, frequency, measuring time, bandwidth, turntable position, correction factor, margin to the limit and limit will be recorded. A plot with the graph of the premeasurement and the limit is stored.

## 8.2 Sequence of testing radiated spurious 30 MHz to 1 GHz

### Setup

- The equipment is set up to simulate normal operation mode as described in the user manual or defined by the manufacturer.
- If the EUT is a tabletop system, a table with 0.8 m height is used, which is placed on the ground plane.
- If the EUT is a floor standing device, it is placed on the ground plane with insulation between both.
- Auxiliary equipment and cables are positioned to simulate normal operation conditions as described in ANSI C 63.4.
- The AC power port of the EUT (if available) is connected to a power outlet below the turntable.
- Measurement distance is 10 m or 3 m (see ANSI C 63.4) – see test details.
- EUT is set into operation.

### Premeasurement

- The turntable rotates from 0° to 315° using 45° steps.
- The antenna is polarized vertical and horizontal.
- The antenna height changes from 1 m to 3 m.
- At each turntable position, antenna polarization and height the analyzer sweeps three times in peak to find the maximum of all emissions.

### Final measurement

- The final measurement is performed for at least six highest peaks according to the requirements of the ANSI C63.4.
- Based on antenna and turntable positions at which the peak values are measured the software maximize the peaks by changing turntable position  $\pm 45^\circ$  and antenna height between 1 and 4 m.
- The final measurement is done with quasi-peak detector (as described in ANSI C 63.4).
- Final levels, frequency, measuring time, bandwidth, antenna height, antenna polarization, turntable angle, correction factor, margin to the limit and limit are recorded. A plot with the graph of the premeasurement with marked maximum final results and the limit is stored.

## 9 Measurement uncertainty

Measurement uncertainty	
Test case	Uncertainty
Occupied bandwidth	± used RBW
Field strength of the fundamental	± 3 dB
Field strength of the harmonics and spurious	± 3 dB
Receiver spurious emissions and cabinet radiations	± 3 dB
Conducted limits	± 2.6 dB

## 10 Summary of measurement results

<input checked="" type="checkbox"/>	No deviations from the technical specifications were ascertained
<input type="checkbox"/>	There were deviations from the technical specifications ascertained
<input type="checkbox"/>	This test report is only a partial test report. The content and verdict of the performed test cases are listed below.

TC Identifier	Description	Verdict	Date	Remark
RF-Testing	CFR Part 15 RSS 210 Issue 8 RSS Gen Issue 4	See table!	2016-10-25	-/-

Test specification clause	Test case	Temperature conditions	Power source conditions	C	NC	NA	NP	Remark
RSS Gen Issue 4	Occupied bandwidth	Nominal	Nominal	<input checked="" type="checkbox"/>	<input type="checkbox"/>	<input type="checkbox"/>	<input type="checkbox"/>	-/-
§ 15.225 (a)	Field strength of the fundamental	Nominal	Nominal	<input checked="" type="checkbox"/>	<input type="checkbox"/>	<input type="checkbox"/>	<input type="checkbox"/>	-/-
§ 15.209 & § 15.225 (b-d)	Field strength of the harmonics and spurious	Nominal	Nominal	<input checked="" type="checkbox"/>	<input type="checkbox"/>	<input type="checkbox"/>	<input type="checkbox"/>	-/-
§ 15.109	Receiver spurious emissions and cabinet radiations	Nominal	Nominal	<input type="checkbox"/>	<input type="checkbox"/>	<input checked="" type="checkbox"/>	<input type="checkbox"/>	-/-
§15.107 & §15.207	Conducted limits	Nominal	Nominal	<input type="checkbox"/>	<input type="checkbox"/>	<input checked="" type="checkbox"/>	<input type="checkbox"/>	-/-
§ 15.225 (a)	Frequency tolerance	Normal & extreme conditions	Normal & extreme conditions	<input checked="" type="checkbox"/>	<input type="checkbox"/>	<input type="checkbox"/>	<input type="checkbox"/>	-/-

**Note:**

- C Compliant
- NC Not compliant
- NA Not applicable
- NP Not performed

## 11 Additional comments

Reference documents: None

Special test descriptions: None

Configuration descriptions: None

## 12 Measurement results

### 12.1 Occupied bandwidth

**Measurement:**

The emission bandwidth (x dB) is defined as the frequency range between two points, one above and one below the carrier frequency, at which the spectral density of the emission is attenuated x dB below the maximum in-band spectral density of the modulated signal.

Measurement parameters	
Detector:	Peak
Resolution bandwidth:	1 % – 5 % of the occupied bandwidth
Video bandwidth:	≥ 3x RBW
Trace mode:	Max hold
Analyzer function:	99 % power function
Used equipment:	See chapter 7.3 A
Measurement uncertainty:	See chapter 9

**Limit:**

IC
for RSP-100 test report coversheet only

**Result:**

99% emission bandwidth
159.6 kHz

**Plot:**

**Plot 1: 99 % emission bandwidth**

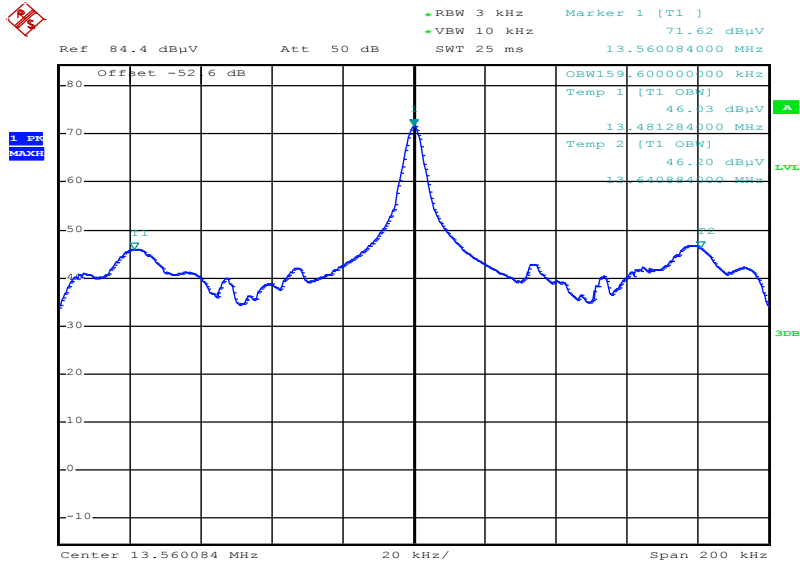

Date: 13.OCT.2016 10:25:22

## 12.2 Field strength of the fundamental

### Measurement:

The maximum detected field strength for the carrier signal.

Measurement parameters	
Detector:	Quasi peak / peak (worst case)
Resolution bandwidth:	120 kHz
Video bandwidth:	≥ 3x RBW
Trace mode:	Max hold
Used equipment:	See chapter 7.2 A
Measurement uncertainty:	See chapter 9

### Limit:

FCC & IC		
Frequency (MHz)	Field strength (μV/m)	Measurement distance (m)
13.553 to 13.567	15,848 (84 dBμV/m)	30

### Recalculation:

According to ANSI C63.10		
Frequency	Formula	Correction value
13.56 MHz	$FS_{limit} = FS_{max} - 40 \log\left(\frac{d_{nearfield}}{d_{measure}}\right) - 20 \log\left(\frac{d_{limit}}{d_{nearfield}}\right)$ <p> <math>FS_{limit}</math> is the calculation of field strength at the limit distance, expressed in dBμV/m  <math>FS_{max}</math> is the measured field strength, expressed in dBμV/m  <math>d_{nearfield}</math> is the <math>\lambda/2\pi</math> distance  <math>d_{measure}</math> is the distance of the measurement point from EUT  <math>d_{limit}</math> is the reference limit distance                 </p>	-21.39

### According to ANSI C63.10

### Result:

Field strength of the fundamental		
Frequency	13.56 MHz	
Distance	@ 3 m	@ 30 m
Measured / calculated value	75.9 dBμV/m	54.51 dBμV/m



### 12.3 Field strength of the harmonics and spurious

**Measurement:**

The maximum detected field strength for the harmonics and spurious.

Measurement parameters	
Detector:	Quasi peak / average or peak (worst case – pre-scan)
Resolution bandwidth:	F < 150 kHz: 200 Hz 150 kHz < F < 30 MHz: 9 kHz 30 MHz < F < 1 GHz: 120 kHz
Video bandwidth:	F < 150 kHz: 1 kHz 150 kHz < F < 30 MHz: 100 kHz 30 MHz < F < 1 GHz: 300 kHz
Trace mode:	Max hold
Used equipment:	See chapter 7.1 A / 7.2 A
Measurement uncertainty:	See chapter 9

**Limit:**

FCC & IC		
Frequency (MHz)	Field strength (dBµV/m)	Measurement distance (m)
0.009 – 0.490	2400/F(kHz)	300
0.490 – 1.705	24000/F(kHz)	30
1.705 – 30	30 (29.5 dBµV/m)	30
30 – 88	100 (40 dBµV/m)	3
88 – 216	150 (43.5 dBµV/m)	3
216 – 960	200 (46 dBµV/m)	3

**Note:** For a reduced measurement distance, please take a look at the limit line and the ANSI C63.10-2013 sub clause 6.4 radiated emissions from unlicensed wireless devices below 30 MHz.

**Result:**

Detected emissions			
Frequency (MHz)	Detector	Resolution bandwidth (kHz)	Detected value
See plots!			

**Plots:**

**Plot 1: 9 kHz – 30 MHz, magnetic emissions**

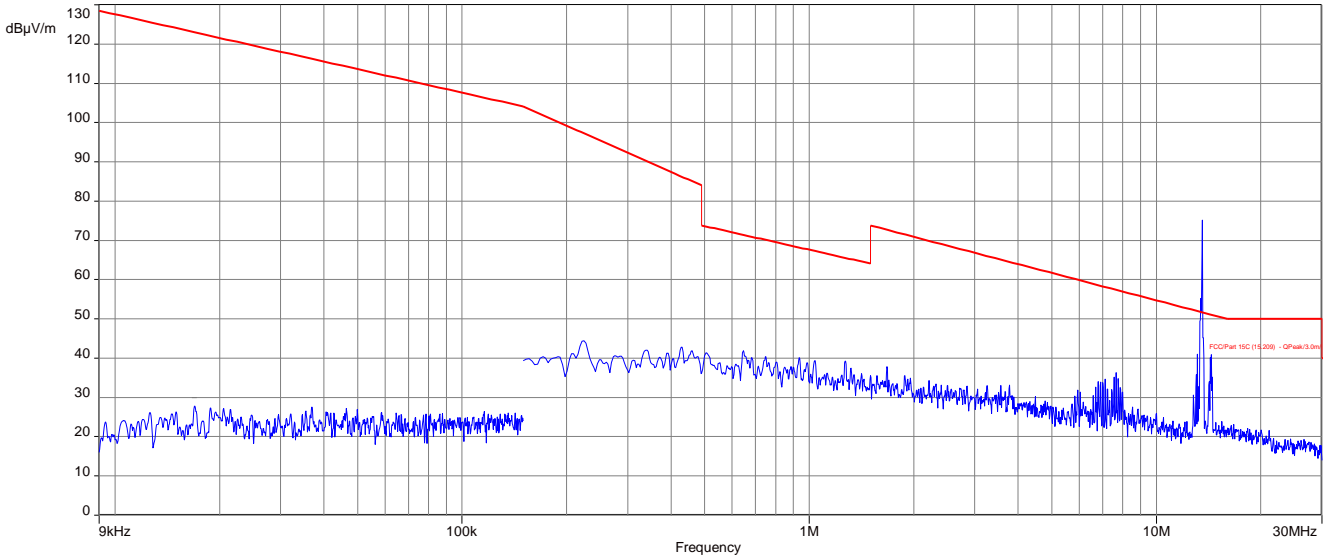

**Plot 2: Spectrum mask (the limits are recalculated according to the ANSI C63.10-2013 sub clause 6.4)**

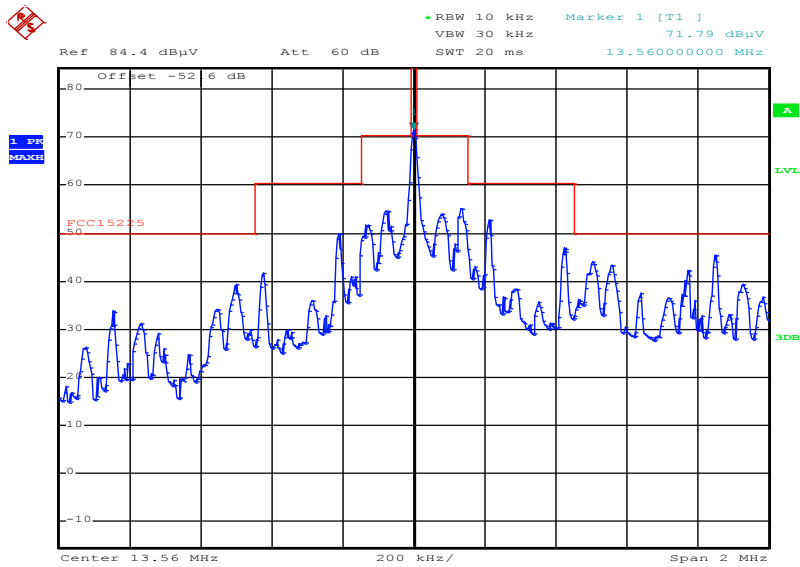

Date: 13.OCT.2016 07:02:54

Plot 3: Spectrum mask, detail

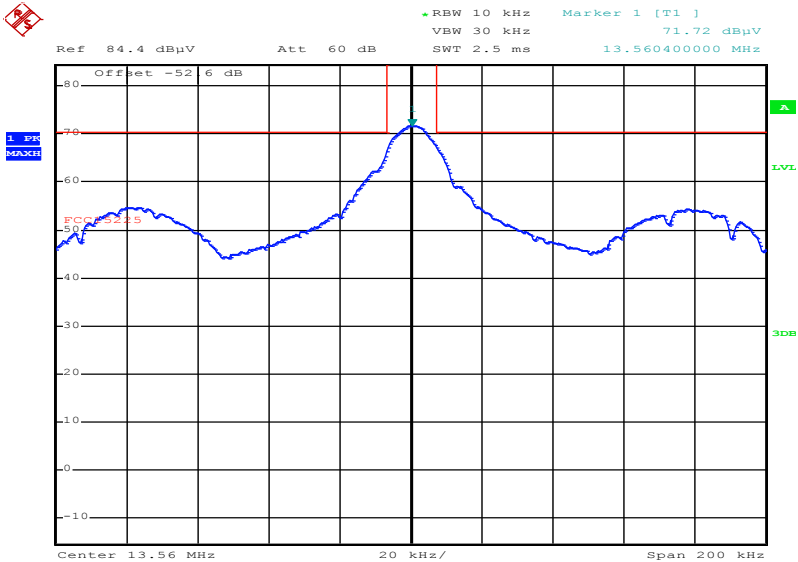

Date: 13.OCT.2016 07:03:41

**Plot 4:** 30 MHz – 1 GHz, vertical and horizontal polarization

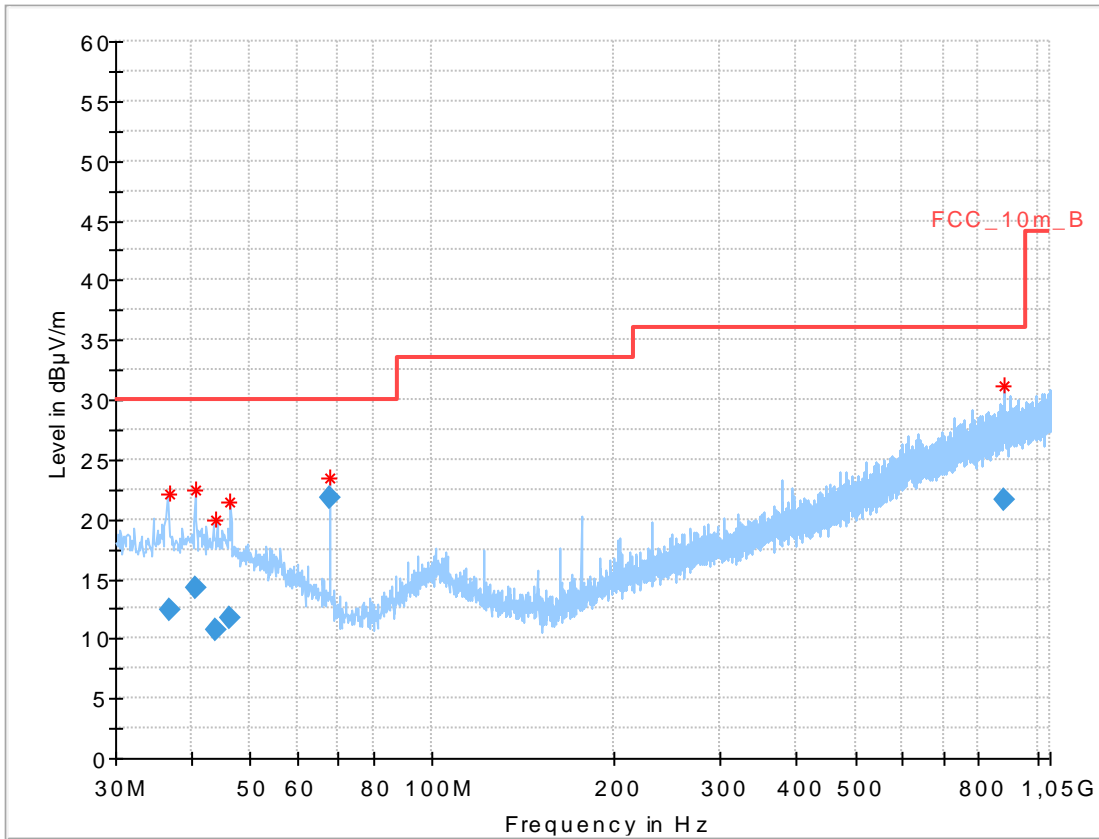

Frequency (MHz)	QuasiPeak (dBµV/m)	Limit (dBµV/m)	Margin (dB)	Meas. Time (ms)	Bandwidth (kHz)	Height (cm)	Pol	Azimuth (deg)	Corr. (dB)
36.902850	12.42	30.00	17.58	1000.0	120.000	178.0	V	117.0	13.9
40.654500	14.20	30.00	15.80	1000.0	120.000	103.0	V	269.0	14.0
43.999800	10.79	30.00	19.21	1000.0	120.000	101.0	V	161.0	13.9
46.144800	11.78	30.00	18.22	1000.0	120.000	104.0	V	53.0	13.6
67.816800	21.82	30.00	8.18	1000.0	120.000	272.0	V	140.0	8.9
878.991300	21.62	36.00	14.38	1000.0	120.000	200.0	H	320.0	23.8

## 12.4 Frequency error

### Measurement:

The maximum detected field strength for the spurious.

Measurement parameters	
Detector:	Peak detector
Resolution bandwidth:	30 Hz / 100 Hz
Video bandwidth:	> RBW
Trace mode:	Max hold
Used equipment:	See chapter 7.3 A
Measurement uncertainty:	See chapter 9

### Limit:

FCC
The frequency tolerance of the carrier signal shall be maintained within +/- 0.01% of the operating frequency over a temperature variation of -20 degrees to +50 degrees C at normal supply voltage, and for a variation in the primary supply voltage from 85% to 115% of the rated supply voltage at a temperature of 20 degrees C. ( $\pm 1.356$ kHz)

### Result: Temperature variation

Frequency tolerance		
Measured frequency (MHz)	Conditions	Result
13.560116	-25 °C & 100% voltage	compliant
13.560128	-20 °C & 100% voltage	compliant
13.560144	-10 °C & 100% voltage	compliant
13.560138	0 °C & 100% voltage	compliant
13.560122	+10 °C & 100% voltage	compliant
13.560102	+20 °C & 100% voltage	compliant
13.560084	+30 °C & 100% voltage	compliant
13.560084	+40 °C & 100% voltage	compliant
13.560102	+50 °C & 100% voltage	compliant
13.560152	+60 °C & 100% voltage	compliant
13.560220	+70 °C & 100% voltage	compliant

### Result: Voltage variation

Frequency tolerance		
Measured frequency (MHz)	Temperature	Result
13.560110	+20 °C & 85% voltage	compliant
13.560102	+20 °C & 100% voltage	compliant
13.560108	+20 °C & 115% voltage	compliant

**Plots:**

**Plot 1: 100% voltage; 70°C**

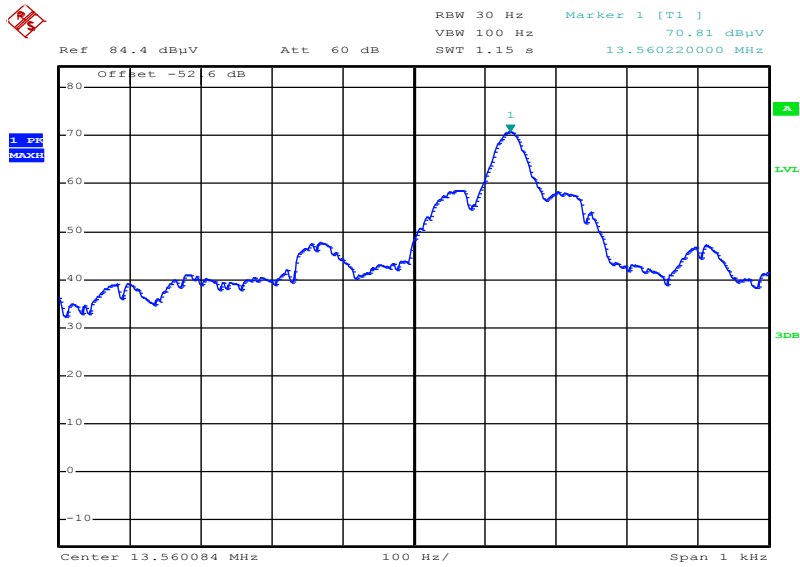

Date: 13.OCT.2016 09:27:06

**Plot 2: 100% voltage; 60°C**

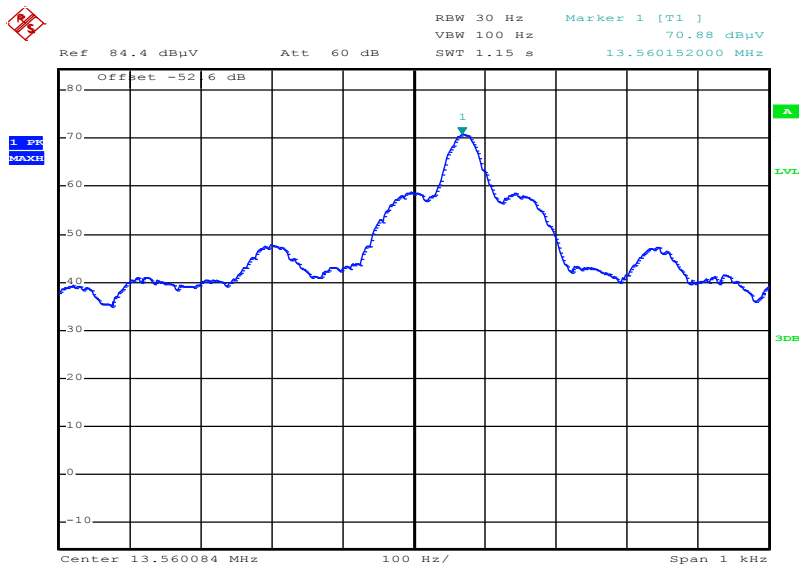

Date: 13.OCT.2016 09:13:29

Plot 3: 100% voltage; 50°C

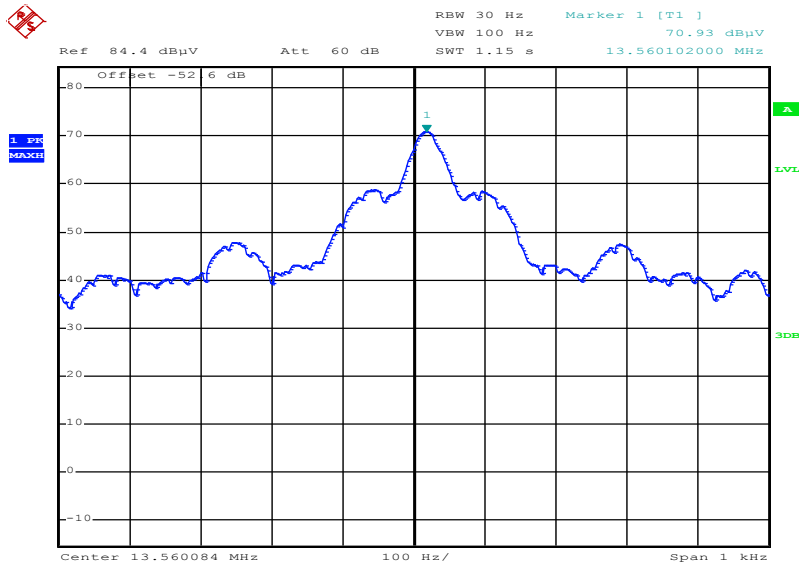

Date: 13.OCT.2016 08:48:51

Plot 4: 100% voltage; 40°C

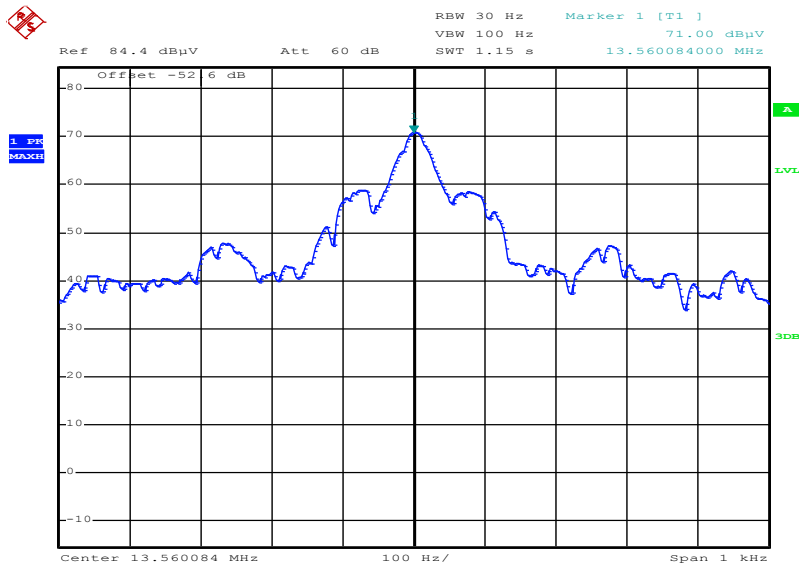

Date: 13.OCT.2016 08:30:27

Plot 5: 100% voltage; 30°C

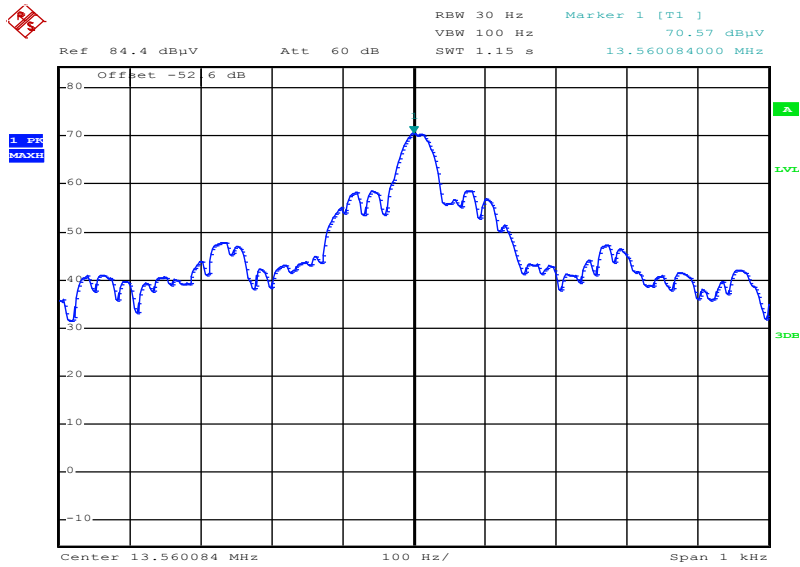

Date: 13.OCT.2016 08:21:02

Plot 6: 100% voltage; 20°C

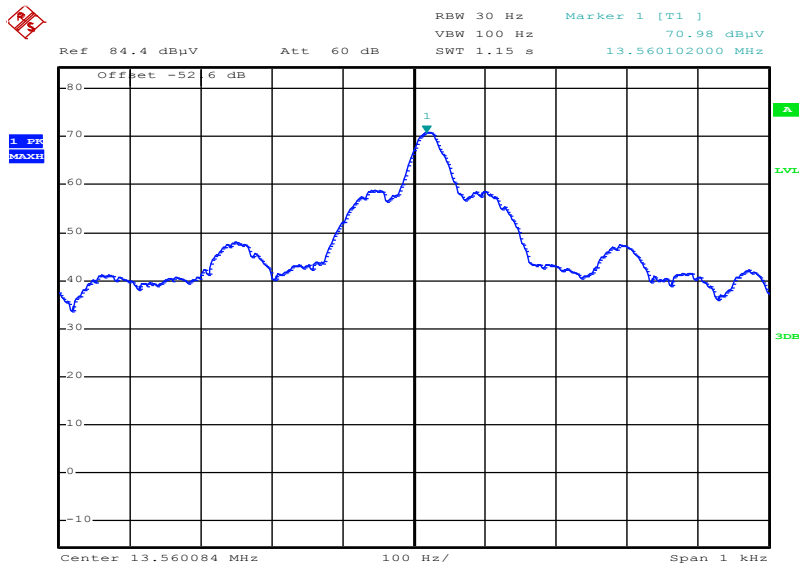

Date: 13.OCT.2016 08:09:29



Plot 7: 100% voltage; 10°C

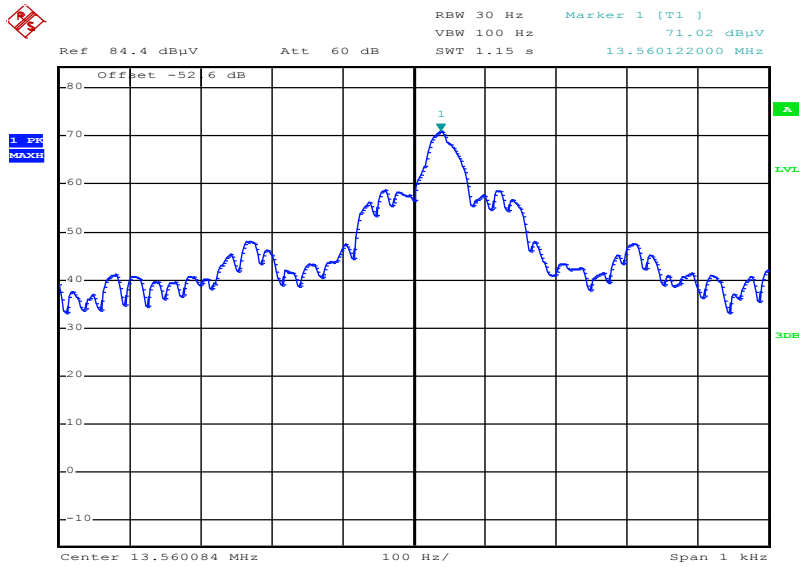

Date: 13.OCT.2016 07:58:14

Plot 8: 100% voltage; 0°C

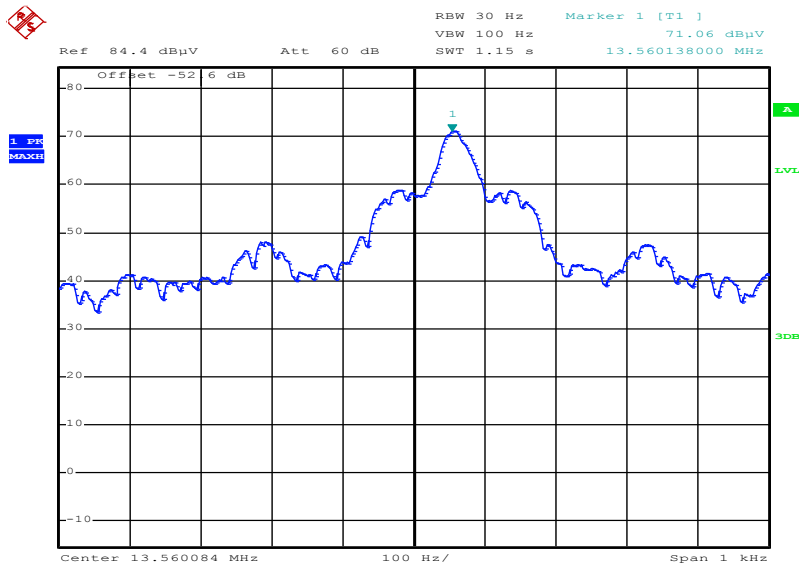

Date: 13.OCT.2016 07:49:49

Plot 9: 100% voltage; -10°C

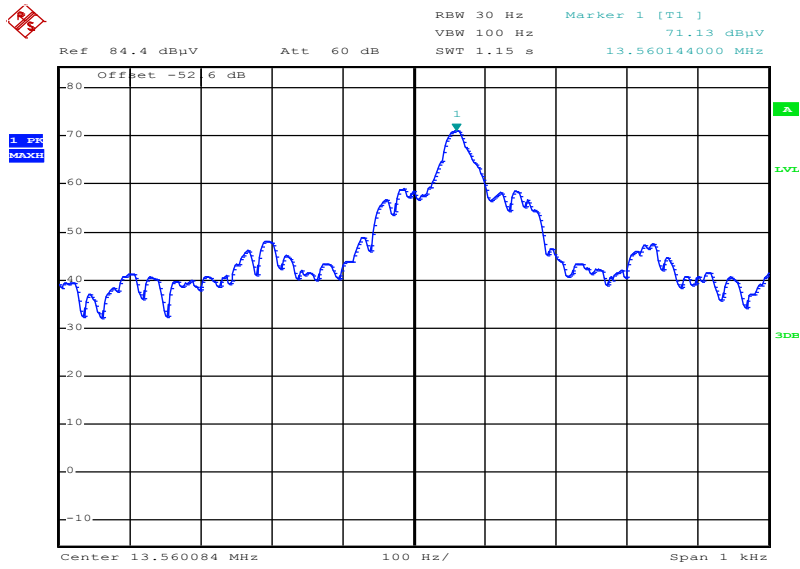

Date: 13.OCT.2016 07:45:06

Plot 10: 100% voltage; -20°C

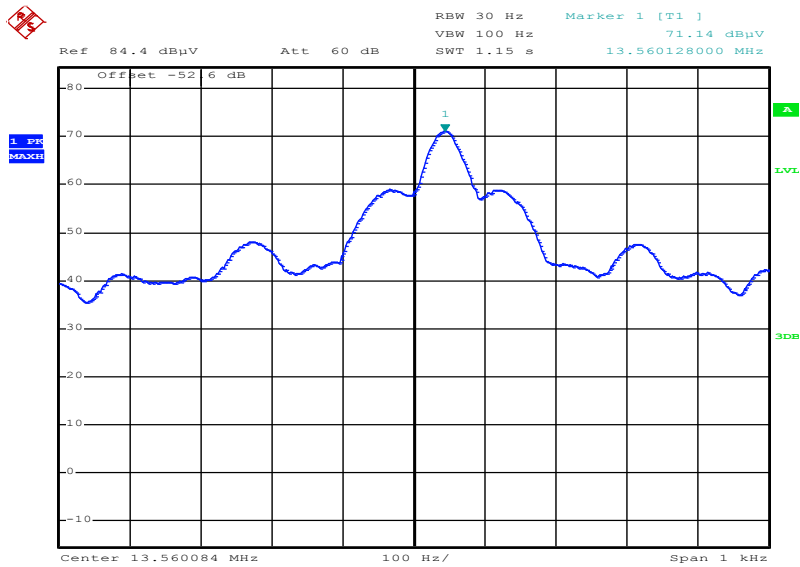

Date: 13.OCT.2016 07:35:04

Plot 11: 100% voltage; -25°C

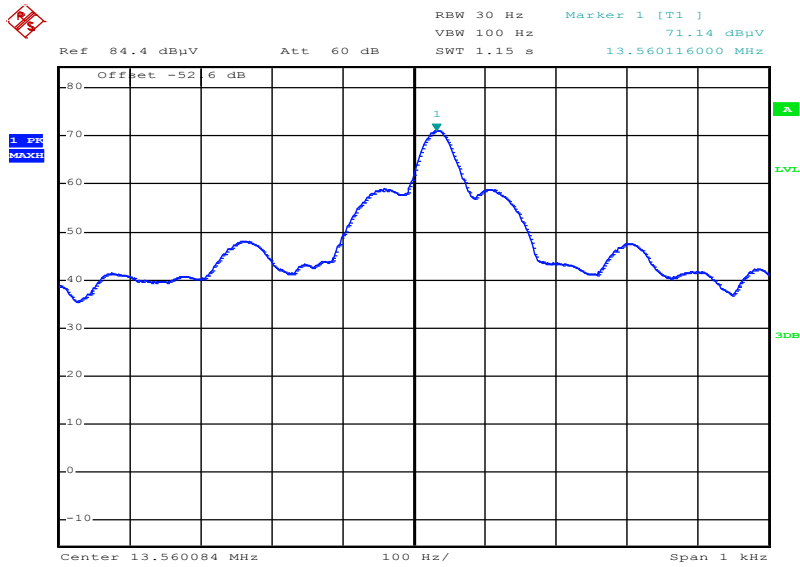

Date: 13.OCT.2016 07:32:40

Plot 12: 115% voltage; 20°C

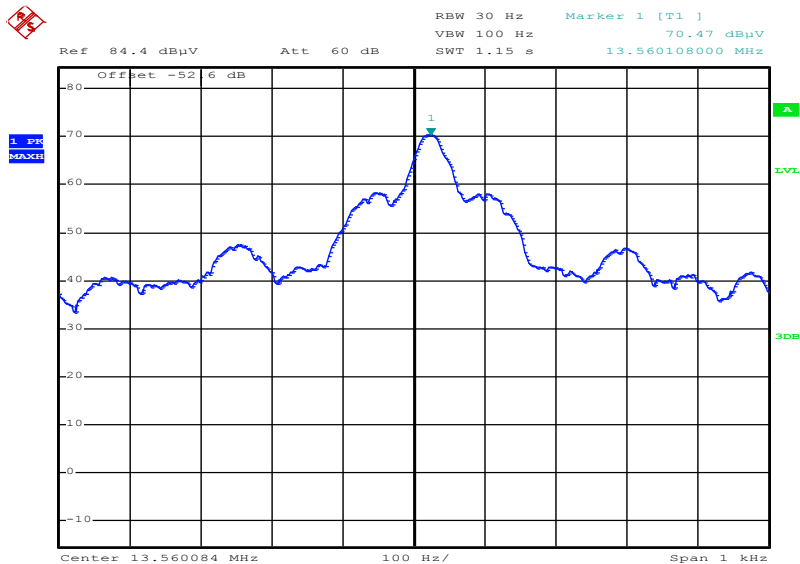

Date: 13.OCT.2016 09:55:27

Plot 13: 100% voltage; 20°C

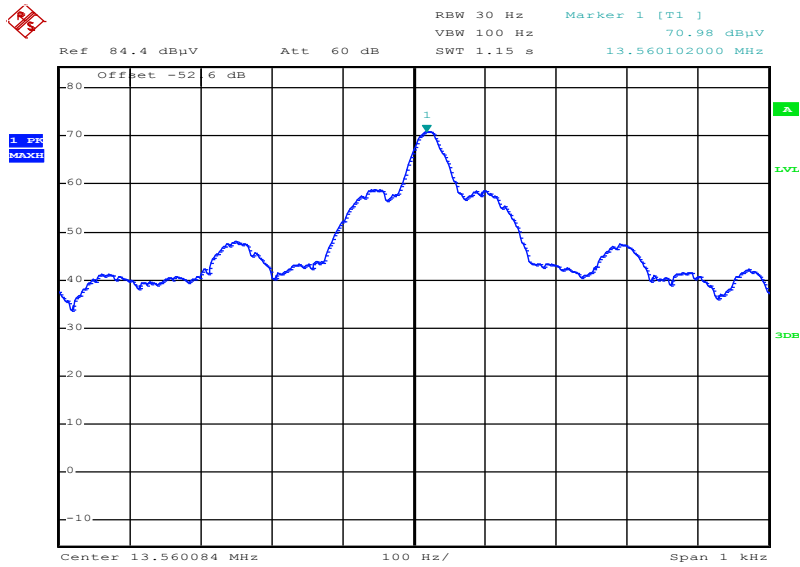

Date: 13.OCT.2016 08:09:29

Plot 12: 85% voltage; 20°C

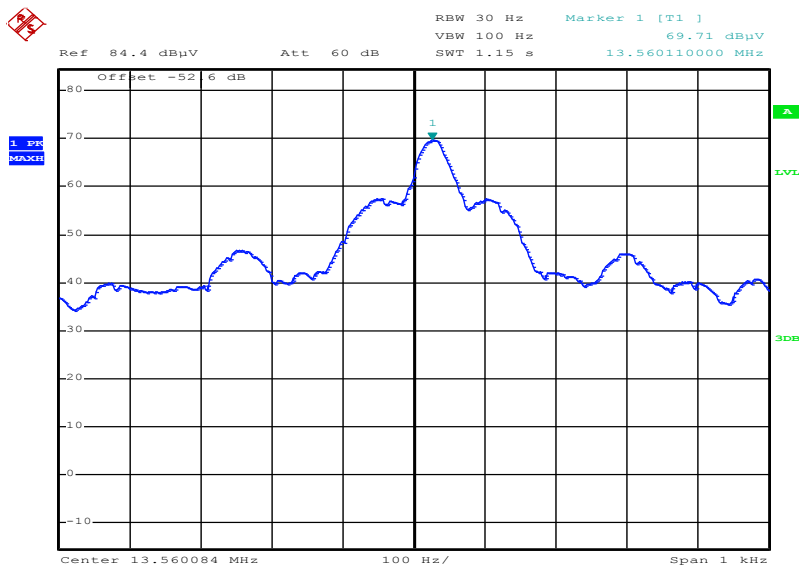

Date: 13.OCT.2016 09:54:51

### 13 Observations

No observations except those reported with the single test cases have been made.

### Annex A Document history

Version	Applied changes	Date of release
	Initial release	2016-10-13
A	Updated range for power supply	2016-10-25

### Annex B Further information

#### Glossary

AVG	-	Average
DUT	-	Device under test
EMC	-	Electromagnetic Compatibility
EN	-	European Standard
EUT	-	Equipment under test
ETSI	-	European Telecommunications Standard Institute
FCC	-	Federal Communication Commission
FCC ID	-	Company Identifier at FCC
HW	-	Hardware
IC	-	Industry Canada
Inv. No.	-	Inventory number
N/A	-	Not applicable
PP	-	Positive peak
QP	-	Quasi peak
S/N	-	Serial number
SW	-	Software
PMN	-	Product marketing name
HMN	-	Host marketing name
HVIN	-	Hardware version identification number
FVIN	-	Firmware version identification number

**Annex C Accreditation Certificate**

Front side of certificate

Back side of certificate



Deutsche Akkreditierungsstelle GmbH

Bellehene gemäß § 8 Absatz 1 AkkStelleG i.V.m. § 1 Absatz 1 AkkStelleGBV  
 Unterzeichnerin der Multilateralen Abkommen  
 von EA, ILAC und IAF zur gegenseitigen Anerkennung

**Akkreditierung**



Die Deutsche Akkreditierungsstelle GmbH bestätigt hiermit, dass das Prüflaboratorium

**CETECOM ICT Services GmbH**  
 Untertürkheimer Straße 6-10, 66117 Saarbrücken

die Kompetenz nach DIN EN ISO/IEC 17025:2005 besitzt, Prüfungen in folgenden Bereichen durchzuführen:

- Funk
- Mobilfunk (GSM / DCS) + OTA
- Elektromagnetische Verträglichkeit (EMV)
- Produktsicherheit
- SAR / EMF
- Umwelt
- Smart Card Technology
- Bluetooth\*
- Automotive
- Wi-Fi-Services
- Kanadische Anforderungen
- US-Anforderungen
- Akustik
- Near Field Communication (NFC)

Die Akkreditierungsurkunde gilt nur in Verbindung mit dem Bescheid vom 04.05.2016 mit der Akkreditierungsnummer D-PL-12076-01 und ist gültig bis 17.01.2018. Sie besteht aus diesem Deckblatt, der Rückseite des Deckblatts und der folgenden Anlage mit insgesamt 63 Seiten.

Registrierungsnummer der Urkunde: D-PL-12076-01-01

Frankfurt, 04.05.2016

*RSE*  
 Im Auftrag Dipl.-Ing. (FH) Ralf Egnor  
 Abteilungsleiter

Siehe Hinweise auf der Rückseite

Deutsche Akkreditierungsstelle GmbH

Standort Berlin  
 Spittelmarkt 10  
 10117 Berlin

Standort Frankfurt am Main  
 Europa-Allee 52  
 60327 Frankfurt am Main

Standort Braunschweig  
 Bundesallee 100  
 38116 Braunschweig

Die auszugsweise Veröffentlichung der Akkreditierungsurkunde bedarf der vorherigen schriftlichen Zustimmung der Deutsche Akkreditierungsstelle GmbH (DAkkS). Ausgenommen davon ist die separate Weiterverbreitung des Deckblatts durch die umseitig genannte Konformitätsbewertungsstelle in unveränderter Form.

Es darf nicht der Anschein erweckt werden, dass sich die Akkreditierung auch auf Bereiche erstreckt, die über den durch die DAkkS bestätigten Akkreditierungsbereich hinausgehen.

Die Akkreditierung erfolgte gemäß des Gesetzes über die Akkreditierungsstelle (AkkStelleG) vom 31. Juli 2009 (BGBl. I S. 2625) sowie der Verordnung (EG) Nr. 765/2008 des Europäischen Parlaments und des Rates vom 9. Juli 2008 über die Vorschriften für die Akkreditierung und Marktüberwachung im Zusammenhang mit der Vermarktung von Produkten (Abl. L 218 vom 9. Juli 2008, S. 30). Die DAkkS ist Unterzeichnerin der Multilateralen Abkommen zur gegenseitigen Anerkennung der European co-operation for Accreditation (EA), des International Accreditation Forum (IAF) und der International Laboratory Accreditation Cooperation (ILAC). Die Unterzeichner dieser Abkommen erkennen ihre Akkreditierungen gegenseitig an.

Der aktuelle Stand der Mitgliedschaft kann folgenden Webseiten entnommen werden:  
 EA: [www.european-accreditation.org](http://www.european-accreditation.org)  
 ILAC: [www.ilac.org](http://www.ilac.org)  
 IAF: [www.iaf.nu](http://www.iaf.nu)

**Note:**

The current certificate including annex can be received from CETECOM ICT Services GmbH on request.