

# **ID ISC.ANT1300/680**

## **Typ A**



English

## Note

© Copyright 2008 by

FEIG ELECTRONIC GmbH

Lange Strasse 4

D-35781 Weilburg-Waldhausen

Tel.: +49 6471 3109-0

<http://www.feig.de>

With the edition of this document, all previous editions become void. Indications made in this manual may be changed without previous notice.

Copying of this document, and giving it to others and the use or communication of the contents thereof are forbidden without express authority. Offenders are liable to the payment of damages. All rights are reserved in the event of the grant of a patent or the registration of a utility model or design.

Composition of the information in this document has been done to the best of our knowledge. FEIG ELECTRONIC GmbH does not guarantee the correctness and completeness of the details given in this manual and may not be held liable for damages ensuing from incorrect or incomplete information. Since, despite all our efforts, errors may not be completely avoided, we are always grateful for your useful tips.

The instructions given in this manual are based on advantageous boundary conditions. FEIG ELECTRONIC GmbH does not give any guarantee promise for perfect function in cross environments and does not give any guaranty for the functionality of the complete system which incorporates the subject of this document.

FEIG ELECTRONIC call explicit attention that devices which are subject of this document are not designed with components and testing methods for a level of reliability suitable for use in or in connection with surgical implants or as critical components in any life support systems whose failure to perform can reasonably be expected to cause significant injury to a human. To avoid damage, injury, or death, the user or application designer must take reasonably prudent steps to protect against system failures.

FEIG ELECTRONIC GmbH assumes no responsibility for the use of any information contained in this document and makes no representation that they free of patent infringement. FEIG ELECTRONIC GmbH does not convey any license under its patent rights nor the rights of others.

OBID® and OBID i-scan® are registered trademarks of FEIG ELECTRONIC GmbH.

I-CODE® is a registered trademark of Philips Electronics N.V.

Tag-it™ is a registered trademark of Texas Instruments Incorporated.

---

## Contents

---

<b>1</b>	<b>Safety Instructions / Warning - Read before Start-Up !</b>	<b>6</b>
<b>2</b>	<b>Performance Features of the ID ISC.ANT1300/680 Antennas</b>	<b>7</b>
2.1	Available Antenna Types .....	7
<b>3</b>	<b>Installation and Wiring</b>	<b>8</b>
3.1	Dimensions of antenna .....	8
3.2	Mounting preparation.....	9
3.3	Installing the antenna .....	10
3.3.1	Drilling the Mounting Holes .....	10
3.3.2	Installing the Antenna Base and Antenna Body .....	12
<b>4</b>	<b>Typical Antenna Configuration (Gate Antenna with two Antennas)</b>	<b>13</b>
4.1	Project Notes .....	13
4.2	Configuration and Setup using Antenna Type -A with power splitter.....	15
4.2.1	Required Components .....	15
4.2.2	Contents of the Gate- Integration- Kit ID ISC.ANT.GIK.....	16
4.2.3	Mounting of the components at the use of the Power Splitter .....	17
4.2.4	Configuration of a Gate antenna with power splitter.....	19
4.2.5	Setting the Power Splitter .....	20
4.2.6	Setting the Antenna Tuner .....	20
4.2.7	Reader Configuration with Power Splitter.....	22
4.2.8	Tuning the Gate Antenna with Power Splitter.....	24
4.3	Configuration and Setup using Antennas Type –A with Multiplexer .....	25
4.3.1	Required Components .....	25
4.3.2	Mounting of the components at the use of the Multiplexer .....	26
4.3.3	Configuration of a Gate antenna with Multiplexer.....	28
4.3.4	Setting the Multiplexer .....	29
4.3.5	DIP Switch Configuration .....	29
4.3.6	Jumper Configuration .....	30

---

---

4.3.7	Setting the Antenna Tuner .....	30
4.3.8	Reader Configuration with Multiplexer.....	32
4.3.9	Tuning the Gate Antenna with Multiplexer.....	34
<b>4.4</b>	<b>Testing the Gate Antenna .....</b>	<b>35</b>
4.4.1	Checking the Noise Level.....	35
4.4.2	Reading a Serial Number .....	36
4.4.3	Testing the performance .....	36
<b>4.5</b>	<b>Connecting and Setting the Alarm Kit (optional) .....</b>	<b>38</b>
4.5.1	Installing the Alarm Indicators .....	38
4.5.2	Connecting the Indicators.....	38
4.5.3	Reader Setting for Indicators.....	39
4.5.4	Programming a Transponder with the AFI Byte .....	41
<b>4.6</b>	<b>Activating Buffered Read Mode .....</b>	<b>43</b>
<b>4.7</b>	<b>Configuring the Reader in accordance with national RF regulations .....</b>	<b>44</b>
<hr/>		
<b>5</b>	<b>Technical Data .....</b>	<b>46</b>
<hr/>		
5.1	Antenna ID ISC.ANT1300/680- Type A.....	46
5.2	Approval.....	49
5.2.1	Europe (CE) .....	49
5.2.2	USA (FCC) and Canada (IC).....	50
5.2.3	USA (UL) .....	51

---

## 1 Safety Instructions / Warning - Read before Start-Up !

---

- The device may only be used for the intended purpose designed by for the manufacturer.
- The operation manual should be conveniently kept available at all times for each user.
- Unauthorized changes and the use of spare parts and additional devices which have not been sold or recommended by the manufacturer may cause fire, electric shocks or injuries. Such unauthorized measures shall exclude any liability by the manufacturer.
- The liability-prescriptions of the manufacturer in the issue valid at the time of purchase are valid for the device. The manufacturer shall not be held legally responsible for inaccuracies, errors, or omissions in the manual or automatically set parameters for a device or for an incorrect application of a device.
- Repairs may only be executed by the manufacturer.
- Installation, operation, and maintenance procedures should only be carried out by qualified personnel.
- Use of the device and its installation must be in accordance with national legal requirements and local electrical codes .
- When working on devices the valid safety regulations must be observed.
- Please observe that some parts of the device may heat severely.
- Before touching the device, the power supply must always be interrupted. Make sure that the device is without voltage by measuring. The fading of an operation control (LED) is no indicator for an interrupted power supply or the device being out of voltage!
- For installation and dismantling you should wear suitable safety gloves, because parts of antenna housing could be sharp-edged.



**CAUTION! The Antenna-Tuner and the Antenna conductor carry voltages up to 1000V.**

Special advice for wearers of cardiac pacemakers:

- Although this device doesn't exceed the valid limits for electromagnetic fields you should keep a minimum distance of 25 cm between the device and your cardiac pacemaker and not stay in an immediate proximity of the reader's antennas for any length of time.

## 2 Performance Features of the ID ISC.ANT1300/680 Antennas

The ID ISC.ANT1300/680 Type A antenna is the version with dynamicTuning Board ID ISC.DAT mounted. The Reader and Power-Splitter or Multiplexer are not included and had to be ordered separately and then to be mounted into the antenna

Up to

- two antennas Type A with reader and power splitter or multiplexer as a single gate,
- three antennas Type A with reader and multiplexer as a double gate, or
- 4 - 8 antennas with reader and multiplexer as a multiple gate

can be operated.

Depending on the antenna configuration, one, two or all three read orientations of the Smart Tags and various antenna spacing (gate widths) are possible.

The ID ISC.ANT1300/680 Type A is „figure-of-eight“ antenna with tuner and have been optimized as transmitting and receiving antennas for the ID ISC.LR2000 Reader. It is however also possible to operate them with other Readers at a transmission frequency of 13.56 MHz and an output impedance of 50  $\Omega$ . The read ranges indicated in this document and the tuning procedures may however then vary.

The antennas comprise the electrical antenna conductor, the housing, the ID ISC.DAT *Dynamic Antenna Tuner* and the connection cable. The antennas are factory tuned to an impedance of 50  $\Omega$  in a magnetically neutral environment at a distance of 95 cm. When installing in different ambient conditions the antenna can be retuned using the “DATuningTool“ PC software. After tuning the antennas will retain their settings as long as the ambient conditions remain unchanged.

The antennas can be used for detecting both product and persons. It is suitable for installation indoors or outdoors if weather-protected.

### 2.1 Available Antenna Types

The following Antennas are currently available:

Antenna Type	Description
ID ISC.ANT1300/680-A	Antenna with dynamic tuning board ID ISC.DAT
ID ISC.ANT-GIK	Mounting material and cables for Reader, Power Splitter or Multiplexer
ID ISC.ANT-GAK	Acoustic alarm signal with mounting material

Table 1: Available Antenna Types

---

### 3 Installation and Wiring

---

#### 3.1 Dimensions of antenna

---

The outside dimensions of the antenna are shown in Fig. 1

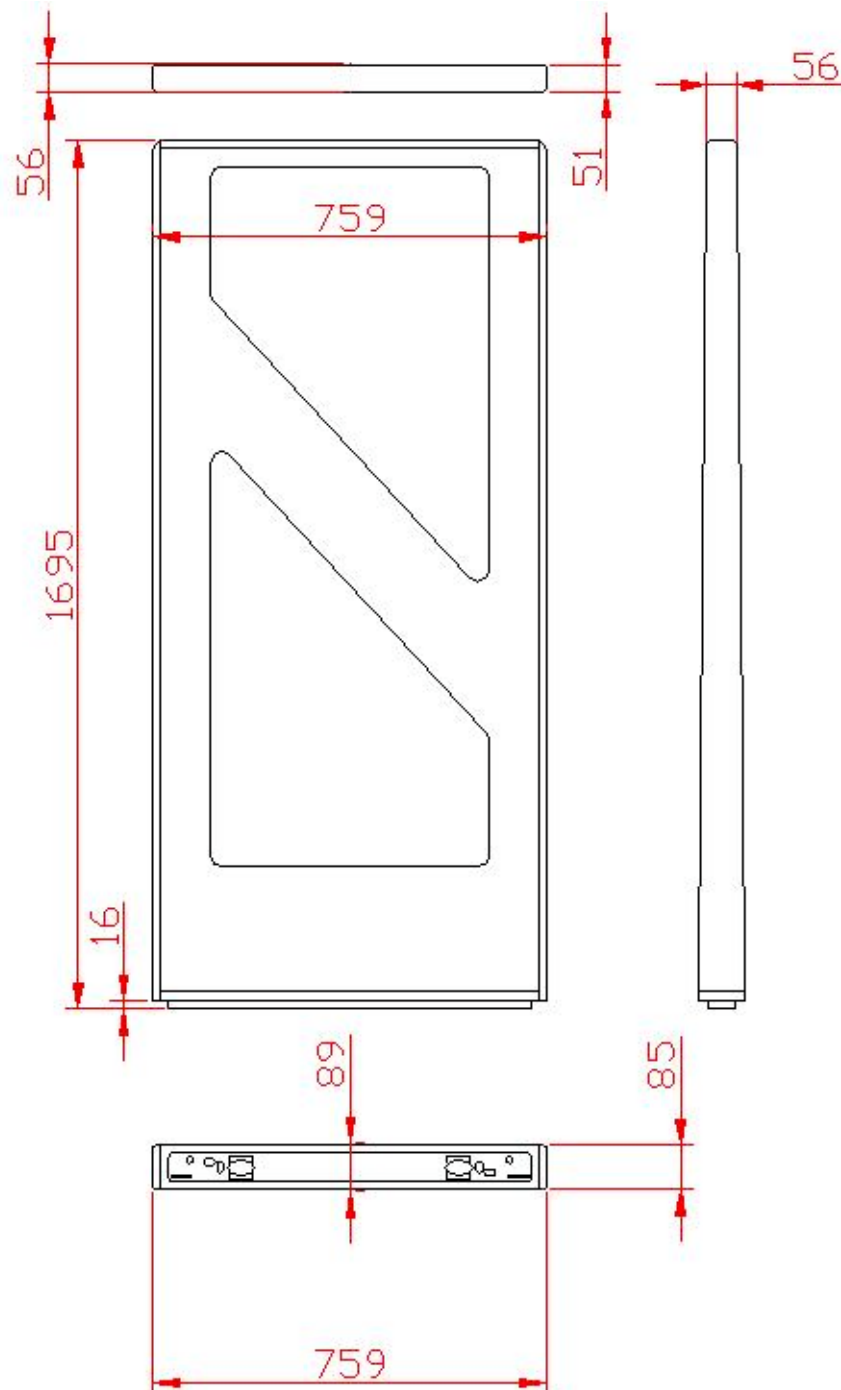

Fig. 1: Antenna outside dimensions

All dimensions are in mm with general tolerance to ISO 2768 m (mean).

### 3.2 Mounting preparation

For assembly the antenna must be carefully unpacked. This is done as described in the following steps:

1. Place the packed antenna on the floor with the top side facing up. Carefully open the box and then remove the antenna.



Fig. 2: Antenna in its packaging

2. After that the antenna has to be placed carefully again on the floor. Now you must remove the fastening screws (hexagon socket width A/F2,5) of the antenna foot cover and remove it upwards. Fig. 3

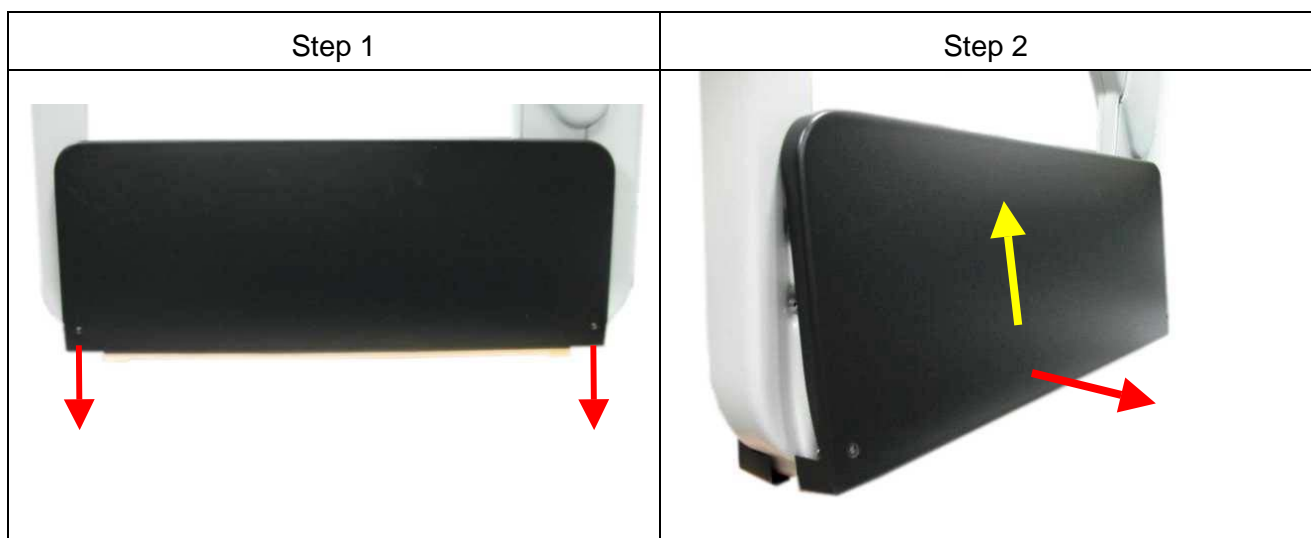

Fig. 3: Opening the antenna foot



### 3.3 Installing the antenna

#### Notes:

Before installing the antennas please read 4.1 [Project Notes](#) . The spacing of the antennas comprising a gate depends on the antenna configuration.

If multiple antennas or gates are connected to different Readers, a minimum separation of 8 m must be kept between the antennas or gates. For shorter distances (1 m – 8 m) the Readers must be multiplexed. Below a distance of 1.5 m the antennas must also be shielded from each other. Otherwise the Reader range will be significantly reduced. The antennas must have a minimum distance of 20 cm from all larger metal parts! At a distance of less than 50 cm between the antenna and metal parts the Reader range will be significantly reduced.

#### 3.3.1 Drilling the Mounting Holes

If the position of the antennas has been marked or determined, the antenna foot ①, which is to be used as a hole template, can be used to mark and drill the mounting holes and the holes for the cable entry. The dimensions are shown in Fig. 4:

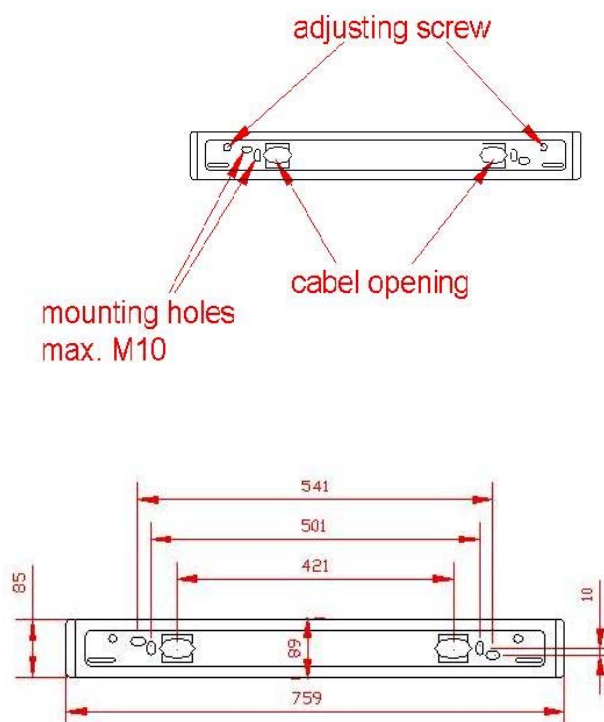

Fig. 4: Floor plate dimensions ①

All dimensions are in mm with general tolerance to ISO 2768 m (middle).

The size and type of the screw anchors depends considerably on the strength of the base or floor. The anchors should be capable of withstanding a permissible load of at least 5 kN per anchor for all load directions (e.g. for concrete floor Hilti HVA anchors with HAS-(E) M8 threaded rod or Hilti HIS-N M8 (5/16") threaded inserts). The size of the mounting holes in the antenna is 10 mm (.39"). The length of the anchors or bolts should be selected such that they extend at least 50 mm (2.0") and a maximum of 65 mm (2.6") from the floor.

***Please follow the mounting instructions of the anchor manufacturer!***

Two cable openings are provided for the necessary connection cable (see Fig. 4). The cable openings are dimensioned such that up to 10 cables having a diameter of 6 mm can be passed through each opening.

We recommend routing the antenna cables through the cable opening on the Power-Splitter or Multiplexer side. All other cables such as the supply voltage and multiplexing cable should be routed through the cable opening on the Reader side.

Alternatively the cables can be routed at the sides of the antenna bas like shown in Fig. 5

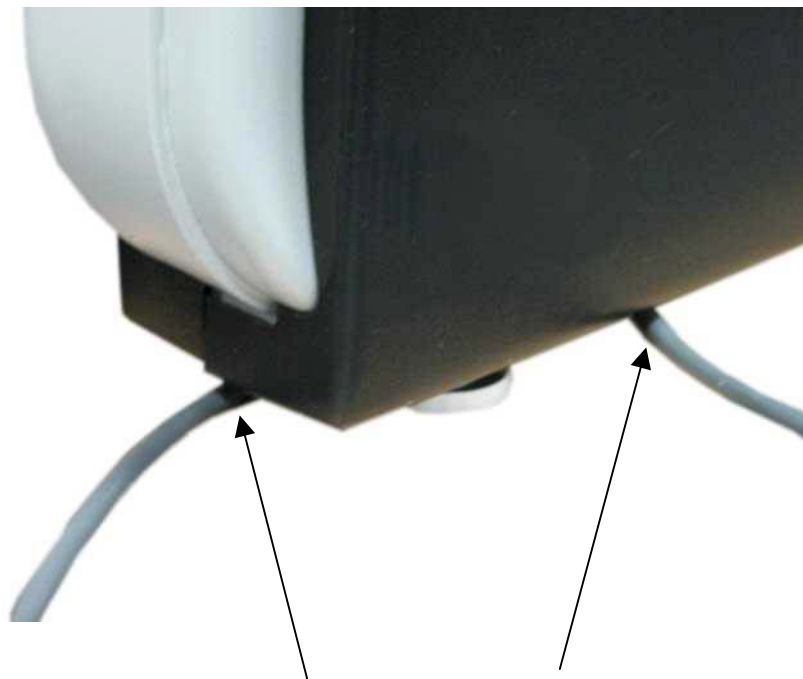

Fig. 5 Cable routing at the antenna sides

---

### 3.3.2 Installing the Antenna Base and Antenna Body

---

The antenna will be screwed on the floor. Use the adjusting screws (Fig. 6) to align the antenna vertically.



Adjusting screws (hexagon socket width A/F5)

Fig. 6: Attaching and aligning the antenna

---

## 4 Typical Antenna Configuration (Gate Antenna with two Antennas)

---

The standard configuration of a gate with three-dimensional tag orientation consists of two ID ISC.ANT1300/680 Type A with reader and power splitter or multiplexer. If a tag moves through the gate horizontally, it can be read at least once. This ensures high reliability of the antenna system.

---

### 4.1 Project Notes

---

The antenna configuration described allows detection of a tag moving horizontally through the capture area of the gate. The tag orientation is non-critical. The tags are detected along a horizontal axis of motion in certain regions within the antennas. The area of detection depends on the tag orientation.

The size of the three-dimensional capture area of the antennas is shown in the sketch below.

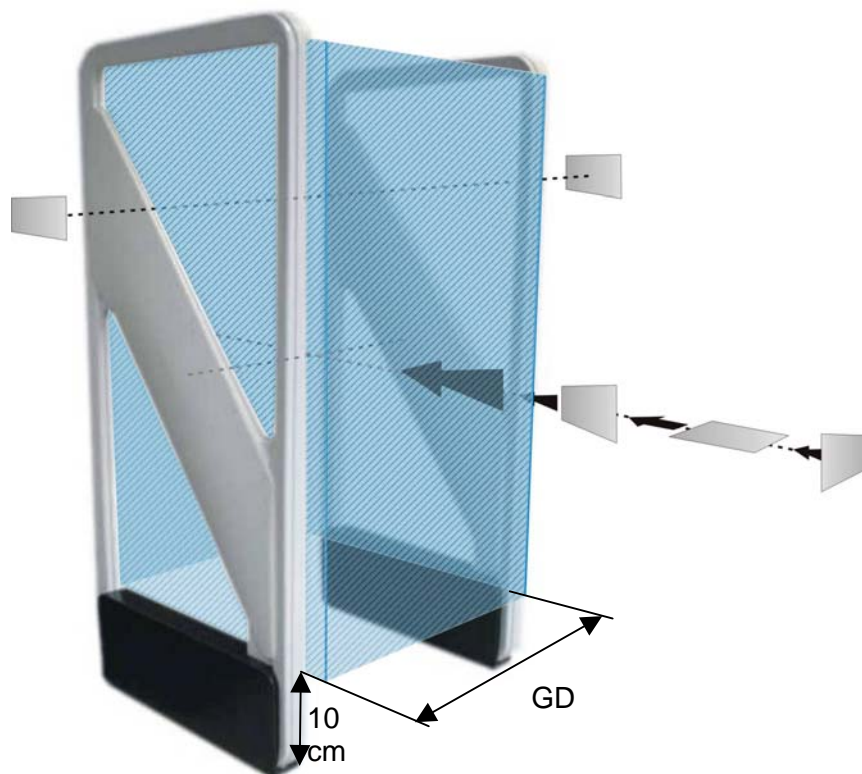

Fig. 7: Capture area and tag orientation

**Notes:**

**Note that the entire capture area of the antenna is larger than the three-dimensional area shown in the drawing. This means there are tag orientations in which the tag can be detected outside the capture area.**

***If multiple gates are arranged with short distances between each other, these will mutually interfere with each other. The Readers for the respective gates must then be synchronized.***

To achieve three-dimensional capture of the tag in the capture area drawn above, the following conditions must be met:

- The gate distance GD depends on the antenna configuration (see Table 2: Design notes).
- The tags should be at least ISO card size (46 mm x 75 mm).
- The activation field strength of the tags should be less than or equal to 80 mA/m.
- The distance from tag to tag should be greater than 10 cm. If the tag to tag distance is reduced, the gate distance GD must be reduced correspondingly. This applies in particular to distances under 5 cm.
- The maximum number of tags (serial number or data) depends on the traverse speed with which the tags are brought through the capture area of the gate (see Table 2: Design notes). The number of tags may be increased in the gate distance GD is correspondingly reduced and the maximum speed adjusted accordingly.
- The antenna should be at least 50 cm from metal parts.
- There should be no interference of the Reader from other electrical devices in the environment. The Noise Level difference should be less than 30 mV.
- The ID ISC.LR2000 Reader should be set to an RF power of 8 watts.
- When using ISO 15693 transponders, the Readers should be set as described [in 4.2.7 Reader Configuration with Power Splitter or 4.3.8 Reader Configuration with Multiplexer](#).
- If multiple gates are operated at the same time at a distance of less than 8 m, the Readers must be synchronized. See Application Note *Synchronizing RFID LongRange Readers using the digital in-/outputs* (N11200-1e-ID-B.pdf).

Table 2: Design notes

	Antenna Type A With reader and power splitter	Antenna Type A With reader and multiplexer
Gate distance GD	≤ 90 cm	≤ 95 cm
Number of tags at traverse speed 1 m/s		
- Read serial number	16	16
- Read data	8	8

---

## 4.2 Configuration and Setup using Antenna Type -A with power splitter

---

---

### 4.2.1 Required Components

---

To construct the gate you need the following components:

- Qty. 2 Antenna ID ISC.ANT1300/6800 Type A
- Qty. 1 Reader module ID ISC.LR2000-A-M
- Qty. 1 Power splitter module ID ISC.ANT-PS-BM
- Qty. 1 Gate integration kit ID ISC.ANT.GIK
- Qty. 1 power supply ID ISC.NET24-B
- Power cable, interface cable and connection cable for the DC power supplies (2-wire, twisted)
- Mounting materials (screws, anchors)

Optional:

- Qty. 1 Alarm Kit ID ISC.ANT.GAK

To configure the Reader you will need the software

- ISOStart Version 7.01 or higher

and for tuning the antennas the service software

- DATuningTool Version 1.00 or higher

on a personal computer running under Microsoft® Windows®. The service software is included on the **OBID i-scan®** CD obtained from FEIG ELECTRONIC GmbH or can be downloaded on the Download Area of the Homepage [www.feig.de](http://www.feig.de).

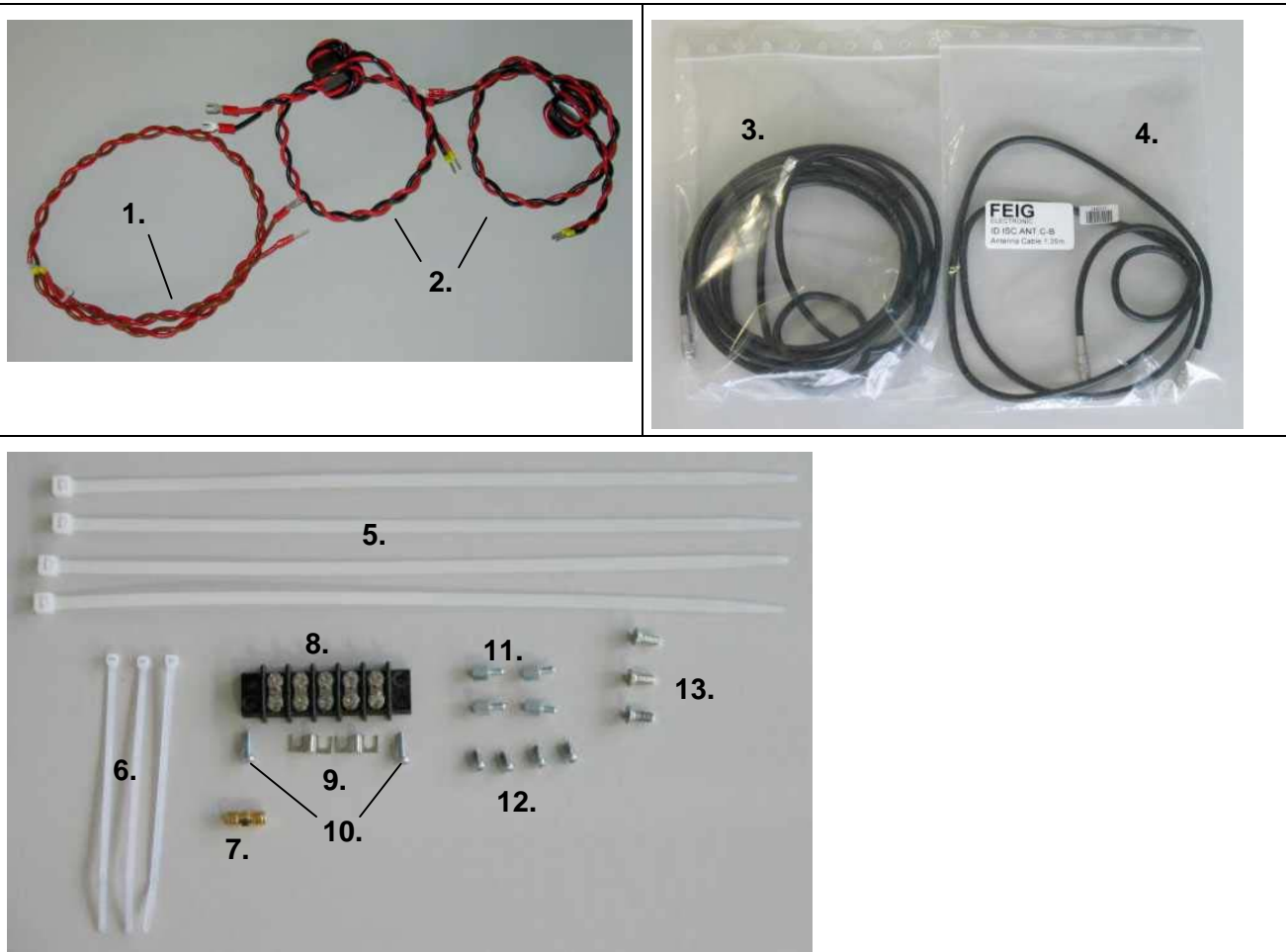

4.2.2 Contents of the Gate- Integration- Kit ID ISC.ANT.GIK

The following parts are contents of the Gate- Integration- Kit .





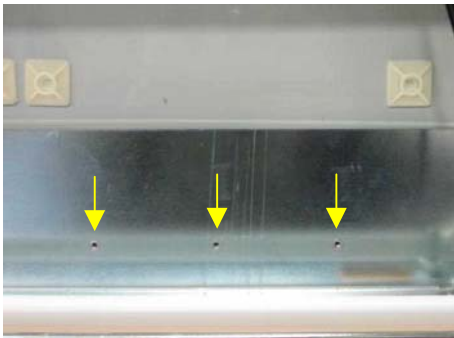

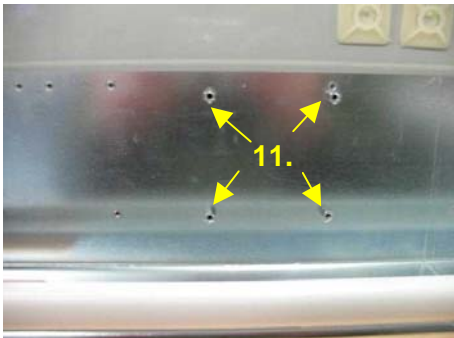
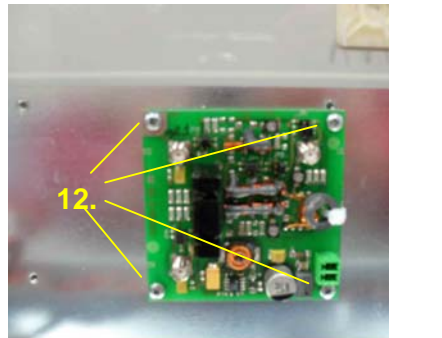
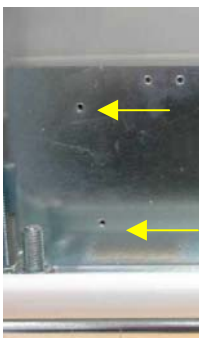
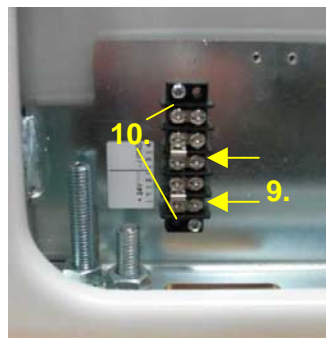
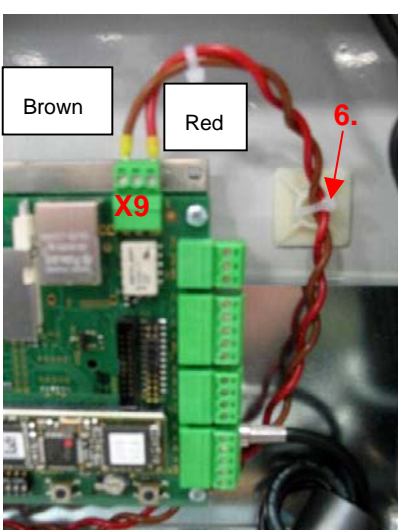
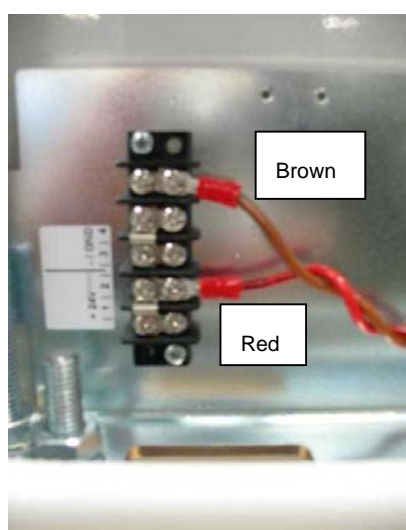

Position	Qty.	Name / Use
1.	1	DC- cable relay / Connection Buzzer – Relay Output – 24V
2.	2	DC-cable Reader, PS, Mux / DC-Connection to Terminal block – Reader, PS or Mux
3.	1	3,65m coaxial cable/ HF- Connection Reader – Mux (just at the use of Mux)
4.	1	1,35m coaxial cable / HF- Connection Reader – PS or Mux
5.	4	Cable tie 4,8x280mm / tie together of the coaxial cables
6.	3	Cable tie 2,5x105mm / Mounting of the torrid cores of the DC-cables and the relay
7.	1	SMA adapter female-female / Connection of 1,35m with 3,65m coaxial cable with Mux
8.	1	Terminal block 5x 2pin / Connection DC - cables
9.	2	Bridge of Terminal block / Connection of the terminals GND and 24VDC
10.	2	Screw M3x10 / Mounting Terminal block into the antenna foot
11.	4	Hexagon spacer bolt M3x6 / Mounting PS or Multiplexer into the antenna foot
12.	4	Screw M3x6 / Mounting PS or Multiplexer into the antenna foot
13.	3	Screw M4x8 / Mounting Reader into the antenna foot

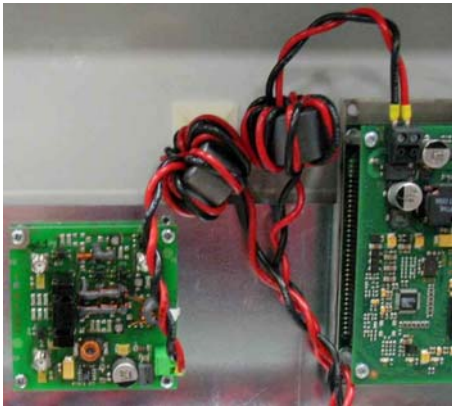
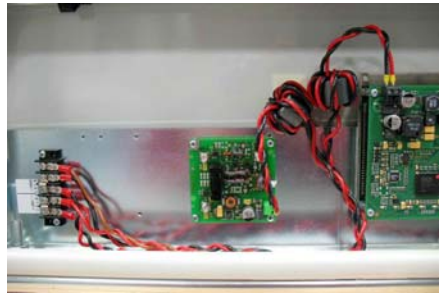
4.2.3 Mounting of the components at the use of the Power Splitter

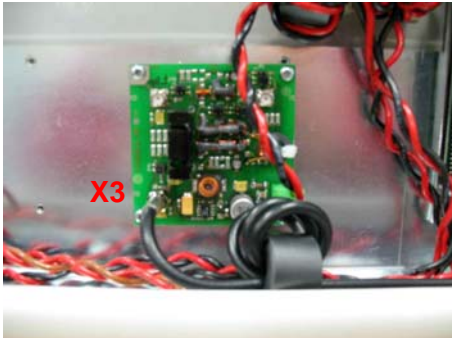
Step	Action	Note	
1	Mounting of the reader with the screw M4x8 Pos.13		
2	Mounting of the Power Splitter with the hexagon spacer bolts M3x6 Pos.11 and the screws M3x6 Pos.12		
3	Mounting of the Terminal block Pos.8 with the screws M3x10 Pos.10 and connection of the terminals 1+2 (+24V) and 3+4 (GND) with the bridges. Pos.9		
4	<p>Mounting of the relay cable Pos.1 with 1 piece of cable tie 2,5x105mm Pos.6</p> <p>Red wire to Com and Brown wire to NO of X9 Reader, Red wire to 2 and Black wire to 5 of terminal block</p>		

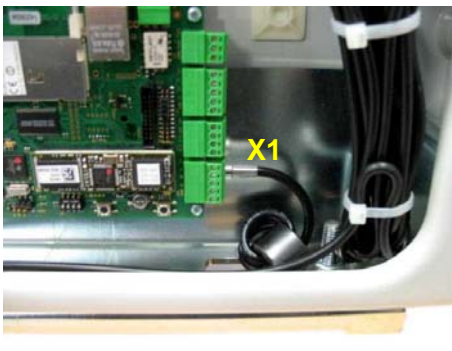
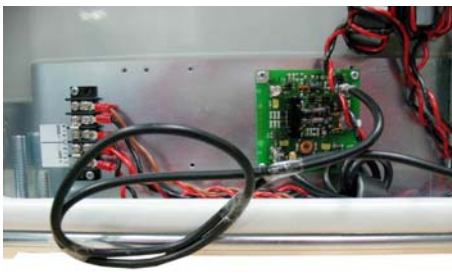

<p><b>5</b></p>	<p>Mounting of the DC-cables Pos.2 of the readers and of the PS with 2 pieces of cable tie 2,5x105mm Pos.6</p> <p>Attention! Take care of polarity.</p>		
<p><b>6</b></p>	<p>Connect DC- cables to Terminal block</p> <p>Red wire to terminal 1+2 (+24V), Black wire to terminal 3+4 (GND)</p>		<p>. Attention! Take care of polarity.</p>
<p><b>7</b></p>	<p>Connect the antenna cable with X3 of PS. Wind up the rest of the cable to loops and tied it together with 2 pieces of cable tie 4,8x280mm Pos.5</p>		
<p><b>8</b></p>	<p>Mounting of the 1,35m coaxial cable between X1 Reader and X1 PS. Mount the torrid from the reader attachment approx. 10cm with 4 turns before the reader.</p>		
<p><b>9</b></p>	<p>Wind up the rest of the cable to loops and tied it together with 2 pieces of cable tie 4,8x280mm Pos.5 and place it in the antenna foot.</p>		

4.2.4 Configuration of a Gate antenna with power splitter

Connect the components as shown in Fig. 8

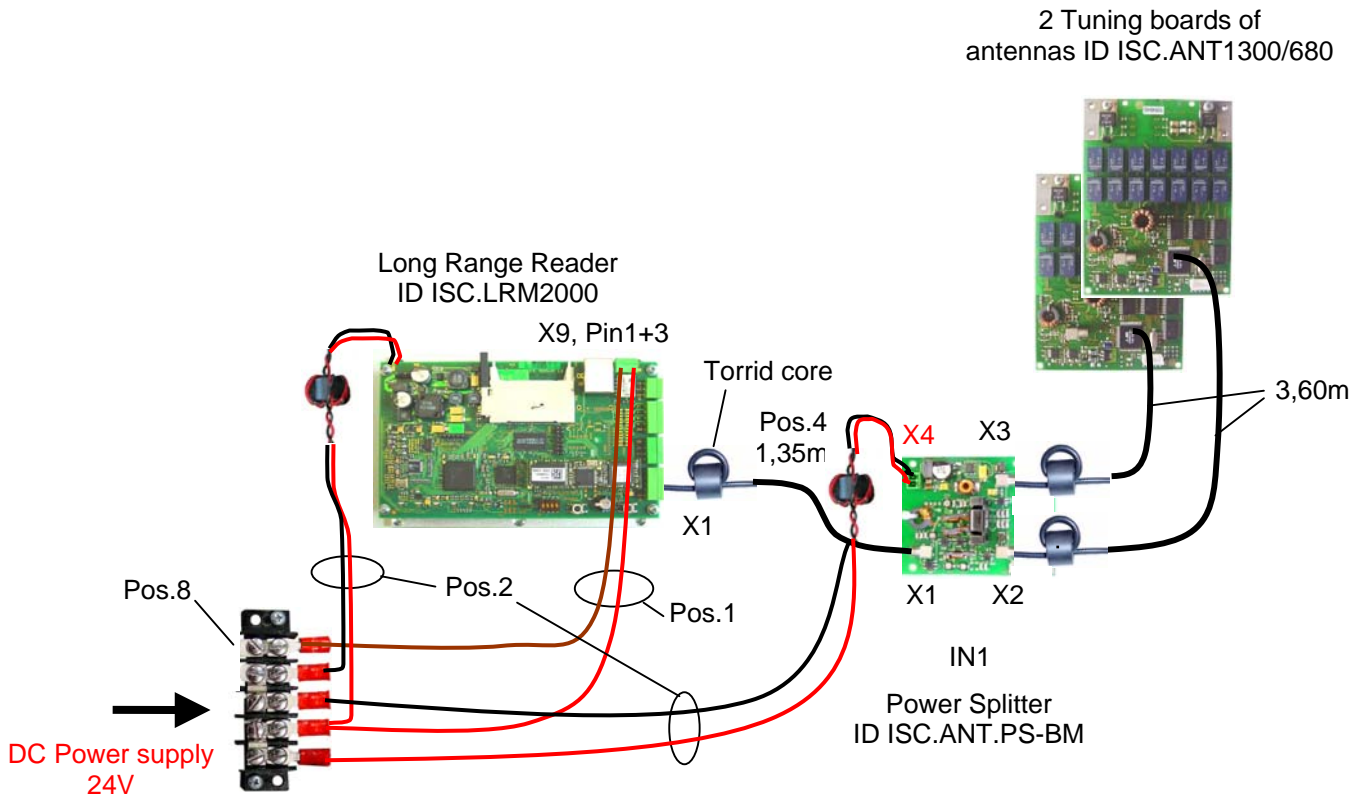

Fig. 8: Component connection for a standard Gate Type A with power splitter

The coax cables have fixed lengths and may not be shortened and therefore need to be tied into small loops (see Fig. 9). Tie all cables as far away from the antenna conductor as possible. The cables must never be allowed to contact the aluminum tube.



Fig. 9: Tying the cables

### 4.2.5 Setting the Power Splitter

Set the jumpers on the Power Splitter as shown Table 3:Power Splitter setting. More information about setting the ID ISC.ANT.PS-BM Power Splitter can be found in the corresponding installation manual (M40402-xde-ID-B).

Table 3:Power Splitter setting

Trans- former	Power Splitter	Phase shifter	JP1	JP3	JP4	JP5	JP6
not used	X	X	3-5 4-6	2-4	1-2	1-2	1-2 3-4
Power Splitter with 90° phase shifter X1: Reader X2: Antenna X3: Antenna X4: 12-24V DC for Antenna with dyn. antenna tuner ID ISC.DAT							

### 4.2.6 Setting the Antenna Tuner

To check the settings of the antenna tuner the antenna foot has to be opened. For that you must remove the to fastening screws (hexagon socket width A/F2,5) of the antenna foot cover and remove it upwards. Fig. 10

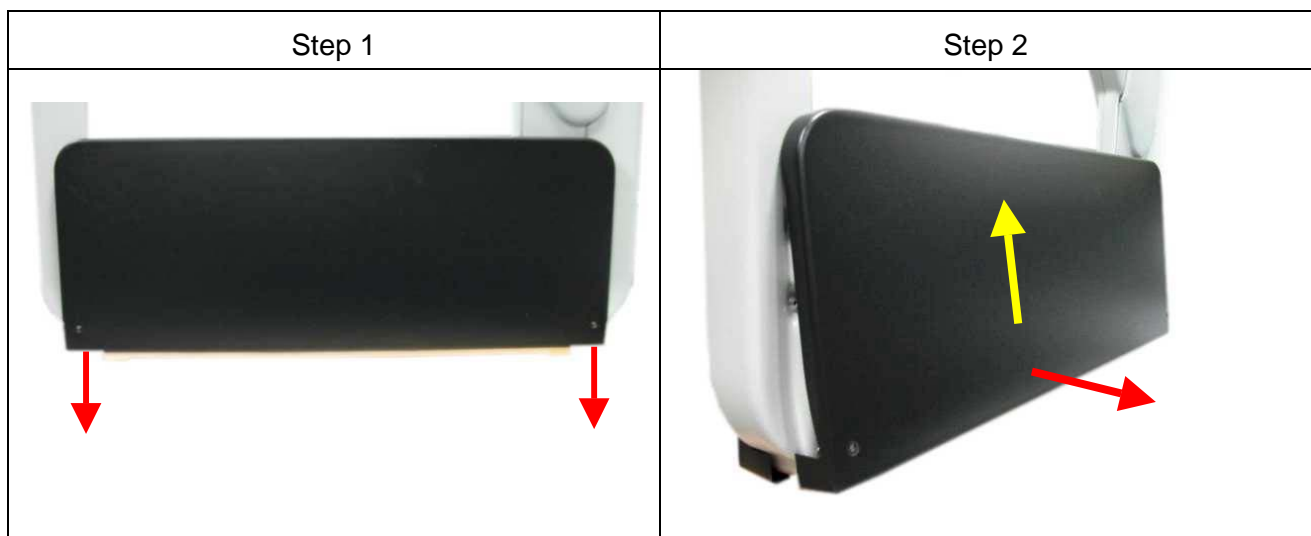

Fig. 10: Opening of the antenna foot

Now you must remove the to fastening screws (hexagon socket width A/F2,5) of the antenna tuner cover and remove it upwards. Fig. 11

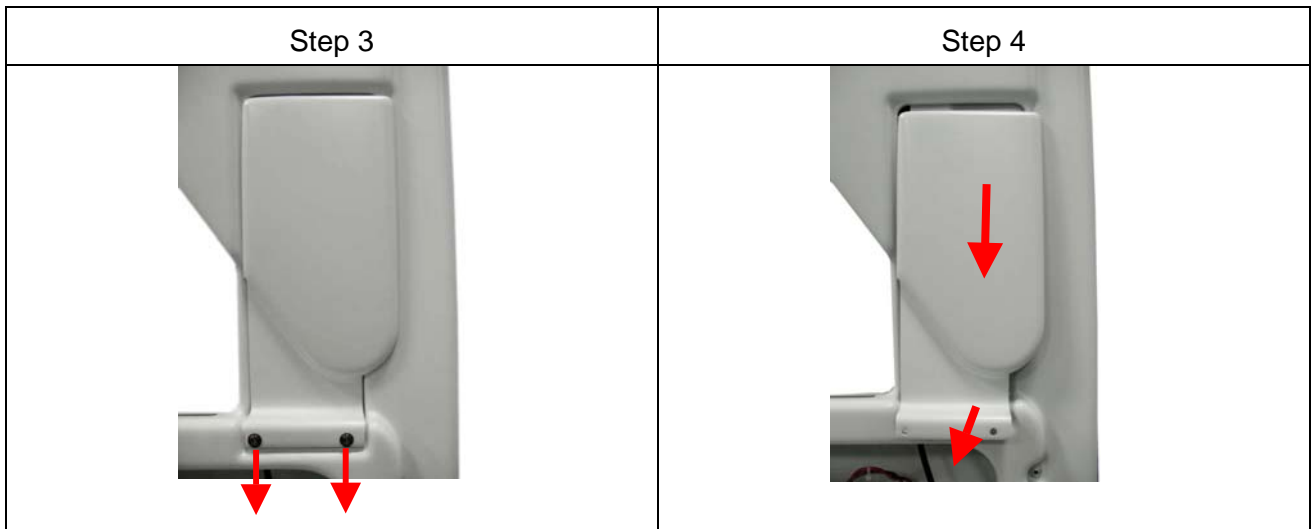
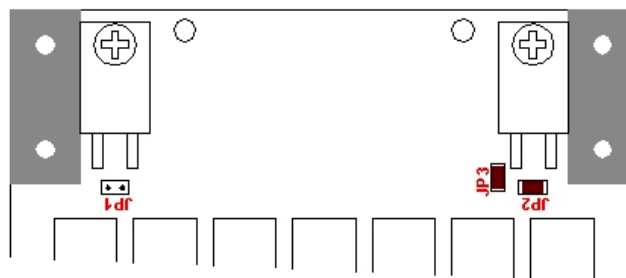

Fig. 11 Removing the antenna tuner cover

The ID ISC.ANT1300/680-A antennas are factory set as follows:

Table 4: Jumper settings for Antenna Tuner



Function	Jumper	Position
1Ω Q resistor	JP1	open
2Ω Q resistor	JP2	closed
Antenna switch	JP3	closed
Capacitor C1	JP 11,12,13,14	open
Capacitor C2	JP 21,22,25,26	open
	JP 23,24	closed







Verify these settings. More on setting the ID ISC.DAT antenna tuner can be found in the corresponding installation manual (M40401-xde-ID-B).

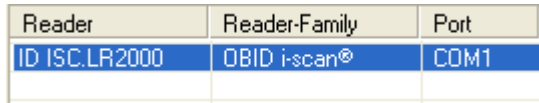

4.2.7 Reader Configuration with Power Splitter

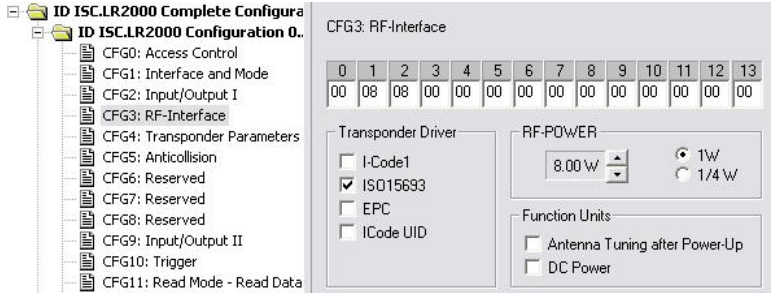
To tune the antennas, open the ISOStart software and first read out the current configuration of the Reader:

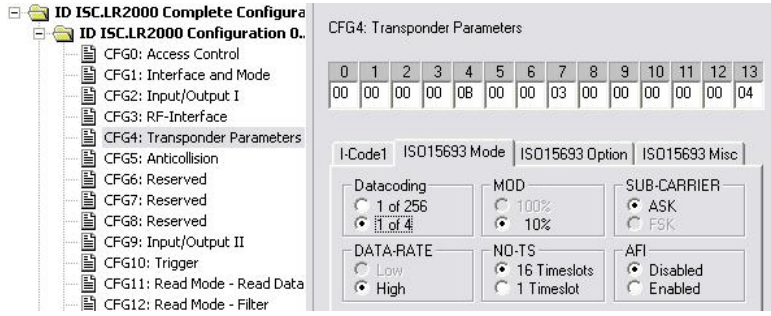
Step	Action	Note
1	Start ISOStart Software	
2	Run „Detect“...	
3	...follow „New-File Assistant“...	
4	...and read out the current Reader Configuration	<input checked="" type="checkbox"/> Read the complete Reader Configuration

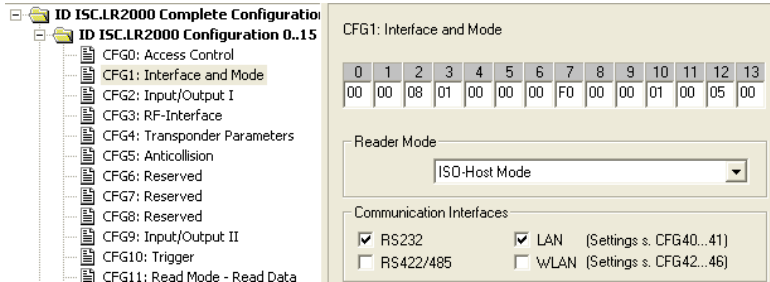

Then set the operating power, Transponder Parameters and ISO Host Mode:

Step	Action	Note
1	Select “Configuration”	
2	<b>CFG3: RF-Interface:</b> “RF-POWER” (here 8W)  Select “Transponders-Drivers” (here ISO 15693)	
3	Set by clicking on “Write”	
4	<b>CFG4:</b> <b>Transponder Parameters</b> Configure the parameters as follows (ISO15693 Mode): <ul style="list-style-type: none"> <li>• „Datacoding“ – 1 of 4</li> <li>• „MOD“ – 10%</li> <li>• „SUB-CARRIER“ – ASK</li> <li>• „DATA-RATE“ – High</li> <li>• „NO-TS“ – 16 Timeslots</li> <li>• „AFI“ – Disabled</li> </ul>	  Note: National RF regulations may require different settings. (see 4.7 Configuring the Reader in accordance with national RF regulations)
5	Set by clicking on “Write”	

Step	Action	Note
6	<p><b>CFG1: Interface and Mode</b></p> <p>To tune, activate “ISO-Host Mode”</p>	
7	Set by clicking on “Write”	

4.2.8 Tuning the Gate Antenna with Power Splitter

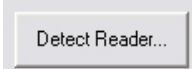
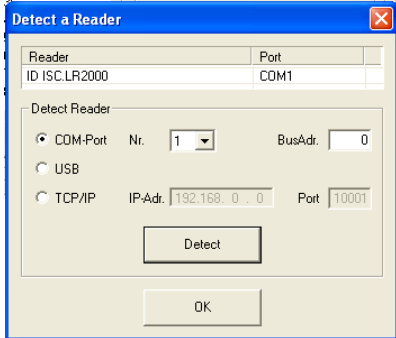
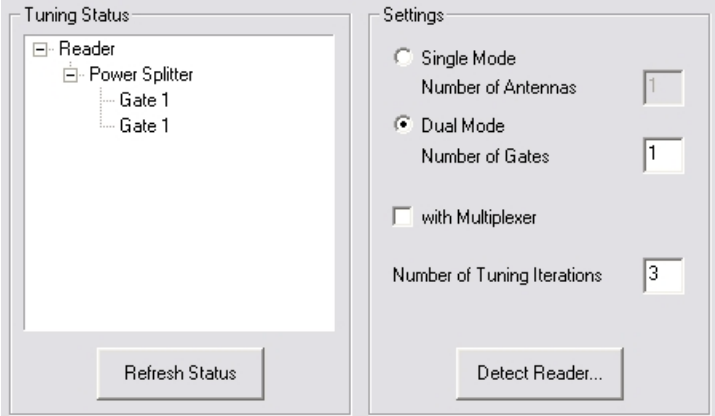
Before tuning the Gate Antenna you must quit the ISOStart software. Then the gate may be tuned according to the following sequence:

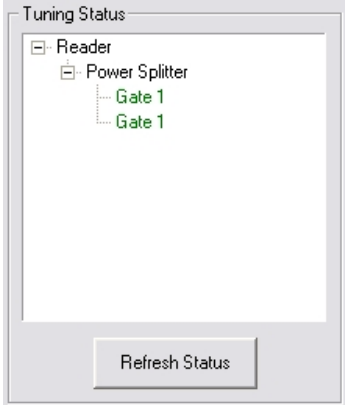
Step	Action	Note
1	Start "DATuningTool" Software	 DATuningTool
2	Click on "Detect Reader..." button and then "Detect" on the selected interface (COM-Port 1)	 
3	Use „Settings“ to enter the configuration: Dual Mode, Number of Gates 1 Number of Tuning Iterations 3	
4	Activate „Start Tuning“ and wait until the tuning process is ended.	 
5	After each tuning pass the current tuning status is displayed.  After successful tuning both antennas for „Gate 1“ are shown in green.	

After successful tuning close the DATuningTool again.

---

## 4.3 Configuration and Setup using Antennas Type –A with Multiplexer

---

---

### 4.3.1 Required Components

---

To construct the gate you need the following components:

- Qty. 2 Antenna ID ISC.ANT1300/680 Type A
- Qty. 1 Reader module ID ISC.LR2000-A-M
- Qty. 1 Multiplexer module ID ISC.ANT.MUX-A-M
- Qty. 1 Gate integration kit ID ISC.ANT.GIK
- Qty. 1 power supply ID ISC.NET24-B
- Power cable, interface cable and connection cable for the DC power supplies (2-wire, twisted)
- Mounting materials (screws, anchors)

Optional:

- Qty. 1 Alarm Kit ID ISC.ANT.GAK

To calibrate the Reader you will need the software

- ISOStart Version 7.01 or higher



and for tuning the antennas the service software





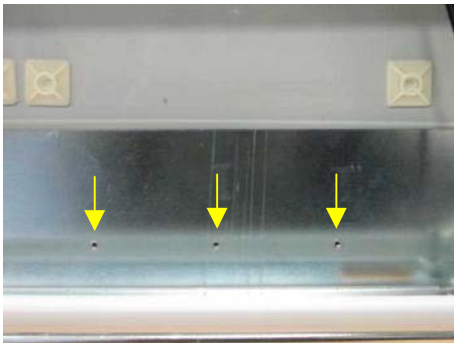

- DATuningTool Version 1.00 or higher

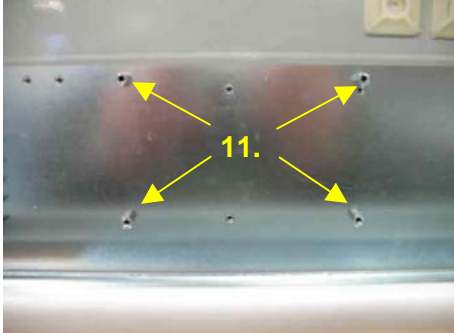
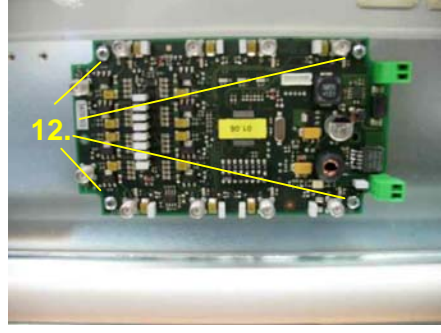
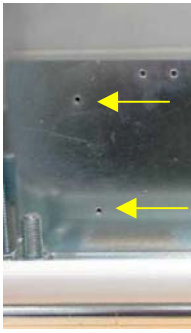
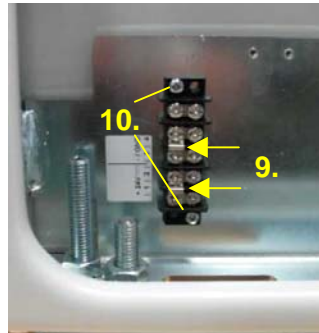
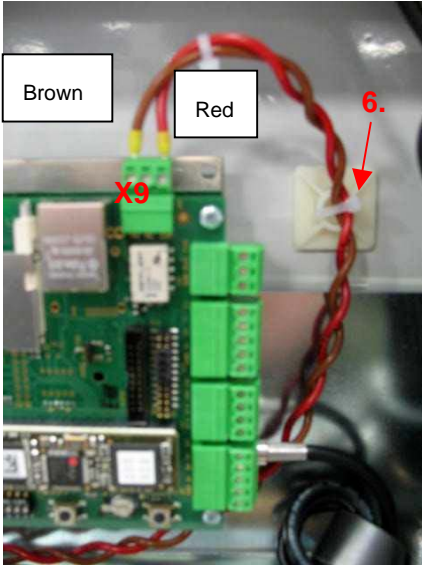
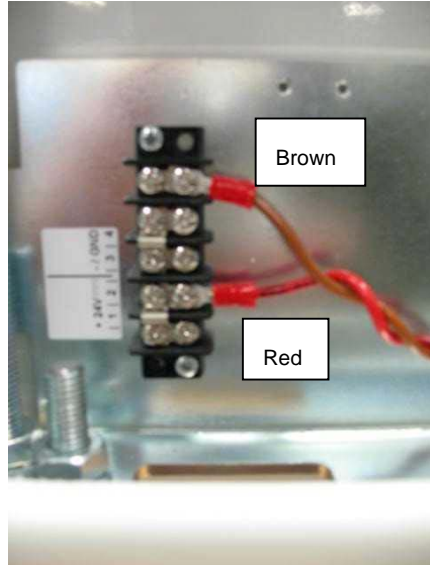
on a personal computer running under Microsoft® Windows®. The service software is included on the **OBID i-scan®** CD obtained from FEIG ELECTRONIC GmbH or can be downloaded at the Download Area of the Homepage [www.feig.de](http://www.feig.de).

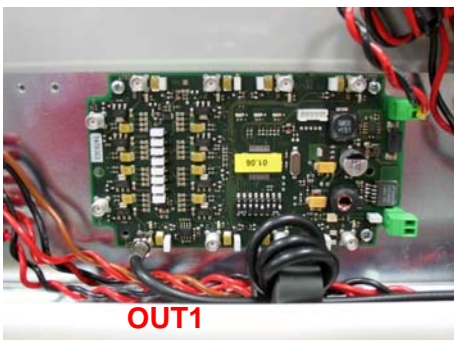

4.3.2 Mounting of the components at the use of the Multiplexer

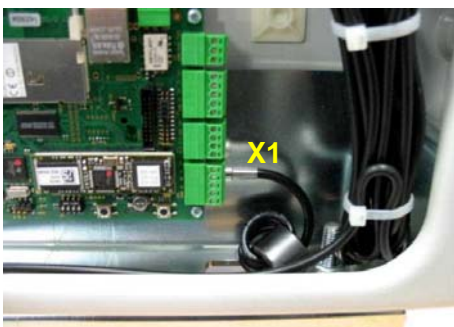
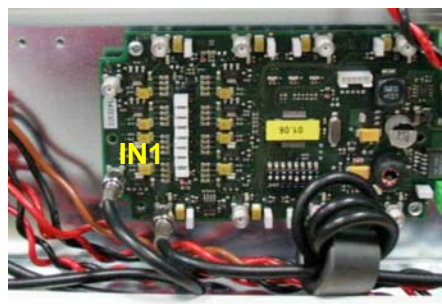
Step	Action	Note	
1	Mounting of the reader with the screw M4x8 Pos.13		
2	Mounting of the Multiplexer with the hexagon spacer bolts M3x6 Pos.11 and the screws M3x6 Pos.12		
3	Mounting of the Terminal block Pos.8 with the screws M3x10 Pos.10 and connection of the terminals 1+2 (+24V) and 3+4 (GND) with the bridges. Pos.9		
4	Mounting of the relay cable Pos.1 with 1 piece of cable tie 2,5x105mm Pos.6  Red wire to Com and Brown wire to NO of X9 Reader, Red wire to 2 and Black wire to 5 of terminal block		

<p><b>5</b></p>	<p>Mounting of the DC-cables Pos.2 of the readers and of the Multiplexer with 2 pieces of cable tie 2,5x105mm Pos.6</p> <p>Attention! Take care of polarity.</p>		
<p><b>6</b></p>	<p>Connect DC- cables to Terminal block</p> <p>Red wire to terminal 1+2 (+24V), Black wire to terminal 3+4 (GND)</p>		<p>. Attention! Take care of polarity.</p>
<p><b>7</b></p>	<p>Connect the antenna cable with Out 1 of Multiplexer. Wind up the rest of the cable to loops and tied it together with 2 pieces of cable tie 4,8x280mm Pos.5</p>		
<p><b>8</b></p>	<p>Mounting of the co-axial cable between X1 Reader and IN1 Multiplexer. Connect the 1,35m and the 3,65m cable using the SMA Adapter Pos.7. Mount the torrid from the reader attachment approx. 10cm with 4 turns before the reader.</p>		
<p><b>9</b></p>	<p>Wind up the rest of the cable to loops and tied it together with 2 pieces of cable tie 4,8x280mm Pos.5 and place it in the antenna foot.</p>		

4.3.3 Configuration of a Gate antenna with Multiplexer

Connect the components as shown in Fig. 12.

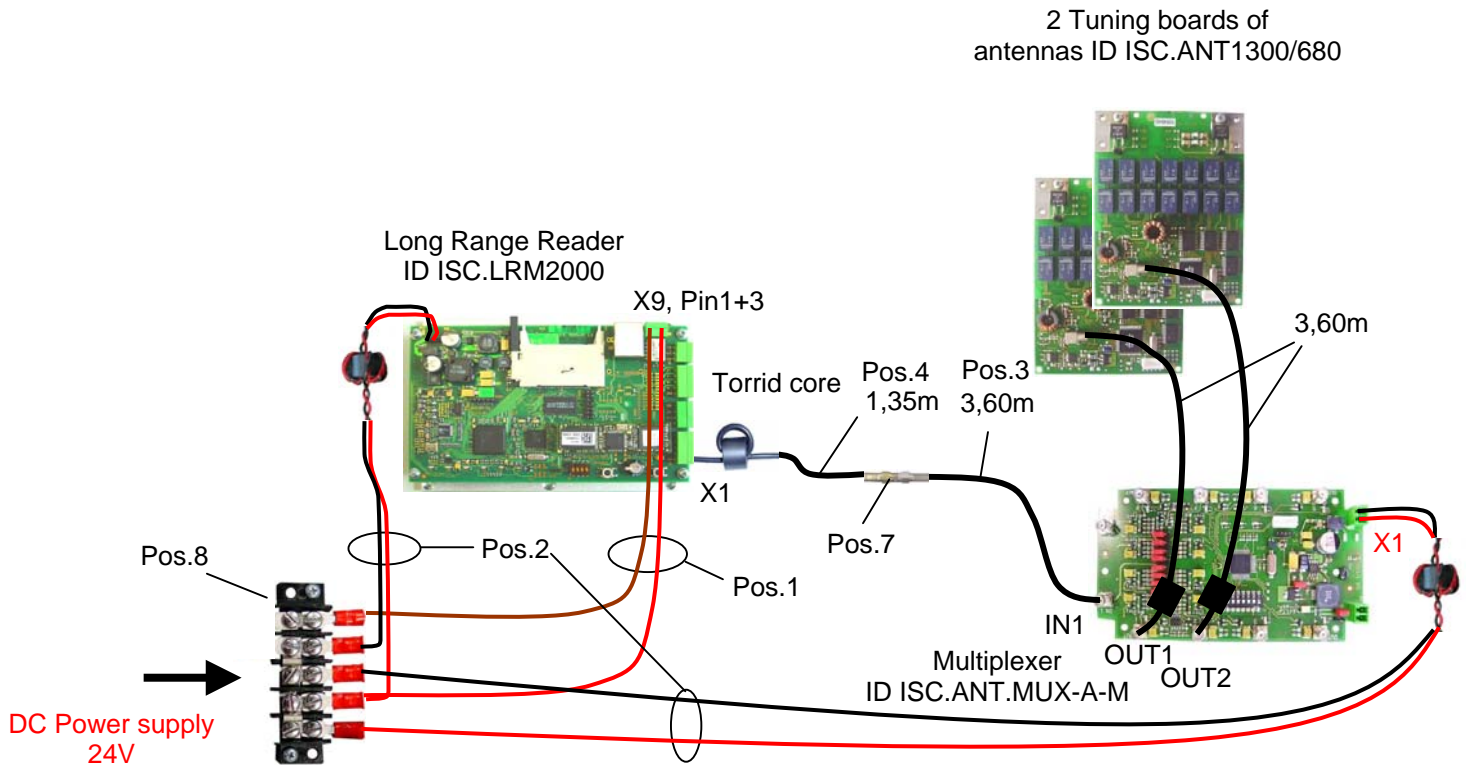

Fig. 12: Connecting the components for a gate consisting of Type A with multiplexer

The coax cables have fixed lengths and may not be shortened and therefore need to be tied into small loops (see Fig. 13: Tying the cables). Tie all cables as far away from the antenna conductor as possible. The cables must never be allowed to contact the aluminum tube.

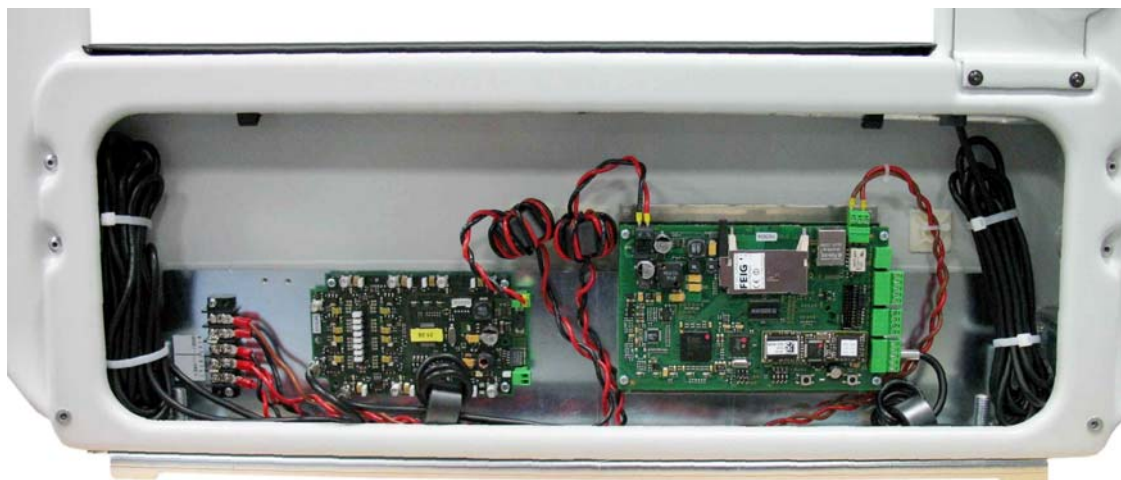

Fig. 13: Tying the cables

### 4.3.4 Setting the Multiplexer

Set the jumpers JP1-JP8, JP11-JP18 and DIP switch S1 on the Multiplexer as shown. More on setting the ID ISC.ANT.MUX Multiplexer can be found in the corresponding installation manual (M30201-xde-ID-B).

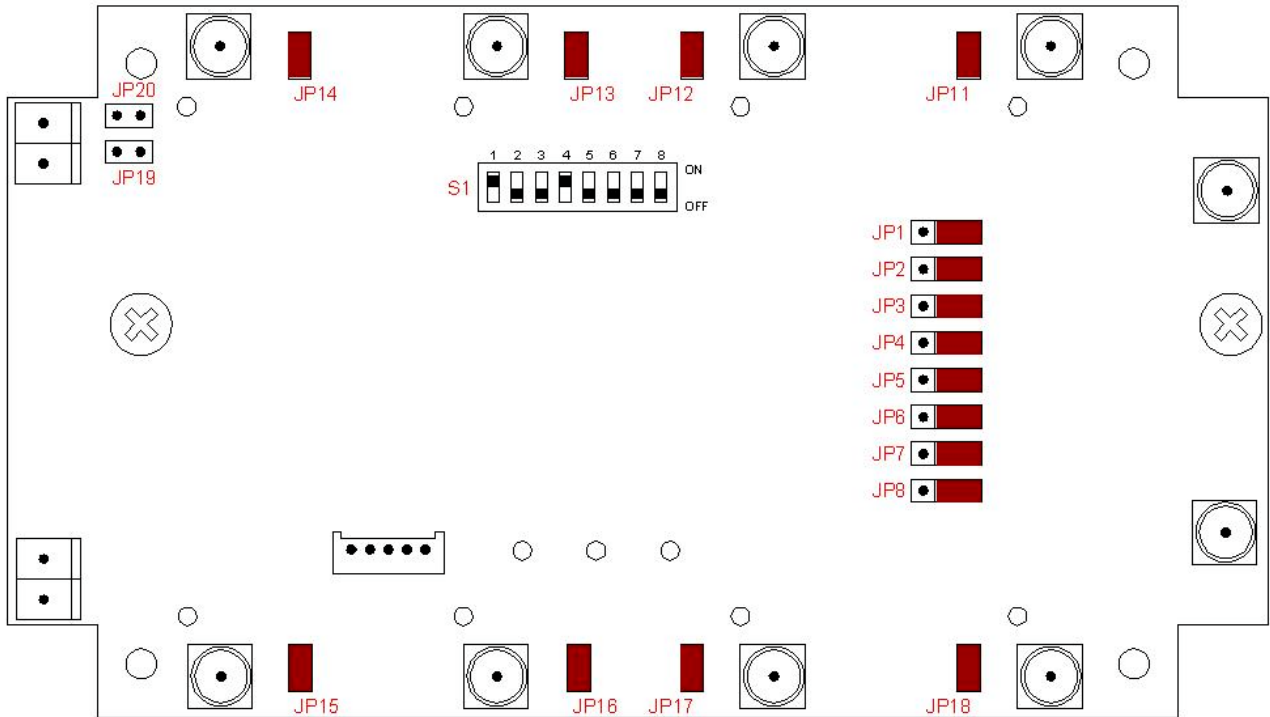

Fig. 14: DIP-Switch and Jumper positions

### 4.3.5 DIP Switch Configuration

The DIP switch should be configured as indicated in the following table:









Table 5: DIP switch configuration

DIP-switch S1							
1	2	3	4	5	6	7	8
ON	OFF	OFF	ON	-	-	-	-

### 4.3.6 Jumper Configuration

Jumpers JP1 to JP8 must be set according to the following table.

Table 6: Configuration JP1-8

Jumper Position	
JP1	
JP2	
JP3	
JP4	
JP5	
JP6	
JP7	
JP8	

In addition, close jumpers JP11 to JP18.

### 4.3.7 Setting the Antenna Tuner

To check the settings of the antenna tuner the antenna foot has to be opened. For that you must remove the to fastening screws (hexagon socket width A/F2,5) of the antenna foot cover and remove it upwards. Fig. 10

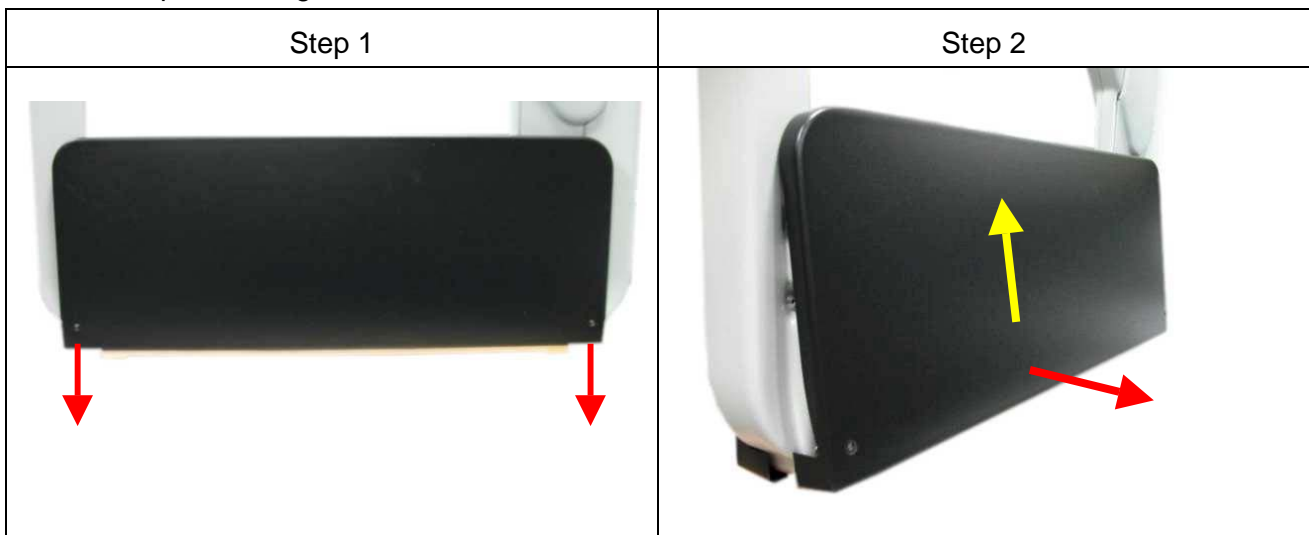

Fig. 15: Opening of the antenna foot

Now you must remove the to fastening screws (hexagon socket width A/F2,5) of the antenna tuner cover and remove it upwards. Fig. 11

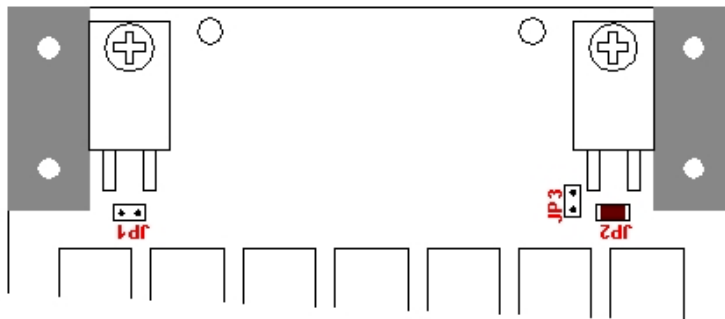

Fig. 16 Removing the antenna tuner cover

ID ISC.ANT1300/680-A antennas must be set as follows (JP3 is factory set to closed and must be opened):

Table 7: Jumper settings for Antenna Tuner



Function	Jumper	Position
1Ω Q resistor	JP1	open
2Ω Q resistor	JP2	closed
Antenna switch	JP3	open
Capacitor C1	JP 11,12,13,14	open
Capacitor C2	JP 21,22,25,26	open
	JP 23,24	closed



Verify these settings. More on setting the ID ISC.DAT antenna tuner can be found in the corresponding installation manual (M40401-xde-ID-B).



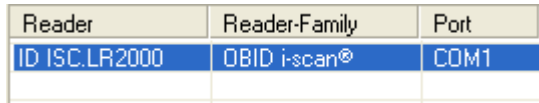

4.3.8 Reader Configuration with Multiplexer

To tune the antennas, open the ISOStart software and first read out the current configuration of the Reader:

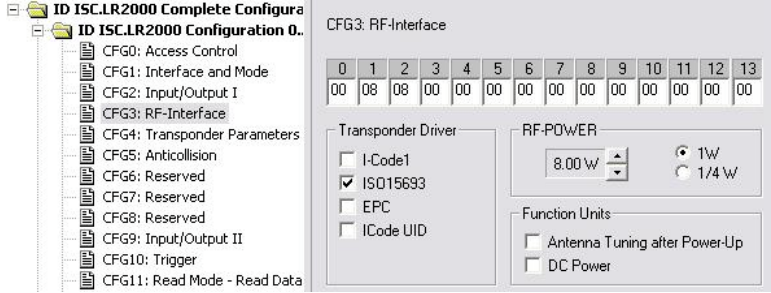
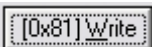
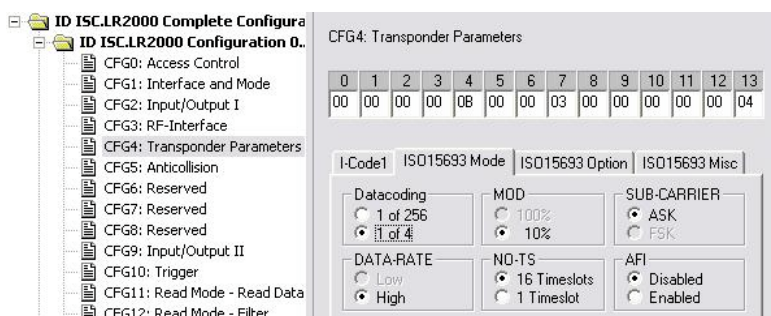
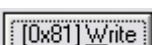
Step	Action	Note
1	Start ISOStart Software	
2	Run „Detect“...	
3	...follow „New-File Assistant“...	
4	...and read out the current Reader Configuration	<input checked="" type="checkbox"/> Read the complete Reader Configuration

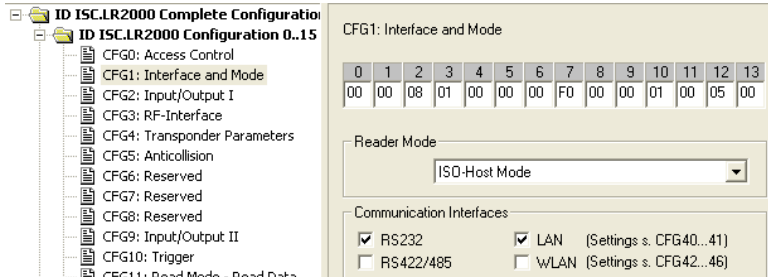
Then set the operating power, Transponder Parameters and ISO Host Mode:

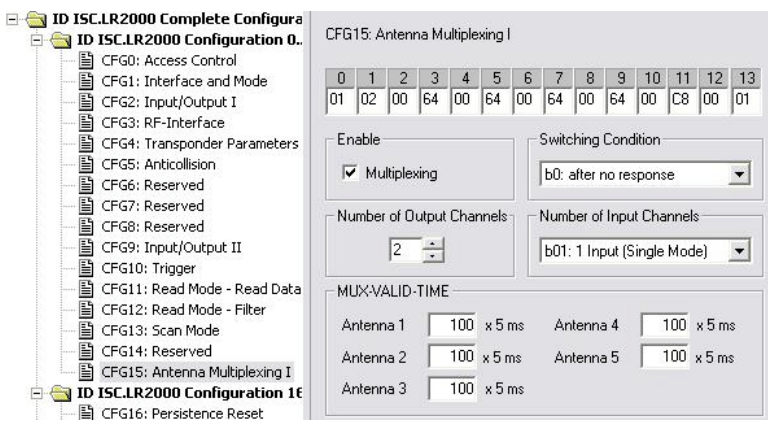

Step	Action	Note
1	Select “Configuration”	
2	<b>CFG3: RF-Interface</b> “RF-POWER” (here 8W)  Select “Transponders-Drivers” (here ISO 15693)	
3	Set by clicking on “Write”	
4	<b>CFG4: Transponder Parameters</b> Configure the parameters as follows (ISO15693 Mode): <ul style="list-style-type: none"> <li>• „Datacoding“ – 1 of 4</li> <li>• „MOD“ – 10%</li> <li>• „SUB-CARRIER“ – ASK</li> <li>• „DATA-RATE“ – High</li> <li>• „NO-TS“ – 1 Timeslot</li> <li>• „AFI“ – Disabled</li> </ul>	  Note: National RF regulations may require different settings. (see 4.7 Configuring the Reader in accordance with national RF regulations)
5	Set by clicking on “Write”	

Step	Action	Note
6	<p><b>CFG1: Interface and Mode</b></p> <p>To tune, activate "ISO-Host Mode"</p>	
7	<p>Set by clicking on "Write"</p>	
8	<p><b>CFG15:</b></p> <p><b>Antenna Multiplexing I</b></p> <p>Activate „Multiplexing“</p> <p>Configure the parameters as follows:</p> <ul style="list-style-type: none"> <li>• „Switching Condition“ – after no response</li> <li>• „Number of Input Channels“ – 1 Input (Single Mode)</li> <li>• „MUX-Valid Time“ – 100 x 5 ms</li> <li>• „Number of Output Channels“ =&gt; 2</li> </ul>	
9	<p>Set by clicking on "Write"</p>	

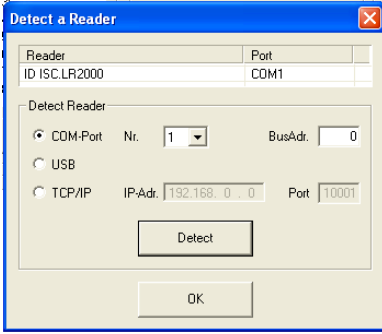
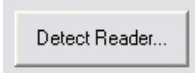
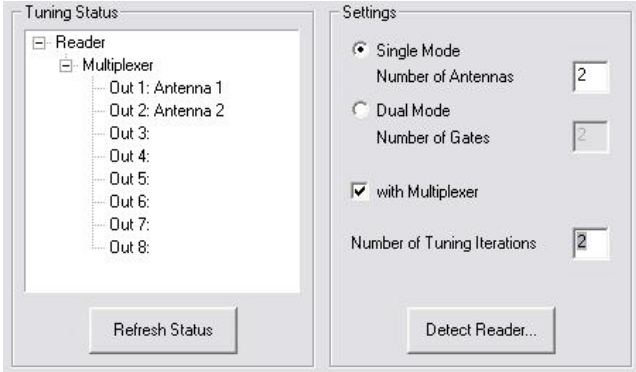
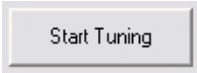

4.3.9 Tuning the Gate Antenna with Multiplexer

Before tuning the gate antenna, you must quit the ISOStart software. Then the gate can be tuned as follows:

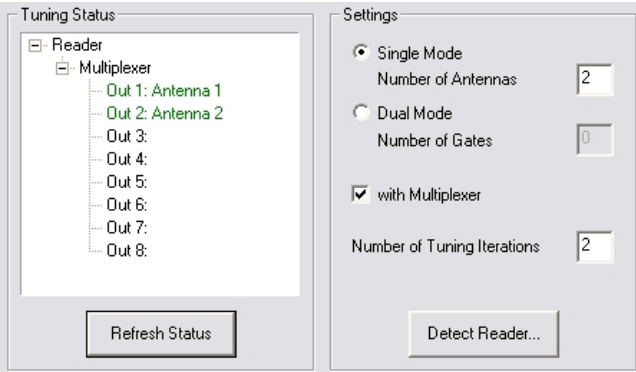
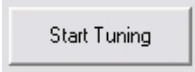

Step	Action	Note
1	Start "DATuningTool" software	 DATuningTool
2	Select "Detect Reader...". In the „Detect Reader“ window select the interface (COM-Port 1, BusAdr. 0) and then select "Detect".	 
3	Use „Settings“ to enter the configuration: Single Mode, Number of Antennas 2 Click on "with Multiplexer" Number of Tuning Iterations 3	
4	Activate „Start Tuning“ and wait until the tuning process is finished.	 
5	The tuning status is displayed after each tuning pass. After successful tuning both antennas are shown in green.	
6	If this does not succeed on the first try, start the process over again by clicking on „Start Tuning“	

After successful tuning, close the DATuningTool again.

## 4.4 Testing the Gate Antenna

After tuning the gate antenna, you can check for proper function using the Reader, the ISOStart service software and a Smart Tag. Here the Noise Level and performance of the gate are tested.

### 4.4.1 Checking the Noise Level

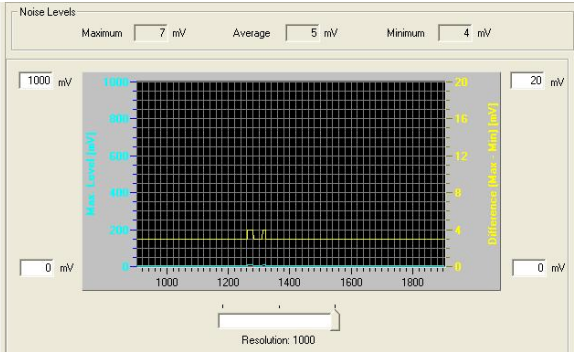
Step	Action	Note
1	Activate "Test and Measurement"	
2	Select „Noise Level“ and start by clicking on „Start“	
3	Normal Noise Level values: Average: < 50mV Difference (Max-Min): < 30mV	

If the values are not met, check the following:

- Are all cables pulled tight and do they make good contact?
- Were the ring cores installed in the antenna cable?
- Were the cables routed as specified?
- Are other RFID systems installed nearby?
- Are there large metal parts near the antenna (distance < 1.0 m)?
- Are there devices nearby which may emit noise interference (larger machines or wireless devices)?
- Are there interference from the mains?

To determine which devices may be disturbing the gate, briefly disconnect them from the mains.

4.4.2 Reading a Serial Number

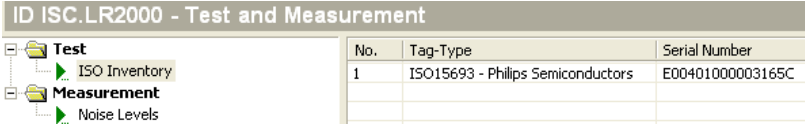
Step	Action	Note												
1	Attach a tag to an antenna	Use adhesive tape, for example												
2	Select „Test and Measurement“													
3	Select „ISO Inventory“ function and activate by clicking on „Start“. The serial number and tag type will be shown in the display.	 <table border="1" data-bbox="976 689 1444 779"> <thead> <tr> <th>No.</th> <th>Tag-Type</th> <th>Serial Number</th> </tr> </thead> <tbody> <tr> <td>1</td> <td>ISO15693 - Philips Semiconductors</td> <td>E00401000003165C</td> </tr> <tr> <td> </td> <td> </td> <td> </td> </tr> <tr> <td> </td> <td> </td> <td> </td> </tr> </tbody> </table>	No.	Tag-Type	Serial Number	1	ISO15693 - Philips Semiconductors	E00401000003165C						
No.	Tag-Type	Serial Number												
1	ISO15693 - Philips Semiconductors	E00401000003165C												

4.4.3 Testing the performance

In this test the capture area of the gate antenna described in [4.1 Project Notes](#) is checked. For other tags or other configurations the indicated ranges and read areas may differ accordingly.

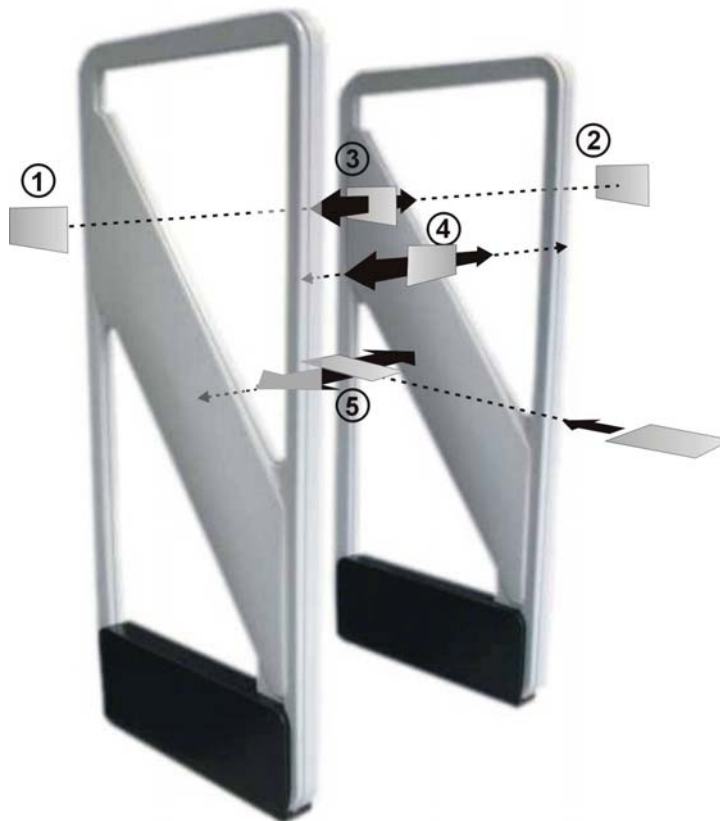

Fig. 17: Performance Test of the gate antenna

The test begins by checking the read range outside the gate (see Fig. points ① and ②), assuming the configuration and locality permit it. Start the ISO Inventory command in the ISOStart program as described in [4.4.2 Reading a Serial Number](#). If the tag is oriented parallel to the antenna towards the outside, a read range of 65 to 75 cm should be achieved.

The three tag orientations are checked inside the gate. This corresponds to the lines and orientations ③④⑤. Now slowly move the tag in the vertical and parallel direction with respect to the antenna along the line ③ from one side to the other. The tag should always be read.

Then repeat this along the line ④ in the vertical tag direction transverse to the antenna and on the line ⑤ in the horizontal tag orientation. Here again the tag should always be read.

**The tag should be read within the gate when moving horizontally through the gate in all 3 read orientations.**

If one or more „holes“ are detected, check the noise values on the Reader (see [4.4.1 Checking the Noise Level](#)) .

The following may result in faulty readings:

- Antenna improperly installed (orientation, antenna distance, check cabling)
- Metal near the antennas is detuning or interfering with them.
- The antennas are not properly tuned.
- Noise level too high ( $V_{max} - V_{min} \geq 30$  mV)
- Tag too insensitive, detuned or defective
- Reader improperly configured (transmitting power, transponder type, modulation, transponder parameters, etc.).
- A cable is defective or has a poor contact.
- Reader, Power Splitter or antenna defective.

---

## 4.5 Connecting and Setting the Alarm Kit (optional)

---

The solution provided here presumes that all alarm indicators (buzzer) are wired in parallel and switched through the relay X11 on the ID ISC.LR2000-A-M Reader. The pulse duration can be set (CFG2 / REL1) between 100 ms and 6553.5 s by adjusting the Reader configuration. Relay X11 provides a changeover contact for low voltages.

---

### 4.5.1 Installing the Alarm Indicators

---

The acoustic indicator, the buzzer, is installed in the antenna base as shown in Fig. 18. For the installation you have to use the attached mounting bracket and the screws. The volume can be adjusted with the attached manual volume controller which has to be mounted first.

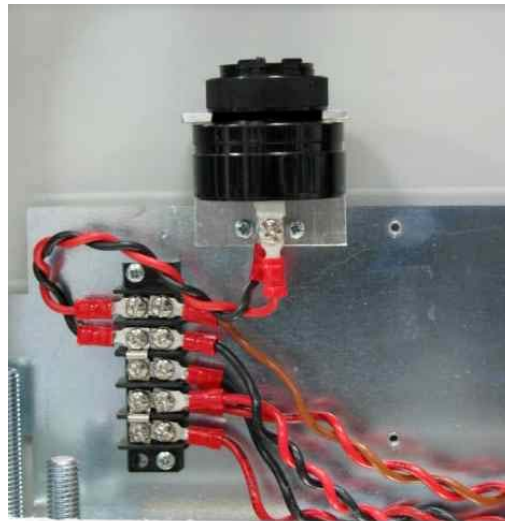

Fig. 18: Installing the buzzer

---

### 4.5.2 Connecting the Indicators

---

The indicators are connected as shown in . The red wire (+) has to be connected with terminal 5 and the black wire (GND/-) has to be connected with terminal 4 of the terminal block. Corresponding to that the wires have to be connected to the buzzer.

**Notes:**

***The relay outputs are dimensioned for max. 24 V DC / 2 A.***







***The relay outputs are intended only for switching resistive loads. If an inductive load is used, the relay contacts must be protected by an external protection circuit.***

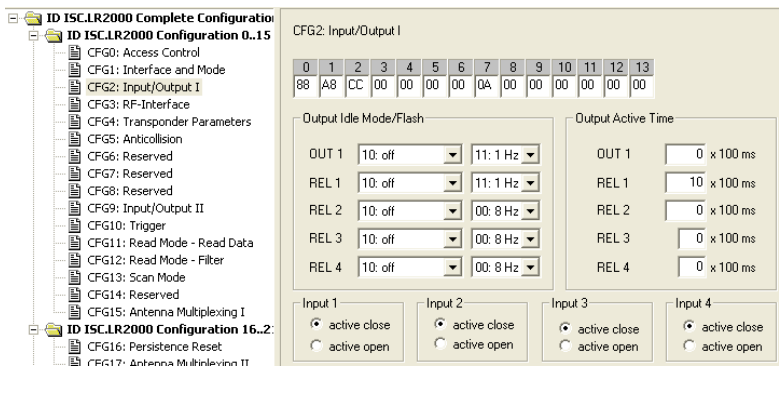

***Reversing the polarity or overloading the outputs will destroy them.***

***See also Installation Manual ID ISC.LRM2000-A/B***

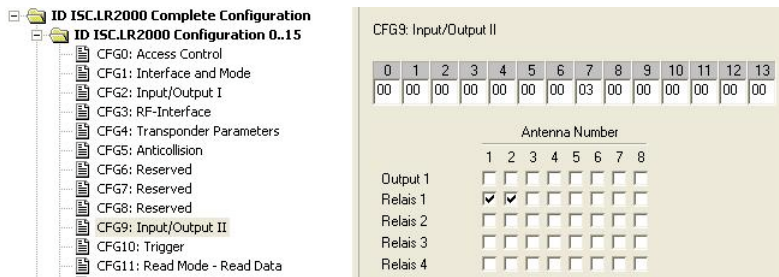
4.5.3 Reader Setting for Indicators

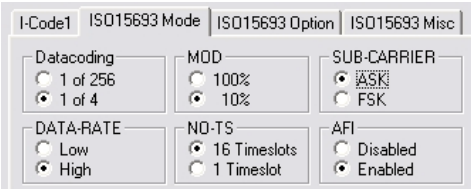
The ISOStart software can be used to set the Reader so that relay X11 opens or closes when a Transponder is read.

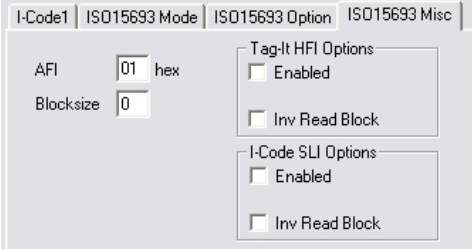



Step	Action	Note
1	Start ISOStart Software	
2	Select "Configuration" and click on "Read" to read the .	
3	<p><b>CFG2: Input/Output I:</b></p> <p>Output: „REL1“ 10: off</p> <p>Relay: Use „REL-TIME“ to enter desired alarm time for relay (10 corresponds to 1 second „REL-TIME“ 10 x 100ms</p>	
4	Set by clicking on "Write"	
5	<p><b>CFG9: Input/Output II</b></p> <p>Assign Relay 1 to antenna 1+2</p>	
6	Set by clicking on "Write"	
7	<p><b>CFG4:</b></p> <p><b>Transponder Parameter</b></p> <p>ISO 15693 Mode „AFI“ Enabled</p>	

<p>7</p>	<p>ISO 15693 Mode Enter desired value in „AFI“ field.</p>	
<p>8</p>	<p>Set by clicking on “Write”</p>	

4.5.4 Programming a Transponder with the AFI Byte

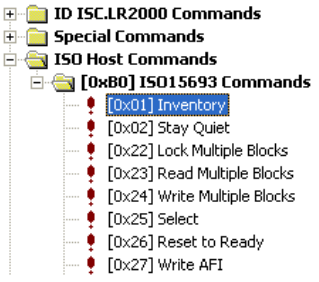
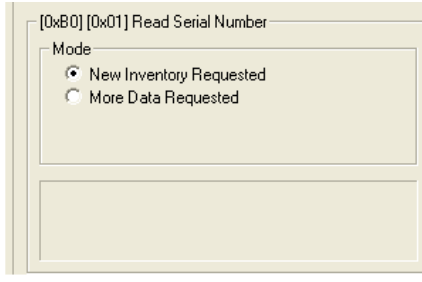
If the transponders will remain on the object when leaving the storage location, they must first be cancelled. This is generally done by writing to a particular area of the transponder.

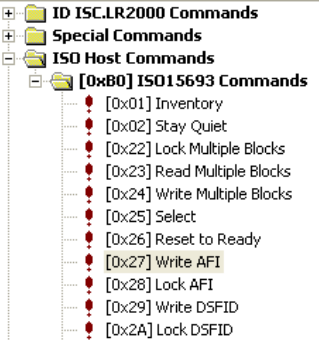
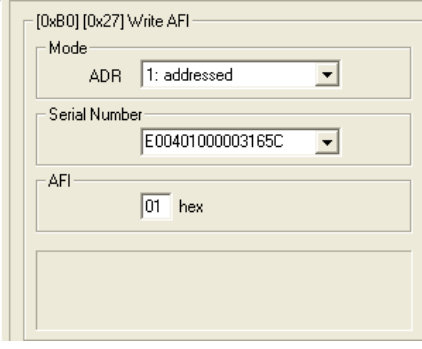
The AFI byte (Application Family Identifier) is useful for this purpose, since it is contained in nearly all transponder models in the 13.56 MHz family. To cancel, simply write a different code to the transponder than for valid transponders which trigger an alarm.

Step	Action:	Note:
1	Select „Commands“	
2	Place the Transponder in the antenna field (Antenna 1)  Select [0x01] Inventory  Select New Inventory Requested	 
3	Read UID by clicking on „Send“	
4	The serial number, DSFID and Transponder type are displayed in a window.  Write down the serial number of the Transponder	<pre>[0xB0] [0x01] Read Serial Number Statusbyte: 0x00 (OK) 1 Transponder in Protocol 1. Transponder TR-TYPE.....: 0x03 (ISO15693 - Philips Semiconductors) DSFID.....: 0x00 SNR.....: E00401000003165C</pre>
5	Select „[0x27] Write AFI“  ADR: 1: addressed  Serial Number: Select Transponder  AFI: Desired AFI Number (not equal to 00)	 
6	Read UID by clicking on „Send“	



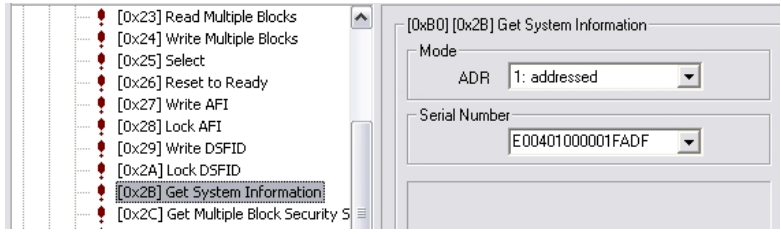



<p>7</p>	<p>To verify, read AFI byte by selecting [0x2B] Get System Information</p>	 <p>The screenshot shows a software interface with a list of commands on the left and a configuration panel on the right. The list includes: [0x23] Read Multiple Blocks, [0x24] Write Multiple Blocks, [0x25] Select, [0x26] Reset to Ready, [0x27] Write AFI, [0x28] Lock AFI, [0x29] Write DSFID, [0x2A] Lock DSFID, [0x2B] Get System Information (highlighted), and [0x2C] Get Multiple Block Security S. The configuration panel on the right is titled '[0xB0] [0x2B] Get System Information' and contains a 'Mode' section with a dropdown menu set to '1: addressed', and a 'Serial Number' section with a dropdown menu set to 'E00401000001FADF'.</p>
----------	--	--

### 4.6 Activating Buffered Read Mode

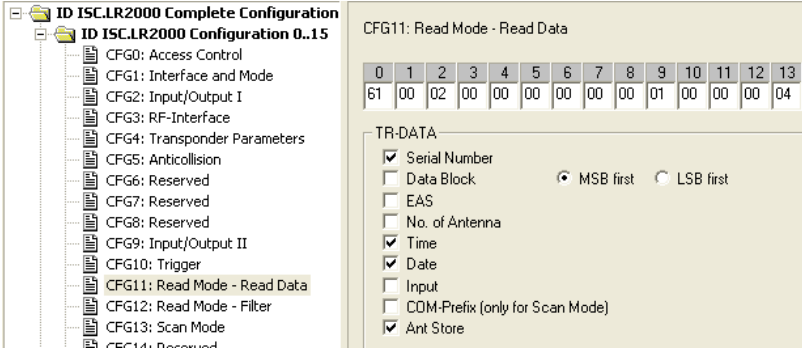
„Buffered Read Mode“ is the normal operating mode of the Reader. Here the tags are read at maximum speed and the information is stored in the Reader’s ring buffer. This data sets can be read by the host.

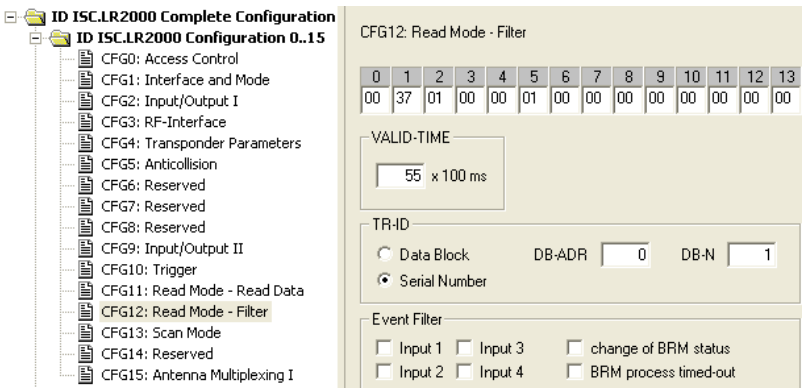
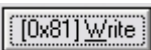
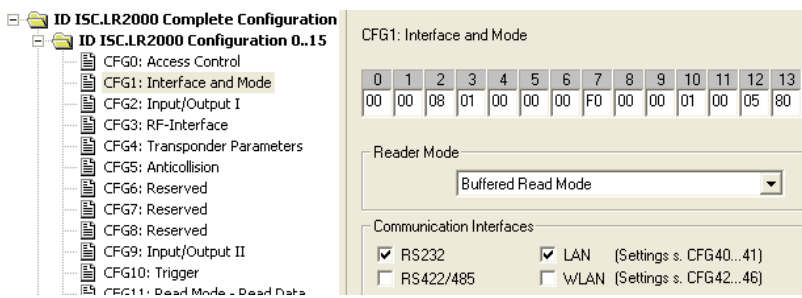
To activate „Buffered Read Mode“ proceed as follows:

Step	Action	Note
1	Select „Configuration“	
2	<b>CFG11: Read Mode –Read Data</b>  TR.DATA Serial Number Ant Store	
3	Set by clicking on “Write”	
4	<b>CFG12: Read Mode-Filter</b>  VALID-TIME  e.g. 55 x 100 ms	
5	Set by clicking on “Write”	
6	<b>CFG1: Interface and Mode</b>  Select „Buffered Read Mode“.	
7	Set by clicking on “Write”	

---

## 4.7 Configuring the Reader in accordance with national RF regulations

---

Configuration of the RFID Readers and the maximum transmitting power of the antennas are affected mainly by the country-specific RF regulations. For the entire EU the limits are set forth in the R&TTE Directive and EN 300 330. In North America this is regulated by FCC Part 15 (USA) and by the RSS-210 (Canada).

The ID ISC.ANT1300/680 antenna with the ID ISC.LR2000 Reader, when used as intended, complies with the basic requirements of Article 3 and the other relevant clauses of the R&TTE Directive 1999/5/EG of March 99. This means that operation in the 29 EU countries and the EFTA countries (EU countries plus Switzerland, Norway and Iceland) is possible with a maximum field strength of 42 dB $\mu$ A/m at 10 m distance.

RF approval (at a maximum field strength of 42 dB $\mu$ A/m at 10 m) for the ID ISC.ANT1300/680 antenna with ID ISC.LRM2000 Reader has been granted in accordance with FCC Part 15 for the USA and the RSS-210 for Canada

RF approval in accordance with EN 300 330 is still possible in all 46 CEPT countries.

The CEPT countries are:

Albania (ALB), Andorra (AND), Austria (AUT), Azerbaijan (AZE), Belarus (BLR), Belgium (BEL), Bulgaria (BUL), Bosnia and Herzegovina (BIH), Croatia (HRV), Cyprus (CYP), Czech Republic (CZE), Denmark (DNK), Estonia (EST), Finland (FIN), France (F), Germany (D), Greece (GRC), Hungary (HNG), Iceland (ISL), Ireland (IRL), Italy (I), Latvia (LVA), Liechtenstein (LIE), Lithuania (LTU), Luxembourg (LUX), Malta (MLT), Former Yugoslav Republic of Macedonia (MKD), Moldova (MDA), Monaco (MCO), Netherlands (HOL), Norway (NOR), Poland (POL), Portugal (POR), Romania (ROU), Russian Federation (RUS), San Marino (SMR), Slovak Republic (SVK), Slovenia (SVN), Spain (E), Sweden (S), Switzerland (SUI), Turkey (TUR), Ukraine (UKR), United Kingdom (G), Vatican City (CVA) and Yugoslavia.

The following restrictions are in effect (as of: July 2006):

1. Outside the EFTA countries RF approval must in all cases be applied for. The existing measuring protocols in accordance with EN 300 330 are generally sufficient.
2. Operation in Croatia (HRV) (maximum field strength 42 dB $\mu$ A/m) is only possible with an individual license!

When placing the antennas in service, the systems integrator must ensure that the prescribed mounting instructions are followed, the necessary Reader settings are made and permissible limits according to the national regulations are not exceeded.

The Reader needs to be configured as follows depending on the installation location:

Parameter	USA / Canada / Europe (42dBuA/m)
General	
RF-Power – CFG 3	maximum 8 W
Downlink RF Modulation – CFG 20 / RF-Modulation	15%
ISO15693	
Downlink RF Modulation – CFG 4 / ISO-MODE / MOD	10%
Downlink RF Data coding – CFG 4 / ISO-MODE / FAST	Fast (1/4) or Normal (1/256)
Timeslots - CFG 4 / ISO-MODE / NO-TS	1 or 16 Timeslots
Inverntory Command Option – CFG 4 / ISO-CMD-OPTION / BREAK	Complete Timeslot length at „NO TAG“

---

## 5 Technical Data

---



---

### 5.1 Antenna ID ISC.ANT1300/680- Type A

---

#### Mechanical Data

- |   |   |
|---|---|
| • Housing   | UV stabilized ABS   |
| • Dimensions ( W x H x D )                                | 720 x 1680 x 86 mm ± 5 mm   |
| • Weight  |   |
| – ID ISC.ANT1300/680-A                                    | Approx. 15 kg with/ 20 kg without packing                                 |
| • Enclosure rating  | IP 54   |
| • Color   | Antenna frame: light grey RAL 7035<br>Antenna foot: signal black RAL 9004 |
| • Mounting  |   |
| – No. of attaching points                                 | 2   |
| – Recommended anchors                                     | Ø 10 mm   |
| – Recommended minimum load capacity of the floor fastener | 5000 N / anchor   |
| • Maximum horizontal load on the top edge of the antenna  | 250 N*  |

#### Electrical Data\*\*\*\*

- |  |   |
|--|---|
| • Supply Voltage                         | 24 V $\pm$ 15 %<br>Noise Ripple : max. 150 mV |
| • Power Consumption                      | max. 32 VA                                    |
| • Operating Frequency                    | 13,56 MHz                                     |
| • Transmit Power                         | 2W – 12 W<br>(250 mW Step - Software)         |
| • Modulation                             | 10% - 30% and 100%<br>(Software configurable) |
| • Maximum transmitting power per antenna | 8 W   |

- **Permissible overall transmitting power per antenna gate**
  - EU-territory (per EN 300 330) and other CEPT nations **8.0 W**
  - USA (per. FCC Part 15) **8.0 W**
- **Outputs**
  - 1 Optocoupler **24 V  $\overline{\text{---}}$  / 30 mA**
  - 1 Differential Output **Reader Synchronisation**
  - 1 Relay ( 1 x Changeover) **24 V  $\overline{\text{---}}$  / 2 A for Alarm Kit**
- **Inputs**
  - 1 Optocoupler **Max. 24 V  $\overline{\text{---}}$  / 20 mA**
  - 1 Differential Input **Reader Synchronisation**
- **Interfaces**
  - RS232**
  - RS484 / RS422**
  - Ethernet (TCP/IP)**
  - Compact Flash II (WLAN)**
- **Protocol Modes**
  - FEIG ISO HOST**
  - BRM (Data Filtering and Data Buffering)**
  - Scan Mode (RS 232/485/422)**
  - Notification Mode (TCP/IP)**
- **Supported Transponders**
  - ISO 15693, ISO 18000-3-A, (EM HF ISO Chips, Fujitsu HF ISO Chips, KSW Sensor Chips, Infineon my-d, NXP I-Code , STM ISO Chips, TI Tag-it)**
  - NXP I-code 1, I-Code UID, I-Code EPC**
- **Ranges / pass-through width in gate with power splitter**
  - One tag orientation **approx. 105 cm\*\***
  - All tag orientations **approx. 90 cm\*\*\***
- **Ranges / pass-through width in gate with multiplexer**
  - One tag orientation **approx. 120 cm\*\***
  - All tag orientations **approx. 95 cm\*\*\***
- **Antenna connection** **1 x SMA plug (50  $\Omega$ )**
- **Antenna connector cable** **RG58, 50  $\Omega$ , approx. 2 m long**

**Ambient Conditions**

- **Temperature range**
  - Operating **–25°C to +50°C**
  - Storage **–25°C to +70°C**

**Applicable Standards**

- **RF approval**
  - Europe **EN 300 330**
  - USA **FCC Part 15**
- **EMC** **EN 301 489**
- **Safety**
  - **Low Voltage Directive** **UL 60950-1 (in preparation)**
  - **Human Exposure** **EN 50364**

\* Persistent deformation after load release approx. 1 cm.

\*\* Qty. 2 ID ISC.ANT1300/680-A antennas, antenna spacing (antenna center), same flow direction, Tag 46 mm x 75 mm ISO15693, sensitivity / minimum field strength  $H_{\min}=80$  mA/m rms, transmitting power 8 W, tag orientation parallel to antenna for horizontal movement through the antenna. The detection performance also depending of the strength of the Transponder answer signal !

\*\*\* Tag 46 mm x 75 mm ISO 15693, sensitivity / minimum field strength  $H_{\min}=80$  mA/m rms, transmitting power 8 W, aligned in all 3 dimensions for horizontal movement through the antenna. The detection performance also depending of the strength of the Transponder answer signal !

---

## 5.2 Approval

---

As per Section 4.7 Configuring the Reader in accordance with national RF regulations!

---

### 5.2.1 Europe (CE)

---

This RF equipment is in compliance with the essential requirements and other relevant provisions of Directive 1999/5/EC dated March 99.



Equipment Classification according to ETSI EN 300 330 and ETSI EN 301 489: Class 2

**The technical data of the ID ISC.LRM2000 Reader built into the ID ISC.ANT1300/680-A antenna can be found in the Installation Manual which is included with the device.**



## 5.2.2 USA (FCC) and Canada (IC)

<b>Product name:</b>	<b>ID ISC.ANT1300/680</b>
<b>Antenna name:</b>	<b>ID ISC.ANT1300/680 Type A</b>
<b>Reader name:</b>	<b>ID ISC.LRM2000-A</b>
<b>FCC ID:</b> <b>IC:</b>	<b>PJMANT1300680</b> <b>6633A-ANT130068</b>
<p><b>Notice for USA and Canada</b></p> 	<p>This device complies with Part 15 of the FCC Rules and with RSS-210 of Industry Canada.</p> <p>Operation is subject to the following two conditions.</p> <p>(1) this device may not cause harmful interference, and</p> <p>(2) this device must accept any interference received, including interference that may cause undesired operation.</p> <p>Unauthorized modifications may void the authority granted under Federal communications Commission Rules permitting the operation of this device.</p> <p>This equipment has been tested and found to comply with the limits for a Class A digital device, pursuant to Part 15 of the FCC Rules. These limits are designed to provide reasonable protection against harmful interference when the equipment is operated in a commercial environment. This equipment generates, uses, and can radiate radio frequency energy and, if not installed and used in accordance with the instruction manual, may cause harmful interference to radio communications. Operation of this equipment in a residential area is likely to cause harmful interference in which case the user will be required to correct the interference at his own expense.</p> <p>Cet appareil numérique de la classe A est conforme à la norme NMB-003 du Canada.</p>

Further information and technical data of the ID ISC.LRM2000 Reader built into the ID ISC.ANT1300/680-A antenna can be found in the Installation Manual which is included with the device.

5.2.3 USA (UL)

---

**In preparation !**



The following picture indicates the label position:

