Electromagnetic Emission
FCC MEASUREMENT REPORT
CERTIFICATION OF COMPLIANCE
FCC Part 15 Certification Measurement

PRODUCT : LCD TV
MODEL/Serial No. : LT46DW000 / E465SABA84R00018
FCC ID : PJILT46DW000
BRAND NAME : HYUNDAI
APPLICANT : HYUNDAI IT CORP.
San 136-1, Ami-ri, Bubal-eub, Icheon-si, Gyeonggi-do,
467-701, Korea
Attn. : Kim, Kyoung-Ok / Assistant Manager
MANUFACTURER : HYUNDAI IT CORP.
San 136-1, Ami-ri, Bubal-eub, Icheon-si, Gyeonggi-do,
467-701, Korea
FCC CLASSIFICATION : Class B Personal computers and peripherals
RULE PART(S) : FCC Part 15 Subpart B
FCC PROCEDURE : ANSI C63.4-2003
TEST REPORT No. : ETLE080718.563
DATES OF TEST : July 21, 2008 to July 24, 2008
REPORT ISSUE DATE : August 18, 2008
TEST LABORATORY : ETL Inc. (FCC Designation Number : KR0022)

This LCD TV, Model LT46DW000 has been tested in accordance with the measurement procedures specified in ANSI C63.4-2003 at the ETL Test Laboratory and has been shown to be complied with the electromagnetic radiated emission limits specified in FCC Rule Part15 Subpart B:

I attest to the accuracy of data. All measurement herein was performed by me or was made under my supervision and is correct to the best of my knowledge and belief. I assume full responsibility for the completeness of these measurements and vouch for the qualifications of all persons taking them.

The results of testing in this report apply to the product/system which was tested only. Other similar equipment will not necessarily produce the same results due to production tolerance and measurement uncertainties.



Hyung Seok, Lee / Chief Engineer

ETL Inc.
#584, Sangwhal-ri, Ganam-myeon, Yaju-gun, Gyeonggi-do, 469-885, Korea
Tel: 82-2-858-0786 Fax: 82-2-858-0788

Table of Contents

FCC Measurement Report

1. Introduction
2. Product Information
3. Description of Tests
4. Test Condition
5. Test Results
 - 5.1 Summary of Test Results
 - 5.2 Conducted Emissions Measurement
 - 5.3 Radiated Emissions Measurement
 - 5.4 Antenna Power Conduction Measurement
 - 5.5 Picture Sensitivity
 - 5.6 Noise figure Measurement
6. Sample Calculation
7. List of test Equipment used for Measurement

Appendix B. Test Setup Photographs

Appendix C. External Photographs

Appendix D. Internal Photographs

FCC MEASUREMENT REPORT

Scope – Measurement and determination of electromagnetic emission(EME) of radio frequency devices including intentional radiators and/or unintentional radiators for compliance with the technical rules and regulations of the U.S Federal Communications Commission(FCC)

General Information

Applicant Name	: HYUNDAI IT CORP.
Address	: San 136-1, Ami-ri, Bubal-eub, Icheon-si, Gyeonggi-do, 467-701, Korea
Attention	: Kim, Kyoung-Ok / Assistant Manager

- **EUT Type :** LCD TV
- **Model Number :** LT46DW000
- **S/N :** E465SABA84R00018
- **Frequency Range :** X-TAL → 28.322 MHz; 25.000 MHz; 19.660 MHz; 27.000 MHz;
24.000 MHz
OSC → 33.000 MHz
- **FCC Rule Part(s) :** FCC Part 15 Subpart B
- **Test Procedure :** ANSI C63.4-2003
- **FCC Classification :** Class B Personal computers and peripherals
- **Dates of Tests :** July 21, 2008 to July 24, 2008
- **Place of Tests :** ETL Inc. Testing Lab.

Radiated Emission test;
#584, Sangwhal-ri, Ganam-myeon, Yoju-gun,
Gyeonggi-do, 469-885, Korea

Conducted Emission test;
ETL Inc. Testing Lab.
371-51, Gasan-dong, Geumcheon-gu, Seoul, 153-803, Korea
- **Test Report No. :** ETLE080718.563

1. INTRODUCTION

The measurement test for radiated and conducted emission test were conducted at the ETL Inc. The site is constructed in conformance with the requirements of the ANSI C63.4-2003 and CISPR Publication 16. The ETL has site descriptions on file with the FCC for 3 m and 10 m site configurations. Detailed description of test facility was found to be in compliance with FCC Rules according to the ANSI C63.4-2003 and registered to the Federal Communications Commission (FCC Designation Number : KR0022).

The measurement procedure described in American National Standard for Method of Measurement of Radio-Noise Emission from Low-Voltage Electrical and Electronic Equipment in the Range of 9 kHz to 40 GHz (ANSI C63.4-2003) was used in determining radiated and conducted emissions from the HYUNDAI IT CORP. Model: LT46DW000

2. PRODUCT INFORMATION

2.1 Equipment Description

The Equipment Under Test (EUT) is the HYUNDAI IT CORP. (model: LT46DW000)

2.2 General Specification

Input	S-Video		1 (A/V audio common)
	Video (RCA)		2 (Audio included)
	Component(Y/Cb/Cr)		2 (Audio included)
	Antenna		1
	PC	Connection jack	D-SUB
		Max. resolution	1 920 x 1 080 @ 60 Hz
		Audio	L/R
	HDMI		2
Memory Slot		No	
Output	Video	1	
	Audio	2 (L/R, SPDIF)	
TV/Video	Analog	NTSC M / FM	
	Digital	ATSC	
	Video system	Component, S-Video, Composite, PC, HDMI	
Power	Supply	AC 100 V – 240 V, 50 Hz/60 Hz	
	Consumption power	260 W (Typical)	
	Stand-by power	< 1 W	
Dimension (W x D x H mm – Stand included)			1 143 mm x 350 mm x 845 mm
Weigh (Stand included)			31.5 kg
Control type			Remote control, Key control

3. DESCRIPTION OF TESTS

3.1 Conducted Emission Measurement

Conducted emissions measurements were made in accordance with section 11, "Measurement of Information Technology Equipment" of ANSI C63.4-2003. The measurements were performed over the frequency range of 0.15 MHz to 30 MHz using a 50 Ω / 50 μ H LISN as the input transducer to a Spectrum Analyzer or a Test Receiver. The measurements were made with the detector set for "Peak" amplitude within a bandwidth of 9 kHz or for "quasi-peak" within a bandwidth of 9 kHz.

The line-conducted emission test is conducted inside a shielded anechoic chamber room with 1 m x 1.5 m x 0.8 m wooden table which is placed 0.4 m away from the vertical wall and 1.5 m away from the side wall of the chamber room. Two LISN are bonded to the shielded room. The EUT is powered from the LISN and the support equipment is powered from the other LISN. Power to the LISNs are filtered by a noise cut power line filters. All electrical cables are shielded by braided tinned steel tubing with inner ϕ 1.2 cm. If the EUT is a DC-powered device, power will be derived from the source power supply it normally will be powered from and these supply lines will be connected to the LISN. Non-inductive bundling to a 1 m length shortened all interconnecting cables more than 1 m. Sufficient time for the EUT, support equipment, and test equipment was allowed in order for them to warm up to their normal operating condition. The RF output of the LISN was connected to the EMI Test Receiver to determine the frequency producing the maximum emission from the EUT. The frequency producing the maximum level was reexamined using to set Quasi-Peak mode by manual, after scanned by automatic Peak mode from 0.15 MHz to 30 MHz. The bandwidth of the spectrum analyzer was set to 9 kHz. The EUT, support equipment, and interconnecting cables were arranged and manipulated to maximize each emission.

Photographs of the worst-case emission can be seen in photographs of conducted emission test setup in Appendix B.

3.2 Radiated Emission Measurement

Radiated emission measurements were made in accordance with section 11, "Measurement of Information Technology Equipment" of ANSI C63.4-2003. The measurements were performed over the frequency range of 30 MHz to 1 GHz using antenna as the input transducer to a spectrum analyzer or a field intensity meter. The measurements were made with the detector set for "Quasi-peak" within a bandwidth of 120 kHz.

Preliminary measurements were made at 3 m using broadband antennas, and spectrum analyzer to determine the frequency producing the maximum emission in shielded room. Appropriate precaution was taken to ensure that all emission from the EUT were maximized and investigated. The system configuration, mode of operation, turntable azimuth and height with respect to the antenna were noted for each frequency found. The spectrum was scanned from 30 MHz to 1000 MHz using Log-Bicon antenna. Above 1 GHz, linearly polarized double ridge horn antennas were used. Final measurements were made open site at 3 m. The test equipment was placed on a wooden turn-table. Sufficient time for the EUT, support equipment, and test equipment was allowed in order for them to warm up to their normal operating condition. Each frequency found during pre-scan measurements was re-examined by manual. The detector function was set to CISPR Quasi-peak mode and the bandwidth of the receiver was set to 120 kHz or 1 MHz depending on the frequency of type of signal. The EUT, support equipment and interconnecting cables were re-configured to the set-up producing the maximum emission for the frequency and were placed on top of a 0.8 m high nonmetallic 1m x 1.5 m table. The EUT, support equipment, and interconnecting cables were re-arranged and manipulated to maximize each emission. The turntable containing the system was rotated; the antenna height was varied 1 m to 4 m and stopped at the azimuth or height producing the maximum emission. Each emission was maximized by: varying the mode of operation to the EUT and/or support equipment and changing the polarity of the antenna, whichever determined the worst-case emission.

Photographs of the worst-case emission can be seen in Photographs of the worst-case emission test setup can be seen in Appendix B.

3.3 Antenna-Conducted Power Measurements

Power on the receive antenna terminals was to be determined by measurement of the voltage present at these terminals. An antenna-conducted power measurement is performed with the EUT antenna terminals connected directly to a spectrum analyzer, if the antenna impedance matches the impedance of the measuring instrument. Otherwise, use an impedance-matching network to connect the measuring instrument to the antenna terminals of the EUT. Losses in decibels in any impedance-matching network used are added to the measured value in dB μ V.

With the EUT tuned to one of the frequency over which device operates, measure both the frequency and voltage present at the antenna input terminals over the frequency range specified in the individual equipment requirements. Repeat this measurement with the receiver tuned to another frequency until the numbers of frequencies specified have been successively measured. Power on the receive antenna terminals is the ratio of V^2/R , where V is the loss-corrected voltage measured at the antenna terminals, and R is the impedance of the measuring instrument.

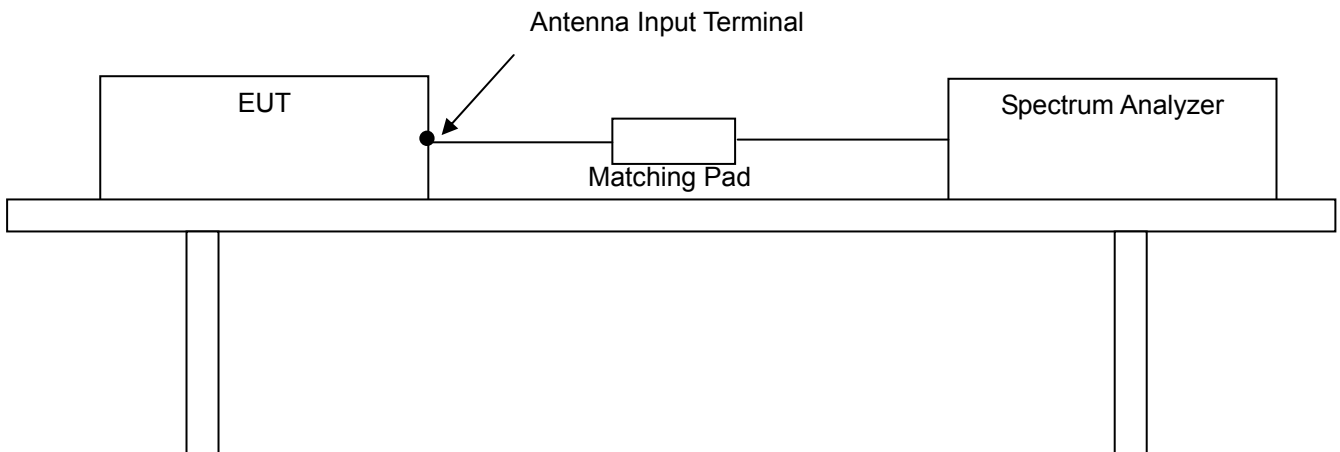

4. TEST CONDITION

4.1 Test Configuration

The device was configured for testing in a typical fashion (as a customer would normally use it). During the tests, the following conditions and configurations were used.

4.2 EUT operation

Operating Mode	The worst operating condition
Stand by mode	X
"H" pattern display(1 680 x 1 050) and MP3 file play mode	O
Color bar display mode	O

O: Worst case investigated during the Test

4.3 Support Equipment Used

Description	Model Name	Serial No.	Manufacturer
PC	DHM	G9MB71S	Dell Asia Pacific Sdn.
DVD Player 1	DVR-530C	NONE	Ellion Digital
DVD Player 2	DVH 4083	NONE	DMTECH
Keyboard	KB-9963	B26960GBUK007B	Chicony Electronics
Mouse	TGP-200M	NONE	Eyecom Technology Limited

4.4 Type of Cables Used

Device from	Device to	Type of I/O port	Length(m)	Type of shield
EUT	PC	RGB In	1.5	Shielded
EUT	PC	PC Audio In	1.2	Shielded
EUT	DVD Player 1	AV 1 (Video 1) In	1.5	Shielded
EUT	DVD Player 2	AV 2 (Video 2) In	1.5	Shielded
EUT	DVD Player 1	Video Out	1.5	Shielded
EUT	DVD Player 1	AV 1 (Video 1) Audio In	1.5	Shielded
EUT	DVD Player 2	AV 2 (Video 2) Audio In	1.5	Shielded
EUT	DVD Player 1	Audio Out	1.5	Shielded
EUT	DVD Player 1	AV 3 (S-Video) In	1.5	Shielded
EUT	DVD Player 1	Component 1 Video In	1.5	Shielded
EUT	DVD Player 2	Component 2 Video In	1.5	Shielded
EUT	DVD Player 1	Component 1 Audio In	1.5	Shielded
EUT	DVD Player 2	Component 2 Audio In	1.5	Shielded
EUT	Termination	HDMI	1.5	Shielded
EUT	Termination	HDMI	1.5	Shielded
EUT	ANT.	ANT.	>3.0	Shielded
EUT	Power socket	AC Input	1.2	Unshielded
PC	Keyboard	PS/2	1.5	Shielded
PC	Mouse	PS/2	1.5	Shielded
PC	Power socket	AC Input	1.2	Unshielded
DVD Player 1	Power socket	AC Input	1.2	Unshielded
DVD Player 2	Power socket	AC Input	1.2	Unshielded

4.5 The setup drawing(s)

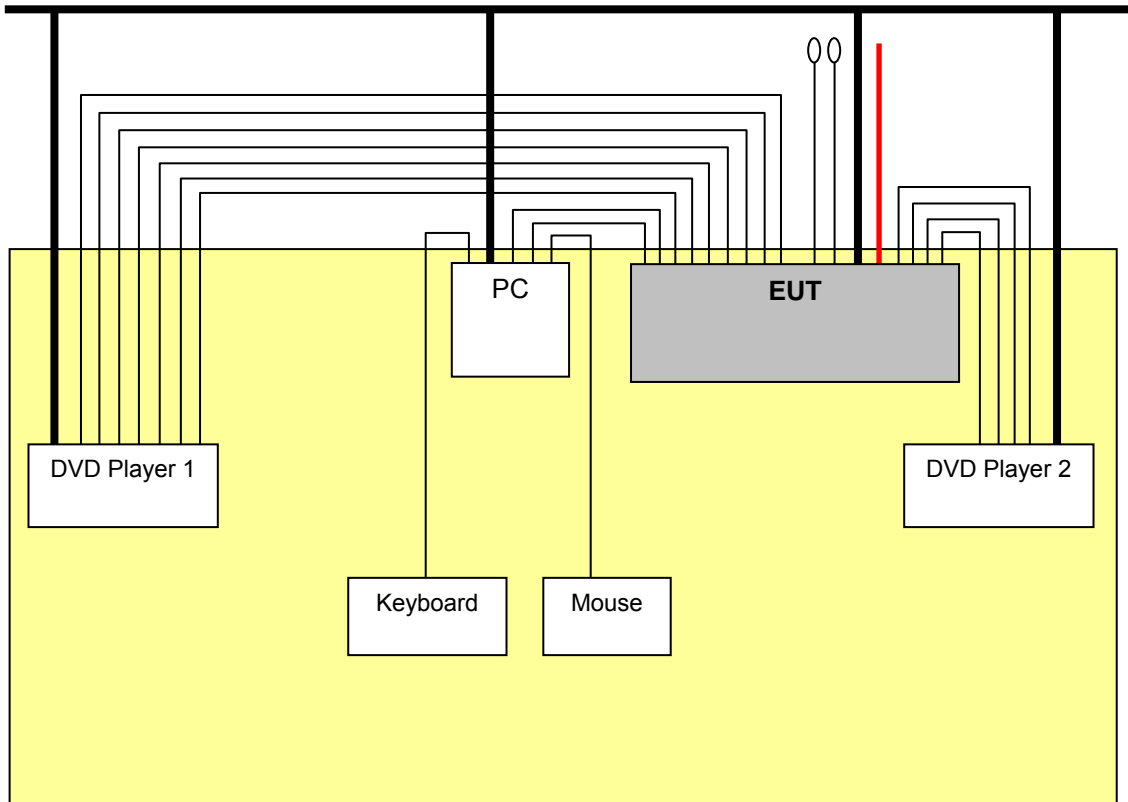

- : Data Line
- : Termination
- : Ant.
- : Power Line

5. TEST RESULTS

5.1 Summary of Test Results

The measurement results were obtained with the EUT tested in the conditions described in this report. Detailed measurement data and plots showing the maximum emission of the EUT are reported.

FCC Rule	Measurement Required	Result
15.107	Conducted Emission Measurement	Passed by 9.04 dB
15.109	Radiated Emission Measurement	Passed by 3.10 dB
15.111	Antenna Power Conduction Measurement	Passed by 7.10 dB
15.117(f)	Picture Sensitivity	<input checked="" type="checkbox"/> met <input type="checkbox"/> not met <input type="checkbox"/> N/A
15.117(g)	Noise Figure Measurement	<input checked="" type="checkbox"/> met <input type="checkbox"/> not met <input type="checkbox"/> N/A
15.119	Closed caption decoder requirements	<input checked="" type="checkbox"/> met <input type="checkbox"/> not met <input type="checkbox"/> N/A
15.120	Program blocking technology requirements	<input checked="" type="checkbox"/> met <input type="checkbox"/> not met <input type="checkbox"/> N/A

The data collected shows that the **HYUNDAI IT CORP. / LCD TV / LT46DW000** complied with technical requirements of above rules part 15.107 and 15.109 Class B Limits and Part 15 Subpart B Unintentional radiators and the TV Broadcast Receiver section of the FCC Rules.

The equipment is not modified anything, mechanical or circuits to improve EMI status during a measurement. No EMI suppression device(s) was added and/or modified during testing.

5.2 Conducted Emissions Measurement

EUT	LCD TV / LT46DW000 (S/N: E465SABA84R00018)
Limit apply to	FCC Part 15.107 Class B
Test Date	July 24, 2008
Operating Condition	"H" pattern display(1 680 x 1 050) and MP3 file play mode
Result	Passed by 9.04 dB

Conducted Emission Test Data

The following table shows the highest levels of conducted emissions on both polarizations of hot and neutral line. Detector mode: CISPR Quasi-Peak mode (6 dB Bandwidth: 9 kHz)

Frequency [MHz]	Result [dB μ V]		Phase (*L/**N)	Limit [dB μ V]		Margin [dB]	
	Quasi-peak	Average		Quasi-peak	Average	Quasi-peak	Average
0.150	40.65	28.67	N	66.00	56.00	25.35	27.33
0.205	44.02	30.84	N	63.41	53.41	19.39	22.57
0.330	37.53	25.28	N	59.45	49.45	21.92	24.17
2.710	37.32	23.30	N	56.00	46.00	18.68	22.70
3.905	44.93	30.67	N	56.00	46.00	11.07	15.33
4.890	46.96	32.53	N	56.00	46.00	9.04	13.47
6.805	50.89	36.36	H	60.00	50.00	9.11	13.64
14.970	46.97	34.99	H	60.00	50.00	13.03	15.01

NOTES:

1. * H : HOT Line , **N : Neutral Line
2. Margin value = Limit – Result
3. Measurement were performed at the AC Power Inlet in the frequency band of 150 kHz ~ 30 MHz according to the FCC Part 15



Test Engineer: **Hyung-min, Choi**

Line: HOT Line

Limit : - - - Quasi-Peak
- - - Average

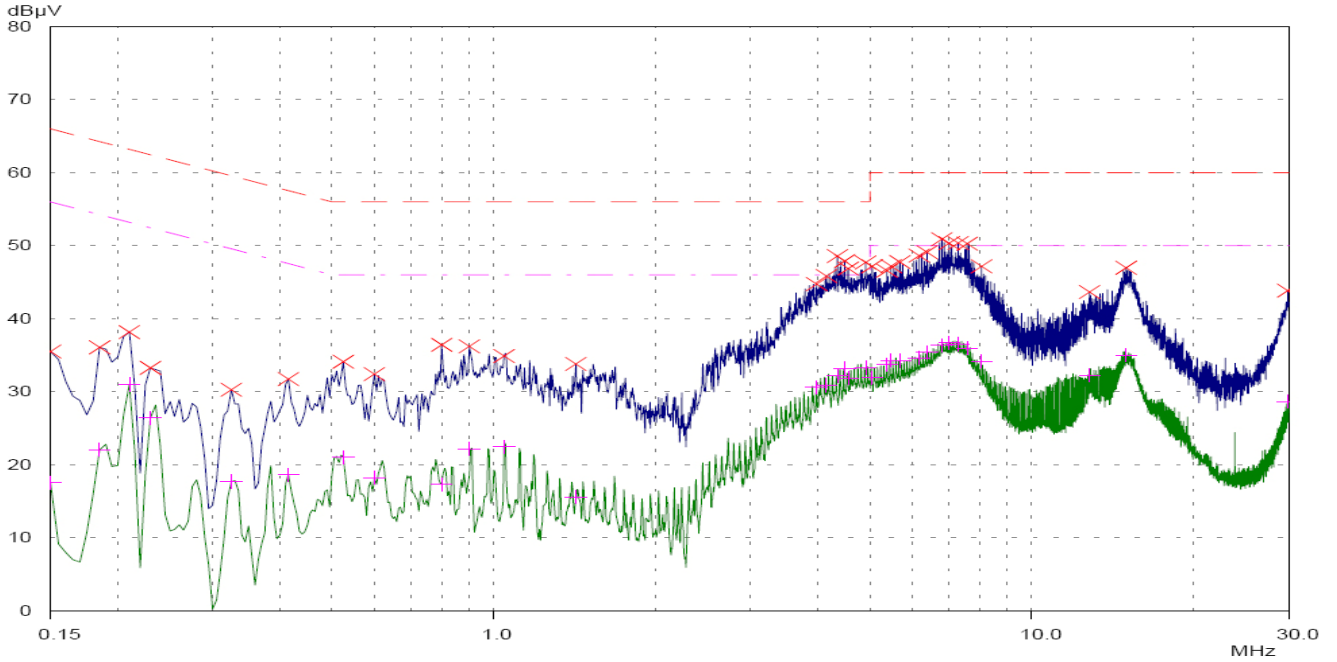

Line: Neutral Line

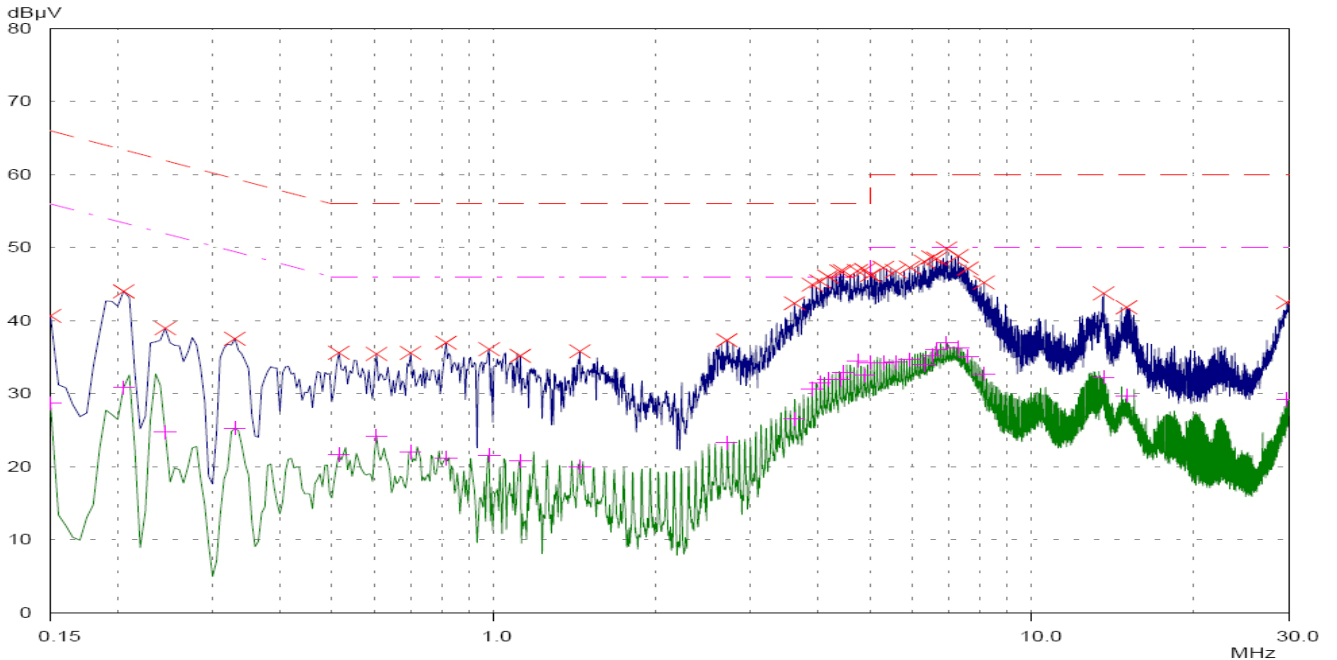

Quasi-peak ↑ x Average ↑ +

EUT	LCD TV / LT46DW000 (S/N: E465SABA84R00018)
Limit apply to	FCC Part 15.107 Class B
Test Date	July 24, 2008
Operating Condition	Color bar display mode
Result	Passed by 9.14 dB

Conducted Emission Test Data

The following table shows the highest levels of conducted emissions on both polarizations of hot and neutral line.
 Detector mode: CISPR Quasi-Peak mode (6 dB Bandwidth: 9 kHz)

Frequency [MHz]	Result [dB μ V]		Phase (*L/**N)	Limit [dB μ V]		Margin [dB]	
	Quasi-peak	Average		Quasi-peak	Average	Quasi-peak	Average
0.150	41.05	29.61	N	66.00	56.00	24.95	26.39
0.205	44.28	32.11	N	63.41	53.41	19.13	21.30
0.325	38.29	24.81	N	59.58	49.58	21.29	24.77
0.500	39.81	23.33	N	56.00	46.00	16.19	22.67
1.875	45.22	21.44	N	56.00	46.00	10.78	24.56
4.325	46.09	31.70	H	56.00	46.00	9.91	14.30
7.140	50.86	36.50	H	60.00	50.00	9.14	13.50
15.400	47.57	34.93	H	60.00	50.00	12.43	15.07

NOTES:

- * H : HOT Line , **N : Neutral Line
- Margin value = Limit – Result
- Measurement were performed at the AC Power Inlet in the frequency band of 150 kHz ~ 30 MHz according to the FCC Part 15



Test Engineer: **Hyung-min, Choi**

Line: HOT Line

Limit : - - - Quasi-Peak
- - - Average

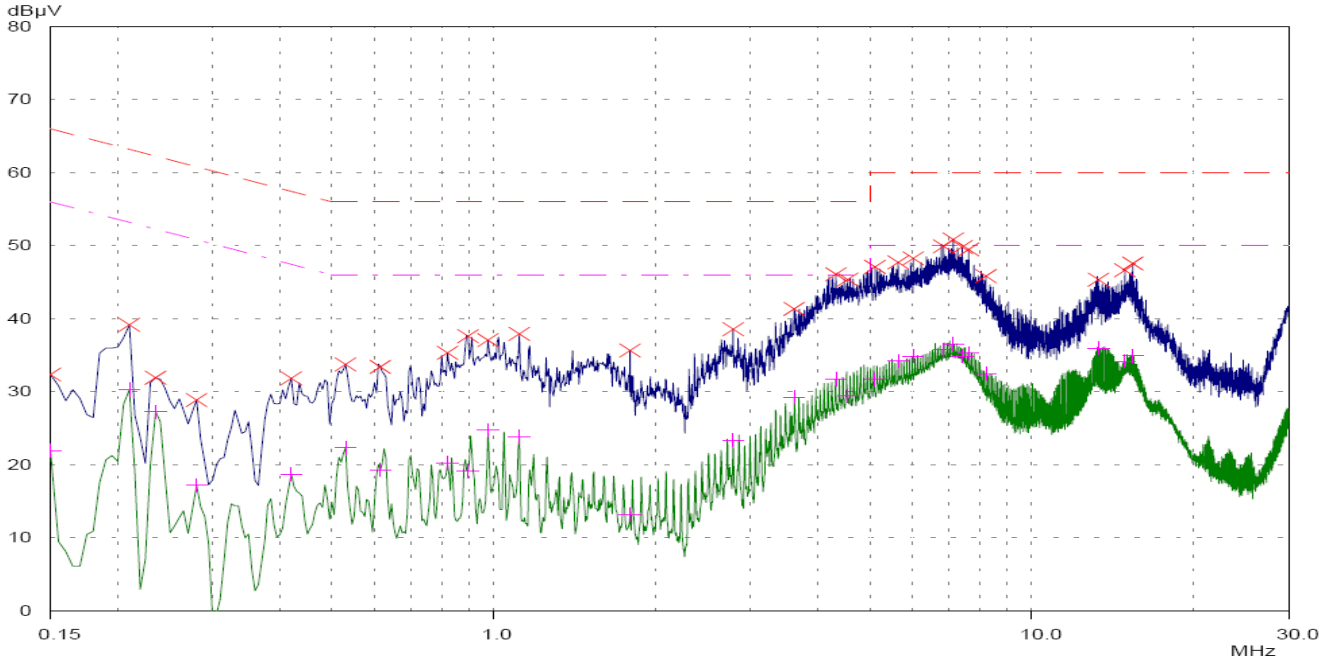

Line: Neutral Line

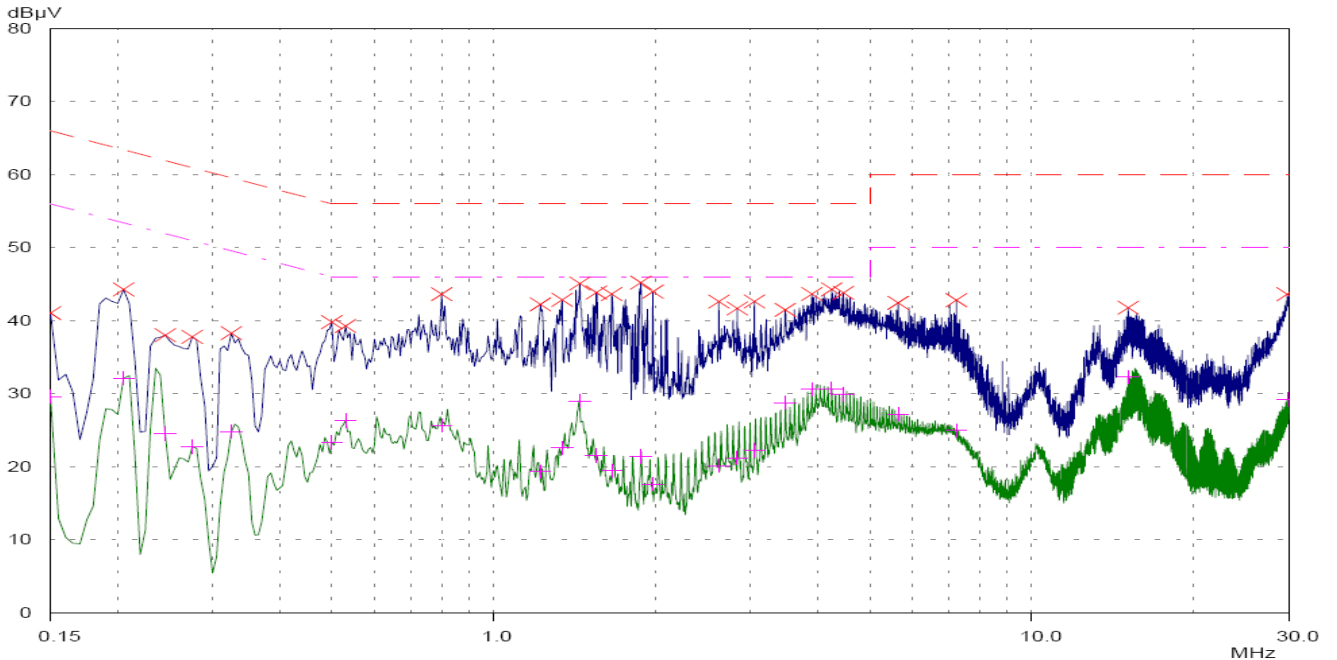

Quasi-peak ↑ x Average ↑ +

5.3 Radiated Emissions Measurement

EUT	LCD TV / LT46DW000 (S/N: E465SABA84R00018)
Limit apply to	FCC Part 15.109 Class B
Test Date	July 21, 2008
Operating Condition	"H" pattern display(1 680 x 1 050) and MP3 file play mode
Result	Passed by 3.10 dB

Radiated Emission Test Data

The following table shows the highest levels of radiated emissions on both polarizations of horizontal and vertical.
 Detector mode: CISPR Quasi – Peak mode (6 dB Bandwidth: 120 kHz)

Frequency [MHz]	Reading [dB μ V]	Polarization (*H/**V)	Ant. Factor [dB/m]	Cable Loss [dB]	Result [dB μ V/m]	Limit [dB μ V/m]	Margin [dB]
31.36	26.36	V	8.71	1.43	36.50	40.00	3.50
42.27	25.57	V	9.44	1.89	36.90	40.00	3.10
56.41	24.34	V	8.96	2.10	35.40	40.00	4.60
143.85	24.38	V	11.36	3.46	39.20	43.50	4.30
199.75	24.67	H	9.83	4.00	38.50	43.50	5.00
221.57	22.93	H	10.45	4.52	37.90	46.00	8.10
299.29	24.72	H	12.69	5.49	42.90	46.00	3.10
450.23	19.73	H	15.77	7.20	42.70	46.00	3.30

NOTES:

- * H : Horizontal polarization , ** V : Vertical polarization
- Result = Reading + Antenna factor + Cable loss
- Margin value = Limit - Result
- The measurement was performed for the frequency range 30 MHz – 1 000 MHz according to FCC Part 15.109 Class B.



Test Engineer: **Hyung-min, Choi**

EUT	LCD TV / LT46DW000 (S/N: E465SABA84R00018)
Limit apply to	FCC Part 15.109 Class B
Test Date	July 21, 2008
Operating Condition	Color bar display mode
Result	Passed by 3.90 dB

Radiated Emission Test Data

The following table shows the highest levels of radiated emissions on both polarizations of horizontal and vertical. Detector mode: CISPR Quasi – Peak mode (6 dB Bandwidth: 120 kHz)

Frequency [MHz]	Reading [dB μ V]	Polarization (*H/**V)	Ant. Factor [dB/m]	Cable Loss [dB]	Result [dB μ V/m]	Limit [dB μ V/m]	Margin [dB]
38.77	25.15	V	9.22	1.73	36.10	40.00	3.90
56.32	22.23	V	8.97	2.10	33.30	40.00	6.70
142.72	19.40	V	11.36	3.44	34.20	43.50	9.30
200.11	20.97	H	9.83	4.00	34.80	43.50	8.70
292.57	19.67	H	12.50	5.43	37.60	46.00	8.40
335.02	15.09	H	13.29	5.92	34.30	46.00	11.70
450.53	18.73	H	15.77	7.20	41.70	46.00	4.30

NOTES:

- * H : Horizontal polarization , ** V : Vertical polarization
- Result = Reading + Antenna factor + Cable loss
- Margin value = Limit - Result
- The measurement was performed for the frequency range 30 MHz – 1 000 MHz according to FCC Part 15.109 Class B.



Test Engineer: **Hyung-min, Choi**

5.4 Antenna power conduction measurement

EUT	LCD TV / LT46DW000 (S/N: E465SABA84R00018)
Limit apply to	FCC Part15 Subpart B Section 15.111
Test Date	July 22, 2008
Operating Condition	Color bar display mode
Result	Passed by 7.10 dB

Antenna power conduction test data

Tuner model:DS-QCUS-30-M45

Test port	Tuned Frequency [MHz]	Meter Reading [dB μ V]	Correction Factor [dB]	Result [dB μ V]	Limit [dB μ V]	Margin [dB]
ANT IN	1 697.00	34.40	8.50	42.90	50.00	7.10
	1 903.00	25.70	9.10	34.80	50.00	15.20

NOTES:

1. The other frequencies has 10 dB margin at least.
2. Result = Meter Reading + Correction Factor.
Margin value = Limit - Result
3. Measurements using the CISPR Quasi-peak mode and 1 MHz resolution peak mode for above 1 GHz, The limits are 2.0 nW in the frequency range from 30 MHz to 5 000 MHz.



Test Engineer: **Hyung-min, Choi**

5.5 Picture sensitivity

EUT	LCD TV / LT46DW000 (S/N: E465SABA84R00018)
Limit apply to	FCC Part15 Subpart B Section 15.117(f)
Test Date	July 23, 2008
Operating Condition	Color bar display mode
Result	Passed

Picture sensitivity test data

Tuner model:DS-QCUS-30-M45

Measured Channel	Average Level [dB μ V]	Result (dB)	Limit (dB)
VHF	25.30	1.50	< 8
UHF	26.80		

NOTES:

1. Result = UHF band average value – VHF band average value
2. Measurements using 50 Ω / 75 Ω matching transformer between spectrum analyzer and TV broadcast receiver.

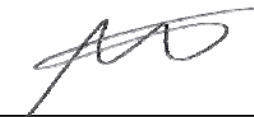

Test Engineer: **Hyung-min, Choi**

5.6 Noise figure measurement

Tuner model:DS-QCUS-30-M45

Measured Channel	Limit (dB)
471.25	< 14
549.25	
723.25	
801.25	

NOTES:

1. The limits shall not exceed 14 dB in the all television channels.

6. SAMPLE CALCULATION

Sample Field Strength Calculation

The field strength is calculated by adding the Antenna Factor and Cable Factor.
The basic equation with a sample calculation is as follows:

$$FS = RA + AF + CF$$

Where FS = Field Strength

RA = Receiver Amplitude

AF = Antenna Factor

CF = Cable Attenuation Factor

$$dB(\mu V) = 20 \log_{10} (uV) : \text{Equation}$$

Example : @ 42.27 MHz

Class B Limit	=	40.00 dBuV/m
Reading	=	25.57 dBuV
Antenna Factor + Cable Loss	=	9.44 + 1.89 = 11.33 dBuV/m
Total	=	36.90 dBuV/m
Margin	=	40.00 – 36.90 = 3.10 dB
	=	3.10 dB below Limit

7. List of test equipments used for measurements

	Test Equipment	Model	Mfg.	Serial No.	Cal. Due Date
<input checked="" type="checkbox"/>	EMI TEST Receiver	ESVS10	R & S	835165/001	09.04.04
<input checked="" type="checkbox"/>	EMI TEST Receiver	ESHS 30	R & S	840190/002	09.02.25
<input checked="" type="checkbox"/>	LISN	3816-2	EMCO	1001	08.10.05
<input checked="" type="checkbox"/>	LISN	3816-2	EMCO	1002	08.10.05
<input checked="" type="checkbox"/>	LogBicon Antenna	VULB9165	Schwarzbeck	2023	09.08.28
<input checked="" type="checkbox"/>	Spectrum Analyzer	E7405A	H.P	US41160290	08.10.04
<input checked="" type="checkbox"/>	TV TEST TRANSMITTER	SFM	R & S	835784/002	08.10.04
<input checked="" type="checkbox"/>	CCVS GENERATOR	SFF	R & S	835202/001	08.10.04
<input checked="" type="checkbox"/>	Matching Pad	RAM	R & S	836964 / 009	08.10.05
<input checked="" type="checkbox"/>	Turn-Table	DETT-03	Daeil EMC	-	N/A
<input checked="" type="checkbox"/>	Antenna Master	DEAM-03	Daeil EMC	-	N/A

End of test report