

Electromagnetic Emission
FCC MEASUREMENT REPORT
CERTIFICATION OF COMPLIANCE
FCC Part 15 Certification Measurement

PRODUCT : LCD MONITOR
MODEL/TYPE NO : P96D / NONE
FCC ID : PJIL18C0GAL0
MULTIPLE MODEL : P96DS, P96L, P96DM, P96DQ, P96DR, P96DL, P96DT, P96DU, P96DV
BRAND NAME : **HYUNDAI**
APPLICANT : HYUNDAI IBT CORP.
106, Apogongdan-gil, Gimcheon-si, Gyeongsangbuk-do, 740-862, Korea
Attn.: Yoon Suk Lee / Manager
MANUFACTURER : HYUNDAI IBT CORP.
106, Apogongdan-gil, Gimcheon-si, Gyeongsangbuk-do, 740-862, Korea
FCC CLASSIFICATION : Class B Personal computers and peripherals
RULE PART(S) : FCC Part 15 Subpart B & ICES-003 Issue 4
TEST PROCEDURE : ANSI C63.4-2003
TEST REPORT No. : ETLE130205.0128
DATES OF TEST : February 14, 2013 to February 18, 2013
REPORT ISSUE DATE : March 11, 2013
TEST LABORATORY : ETL Inc. (FCC Designation Number: KR0022, IC OATS Number: 6473B-1)

This LCD MONITOR, Model P96D has been tested in accordance with the measurement procedures specified in ANSI C63.4-2003 at the ETL/EMC Test Laboratory and has been shown to be complied with the electromagnetic radiated emission limits specified in FCC Rule Part15 Subpart B & ICES-003 Issue 4:

I attest to the accuracy of data. All measurement herein was performed by me or was made under my supervision and is correct to the best of my knowledge and belief. I assume full responsibility for the completeness of these measurements and vouch for the qualifications of all persons taking them.

The results of testing in this report apply to the product/system which was tested only. Other similar equipment will not necessarily produce the same results due to production tolerance and measurement uncertainties.

Prepared by: 
Jae Young, Kwon (Test Engineer)
March 11, 2013

Reviewed by: 
Hyung Min, Choi (Chief Engineer)
March 11, 2013

ETL Inc.
#371-51, Gasan-dong, Geumcheon-gu, Seoul, 153-803, Korea
Tel: 82-2-858-0786 Fax: 82-2-858-0788

*The test report merely corresponds to the test sample(s).
This report shall not be reproduced, in whole or in part without the written approval of ETL Inc.*

Table of Contents

FCC Measurement Report

- 1. Introduction**
- 2. Product Information**
- 3. Description of Tests**
- 4. Test Condition**
- 5. Test Results**
 - 5.1 Summary of Test Results**
 - 5.2 Conducted Emissions Measurement**
 - 5.3 Radiated Emissions Measurement**
- 6. Sample Calculation**
- 7. List of test Equipment used for Measurement**

Appendix A. FCC Label and Location

Appendix B. Test Setup Photographs

Appendix C. External Photographs

Appendix D. Internal Photographs

Appendix E. Block Diagram

Appendix F. User Manual

FCC MEASUREMENT REPORT

Scope – Measurement and determination of electromagnetic emission(EME) of radio frequency devices including intentional radiators and/or unintentional radiators for compliance with the technical rules and regulations of the U.S Federal Communications Commission(FCC)

General Information

Applicant Name : HYUNDAI IBT CORP.

**Address : 106, Apogongdan-gil, Gimcheon-si,
Gyeongsangbuk-do, 740-862, Korea**

Attention : Yoon Suk Lee / Manager

- **EUT Type :** LCD MONITOR
- **Model Number :** P96D
- **S/N :** -
- **Frequency Range :** X-tal → 12.000 MHz; 14.31818 MHz; 74.250 MHz
- **Rule Part(s) :** FCC Part 15 Subpart B & ICES-003 Issue 4
- **Test Procedure :** ANSI C63.4-2003
- **FCC Classification :** Class B Personal computers and peripherals
- **Dates of Tests :** February 14, 2013 to February 18, 2013
- **Place of Tests :** ETL Inc. Testing Lab. (FCC Designation Number : KR0022)

Radiated Emission test;
#499-1, Sagot-ri, Seosin-myeon, Hwaseong-si,
Gyeonggi-do, 445-882, Korea

Conducted Emission test;
ETL Inc. Testing Lab. (FCC Designation Number : KR0022)
371-51, Gasan-dong, Geumcheon-gu, Seoul, 153-803, Korea
- **Test Report No. :** ETLE130205.0128

1. INTRODUCTION

The measurement tests for radiated and conducted emission test were conducted at the ETL Inc. The site is constructed in conformance with the requirements of the ANSI C63.4-2003 and CISPR Publication 16. The ETL has site descriptions on file with the FCC for 3 m and 10 m site configurations. Detailed description of test facility was found to be in compliance with the requirements of Section 2.948 FCC Rules according to the ANSI C63.4-2003 and registered to the Federal Communications Commission (FCC Designation Number : KR0022).

The measurement procedure described in American National Standard for Method of Measurement of Radio-Noise Emission from Low-Voltage Electrical and Electronic Equipment in the Range of 9 kHz to 40 GHz (ANSI C63.4-2003) was used in determining radiated and conducted emissions from the HYUNDAI IBT CORP., Model: P96D.

2. PRODUCT INFORMATION

2.1 Equipment Description

The Equipment Under Test (EUT) is the LCD MONITOR (model: P96D).

The model P96D is basic model that was tested.

The model differences are same with below table;

Model name	DVI	VGA	Speaker	USB	Pivot stand	Tilt stand	Swivel stand
P96D	O	O	O	O	X	O	X
P96DS	O	O	O	X	X	O	X
P96L	O	O	X	X	O	X	X
P96DM	O	O	O	X	O	X	X
P96DQ	O	O	O	O	O	X	X
P96DR	O	O	X	O	O	X	X
P96DL	O	O	X	X	X	X	O
P96DT	O	O	O	X	X	X	O
P96DU	O	O	O	O	X	X	O
P96DV	O	O	X	O	X	X	O

* O: Existence, X: Non-existence

2.2 General Specification

Item		Specification
LCD	Visible Screen Area	409.8 mm (H) x 230.4 mm (V) (18.51 Inch)
	Pixel Pitch	0.300 mm (H) x 0.300 mm (V)
	Recommended Resolution	1 366 x 768 @ 60 Hz
	Maximum Visible Angle	170°/160° (H/V)
	Displayed Color	16.7 M
	Brightness	250 cd/m ²
	Contrast Ratio	1 000:1
	Response Time	5 msec
Input Signal	Horizontal Frequency	30 kHz – 80 kHz
	Vertical Frequency	60 kHz – 75 kHz
	Video Signal	Analog RGB, DVI
	Connector	DVI-I, AUDIO, USB
Power	Power Consumption	< 18 W (Max)
	Stand by Power	< 0.5 W
	Input Power	AC 100 V – 240 V; 50 Hz/60 Hz; 2.0 A
Multimedia Speakers		1 W x 2
Operating Environment	Operation	Temperature: (25 ± 15) °C
		Humidity: (50 ± 30) % R.H. (non-condensing)
	Storage	Temperature: (20 ± 30) °C
		Humidity: (50 ± 40) % R.H. (non-condensing)

3. DESCRIPTION OF TESTS

3.1 Conducted Emission Measurement

Conducted emissions measurements were made in accordance with section 11, "Measurement of Information Technology Equipment" of ANSI C63.4-2003. The measurements were performed over the frequency range of 0.15 MHz to 30 MHz using a 50 Ω /50 μ H LISN as the input transducer to a Spectrum Analyzer or a Test Receiver. The measurements were made with the detector set for "Peak" amplitude within a bandwidth of 9 kHz or for "quasi-peak" within a bandwidth of 9 kHz.

The line-conducted emission test is conducted inside a shielded anechoic chamber room with 1 m x 1.5 m x 0.8 m wooden table which is placed 40 cm away from the vertical wall and 1.5 m away from the side wall of the chamber room. Two LISN are bonded to the shielded room. The EUT is powered from the LISN and the support equipment is powered from the other LISN. Power to the LISNs are filtered by a noise cut power line filters. All electrical cables are shielded by braided tinned steel tubing with inner ϕ 1.2 cm. If the EUT is a DC-powered device, power will be derived from the source power supply it normally will be powered from and these supply lines will be connected to the LISN. Non-inductive bundling to a 1 m length shortened all interconnecting cables more than 1 m. Sufficient time for the EUT, support equipment, and test equipment was allowed in order for them to warm up to their normal operating condition. The RF output of the LISN was connected to the EMI Test Receiver to determine the frequency producing the maximum emission from the EUT. The frequency producing the maximum level was reexamined using to set Quasi-Peak mode by manual, after scanned by automatic Peak mode from 0.15 MHz to 30 MHz. The bandwidth of the spectrum analyzer was set to 9 kHz. The EUT, support equipment, and interconnecting cables were arranged and manipulated to maximize each emission.

Photographs of the worst-case emission can be seen in photographs of conducted emission test setup in Appendix B.

3.2 Radiated Emission Measurement

Radiated emission measurements were made in accordance with section 11, "Measurement of Information Technology Equipment" of ANSI C63.4-2003. The measurements were performed over the frequency range of 30 MHz to 40 GHz (or 5th harmonic of the highest frequency) in using antenna as the input transducer to a spectrum analyzer or a field intensity meter. The measurements below 1 GHz were made with the detector set for "Quasi-peak" within a bandwidth of 120 kHz. The measurements above 1 GHz were made with the detector set for "Peak and Average" within a bandwidth of 1 MHz.

Preliminary measurements were made at 3 m using broadband antennas, and spectrum analyzer to determined the frequency producing the maximum emission in shielded room. Appropriate precaution was taken to ensure that all emission from the EUT were maximized and investigated. The system configuration, mode of operation, turntable azimuth and height with respect to the antenna were noted for each frequency found. The spectrum was scanned from 30 MHz to 1 000 MHz using Log-Bicon antenna. Above 1 GHz, linearly polarized double ridge horn antennas were used. Final measurements were made open site at 10 m and 3 m. The test equipment was placed on a wooden turn-table. Sufficient time for the EUT, support equipment, and test equipment was allowed in order for them to warm up to their normal operating condition. Each frequency found during pre-scan measurements was re-examined by manual. The detector function was set to CISPR Quasi-peak mode and the bandwidth of the receiver was set to 120 kHz or 1 MHz depending on the frequency of type of signal. The EUT, support equipment and interconnecting cables were re-configured to the set-up producing the maximum emission for the frequency and were placed on top of a 0.8 m high nonmetallic 1 m x 1.5 m table. The EUT, support equipment, and interconnecting cables were re-arranged and manipulated to maximize each emission. The turntable containing the system was rotated; the antenna height was varied 1 m to 4 m and stopped at the azimuth or height producing the maximum emission. Each emission was maximized by: varying the mode of operation to the EUT and/or support equipment and changing the polarity of the antenna, whichever determined the worst-case emission.

Photographs of the worst-case emission can be seen in Photographs of the worst-case emission test setup can be seen in Appendix B.

4. TEST CONDITION

4.1 Test Configuration

The device was configured for testing in a typical fashion (as a customer would normally use it). During the tests, the EUT and the supported equipments were installed to meet FCC requirement and operated in a manner and which tends to maximize its emission level in a typical application.

4.2 EUT operation

The equipment under test was operated during the measurement under following conditions:

	Conditions	Remark
■	Stand by	
■	The EUT was connected as user's guide. And during the executed test program for EMI program with "H" pattern display on monitor.	VGA mode & USB mode
■	The EUT was connected as user's guide. And during the executed test program for EMI program with "H" pattern display on monitor. *	DVI mode & USB mode

* The worst case was investigated for emission test.

4.3 Support Equipment Used

Description	Model Name	Serial No.	Manufacturer	FCC
PC	D07M001	DMJFQBX	Dell Inc.	DoC
Keyboard	IGK-5300	NONE	Shenzhen Jiayewang Technology Co.,Ltd.	DoC
Mouse	MO-2100	NONE	Tonzo Industrial Co., Ltd.	DoC
USB Drive	NONE	NONE	NONE	DoC

4.4 Type of Cables Used

Device from	Device to	Type of I/O port	Length[m]	Type of shield	Used ferrite core
EUT	PC	VGA	1.5	Shielded	O
EUT	PC	DVI	1.5	Shielded	O
EUT	PC	Audio In	1.5	Shielded	O
EUT	PC	USB	1.5	Shielded	O
EUT	USB Drive	USB host	-	-	-
EUT	Power socket	AC Input	1.2	Unshielded	X
PC	Keyboard	USB	1.5	Shielded	X
PC	Mouse	USB	1.5	Shielded	X
PC	Power socket	AC Input	1.2	Unshielded	X

4.5 The setup drawing(s)

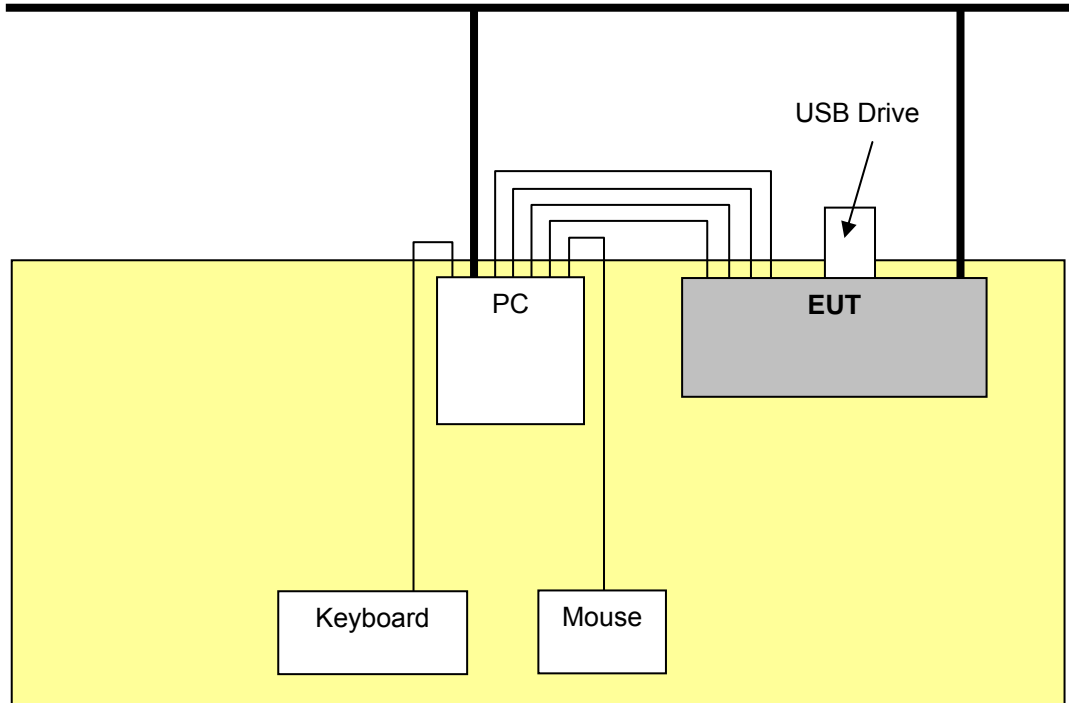

- : Signal line
- : Power line
- : Adapter

5. TEST RESULTS

5.1 Summary of Test Results

The measurement results were obtained with the EUT tested in the conditions described in this report. Detailed measurement data and plots showing the maximum emission of the EUT are reported.

FCC Rule	Measurement Required	Result
15.107(a)	Conducted Emission Measurement	Passed by 3.14 dB
15.109(g)	Radiated Emission Measurement (Below 1 GHz)	Passed by 3.20 dB
15.109(a)	Radiated Emission Measurement (Above 1 GHz)	Passed by 8.17 dB

The data collected shows that the **HYUNDAI IBT CORP. / LCD MONITOR / P96D** complied with technical requirements of above rules part 15.107(a), 15.109(g) and 15.109(a) Class B Limits and CISPR Publication 22.

The equipment is not modified anything, mechanical or circuits to improve EMI status during a measurement. No EMI suppression device(s) was added and/or modified during testing.

5.2 Conducted Emissions Measurement

5.2.1 Conducted Emissions Data

EUT	LCD MONITOR / P96D (S/N: N/A)
Limit apply to	FCC Part 15.107(a) Class B
Test Date	February 14, 2013
Operating Condition	The EUT was connected as user's guide. And during the executed test program for EMI program with "H" pattern display on monitor. (Worst case: DVI mode & USB mode)
Result	Passed by 3.14 dB

Conducted Emission Test Data

The following data and graph shows the highest levels of conducted emissions on both polarizations of hot and neutral line.

Detector mode: CISPR Quasi-Peak mode (6 dB Bandwidth: 9 kHz)

NOTES:

1. Please see the measured data and graph in next page.
2. The Level (Result) value was included the reading, antenna factor and cable loss.
3. Delta (Margin) value = Limit - Level (Result)
4. Measurement were performed at the AC Power Inlet in the frequency band of 150 kHz ~ 30 MHz according to the FCC Part 15.107(a) Class B.
5. If the average limit is met when using a Quasi-peak detector receiver, the EUT shall be deemed to meet both limits and measurement with the average detector receiver is unnecessary.

Line: HOT

ETL EMC Laboratory
 Conducted Emission Test Result

EUT: ETLE130205.0128
 Manuf:
 Op Cond:
 Operator:
 Test Spec:
 Comment: HOT

Prescan Measurement:	Detectors:	X PK / + AV
	Meas Time:	see scan settings
	Peaks:	16
	Acc Margin:	10 dB

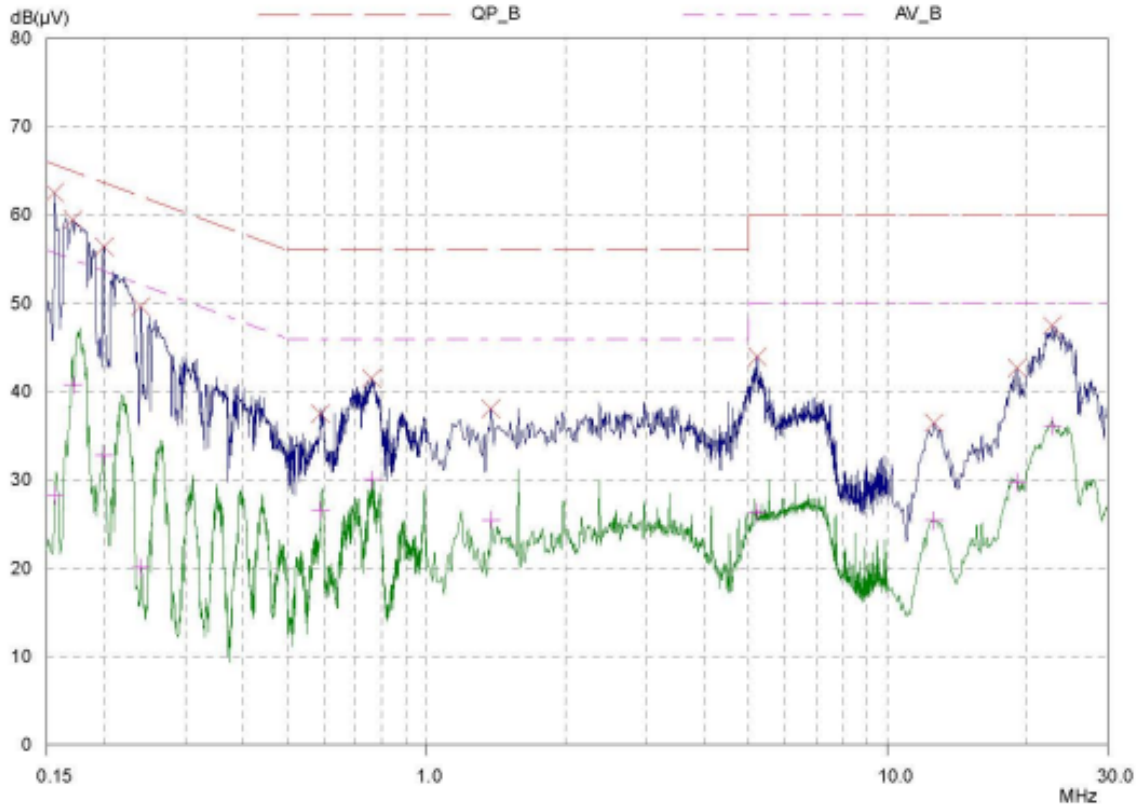

ETL EMC Laboratory
Conducted Emission Test Result

EUT: ETLE130205.0128
 Manuf:
 Op Cond:
 Operator:
 Test Spec:
 Comment: HOT

Prescan Measurement: Detectors: X PK / + AV
 Meas Time: see scan settings
 Peaks: 16
 Acc Margin: 10 dB

Peak Search Results

Frequency MHz	PK Level dB(μV)	PK Limit dB(μV)	PK Delta dB
0.156	62.53	65.67	3.14
0.171	59.47	64.91	5.44
0.2	56.35	63.61	7.26
0.24	49.58	62.10	12.52
0.588	37.48	56.00	18.52
0.761	41.49	56.00	14.51
1.38	38.06	56.00	17.94
5.21	43.94	60.00	16.06
12.6	36.45	60.00	23.55
19.1	42.66	60.00	17.34
22.8	47.47	60.00	12.53

Frequency MHz	AV Level dB(μV)	AV Limit dB(μV)	AV Delta dB
0.156	28.25	55.67	27.42
0.171	40.74	54.91	14.17
0.2	32.76	53.61	20.85
0.24	20.04	52.10	32.06
0.588	26.54	46.00	19.46
0.761	30.03	46.00	15.97
1.38	25.46	46.00	20.54
5.21	26.32	50.00	23.68
12.6	25.42	50.00	24.58
19.1	29.72	50.00	20.28
22.8	36.12	50.00	13.88

* limit exceeded

Line: Neutral

ETL EMC Laboratory
Conducted Emission Test Result
EUT: ETLE130205.0128
Manuf:
Op Cond:
Operator:
Test Spec:
Comment: NEUTRAL

Prescan Measurement: Detectors: X PK / + AV
 Meas Time: see scan settings
 Peaks: 16
 Acc Margin: 10 dB

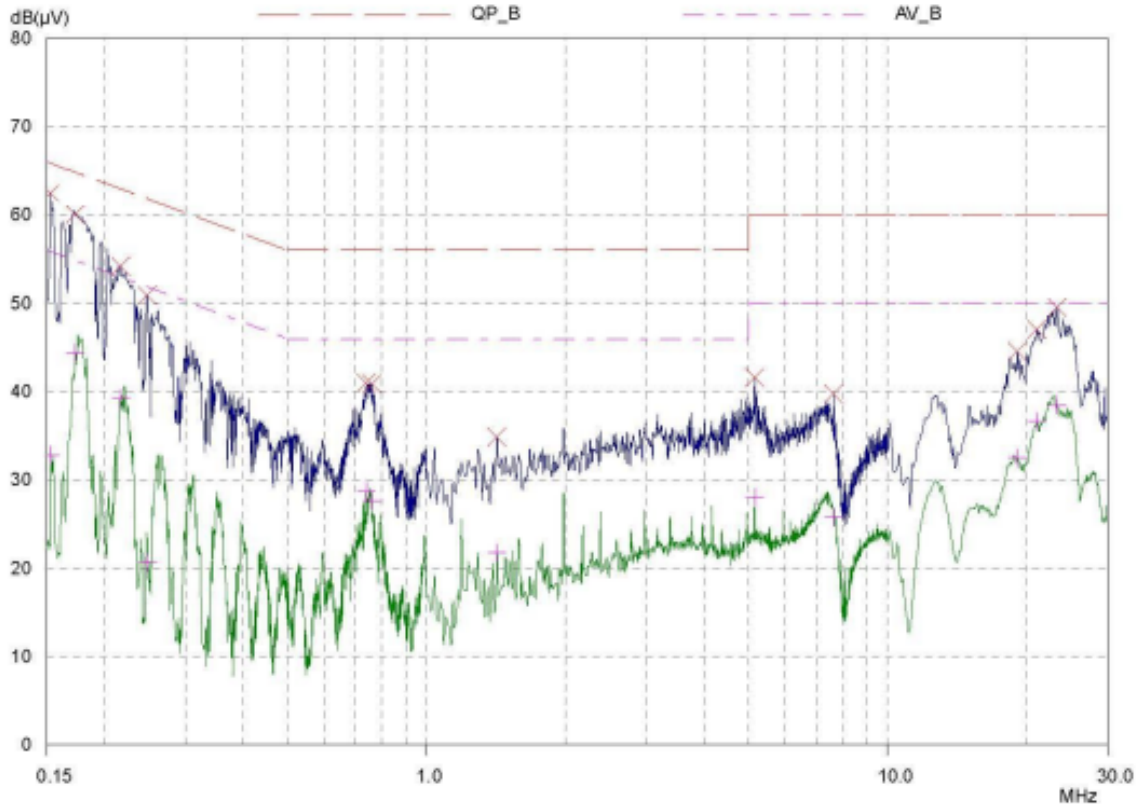

ETL EMC Laboratory
Conducted Emission Test Result

EUT: ETLE130205.0128
 Manuf:
 Op Cond:
 Operator:
 Test Spec:
 Comment: NEUTRAL

Prescan Measurement: Detectors: X PK / + AV
 Meas Time: see scan settings
 Peaks: 16
 Acc Margin: 10 dB

Peak Search Results

Frequency MHz	PK Level dB(µV)	PK Limit dB(µV)	PK Delta dB
0.153	62.55	65.84	3.29
0.173	60.03	64.82	4.79
0.217	54.17	62.93	8.76
0.248	50.88	61.82	10.94
0.741	40.98	56.00	15.02
0.761	40.88	56.00	15.12
1.42	34.88	56.00	21.12
5.15	41.58	60.00	18.42
7.65	39.73	60.00	20.27
19.1	44.55	60.00	15.45
21.1	47.06	60.00	12.94
23.3	49.53	60.00	10.47

Frequency MHz	AV Level dB(µV)	AV Limit dB(µV)	AV Delta dB
0.153	32.81	55.84	23.03
0.173	44.36	54.82	10.46
0.217	39.25	52.93	13.68
0.248	20.60	51.82	31.22
0.741	28.72	46.00	17.28
0.761	27.64	46.00	18.36
1.42	21.76	46.00	24.24
5.15	28.04	50.00	21.96
7.65	25.79	50.00	24.21
19.1	32.49	50.00	17.51
21.1	36.61	50.00	13.39
23.3	38.44	50.00	11.56

* limit exceeded

5.3 Radiated Emissions Measurement

5.3.1 Radiated Emissions Data

- Below 1 GHz

EUT	LCD MONITOR / P96D (S/N: N/A)
Limit apply to	FCC Part 15.109(g) (CISPR 22 Class B)
Test Date	February 18, 2013
Operating Condition	The EUT was connected as user's guide. And during the executed test program for EMI program with "H" pattern display on monitor. (Worst case: DVI mode & USB mode)
Result	Passed by 3.20 dB

Radiated Emission Test Data

The following table shows the highest levels of radiated emissions on both polarizations of horizontal and vertical.
Detector mode: CISPR Quasi-Peak mode (6 dB Bandwidth: 120 kHz)

Frequency [MHz]	Reading [dB(μV)]	Polarization (*H/**V)	Ant. Factor [dB/m]	Cable Loss [dB(μV)]	Result [dB(μV/m)]	Limit [dB(μV/m)]	Margin [dB]
34.50	13.49	V	11.40	1.41	26.30	30.00	3.70
79.00	16.35	V	8.84	1.61	26.80	30.00	3.20
145.00	10.04	V	12.67	1.99	24.70	30.00	5.30
341.10	10.69	H	14.29	2.82	27.80	37.00	9.20
365.70	7.15	H	14.86	2.89	24.90	37.00	12.10
424.50	8.76	H	16.15	3.09	28.00	37.00	9.00
510.00	4.49	H	17.86	3.45	25.80	37.00	11.20

NOTES:

1. * H : Horizontal polarization , ** V : Vertical polarization
2. Result = Reading + Antenna factor + Cable loss
3. Margin value = Limit - Result
4. The measurement was performed for the frequency range 30 MHz ~ 1 000 MHz according to the FCC Part 15.109(g) and CISPR 22 Class B.

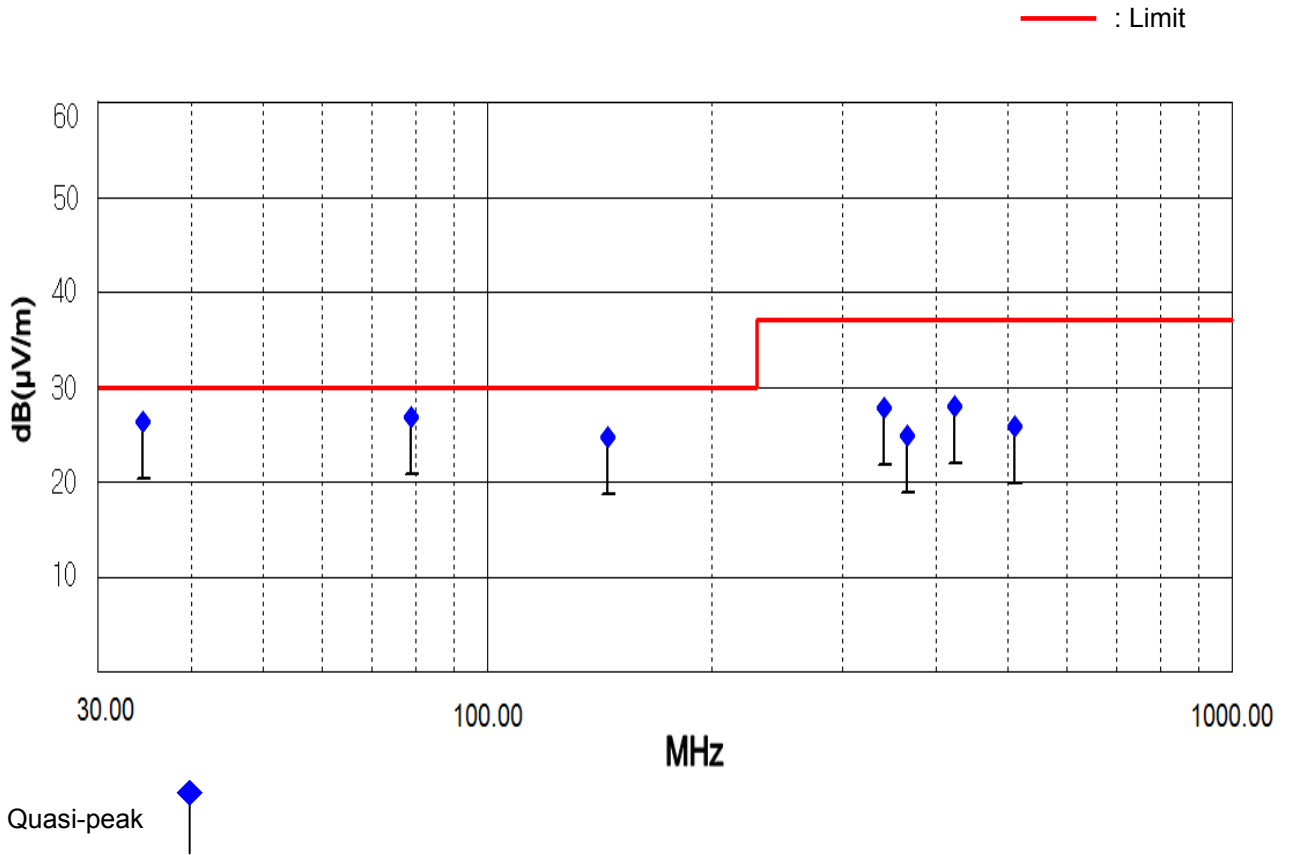

- Above 1 GHz

EUT	LCD MONITOR / P96D (S/N: N/A)
Limit apply to	FCC Part 15.109(a) Class B
Test Date	February 17, 2013
Operating Condition	The EUT was connected as user's guide. And during the executed test program for EMI program with "H" pattern display on monitor. (Worst case: DVI mode & USB mode)
Result	Passed by 8.17 dB

Radiated Emission Test Data

The following table shows the highest levels of radiated emissions on both polarizations of horizontal and vertical. Detector mode: CISPR Peak mode, Average mode

Frequency [MHz]	Reading [dB(μV)]		Polarity (*H/**V)	Ant. Factor [dB/m]	Cable Loss [dB]	Result [dB(μV/m)]		Limit [dB(μV/m)]		Margin [dB]	
	Peak	Average				Peak	Average	Peak	Average	Peak	Average
1 359.70	57.08	56.28	V	24.99	-35.47	46.60	45.80	73.97	53.97	27.37	8.17
1 593.50	62.82	50.12	V	25.37	-35.19	53.00	40.30	73.97	53.97	20.97	13.67
1 989.80	57.01	40.31	V	26.02	-34.54	48.50	31.80	73.97	53.97	25.47	22.17
2 038.30	55.76	43.26	V	26.14	-34.49	47.40	34.90	73.97	53.97	26.57	19.07
2 389.80	57.72	41.02	V	27.02	-34.24	50.50	33.80	73.97	53.97	23.47	20.17
2 975.50	55.04	50.14	V	28.50	-33.14	50.40	45.50	73.97	53.97	23.57	8.47
3 054.60	54.26	46.66	V	28.62	-32.98	49.90	42.30	73.97	53.97	24.07	11.67

NOTES:

1. * H : Horizontal polarization , ** V : Vertical polarization
2. Cable loss = Cable loss + Amp. Gain
3. Result = Reading + Antenna factor + Cable loss
4. Margin value = Limit - Result
5. The measurement was performed for the frequency range 1 GHz ~ 6 GHz according to FCC Part 15.109(a) Class B.
6. Upper frequency of measurement range: 5th harmonic of the highest frequency.

Polarization: Vertical

Limit : — Peak
— Average

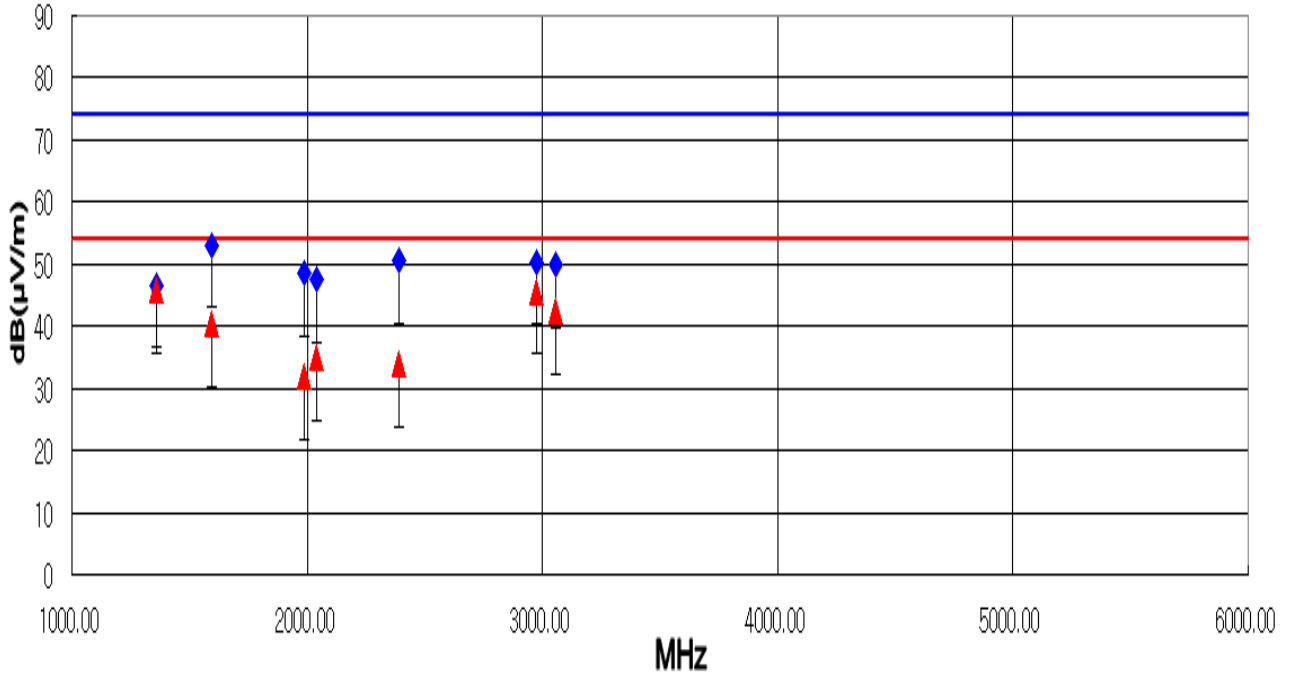

Peak ◆ Average ▲

6. SAMPLE CALCULATION

Sample Field Strength Calculation

The field strength is calculated by adding the Antenna Factor and Cable Factor.
The basic equation with a sample calculation is as follows:

$$FS = RA + AF + CF - PA$$

Where FS = Field Strength
 RA = Receiver Amplitude
 AF = Antenna Factor
 CF = Cable Attenuation Factor
 PA* = Preamplifier Factor

* PA is only be used for the measuring frequency above 1 GHz.

$$dB(\mu V) = 20 \log_{10} (\mu V) : \text{Equation}$$

$$dB(\mu V) = dBm + 107$$

Example : @ 79.00 MHz

Class B Limit	= 30.00 dB(μ V/m) (CISPR 22 Class B)
Reading	= 16.35 dB(μ V)
Antenna Factor + Cable Loss	= 8.84 + 1.61 = 10.45 dB(μ V/m)
Total	= 26.80 dB(μ V/m)
Margin	= 30.00 – 26.80 = 3.20 dB
	= 3.20 dB below Limit

7. List of test equipments used for measurements

	Test Equipment	Model	Mfg.	Serial No.	Cal. Date	Cal. Due Date
<input checked="" type="checkbox"/>	EMI Test Receiver	ESVS 10	R&S	835165/001	12.03.20	13.03.20
<input checked="" type="checkbox"/>	EMI Test Receiver	ESCS30	R&S	847793/005	12.04.13	13.04.13
<input checked="" type="checkbox"/>	EMI Test Receiver	ESCI7	R&S	100851	12.09.05	13.09.05
<input checked="" type="checkbox"/>	LISN	3825/2	EMCO	9006-1669	12.09.05	13.09.05
<input checked="" type="checkbox"/>	LISN	3816-2	EMCO	1001	12.09.05	13.09.05
<input checked="" type="checkbox"/>	Horn Antenna	BBHA 9120D	Schwarzbeck	277	11.03.22	13.03.22
<input checked="" type="checkbox"/>	Amplifier	TK-PA18	TESTEK.	120020	12.12.15	13.12.15
<input checked="" type="checkbox"/>	LogBicon Antenna	VULB9160	Schwarzbeck	3128	12.02.22	14.02.22
<input checked="" type="checkbox"/>	Turn-Table	MFT-120S	Max-Full Antenna Corp	-	N/A	N/A
<input checked="" type="checkbox"/>	Antenna Master	MFA-440E	Max-Full Antenna Corp	-	N/A	N/A