



Test Report for RAY240 Radio

CFR 47 Parts 80, 15 and 2: Radiated Emissions

Test Report Number: 552/1042

Approved	Adil Abbas International Compliance Manager		02/06/2004
Technical Check	Peter Bowen Senior EMC Test Engineer		11/03/2004
Administrative Check	Chris Bird Approvals Manager		02/06/2004
Report	Andy Little EMC Engineer		05/03/2004
Report Date	05/03/2004	Test Date	04/03/2004

The test data and results contained within this report relate only to the items tested.

This report shall not be reproduced except in full without the written approval of Raymarine Ltd.

Any reported expanded uncertainty is based on a standard uncertainty multiplied by a coverage factor $k = 2$, providing a level of confidence of approximately 95%. Any uncertainty evaluation has been carried out with reference to CISPR16-4:2002.

1 Purpose of Tests

Initial FCC compliance tests of the RAY 240 Radio, in accordance with FCC CFR 47 Part 80.211, 2.1053 and 15.109.

2 Test Site Accreditation

The test site used for the test detailed in this report were carried out on a FCC and Industry Canada registered test site

FCC Registration Number: 970522
Industry Canada Registration Number: IC4069-1

3 Description of Equipment under Test (EUT)

(To include all equipment being tested)

Date of Receipt:	23 rd February 2004
Client:	Raymarine Communications group
Brand Name:	Raymarine
Product Range:	Communications
Country of Manufacture:	England
Operational voltage range:	10.8 to 15.6V (Tolerant of 24V but will not transmit or receive)

Unit 1

Model Name or Number:	RAY240 VHF Transceiver (US Version)	
Unique Type Identification:	R49129	
FCC ID Number	PJ5RAY240	
Serial Number:	EMC230204a	
Circuit Diagram Number(s) & Issue:	Processor Board	4552-007 Issue Y
	Interconnect Board	4552-022 Issue F
	RF Board	4552-039 Issue G
PCB Assembly Number(s) & Issue:	Processor Board	3015-291 Issue C
	Interconnect Board	3015-295 Issue D
	RF Board	4552-001 Issue D
Software Version:	V0.13	
Modifications to Unit:	None	

Unit 2

Model Name or Number:	RAY240 Handset (US Version)	
Unique Type Identification:	E45009	
Serial Number:	EMC230204b	
Circuit Diagram Number(s) & Issue:	4552-008 Issue s	
PCB Assembly Number(s) & Issue:	3015-292 Issue e	
Software Version:	H0.06	
Modifications to Unit:	None	

Unit 3

Model Name or Number:	RAY240 Active Speaker	
Unique Type Identification:	E45003	
Serial Number:	EMC230204c	
Circuit Diagram Number(s) & Issue:	4552-009j	
PCB Assembly Number(s) & Issue:	3015-294a	
Software Version:	N/A	
Modifications to Unit:	None	

4 Description of Auxiliary Equipment

(To include all equipment associated with the EUT(s) which are NOT directly subjected to the test)

Item	Unique Type Identification & Serial Number
	None

5 General

Supply Voltage	Ambient Temperature	Relative Humidity
12V	24°C	25%

6 Test Configuration

(See Section 3 Description of Equipment under Test (EUT) and Section 3 Description of Auxiliary Equipment for Description of Equipment)

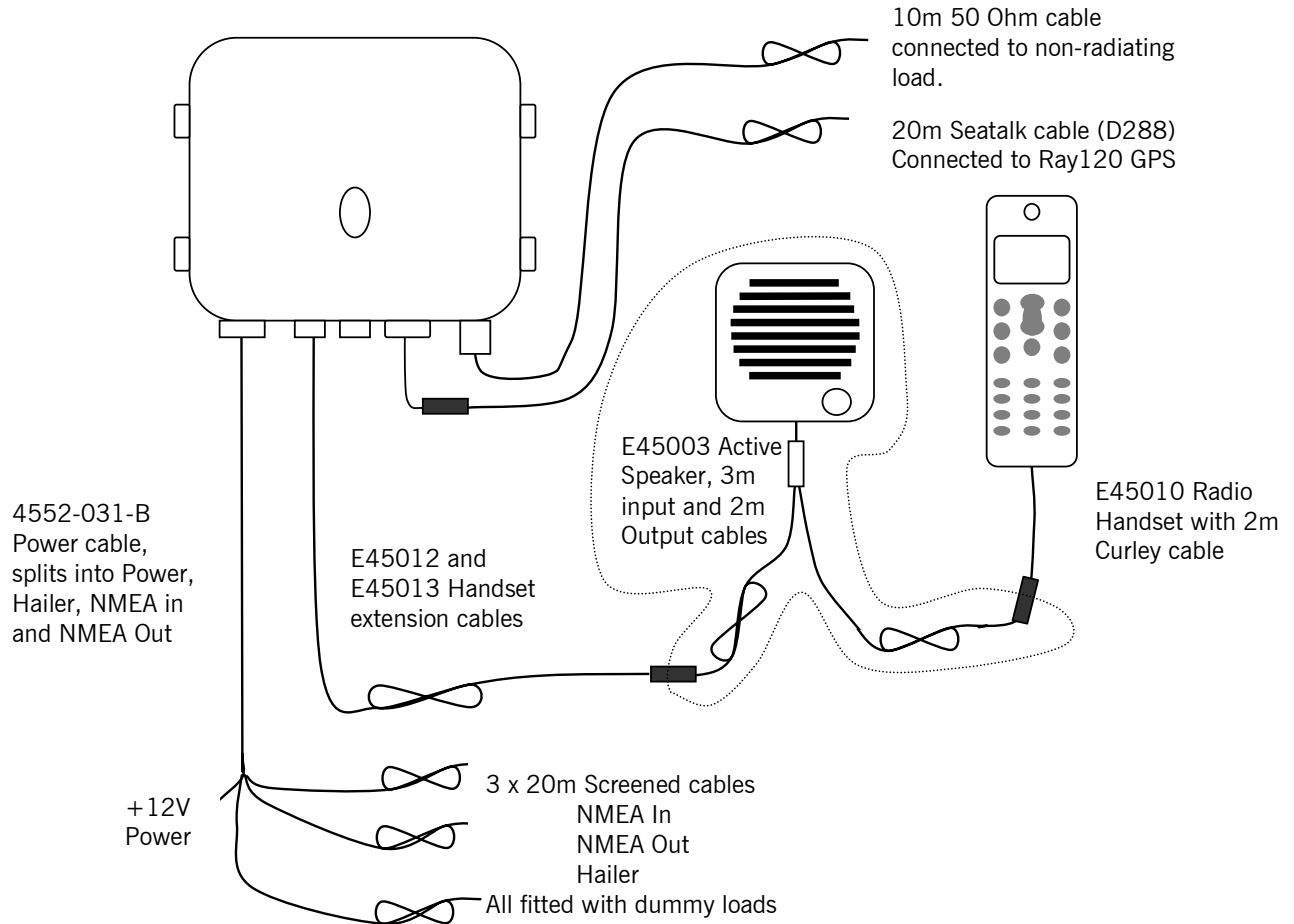

Title	Description
Test Setup and Operating Mode	Setup as per diagram Section 6. Operating mode of the radio was standard transmit at 25W on channel 68 (156.425MHz).

7 Transmit Mode Limit Line Calculation

Centre Frequency 156.425MHz
 Declared Bandwidth 16kHz

Test frequency Range 9kHz to 1.56425GHz (Tested to 2GHz)

Mean power of Transmitter 20.9W

Therefore limit (dBc) = $43 + 10 \log_{10}(\text{Mean Power}) = 56.2\text{dBc}$

Level of carrier measured at 3m 140dB μ V/m

Frequency (Band start)	Frequency (Band stop)	Limit (dBc)	Limit (dBm)
9kHz	156.385MHz	56.2dBc	83.8dB μ V/m
156.385MHz	156.409MHz	35dBc	105 dB μ V/m
156.409MHz	156.417MHz	25dBc	115 dB μ V/m
156.417MHz	156.433MHz	Carrier	Carrier
156.433MHz	156.441MHz	25dBc	115 dB μ V/m
156.441MHz	156.465MHz	35dBc	105 dB μ V/m
156.465MHz	2GHz	56.2dBc	83.8dB μ V/m

8 Test Results

8.1 Transmit Mode

Frequency	Peak Level (dB μ V/m)	Quasi Peak Level (dB μ V/m)
56MHz	27.7	25.0
80.16MHz	18.8	11.9
135.04MHz	26.6	24.1
139.64MHz	30.3	28.8
540.12MHz	30.3	28.3
863.16MHz	31.7	22.0
952.4MHz	36.2	33.2

Test Description	See Page	Result
9kHz to 2GHz FCC CFR47 Part 80.211 and Part 2.1053		
Graph of peak emissions and table of peak measurements	6	PASS

Resolution Bandwidths Used

9kHz to 150kHz	200Hz
150kHz to 30MHz	10kHz
30MHz to 1GHz	100kHz
1 to 2 GHz	1MHz
150 to 160MHz	3kHz

8.2 Receive Mode

Frequency	Peak Level (dB μ V/m)	Quasi Peak Level (dB μ V/m)
9kHz to 30MHz	No signals found	
1.7716GHz	Signal Not found	

Test Description	See Page	Result
9kHz to 2GHz FCC CFR47 Part 15.109		
Graph of peak emissions and table of peak measurements	11	PASS

Resolution Bandwidths Used

9kHz to 150kHz	200Hz
150kHz to 30MHz	10kHz
30MHz to 1GHz	100kHz
1 to 2 GHz	1MHz

9 Comments and Circuit Modifications

The Radiated emissions were measured over the band 9kHz to 2GHz; all emissions were below the required limit. The unit is therefore considered to meet the requirements of the standard.

10.2 30 to 156MHz

 Marker 1 [T1] Det MA/QP Trd CH3_fcc
Att 0 dB AUTO 92.63 dB μ V/m ResBW 120 kHz
INPUT 1 156.00000000 MHz Meas T 100 ms Unit dB μ V/m

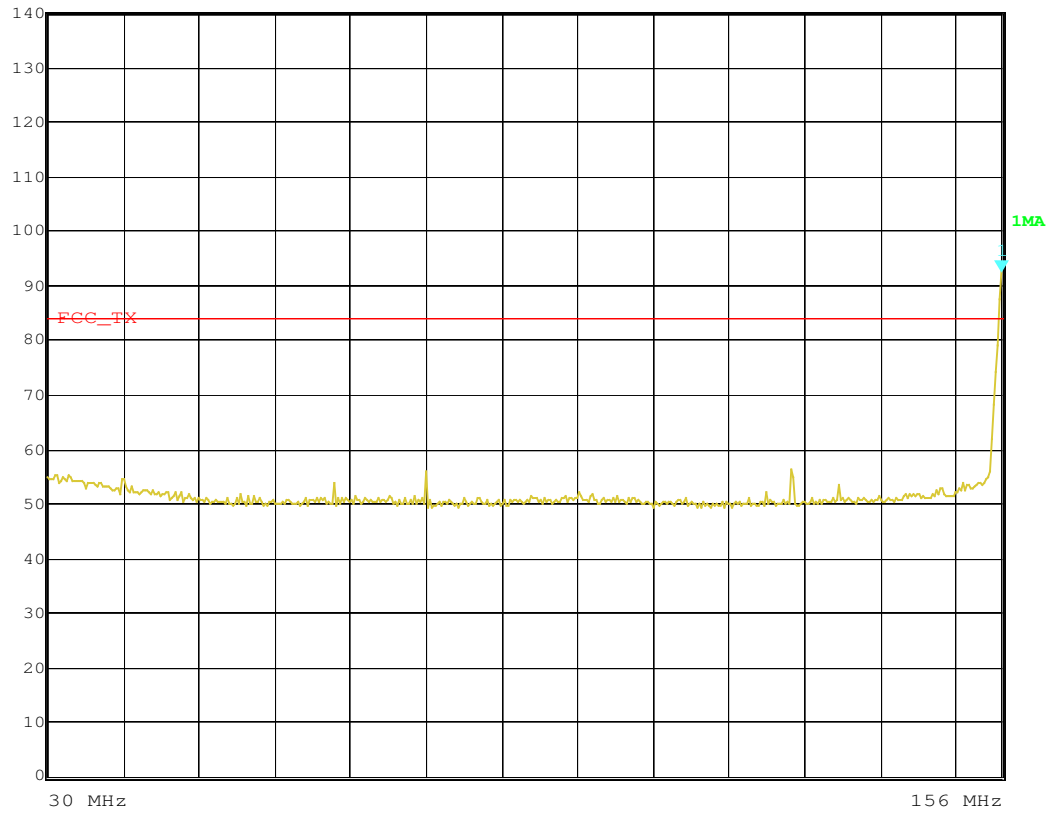

Date: 3.MAR.2004 16:01:37

10.3 156 to 157 MHz

 Marker 1 [T1] Det MA/QP Trd CH3_fcc
Att 0 dB AUTO 139.58 dBV/m ResBW 1 kHz
INPUT 1 156.42440000 MHz Meas T 100 ms Unit dBV/m

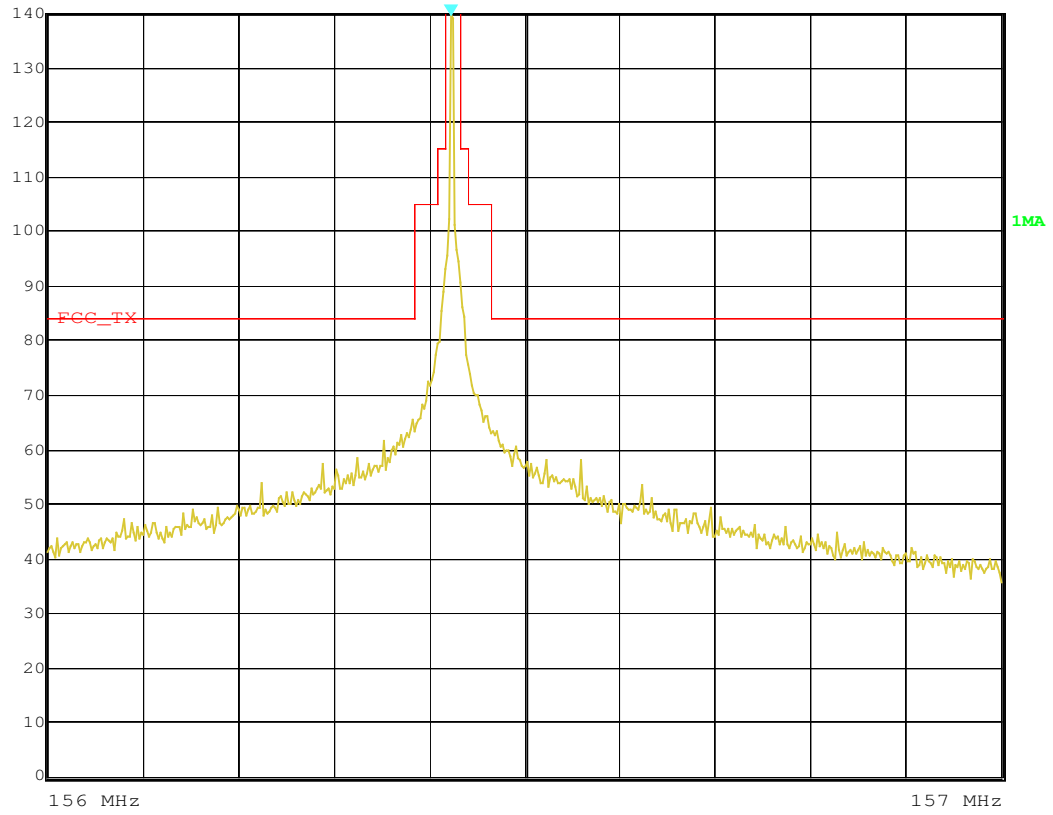

Date: 3.MAR.2004 15:43:53

10.4 157 to 300MHz

RS	Att 0 dB AUTO	Marker 1 [T1]	82.98 dBV/m	Det	MA/QP Trd	CH3_fcc
	INPUT 1	157.00000000 MHz		ResBW	120 kHz	
				Meas T	100 ms Unit	dBV/m

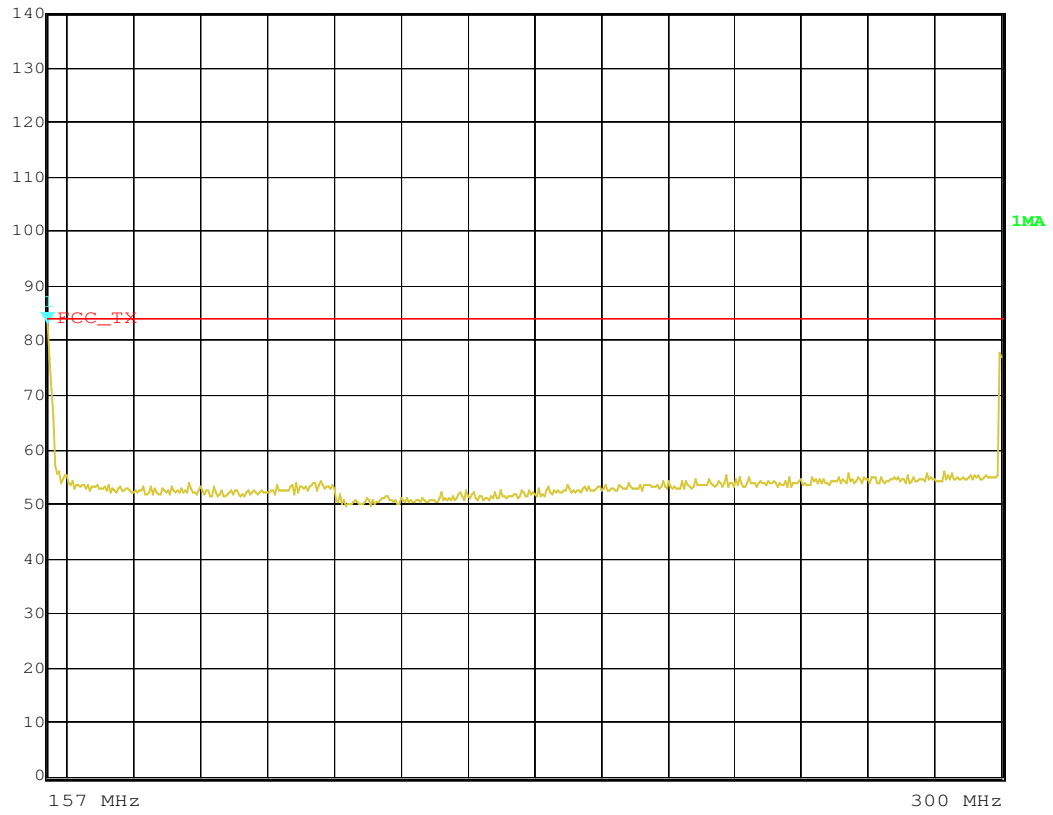

Date: 3.MAR.2004 16:07:40

10.5 300MHz to 2GHz



Marker 1 [T1] Det MA/QP Trd CH3_fcc
Att 0 dB AUTO 29.90 dBV/m ResBW 120 kHz
INPUT 1 301.9600000 MHz Meas T 100 ms Unit dBV/m

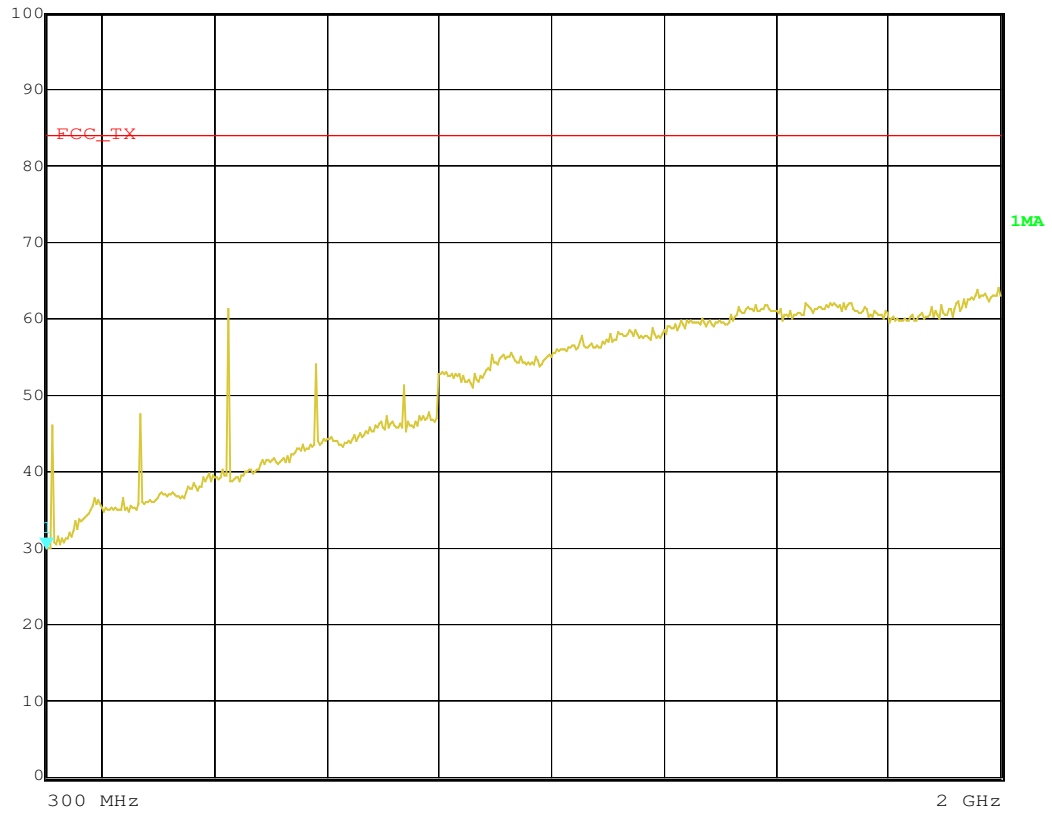

Date: 4.MAR.2004 08:09:11

11 Radiated Emissions Graphs – Receive Mode

11.1 30MHz to 300MHz

 Marker 1 [T1] Det MA/QP Trd CH3_fcc
Att 0 dB AUTO 23.84 dBV/m ResBW 120 kHz
Preamp INPUT 1 200.2400000 MHz Meas T 5 s Unit dBV/m

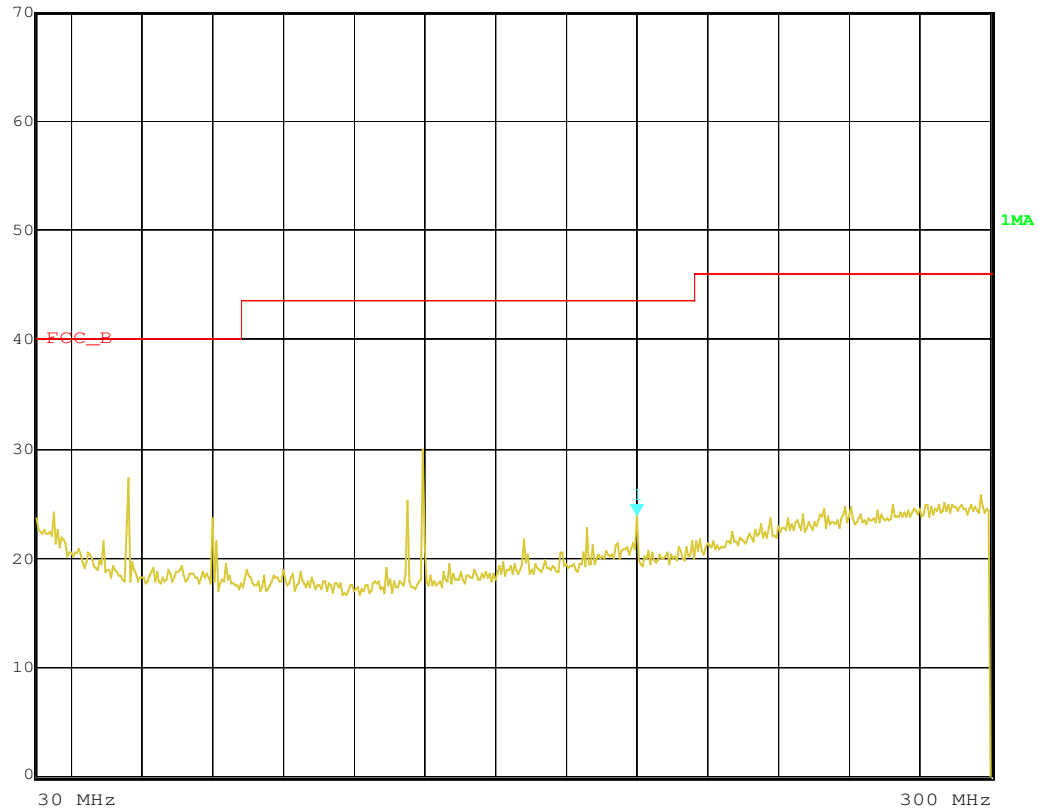

Date: 4.MAR.2004 10:27:28

11.2 300MHz to 2GHz

	Att 0 dB AUTO	Marker 1 [T1]	Det	MA/QP Trd	CH3_fcc
	Preamp INPUT 1	300.0400000 MHz	14.58 dBV/m	ResBW 120 kHz	
			Meas T	100 ms Unit	dBV/m

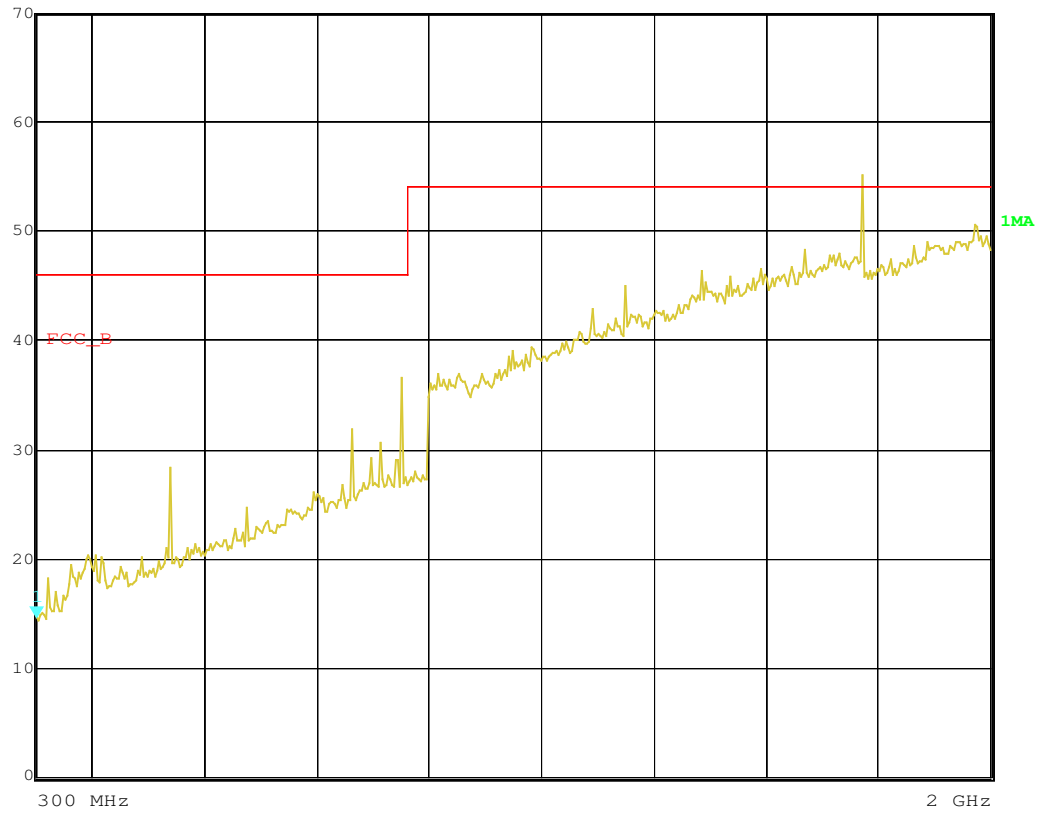

Date: 4.MAR.2004 09:32:30

12 List of Test Equipment

Test Equipment Type	Manufacturer and Type Number	Serial Number	TE No.
EMI Test Receiver 20Hz to 26.5GHz	Rohde & Schwarz ESI	832692/006	886
DVM	Fluke Model 83	63550394	1420
Power Supply Unit	Farnell AP60-50	01140	0376
Attenuator 1 (25W, 10dB)	Inmet Corp FSC64671 6N25W-10dB	Supplied by Customer, Combined Calibration results for both attenuators held on file	
Attenuator 2 (25W, 10dB)	Bird Electronics Corp Mod 25-A-MFW-10 0121		
Notch Filter	VHF Notch filter	Supplied by Customer, Calibration results held on file	
Semi-Anechoic Chamber, Site 3	Global EMC	GE002	
Biconical Antenna, 30-300MHz	Schwarzbeck VHBB9124/BBAK9137	285	0968
Log-Periodic Antenna, 0.3-3.0GHz	Emco EM6946	112	0969
Active Loop Antenna 9kHz - 30MHz	Chase EMC HLA6120	1122	0904
Loop Antenna PSU/Charger	Chase EMC CBP9720	1076	1424
Antenna Mast (Site 3)	EMCO 2075 4m Mini-Mast		1526
Turntable (Site 3)	EMCO Lo-Pro Turntable		1527
Mast/Turntable/Antenna Controller (Site 3)	EMCO 2090 Multi-Device Controller	9712-1278	1525
EMI Test Receiver 20Hz to 26.5GHz	Rohde & Schwarz ESI	832692/006	886
R.F. Preamplifier 30-2000MHz	Comtest GPA304	1002	
DVM	Fluke Model 83	63550394	1420
Power Supply Unit	Palstar PS30M	520360607	1238

In accordance with UKAS requirements, all measuring equipment is on a calibration cycle.