



Raymarine Limited

RAY 240 VHF Radio

ID Label Drawings and Photos

FCC ID PJ5RAY240

IC: 4069B-RAY240

USED ON:

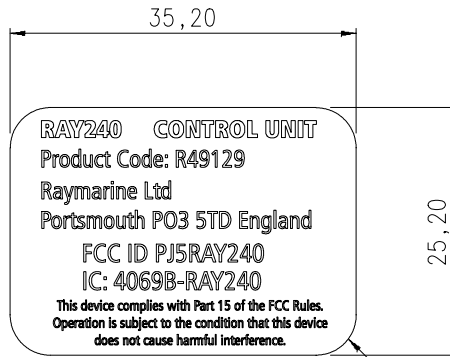



R4,10
4 POS

NOTES :-

1. MATERIAL : CLEAR POLYCARBONATE (LEXAN FILM 8A35) 250 MICRONS THICK.
2. FINISH : VELVET / POLISHED.
3. UNDERSURFACE PRINTED, SELF ADHESIVE BACKED (REF. 3M 468MP HIGH PERFORMANCE).
4. COLOUR SPECIFICATIONS :-
BACKGROUND - BLACK SERICOL INK MG001(RAYMARINE APPROVED)
ALL LEGENDS - WHITE SERICOL INK MG025 (RAYMARINE APPROVED)
(COLOUR MATCHED TO PANTONE WHITE - RAYMARINE APPROVED)
5. LABEL SURFACE AREA TO BE COMPLETELY CLEAR OF SCRATCHES, BLEMISHES & FINGER MARKS.
6. PUNCHED OUT PROFILE EDGES TO BE BURR FREE.
7. REFER TO ARTWORK 3032-764 ISSUE c FOR PRINTING DETAILS.
8. THIS DRAWING IS THE 'MASTER DOCUMENT' & ELECTRONIC DATA IS AVAILABLE UPON REQUEST.

C	Input: 10.8 - 15.6 VDC, REMOVED FROM BELOW 'Product Code: 'This device ...' - ADDED.	13.05.04 A.J.C
B	ARTWORK UPISSUED.	01.03.04 A.J.C
A	FIRST ISSUE	ORIGINAL
ISS	DESCRIPTION OF CHANGE	DATE

ITEM No	DRG/PART No	QTY	DESCRIPTION
PARTS LIST			
 THE INFORMATION CONTAINED HEREIN SHALL NOT BE REPRODUCED WITHOUT THE PRIOR WRITTEN PERMISSION OF RAYMARINE LTD		TOLERANCES UNLESS OTHERWISE STATED X ±0,50 MACHINING: 1,6 .XX ±0,25 SURFACE √ .XXX ±0,10 SHARP INTERNAL CORNERS ANGLES ±1° TO HAVE RADIUS 0,4 MAX (EXCL DRAFT) DEBURR ALL EDGES	
		DIMENSIONS IN MM SCALE: 2:1	

DRAWN TO BS308  DO NOT SCALE - IF IN DOUBT ASK

MATERIAL SEE NOTES

FINISH SEE NOTES

TITLE LABEL, PRODUCT, TX BOX, D552, US

DRAWING No. 3029-483

SHT 1 OF 1

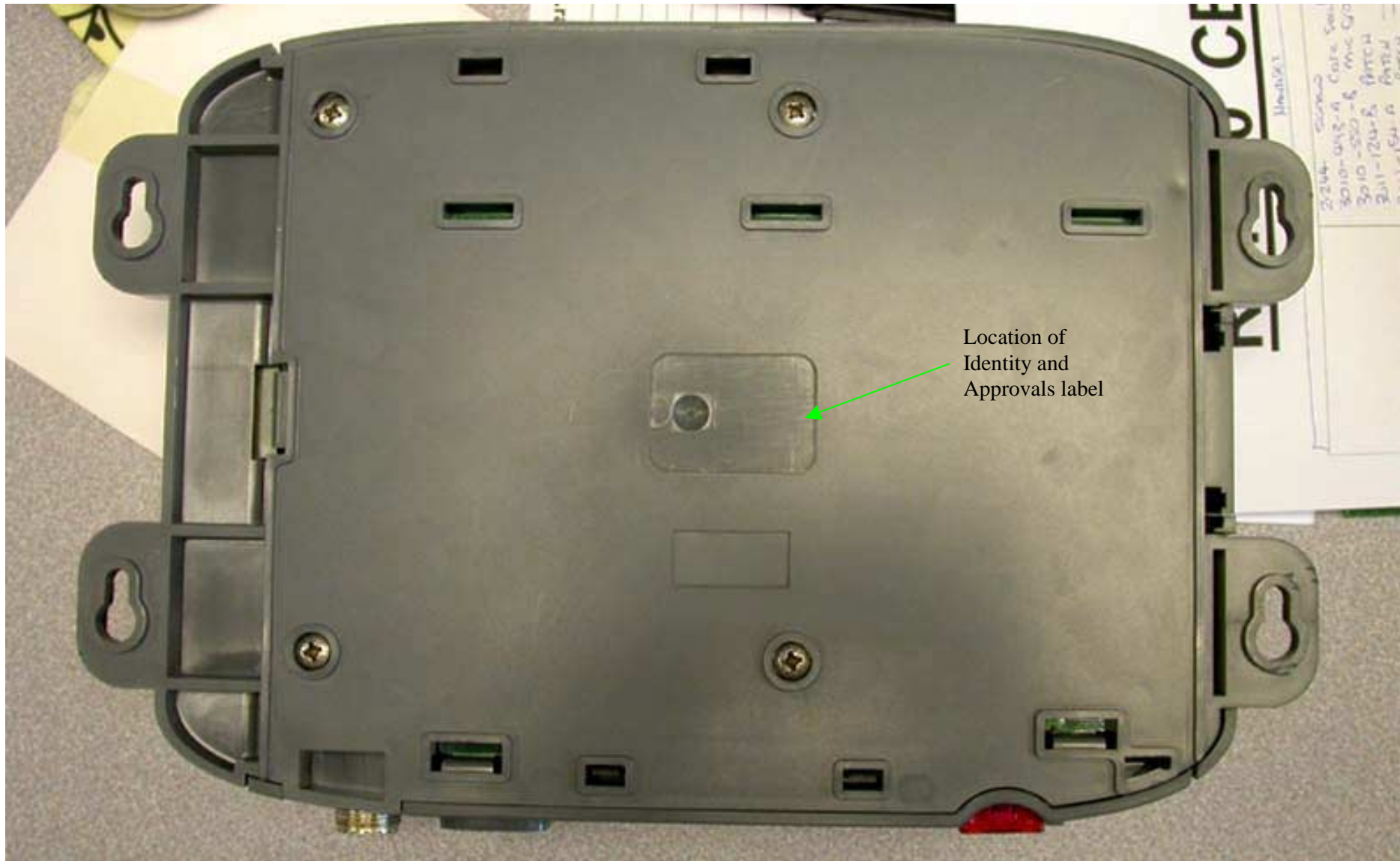

Location of
Identity and
Approvals label

RAY 240 VHF Radio

Control Unit (Transceiver)

USED ON:

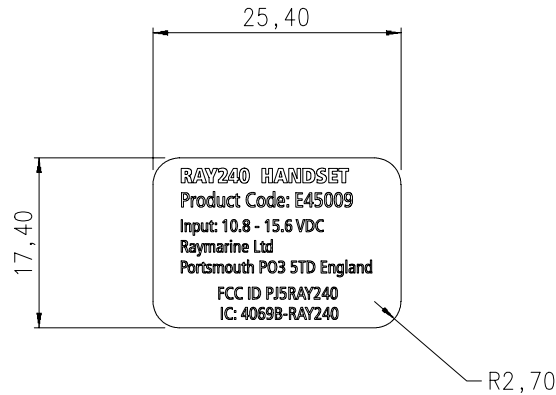

NOTES :-

1. MATERIAL : CLEAR POLYCARBONATE (LEXAN FILM 8A35) 250 MICRONS THICK.
2. FINISH : VELVET / POLISHED.
3. UNDERSURFACE PRINTED, SELF ADHESIVE BACKED (REF. 3M 468MP HIGH PERFORMANCE).
4. COLOUR SPECIFICATIONS :-
 BACKGROUND - BLACK SERICOL INK MG001(RAYMARINE APPROVED)
 ALL LEGENDS - WHITE SERICOL INK MG025 (RAYMARINE APPROVED)
 (COLOUR MATCHED TO PANTONE WHITE - RAYMARINE APPROVED)
5. LABEL SURFACE AREA TO BE COMPLETELY CLEAR OF SCRATCHES, BLEMISHES & FINGER MARKS.
6. PUNCHED OUT PROFILE EDGES TO BE BURR FREE.
7. REFER TO ARTWORK 3032-762 ISSUE B FOR PRINTING DETAILS.
8. THIS DRAWING IS THE 'MASTER DOCUMENT' & ELECTRONIC DATA IS AVAILABLE UPON REQUEST.

B	ARTWORK UP ISSUED.	01.03.04 A.J.C
A	FIRST ISSUE	ORIGINAL
ISS	DESCRIPTION OF CHANGE	DATE

ITEM No	DRG/PART No	QTY	DESCRIPTION
PARTS LIST			
 ©2001 RAYMARINE LTD		THE INFORMATION CONTAINED HEREIN SHALL NOT BE REPRODUCED WITHOUT THE PRIOR WRITTEN PERMISSION OF RAYMARINE LTD	TOLERANCES UNLESS OTHERWISE STATED X ±0,50 .X ±0,25 .XX ±0,10 .XXX ±0,05 ANGLES ±1° (EXCL DRAFT) DIMENSIONS IN MM
		MACHINING: 1,6/ SURFACE SHARP INTERNAL CORNERS TO HAVE RADIUS 0,4 MAX DEBURR ALL EDGES SCALE: 2:1	

DRAWN TO BS308 ☉ ☐ DO NOT SCALE - IF IN DOUBT ASK	
MATERIAL	SEE NOTES
FINISH	SEE NOTES

TITLE		
LABEL, PRODUCT, HANDSET, D552, US		
DRAWING No.	3029-481	A 3
SHT 1 OF 1		



Location of
Identity and
Approvals label

RAY 240 VHF Radio

Handset

USED ON:

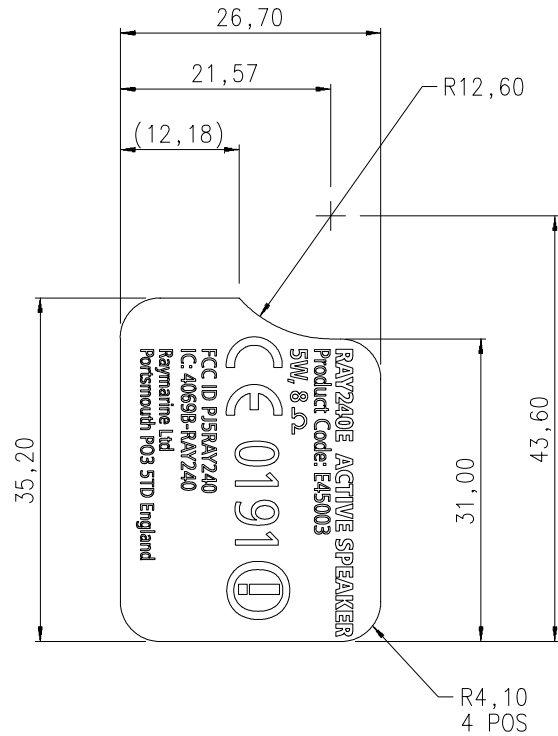

NOTES :-

1. MATERIAL : CLEAR POLYCARBONATE (LEXAN FILM 8A35) 250 MICRONS THICK.
2. FINISH : VELVET / POLISHED.
3. UNDERSURFACE PRINTED, SELF ADHESIVE BACKED (REF. 3M 468MP HIGH PERFORMANCE).
4. COLOUR SPECIFICATIONS :-
 BACKGROUND - BLACK SERICOL INK MG001(RAYMARINE APPROVED)
 ALL LEGENDS - WHITE SERICOL INK MG025 (RAYMARINE APPROVED)
 (COLOUR MATCHED TO PANTONE WHITE - RAYMARINE APPROVED)
5. LABEL SURFACE AREA TO BE COMPLETELY CLEAR OF SCRATCHES, BLEMISHES & FINGER MARKS.
6. PUNCHED OUT PROFILE EDGES TO BE BURR FREE.
7. REFER TO ARTWORK 3032-763 ISSUE B FOR PRINTING DETAILS.
8. THIS DRAWING IS THE 'MASTER DOCUMENT' & ELECTRONIC DATA IS AVAILABLE UPON REQUEST.

B	ARTWORK UP ISSUED.	01.03.04 A.J.C
A	FIRST ISSUE	ORIGINAL
ISS	DESCRIPTION OF CHANGE	DATE

ITEM No	DRG/PART No	QTY	DESCRIPTION
PARTS LIST			
		THE INFORMATION CONTAINED HEREIN SHALL NOT BE REPRODUCED WITHOUT THE PRIOR WRITTEN PERMISSION OF RAYMARINE LTD	
©2001 RAYMARINE LTD		TOLERANCES UNLESS OTHERWISE STATED X ±0,50 .X ±0,25 .XX ±0,10 .XXX ±0,05 ANGLES ±1° (EXCL DRAFT) DIMENSIONS IN MM	
		MACHINING: 1,6/ SURFACE SHARP INTERNAL CORNERS TO HAVE RADIUS 0,4 MAX DEBURR ALL EDGES SCALE: 2:1	

DRAWN TO BS308 DO NOT SCALE - IF IN DOUBT ASK	
MATERIAL	SEE NOTES
FINISH	SEE NOTES

TITLE		DRAWING No.	A 3
LABEL, PRODUCT, SPEAKER, D552			
DR*N: A.J.C	DATE: 19.11.03	3029-482	A 3
CK'D:			
APP'D:			
SHT 1 OF 1			

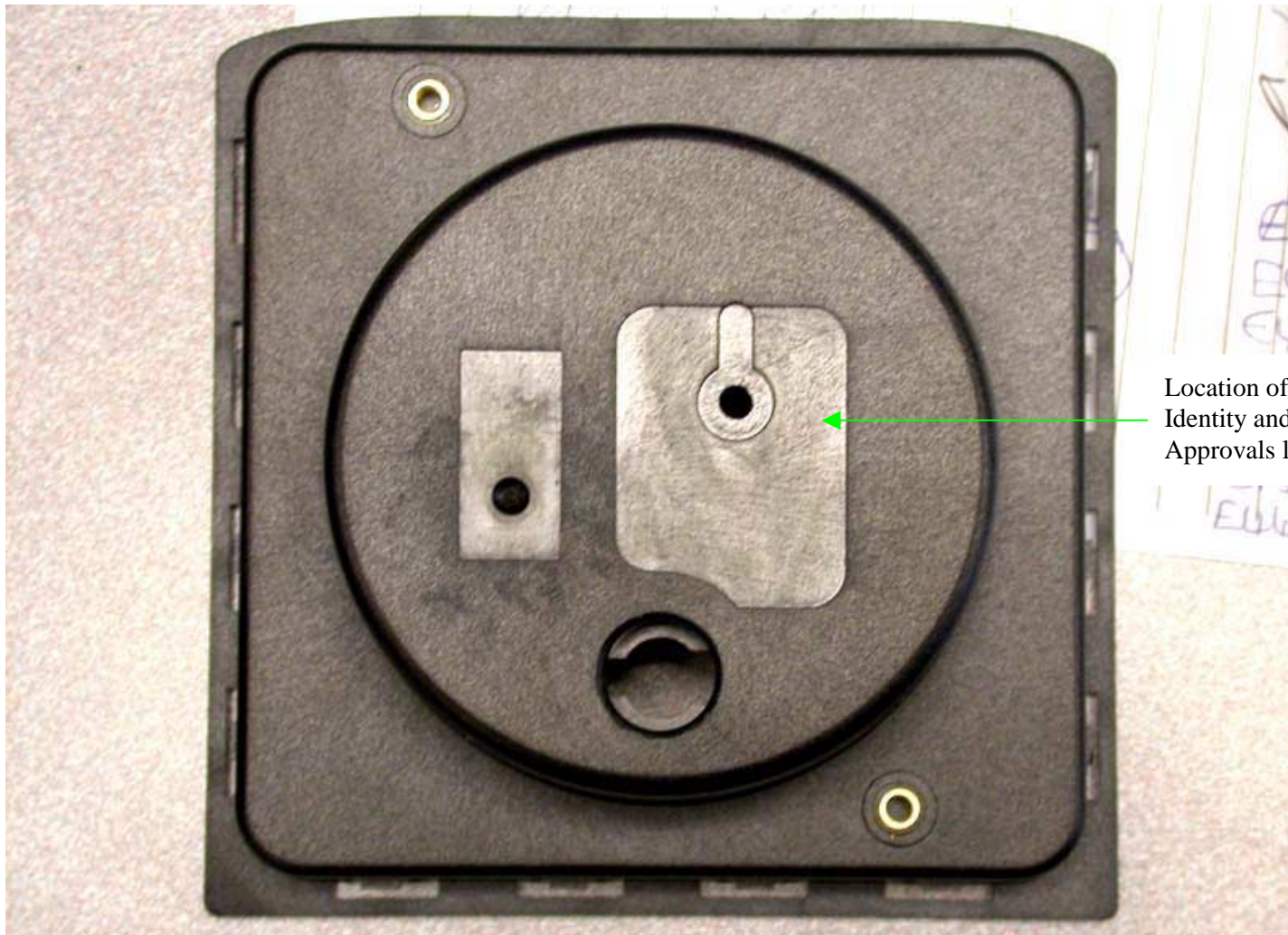

RAY 240 VHF Radio

Active Speaker