



Raymarine UK Ltd  
Marine House  
Cartwright Drive  
Segensworth  
Fareham  
Hampshire  
PO15 5RJ  
Tel: 01329 246700

Email: [compliance@raymarine.com](mailto:compliance@raymarine.com)

<http://www.raymarine.com>

---

## Test Report for a75, a77 & a78 Marine Multifunction Displays

### To RSS-210 and 47 CFR Part 15 Subpart C – Spurious Emissions

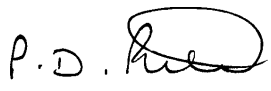
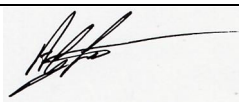
Model Number	E70164, E70165, E70202		
Product Description	a75, a77, a78		
Report Number	TP/847/1011		
Report Author Mike Thompson EMC Engineer		Date	6 <sup>th</sup> August 2013
Technical Check Paul Pitt EMC Engineer		Date	6 <sup>th</sup> August 2013
Approval Andrew Little Compliance Manager		Date	7 <sup>th</sup> August 2013

Test Date Range	29 <sup>th</sup> July 2013 – 2 <sup>nd</sup> August 2013
-----------------	--

Product Status	PASS
----------------	------

This test report shall not be reproduced except in full, without written approval of Raymarine UK Ltd.

The test data and results contained within this report relate only to the items tested.

## 1 RSS 210 and 47 CFR Part 15 Test Summary

	CFR 47 Part 15	RSS-210	Section	Result
Hopping Sequence	15.247(a)		See TP/808/1055b section 5.4	Pass
Peak Output Power	15.247(b)	A8.4(2)	See TP/808/1055b section 5.3	Pass
Carrier Frequency Separation	15.247(a)	A8.1(b)	See TP/808/1055b section 5.4	Pass
Frequency Band Edges	15.247(d)		See TP/808/1055b section 5.8	Pass
20dB Bandwidth	15.247(a)(1)	A8.1(a)	See TP/808/1055b section 5.7	Pass
Radiated Emissions	15.209(a)	RSS-GEN 7.5.2	6	Pass
Spurious Emissions	15.247(d)	A8.5	7	Pass
Number of Channels	15,247(a)(1)	A8.1(d)	See TP/808/1055b section 5.4	Pass
Directional antenna with >6dBi	15.247(c)		See TP/808/1055b section 5.2 Antenna<6dBi	N/A
Dwell Time	15.247(a)	A8.1(d)	See TP/808/1055b section 5.4	Pass
6dB Bandwidth		A8.2(a)		N/A (FHSS)
Power Spectral Density		A8.2(b)		N/A (FHSS)

## 2 Attestations

This equipment has been tested in accordance with the standards identified in this report. To the best of my knowledge and belief, these tests were performed using the measurement procedures described in these reports.

All measuring instruments used to determine the status of the product's compliance to the identified standards are calibrated regularly in accordance with UKAS requirements.

A comprehensive system of traceable calibration in accordance with ISO9001 is maintained.

Name/Position	Signature	Date
Mike Thompson EMC Engineer		6 <sup>th</sup> August 2013

I attest that the necessary measurements were made, under my supervision at:

Raymarine UK Ltd, Marine House, Cartwright Drive, Segensworth, Fareham, Hampshire,  
PO15 5RJ.



Andy Little  
Compliance Manager

**Date 7<sup>th</sup> August 2013**

TABLE OF CONTENTS

1 RSS 210 and 47 CFR Part 15 Test Summary ..... 2

2 Attestations ..... 3

3 Test Information ..... 5

    3.1 Test Facilities ..... 5

    3.2 Overall Test Conditions ..... 5

    3.3 Test Methods ..... 5

4 EUT Information ..... 6

    4.1 Test Rationale ..... 6

    4.2 Description of Equipment under Test (EUT) ..... 6

    4.3 Additional information ..... 7

    4.4 Description of Auxiliary Equipment ..... 7

    4.5 Test setup ..... 8

    4.6 Emissions – Below 2GHz ..... 9

    4.7 Transmitter Spurious Emissions – 2GHz to 26GHz ..... 9

5 Photographs ..... 9

6 Emissions Results ..... 10

    6.1 a77, 30 foot range, Radiated Emissions 9 kHz to 150 kHz ..... 10

    6.2 a77, 400 foot range, Radiated Emissions 9 kHz to 150 kHz ..... 11

    6.3 a77, 30 foot range, Radiated Emissions 150 kHz to 30MHz ..... 12

    6.4 a77, 400 foot range, Radiated Emissions 150 kHz to 30MHz ..... 13

    6.5 a77, 30 foot range, Radiated Emissions 30MHz to 300MHz ..... 14

    6.6 a77, 400 foot range, Radiated Emissions 30MHz to 300MHz ..... 15

    6.7 a77, 30 foot range, Radiated Emissions 300MHz to 1GHz ..... 16

    6.8 a77, 400 foot range, Radiated Emissions 300MHz to 1GHz ..... 17

    6.9 a77, 30 foot range, Radiated Emissions 1GHz to 2GHz ..... 18

    6.10 a77, 400 foot range, Radiated Emissions 1GHz to 2GHz ..... 18

    6.11 FCC Part 15, Chapter 47\_15.247 Spurious Emissions 2GHz to 26GHz ..... 19

7 Receiver Spurious Emissions ..... 23

8 List of Test Equipment ..... 24

### 3 Test Information

#### 3.1 Test Facilities

Site 1	9m x 6m x 5.5m Semi Anechoic Chamber	FCC ID IC Certification	371673 4069B-2
--------	---	----------------------------	-------------------

#### 3.2 Overall Test Conditions

Work Area	Relative Humidity (%)	Air Pressure (mbar)	Ambient Temperature (°C)
Site 1-5	60-65	1003-1005	18.5-19.6
Sites 6-10	59-65	1013-1015	21.2-22.0

#### 3.3 Test Methods

The objective of the report is to perform testing according to 47 CFR Part 15 Subpart C paragraph 15.247(d) (Bluetooth and WIFI, 2.4GHz ISM band radiators) for the EUT FCC ID Certification:

Number	Standard Number	Document Title
1	47 CFR Part 15 (10-01-09 Edition)	Radio Frequency Devices

##### 3.3.1 Deviations from Test Methods

None

## 4 EUT Information

### 4.1 Test Rationale

Tested to ensure compliance to FCC Chapter 47, part 15: 15.209(a) Radiated Emissions 15.247(d) Spurious Emissions
---

### 4.2 Description of Equipment under Test (EUT)

Date of Receipt:	25 <sup>th</sup> July 2013
Client:	Stephen Grant
Brand Name:	Raymarine
Product Range:	a7
Country of Manufacture:	China
Operational voltage range:	12VDC

#### Unit 1

Model Name or Number:	a77
Unique Type Identification:	E70165
FCC ID	PJ5-WFBT7
IC ID	4069B-WFBT7
Serial Number:	EMC130725b
CCT Diagram Number(s) & Issue:	CPU 1002597-3 Sonar 1001523-4 Keyboard 1001673-1 GPS 1001653-5 Chart 1001663-1
PCB Assembly Number(s) & Issue:	CPU 1002598 Sonar 1001524-4 Keyboard 1001674-1 GPS 1001654-5 Chart 1001664-1
Software Version:	Boot 7.26-00131 Kernel 3.4.41-rm Application 7.32-00619
Modifications to Unit:	None

#### 4.3 Additional information

This test report is also applicable to the following multifunctional displays :-  
a75 & a78

#### 4.4 Description of Auxiliary Equipment

Product Type	Part Number	Serial Number
E97	E70022	EMC120117A
i70 Instrument	E22172	E221721010302
Transducer	P58	

4.5 Test setup

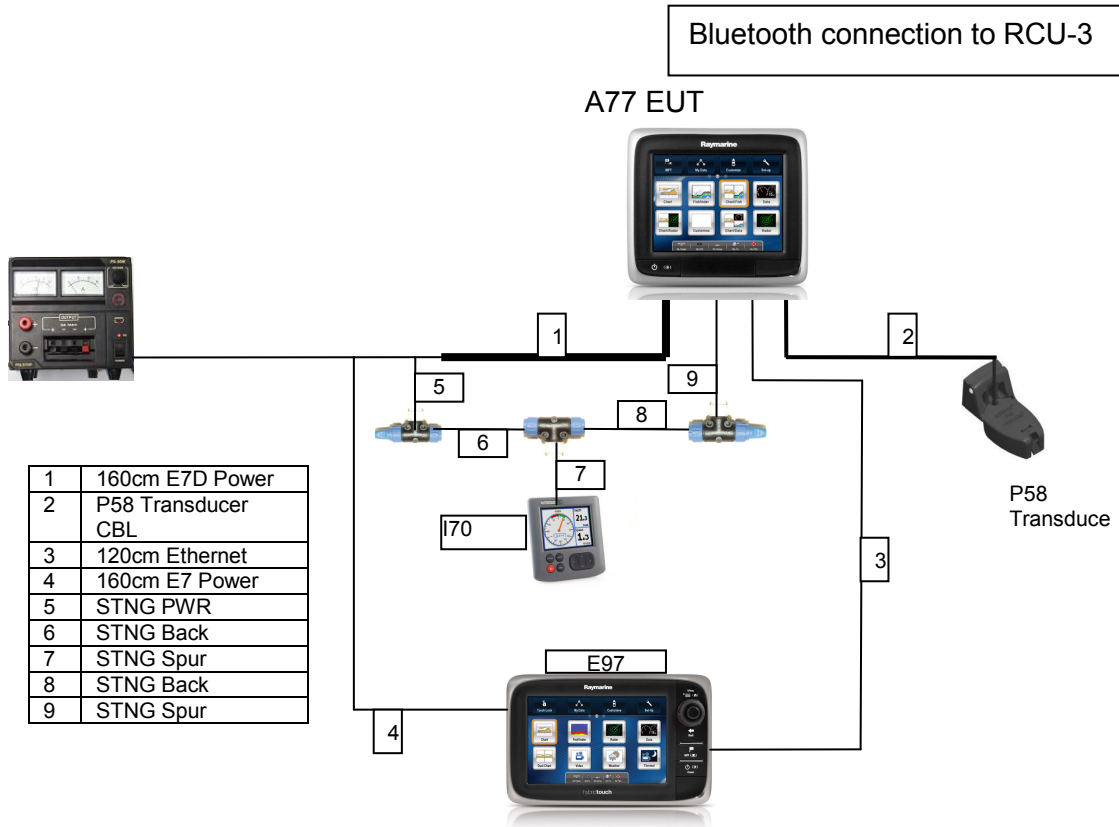



#### 4.6 Emissions – Below 2GHz

Below 2GHz the unit was setup in a system to ensure the EUT was fully functional. The Bluetooth and WIFI were functional during testing.

#### 4.7 Transmitter Spurious Emissions – 2GHz to 26GHz

2GHz to 26GHz the unit was setup in a system to ensure the EUT was fully functional. Control of the Bluetooth was controlled externally to enable the Bluetooth Emissions to be measured separately.

### 5 Photographs

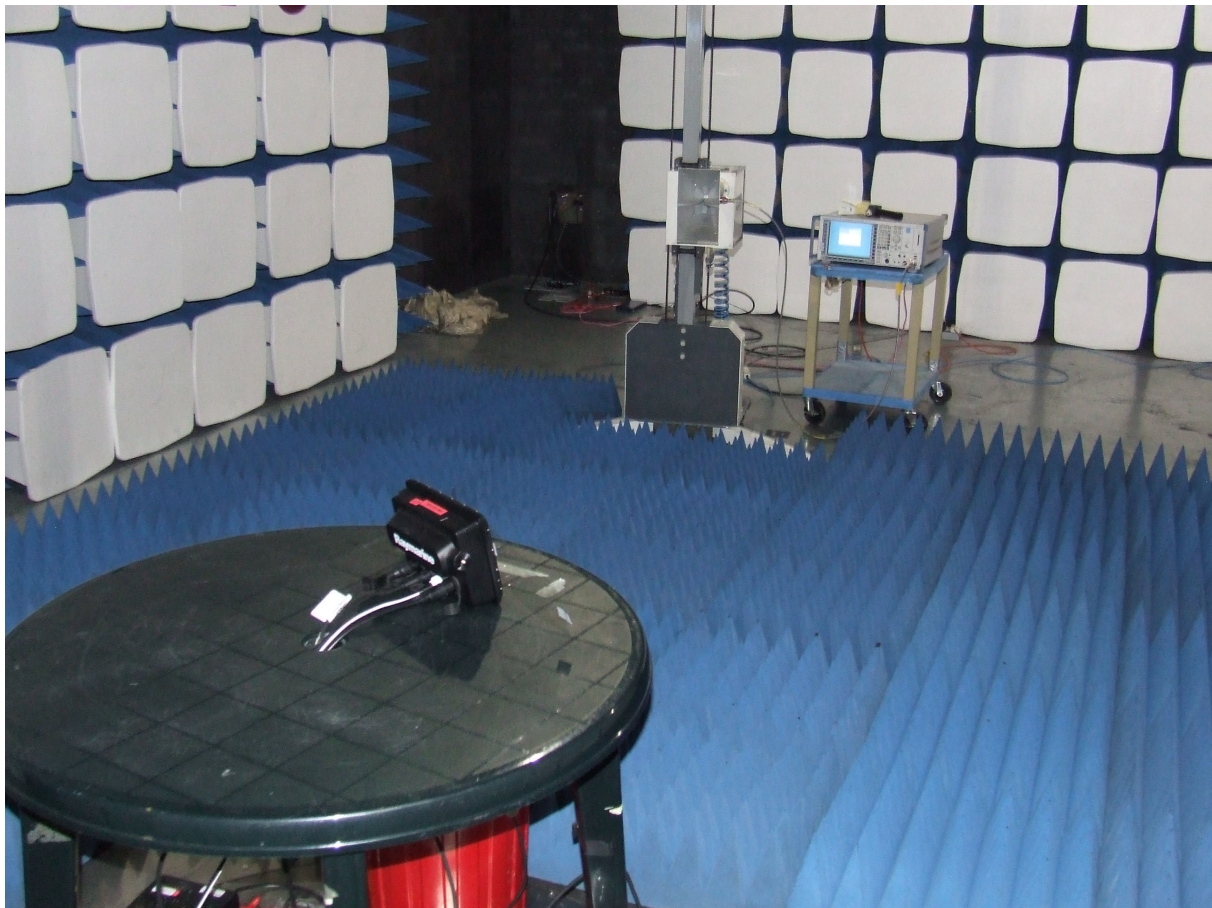

## 6 Emissions Results

### 6.1 a77, 30 foot range, Radiated Emissions 9 kHz to 150 kHz

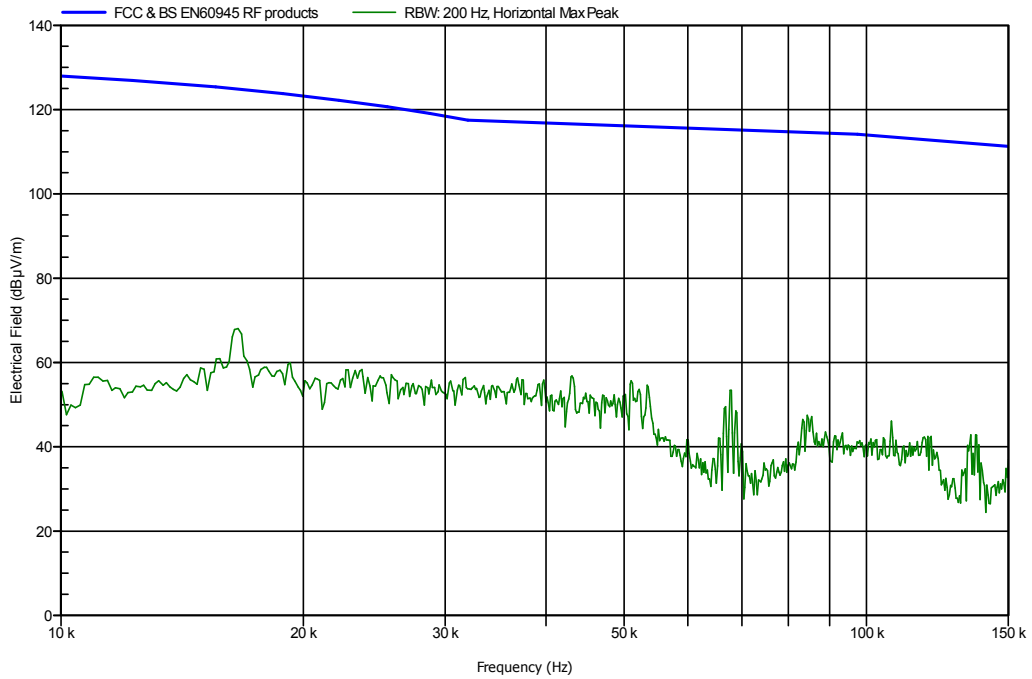

Loop Face On

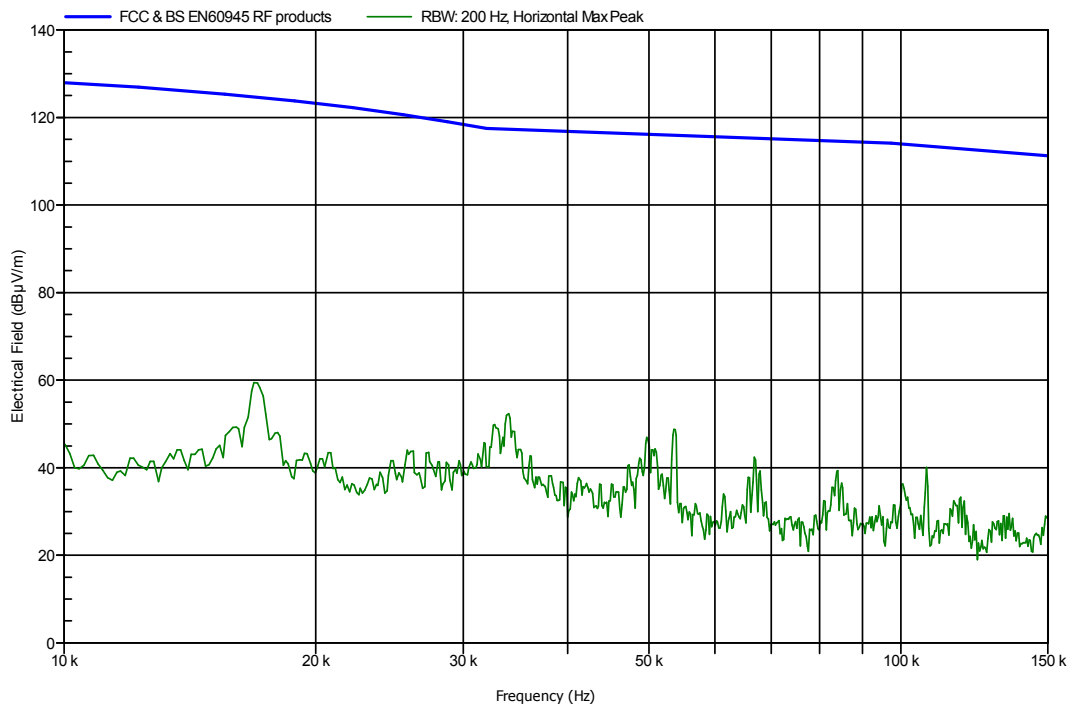

Loop Side On

6.2 a77, 400 foot range, Radiated Emissions 9 kHz to 150 kHz

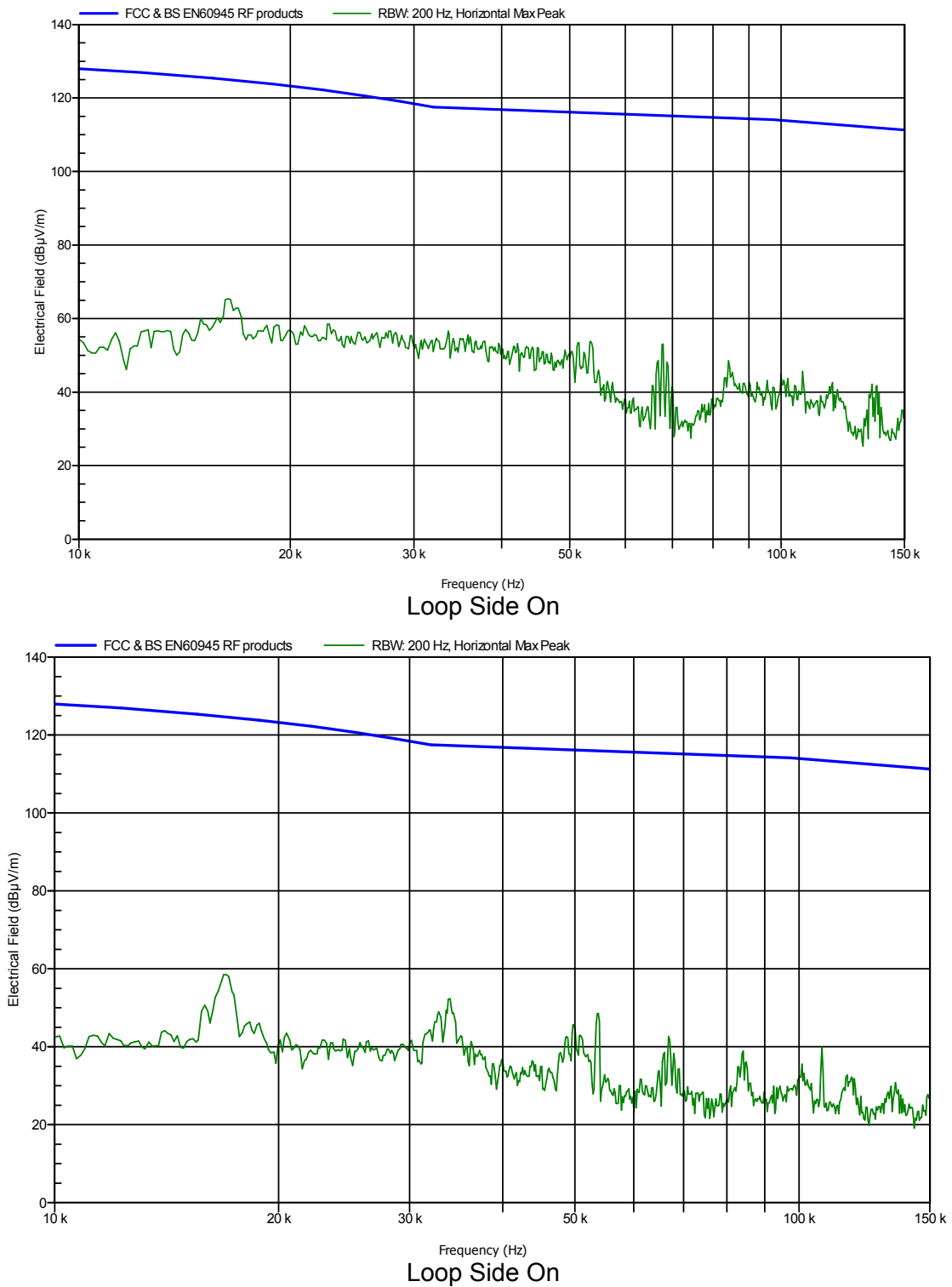

6.3 a77, 30 foot range, Radiated Emissions 150 kHz to 30MHz

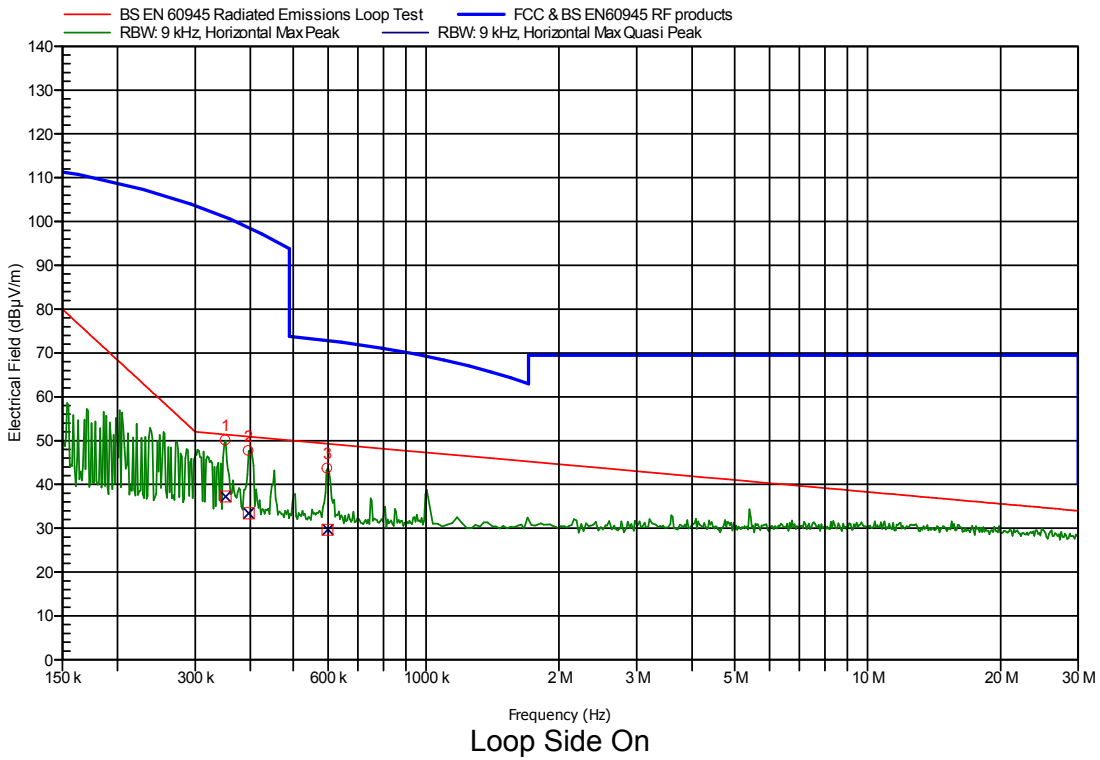
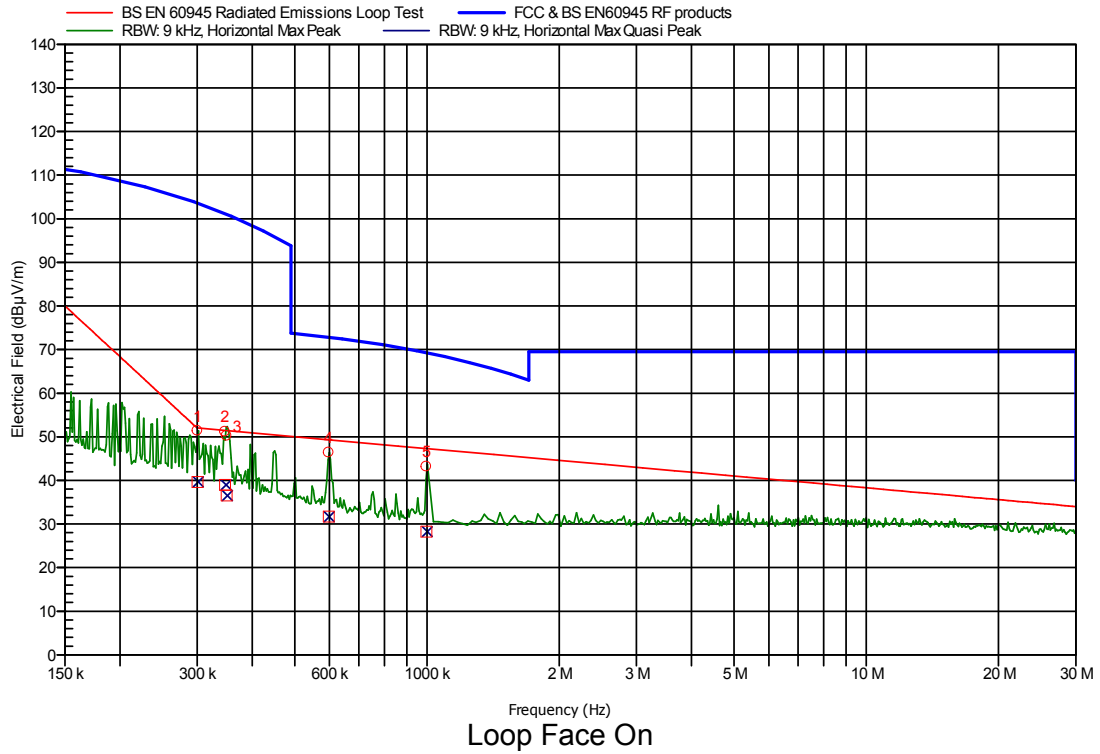

### 6.4 a77, 400 foot range, Radiated Emissions 150 kHz to 30MHz

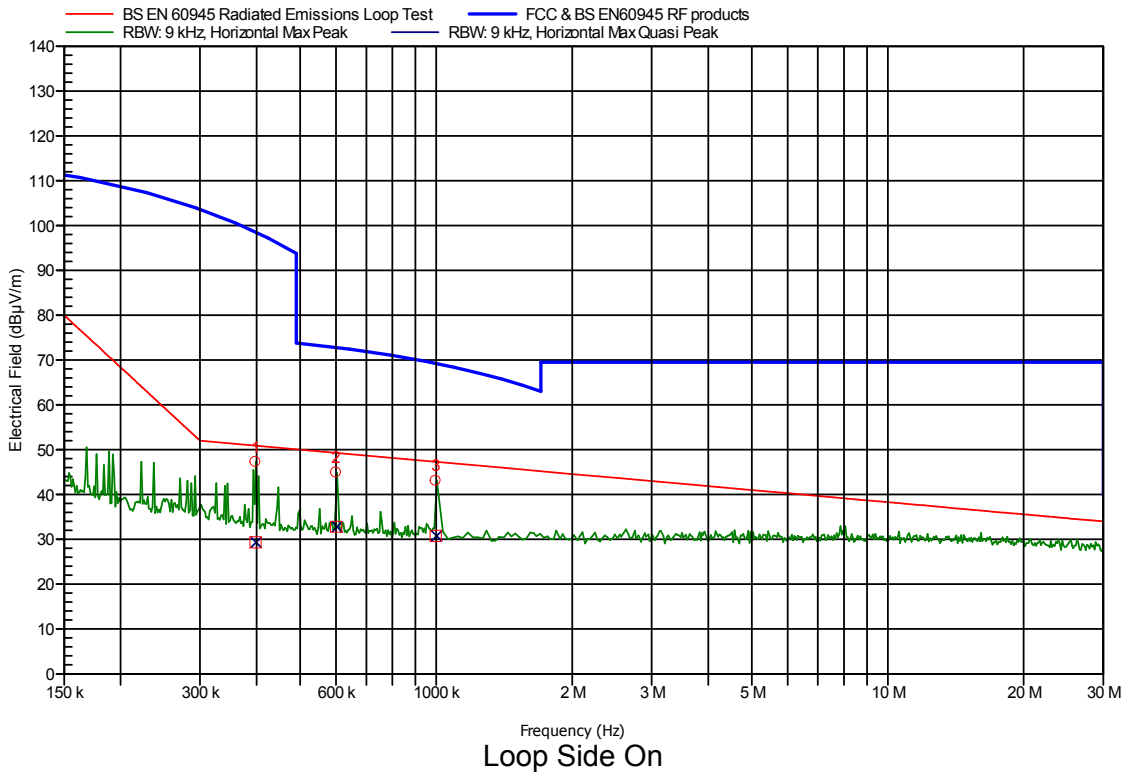
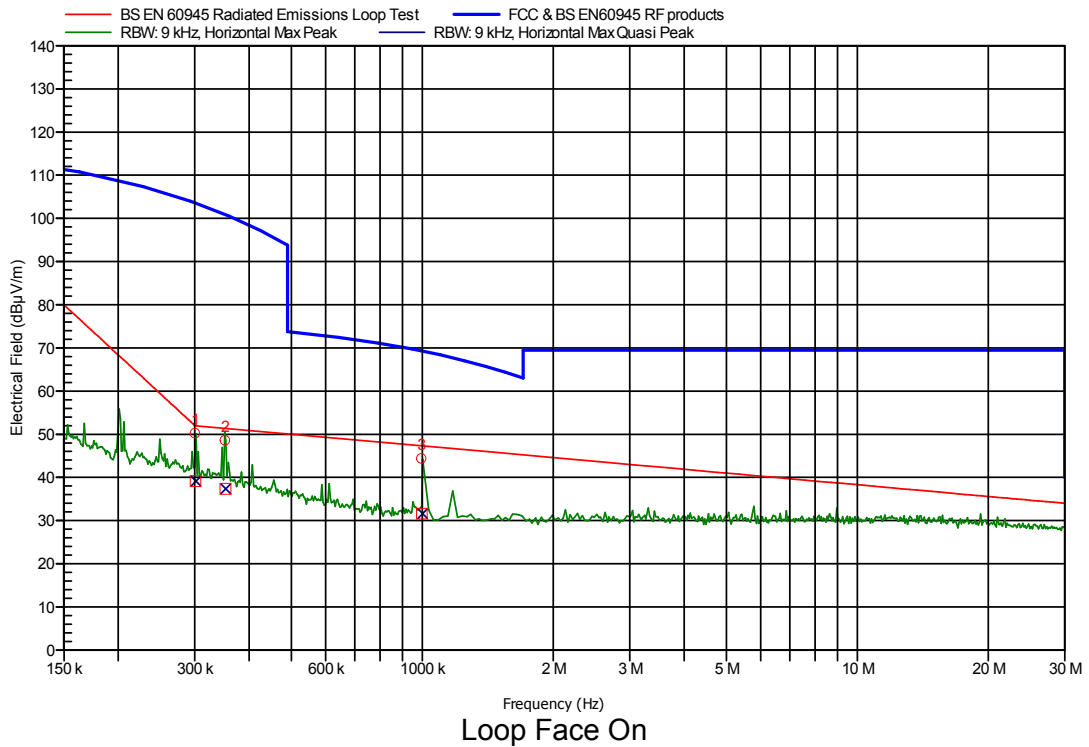

6.5 a77. 30 foot range, Radiated Emissions 30MHz to 300MHz

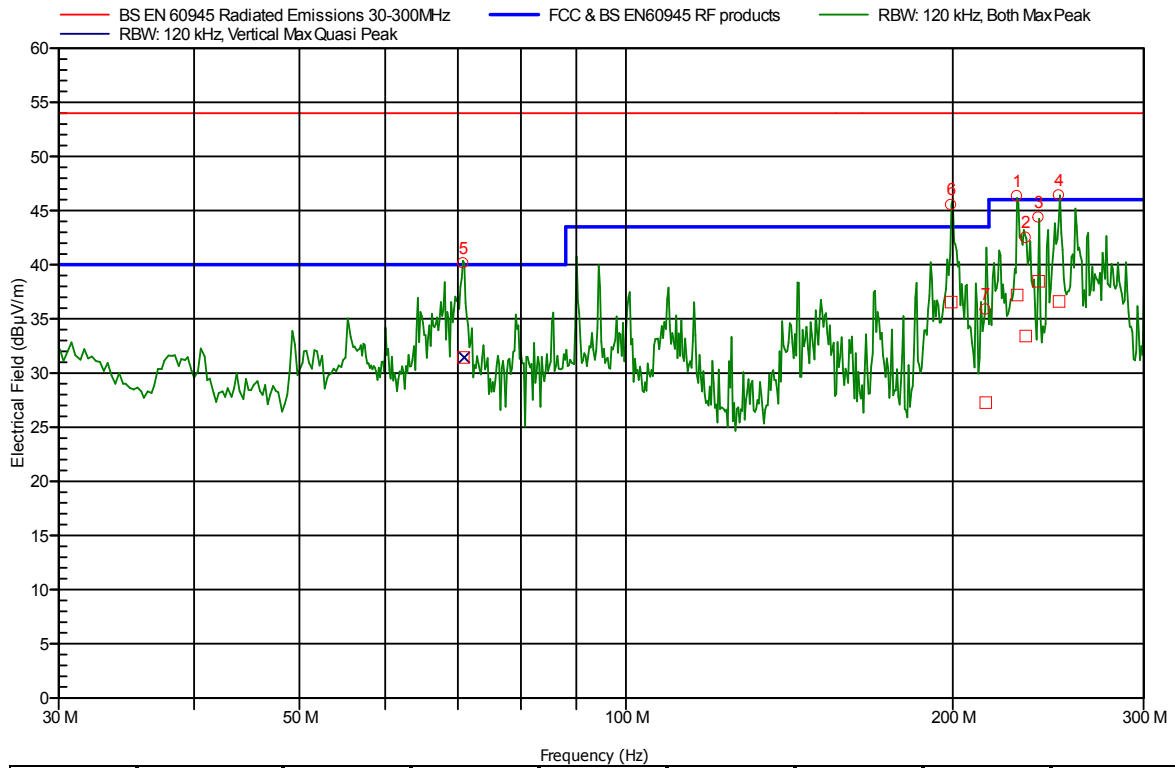

Nr	Frequency (MHz)	Peak Value (dBµV/m)	QP Value (dBµV/m)	QP Limit (dBµV/m)	Result	Angle	Height (m)	H/V
1	229.229	46.32	37.19	46	Pass	231 Degree	1.5 m	H
2	233.542	42.48	33.41	46	Pass	231 Degree	1.5 m	H
3	239.948	44.35	38.47	46	Pass	77 Degree	1.5 m	H
4	250.587	46.4	36.61	46	Pass	231 Degree	1.5 m	H
5	70.809	40.12	31.44	40	Pass	0 Degree	1.5 m	V
6	199.318	45.51	36.56	43.5	Pass	270 Degree	1.5 m	H
7	214.456	35.86	27.28	43.5	Pass	231 Degree	1.5 m	H

6.6 a77, 400 foot range, Radiated Emissions 30MHz to 300MHz

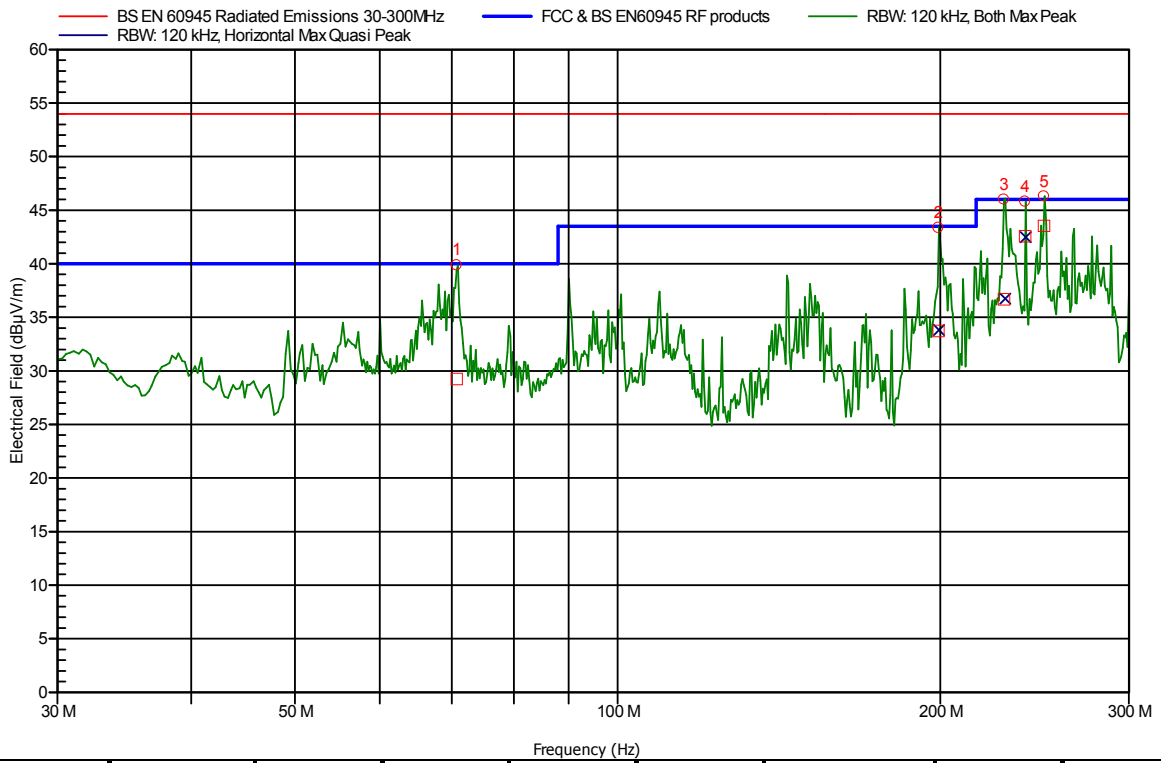

Nr	Frequency (MHz)	Peak Value (dBµV/m)	QP Value (dBµV/m)	QP Limit (dBµV/m)	Result	Angle	Height (m)	H/V
1	70.771	39.85	29.24	40	Pass	0 Degree	1.5 m	V
2	199.244	43.36	33.72	43.5	Pass	231 Degree	1.5 m	H
3	229.339	45.99	36.69	46	Pass	270 Degree	1.5 m	H
4	240.025	45.79	42.58	46	Pass	231 Degree	1.5 m	H
5	249.998	46.29	43.54	46	Pass	77 Degree	1.5 m	V

6.7 a77, 30 foot range, Radiated Emissions 300MHz to 1GHz

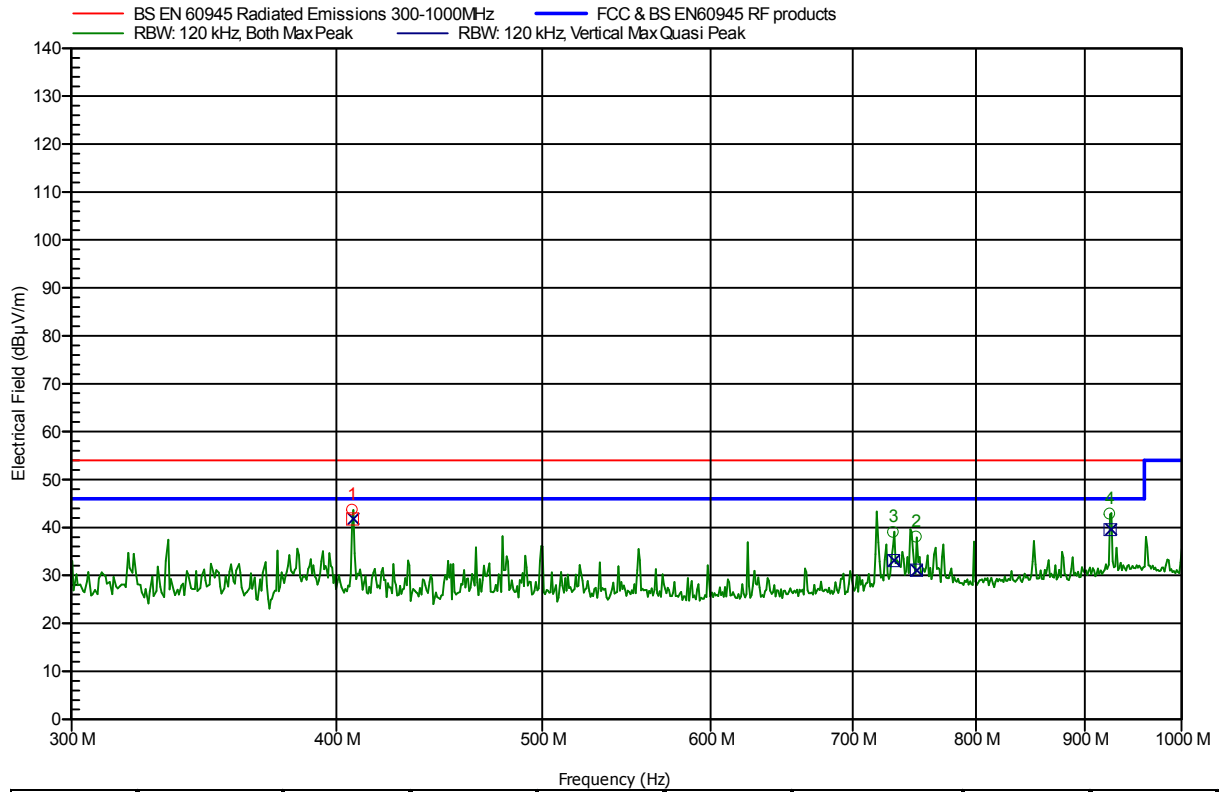

Nr	Frequency (MHz)	Peak Value (dBµV/m)	QP Value (dBµV/m)	QP Limit (dBµV/m)	Result	Angle	Height (m)	H/V
1	407.016	43.63	41.79	46	Pass	180 Degree	1.5 m	V
2	749.976	37.96	31.1	46	Pass	180 Degree	1.5 m	V
3	731.562	38.96	33.1	46	Pass	270 Degree	1.5 m	V
4	925.076	42.77	39.57	46	Pass	180 Degree	1.5 m	V



6.8 a77, 400 foot range, Radiated Emissions 300MHz to 1GHz

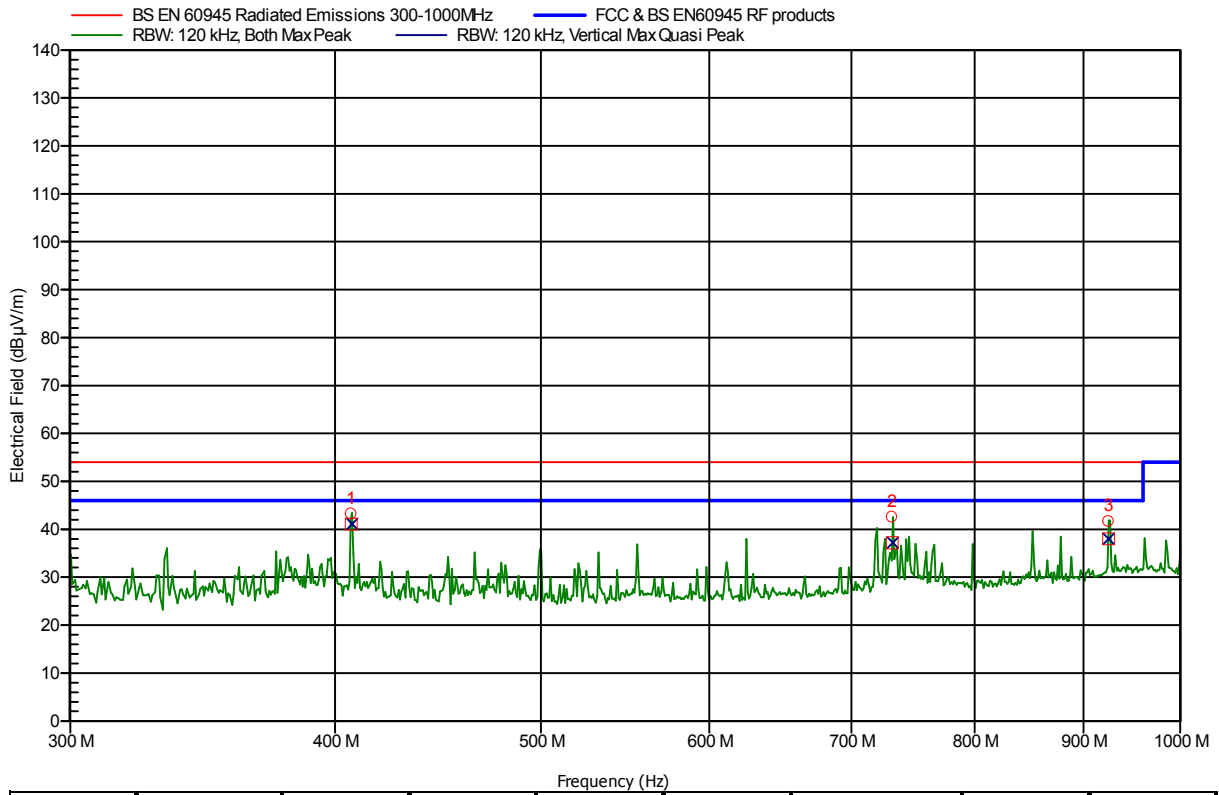

Nr	Frequency (MHz)	Peak Value (dBµV/m)	QP Value (dBµV/m)	QP Limit (dBµV/m)	Result	Angle	Height (m)	H/V
1	406.994	43.18	41.08	46	Pass	180 Degree	1.5 m	V
2	731.542	42.51	37.18	46	Pass	180 Degree	1.5 m	V
3	924.928	41.62	38	46	Pass	180 Degree	1.5 m	V

6.9 a77, 30 foot range, Radiated Emissions 1GHz to 2GHz

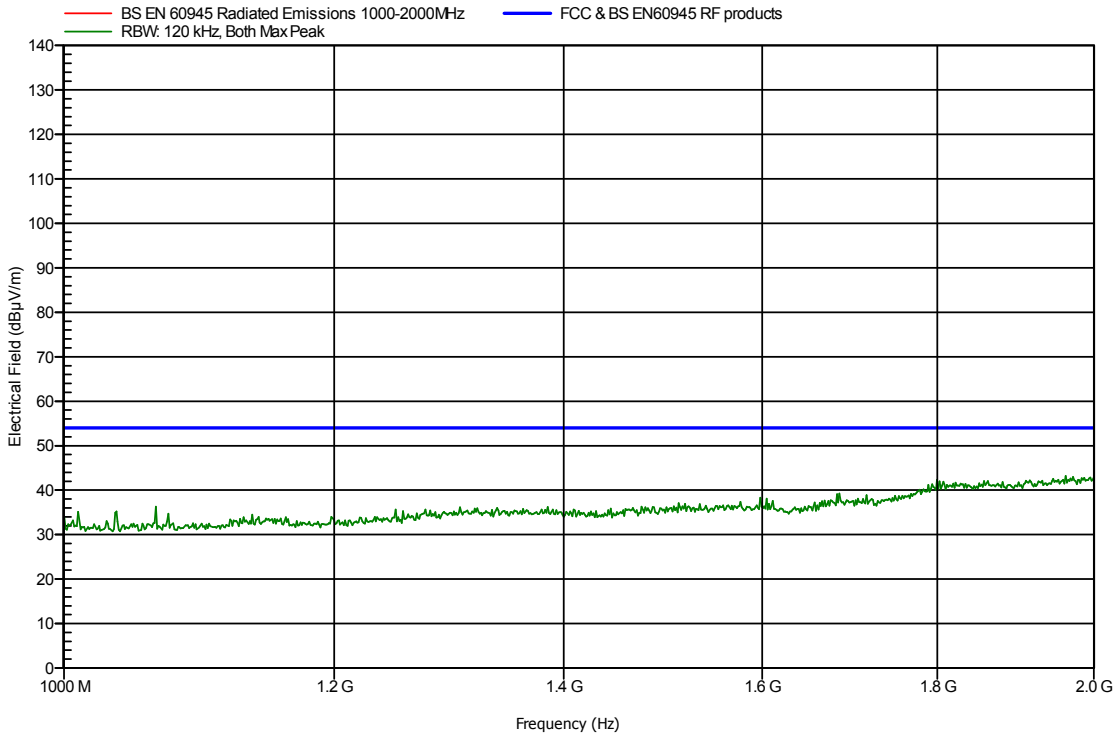

6.10 a77, 400 foot range, Radiated Emissions 1GHz to 2GHz

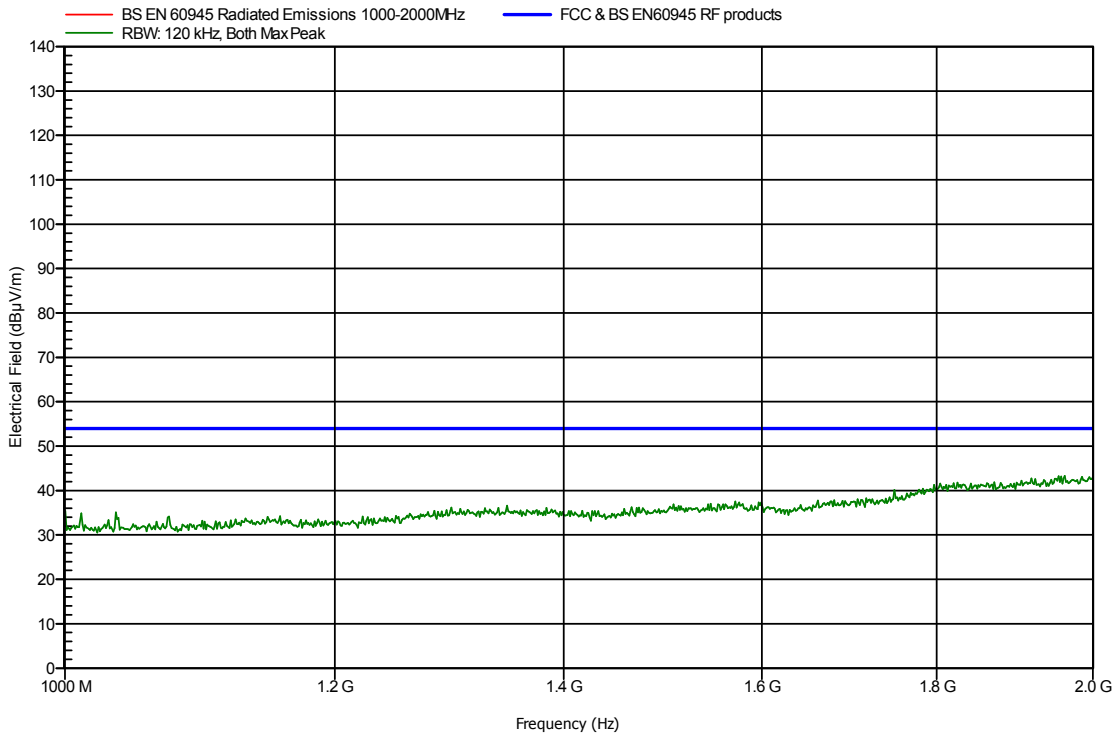

## 6.11 FCC Part 15, Chapter 47\_15.247 Spurious Emissions 2GHz to 26GHz

The following plots illustrate the radiated emissions of the EUT from 2GHz to 26GHz. The limit for emissions in this band is 20dBc for harmonics and 500 $\mu$ V/m. Any emissions more than 10dB of this limit are not recorded, however all emissions were more than 10dB below this limit.

A 100 kHz RBW was used in order to reduce to noise floor in the measuring receiver. The EUT was rotated through 360 degrees and antenna oriented horizontally & vertically during a peak hold sweep. The following graphs are the resultant peak hold results.

Emissions between 2GHz to 18GHz (Excluding specific plot 2GH-3GHz) were carried out using a 2.4GHz band stop filter to prevent the receiver from saturating.

### 6.11.1 Bluetooth Emissions

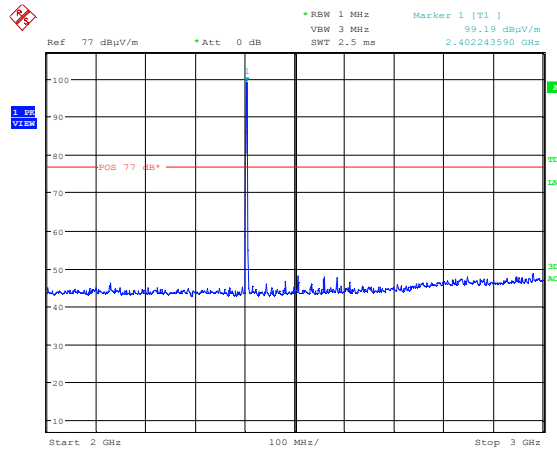

Date: 1.AUG.2013 14:27:12

### a77 1Mbps Bluetooth GFSK 9.5dBm nominal Channel 1 (2GHz - 3GHz)

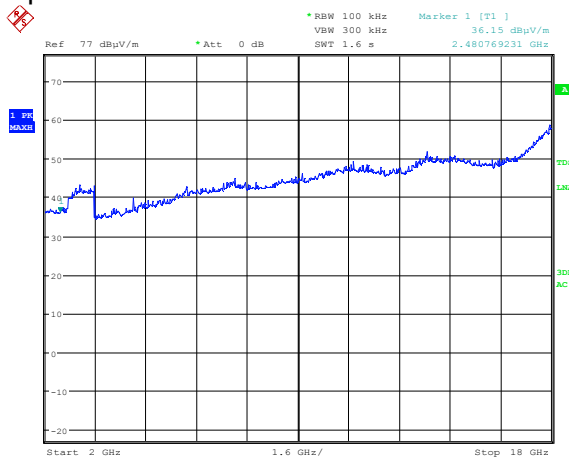

Date: 1.AUG.2013 14:40:18

### a77 1Mbps Bluetooth GFSK 9.5dBm nominal Channel 1 (2GHz to 18GHz)

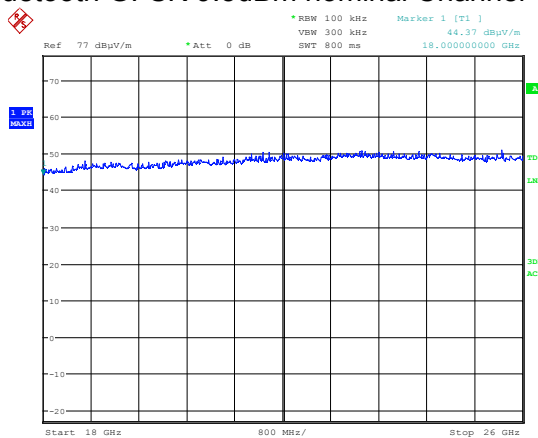

Date: 1.AUG.2013 14:53:14

### a77 1Mbps Bluetooth GFSK 9.5dBm nominal Channel 1 (18GHz to 26GHz)

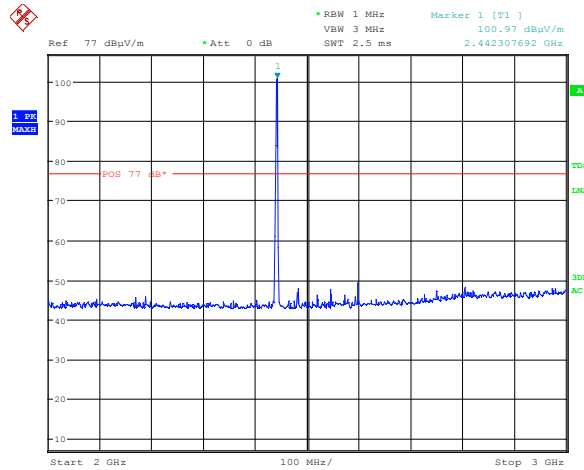

Date: 1.AUG.2013 14:29:52

a77 1Mbps Bluetooth GFSK 9.5dBm nominal Channel 40 (2GHz to 3GHz)

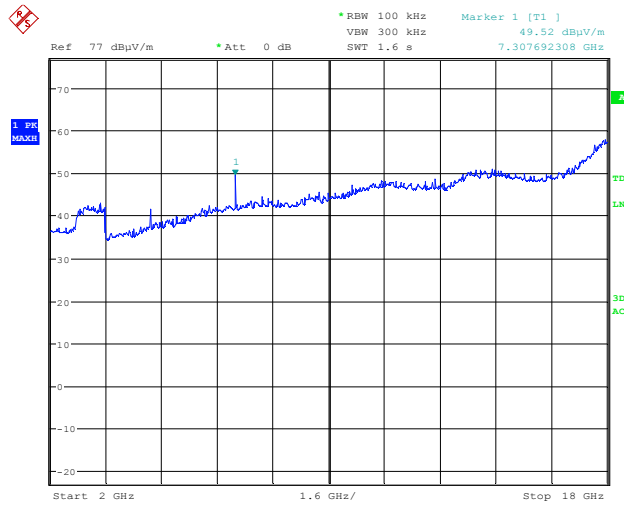

Date: 1.AUG.2013 14:42:49

a77 1Mbps Bluetooth GFSK 9.5dBm nominal Channel 40 (2GHz to 18GHz)

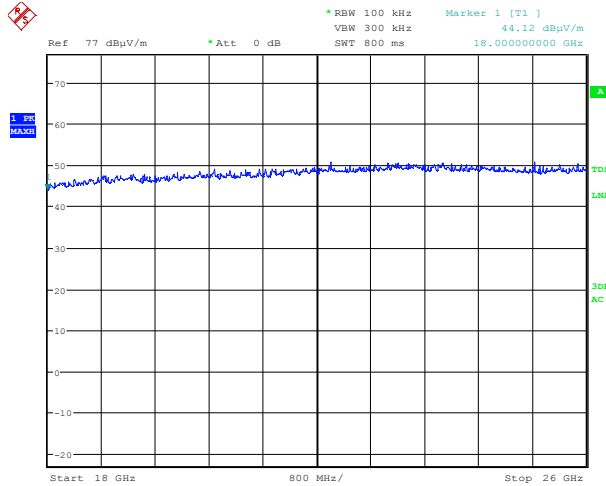

Date: 1.AUG.2013 14:55:49

a77 1Mbps Bluetooth GFSK 9.5dBm nominal Channel 40 (18GHz to 26GHz)

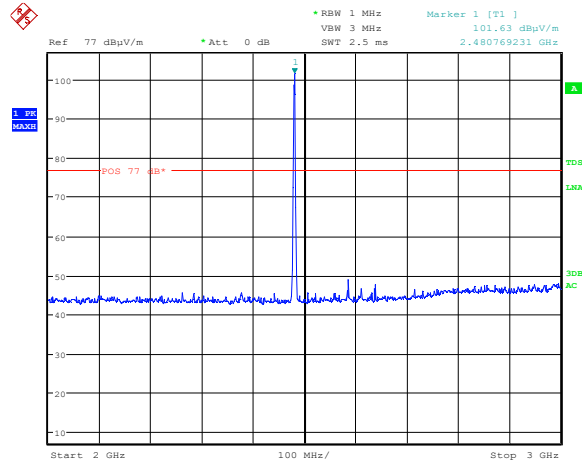

Date: 1.AUG.2013 14:32:18

a77 1Mbps Bluetooth GFSK 9.5dBm nominal Channel 79 (2GHz to 3GHz)

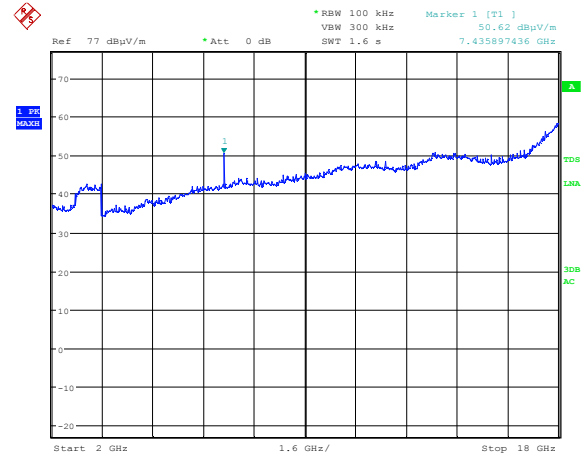

Date: 1.AUG.2013 14:45:09

a77 1Mbps Bluetooth GFSK 9.5dBm nominal Channel 79 (2GHz to 18GHz)

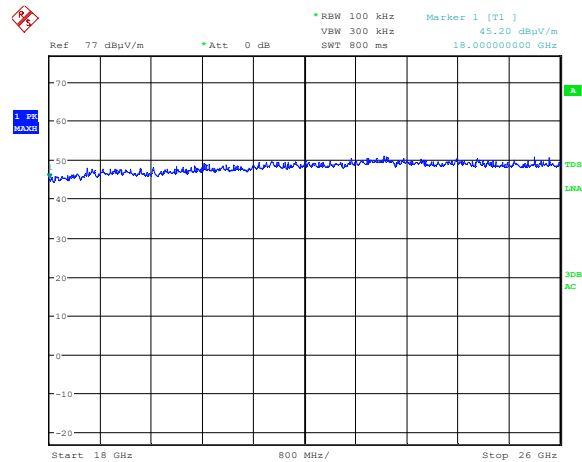

Date: 1.AUG.2013 14:58:17

a77 1Mbps Bluetooth GFSK 9.5dBm nominal Channel 79 (18GHz to 26GHz)

## 7 Receiver Spurious Emissions

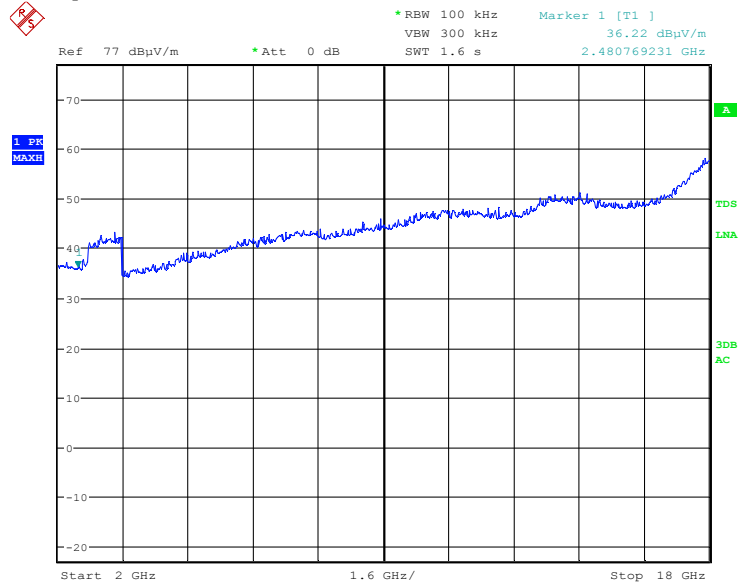

Date: 1.AUG.2013 14:35:45

### Receiver spurious emissions 2GHz to 18GHz

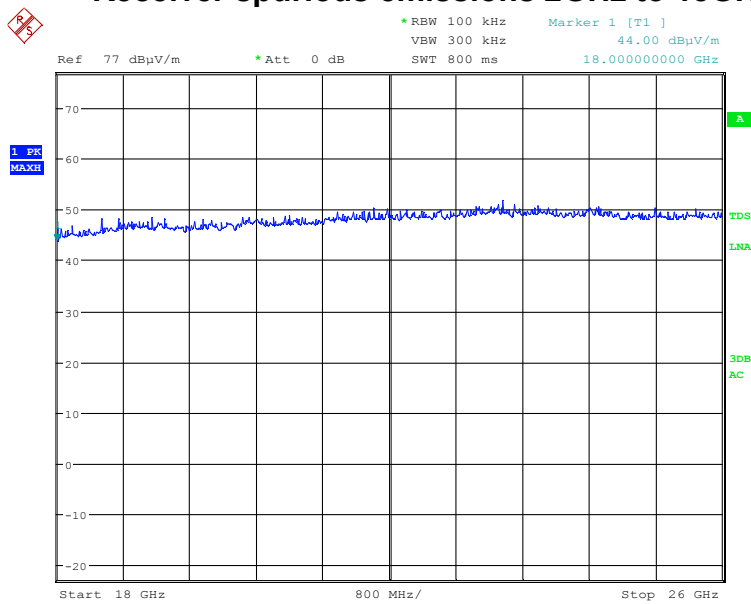

Date: 1.AUG.2013 14:50:41

### Receiver spurious emissions 18GHz to 26GHz

## 8 List of Test Equipment

Test Equipment Type	Manufacturer and Type Number	Serial Number	Cal No.	Cal Due
Digital Multimeter	Fluke 175	97460092	2248	7 <sup>th</sup> Nov 2013
EMI Receiver 20Hz to 26.5GHz	Rohde & Schwarz ESCI	100416	001692	22 <sup>nd</sup> Aug 2013
Active Loop Antenna 9kHz - 30MHz	Chase EMC HLA6120	1122	00442	14 <sup>th</sup> Feb 2014
Loop Antenna PSU/Charger	Chase EMC CBP9721	N/A	02671	N/A
Antenna Horn 1-18GHz	Chase BBHA9120D	9120D-578	01719	2 <sup>nd</sup> Nov 2014
Antenna Horn 18GHz-26GHz	Credowan 20-R-2843-0007	36755	482	16 <sup>th</sup> Nov 2014
Antenna 30MHz-3GHz	Chase CBL6141	22932	01802	23 <sup>rd</sup> Jul 2014
Antenna Mast (Site 1)	Inn-co GmbH MM4000	MM4000/056/13750 806/L	02075	N/A
Turntable (Site 1)	Inn-co GmbH DS1200S	DS1200S/175/1375 0806/L	02076	N/A
Mast/Turntable Controller (Site 1)	Inn-co GmbH Co 2000	CO/2000/359/137/5 0806/L	02077	N/A
EMI Receiver 20Hz to 40GHz	Rohde & Schwarz ESU40	100017	01721	22 <sup>nd</sup> Mar 2014
Power Supply Unit	Palstar PS30M	G290775401	2020	N/A

In accordance with UKAS requirements, all measuring equipment is on a calibration cycle.