



6+



R1512-0920

Keep these instructions for future reference as they contain important information. **IMPORTANT:** Please read all "Consumer Information" before operating your vehicle.

CAUTION: Surfaces may become hot and cause burns if electronics get wet. Do not operate vehicle through water or snow.

I. CONTENTS / FEATURES

Vehicle

Transmitter

Vehicle

- 1 ON(I)/OFF(O) switch
- 2 Steering adjuster

Transmitter

- 1 Forward / Reverse
- 2 Left / Right
- 3 Switch
- 4 Battery door

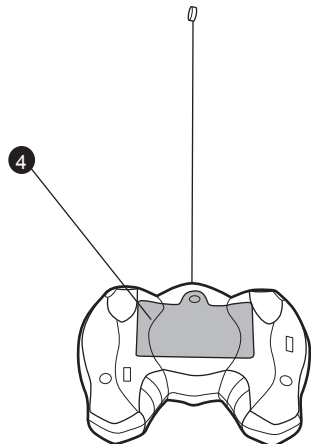
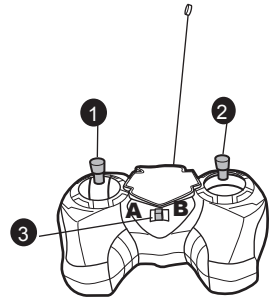
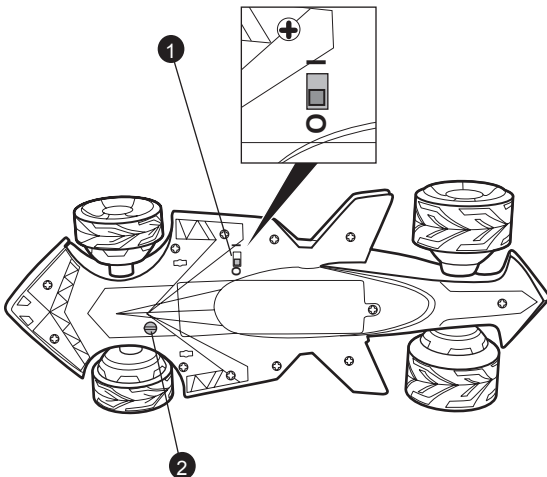
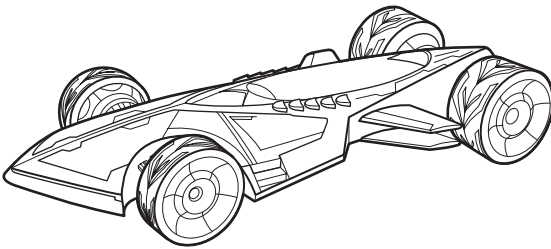

II. VEHICLE OPERATION

1.Forward Reverse

2.Left Right

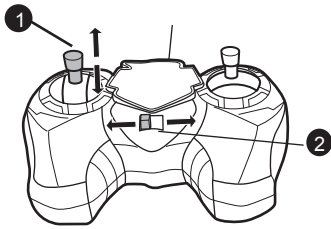

3.LEFT RIGHT

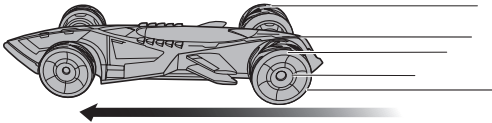
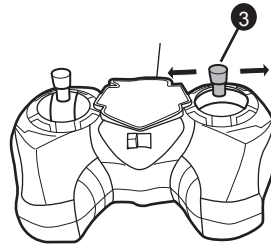

SIDE A

Reveal the hidden weapons

If the bumper hits an obstacle while driving on Side A, the panels will open to reveal the hidden secret weapons!

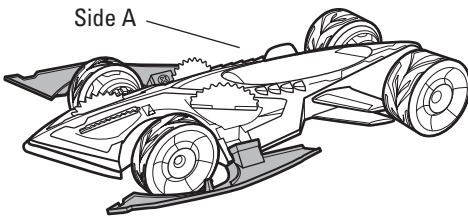

III. BATTERY INSTALLATION

Requires 4 AA Alkaline batteries for the vehicle and 2 AAA Alkaline batteries for the transmitter. Batteries not included.

Vehicle

1. Use a screwdriver (not included) to unscrew the power clip cover screw, remove the battery cover.
2. Install 4 AA Alkaline batteries (not included), with polarity (+/-) as shown inside the battery compartment.
3. Replace the battery door and tighten screw.

Transmitter

1. Remove the battery cover as shown.
2. Install 2 AAA Alkaline batteries (not included), with polarity (+/-) as shown inside the battery compartment.
3. Replace the battery cover.

Once the batteries are installed the transmitter will always be "ON" and will work automatically the moment you use it.

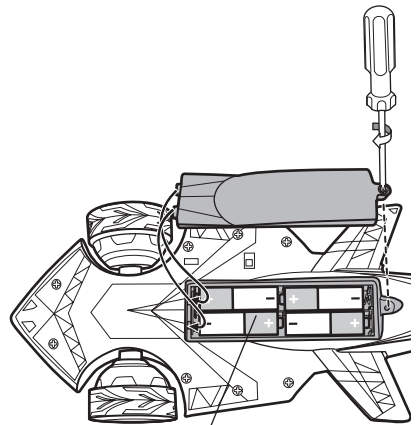

4 x AA

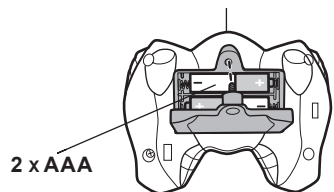

2 x AAA

IV. QUICK TIPS

1. When your vehicle starts to lose power, it may lose functionality or performance. It's time for fresh batteries.
2. Your vehicle's running time may vary depending on your driving style.
3. Radio interference can affect your vehicle's performance. Interference can be caused by other R/C vehicles running on the same frequency, electrical wires, large buildings, CB radios or other wireless gear. Try to stay away from these!
4. Point your transmitter up - not down toward your vehicle. If your vehicle gets too far away, it won't work properly.
5. Don't drive your vehicle through water or snow. If your vehicle does get wet, wipe it with a towel and allow it to dry completely.
6. Don't store your vehicle near heat or in direct sunlight. Always turn switches OFF and remove all batteries for storage.

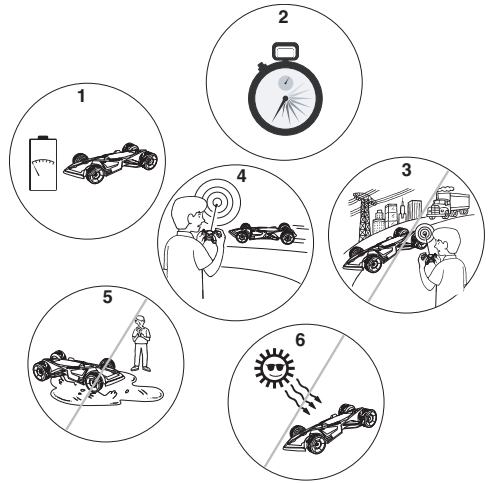

V. CONSUMER INFORMATION

Note to adults: To ensure that the child's play is both safe and fun, please review all operating instructions and safety rules with your child.

Safety Tips

- NEVER drive your vehicle on streets! They're for real cars!
- DO NOT pick up vehicle while in motion.

CAUTION: To prevent entanglement, keep hair away from wheels.

- Keep fingers, hair and loose clothing away from the tires and the wheel hubs while the vehicle is switched ON.
- Adult supervision is recommended when this vehicle is being operated.
- To avoid accidental operation, remove all batteries when not in use. Always turn the vehicle OFF before removing batteries.

BATTERY SAFETY INFORMATION

In exceptional circumstances batteries may leak fluids that can cause a chemical burn injury or ruin your product. To avoid battery leakage:

- Non-rechargeable batteries are not to be recharged.
- Rechargeable batteries are to be removed from the product before being charged (if designed to be removable).
- Rechargeable batteries are only to be charged under adult supervision (if designed to be removable).

- Do not mix alkaline, standard (carbon-zinc), or rechargeable (nickel-cadmium) batteries.
- Do not mix old and new batteries.
- Only batteries of the same or equivalent type as recommended are to be used.
- Batteries are to be inserted with the correct polarity.
- Exhausted batteries are to be removed from the product.
- The supply terminals are not to be short-circuited.
- Dispose of battery(ies) safely.
- Do not dispose of this product in a fire. The batteries inside may explode or leak.

WARNING: Inserting or changing batteries are actions that must be done to Note to Adults: – using the appropriate tool to open and close battery compartment.

Battery Performance Note:

For best performance use regular or high-performance alkaline batteries (where disposable batteries are called for). If your vehicle is supplied with standard (carbon-zinc) batteries for initial use and/or demonstration purposes, we recommend replacing them with alkaline batteries when necessary. Battery life may vary depending on battery brand.



Protect the environment by not disposing of this product with household waste [2002/96/EC]. Check your local authority for recycling advice and facilities.

© 2010 Mattel, Inc. 636 Girard Avenue, East Aurora, NY 14052, U.S.A.
Consumer Relations 1-800-524-8697. • Mattel Canada Inc., Mississauga,
Ontario L5R 3W2. You may call us free at 1-800-524-8697. • Mattel U.K.
Ltd., Vanwall Business Park, Maidenhead SL6 4UB. Helpline 01628 500303.
• Mattel Australia Pty., Ltd., Richmond, Victoria. 3121. Consumer Advisory
Service - 1300 135 312 Mattel East Asia Ltd., Room 1106, South Tower,
World Finance Centre, Harbour City, Tsimshatsui, HK, China. • Diimport
& Diedarkan Oleh: Mattel SEA Ptd Ltd. (993532-P) Lot 13.5, 13th Floor,
Menara Lien Hoe, Persiaran Tropicana Golf Country Resort, 47410 PJ.
Tel:03-78803817, Fax:03-78803867. service.mattel.com

This device complies with Part 15 of the FCC Rules.

Operation is subject to the following two conditions:

(1) This device may not cause harmful interference, and (2) this device must accept any interference received, including interference that may cause undesired operation.

- This equipment has been tested and found to comply with the limits for a Class B digital device, pursuant to part 15 of the FCC rules. These limits are designed to provide reasonable protection against harmful interference in a residential installation. This equipment generates, uses and can radiate radio frequency energy and, if not installed and used in accordance with the instructions, may cause harmful interference to radio communications. However, there is no guarantee that interference will not occur in a particular installation. If this equipment does cause harmful interference to radio or television reception, which can be determined by turning the equipment off and on, the user is encouraged to try to correct the interference by one or more of the following measures:
 - Reorient or relocate the receiving antenna.
 - Increase the separation between the equipment and receiver.
 - Connect the equipment into an outlet on a circuit different from that to which the receiver is connected.
 - Consult the dealer or an experienced radio/TV technician for help.

NOTE: Changes or modifications not expressly approved by the manufacturer responsible for compliance could void the user's authority to operate the equipment.