

The uprising begins
HERE

Mind FLEX™

Game

Instruction Manual

IMPORTANT: Please read the entire Quick Start section before playing any games.

www.mindflexgames.com

Requires 4 'C' alkaline batteries for console
and 3 'AAA' alkaline batteries for headset
(Not Included).



Keep these instructions for future reference
as they contain important information.

TABLE OF CONTENTS

Overview	2	Teeter-Totter	17
Components List	2	Propeller Wheel	19
Product Diagrams	3	Building a Course	20
Quick Start	5	The Games	21
Battery Installation	5	The Game Menu	21
Putting on the Headset	6	Freestyle	23
Turning on the Console	7	Mental Marathon™	24
Controlling the Ball	8	Danger Zone	26
Concentration Tips	8	Chase the Lights	28
Obstacles	11	Thoughtshot™	30
Obstacle Difficulty Levels	11	Troubleshooting	32
Ring Towers	12	Connection Problems	32
Maze Cages	13	Problems Controlling the Ball	33
Funnel	15	Status Light Reference Chart	34
Cannon	16		



OVERVIEW

GET READY TO CONTROL THE ACTION AS YOU NEVER HAVE BEFORE – WITH THE POWER OF YOUR MIND!

Just put on the Mindflex™ headset and your own brainwaves will move a ball up and down on a cushion of air. Concentrate and the ball will rise, relax and it will descend – it's literally mind over matter!

THE OBJECT IS SIMPLE.

Race through a mind-bending obstacle course as quickly as you can. The player with the fastest time wins!

THE CHALLENGES ARE ENDLESS!

Ready to flex your mental muscles? Then get your brain in the game with Mindflex™!

COMPONENTS

Mindflex™ comes with the following components:

- 1 Game Console
- 1 Headset
- 4 Balls
- 3 Ring Towers
- 5 Rings
- 2 Maze Cages
- 2 Wall Panels
- 4 Shelf Panels
- 1 Funnel (3 pieces)
- 1 Cannon (3 pieces)
- 1 Teeter-Totter
- 1 Propeller Wheel

HANDLE FOAM BALLS WITH CARE.

Do not press, crush or squeeze the foam balls, or you may damage their ability to levitate.

Keep them safe by storing them in the compartment on the underside of the console. (see page 3).

OVERVIEW

1. Fan Nozzle
2. Calibration Point
3. Start Spaces
4. Control Knob
5. Select Button
6. Enter Button
7. Sensor LEDs
8. On/Off Switch (side)
9. Status Light
(refer to chart in Troubleshooting section)
10. Foam Ball Storage Compartment (Bottom)
11. Battery Compartment (Bottom)

THE CONSOLE

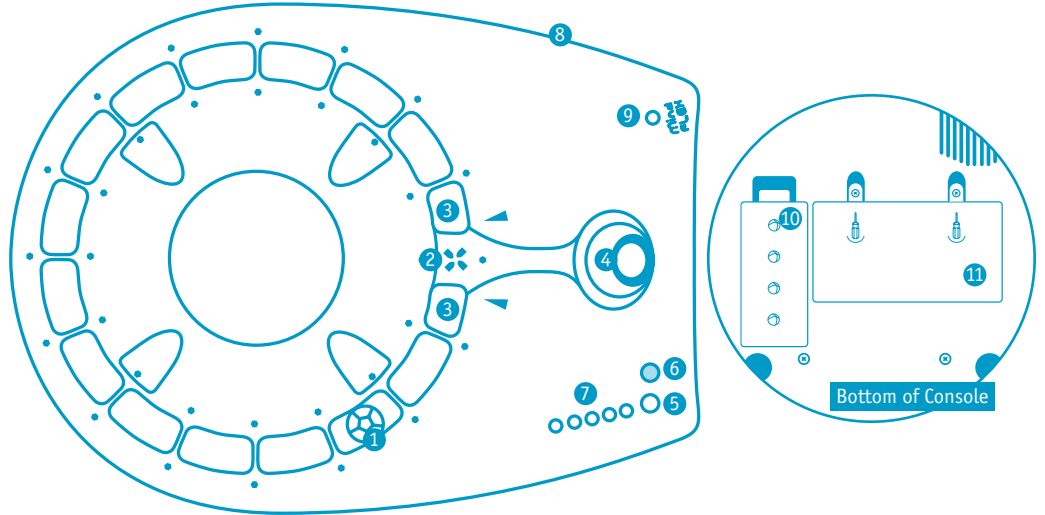

3

THE HEADSET

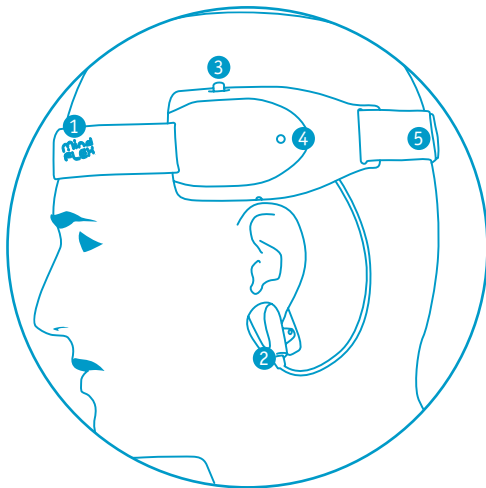
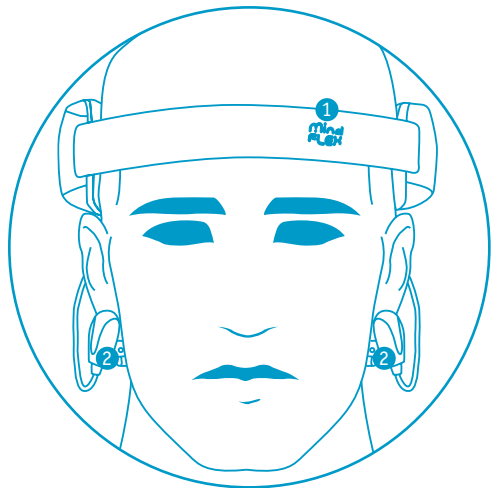

1. Forehead Sensor
2. Ear Clips
3. On/Off Switch
4. Power Light
5. Adjustable Buckle

4

OVERVIEW

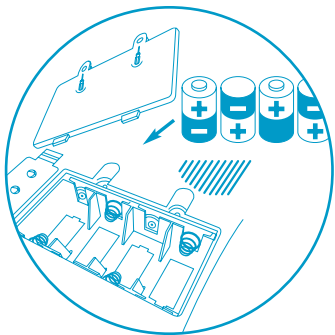

BATTERY INSTALLATION

CONSOLE

1. Open battery cover with Phillips head screwdriver (not included).
2. Insert 4 'C' alkaline batteries as shown.
3. Replace battery cover and tighten the screws.

For best performance, use only alkaline batteries. When the console's status light begins to blink GREEN, its batteries are low. Replace console batteries when console lights dim, sound becomes distorted or ball can no longer achieve a maximum height of 5 inches when all 5 sensor LEDs are lit.

HEADSET

1. Open battery cover with Phillips head screwdriver (not included).
2. Insert 3 'AAA' alkaline batteries as shown.
3. Replace battery cover and tighten the screw.

When the console's status light or the headset's power light blinks RED, the headset batteries are running low.

Refer to the Troubleshooting section for descriptions of all status messages.

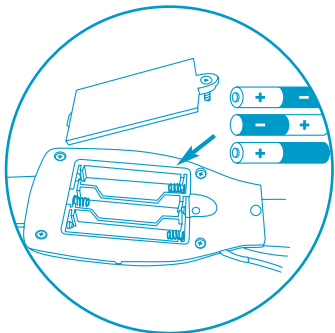

PUTTING ON HEADSET

Helpful Hints

1. Before putting on the headset, be sure to remove hats, ponytails, hairclips or anything else that might get in the way, and brush the hair from your forehead.
2. Before attaching the ear clips, remove earrings.
3. Periodically clean the forehead and ear clip sensors with a cloth or paper towel moistened in warm, soapy water.

1. Put on the headset as shown. Make sure the forehead sensor located under the Mindflex™ logo is positioned above your left eye, flat against your forehead, with no hair between your skin and the sensor.
2. If the headset does not fit comfortably against your forehead, use the buckle on the back of the headset to adjust for a snug fit.
3. Attach the ear clips to each ear lobe so the metal sensors are flat against your skin.
4. While sitting as still as you can, turn on the headset – the headset's red Power Light will come on.

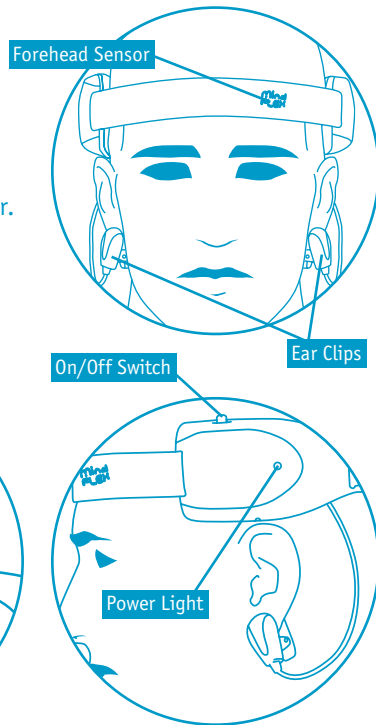

6

QUICK START

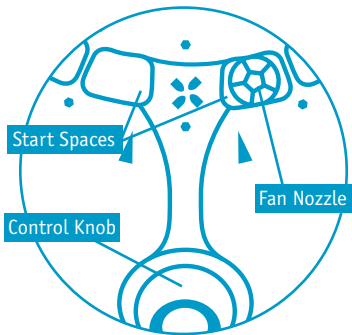

TURNING ON CONSOLE

1. Move the fan nozzle to either start space by turning the control knob – the start spaces are marked with arrows. Place a ball above the fan nozzle.
2. Turn on the console.
3. When the console says “Select Game,” press the SELECT button (white) until you hear “Freestyle.”

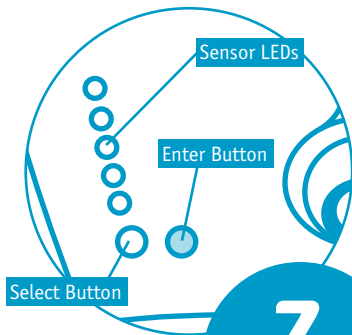
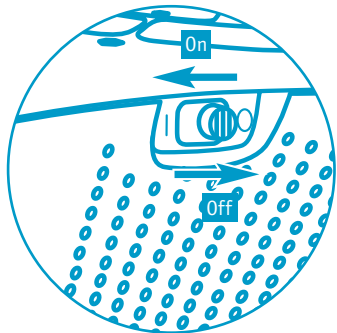

4. Press the ENTER button (gray) to confirm your choice of “Freestyle.”
5. It may take a few seconds for the console to communicate with the headset. Just remain still until it does so. Once a connection is established, the console will beep and tell the player, “Begin.”

Connection Problems

Whenever the headset fails to read your brainwaves, the console will say, “Check headset sensors.” If this happens during a game, the game timer will pause until the signal is restored. Refer to the TROUBLESHOOTING section for tips on connection problems.

CONTROLLING THE BALL

The time has come to put your brainpower to the test! Try each of the practice exercises below to familiarize yourself with controlling the ball. **Do not** put any obstacles on the console yet.

The sensor LEDs (5 lights) on the face of the console will display your level of concentration.

RAISING THE BALL (HIGH CONCENTRATION)

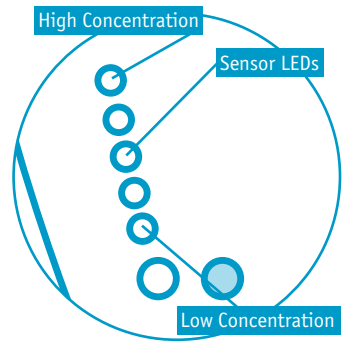

The higher your concentration, the higher the ball will float – up to a height of approximately 5 inches.

Exercise #1: Raise the ball as high as you can and try to hold it there for three seconds.

Tips for Increasing Concentration

- Relax your face – try not to move any muscles in your face.
- Stare at the ball. Concentrate all of your attention on it.
- Picture the ball rising.
- Focus your attention on the exact spot you want to see it reach.
- Imagine pushing the ball up with your mind.
- Do math problems in your head.
- Think the same thought over and over.

Everyone is different, so find out what works best for you!

Tips for Lowering Concentration

- Try to clear your mind.
- Relax your body.
- Take deep breaths.
- Close your eyes for a moment then open them and look at different parts of the console without focusing on anything.
- Think about sleeping.
- Think about a peaceful, relaxing place.

Again, discover what techniques work best for you!

LOWERING THE BALL (LOW CONCENTRATION)

By relaxing your concentration, the ball will descend.

Exercise #2: Lower the ball. Try to hold the ball in place for three seconds.

Exercise #3: Raise and lower the ball three times in a row.

MOVING THE BALL RIGHT OR LEFT (CONTROL KNOB)

To move the ball – and the fan nozzle – right or left around the console, turn the control knob. Turning it clockwise will move the fan in a counter-clockwise direction, and turning it counter-clockwise will move the fan in a clockwise direction.

Exercise #4: Concentrate until the ball is floating as high as you can get it. Turn the control knob and move the ball all the way around the console, trying to keep the ball at the same height.

Exercise #5: Once you reach the end, relax your thoughts until the ball is floating as low as you can get it. Now turn the control knob in the opposite direction and move the ball back the other way, maintaining the low height of the ball.

Exercise #6: Press ENTER to end the game.

Congratulations! By completing this Quick Start you have begun to master the power of your mind! Now it's time to tackle the obstacles!

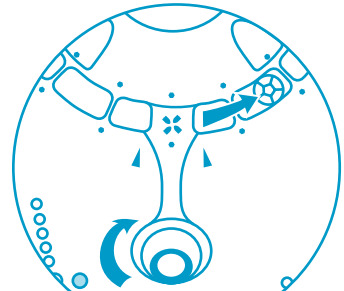

Turn control knob clockwise to move fan counter-clockwise

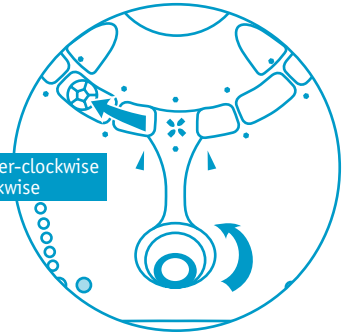

Turn control knob counter-clockwise to move fan clockwise

OBSTACLES

It takes serious mental focus to navigate the ball around the Mindflex™ course. Each obstacle you face along the way will provide a unique “mental block” to challenge your concentration skills.

You will find that some obstacles are more challenging than others. When building your obstacle course, you may want to start with the easier obstacles first.

Difficulty of Obstacles

Easy

Ring Towers
Maze Cages

Medium

Funnel
Cannon

Hard

Teeter-Totter
Propeller Wheel

RING TOWERS

Each ring tower has 5 sockets. Customize the towers by inserting rings into the sockets at whatever angle you want. **A**

Plug the ring towers into the console, making sure the rings point toward the center of the console. **B**

The following diagrams show how to navigate the ball through several different ring tower set-ups:

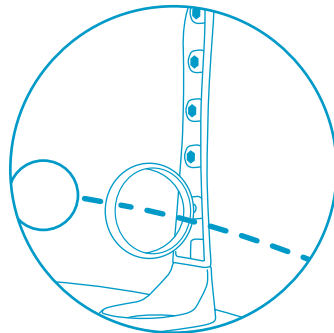
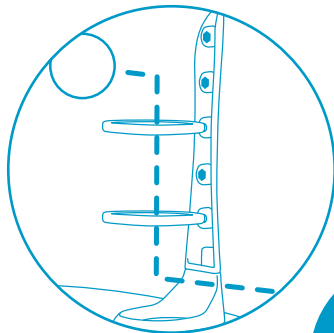
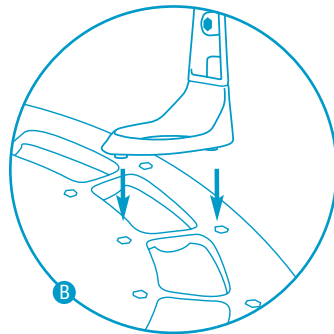
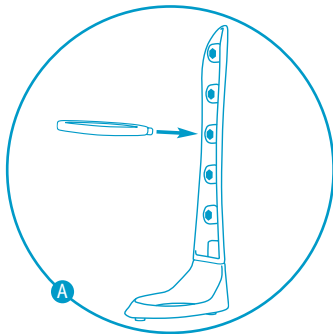

Upper Shelf Panel (2)

Lower Shelf Panel (2)

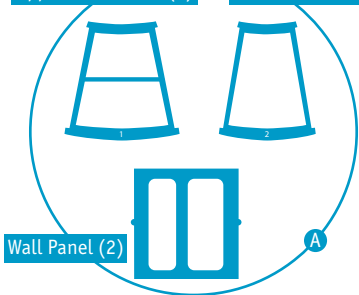

Notches in each maze cage allow you to add both an upper shelf panel and a lower shelf panel. You can identify an upper shelf panel by its crosspiece. Lower shelf panels have no crosspiece. **A**

To add a shelf panel to a maze cage, insert the pins on one side of a shelf into the notches on one side of a cage (make sure you use an upper shelf panel for the upper notches and a lower shelf panel for the lower notches). Tilt the shelf down until the pins on the other side of the shelf snap into the notches on the opposite side of the cage. **B**

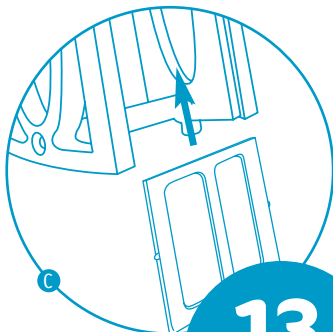

Slide wall panels into their tracks from the bottom of the maze cages. **C**

Plug maze cages into the console with their **widest side** positioned along the outer edge of the console – you can identify the wide side of a cage by its open corners. **D**

MAZE CAGES

When both shelves are in position, you can slide a wall panel into one of four positions to block different paths through a cage. **E**

REMEMBER: You do not need to use all the pieces when building your maze cages. Just make sure you always create a path that allows a ball to pass in one side of the cage and out the other.

SAMPLE MAZE CAGE CONFIGURATIONS

To get started, try building the following maze cage. **F**

For a greater challenge, you can place the two cages next to each other, with the entrance of the first cage at the bottom, and the exit from the second cage at the top. **G**

See what other combinations you can come up with!

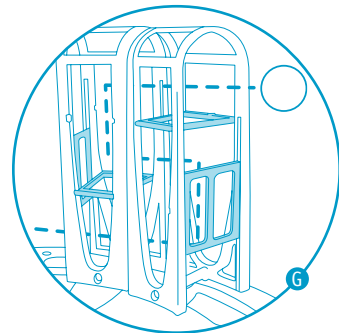
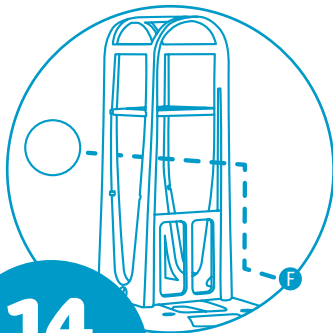
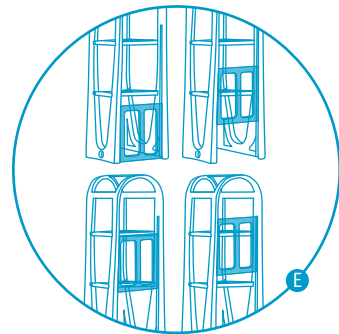
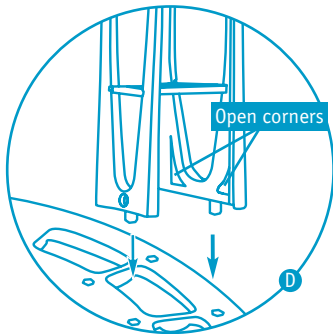

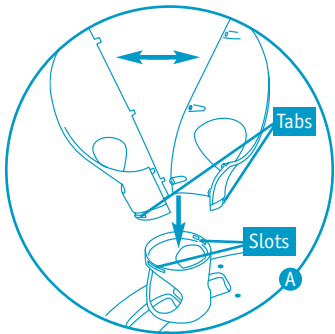

Snap the two halves of the funnel together. Next, line up the tabs in the funnel with the slots in the funnel base then plug the funnel into the base. **A**

Attach the funnel to the console so the funnel opening points toward the center of the console.

Navigate this obstacle by traveling through the holes in the side of the funnel – but be careful! If the ball floats too high, the funnel will spit it out! **B**

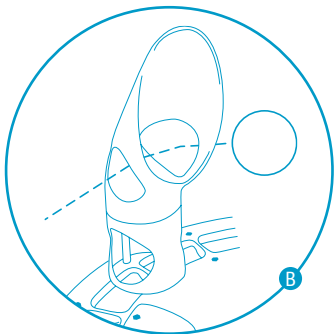

You can also use the base as a stand-alone obstacle. **C**

FUNNEL

CANNON

Line up the notches in the barrel with the tabs in the elbow and plug them together. Next, plug the elbow into the cannon base. The elbow will rotate freely within the base, allowing you to aim the cannon as desired. Attach the assembled cannon to the console.

For a Greater Challenge

You can use the cannon as a stand-alone obstacle. Try to navigate through its base without getting shot out.

Use the cannon with the funnel obstacle. For best performance, position them directly across the console from each other.

Move the ball through the holes in the cannon base then concentrate to launch the ball into the funnel!

Adjust the angle of the cannon until you find what works best for you.

Experiment with moving the funnel to different positions around the console. Simply adjust the angle of the cannon so it points into the funnel then see how many baskets you can make!

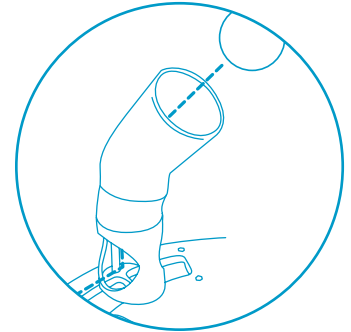
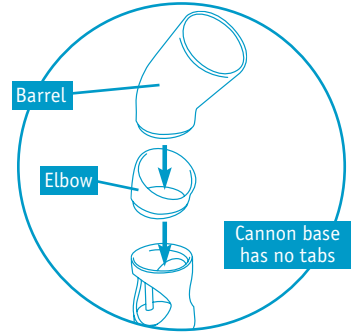

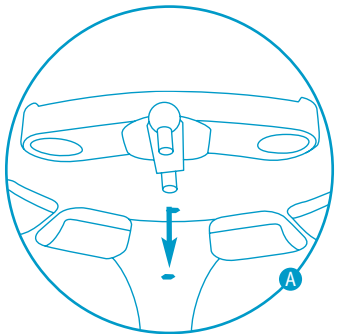

Plug the teeter-totter into the console so that it follows the curve of the console. **A**

Maneuver the ball above the hole on one side of the teeter-totter then relax your concentration to lower the ball. **B**

Once the ball rolls to the other end of the teeter-totter, move the fan nozzle beneath it.

Concentrate to raise the ball out of the teeter-totter and proceed on your way. **C**

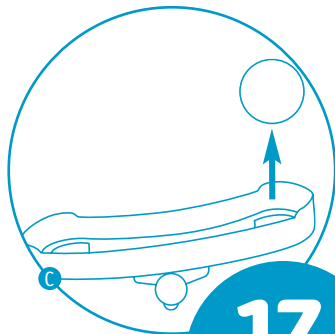
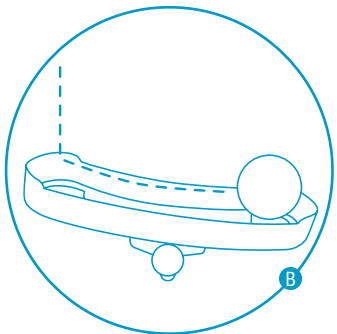

IMPORTANT: The teeter-totter is the *only* obstacle that can be placed above the *calibration point*.

The calibration point blocks the flow of air from the fan so the ball cannot float above it. However, by placing the teeter-totter here, you create a bridge that will allow you to travel back and forth over this point in either direction.

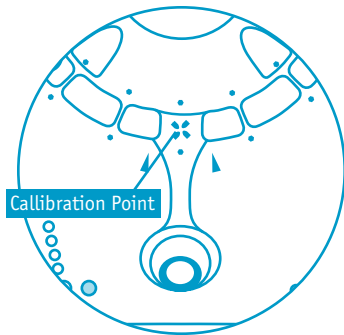

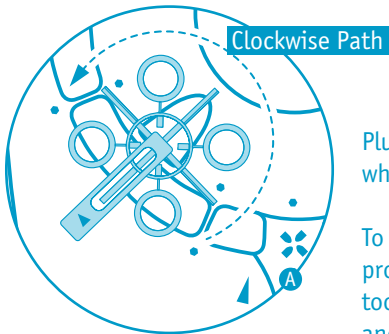

Plug both pegs of the propeller wheel into the console. Air from the fan will cause the propeller wheel to spin in a counter-clockwise direction.

To pass this obstacle, lower the ball onto one of the four loops. Use the fan to gently spin the propeller wheel until you move the ball to the other side of the obstacle. Be careful – if you spin it too fast, you'll knock the ball off! Once the ball is on the other side, levitate the ball from its loop and continue on your way.

IMPORTANT: THIS IS A ONE-WAY OBSTACLE!

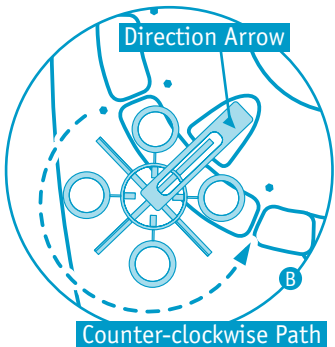

Because the propeller wheel only spins in one direction, it will only allow you to travel in one direction around the course. Depending on the obstacle's position, you will either be able to travel in a clockwise or a counter-clockwise direction around the console. **A B**

When the propeller wheel is attached to the console, just check the arrow painted on its top – it points in the direction the ball must travel to pass the obstacle.

BUILDING A COURSE

Create whatever course you can imagine by choosing your obstacles and positioning them wherever you want. You'll discover hundreds of mind-bending combinations!

When you build an obstacle course, follow these simple guidelines:

1. Obstacles can be positioned anywhere around the console **except** over the two start spaces.
2. Be sure to leave at least one empty space between each obstacle.
3. Do not place any obstacles over the calibration point **except** the teeter-totter (see page 17-18).
4. Remember, you can only travel past the propeller wheel in one direction – make sure you set it in the direction you want to go (see page 19).

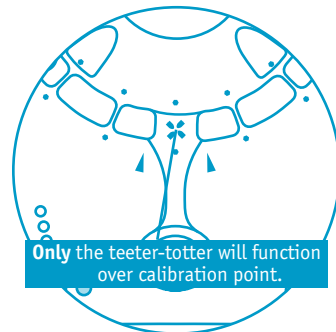
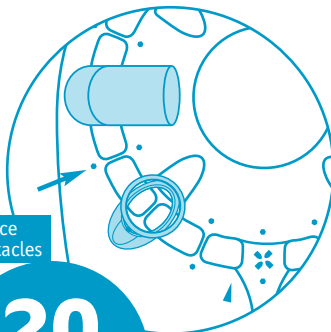
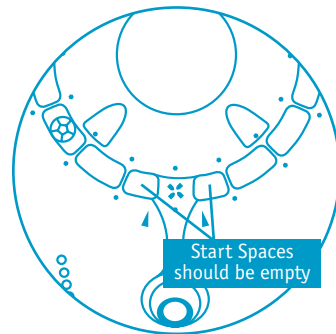

THE GAMES

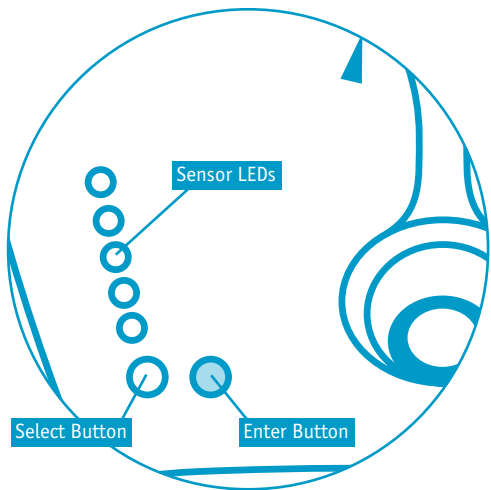

Now that you've familiarized yourself with controlling the ball and the different obstacles, it's time to try out the games! Mindflex™ comes with 5 different game modes that will challenge you in different ways.

THE GAME MENU

After putting on the headset and turning on the console (as described in the Quick Start section), the console will direct you to "Select game." The 5 sensor LEDs on the front of the console will begin to flash, indicating that you are in the Game Menu and need to make some choices.

Press the SELECT button (white) to cycle through a list of games then press ENTER (gray) to confirm your choice.

Note: Depending on the game you choose, you may also be prompted to select number of players and difficulty level, but we'll cover that in more detail under each game description.

CANCELLING YOUR CHOICES

FROM THE GAME MENU

To Cancel a Selection:

If you wish to cancel a choice you made while in the Game Menu, press the SELECT and ENTER buttons together and hold them down for 2 seconds. The console will cancel your choice and return you to the “Select Game” prompt.

FROM A GAME

To Cancel a Player’s Turn:

If a player does not wish to finish their turn, press and hold the ENTER button for 2 seconds. That player’s turn will be canceled and the game will advance to the next player.

To Cancel a Game:

If you wish to exit a game completely, press and hold both the SELECT and ENTER buttons for several seconds until the game returns you to the Game Menu and you hear “Select Game.”

Number of Players: 1

(Player does not need to select)

Difficulty Levels (Time Limit):

Not selectable (No time limit)

Object: Practice your concentration skills with no time limit.

FREESTYLE

1. Put on the headset and turn it on as described in the Quick Start section.
2. Turn on the console.
3. When the console says, “Select game,” press SELECT (white button) until you hear “Freestyle.” Press ENTER (gray button).
4. The console will beep and say, “Begin.” (If you experience connection problems, refer to the Troubleshooting section.)
5. While in “Freestyle” mode, the console will react to your concentration level. Practice controlling the ball or using different obstacles. You can also use “Freestyle” mode to make up your own games!
6. When you want to exit “Freestyle,” press the ENTER button to return to the Game Menu.

MENTAL MARATHON™

1. Set up the obstacle course as desired.
2. Place a ball on either of the two start spaces. Because the calibration point blocks the path, the space you choose determines the direction you must travel around the course. From the **right space** you will have to travel **counter-clockwise**, and from the **left space**, you will travel **clockwise**.
3. Turn on the console.
4. When the console says, “Select game,” press SELECT (white button) until you hear “Mental Marathon.” Press ENTER (gray button).
5. Press SELECT to choose the number of players (from 1 to 4) and press ENTER.
6. The console will tell the first player to “Put on the headset.” When the headset is in place and turned on (see Quick Start section), press SELECT.
7. Before the game will begin, the fan nozzle must be positioned underneath the calibration point – this is the “ready” position for the fan. If it is not there, the console will say, “Rotate fan to calibration point.” Turn the control knob to move the fan nozzle under the calibration point and leave it there. The unit will buzz to confirm that you are in position.

Number of Players: 1-4
Difficulty Levels (Time Limit):
Not selectable (No time limit)
Object: Travel around the obstacle course as quickly as you can. Beat your own best time or compete against other players – the fastest time wins!

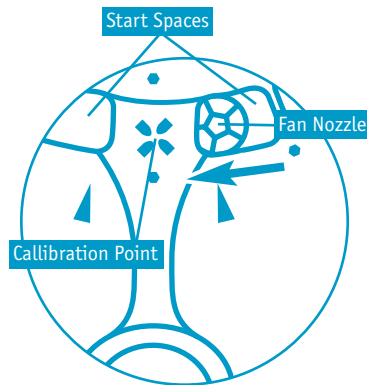

8. The console will say, "Begin."
9. Turn the control knob to maneuver the ball around the course.
10. When you pass each light on the console's surface, it will light up to mark your progress.
NOTE: Once you activate a light, you must continue to travel in that direction for the rest of the game.
11. You must activate all four lights in a row to successfully complete the game.
12. If the ball falls out of the airflow, place it back into play at the point where it fell off.
13. Race all the way around the course as quickly as you can. **When you return the fan to the calibration point, the game will announce your time.**
14. If you selected a multi-player game, the console will direct the next player to put on the headset. Once the next player is wearing the headset, press SELECT and the console will say, "Begin."
15. At the end of the game, the console will declare a winner based on the shortest time.

DANGER ZONE

1. Set up the obstacle course. **Do not** place obstacles over any lights.
2. Place a ball in either of the two start spaces.
3. Turn on the console.
4. When the console says, “Select game,” press SELECT (white button) until you hear “Danger Zone.” Press ENTER (gray button).
5. Press SELECT to choose the number of players (from 1 to 4) and press ENTER.
6. Press SELECT to choose the difficulty (Beginner, Intermediate or Advanced) and press ENTER. Easier difficulty settings will give you more time to escape each danger zone.
7. The console will tell the first player to “Put on the headset.” When the headset is in place and turned on (see Quick Start section), press SELECT.
8. Before the game will begin, the fan nozzle must be positioned underneath the calibration point – this is the “ready” position for the fan. If it is not there, the console will direct you to “Rotate fan to calibration point.” Move the fan nozzle under the calibration point and leave it there. The unit will buzz to confirm that you are in position.

Number of Players: 1-4
Difficulty Levels (Time Limit):
Beginner (1 minute/zone)
Intermediate (45 seconds/zone)
Advanced (20 seconds/zone)
Object: Escape 4 danger zones before time runs out or your game ends! Beat your best time or compete against other players – the shortest time wins!

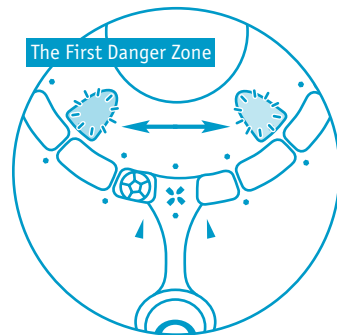

9. The console will say, “Begin.”
10. The two lights to either side of the calibration point will begin to blink. This is the first danger zone. You must maneuver the ball out of this zone before the lights go out or your game is over. Depending on the difficulty you selected, you will have different amounts of time to escape each zone (for instance, “Advanced” only gives you 20 seconds per zone).
11. When you escape a zone, the console will confirm by saying “Zone Complete.” Continue traveling in the same direction all the way around the course. You will **not** be able to escape a new zone by going back the way you came.
12. The first danger zone will continue to blink – even after you escape it – until the time for that zone runs out. At that point, the next consecutive zone will begin to blink. Just keep moving – try to stay ahead of the blinking zones if you can. You never want to be caught in one when it goes out.
13. If the ball falls out of the air flow, place it back into play at the point where it fell off.
14. When you escape the final danger zone, return the fan to its place beneath the calibration point and the console will announce your time.
15. If you selected a multi-player game, the console will direct the next player to put on the headset. Once the next player is wearing the headset, press SELECT and the console will say, “Begin.”
16. At the end of the game, the console will declare a winner based on the greatest number of zones escaped in the shortest amount of time.

CHASE THE LIGHTS

1. Set up the obstacle course as desired **but be sure to place the teeter-totter above the calibration point.** You will be moving back and forth a lot when playing “Chase the Lights,” and the teeter-totter is the only obstacle that allows you to travel in either direction over the calibration point (see pages 17-18).
2. Place a ball in the teeter-totter.
3. Turn on the console.
4. When the console says, “Select game,” press SELECT (white button) until you hear “Chase the Lights.” Press ENTER (gray button).
5. Press SELECT to choose the number of players (from 1 to 4) and press ENTER.
6. Press SELECT to choose the difficulty (Beginner, Intermediate or Advanced) and press ENTER. Easier difficulty settings will give you more time to play.
7. The console will tell the first player to “Put on the headset.” When the headset is in place and turned on (see Quick Start section), press SELECT.

Number of Players: 1-4
Difficulty Levels (Time Limit):

Beginner (5 minutes)

Intermediate (3 minutes)

Advanced (1 minute)

Object: “Tag” as many lights as you can before time runs out! Beat your best score or compete against other players – whoever tags the most lights wins!

8. Before the game will begin, the fan nozzle must be positioned underneath the calibration point – this is the “ready” position for the fan. If it is not there, the console will direct you to “Rotate fan to calibration point.” Move the fan nozzle under the calibration point and leave it there. The unit will buzz to confirm that you are in position.
9. The console will say, “Begin.”
10. One of the lights on the surface of the console will light up. As quickly as you can, maneuver the ball to that light to “tag” it.
11. Once tagged, the light will go out and another will light up. Choose the quickest route to tag the next light.
Remember: You can travel in **both** directions when playing Chase the Lights.
12. If the ball falls out of the airflow, place it back into play at the point where it fell off.
13. Continue tagging lights until time runs out and the console announces your score.
14. If you selected a multi-player game, the console will direct the next player to put on the headset. Once the next player is wearing the headset, press SELECT and the console will say, “Begin.”
15. At the end of a multi-player game, the console will declare a winner based on the total number of lights each player tagged in the shortest amount of time.

THOUGHTSHOT™

1. Set up the cannon and funnel obstacles directly across from each other. These are the only two obstacles you will need for this game.
2. Use the control knob to rotate the fan nozzle beside the cannon and place a ball on top of the nozzle.
3. Turn on the console.
4. When the console says, "Select game," press SELECT (white button) until you hear "Thoughtshot." Press ENTER (gray button).
5. Press SELECT to choose the number of players (from 1 to 4) and press ENTER.
6. Press SELECT to choose the difficulty (Beginner, Intermediate or Advanced) and press ENTER. Easier difficulty settings will give you more time to shoot baskets.
7. The console will tell the first player to "Put on the headset." When the headset is in place and turned on (see Quick Start section), press SELECT.

30

Number of Players: 1-4
Difficulty Levels (Time Limit):
Beginner (3 minutes)
Intermediate (2 minutes)
Advanced (1 minute)
Object: Score as many points as you can by blasting the ball into the funnel! Beat your best score or compete against other players – whoever gets the most points wins!

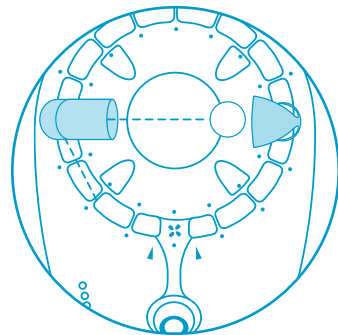

8. The console will say, “Begin.”
9. Concentrate to raise the ball into the cannon and shoot.
10. Whenever the ball lands in the funnel, press the SELECT button to add 1 point to your score.
11. After each shot, pick up the ball and place it next to the cannon to shoot again.
12. Play until your time runs out or until you score 20 points – the game automatically ends at 20. The console will announce your score.
13. If you selected a multi-player game, the console will direct the next player to put on the headset. Once the next player is wearing the headset, press SELECT and the console will say, “Begin.”
14. At the end of the game, the console will declare a winner based on the player with the highest score.

For a Greater Challenge

Add a few obstacles to the course. Instead of picking up the ball after each shot, use the fan to navigate the ball through the obstacles to get back to the cannon!

TROUBLESHOOTING

CONNECTION PROBLEMS

If you receive the message “Check headset sensors,” make the following adjustments. Be sure to wait about 5 seconds after each adjustment to see if the issue has been corrected – if so, you will hear “Calibrating headset.”

- Make sure the sensor is pressed tight and flat against your forehead. Adjust the headband if necessary.
- Make sure no hair is caught between the sensor and your skin.
- Move the forehead sensor to a slightly different position above your left eye.
- Remove then reattach the clips to your ears.
- Make sure both clips are pressed flat against your ear lobes.
- Leaving the headset on your head, turn the headset off and back on.
- Clean the surfaces of the forehead and ear clip sensors with a cloth or paper towel moistened in warm, soapy water.
- Visit www.mindflexgames.com for additional help.

NOTE: If you receive the message “Check headset sensors” during a game, the game timer will pause until you reestablish a good connection.

PROBLEMS CONTROLLING THE BALL

If you have difficulty controlling the ball – either raising or lowering it – try the following adjustments.

- Refer to the Concentration and Relaxation tips on pages 8 and 9.
- Turn off the headset. Place both feet flat on the floor, sit as still as you can and try to clear your mind. After 5 seconds, turn the headset back on.

NOTE: Don't be afraid to turn off the headset in the middle of a game. The game timer will pause until the console establishes a new connection with the headset.

- Visit www.mindflexgames.com for more tips and tutorials.

STATUS LIGHT REFERENCE CHART

During game play, the status light changes color and blinks to communicate the current status of the Mindflex™ system. Refer to the following chart for descriptions of the various status messages:

LIGHT	STATUS
Green	Good connection between console and headset
Blinking Green	Console batteries low. Fan may begin to lose power. Replace batteries soon.
Orange	"Calibrating headset." Headset attempting to read brainwaves.
Blinking Orange	"Check headset sensors." Headset positioned incorrectly. Verify proper placement of ear clips and forehead sensor.
Red	No headset signal. Possible causes: a) Headset turned off b) Headset batteries dead c) Headset out of range
Blinking Red	Headset batteries low. Replace soon.

COMPLIANCE WITH FCC REGULATIONS (VALID IN U.S. ONLY - VALABLE AUX É.-U. SEULEMENT)

This device complies with part 15 of the FCC Rules. Operation is subject to the following two conditions: (1) This device may not cause harmful interference, and (2) this device must accept any interference received, including interference that may cause undesired operation. NOTE: This equipment has been tested and found to comply with the limits for a Class B digital device, pursuant to Part 15 of the FCC Rules. These limits are designed to provide reasonable protection against harmful interference in a residential installation. This equipment generates, uses and can radiate radio frequency energy and, if not installed and used in accordance with the instructions, may cause harmful interference to radio communications. However, there is no guarantee that interference will not occur in a particular installation. If this equipment does cause harmful interference to radio or television reception, which can be determined by turning the equipment off and on, the user is encouraged to try to correct the interference by one or more of the following measures:

- Reorient or relocate the receiving antenna.
- Increase the separation between the equipment and receiver.
- Connect the equipment into an outlet on a circuit different from that to which the receiver is connected.
- Consult the dealer or an experienced radio/TV technician for help.

NOTE: Changes or modifications not expressly approved by the manufacturer responsible for compliance could void the user's authority to operate the equipment.

RSS - 210 (Canada)

(VALID FOR CANADA ONLY - VALABLE AU CANADA SEULEMENT)

This radiocommunication device complies with all the requirements of Industry Canada Standard RSS-210. Operation is subject to the following two conditions: (1) this device may not cause harmful interference and (2) this device must accept any interference, including interference that may cause undesired operation of the device. Ce dispositif de radiocommunication rencontre toutes les exigences de la norme CNR-210 d'Industrie Canada. L'utilisation de ce produit est sujette aux conditions suivantes : (1) il ne doit pas produire de brouillage et (2) il doit pouvoir tolérer tout brouillage radioélectrique reçu, même si ce brouillage est susceptible de compromettre son fonctionnement.

CNR-210 d'Industrie Canada (CANADA SEULEMENT)

2.4 GHz

BATTERY SAFETY INFORMATION

In exceptional circumstances batteries may leak fluids that can cause a chemical burn injury or ruin your product.

To avoid battery leakage:

- Non-rechargeable batteries are not to be recharged.
- Rechargeable batteries are to be removed from the product before being charged (if designed to be removable).
- Rechargeable batteries are only to be charged under adult supervision (if designed to be removable).
- Do not mix alkaline, standard (carbon-zinc), or rechargeable (nickel-cadmium) batteries.
- Do not mix old and new batteries.
- Only batteries of the same or equivalent type as recommended are to be used.
- Batteries are to be inserted with the correct polarity.
- Exhausted batteries are to be removed from the product.
- The supply terminals are not to be short-circuited.
- Dispose of battery(ies) safely.
- Do not dispose of this product in a fire. The batteries inside may explode or leak.



P2639-0920



INFORMACIÓN DE SEGURIDAD ACERCA DE LAS PILAS

En circunstancias excepcionales, las pilas pueden desprender líquido corrosivo que puede provocar quemaduras o dañar el producto. Para evitar el derrame de líquido corrosivo:

- No intentar cargar pilas no-recargables.
- Antes de recargar las pilas recargables, sacarlas del producto.
- Recargar las pilas recargables siempre bajo supervisión de un adulto.
- No mezclar pilas de diferentes tipos: alcalinas, estándar (carbono-zinc) y recargables (níquel-cadmio).
- No mezclar pilas nuevas con gastadas.
- Utilizar pilas del tipo recomendado en las instrucciones o equivalente.
- Colocar las pilas según la polaridad indicada.
- Retirar las pilas gastadas del producto.
- Evitar cortocircuitos en los polos de las pilas.
- Desechar las pilas gastadas en un contenedor especial para pilas.
- No quemar el producto, ya que las pilas de su interior podrían explotar o desprender líquido corrosivo.

MISES EN GARDE AU SUJET DES PILES

Lors de circonstances exceptionnelles, des substances liquides peuvent s'écouler des piles et provoquer des brûlures chimiques ou endommager le produit. Pour éviter tout écoulement des piles :

- Ne pas recharger des piles non rechargeables.
- Les piles rechargeables doivent être retirées du produit avant d'être rechargées (en cas de piles amovibles).
- En cas d'utilisation de piles rechargeables, celles-ci ne doivent être chargées que par un adulte (en cas de piles amovibles).
- Ne pas mélanger des piles alcalines, standard (carbone-zinc) ou rechargeables (nickel-cadmium).
- Ne jamais mélanger des piles usées avec des piles neuves.
- N'utiliser que des piles du même type que celles recommandées, ou des piles équivalentes.
- Veiller à bien respecter le sens des polarités (+) et (-), et toujours suivre les indications des fabricants du jouet et des piles.
- Toujours retirer les piles usées du produit.
- Ne pas court-circuiter les bornes des piles.
- Jeter les piles usées dans un conteneur réservé à cet usage.
- Ne pas jeter le produit au feu. Les piles incluses pourraient exploser ou couler.

Protect the environment by not disposing of this product with household waste [2002/96/EC]. Check your local authority for recycling advice and facilities. • No tirar este producto en la basura doméstica [2002/96/EC]. Para más información sobre la eliminación correcta de residuos de equipos eléctricos y electrónicos, póngase en contacto con la Junta de Residuos o el Ayuntamiento de su localidad.

• Protéger l'environnement en ne jetant pas ce produit dans les ordures ménagères [2002/96/EC]. Consulter votre municipalité pour obtenir des conseils sur le recyclage et connaître les centres de dépôt de votre région.



© 2009 Mattel, Inc. All Rights Reserved. Mattel, Inc. 636 Girard Avenue, East Aurora, NY 14052, U.S.A. www.radicagames.com Helpline 1.800.803.9611 or service.mattel.com. Mattel U.K. Ltd., Vanwall Business Park, Maidenhead SL6 4UB, Helpline 01628 500303. Mattel Canada Inc., Mississauga, Ontario L5R 3W2. You may call us free at/ Composez sans frais le 1-800-524-8697. Mattel Australia Pty., Ltd., Richmond, Victoria. 3121. Consumer Advisory Service - 1300 135 312. Mattel East Asia Ltd., Room 1106, South Tower, World Finance Centre, Harbour City, Tsimshatsui, HK, China. Diimport & Diedarkan Oleh: Mattel SEA Ptd Ltd.(993532-P) Lot 13.5, Menara Lien Hoe, Persiaran Tropicana Golf Country Resort, 47410 PJ. Tel:03-78803817, Fax:03-78803867.

Sírvanse guardar esta información para futura referencia. Mattel España, S.A., Aribau 200. 08036 Barcelona. Recomendamos que anote este endereço para futura referencia: Mattel Portugal Lda., Av. da República, nº 90/96, 2º andar Fracção 2, 1600-206 Lisboa. **HECHO EN CHINA. Importado y distribuido por** Mattel de México, S.A. de C.V., Insurgentes Sur # 3579, Torre 3, Oficina 601, Col. Tlalpan, Delegación Tlalpan, C.P. 14020, México, D.F. R.F.C. MME-920701-NB3. Mattel Chile, S.A., Avenida Américo Vespucio 501-B, Quilicura, Santiago. Mattel de Venezuela, C.A., RIF J301596439, Ave. Mara, C.C. Macaracuy Plaza, Torre B, Piso 8, Colinas de la California, Caracas 1071. Mattel Argentina S.A., Curupaipi 1186, (1607) - Villa Adelina, Buenos Aires. Mattel Colombia, S.A., calle 12347-07 P.5, Bogotá. Marcas registradas utilizadas bajo licencia. Todos los derechos reservados.