



7.2V R/C

CAUTION-ELECTRIC TOY-NOT RECOMMENDED FOR CHILDREN UNDER 8 YEARS OF AGE. AS WITH ALL ELECTRIC PRODUCTS, PRECAUTIONS SHOULD BE OBSERVED DURING HANDLING AND USE TO PREVENT ELECTRIC SHOCK. INPUT: 120VAC, 60Hz, 12VA. OUTPUT: 8.5VDC, 420mA, 3.6V.

G3474-0920
G3474-S1

TYCO® R/C SUPPORT

**Questions or problems with your product?
DON'T RETURN IT TO THE STORE!
Just call us for help.**

U.S. consumers may also register their products at this number.
1 888 557-TYCO (8926)

tycorc.com

Keep these instructions for future reference: they contain important information. IMPORTANT: Please read all "Consumer Information" before operating your vehicle.

CAUTION: Surfaces may become hot and cause burns if electronics get wet. Do not operate vehicle through water or snow.

I. CONTENTS/FEATURES

- Vehicle
- Transmitter
- 7.2v Battery pack
- 7.2v wall charger
- 6AA Batteries

Vehicle

1 Steering adjuster control

For when your vehicle appears to veer to either the right or left, use screwdriver (not included) to turn the knob in the direction necessary to correct the vehicle's alignment.

2 Try-Me button to activate lights and sounds

- 3 4AA battery door
- 4 7.2v battery latch
- 5 7.2v battery door

6 ON/Fender lights/OFF/Try-Me (lights and music) switch

This switch has 4 positions:

- I Vehicle On: Vehicle runs with music effects and lights as you drive (In this mode vehicle will perform at low speed)
- Light Fender lights "on" only (Vehicle no movement forward)
- 0 Vehicle OFF
- Light/Music Try-Me On: Activates 'try me' function with lights and music effects (In this mode vehicle cannot be driven)

7 Media player music(MP3/CD's)/OFF/Cruise music switch

This switch has 3 positions:

- Music Vehicle runs with internally stored music (In this mode vehicle will perform at low speed)
- 0 Vehicle runs with no music (In this mode vehicle will perform at maximum speed)
- Headphones Vehicle runs with your MP3 or CD music player (In this mode vehicle will perform at low speed)

Note: Both the switches turn to "0" position after run your vehicle or your MP3/CD music end.

- 8 Fender lights
- 9 Trunk lock-use coin (not included) to open trunk after trunk lock
- 10 Media player plug (for direct input into most media players)

Media player should first be placed into the the protective sleeve and then plugged in. (The music player is not included)

Adjust the volume of the music using the volume control on your music player.

11 Protective media player sleeve

Transmitter

- 1 Antenna
- 2 Left & Right controls
- 3 Forward & Reverse controls
- 4 Battery door

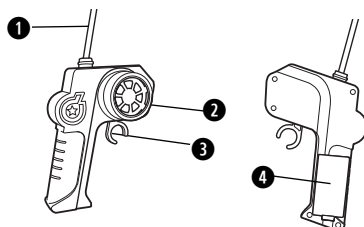
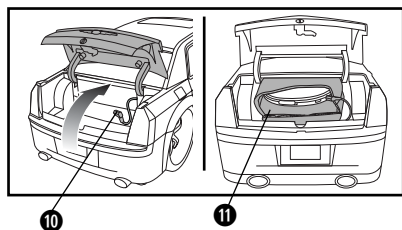
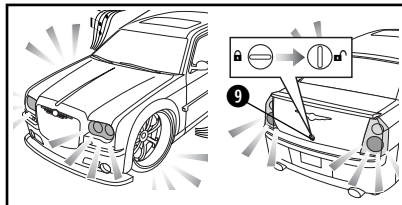
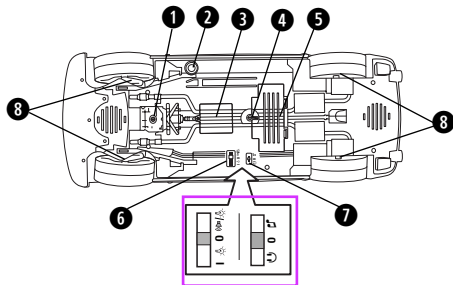

II. VEHICLE OPERATION

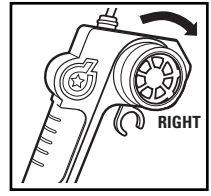
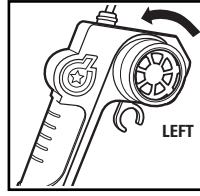
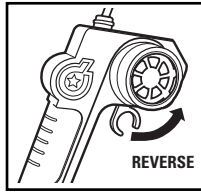
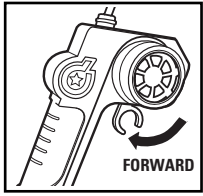

Slam steering control: Left & Right turn activation turning motion activates turn signal lights.

Throttle control: Forward & Reverse motion activation

Forward & Reverse motion activates headlights & fender lights

Forward & Reverse motion activates cruise tune (from internally stored music). Vehicle drives in low speed when a music player is plugged in.

Brake lights activate when the trigger switch returns to the neutral position.

III. BATTERY INSTALLATION

There are two power sources: a 7.2v SubC NiCd rechargeable battery pack (which powers all the driving and turning) and a 4 AA alkaline battery pack (which powers the lights and sounds).

For detailed information regarding rechargeable battery charging and safety, please refer to the "Battery Charging/Care" section.

Vehicle

For lights and music sounds position battery installation:

1. Use a screwdriver (not included) to unscrew the power clip cover screw, open the battery cover as shown.
2. Install 4 AA alkaline batteries with polarity (+/-) as shown inside the battery compartment.
3. Replace the battery door.

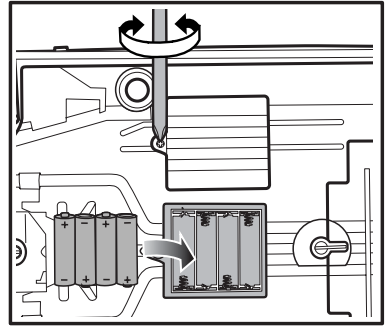

For driving battery installation:

1. Rotate the battery door latch to the unlocked position and open the battery door.
2. Insert the charged battery pack into the battery compartment as shown.
3. Connect the battery pack's wire connector to the vehicle's charging jack as shown. Make certain the connector is securely connected.
4. Close the battery door and rotate the battery door latch to the locked position.

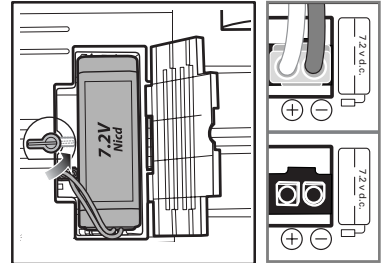

Transmitter

1. Remove the battery cover as shown.
2. Install 2 AA alkaline batteries with polarity (+/-) as shown inside the battery compartment.
3. Replace the battery door.

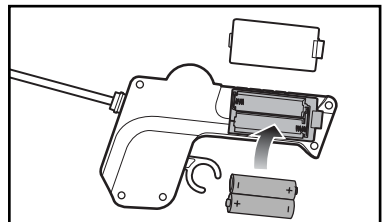

V. BATTERY CHARGING/CARE

CAUTION: Use only the charger supplied with this toy. Do not use any other charging source.

Use only Tyco® R/C 7.2v NiCd battery packs. Other batteries may leak or rupture, causing personal injury and damage.

1. Plug the wall pack charger into a standard wall outlet.
2. Connect the battery pack's wire connector to the wall pack charger connector. Make certain the two connectors are tightly snapped together.
3. To disconnect the wires, push down on the connector clip and pull apart.
4. After charging, the battery will feel warm. This condition is normal for fully charged batteries.
5. New battery packs must be charged for 5 1/2 hours the first two times charged. Subsequent charges will require 4 hours. Charging the battery pack for more than 5 1/2 hours will not give you a longer running time. 5 1/2 hours is all that is required for a fully charged battery pack.
6. Unlike alkaline batteries, which lose power gradually, a NiCd (Nickel-Cadmium) battery will run for its normal running time and then lose most of its power at once. That's how you'll know it's time to recharge the battery pack.
7. After use, the battery pack will be hot! Wait at least 20 minutes until the battery pack cools before recharging. Recharging a warm or hot battery pack will greatly reduce the number of times your battery pack can be recharged.

RECHARGEABLE BATTERY INFORMATION:

- ✗ DO NOT RECHARGE BATTERY PACK IF IT'S HOT. ALLOW IT TO COOL BEFORE RECHARGING.
- ✗ DO NOT RECHARGE A BATTERY PACK THAT SHOWS LEAKAGE OR CORROSION.
- ✗ DO NOT DISASSEMBLE THE BATTERY PACK. THE BATTERY PACK IS A SEALED RECHARGEABLE NICKEL-CADMIUM BATTERY.
- ✗ EXERCISE CAUTION IN HANDLING A HOT BATTERY PACK.
- ✗ IF BATTERY PACK AND/OR CHARGER ARE WET, THOROUGHLY DRY BEFORE CHARGING.
- ✗ DO NOT RECHARGE NON-RECHARGEABLE BATTERIES.

Note to Adults:

- Remove rechargeable batteries before recharging. Recharge batteries only under adult supervision.
- Regularly examine for damage to the cord, plug, enclosure and other parts.
- In the event of any damage, the toy must not be used with the battery charger until the damage has been repaired.
- This toy is not intended for children under 3 years old. The battery charger is not a toy.

THIS PRODUCT USES A NICKEL-CADMIUM RECHARGEABLE BATTERY PACK. BATTERY MUST BE RECYCLED OR DISPOSED OF PROPERLY. FOR FURTHER INFORMATION REGARDING BATTERIES OR THEIR DISPOSAL PLEASE CALL 1-800-348-075.

VI. CONSUMER INFORMATION:

QUICK TIPS

- 1 When the 4AA batteries in the vehicle are running low the sound effects and motor will cut off. You'll then hear a 10-second beep. Turn the vehicle OFF before changing new AA batteries and 7.2V battery pack. When the 7.2v SubC NiCd is low or encounters a stall, the unit will cut the motors and turn off the sound effects. The unit will beep as long as the user continues to press the remote control.
- 2 Your vehicle's running time may change depending on your driving style.
- 3 Radio interference can make your vehicle run badly. Interference can be caused by other R/C vehicles running on the same frequency; electrical wires; large buildings; CB radios; or other wireless gear. Try to stay away from these!
- 4 Point your transmitter antenna up - not down toward your vehicle. If your vehicle gets too far away, it won't work properly.
- 5 Don't drive your vehicle in sand or through water or snow. If your vehicle does get wet, wipe with a towel and allow it to dry completely.
- 6 Don't store your vehicle near heat or in direct sunlight. Always turn switches OFF and remove all batteries for storage.

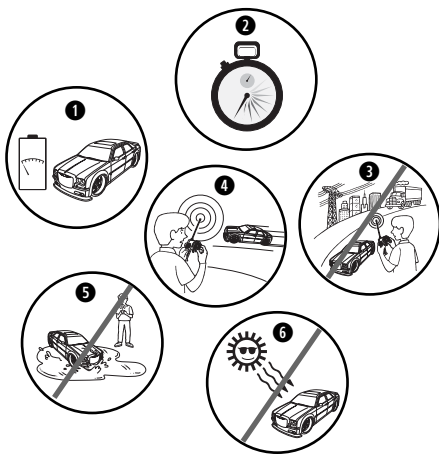

7.2v d.c. NiCd,
6 x Sub-C
1600mAh

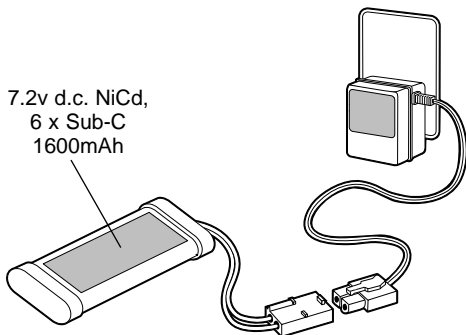

Note to Adults: To ensure that the child's play is both safe and fun, please review all the operating instructions and safety rules with your child.

Safety Tips

- NEVER drive your vehicle on streets! They're for real cars!
- DO NOT pick up the vehicle while it's in motion.
- Keep fingers, hair and loose clothing away from the tires and the wheel hubs while the vehicle is switched ON.

 **CAUTION:** To prevent entanglement, keep hair away from wheels.

- Adult supervision is recommended when this vehicle is being operated.
- To avoid accidental operation, remove all batteries when not in use. Always turn all switches OFF before removing batteries.

BATTERY SAFETY INFORMATION

In exceptional circumstances batteries may leak fluids that can cause a chemical burn injury or ruin your product.

To avoid battery leakage:

- Non-rechargeable batteries are not to be recharged.
- Rechargeable batteries are to be removed from the product before being charged (if designed to be removable).

- Rechargeable batteries are only to be charged under adult supervision (if designed to be removable).
- Do not mix alkaline, standard (carbon-zinc), or rechargeable (nickel-cadmium) batteries.
- Do not mix old and new batteries.
- Only batteries of the same or equivalent type as recommended are to be used.
- Batteries are to be inserted with the correct polarity.
- Exhausted batteries are to be removed from the product.
- The supply terminals are not to be short-circuited.
- Dispose of battery(ies) safely.
- Do not dispose of this product in a fire. The batteries inside may explode or leak.

Battery Performance Note:

For best performance use regular or high-performance alkaline batteries (where disposable batteries are called for). If your vehicle is supplied with standard (carbon-zinc) batteries for initial use and/or demonstration purposes, we recommend replacing them with alkaline batteries when necessary. Battery life may vary depending on battery brand.

TROUBLESHOOTING - PROBLEM? - SOLUTIONS

SYMPTOM

• PROBABLE CAUSE

• CORRECTION

Vehicle runs slowly or will not run.

- Loose battery connection or vehicle switch not ON.
- Weak or uncharged rechargeable NiCd battery.
- Weak AA batteries (Power Clip) or transmitter battery.

- Check battery connector and vehicle switch.
- Charge battery or replace.
- Replace with fresh alkaline battery.

Power indicator light on transmitter does not light.

- Transmitter battery weak or not connected.

- Check connections and replace battery if required.

Erratic operation or only short range possible.

- Radio interference likely.

- Change location - see Point 3, "Quick Tips."

Vehicle doesn't work after going through water or snow.

- Water in the electronics area.

- Vehicle will take several hours to dry. Allow to dry thoroughly overnight before trying again. Avoid driving in water or snow.

90 DAY LIMITED WARRANTY – TYCO® R/C PRODUCTS

Mattel, Inc. warrants to the original consumer purchaser that this product will be free of defects in material and workmanship for ninety (90) days (unless specified in alternate warranties) from the date of purchase. Mattel will replace the product in the event of such a defect within the warranty period.

In the event of a defect covered under this warranty, first call the toll-free number listed below. Many problems can be solved in this manner. If necessary, you will be instructed to return the product, postage prepaid and insured, to the address below. Enclose your name, address, dated sales receipt, and a brief explanation of the defect. Replacement and return shipment will be free of charge.

This warranty does not cover damage resulting from unauthorized modification, accident, misuse or abuse. If the product is returned without a dated sales receipt the product may be excluded from coverage under this warranty.

Mattel's liability for defects in material and workmanship under this warranty shall be limited to repair or replacement, at our sole option, and in no event shall we be responsible for incidental, consequential, or contingent damages (except in those states that do not allow this exclusion or limitation). This warranty is exclusive, and is made in lieu of any express or implied warranty. **Valid only in U.S.A.** This warranty gives you specific legal rights and you may have other rights, which vary from state to state. Some states do not allow the exclusion of incidental or consequential damages, so the above exclusions or limitations may not apply to you.

TOLL-FREE NUMBER: 1-888-557-TYCO (8926) (**valid only in U.S.A.**)
Hours: 8:00 A.M. - 5:00 P.M. Eastern Time; Monday - Friday. Expect some delay in January following the holiday season. Please be patient and keep trying the toll-free number.

ADDRESS FOR RETURNS:
CONSUMER RELATIONS
636 GIRARD AVENUE
EAST AURORA, NY 14052

© 2005 Mattel, Inc., 333 Continental Blvd., El Segundo, CA 90245 U.S.A. Consumer Affairs: 1 (800) 524-TOYS.
PRINTED IN CHINA. All Rights Reserved. MATTEL, TYCO and associated trademarks and trade dress are owned by Mattel, Inc. Retain this address for future reference: Mattel U.K. Ltd., Vanwall Business Park, Maidenhead SL6 4UB, Helpline: 01628 500303, Mattel Australia Pty Ltd., Richmond, Victoria 3121 - Consumer Advisory Service: 1300 135 312. Mattel East Asia Ltd, Room 1106, South Tower, World Finance Centre, Harbour City, Tsimshatsui, HK, China. Dimport & Diedarkan Olet: Mattel SEA Ptd Ltd. (993532-P) Lot 13.5, Menara Lien Hoe, Persiaran Tropicana Golf Country Resort, 47410 P.J. Tel: 03-78803817, Fax: 03-78803867.

COMPLIANCE WITH FCC REGULATIONS (VALID IN U.S. ONLY)

This device complies with part 15 of the FCC Rules. Operation is subject to the following two conditions: (1) This device may not cause harmful interference, and (2) this device must accept any interference received, including interference that may cause undesired operation. This device generates and uses radio frequency energy and if not used properly may cause interference to radio and television reception. It has been tested and found to comply with the limits set by the FCC which are designed to provide reasonable protection against such interference.

NOTE: Changes or modifications not expressly approved by the manufacturer responsible for compliance could void the user's authority to operate the equipment.