



No. 1 Workshop, M-10, Middle section, Science & Technology Park,

Shenzhen, Guangdong, China 518057

Telephone: +86 (0) 755 2601 2053

Fax: +86 (0) 755 2671 0594

Email: ee.shenzhen@sgs.com

Report No.: SZEM161201133801

Page: 1 of 42

FCC REPORT

Application No: SZEM1612011338CR
Applicant: Mattel Asia Pacific Sourcing Ltd
Manufacturer: Wynnewood Toys Industrial
Factory: Wynnewood Toys Industrial
Product Name: SmartCycle
Model No.(EUT): DRP30
FCC ID: PIYDRP30-17
Standards: 47 CFR Part 15, Subpart C (2015)
Date of Receipt: 2017-01-03
Date of Test: 2017-01-12 to 2017-01-16
Date of Issue: 2017-01-17

Test Result:	PASS *
---------------------	---------------

* In the configuration tested, the EUT complied with the standards specified above.

Authorized Signature:



Jack Zhang
EMC Laboratory Manager

The manufacturer should ensure that all products in series production are in conformity with the product sample detailed in this report. If the product in this report is used in any configuration other than that detailed in the report, the manufacturer must ensure the new system complies with all relevant standards. Any mention of SGS International Electrical Approvals or testing done by SGS International Electrical Approvals in connection with, distribution or use of the product described in this report must be approved by SGS International Electrical Approvals in writing.

The report must not be used by the client to claim product certification, approval, or endorsement by NVLAP, NIST, or any agency of the federal government. All test results in this report can be traceable to National or International Standards.

This document is issued by the Company subject to its General Conditions of Service printed overleaf, available on request or accessible at <http://www.sgs.com/en/Terms-and-Conditions.aspx> and, for electronic format documents, subject to Terms and Conditions for Electronic Documents at <http://www.sgs.com/en/Terms-and-Conditions/Terms-e-Documents.aspx>. Attention is drawn to the limitation of liability, indemnification and jurisdiction issues defined therein. Any holder of this document is advised that information contained hereon reflects the Company's findings at the time of its intervention only and within the limits of Client's instructions, if any. The Company's sole responsibility is to its Client and this document does not exonerate parties to a transaction from exercising all their rights and obligations under the transaction documents. This document cannot be reproduced except in full, without prior written approval of the Company. Any unauthorized alteration, forgery or falsification of the content or appearance of this document is unlawful and offenders may be prosecuted to the fullest extent of the law. Unless otherwise stated the results shown in this test report refer only to the sample(s) tested and such sample(s) are retained for 30 days only.



2 Version

Revision Record				
Version	Chapter	Date	Modifier	Remark
00		2017-01-17		Original

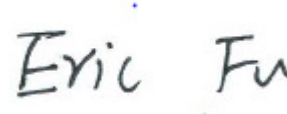
Authorized for issue by:				
Tested By				2017-01-16
				Date
Checked By				2017-01-17
				Date
		Peter Geng /Project Engineer		
		Eric Fu /Reviewer		



3 Test Summary

Test Item	Test Requirement	Test method	Result
Antenna Requirement	47 CFR Part 15, Subpart C Section 15.203/15.247 (c)	ANSI C63.10 2013	PASS
AC Power Line Conducted Emission	47 CFR Part 15, Subpart C Section 15.207	ANSI C63.10 2013	n/a
Conducted Peak Output Power	47 CFR Part 15, Subpart C Section 15.247 (b)(3)	ANSI C63.10 2013	PASS
6dB Occupied Bandwidth	47 CFR Part 15, Subpart C Section 15.247 (a)(2)	ANSI C63.10 2013	PASS
Power Spectral Density	47 CFR Part 15, Subpart C Section 15.247 (e)	ANSI C63.10 2013	PASS
Band-edge for RF Conducted Emissions	47 CFR Part 15, Subpart C Section 15.247(d)	ANSI C63.10 2013	PASS
RF Conducted Spurious Emissions	47 CFR Part 15, Subpart C Section 15.247(d)	ANSI C63.10 2013	PASS
Radiated Spurious Emissions	47 CFR Part 15, Subpart C Section 15.205/15.209	ANSI C63.10 2013	PASS
Restricted bands around fundamental frequency (Radiated Emission)	47 CFR Part 15, Subpart C Section 15.205/15.209	ANSI C63.10 2013	PASS



4 Contents

	Page
.....	1
2 VERSION	2
3 TEST SUMMARY	3
4 CONTENTS	4
5 GENERAL INFORMATION	5
5.1 CLIENT INFORMATION	5
5.2 GENERAL DESCRIPTION OF EUT	5
5.3 TEST ENVIRONMENT	7
5.4 DESCRIPTION OF SUPPORT UNITS	7
5.5 TEST LOCATION	7
5.6 TEST FACILITY	8
5.7 DEVIATION FROM STANDARDS	8
5.8 ABNORMALITIES FROM STANDARD CONDITIONS	8
5.9 OTHER INFORMATION REQUESTED BY THE CUSTOMER	8
5.10 EQUIPMENT LIST	9
6 TEST RESULTS AND MEASUREMENT DATA	11
6.1 ANTENNA REQUIREMENT	11
6.2 CONDUCTED PEAK OUTPUT POWER	12
6.3 6dB OCCUPY BANDWIDTH	15
6.4 POWER SPECTRAL DENSITY	18
6.5 BAND-EDGE FOR RF CONDUCTED EMISSIONS	21
6.6 SPURIOUS RF CONDUCTED EMISSIONS	23
6.7 RADIATED SPURIOUS EMISSION	29
6.7.1 <i>Spurious Emissions</i>	29
6.8 RESTRICTED BANDS AROUND FUNDAMENTAL FREQUENCY	36
7 PHOTOGRAPHS - EUT TEST SETUP	42
7.1 RADIATED EMISSION	42
7.2 RADIATED SPURIOUS EMISSION	42
8 PHOTOGRAPHS - EUT CONSTRUCTIONAL DETAILS	42



5 General Information

5.1 Client Information

Applicant:	Mattel Asia Pacific Sourcing Ltd
Address of Applicant:	13/F., South Tower, World Finance Centre, Harbour City, Tsimshatsui, Kowloon, Hong Kong
Manufacturer:	Wynnewood Toys Industrial
Address of Manufacturer:	1310 Guan Guang Rd, Guanlan Baoan, Shenzhen, China
Factory:	Wynnewood Toys Industrial
Address of Factory:	1310 Guan Guang Rd, Guanlan Baoan, Shenzhen, China

5.2 General Description of EUT

Product Name:	SmartCycle
Model No.:	DRP30
Operation Frequency:	2402MHz~2480MHz
Bluetooth Version:	V4.0 BLE
Modulation Type:	GFSK
Number of Channel:	40
Antenna Type:	Monopole
Antenna Gain:	0dBi
Power Supply:	6V DC by 4 x 1.5V "AA" batteries



Operation Frequency each of channel							
Channel	Frequency	Channel	Frequency	Channel	Frequency	Channel	Frequency
0	2402MHz	10	2422MHz	20	2442MHz	30	2462MHz
1	2404MHz	11	2424MHz	21	2444MHz	31	2464MHz
2	2406MHz	12	2426MHz	22	2446MHz	32	2466MHz
3	2408MHz	13	2428MHz	23	2448MHz	33	2468MHz
4	2410MHz	14	2430MHz	24	2450MHz	34	2470MHz
5	2412MHz	15	2432MHz	25	2452MHz	35	2472MHz
6	2414MHz	16	2434MHz	26	2454MHz	36	2474MHz
7	2416MHz	17	2436MHz	27	2456MHz	37	2476MHz
8	2418MHz	18	2438MHz	28	2458MHz	38	2478MHz
9	2420MHz	19	2440MHz	29	2460MHz	39	2480MHz

Note:

In section 15.31(m), regards to the operating frequency range over 10 MHz, the lowest frequency, the middle frequency, and the highest frequency of channel were selected to perform the test, and the selected channel see below:

Channel	Frequency
The lowest channel (CH0)	2402MHz
The middle channel (CH19)	2440MHz
The highest channel (CH39)	2480MHz



5.3 Test Environment

Operating Environment:	
Temperature:	25.0 °C
Humidity:	55 % RH
Atmospheric Pressure:	1015mbar

5.4 Description of Support Units

The EUT has been tested independent unit.

5.5 Test Location

All tests were performed at:

SGS-CSTC Standards Technical Services Co., Ltd., Shenzhen Branch

No. 1 Workshop, M-10, Middle Section, Science & Technology Park, Shenzhen, Guangdong, China.
518057.

Tel: +86 755 2601 2053 Fax: +86 755 2671 0594

No tests were sub-contracted.



5.6 Test Facility

The test facility is recognized, certified, or accredited by the following organizations:

- **CNAS (No. CNAS L2929)**

CNAS has accredited SGS-CSTC Standards Technical Services Co., Ltd. Shenzhen Branch EMC Lab to ISO/IEC 17025:2005 General Requirements for the Competence of Testing and Calibration Laboratories (CNAS-CL01 Accreditation Criteria for the Competence of Testing and Calibration Laboratories) for the competence in the field of testing.

- **A2LA (Certificate No. 3816.01)**

SGS-CSTC Standards Technical Services Co., Ltd., Shenzhen EMC Laboratory is accredited by the American Association for Laboratory Accreditation(A2LA). Certificate No. 3816.01.

- **VCCI**

The 10m Semi-anechoic chamber and Shielded Room of SGS-CSTC Standards Technical Services Co., Ltd. have been registered in accordance with the Regulations for Voluntary Control Measures with Registration No.: G-823, R-4188, T-1153 and C-2383 respectively.

- **FCC – Registration No.: 556682**

SGS-CSTC Standards Technical Services Co., Ltd., Shenzhen EMC Laboratory has been registered and fully described in a report filed with the (FCC) Federal Communications Commission. The acceptance letter from the FCC is maintained in our files. Registration No.: 556682.

- **Industry Canada (IC)**

Two 3m Semi-anechoic chambers and the 10m Semi-anechoic chamber of SGS-CSTC Standards Technical Services Co., Ltd. Shenzhen Branch EMC Lab have been registered by Certification and Engineering Bureau of Industry Canada for radio equipment testing with Registration No.: 4620C-1, 4620C-2, 4620C-3.

5.7 Deviation from Standards

None.

5.8 Abnormalities from Standard Conditions

None.

5.9 Other Information Requested by the Customer

None.



5.10 Equipment List

RF connected test						
Item	Test Equipment	Manufacturer	Model No.	Inventory No.	Cal. Date (yyyy-mm-dd)	Cal. Due date (yyyy-mm-dd)
1	DC Power Supply	ZhaoXin	RXN-305D	SEM011-02	2016-10-09	2017-10-09
2	Spectrum Analyzer	Rohde & Schwarz	FSP	SEM004-06	2016-10-09	2017-10-09
3	Signal Generator	Rohde & Schwarz	SML03	SEM006-02	2016-04-25	2017-04-25
4	Power Meter	Rohde & Schwarz	NRVS	SEM014-02	2016-10-09	2017-10-09

RE in Chamber						
Item	Test Equipment	Manufacturer	Model No.	Inventory No.	Cal. Date (yyyy-mm-dd)	Cal. Due date (yyyy-mm-dd)
1	3m Semi-Anechoic Chamber	ETS-LINDGREN	N/A	SEM001-01	2016-05-13	2017-05-13
2	EMI Test Receiver	Agilent Technologies	N9038A	SEM004-05	2016-10-09	2017-10-09
3	BiConiLog Antenna (26-3000MHz)	ETS-LINDGREN	3142C	SEM003-01	2014-11-01	2017-11-01
4	Double-ridged horn (1-18GHz)	ETS-LINDGREN	3117	SEM003-11	2015-10-17	2018-10-17
5	Horn Antenna (18-26GHz)	ETS-LINDGREN	3160	SEM003-12	2014-11-24	2017-11-24
6	Pre-amplifier (0.1-1300MHz)	Agilent Technologies	8447D	SEM005-01	2016-04-25	2017-04-25
7	Band filter	Amindeon	Asi 3314	SEM023-01	N/A	N/A
8	DC Power Supply	Zhao Xin	RXN-305D	SEM011-02	2016-10-09	2017-10-09
9	Loop Antenna	Beijing Daze	ZN30401	SEM003-09	2015-05-13	2018-05-13



RE in Chamber						
Item	Test Equipment	Manufacturer	Model No.	Inventory No.	Cal. Date (yyyy-mm-dd)	Cal. Due date (yyyy-mm-dd)
1	3m Semi-Anechoic Chamber	AUDIX	N/A	SEM001-02	2016-05-13	2017-05-13
2	EXA Spectrum Analyzer	Agilent Technologies Inc	N9010A	SEM004-09	2016-07-19	2017-07-19
3	BiConiLog Antenna (26-3000MHz)	ETS-Lindgren	3142C	SEM003-02	2014-11-15	2017-11-15
4	Amplifier (0.1-1300MHz)	HP	8447D	SEM005-02	2016-10-09	2017-10-09
5	Horn Antenna (1-18GHz)	Rohde & Schwarz	HF907	SEM003-07	2015-06-14	2018-06-14
6	Horn Antenna (18-26GHz)	ETS-Lindgren	3160	SEM003-12	2014-11-24	2017-11-24
7	Horn Antenna(26GHz-40GHz)	A.H.Systems, inc.	SAS-573	SEM003-13	2015-02-12	2018-02-12
8	Low Noise Amplifier	Black Diamond Series	BDLNA-0118-352810	SEM005-05	2016-10-09	2017-10-09
9	Band filter	Amindeon	Asi 3314	SEM023-01	N/A	N/A

6 Test results and Measurement Data

6.1 Antenna Requirement

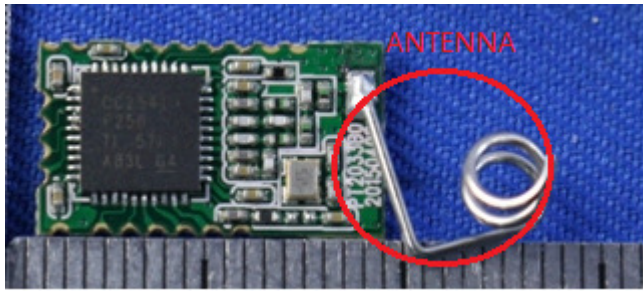
Standard requirement:	47 CFR Part 15C Section 15.203 /247(c)
<p>15.203 requirement: An intentional radiator shall be designed to ensure that no antenna other than that furnished by the responsible party shall be used with the device. The use of a permanently attached antenna or of an antenna that uses a unique coupling to the intentional radiator, the manufacturer may design the unit so that a broken antenna can be replaced by the user, but the use of a standard antenna jack or electrical connector is prohibited.</p> <p>15.247(b) (4) requirement: The conducted output power limit specified in paragraph (b) of this section is based on the use of antennas with directional gains that do not exceed 6 dBi. Except as shown in paragraph (c) of this section, if transmitting antennas of directional gain greater than 6 dBi are used, the conducted output power from the intentional radiator shall be reduced below the stated values in paragraphs (b)(1), (b)(2), and (b)(3) of this section, as appropriate, by the amount in dB that the directional gain of the antenna exceeds 6 dBi.</p>	
EUT Antenna:	
<p>The antenna is integrated on the main PCB and no consideration of replacement. The best case gain of the antenna is 0dBi.</p>	

6.2 Conducted Peak Output Power

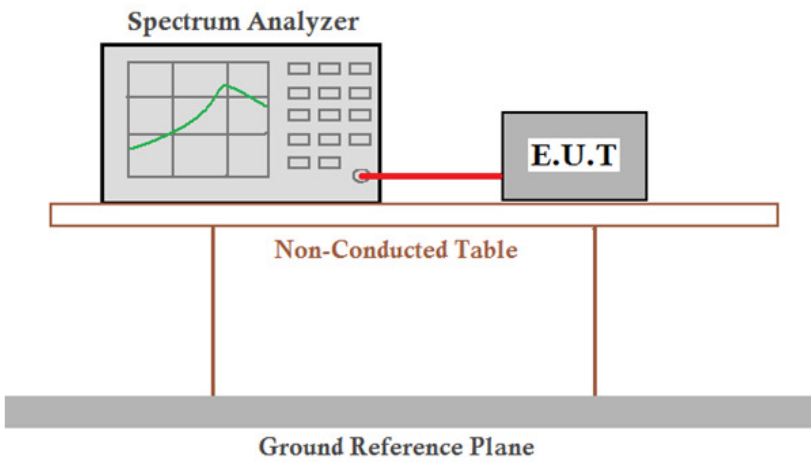
Test Requirement:	47 CFR Part 15C Section 15.247 (b)(1)
Test Method:	ANSI C63.10 :2013 Section 11.9.1
Test Setup:	 <p><i>Remark:</i> Offset the High-Frequency cable loss 1.5dB in the spectrum analyzer.</p>
Limit:	30dBm
Test Mode:	Transmitting with GFSK modulation.
Instruments Used:	Refer to section 5.10 for details.
Test Results:	Pass

Measurement Data

GFSK mode			
Test channel	Peak Output Power (dBm)	Limit (dBm)	Result
Lowest	-4.41	30.00	Pass
Middle	-5.89	30.00	Pass
Highest	-7.38	30.00	Pass



Test plot as follows:

Test mode:	GFSK	Test channel:	Lowest
------------	------	---------------	--------

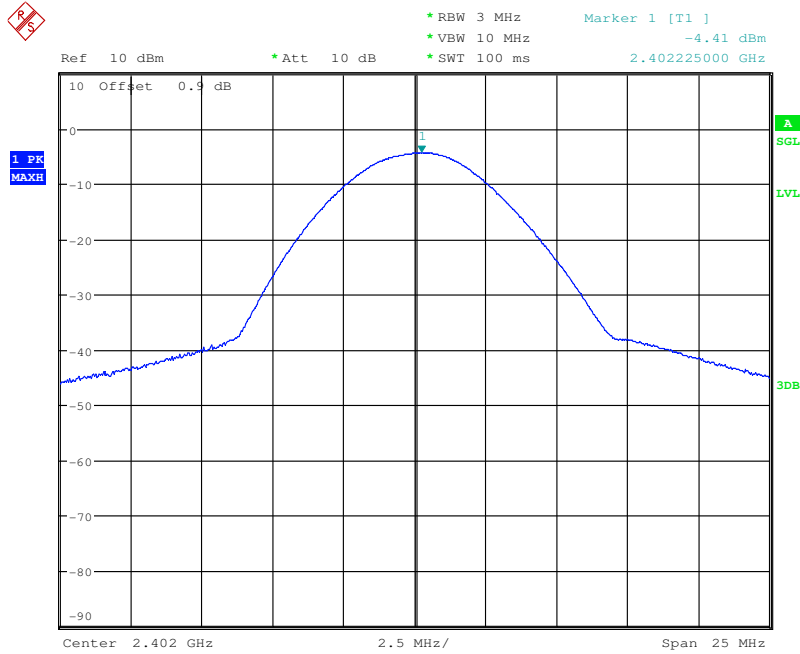

Test mode:	GFSK	Test channel:	Middle
------------	------	---------------	--------

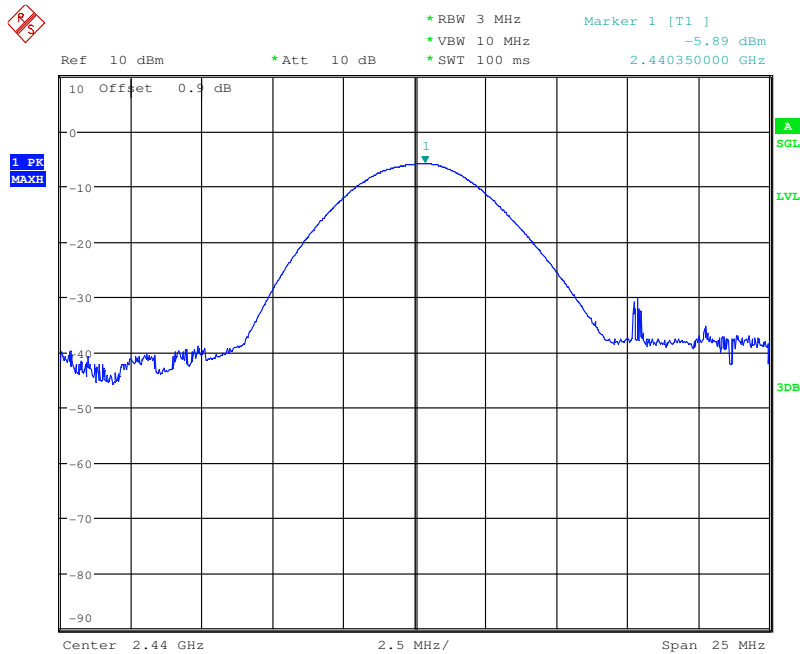



Test mode:	GFSK	Test channel:	Highest
------------	------	---------------	---------

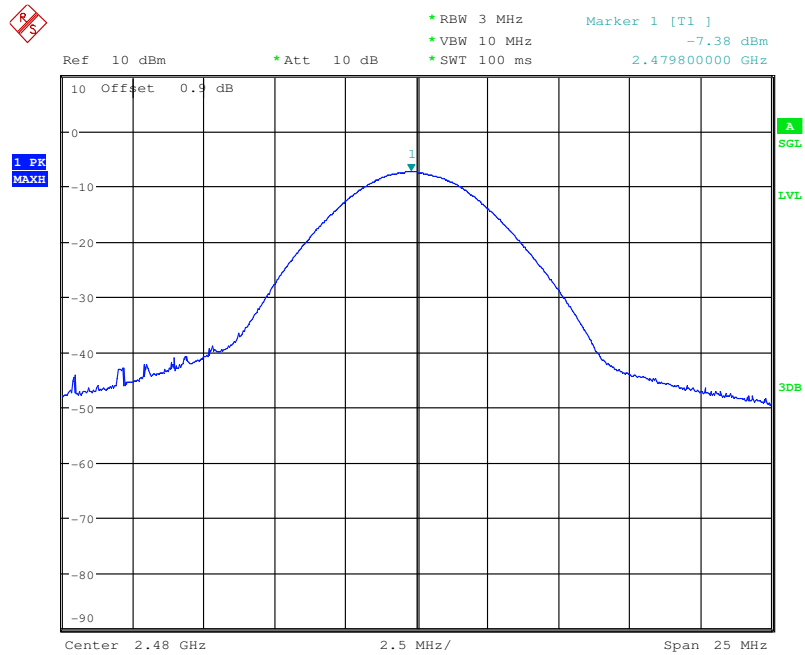

6.3 6dB Occupy Bandwidth

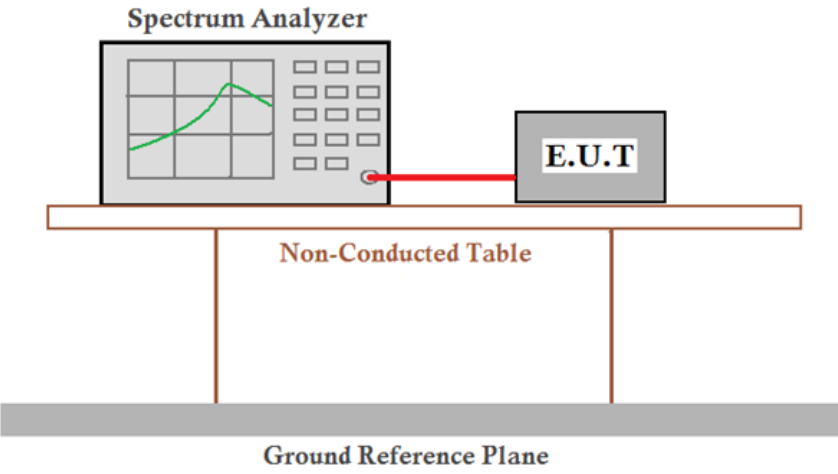
Test Requirement:	47 CFR Part 15C Section 15.247 (a)(2)
Test Method:	ANSI C63.10: 2013 Section 11.8
Test Setup:	
Limit:	≥ 500 kHz
Test Mode:	Transmitting with GFSK modulation.
Instruments Used:	Refer to section 5.10 for details.
Test Results:	Pass

Measurement Data

GFSK mode			
Test channel	6dB Occupy Bandwidth (MHz)	Limit (kHz)	Result
Lowest	0.681	≥500	Pass
Middle	0.681	≥500	Pass
Highest	0.672	≥500	Pass



Test plot as follows:

Test mode:	GFSK	Test channel:	Lowest
------------	------	---------------	--------

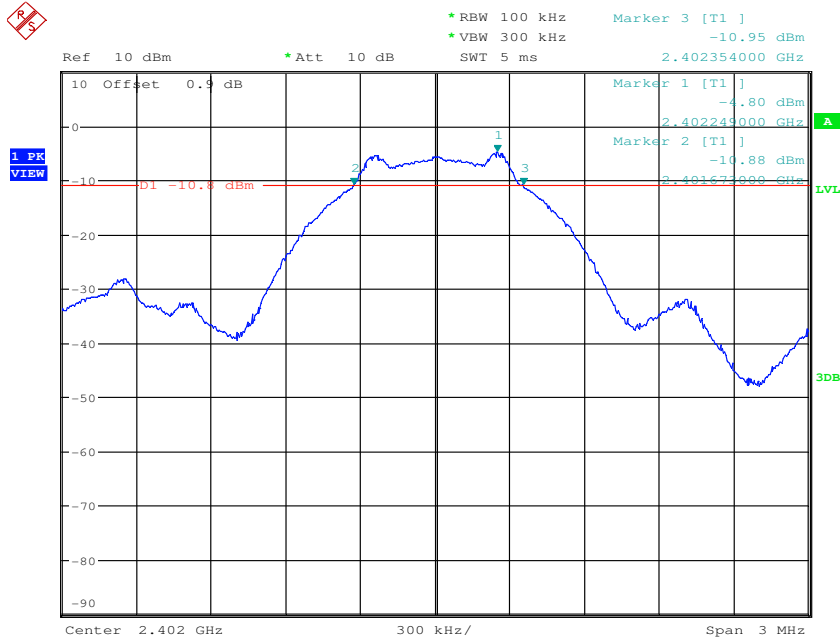

Test mode:	GFSK	Test channel:	Middle
------------	------	---------------	--------

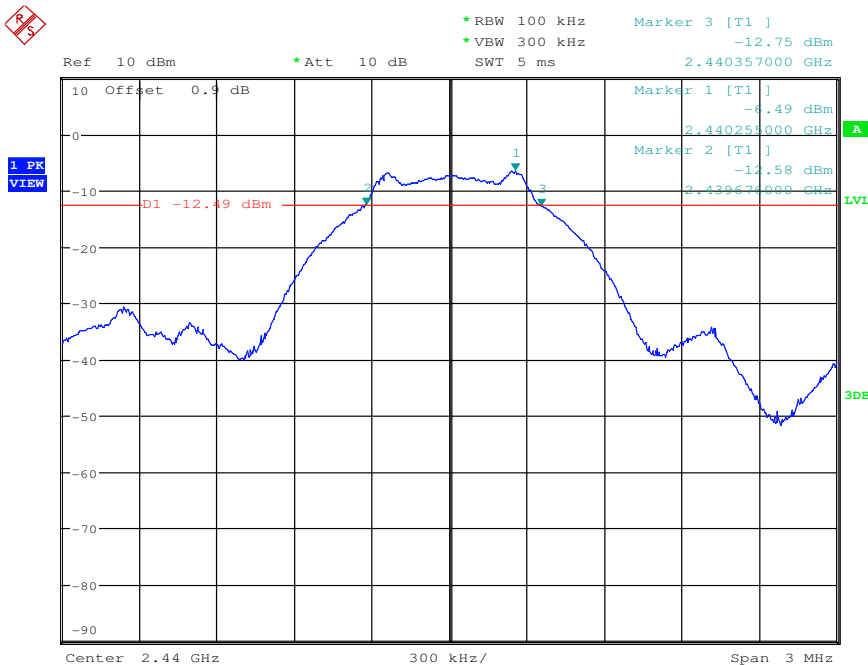



Test mode:	GFSK	Test channel:	Highest
------------	------	---------------	---------

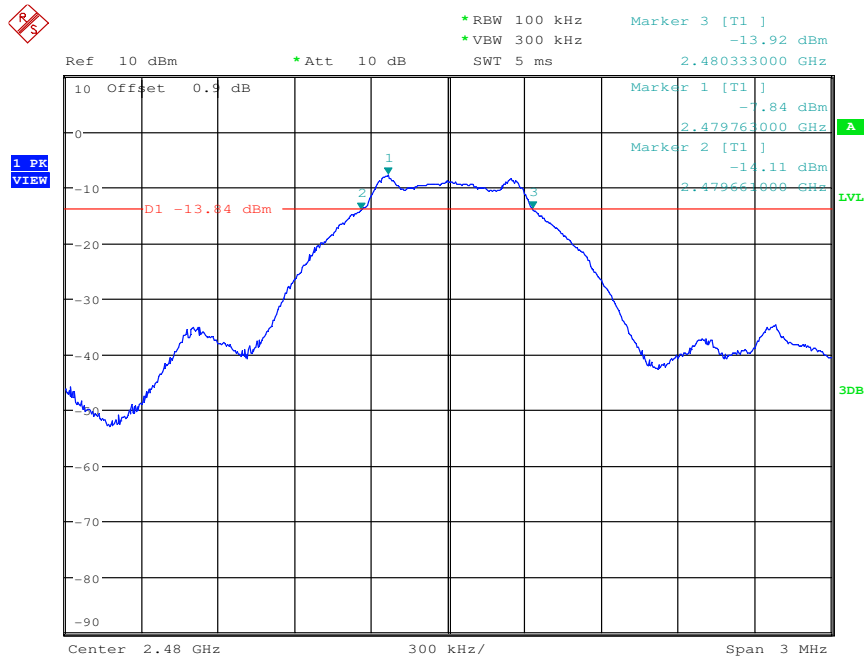

6.4 Power Spectral Density

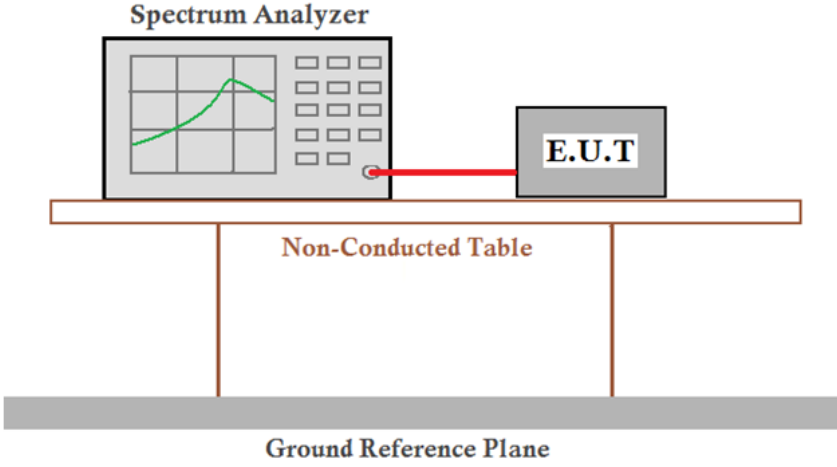
Test Requirement:	47 CFR Part 15C Section 15.247 (e)
Test Method:	ANSI C63.10 :2013 Section 11.10.2
Test Setup:	 <p>The diagram shows a Spectrum Analyzer on the left and an E.U.T. on the right, connected by a red cable. They are both on a table labeled 'Non-Conducted Table'. Below the table is a 'Ground Reference Plane'.</p>
Limit:	≤8.00dBm/3kHz
Test Mode:	Transmitting with GFSK modulation.
Instruments Used:	Refer to section 5.10 for details.
Test Results:	Pass

Measurement Data

GFSK mode			
Test channel	Power Spectral Density (dBm/3kHz)	Limit (dBm/3kHz)	Result
Lowest	-16.56	≤8.00	Pass
Middle	-18.58	≤8.00	Pass
Highest	-19.24	≤8.00	Pass



Test plot as follows:

Test mode:	GFSK	Test channel:	Lowest
------------	------	---------------	--------

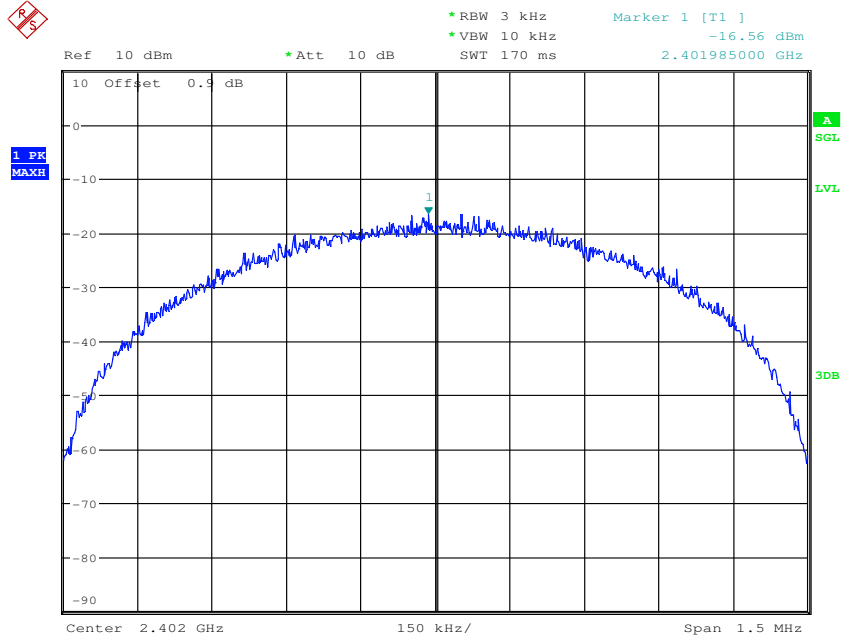

Test mode:	GFSK	Test channel:	Middle
------------	------	---------------	--------

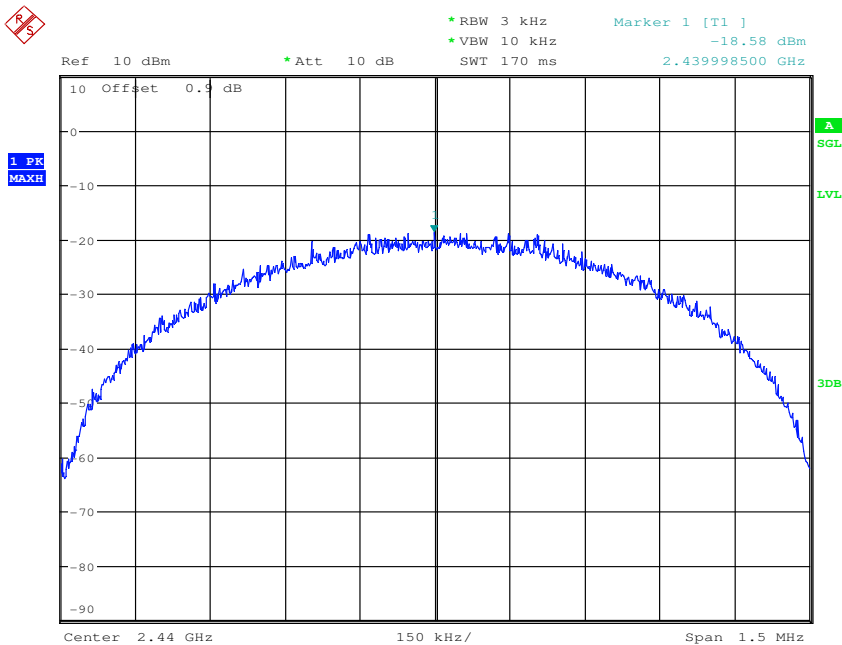



Test mode:	GFSK	Test channel:	Highest
------------	------	---------------	---------

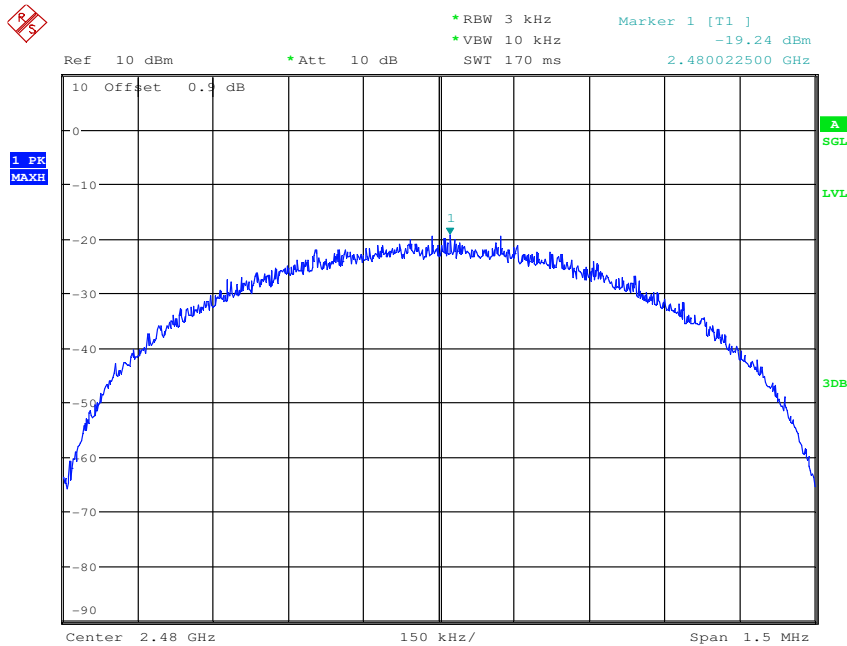

6.5 Band-edge for RF Conducted Emissions

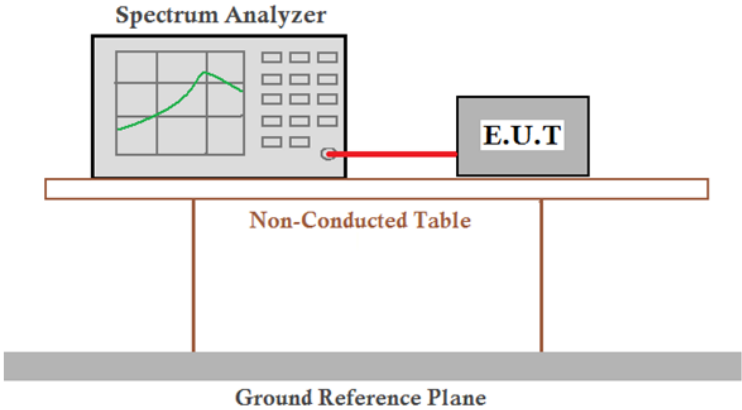
Test Requirement:	47 CFR Part 15C Section 15.247 (d)
Test Method:	ANSI C63.10: 2013 Section 11.13
Test Setup:	 <p>Remark: Offset the High-Frequency cable loss 1.5dB in the spectrum analyzer.</p>
Limit:	In any 100 kHz bandwidth outside the frequency band in which the spread spectrum intentional radiator is operating, the radio frequency power that is produced by the intentional radiator shall be at least 20 dB below that in the 100 kHz bandwidth within the band that contains the highest level of the desired power, based on either an RF conducted or a radiated measurement.
Test Mode:	Transmitting with GFSK modulation.
Instruments Used:	Refer to section 5.10 for details.
Test Results:	Pass



Test plot as follows:

Test mode:	GFSK	Test channel:	Lowest
------------	------	---------------	--------

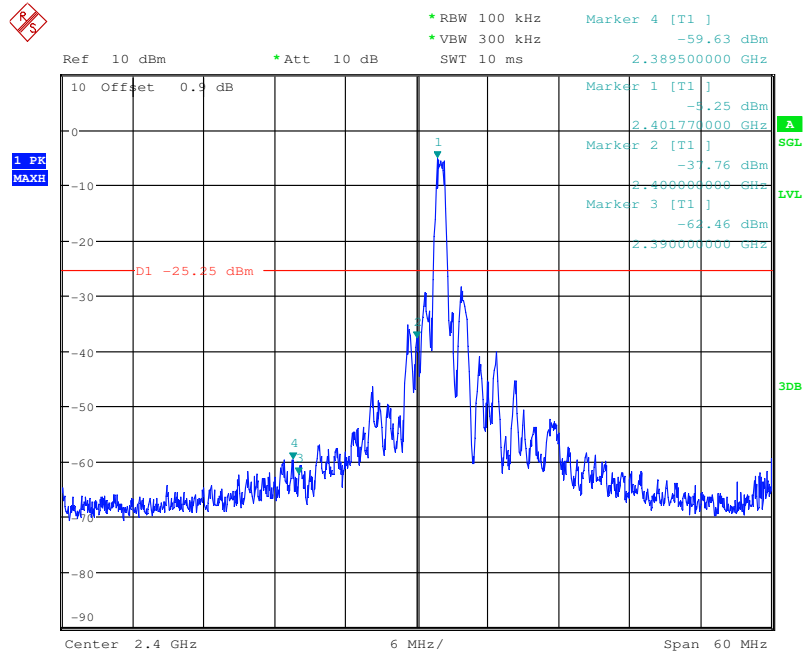

Test mode:	GFSK	Test channel:	Highest
------------	------	---------------	---------

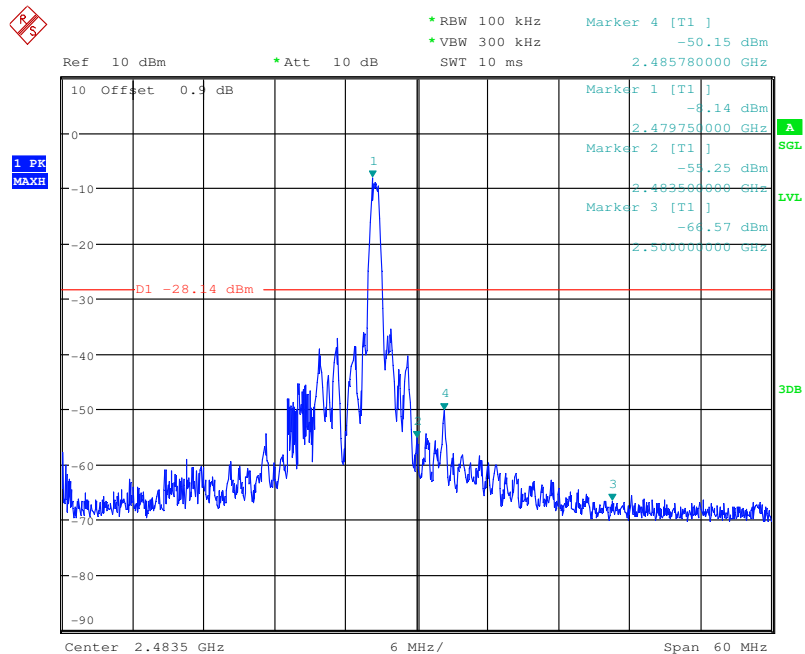

6.6 Spurious RF Conducted Emissions

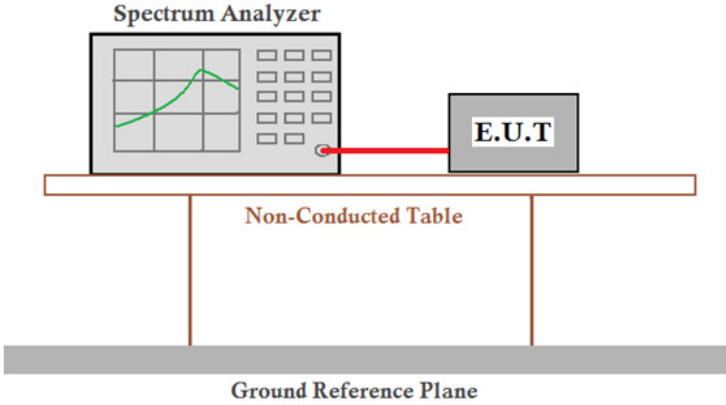
Test Requirement:	47 CFR Part 15C Section 15.247 (d)
Test Method:	ANSI C63.10: 2013 Section 11.11
Test Setup:	 <p>Remark: Offset the High-Frequency cable loss 1.5dB in the spectrum analyzer.</p>
Limit:	In any 100 kHz bandwidth outside the frequency band in which the spread spectrum intentional radiator is operating, the radio frequency power that is produced by the intentional radiator shall be at least 20 dB below that in the 100 kHz bandwidth within the band that contains the highest level of the desired power, based on either an RF conducted or a radiated measurement.
Test Mode:	Transmitting with GFSK modulation.
Instruments Used:	Refer to section 5.10 for details.
Test Results:	Pass



Test plot as follows:

Test mode:	GFSK	Test channel:	Lowest
------------	------	---------------	--------

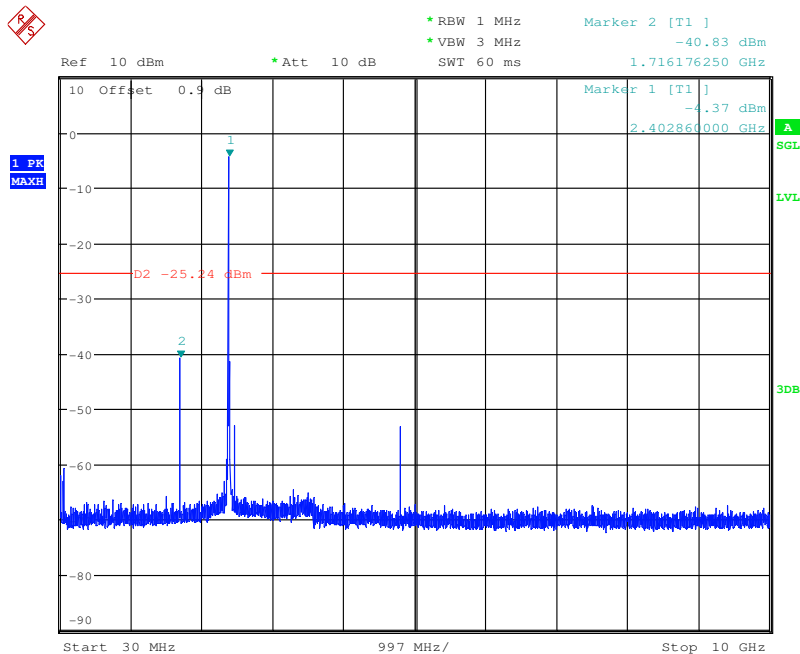
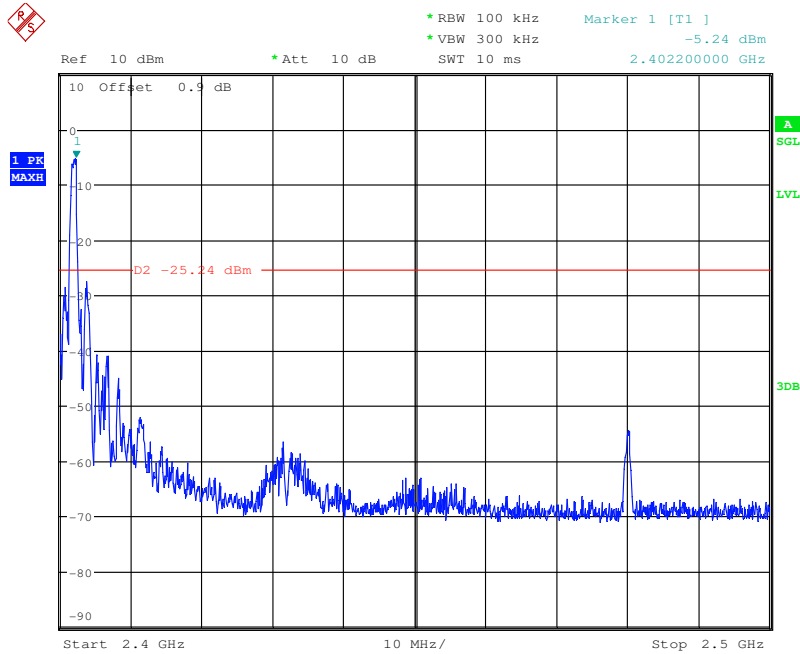

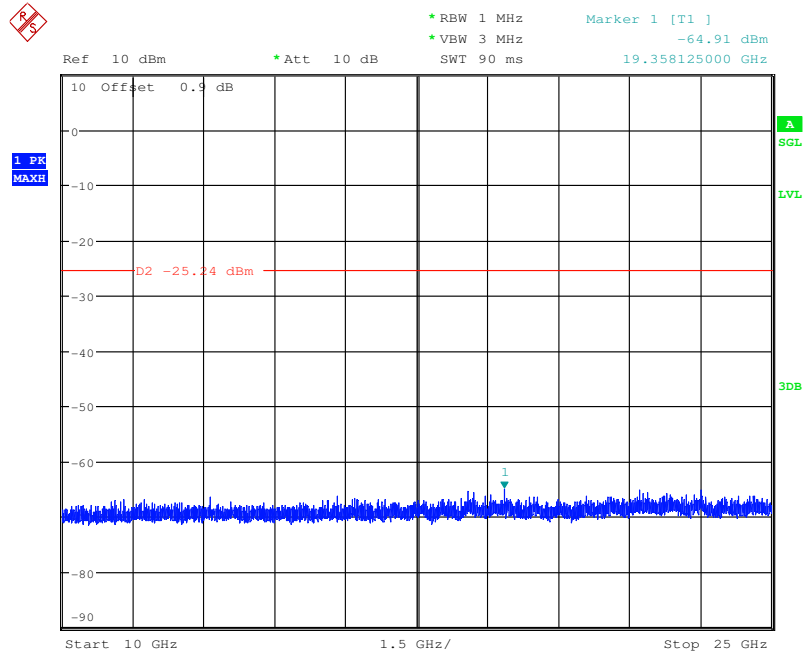

Test mode:	GFSK	Test channel:	Middle
------------	------	---------------	--------

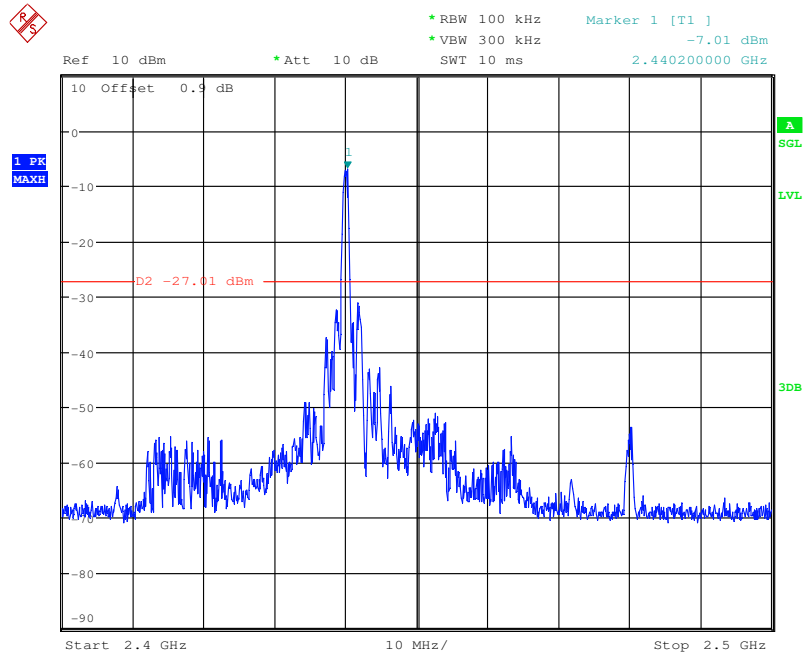

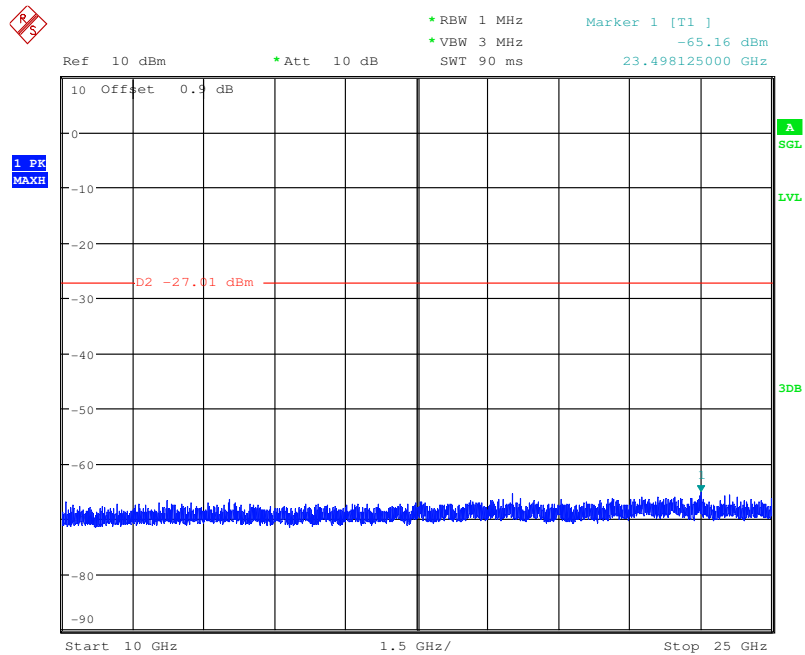
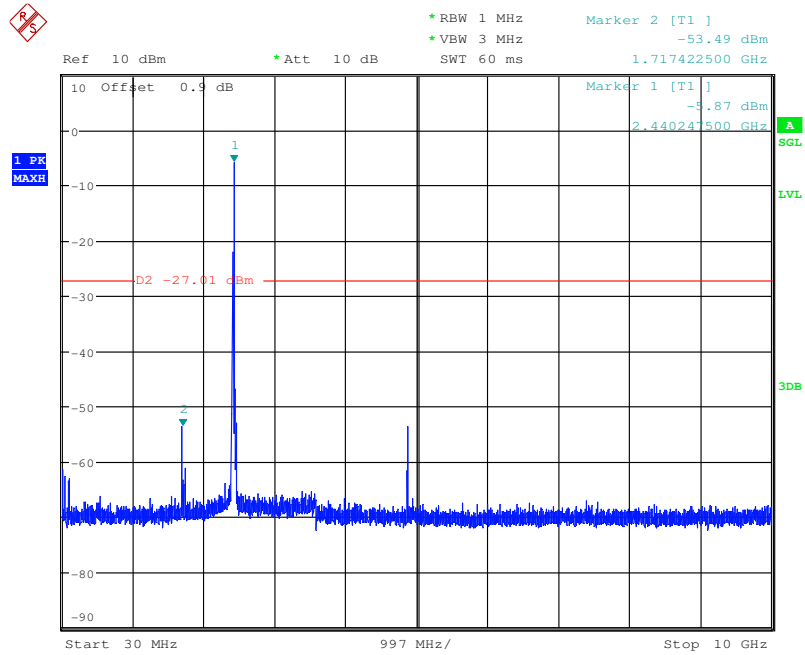



Test mode:	GFSK	Test channel:	Highest
------------	------	---------------	---------

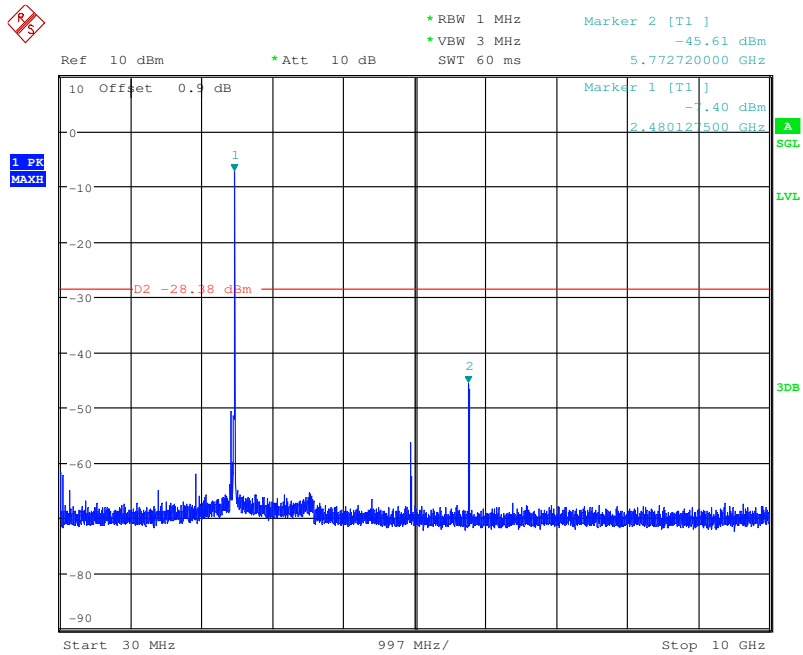
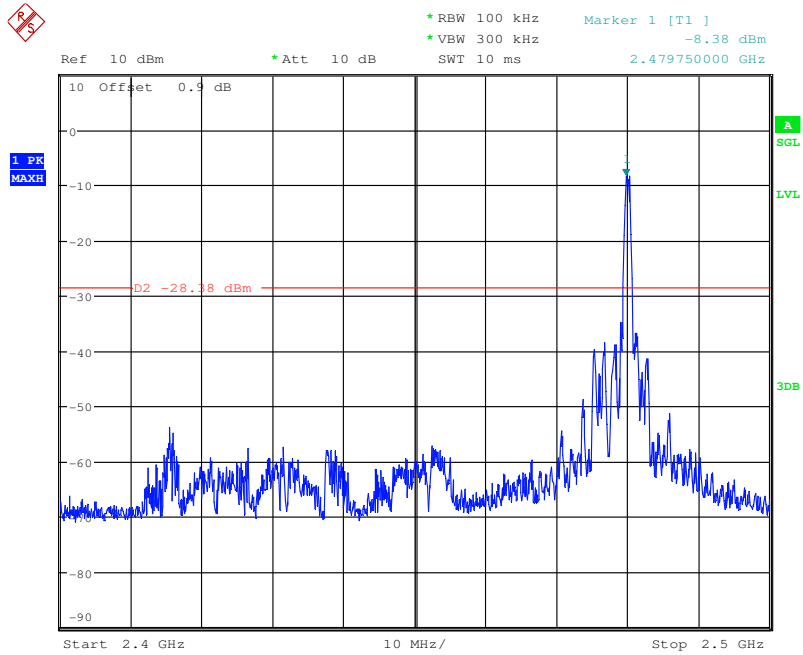

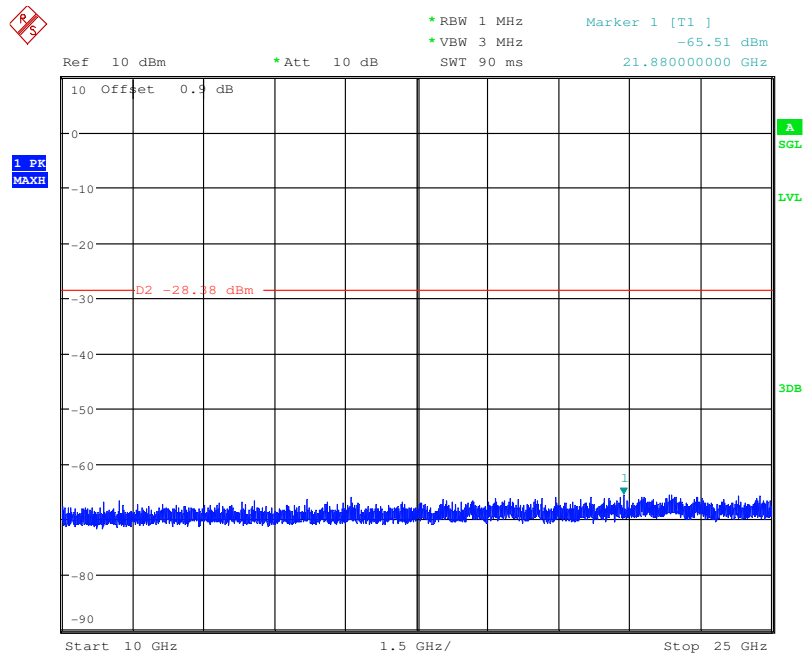

Remark:

Use 100kHz RBW to determine the relative limit in the band 2.4GHz to 2.5GHz, and Use 1MHz RBW to measure spurious emissions in the band 30MHz to 10GHz and 10GHz to 25GHz. The sweep points set to 30001.

6.7 Radiated Spurious Emission

6.7.1 Spurious Emissions					
Test Requirement:	47 CFR Part 15C Section 15.209 and 15.205				
Test Method:	ANSI C63.10 :2013 Section 11.12				
Test Site:	Below 1GHz: Measurement Distance: 3m (Semi-Anechoic Chamber) Above 1GHz: Measurement Distance: 3m (Full-Anechoic Chamber)				
Receiver Setup:	Frequency	Detector	RBW	VBW	Remark
	0.009MHz-0.090MHz	Peak	10kHz	30kHz	Peak
	0.009MHz-0.090MHz	Average	10kHz	30kHz	Average
	0.090MHz-0.110MHz	Quasi-peak	10kHz	30kHz	Quasi-peak
	0.110MHz-0.490MHz	Peak	10kHz	30kHz	Peak
	0.110MHz-0.490MHz	Average	10kHz	30kHz	Average
	0.490MHz -30MHz	Quasi-peak	10kHz	30kHz	Quasi-peak
	30MHz-1GHz	Quasi-peak	100 kHz	300kHz	Quasi-peak
	Above 1GHz	Peak	1MHz	3MHz	Peak
Peak		1MHz	10Hz	Average	
Limit:	Frequency	Field strength (microvolt/meter)	Limit (dBuV/m)	Remark	Measurement distance (m)
	0.009MHz-0.490MHz	2400/F(kHz)	-	-	300
	0.490MHz-1.705MHz	24000/F(kHz)	-	-	30
	1.705MHz-30MHz	30	-	-	30
	30MHz-88MHz	100	40.0	Quasi-peak	3
	88MHz-216MHz	150	43.5	Quasi-peak	3
	216MHz-960MHz	200	46.0	Quasi-peak	3
	960MHz-1GHz	500	54.0	Quasi-peak	3
	Above 1GHz	500	54.0	Average	3
Note: 15.35(b), Unless otherwise specified, the limit on peak radio frequency emissions is 20dB above the maximum permitted average emission limit applicable to the equipment under test. This peak limit applies to the total peak emission level radiated by the device.					

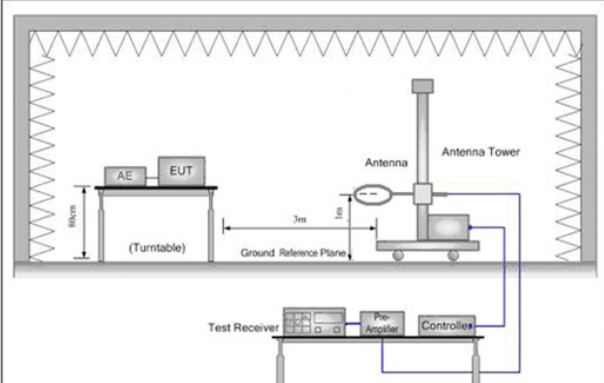
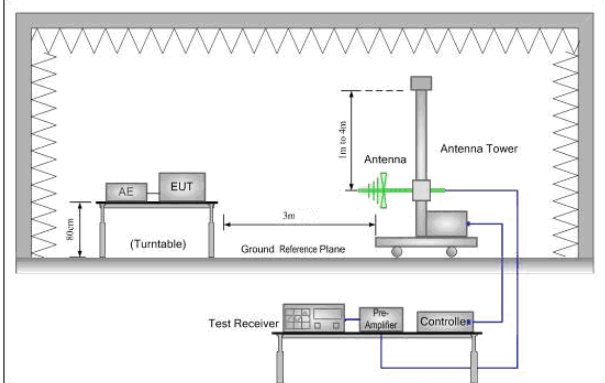
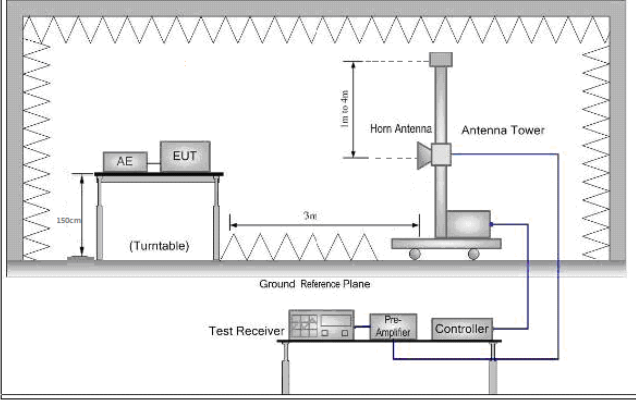
Test Setup:	
 <p style="text-align: center;">Figure 1. Below 30MHz</p>	 <p style="text-align: center;">Figure 2. 30MHz to 1GHz</p>
 <p style="text-align: center;">Figure 3. Above 1 GHz</p>	
<p>Test Procedure:</p>	<ol style="list-style-type: none"> a. For below 1GHz, the EUT was placed on the top of a rotating table 0.8 meters above the ground at a 3 meter semi-anechoic chamber. The table was rotated 360 degrees to determine the position of the highest radiation. b. For above 1GHz, the EUT was placed on the top of a rotating table 1.5 meters above the ground at a 3 meter full-anechoic chamber. The table was rotated 360 degrees to determine the position of the highest radiation. c. The EUT was set 3 meters away from the interference-receiving antenna, which was mounted on the top of a variable-height antenna tower. d. The antenna height is varied from one meter to four meters above the ground to determine the maximum value of the field strength. Both horizontal and vertical polarizations of the antenna are set to make the measurement. e. For each suspected emission, the EUT was arranged to its worst case and then the antenna was tuned to heights from 1 meter to 4 meters (for the test frequency of below 30MHz, the antenna was tuned to heights 1 meter) and the rotatable table was turned from 0 degrees to 360 degrees to find the maximum reading. f. The test-receiver system was set to Peak Detect Function and Specified Bandwidth with Maximum Hold Mode. g. If the emission level of the EUT in peak mode was 10dB lower than the limit specified, then testing could be stopped and the peak values of the EUT would be reported. Otherwise the emissions that did not have 10dB



	<p>margin would be re-tested one by one using peak, quasi-peak or average method as specified and then reported in a data sheet.</p> <p>h. Test the EUT in the lowest channel (2402MHz),the middle channel (2440MHz),the Highest channel (2480MHz)</p> <p>i. Repeat above procedures until all frequencies measured was complete.</p>
Exploratory Test Mode:	Transmitting with GFSK modulation.
Final Test Mode:	Transmitting with GFSK modulation. For below 1GHz part, through pre-scan, the worst case is the lowest channel. Only the worst case is recorded in the report.
Instruments Used:	Refer to section 5.10 for details.
Test Results:	Pass



Radiated Emission below 1GHz		
30MHz~1GHz (QP)		
Test mode:	Transmitting mode	Vertical

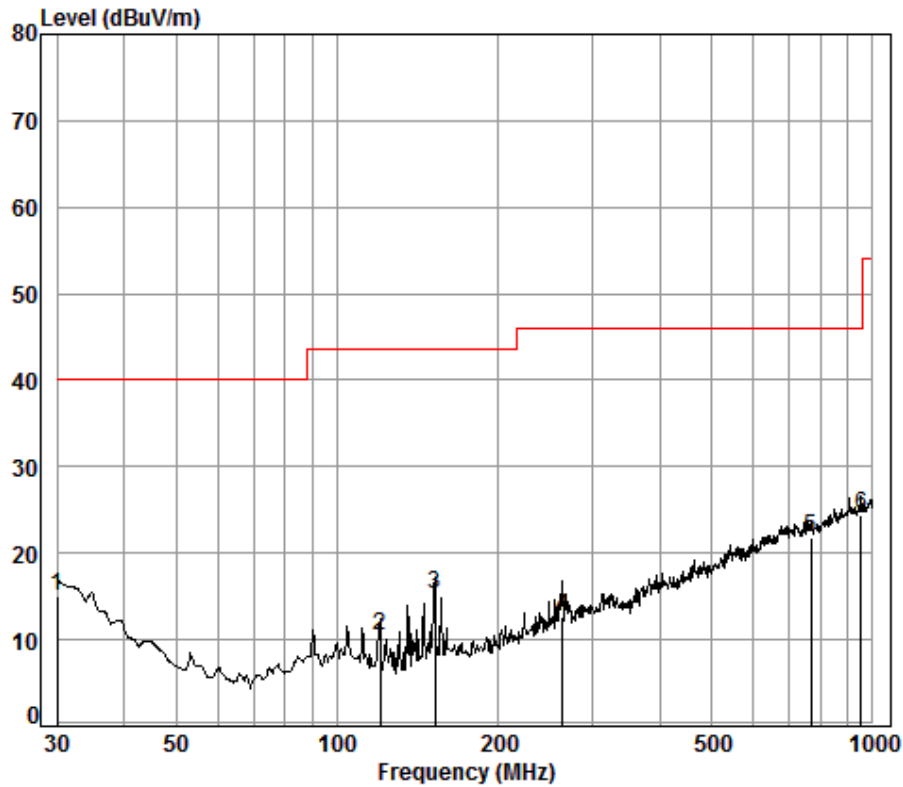

Condition: 3m VERTICAL

Job No. : 11338CR

Test mode: TX

	Freq	Cable Loss	Ant Factor	Preamp Factor	Read Level	Level	Limit	Over
	MHz	dB	dB/m	dB	dBuV	dBuV/m	dBuV/m	dB
1	30.00	0.60	18.70	27.36	23.02	14.96	40.00	-25.04
2	120.28	1.25	7.89	27.07	28.38	10.45	43.50	-33.05
3	152.13	1.32	9.13	26.90	31.75	15.30	43.50	-28.20
4	263.82	1.74	12.58	26.50	24.88	12.70	46.00	-33.30
5	766.06	3.11	21.89	27.33	24.06	21.73	46.00	-24.27
6 pp	952.09	3.65	23.30	26.54	24.10	24.51	46.00	-21.49



Test mode:	Transmitting mode	Horizontal
------------	-------------------	------------

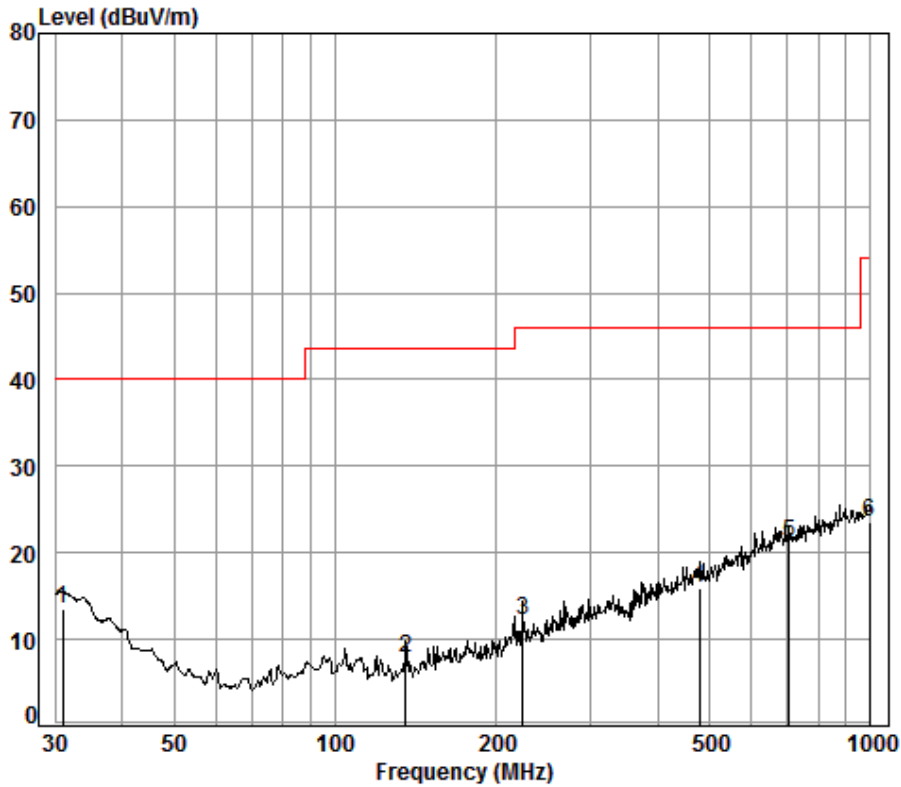

Condition: 3m HORIZONTAL

Job No. : 11338CR

Test mode: TX

	Freq	Cable Loss	Ant Factor	Preamp Factor	Read Level	Limit Level	Limit Line	Over Limit
	MHz	dB	dB/m	dB	dBuV	dBuV/m	dBuV/m	dB
1	30.96	0.60	18.16	27.35	22.10	13.51	40.00	-26.49
2	135.51	1.29	7.92	26.98	25.55	7.78	43.50	-35.72
3	223.73	1.54	11.43	26.62	25.95	12.30	46.00	-33.70
4	478.85	2.52	17.80	27.60	23.23	15.95	46.00	-30.05
5 pp	704.23	2.92	21.60	27.41	24.08	21.19	46.00	-24.81
6	996.50	3.70	24.16	26.33	21.91	23.44	54.00	-30.56



Transmitter Emission above 1GHz									
Test mode:		GFSK		Test channel:		Lowest		Remark:	Peak
Frequency (MHz)	Antenna Factor (dB/m)	Cable Loss (dB)	Preamp Factor (dB)	Read Level (dBuV)	Level (dBuV/m)	Limit Line (dBuV/m)	Over Limit (dB)	Polarization	
3754.236	32.94	7.72	37.98	43.65	46.33	74.00	-27.67	Vertical	
4804.000	34.16	8.87	38.40	43.61	48.24	74.00	-25.76	Vertical	
5947.702	34.67	10.42	38.31	44.27	51.05	74.00	-22.95	Vertical	
7206.000	36.42	10.68	37.11	41.53	51.52	74.00	-22.48	Vertical	
9608.000	37.52	12.50	35.10	37.58	52.50	74.00	-21.50	Vertical	
12050.440	38.63	14.52	35.72	36.36	53.79	74.00	-20.21	Vertical	
3797.945	33.06	7.74	37.98	44.68	47.50	74.00	-26.50	Horizontal	
4804.000	34.16	8.87	38.40	42.44	47.07	74.00	-26.93	Horizontal	
5820.005	34.59	10.06	38.34	44.18	50.49	74.00	-23.51	Horizontal	
7206.000	36.42	10.68	37.11	41.63	51.62	74.00	-22.38	Horizontal	
9608.000	37.52	12.50	35.10	37.68	52.60	74.00	-21.40	Horizontal	
11894.540	38.50	14.45	35.58	36.58	53.95	74.00	-20.05	Horizontal	

Test mode:		GFSK		Test channel:		Middle		Remark:	Peak
Frequency (MHz)	Antenna Factor (dB/m)	Cable Loss (dB)	Preamp Factor (dB)	Read Level (dBuV)	Level (dBuV/m)	Limit Line (dBuV/m)	Over Limit (dB)	Polarization	
3842.163	33.18	7.76	37.98	45.43	48.39	74.00	-25.61	Vertical	
4880.000	34.29	8.97	38.44	43.24	48.06	74.00	-25.94	Vertical	
6051.874	34.74	10.49	38.25	43.50	50.48	74.00	-23.52	Vertical	
7320.000	36.37	10.72	37.01	41.57	51.65	74.00	-22.35	Vertical	
9760.000	37.55	12.58	35.02	37.14	52.25	74.00	-21.75	Vertical	
12279.260	38.77	14.33	36.27	36.37	53.20	74.00	-20.80	Vertical	
3836.607	33.16	7.75	37.98	44.37	47.30	74.00	-26.70	Horizontal	
4880.000	34.29	8.97	38.44	42.27	47.09	74.00	-26.91	Horizontal	
6060.637	34.75	10.48	38.24	43.36	50.35	74.00	-23.65	Horizontal	
7320.000	36.37	10.72	37.01	41.72	51.80	74.00	-22.20	Horizontal	
9760.000	37.55	12.58	35.02	37.83	52.94	74.00	-21.06	Horizontal	
12386.320	38.83	14.24	36.53	36.57	53.11	74.00	-20.89	Horizontal	



Test mode:		GFSK		Test channel:		Highest		Remark:		Peak
Frequency (MHz)	Antenna Factor (dB/m)	Cable Loss (dB)	Preamplifier Factor (dB)	Read Level (dBuV)	Level (dBuV/m)	Limit Line (dBuV/m)	Over Limit (dB)	Polarization		
3558.534	32.37	7.65	37.96	44.41	46.47	74.00	-27.53	Vertical		
4960.000	34.43	9.09	38.48	46.76	51.80	74.00	-22.20	Vertical		
6078.201	34.76	10.46	38.22	43.77	50.77	74.00	-23.23	Vertical		
7440.000	36.32	10.77	36.90	41.31	51.50	74.00	-22.50	Vertical		
9920.000	37.58	12.67	34.94	37.31	52.62	74.00	-21.38	Vertical		
11980.900	38.58	14.54	35.60	36.31	53.83	74.00	-20.17	Vertical		
3737.975	32.89	7.72	37.97	44.51	47.15	74.00	-26.85	Horizontal		
4960.000	34.43	9.09	38.48	41.67	46.71	74.00	-27.29	Horizontal		
6166.787	34.84	10.34	38.13	43.62	50.67	74.00	-23.33	Horizontal		
7440.000	36.32	10.77	36.90	41.71	51.90	74.00	-22.10	Horizontal		
9920.000	37.58	12.67	34.94	37.53	52.84	74.00	-21.16	Horizontal		
12137.940	38.68	14.45	35.93	36.12	53.32	74.00	-20.68	Horizontal		

Remark:

- 1) The field strength is calculated by adding the Antenna Factor, Cable Factor & Preamplifier. The basic equation with a sample calculation is as follows:
Final Test Level = Receiver Reading + Antenna Factor + Cable Factor – Preamplifier Factor
- 2) Scan from 9kHz to 25GHz, the disturbance above 13GHz and below 30MHz was very low, and the above harmonics were the highest point could be found when testing, so only the above harmonics had been displayed. The amplitude of spurious emissions from the radiator which are attenuated more than 20dB below the limit need not be reported.
- 3) As shown in this section, for frequencies above 1GHz, the field strength limits are based on average limits. However, the peak field strength of any emission shall not exceed the maximum permitted average limits specified above by more than 20 dB under any condition of modulation. So, only the peak measurements were shown in the report.

6.8 Restricted bands around fundamental frequency

Test Requirement:	47 CFR Part 15C Section 15.209 and 15.205		
Test Method:	ANSI C63.10: 2013 Section 11.12		
Test Site:	Above 1GHz: Measurement Distance: 3m (Full-Anechoic Chamber)		
Limit:	Frequency	Limit (dBuV/m @3m)	Remark
	30MHz-88MHz	40.0	Quasi-peak Value
	88MHz-216MHz	43.5	Quasi-peak Value
	216MHz-960MHz	46.0	Quasi-peak Value
	960MHz-1GHz	54.0	Quasi-peak Value
	Above 1GHz	54.0	Average Value
		74.0	Peak Value

Test Setup:	
-------------	--

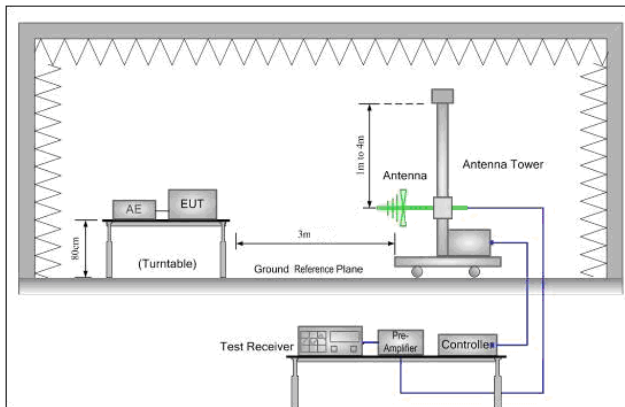

Figure 1. 30MHz to 1GHz

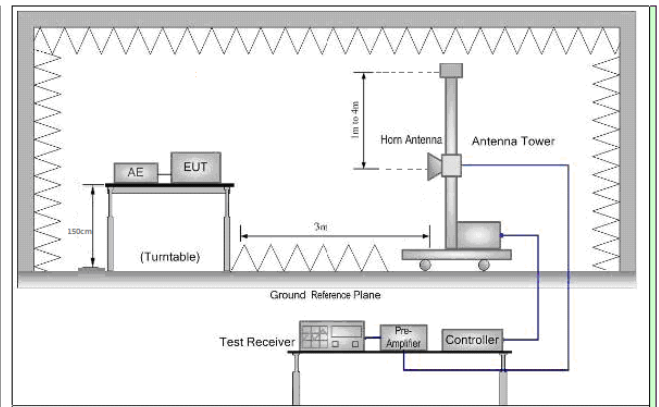

Figure 2. Above 1 GHz

Test Procedure:	<ol style="list-style-type: none"> For below 1GHz, the EUT was placed on the top of a rotating table 0.8 meters above the ground at a 3 meter semi-anechoic chamber. The table was rotated 360 degrees to determine the position of the highest radiation. For above 1GHz, the EUT was placed on the top of a rotating table 1.5 meters above the ground at a 3 meter full-anechoic chamber. The table was rotated 360 degrees to determine the position of the highest radiation. The EUT was set 3 meters away from the interference-receiving antenna, which was mounted on the top of a variable-height antenna tower. The antenna height is varied from one meter to four meters above the ground to determine the maximum value of the field strength. Both horizontal and vertical polarizations of the antenna are set to make the measurement. For each suspected emission, the EUT was arranged to its worst case and then the antenna was tuned to heights from 1 meter to 4 meters and the rotatable table was turned from 0 degrees to 360 degrees to find the maximum reading. The test-receiver system was set to Peak Detect Function and Specified Bandwidth with Maximum Hold Mode. Place a marker at the end of the restricted band closest to the transmit frequency to show compliance. Also measure any emissions in the restricted bands. Save the spectrum analyzer plot. Repeat for each power and modulation for lowest and highest channel Test the EUT in the lowest channel , the Highest channel Repeat above procedures until all frequencies measured was complete.
-----------------	--------------------------------------------------------------------------------------------------------------------------------------------------------------------------------------------------------------------------------------------------------------------------------------------------------------------------------------------------------------------------------------------------------------------------------------------------------------------------------------------------------------------------------------------------------------------------------------------------------------------------------------------------------------------------------------------------------------------------------------------------------------------------------------------------------------------------------------------------------------------------------------------------------------------------------------------------------------------------------------------------------------------------------------------------------------------------------------------------------------------------------------------------------------------------------------------------------------------------------------------------------------------------------------------------------------------------------------------------------------------------------------------------------------------------------------------------------------------------------------------------------------------------------------------------------------------------------------------------------------------------------------------------------------------------------------------



Exploratory Test Mode:	Transmitting with GFSK modulation.
Final Test Mode:	Transmitting with GFSK modulation.
Instruments Used:	Refer to section 5.10 for details.
Test Results:	Pass



Test plot as follows:

Test channel:	Lowest	Remark:	Peak	Vertical
---------------	--------	---------	------	----------

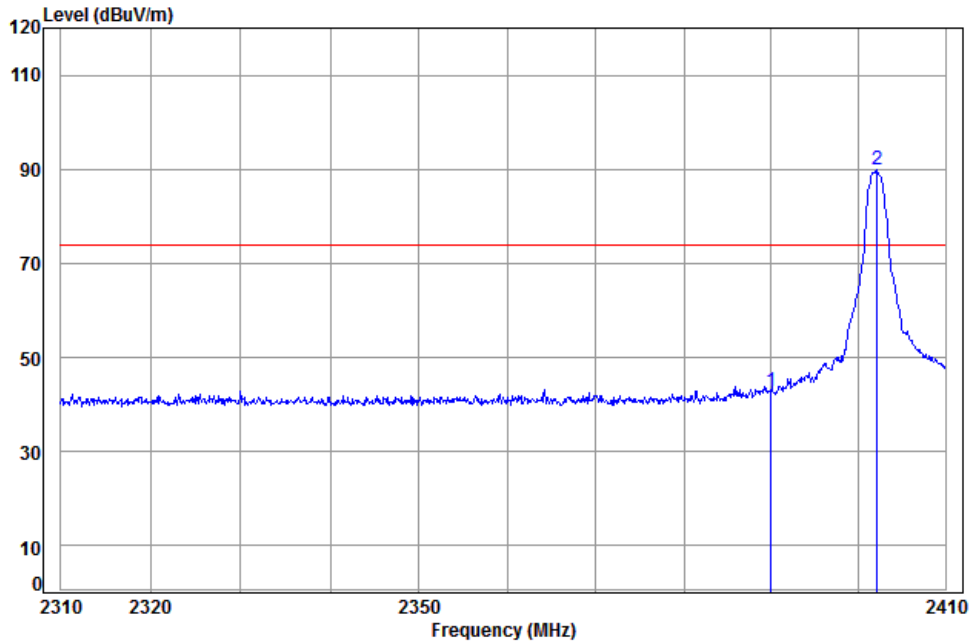

Condition: 3m VERTICAL
Job No: : 11338CR
Mode: : 2402 Bandedge
: BLE

	Freq	Cable Loss	Ant Factor	Preamp Factor	Read Level	Level	Limit Line	Over Limit	Remark
	MHz	dB	dB/m	dB	dBuV	dBuV/m	dBuV/m	dB	
1	2390.000	5.34	29.08	37.96	46.49	42.95	74.00	-31.05	
2	pp 2402.148	5.35	29.11	37.96	93.26	89.76	74.00	15.76	



Test channel:	Lowest	Remark:	Peak	Horizontal
---------------	--------	---------	------	------------

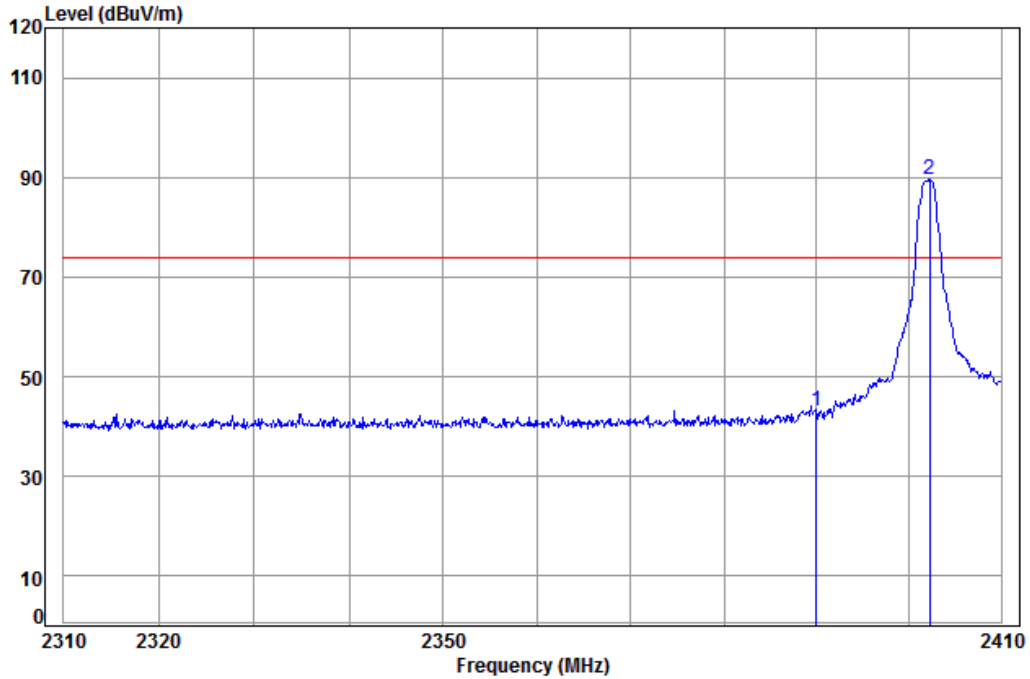

Condition: 3m HORIZONTAL
Job No: : 11338CR
Mode: : 2402 Bandedge
: BLE

	Freq	Cable Loss	Ant Factor	Preamp Factor	Read Level	Level	Limit Line	Over Limit	Remark
	MHz	dB	dB/m	dB	dBuV	dBuV/m	dBuV/m	dB	
1	2390.000	5.34	29.08	37.96	46.77	43.23	74.00	-30.77	
2	pp 2402.250	5.35	29.11	37.96	93.06	89.56	74.00	15.56	



Test channel:	Highest	Remark:	Peak	Vertical
---------------	---------	---------	------	----------

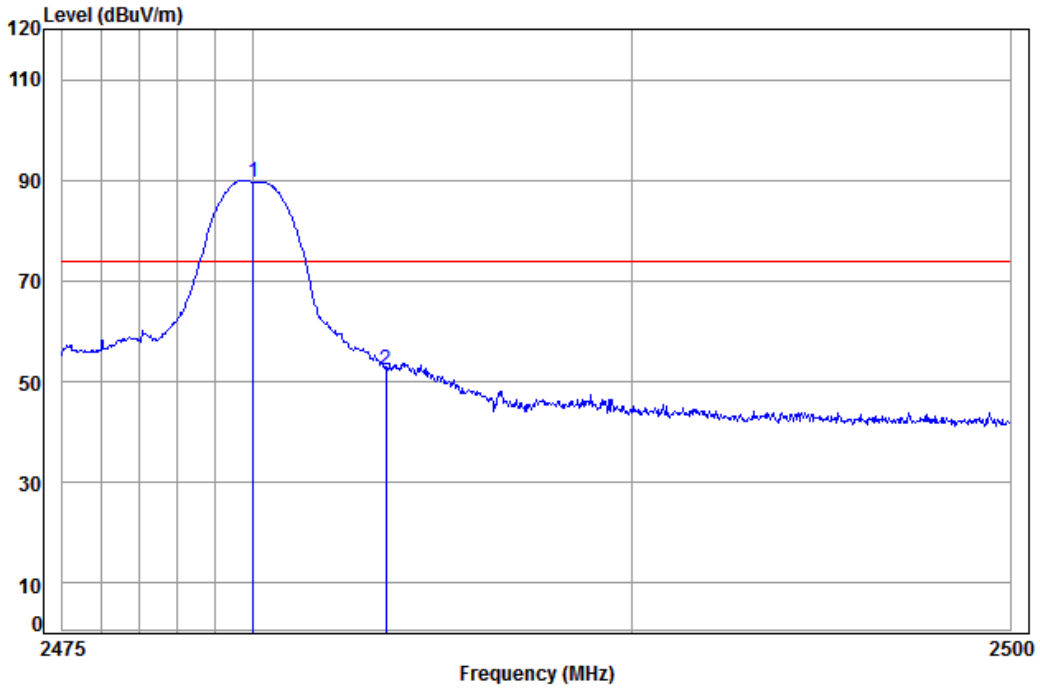

Condition: 3m VERTICAL
Job No: : 11338CR
Mode: : 2480 Bandedge
: BLE

	Freq	Cable Loss	Ant Factor	Preamp Factor	Read Level	Level	Limit Line	Over Limit	Remark
	MHz	dB	dB/m	dB	dBuV	dBuV/m	dBuV/m	dB	
1 pp	2480.005	5.41	29.34	37.95	92.91	89.71	74.00	15.71	
2	2483.500	5.41	29.35	37.95	55.66	52.47	74.00	-21.53	



Test channel:	Highest	Remark:	Peak	Horizontal
---------------	---------	---------	------	------------

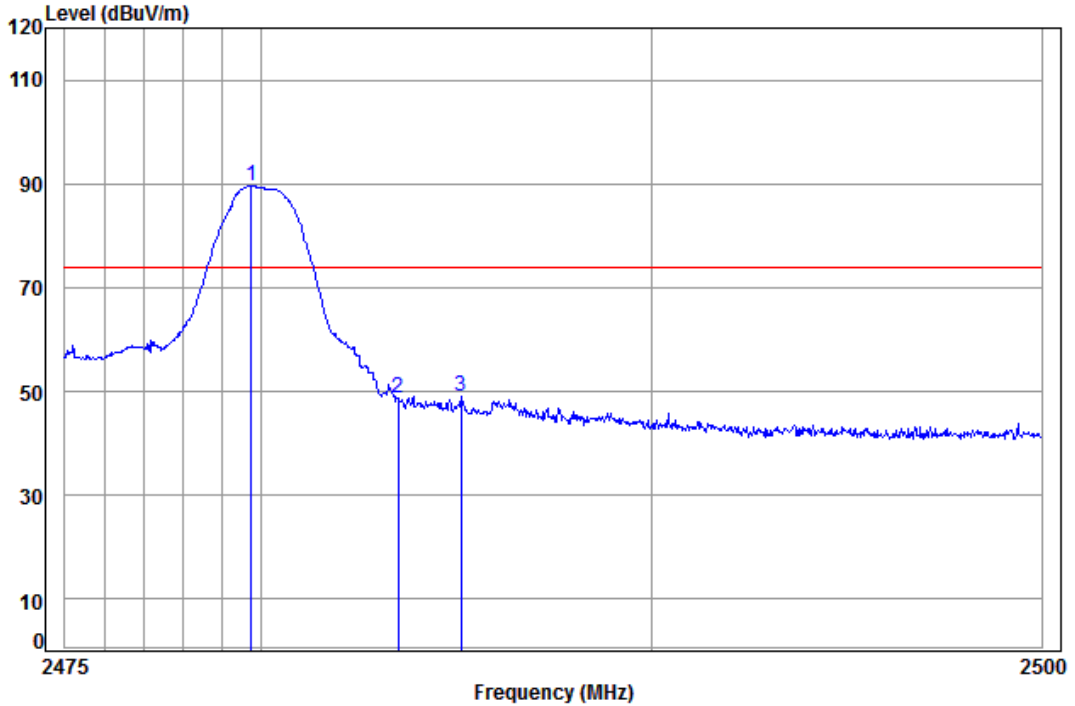

Condition: 3m HORIZONTAL
Job No: : 11338CR
Mode: : 2480 Bandedge
: BLE

	Freq	Cable Loss	Ant Factor	Preamp Factor	Read Level	Limit Level	Over Limit	Remark
	MHz	dB	dB/m	dB	dBuV	dBuV/m	dBuV/m	dB
1 pp	2479.756	5.41	29.34	37.95	92.75	89.55	74.00	15.55
2	2483.500	5.41	29.35	37.95	51.83	48.64	74.00	-25.36
3	2485.120	5.41	29.36	37.95	52.08	48.90	74.00	-25.10

Note:

The field strength is calculated by adding the Antenna Factor, Cable Factor & Preamplifier. The basic equation with a sample calculation is as follows:

$$\text{Final Test Level} = \text{Receiver Reading} + \text{Antenna Factor} + \text{Cable Factor} - \text{Preamplifier Factor}$$

7 Photographs - EUT Test Setup

Test model No.: DRP30

7.1 Radiated Emission

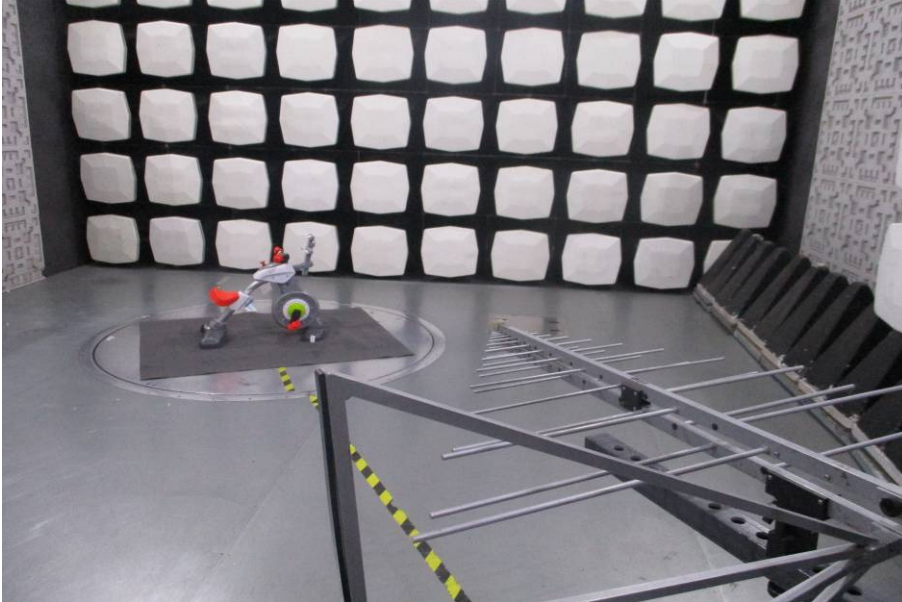

7.2 Radiated Spurious Emission

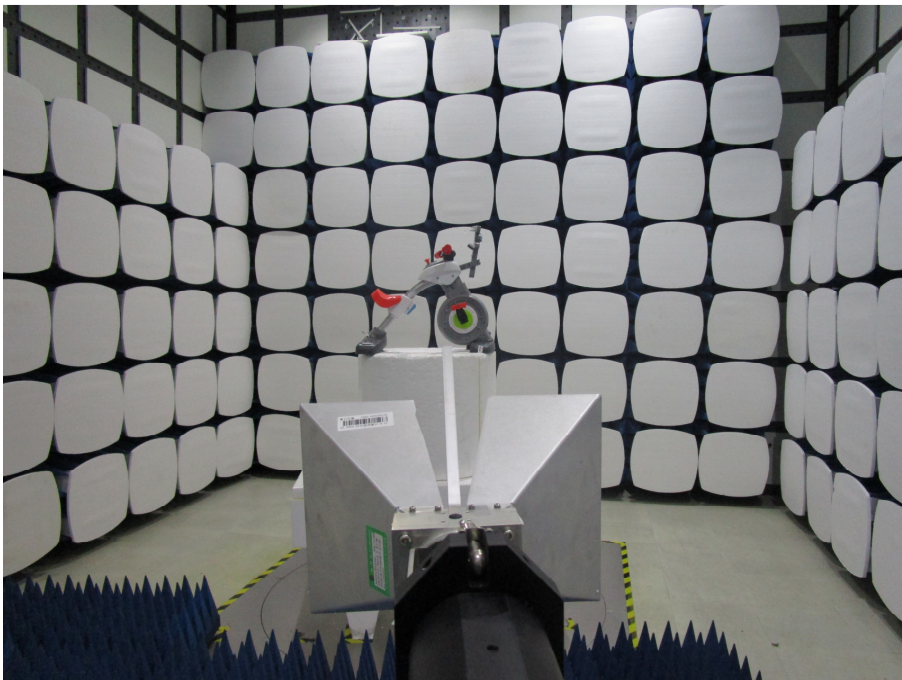

8 Photographs - EUT Constructional Details

Refer to Appendix A - Photographs of EUT Constructional Details for SZEM1612011338CR.