

ezWAVE

WWL-1100N&WWL-1100P

The innovation superhigh-speed wireless network,
Widelink takes the initiative.

Wireless LAN Card Users' Guide

Corporate Headquarters

Widelink Co. Ltd.

664-25 Dongshin Bldg. 2F

Shinsa-Dong, Kangnam-gu

Seoul 135-120, Korea

<http://www.widelink.co.kr>

Tel: +82-2-3445-9938

Fax: +82-2-3445-8534

Support

Windows 98/Me

Windows 2000

Linux

Widelink
Home Internet Service

www.widelink.co.kr

Contents

Chapter 1	Introduction To The Wireless LAN	4
1.1	What is Wireless LAN?	4
1.2	Wireless LAN Standard and Structure.....	5
Chapter 2	Before You Start ezWAVE	10
Chapter 3	Installing ezWAVE Card On The Windows Os	11
3.1	Installing PC Card Adapter.	11
3.1.1	Installing the PC Card Driver for Windows OS... ..	12
3.1.2	PC Card (PCMCIA) Network Configuration	17
3.1.3	Uninstalling PC Card Software	21
3.1.4	Remove PC Card from PC card socket	21
3.1.5	ezWAVE Configuration Utility	22
3.2	PCI Card Installation	26
3.2.1	Installing PCI Card Adapter	27
3.2.2	Installing PCI Card Driver	29
3.2.3	PCI Card Network Configuration	29
3.3	Troubleshooting	30
Appendix		
Appendix A	Cell Planning (Radio Range)	32
Appendix B	Technical Specification	34
Appendix C	Channel Allocation	36

THE SPECIFICATIONS AND INFORMATION REGARDING THE PRODUCTS IN THIS MANUAL ARE SUBJECT TO CHANGE WITHOUT NOTICE. ALL STATEMENTS, INFORMATION, AND RECOMMENDATIONS IN THIS MANUAL ARE BELIEVED TO BE ACCURATE BUT ARE PRESENTED WITHOUT WARRANTY OF ANY KIND, EXPRESS OR IMPLIED. USERS MUST TAKE FULL RESPONSIBILITY FOR THEIR APPLICATION OF ANY PRODUCTS.

THE SOFTWARE LICENSE AND LIMITED WARRANTY FOR THE ACCOMPANYING PRODUCT ARE SET FORTH IN THE INFORMATION PACKET THAT SHIPPED WITH THE PRODUCT AND ARE INCORPORATED HEREIN BY THIS REFERENCE. IF YOU ARE UNABLE TO LOCATE THE SOFTWARE LICENSE OR LIMITED WARRANTY, CONTACT YOUR WIDELINK REPRESENTATIVE FOR A COPY.

NOTWITHSTANDING ANY OTHER WARRANTY HEREIN, ALL DOCUMENT FILES AND SOFTWARE OF THESE SUPPLIERS ARE PROVIDED "AS IS" WITH ALL FAULTS. WIDELINK AND THE SUPPLIERS DISCLAIM ALL WARRANTIES, EXPRESSED OR IMPLIED, INCLUDING WITHOUT LIMITATION, THOSE OF MERCHANTABILITY, FITNESS FOR A PARTICULAR PURPOSE AND NON-INFRINGEMENT OR ARISING FROM A COURSE OF DEALING, USAGE, OR TRADE PRACTICE.

IN NO EVENT SHALL WIDELINK OR ITS SUPPLIERS BE LIABLE FOR ANY INDIRECT, SPECIAL, CONSEQUENTIAL, OR INCIDENTAL DAMAGES, INCLUDING WITHOUT LIMITATION, LOST PROFITS OR LOSS DAMAGE TO DATA ARISING OUT OF THE USE OR INABILITY TO USE THIS MANUAL, EVEN IF WIDELINK OR ITS SUPPLIERS HAVE BEEN ADVISED OF THE POSSIBILITY OF SUCH DAMAGES.

SAFETY INFORMATION**WARNING**

- * *Opening the unit, for whatever reason, could lead to damages that are not covered by the guarantee.*
- * *To prevent fire or shock hazard, do not expose your ezWAVE wireless LAN PC cards to rain or moisture.*

NOTES:

- * *The Widelink supplied software may show screens slightly different from those included in this manual.*
- * *This manual is written based on the assumption that you are familiar with basic operations of Windows operating system.*

Microsoft, Windows, Windows95, Windows98, Windows ME, Windows 2000 and Windows NT are registered trademarks of Microsoft Corporation.

ezWave, Widelink's logo, is registered trademark of Widelink Co., Ltd. or its affiliates in Korea, US and certain other countries. All other trademarks mentioned in this documents are the property of their respective owners. The use of word partner does not imply a partnership relationship between Widelink and any of its resellers.

*Using the Widelink's ezWAVE card
Copyright © 2000. Widelink Co., Ltd.
All rights reserved.*

Chapter 1 Introduction To The Wireless LAN

A wireless LAN (WLAN) is a flexible data communication system implemented as an extension to, or as an alternative for, a wired LAN within a building or campus. Using electromagnetic waves, WLANs transmit and receive data over the air, minimizing the need for wired connections. Thus, WLANs combine data connectivity with user mobility, and, through simplified configuration, enable movable LANs. WLANs have gained strong popularity in a number of vertical markets, including the health-care, retail, manufacturing, warehousing, and academic arenas. These industries have profited from the productivity gains of using hand-held terminals and notebook computers to transmit real-time information to centralized hosts for processing. Today WLANs are becoming more widely recognized as a general-purpose connectivity alternative for a broad range of business customers.

1.1 What is Wireless LAN?

Wireless LANs use electromagnetic airwaves (radio and infrared) to communicate information from one point to another without relying on any physical connection. Radio waves are often referred to as radio carriers because they simply perform the function of delivering energy to a remote receiver. The data being transmitted is superimposed on the radio carrier so that it can be accurately extracted at the receiving end. This is generally referred to as modulation of the carrier by the information being transmitted. Once data is superimposed (modulated) onto the radio carrier, the radio signal occupies more than a single frequency, since the frequency or bit rate of the modulating information adds to the carrier.

Multiple radio carriers can exist in the same space at the same time without interfering with each other if the radio waves are transmitted on different radio frequencies. To extract data, a radio receiver tunes in (or selects) one radio frequency while rejecting all other radio signals on different frequencies.

In a typical WLAN configuration, a transmitter/receiver (transceiver) device, called an access point, connects to the wired network from a fixed location using standard Ethernet cable. At a minimum, the access point receives, buffers, and transmits data between the WLAN and the wired network infrastructure. A single access point can support a small group of users and can function within a range of less than one hundred

to several hundred feet. The access point (or the antenna attached to the access point) is usually mounted high but may be mounted essentially anywhere that is practical as long as the desired radio coverage is obtained.

End users access the WLAN through wireless LAN adapters, which are implemented as PC cards in notebook computers, or use PCI adapters in desktop computers. WLAN adapters provide an interface between the client network operating system (NOS) and the airwaves (via an antenna). The nature of the wireless connection is transparent to the NOS.

1.2 Wireless LAN Standard and Structure

○ Wireless LAN Standard – IEEE802.11b

The widespread acceptance of WLANs depends on industry standardization to ensure product compatibility and reliability among the various manufacturers. The Institute of Electrical and Electronics Engineers (IEEE) ratified the original 802.11 specifications in 1997 as the standard for wireless LANs. That version of 802.11 provides for 1 Mbps and 2 Mbps data rates and a set of fundamental signaling methods and other services. The most critical issue affecting WLAN demand has been limited throughput. The data rates supported by the original 802.11 standard are too slow to support most general business requirements and have slowed adoption of WLANs. Recognizing the critical need to support higher data-transmission rates, the IEEE recently ratified the 802.11b standard (also known as 802.11 High Rate) for transmissions of up to 11 Mbps.

With 802.11b, WLANs will be able to achieve wireless performance and throughput comparable to wired Ethernet. Outside of the standards bodies, wireless industry leaders have united to form the Wire-less Ethernet Compatibility Alliance (WECA).

WECA's mission is to certify cross-vendor interoperability and compatibility of IEEE 802.11b wireless networking products and to promote that standard for the enterprise, the small business, and the home. Members include WLAN semiconductor manufacturers, WLAN providers, computer system vendors, and software makers.

○ Wireless LAN Network Equipment

802.11 defines two pieces of equipment, a wireless *station*, which is usually a PC equipped with a wireless network interface card (NIC), and an *access point (AP)*, which acts as a bridge between the wireless and wired networks. An access point usually

consists of a radio, a wired network interface (e.g., 802.3), and bridging software conforming to the 802.1d bridging standard. The access point acts as the base station for the wireless network, aggregating access for multiple wireless stations onto the wired network. Wireless end stations can be 802.11 PC Card, PCI.

○ Wireless LAN Network Configuration

The 802.11 standard define two modes: *infrastructure* mode and *ad hoc* mode (or independent or peer-to-peer).

- Ad Hoc Mode

Ad hoc mode (also called peer-to-peer mode or an Independent Basic Service Set, or IBSS) is simply a set of 802.11 wireless stations that communicate directly with one another without using an access point or any connection to a wired network. This mode is useful for quickly and easily setting up a wireless network anywhere that a wireless infrastructure does not exist or is not required for services, such as a hotel room, convention center, or airport, or where access to the wired network is barred (such as for consultants at a client site).

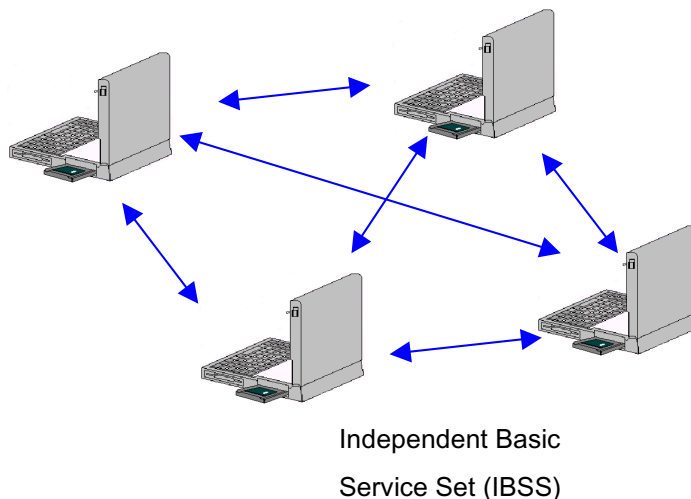

Figure 1. Ad Hoc Mode

- Infrastructure Mode

In infrastructure mode, the wireless network consists of at least one access

point connected to the wired network infrastructure and a set of wireless end stations. This configuration is called a *Basic Service Set (BSS)*. An *Extended Service Set (ESS)* is a set of two or more BSSs forming a single sub-network. Since most corporate WLANs require access to the wired LAN for services (file servers, printers, Inter-net links) they will operate in infrastructure mode.

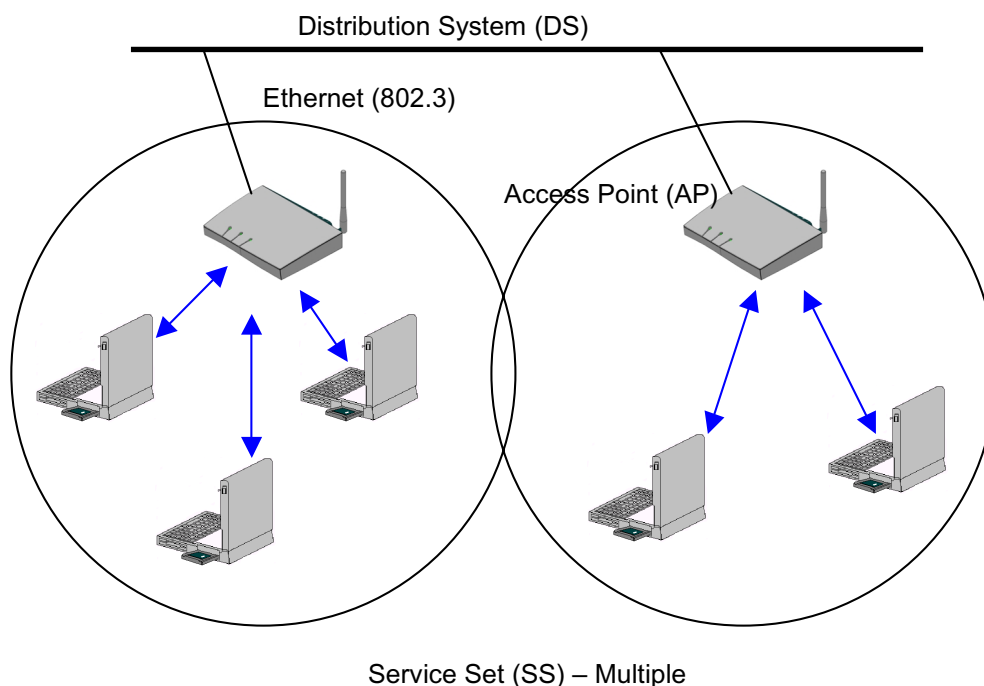

Figure 2. Infrastructure Mode

○ Roaming

Wireless communication is limited by how far signals carry for given power output. WLANs use cells, called microcells, similar to the cellular telephone system to extend the range of wireless connectivity. At any point in time, a mobile PC equipped with a WLAN adapter is associated with a single access point and its microcell, or area of coverage. Individual microcells overlap to allow continuous communication within wired network. They handle low power signals and “hand off” users as they roam through a given geographic area.

The 802.11 MAC layer is responsible for how a client associates with an access point.

When an 802.11 client enters the range of one or more APs, it chooses an access point to associate with (also called joining a Basic Service Set), based on signal strength and observed packet error rates. Once accepted by the access point, the client tunes to the radio channel to which the access point is set. Periodically it surveys all 802.11 channels in order to assess whether a different access point would provide it with better performance characteristics. If it determines that this is the case, it *reassociates* with the new access point, tuning to the radio channel to which that access point is set. Reassociation usually occurs because the wireless station has physically moved away from the original access point, causing the signal to weaken. In other cases, Reassociation occurs due to a change in radio characteristics in the building, or due simply to high network traffic on the original access point. In the latter case this function is known as “load balancing,” since its primary function is to distribute the total WLAN load most efficiently across the available wireless infrastructure. This process of dynamically associating and reassociating with APs allows network managers to set up WLANs with very broad coverage by creating a series of overlapping 802.11b cells throughout a building or across a campus. To be successful, the IT manager ideally will employ “channel reuse,” taking care to set up each access point on an 802.11 DSSS channel that does not overlap with a channel used by a neighboring access point.

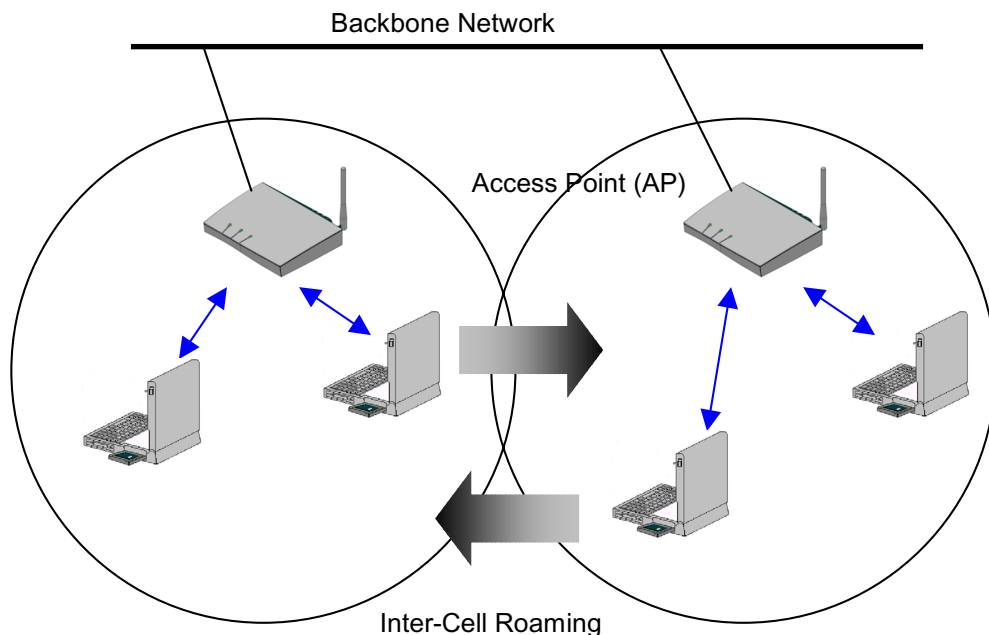

Figure 3. Roaming

○ **BSS, ESS and SS ID**

The basic service set (BSS) is the basic building block of WLAN network. Minimum WLAN BSS may be consist of only two stations. Using access point (AP) and network distribution systems (DS), WLAN service set can be extended arbitrary size – extended service set (ESS). Each service set has its network ID (SSID). All the service sets within an ESS network can have same service ID so that the ESS can support inter-cell ROAMING.

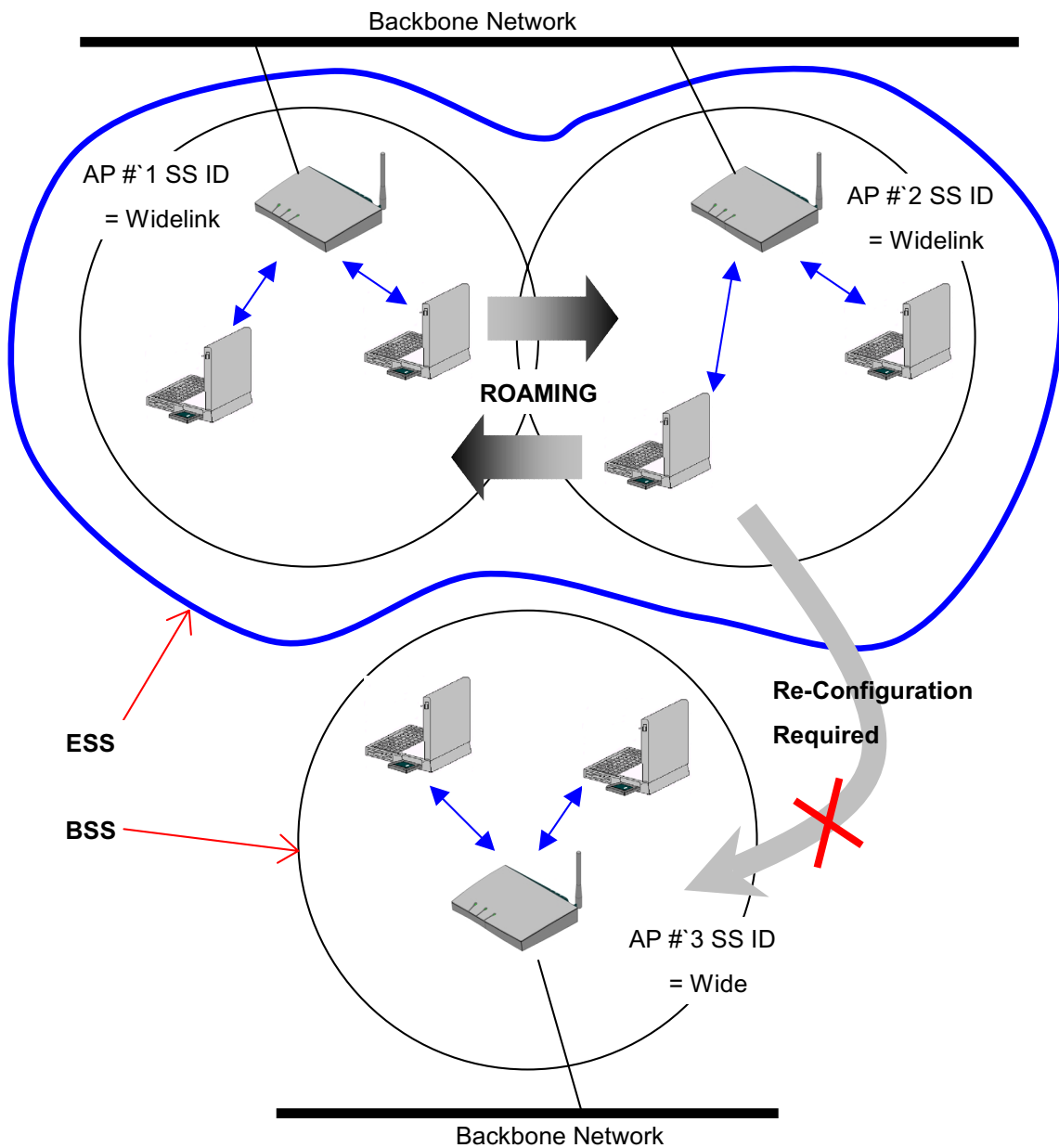

Figure 4. SSID and Roaming

Chapter 2 Before You Start ezWAVE

To use the ezWAVE adapter with a computing device (desktop personal computer, notebook, laptop computer, portable or hand-held device), the device must be equipped with an internal or external PC Card Type II or Type III slot. All drivers and supporting software (card and socket services) for the client adapter slot must be loaded and configured.

Ask your system administrator for the following information, which you may need to provide during driver installation:

- Your Wireless Client Name
- Your Wireless SSID
- Your computer's unique client name and workgroup name
- For Windows NT, a free interrupt and I/O address.
- For your network account, your user name and password
- If you are not using a DHCP server, you will only need IP address, gateway address, and subnet mask

After unpacking the card, make sure the following items are present and in good condition:

- Widelink ezWAVE WAP-1100 Series PC Card Adapter
- WAP-1100 Series install software and documentation CD for Windows 98, ME and Windows 2000.

If any item is damaged or missing, contact your PC Card adapter supplier. Save all the shipping and packing material to repack the unit, should service be required.



Caution

Before you start, close all working windows and backup important data.

Chapter 3 Installing the PC/PCI Card Adapter on a Windows OS

This section provides instructions for installing a PC/PCI adapter on a computer using one of the Windows operating systems.



Caution

The following procedures and physical connections apply generally to normal and conventional client adapter slots. In the cases of custom or non-conventional equipment, be alert to possible differences in client adapter slot configurations.

3.1 Installing PC Card Adapter

Before you begin, examine the client adapter. One end is a dual-row, 68-pin client adapter connector. This side will be inserted into the client adapter slot with the logo on the client adapter facing up. The card is keyed so it can be inserted only one way into the slot.

The client adapter can be connected to a client adapter Type II slot. This includes slots that support both Type II and Type III cards.



Caution

Do not force the client adapter into the slot. Forcing it will damage both the client adapter and the slot. If the client adapter does not go in easily, remove the card and reinsert it.

3.1.1 Installing the PC Card Driver for Windows Operating Systems

► Windows 98, ME, 2000

If the operating system on your computer is Windows, follow these steps.

STEP 1

If you insert the ezWAVE software and documentation CD for Windows, the Windows automatically runs ezWAVE setup program and a dialog box appears.

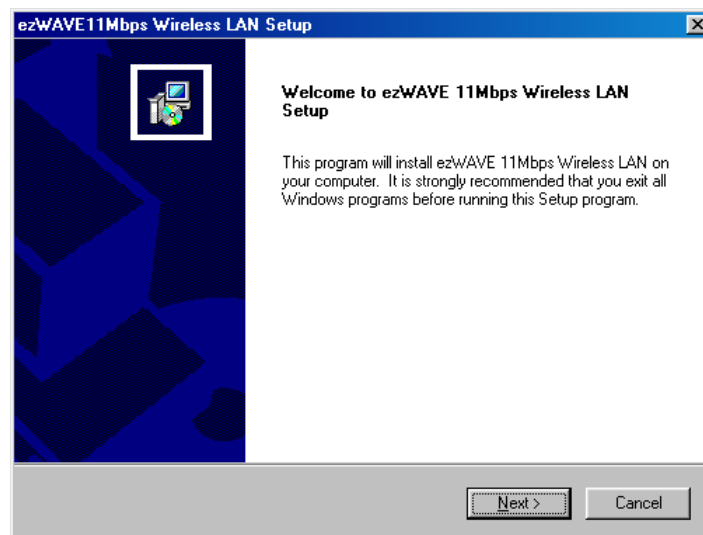

If above dialog box does not appear, select CD-ROM drive, and click “**setup.exe**” file.

STEP 2

Click **N**ext > icon. A License Agreement dialog box appears asking whether you agree with the license or not will appear.

If you agree, click **Y**es icon.

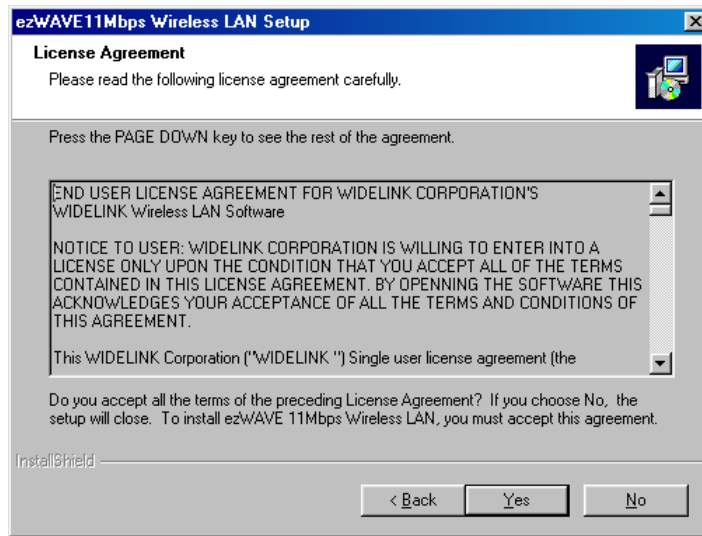

STEP 3

Give a destination folder. To select a different folder click on **Browse** and then click **Next**.

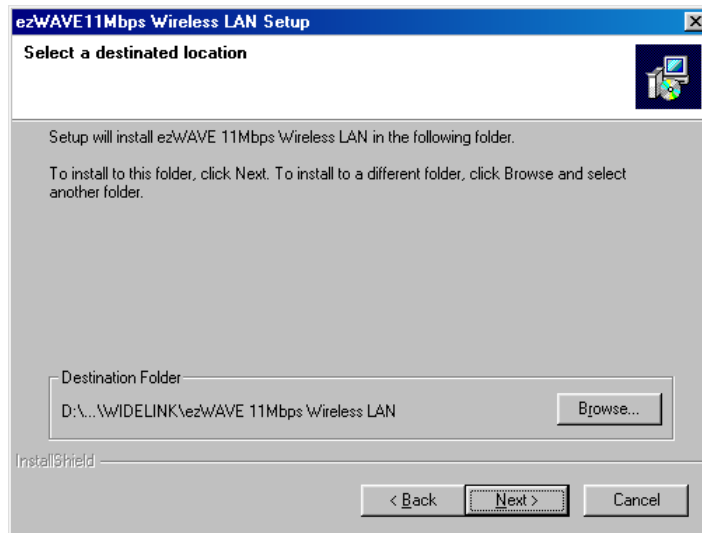

STEP 4

Select the SSID. Default SSID is ANY. You can change this later using the configuration utility or network configuration. Click on **Next**.

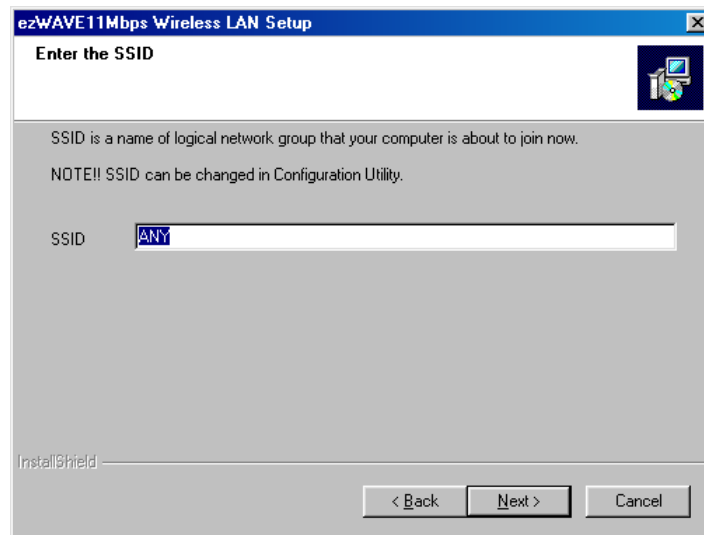

STEP 5

Select network type and click on **Next**. Default is infrastructure.

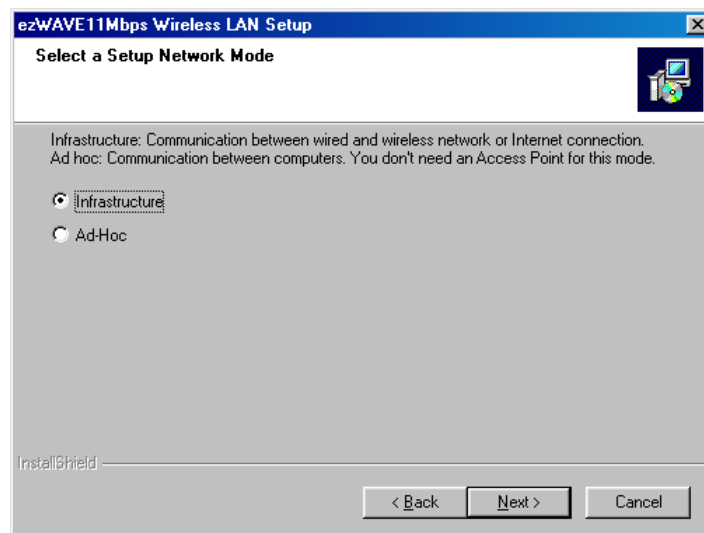

STEP 6

Confirm the current settings; SSID, Network Mode, Utility directory and click on **Next**.

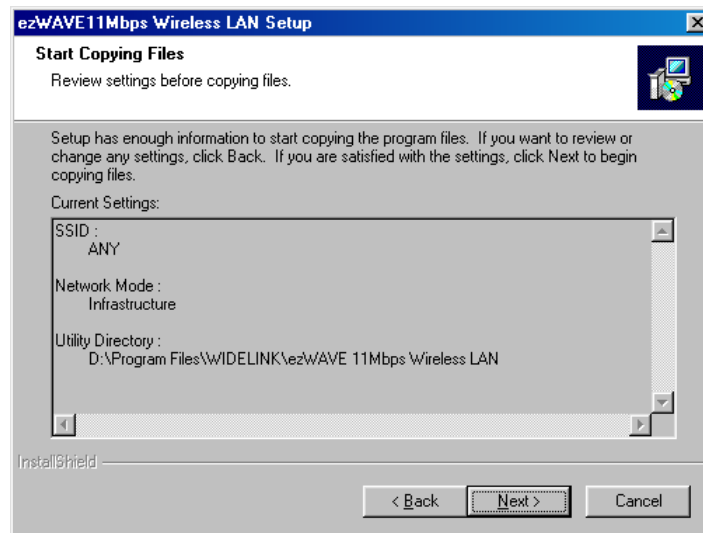
**STEP 7**

It takes a few seconds for copying the utility files and then click on **Finish** to complete the installation.

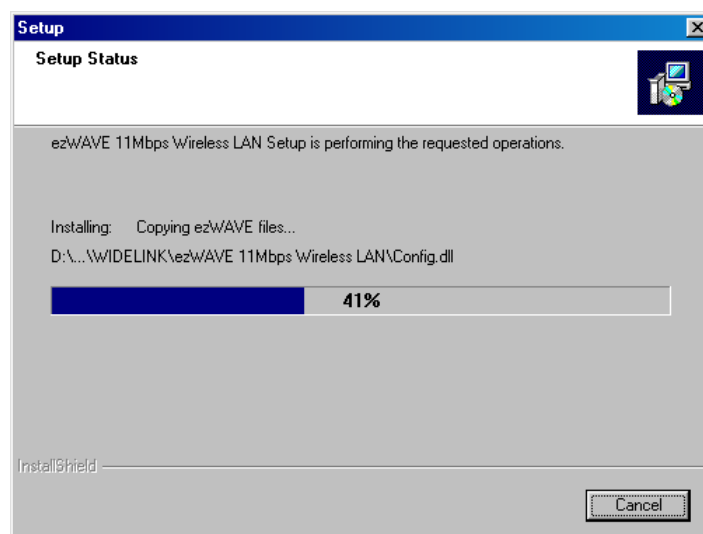

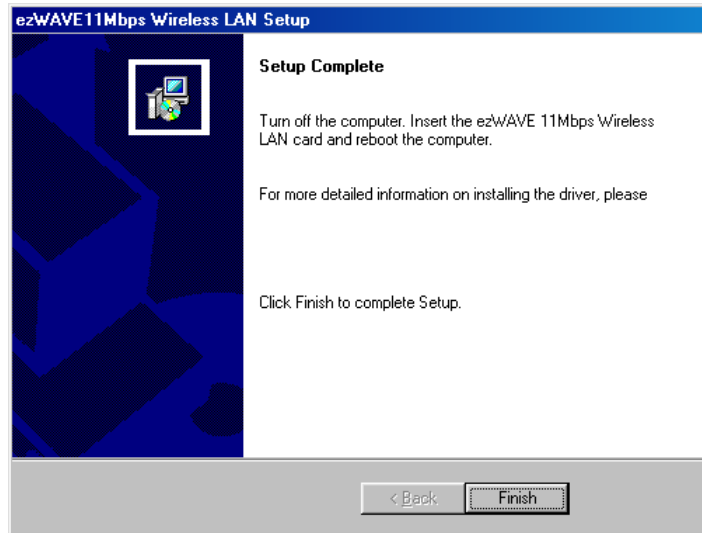

3.1.2 PC Card (PCMCIA) Network Configuration

If you have completed PC card installation, insert the PC card. If you PC detects the PC card, you can find glittering LED and PC sound. Also you will see the PC card icon on the right bottom of your screen.

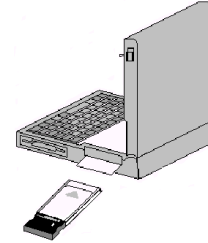

When you install Widelink's wireless LAN card, all the setup process runs automatically. If you reinstall the install program, it asks the positions of "ezWAVE.inf" and cw10.sys. Then you should select same as the below:

File name	Path
ezWAVE.inf	c:\windows\inf
cw10.sys	c:\windows\system

And then the install program asks whether you want to reboot your computer. At this point you should select "No" in order to complete the installation correctly.

Click on **My Computer** icon. Select the Device manager and network adaptors. If you find yellow (?) sign on the adaptor, it indicates that the installation is not successful. Select the adaptor and click on Remove. Restart your computer after uninstalling the driver to make the change effective.

Click on the Network Neighborhood and select properties from the pop-up menu. The network box appears and you see three main tabs; Configuration, Identification, Access control.

Click on the configuration tab and then click on add button. Select network component type box appears. Click on the protocol then click the add button.

Select network protocol box. From the list of manufactures, click on Microsoft. From the list of network protocols, select NetBEUI and click OK.

The NetBEUI protocol is now installed. After click on OK, return back to Network Component Type box.

Repeat this protocol add procedure to add IPX/SPX protocol and TCP/IP protocol.

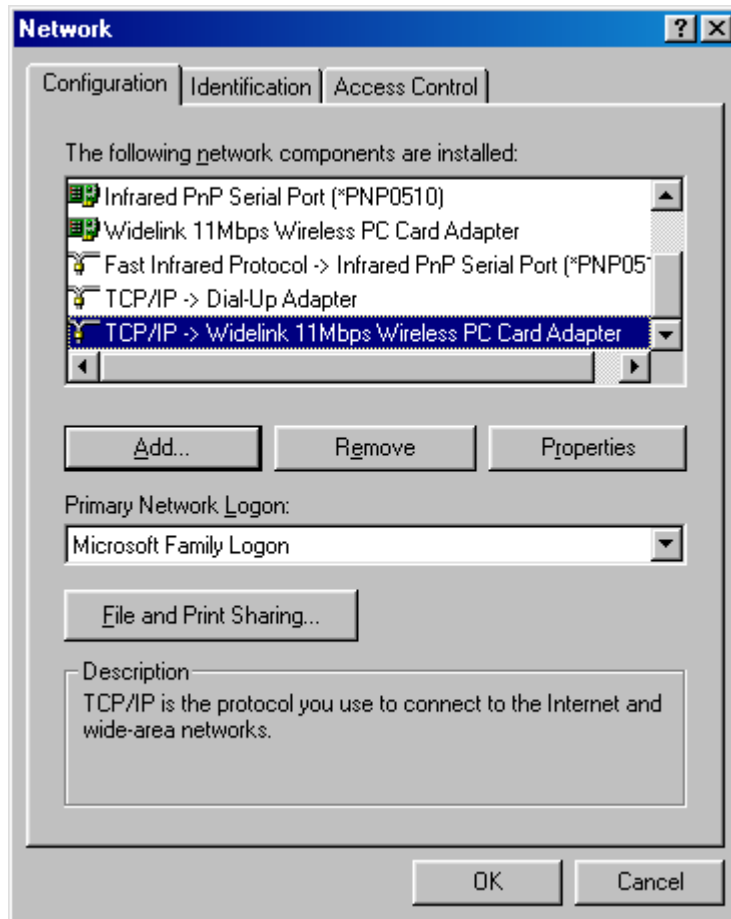
**Caution**

This Process could cause serious problem on your network if you edit wrong data. So, if you do not know how to configure your network option, ask for help from your network administrator.

Click on the TCP/IP option for setting the IP address for your computer. You can select either Static or DHCP setting. If you use static IP address then enter the IP value assigned for you, Subnet masking, DNS, Domain/Workgroup name and Gateway address value.

IP Address

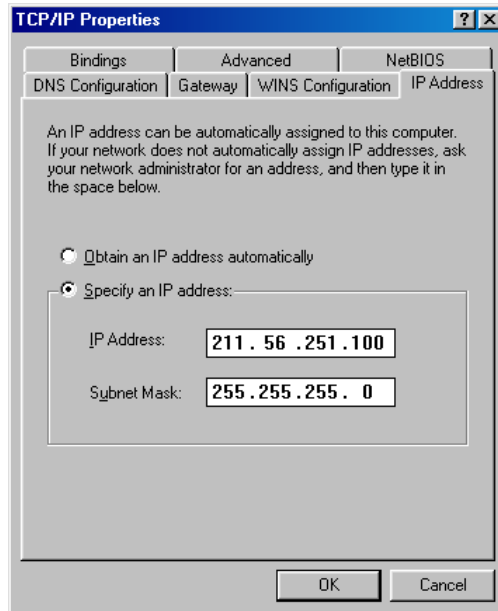

Gateway Address

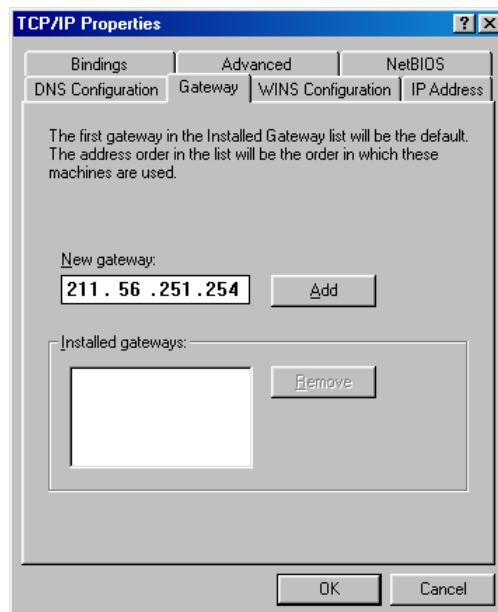

DNS

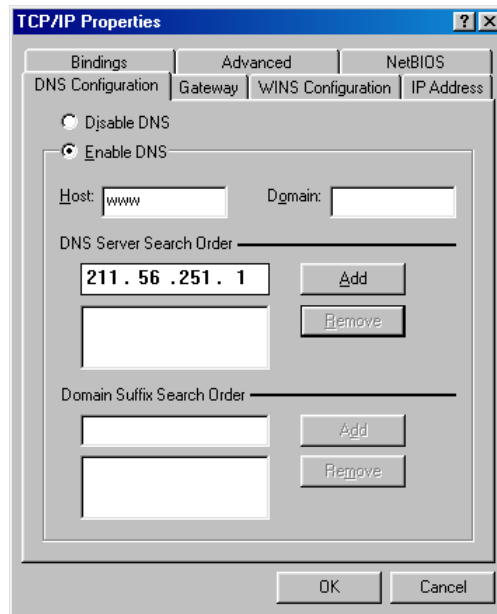

After setting these parameters appropriately, click on OK to return Network Component Type. You can select the File and Printer Sharing options as well as the Access to your computer by other users connected to that network by setting the computer sharing options.

Click on OK.

Screen message "Do you want to restart your computer" will pop up. Select "Yes". It will shut down your computer and restart.

3.1.3 Uninstalling PC Card Software

If you want to uninstall the PC card, click on the control panel. Select the Add/Remove Programs. Click on the Widelink 11Mbps Wireless LAN and click on Add/Remove button. Uninstall Shield removes the software successfully.

And then, click System icon in the control panel and removes the Widelink 11Mbps Wireless PC Card adapter under the Network adapters.

3.1.4 Remove PC Card from PC card socket

If you want to extract PC card from PC card socket, click on PC card information icon. Click on Socket Status window and select Widelink 11Mbps Wireless PC cards adapter and click on Stop button.

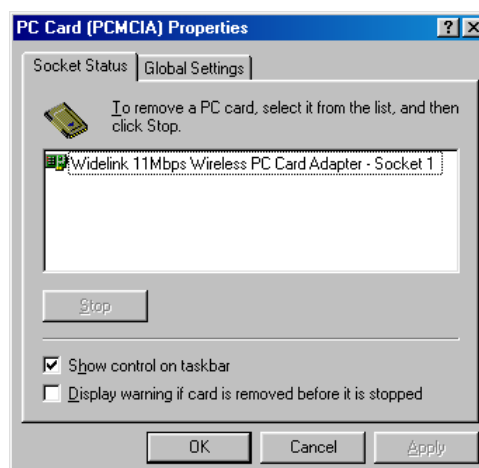

After a few second, screen message "You can remove this device safely" will pop up.



3.1.5 ezWAVE Configuration Utility

ezWAVE install shield program installs wireless LAN driver program and Configuration Utility program. You can see the icon at the right bottom of your screen. Click on that icon will show you the screen as show below.

Wireless Link Status

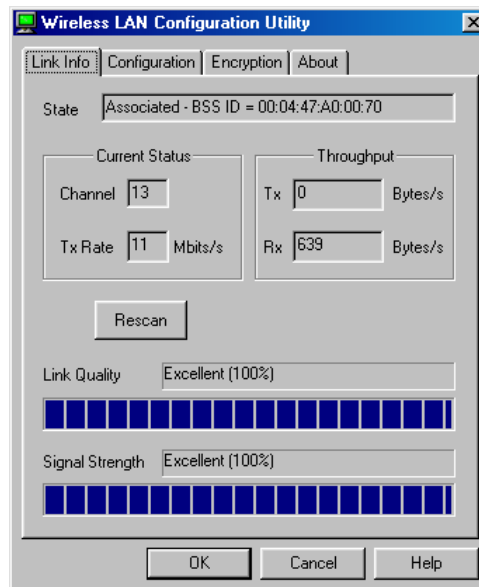

Status shows wireless LAN card's MAC address information.

Current Status shows selected channel number and transmit data rate.

Channel number is the channel available for the communications between the client and AP or between the clients only. In case of the Infrastructure Network Mode, the channel number scanned automatically, while in case of the Ad-hoc Network Mode, the channel number is set by the client and can be changed by the client user.

If you click on **Rescan** button, LAN card program searches other new channel that currently used one.

Throughput (Byte/sec) shows transmission/receiving data rate.

Link Quality shows measured radio link quality. If the link quality is bad, your computer may not communicate with other client computers. Otherwise (fair/good/excellent), there will be no problems in communicating with other clients.

Signal Strength is almost similar to Link Quality information except for a slight difference. Usually, the quality level moves simultaneous with the Link Quality level.

Network Configuration

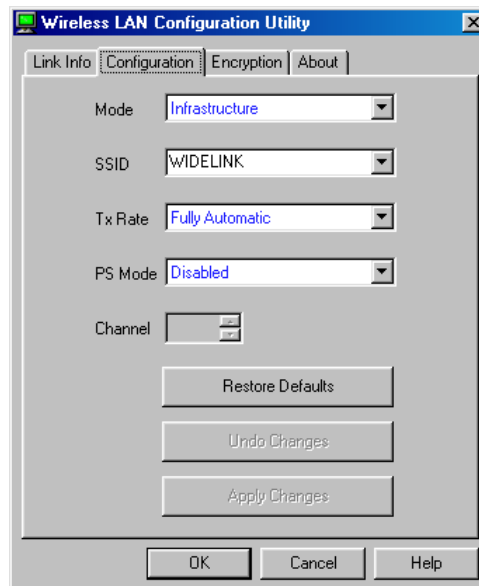

Mode: You can select wireless LAN network mode – Infrastructure or Ad-hoc mode

Infrastructure Mode

This mode is used to set up a connection to a wired Ethernet network. This mode requires an ezWAVE Access Point to gain access to the wired network.

Ad Hoc Mode

This mode is used to set up a small, temporary network between two or more computers. For example, you might set up an ad hoc network between computers in a conference room so users can share information in a meeting.

SSID: The Service Set Identifier (SSID) controls access to a given wireless network. This value MUST match the SSID of any and all ezWAVE Access Points that you want to communicate with. If the value does not match, access to the system is not granted. The SSID can be formed by up to 32 case-sensitive characters.

Tx Rate: The transmission rate at which the data packets are transmitted by the client or AP. You can set this value to 1~2Mbps, 5.5Mbps, 11Mbps or Fully Automatic.

WEP: WEP stands for Wired Equivalent Privacy. WEP is an encryption scheme that provides the secure wireless data communications to the users. WEP uses a 64bit-key or 128bit-key to control the network access. In order to decode the data transmission, each wireless client on the network must use the identical 64bit-key or 128bit-key.

PS Mode: PS stands for Power Saving Mode. Currently, the PS mode is not supported.

After changing the setting in the Configuration change dialog box, click on Apply Changes button. It takes a few seconds to set changes that you made.

Encryption – WEP

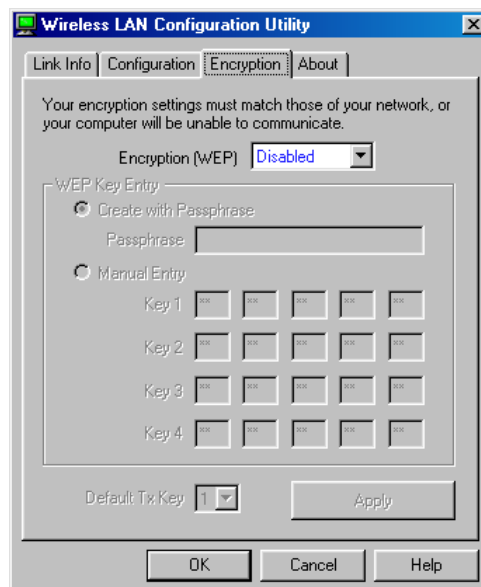

In order to do secure communication over the wireless LAN network, wireless LAN module provides encryption function - WEP. There are two ways to generate WEP key. This key is important in protecting the illegal access to the wireless networks.

If you want to use WEP function, the AP's WEP key value must be set exactly same as your WEP key value. And all the users who want to communicate with you must use the same WEP key value.

You can select WEP key **Disable** in Configuration dialog box, then communication between clients and AP are not secured.

There are two ways to generate the WEP key. One is by entering any text in the Passphrase: And click on Generate button. It will generate four WEP keys; Key 1, Key 2, Key 3, Key 4. You can select any key for the security. If you do not select any key, Key 1 is selected in default.

The other way is by entering Key value directly from the keyboard: Select the Key number and use that Key for accessing the AP. If the Key is not entered correctly, a client cannot access any other client or AP. This Key value protects the illegal access to the wireless network resources. As the wireless channel is more prone to the illegal access, WEP provides the users safe wireless LAN network access.



If you use WEP function, your network throughput degrades (you will experience slow transmission. This case is applied to all different brands of wireless LAN products).

3.2 PCI Card Installation

This section describes the procedures for installing the client adapter.

Before You Start

For the client adapter to be used with a computing device, the device must be equipped with a PCI or ISA expansion slot. Check the documentation that came with your computer for details on the differences between PCI and ISA expansion slots.

Ask your system administrator for the following information, which you may need to provide during driver installation:

- Your Wireless Client Name
- Your Wireless SSID
- Your computer's unique client name and workgroup name
- For Windows NT, a free interrupt and I/O address.
- For your network account, your user name and password
- If you are not using a DHCP server, you will only need IP address, gateway address, and subnet mask.

After unpacking the client adapter, make sure the following items are present and in good condition:

- ezWAVE WWL-1100P Series PCI Client Adapter
- Standard 2 dBi dipole antenna
- WWL-1100P Series software and documentation CD for Windows 98, Windows ME, Windows 2000 when Installing the PCI Client Adapter

If any item is damaged or missing, contact your client adapter supplier. Save all shipping and packing material in order to repack the unit should service be required.

This section provides instructions for installing a client adapter on a computer using one of the Windows operating systems.

Before you begin, examine the client adapter and the antenna connector. LEDs will be

faced out of your computer and be visible when you put the cover back on. The bottom edge of the card is a connector, which you will insert into an empty expansion slot in your computer.

3.2.1 Installing PCI Card Adapter

1. Turn off the computer and all its components.
2. Remove the computer cover.
3. Remove the screw from the top of the CPU back panel above an empty expansion slot. This screw is used to hold the metal bracket on the back panel.
4. Tilt the client adapter to allow the antenna connector and LED lights to slip through the opening in the CPU back panel.
5. Press the client adapter into the empty slot until it is connected firmly.

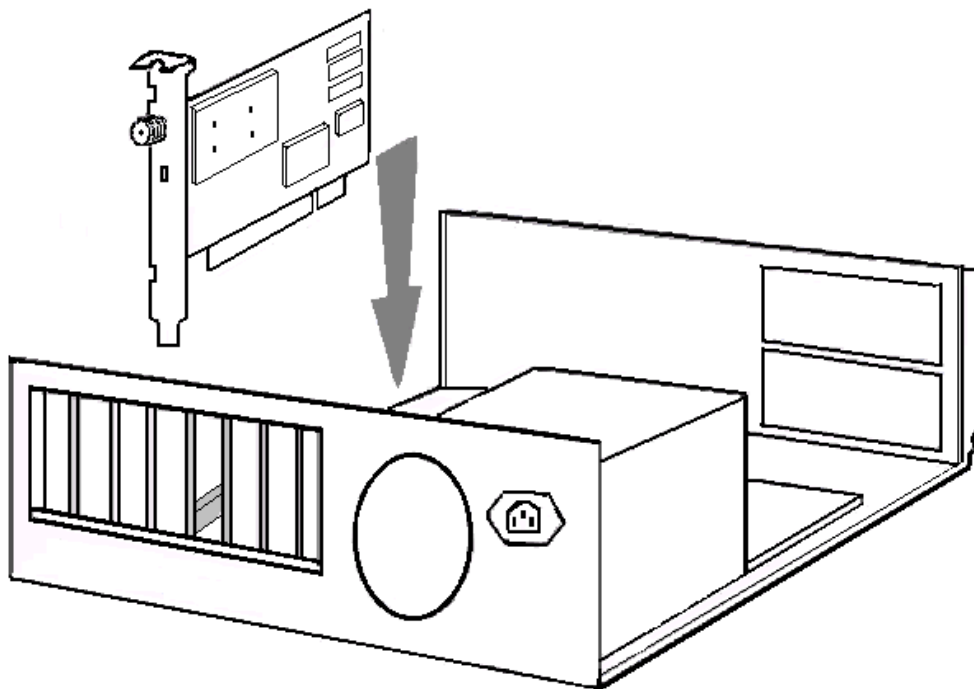

**Caution**

Do not force the client adapter into the slot. Forcing it will damage both the card and the slot. If the card does not go in easily, remove the card and reinsert it.

6. Reinstall the screw to the top of the CPU back panel.
7. The client adapter comes with one 2dBi dipole antenna. With the unit powered off, attach the antenna to the antenna connector on the client adapter.

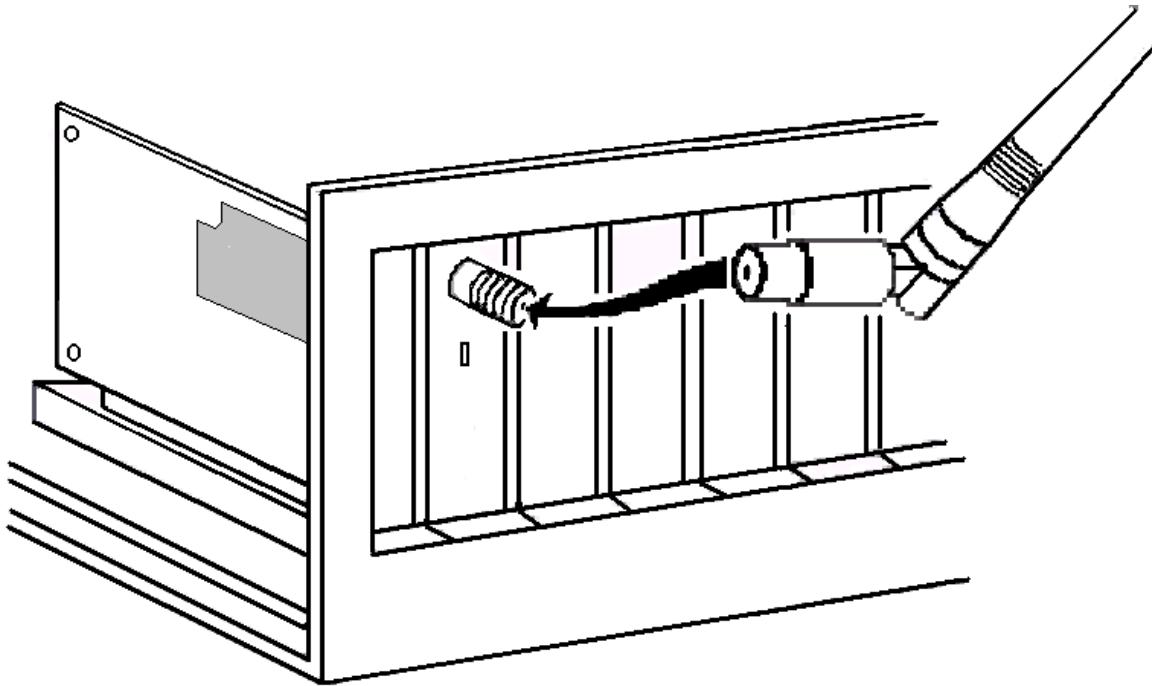
**Caution**

Do not over-tighten the antenna connector; finger-tight is sufficient. Position the antenna vertically for best omni-directional signal reception.

3.2.2 Installing PCI Card Driver

The installation process of PCI card driver program is the same as that of PC card installation. So, you may refer above **3.1.1 Installing the PC Card Driver for Windows Operating Systems**.

3.2.3 PCI Card Network Configuration

The installation process of PCI card driver program is the same as that of PC card installation. So you may refer to the above **3.1.2 PC Card (PCMCIA Card) Network Configuration**

3.3 Troubleshooting

In this chapter, we have listed various problems that you may encounter during the installation. We have also listed possible solutions.

The system tray wireless monitor icon  is always red

- ➔ Change your location or the location of the antenna by a few feet and try again.
- ➔ Make sure the client adapter card is securely inserted in the expansion slot.
- ➔ Make sure the antenna is securely attached.
- ➔ Make sure that your computers SSID have the same one with other clients.
- ➔ Set all clients to the same channel number in case of Ad-hoc network mode.
- ➔ Make sure that you are within the range of an AP. If your computer cannot be associated with any AP, it cannot communicate with other clients.
- ➔ Make sure the antenna is securely attached.

The system tray wireless monitor icon  is always yellow

- ➔ You can communicate with other clients but air link quality is not good so data transferred slowly. In this case, you may move your computer or wireless LAN card antenna to higher position than current state or closer position with AP.

Cannot find wireless monitor icon  in the taskbar

- ➔ Make sure that the PC card is started as automatic in the device applet of the Control panel.
- ➔ Double click on the PC card icon in the Control panel. Click on Widelink adapter and then click on the properties button. It should state that the driver started correctly.
- ➔ Make sure the drivers were installed correctly. If there is some warning or error, uninstall drivers and software through Add/Remove Program. Remove the Wireless LAN card and reinstall the drivers following the manual.

Cannot connect to some computers

- ➔ Make sure that the client computer is within the range of an AP and uses same SSID as you.
- ➔ Make sure that your TCP/IP is set properly and correctly.

Appendix

Appendix A Cell Planning (Radio Range)

This section provides general guidelines on factors that influence network performance.

Cell Site Survey

Because of differences in component configuration, placement and physical environment, every network application is an unique installation. Before installing the system, users should perform a site survey to determine the optimum utilization of network components and to maximize range, coverage and network performance.

Here are some operating and environmental conditions you should consider:

- **Data Rates**

Radio signal sensitivity and range are inversely proportional to data bit rates. The maximum radio range is achieved at the lowest workable data rate. There will be a decrease in receiver threshold sensitivity as the radio data rate increases.

- **Antenna Type and Placement (PCI card only)**

Proper antenna configuration is a critical factor in maximizing radio range. As a general guide, range increases in proportion to antenna height. For a detailed explanation of antenna types and configurations along with guidelines on selecting antennas for specific environments, see the documentation that comes with your antenna.

- **Physical Environments**

Clear or open areas provide better radio range than closed or filled areas. Also, the less cluttered the work environment, the greater the range.

- **Obstructions**

A physical obstruction such as metal shelving or a steel pillar can hinder the performance of the client adapter. Avoid locating the computing device in a location where there is a metal barrier between the sending and receiving antennas.

• Building Materials

Radio penetration is greatly influenced by the building material used in construction. For example, drywall construction allows greater range than concrete blocks. Metal or steel construction is a barrier to radio signals.

Enhancing Coverage

The system architecture options of the wireless station and ezWAVE Access Points provide for a variety of coverage alternatives and flexibility. The system can be designed to provide a wide coverage area with minimal overlap or coverage with heavy overlap. The latter improves system performance and protection against downtime in the event of a component failure. By arranging the ezWAVE Access Points so the overlap in coverage area is minimized, a large area can be covered with minimal system cost. The total bandwidth available to each mobile station will depend on the amount of data each mobile station desires to transfer and the number of stations located in each cell. Seamless roaming is supported as mobile station moves in and out of range of each ezWAVE Access Point, thereby maintaining a constant connection to the wired LAN. Each device in the radio network must be configured with the same Service Set Identifier (SSID) to provide the roaming capability. Multiple systems can operate in the same vicinity. The architecture provides multiple channels, which can coexist in the same area with virtually no interference to each other. In this mode, each system must be configured with different Service Set Identifiers (SSID) and different channels, which prevent clients from roaming to ezWAVE Access Points from a different wireless system.

Appendix B Technical Specifications

Supported Operating Systems

Windows 98, Windows ME, Windows 2000

Radio Specifications

Item	Specification	Description
Radio Type	Direct Sequence Spread-Spectrum (DSSS)	2.4 GHz ISM Band
Operating Frequency	2400-2483.5 MHz	North American, ETSI, and Japan channel coverage, factory configurable
FCC ID		FCC approval
Channeling	5 MHz increments	Programmable for IEEE 802.11b
Type of Modulation	BPSK 1 Mbit/s QPSK 2 Mbit/s CCK 5.5 and 11 Mbits/s	Nominal 10 MHz BW (-6 dB)
Receiver sensitivity	-84 dBm	

Power Requirements

- PC Card

Specification	Value
Operational Voltage	3.3V \pm 0.25V
Receive Mode Current	250 mA (200 mA typically)
High Power Transmit Mode Current	400 mA (370 mA typically)
Sleep Mode Current	30 mA typically

- PCI Card

Specification	Value
Operational Voltage	5.0V \pm 0.25V
Receive Mode Current	250 mA (200 mA typically)
High Power Transmit Mode Current	470 mA (450 mA typically)
Sleep Mode Current	40 mA typically

Physical Specifications

PC Card

Item	Description
Size	114 mm L x 54 mm W x 5 mm H
Enclosure	PC Card Type II
Operating Temperature	-10°C to 50°C (14°F to 122°F)
Connectors	68-pin PCMCIA card
Status Indicators	Green LEDs – link association/activity

PCI Card

Item	Description
Size	149 mm L x 121 mm W x 18 mm H
Operating Temperature	-10°C to 50°C (14°F to 122°F)
Connectors	PCI Card edge
Status Indicators	Green LEDs – link association/activity

Appendix C Channel Allocation

The channel identifiers and the channel center frequencies of each 22-MHz-wide channel are shown in the table below, as appropriate for the various areas or regulatory agencies.

Channel Identifier	Center Frequency	Regulatory Domains				
		North America	ETSI	Spain	France	Korea / Japan
1	2412MHz	√	√	–	–	√
2	2417MHz	√	√	–	–	√
3	2422MHz	√	√	–	–	√
4	2427MHz	√	√	–	–	√
5	2432MHz	√	√	–	–	√
6	2437MHz	√	√	–	–	√
7	2442MHz	√	√	–	–	√
8	2447MHz	√	√	–	–	√
9	2452MHz	√	√	–	–	√
10	2457MHz	√	√	√	√	√
11	2462MHz	√	√	√	√	√
12	2467MHz	–	√	–	√	√
13	2472MHz	–	√	–	√	√
14	2484MHz	–	–	–	–	Japan(√)