



---

**UGD-D00218 Rev A**

**uMAXe  
Installation Guide**

**System Release 9.5**

---





---

## Copyright

© Copyright by **Airspan Networks Inc.**, 2011. All rights reserved worldwide.

The information contained within this document is proprietary and is subject to all relevant copyright, patent and other laws protecting intellectual property, as well as any specific agreements protecting Airspan Networks Inc. rights in the aforesaid information. Neither this document nor the information contained herein may be published, reproduced or disclosed to third parties, in whole or in part, without the express, prior, written permission of Airspan Networks Inc. In addition, any use of this document or the information contained herein for the purposes other than those for which it is disclosed is strictly forbidden.

Airspan Networks Inc. reserves the right, without prior notice or liability, to make changes in equipment design or specifications.

Information supplied by Airspan Networks Inc. is believed to be accurate and reliable. However, no responsibility is assumed by Airspan Networks Inc. for the use thereof nor for the rights of third parties which may be effected in any way by the use of thereof.

Any representation(s) in this document concerning performance of Airspan Networks Inc. product(s) are for informational purposes only and are not warranties of future performance, either expressed or implied. Airspan Networks Inc. standard limited warranty, stated in its sales contract or order confirmation form, is the only warranty offered by Airspan Networks Inc. in relation thereto.

This document may contain flaws, omissions or typesetting errors; no warranty is granted nor liability assumed in relation thereto unless specifically undertaken in Airspan Networks Inc. sales contract or order confirmation. Information contained herein is periodically updated and changes will be incorporated into subsequent editions. If you have encountered an error, please notify Airspan Networks Inc. All specifications are subject to change without prior notice.

Product performance figures quoted within this document are indicative and for information purposes only.



---

## Table of Contents

Copyright .....	2
Table of Contents .....	3
Summary of Figures .....	5
Summary of Tables .....	6
Warnings and Cautions .....	7
Human Exposure to Radio Frequencies .....	7
Radio Interference .....	7
Avoiding Radio Interference .....	7
Modifications .....	7
General .....	7
Safety .....	7
Warning Symbols .....	8
Service Information .....	8
UL Information .....	8
Lightning Protection .....	9
DECLARATION OF CONFORMITY .....	10
FCC Notice .....	11
Federal Communication Commission Notice .....	11
GPS Compliance .....	11
Maximum Output TX Power .....	12
Power Consumption .....	12
Antenna Types .....	12
uMAXe Antenna Usage .....	13
1 About this Guide .....	15
1.1 Purpose .....	15
1.2 Intended Audience .....	15
1.3 Conventions .....	15
1.4 Referenced Documentation .....	15
1.5 Organization of this Guide .....	15
2 Introduction .....	17
2.1 uMAXe .....	17
2.2 uMAXe Frequency Ranges .....	17
2.2.1 Architecture .....	17
3 Getting Started .....	21
3.1 Workflow of Installation .....	21
3.2 uMAXe Installation Checklist .....	21
4 Verify Prerequisites .....	22



## uMAXe Installation Guide



---

4.1	Verify Safety Requirements .....	22
4.1.1	Warning of Hazardous Voltages .....	22
4.2	Verify Installation Requirements .....	23
4.2.1	Verify the Tools .....	23
4.2.2	Verify the Parts and Kits .....	23
4.2.3	Verify Components .....	28
5	Install uMAXe .....	30
5.1	Pole mount configuration .....	30
5.2	Wall mount configuration .....	32
5.2.1	Mounting Example .....	33
5.3	uMAXe Connections .....	33
5.3.1	LED Display .....	34
5.4	Install uMAXe Antennas .....	34
5.4.1	Install Dual Slant Antenna .....	35
5.4.2	Install Omni Antenna .....	37
5.5	Optional Mounting Antenna on uMAXe .....	38
5.6	GPS Antenna Assembly .....	38
5.7	LED Display .....	39
5.8	Install Junction Box (Optional) .....	39
5.8.1	Junction Box Installation .....	40
6	Connect and Manage Cables .....	42
6.1	Assemble Ethernet Connector .....	42
7	Set Power System .....	43
7.1	Power Input - DC .....	43
8	Initial WEB Configuration .....	44
8.1	Initial configuration .....	44
8.1.1	General Config .....	44
8.1.2	SNMP Agent/Trap Configuration .....	45
8.1.3	Mgmt IP Config .....	45
8.1.4	BS Operational State .....	46
9	Appendix A .....	48
9.1	Review Job Sheet .....	48
10	Appendix C – Glossary of Terms .....	49
11	Appendix D – Installation Checklist .....	51
12	Appendix E .....	52
12.1	Revision History .....	52
12.2	Contact Information .....	52

---

---

## Summary of Figures

Figure 1 – uMAXe –network interface .....	18
Figure 2 – each sector connected separately .....	19
Figure 3 – uMAXe Functional Components .....	20
Figure 4 – Workflow of Installation .....	21
Figure 5 - PS – uMAXe.....	25
Figure 6 – uMAXe Base Station Unit, Ethernet termination and RF ports .....	28
Figure 7 – uMAXe Cable Assembly for GPS Antenna .....	29
Figure 8 - Lightning/Surge protector (required) .....	29
Figure 9 - Junction box with pole assembly .....	29
Figure 10 – Pole Mounted uMAXe Assembly.....	30
Figure 11 - pole mounting brackets (shown assembled).....	30
Figure 12 - pole bracket brackets with Rear panel.....	31
Figure 13 - adapters on back.....	31
Figure 14 – Wall mounting uMAXe.....	32
Figure 15 - Wall mount .....	33
Figure 16 - uMAXe connections (bottom).....	34
Figure 17 - uMAXe Antenna Dual Slant Mast Mount Configuration.....	35
Figure 18 - Adjustable Mounting Kit, with Snaplock Stainless Steel Bands.....	36
Figure 19 - Adjustable Mounting Kit, with 'V' Blocks .....	36
Figure 20 - Adjustable Mounting Kit 2, with 'V' Blocks .....	37
Figure 21 - possible Omni antenna array .....	37
Figure 22 - GPS cable assembly prior to mounting.....	38
Figure 23 - Attach GPS antenna to RG58 cable .....	39
Figure 24 - GPS antenna assembled on bracket .....	39
Figure 25 - Junction box with mounting brackets assembled .....	40
Figure 26 - mounting bracket (2 required) .....	40
Figure 27 – Ethernet connector cable termination .....	42
Figure 28 – Ethernet environmental connector assembly .....	42
Figure 29 – DC Power connection.....	43
Figure 30 - Power connector – uMAXe bottom panel .....	43
Figure 31 – General BS Configuration Initial.....	44
Figure 32 - SNMP Initial Configuration .....	45
Figure 33 - Management IP Configuration .....	46
Figure 34 - Operational State .....	47



---

## Summary of Tables

Table 1 - uMAXe FCC Maximum Output TX Power .....	12
Table 2 - uMAXe ETSI Maximum Output TX Power .....	12
Table 3 - Power Consumption .....	12
Table 4 – 1.4 GHz Antenna Types -Technical .....	12
Table 5 - 2.x GHz Antenna Types - Technical .....	13
Table 6 - 3.x GHz Antenna Types - Technical .....	13
Table 7 - Antenna arrays .....	13
Table 8 - uMAXe frequency ranges .....	17
Table 9 - uMAXe installation tools .....	23
Table 10 - uMAXe installation parts and kits .....	23
Table 11 - Input Power for uMAXe .....	25
Table 12 - uMAXe wall mount installation parts .....	26
Table 13 - uMAXe pole mount installation parts.....	26
Table 14 - uMAXe additional parts and kits.....	26
Table 15 - Cavity filter (for 2.3 variant only) .....	26
Table 16 - Junction box (optional) .....	27
Table 17 - uMAXe physical dimensions .....	28
Table 18 - Antenna connection.....	38
Table 19 - LED Display.....	39
Table 19 - Cable hole sizes .....	40
Table 20 - Checklist for Procedure .....	51

---

## Warnings and Cautions

### Human Exposure to Radio Frequencies

The uMAXe antennas should be installed and operated from a minimum distance of 2.4 meters (for 3.x) or 3.4 meters (for 2.x or 1.x) from your body.

### Radio Interference

This uMAXe generates, uses, and can radiate radio frequency energy and, if not installed and used in accordance with the instructions, may cause harmful interference to radio communications. However, there is no guarantee that interference will not occur in a particular installation. If this equipment does cause harmful interference to radio or television reception, which can be determined by turning the equipment on and off, the technician is encouraged to try to correct the interference by performing one or more of the following measures:

- Re-orientate or relocate the antenna
- Increase separation between the BSs and/or End Device
- Connect the equipment to an outlet on a circuit different from that to which the power source is connected

### Avoiding Radio Interference

- The uMAXe must not be co-located or operating in conjunction with any antenna or other transmitter.
- Ensure a minimum of 1-meter separation between co-located antennas of uMAXe units.

### Modifications

Any changes and modifications to this device that are not expressly approved by Airspan Networks may void the user's authority to operate the equipment.

### General

- Only qualified personnel should be allowed to install, replace, and service the equipment.
- The device cannot be sold retail, to the general public or by mail order. It must be sold to operators.
- Installation must be controlled.
- Installation must be performed by licensed professionals.
- Installation requires special training. The uMAXe radio and antenna should be installed **ONLY** by experienced installation professionals who are familiar with local building and safety codes and, wherever applicable, are licensed by the appropriate government regulatory authorities. Failure to do so may void Airspan's WiMAX product warranty and may expose the end user or the service provider to legal and financial liabilities. Airspan and its resellers or distributors are not liable for injury, damage or violation of regulations associated with the installation of outdoor units or antennas.

### Safety

1. Read this User Manual and follow all operating and safety instructions.
2. Keep all product information for future reference.
3. This product is supplied with a grounding power plug. Do not defeat this important safety feature.

4. **Warning:** High voltages exist inside the product - do not remove the lid or base: No user serviceable parts inside.
5. Position the power cord to avoid possible damage; do not overload wall outlets.
6. Do not place this product on or near a direct heat source, and avoid placing objects on the terminal.
7. Do not operate this device near water or in a wet location.
8. Use only a damp cloth for cleaning. Do not use liquid or aerosol cleaners. Disconnect the power before cleaning.
9. The units should not be located near power lines or other electrical power circuits.
10. The radio transceiver must be properly grounded to protect against power surges and accumulated static electricity. It is the user's responsibility to install this device in accordance with the local electrical codes.
11. Installation of the uMAXe must be contracted to a professional installer.
12. Disconnect Device. The socket outlet should be easily accessible in case you have to disconnect the device.
13. When installed in the final configuration, the product must comply with the applicable Safety Standards and regulatory requirements of the country in which it is installed. If necessary, consult with the appropriate regulatory agencies and inspection authorities to ensure compliance.

### Warning Symbols

The following symbols may be encountered during installation or troubleshooting. These warning symbols mean danger. Bodily injury may result if you are not aware of the safety hazards involved in working with electrical equipment and radio transmitters. Familiarize yourself with standard safety practices before continuing.



Electro-Magnetic Radiation



High Voltage

### Service Information

Refer all repairs to qualified service personnel. Do not remove the covers or modify any part of this device, as this will void the warranty.

Disconnect the power to this product and return it for service if the following conditions apply:

- a. The terminal does not function after following the operating instructions outlined in this manual.
- b. Liquid has been spilled, a foreign object is inside, or the terminal has been exposed to rain.
- c. The product has been dropped or the housing is damaged.

Locate the serial number of the terminal, antenna, and transceiver and record these on your registration card for future reference. Use the space below to affix serial number stickers. Also record the MAC address, located on the back of the terminal.

### UL Information

- The equipment must be properly grounded according with NEC and other local safety code requirements.
- Reminder to all the BWA system installers: Attention to Section 820-40 of the NEC which provides guidelines for proper grounding and, in particular, specifies that the cable ground shall



---

be connected to the grounding system of the building, as close to the point of cable entry as is practical.

### Lightning Protection

**WARNING:** The following notes are general recommendations for the system. The wireless equipment should be installed by a qualified professional installer and must follow local and national codes for electrical grounding and safety. Failure to meet safety requirements and/or use of non-standard practices and procedures could result in personal injury and damage to equipment. A direct lightning strike may cause serious damage even if these guidelines are followed.

All outdoor wireless equipment is susceptible to lightning damage from a direct hit or induced current from a near strike. Lightning protection and grounding practices in local and national electrical codes serve to minimize equipment damage, service outages, and serious injury. Reasons for lightning damage are summarized as:

- Poorly grounded tower/antenna sites that can conduct high lightning strike energy into equipment.
- Lack of properly installed lightning protection equipment that can cause equipment failures from lightning induced currents.

A lightning protection system provides a means by which the energy may enter earth without passing through and damaging parts of a structure. A lightning protection system does not prevent lightning from striking; it provides a means for controlling it and preventing damage by providing a low resistance path for the discharge of energy to travel safely to ground. Improperly grounded connections are also a source of noise that can cause sensitive equipment to malfunction.

A good tower grounding system disperses most of the surge energy from a tower strike away from the building and equipment.

To limit the equipment damage due to a lightning strike, the following practices are recommended for the wireless system:

- Provide direct grounding from the antenna mounting bracket, the radio and antenna and the lightning arrestors to the same ground point at the base of the tower or a ground bus on the building. Use the grounding screws on the antenna bracket and the radio and antenna for terminating the ground wires.
- The AC wall outlet ground must be connected to the same grounding system as the BS.

---

## DECLARATION OF CONFORMITY

European Community, Switzerland, Norway, Iceland, and Liechtenstein

Declaration of Conformity with Regard to the R&TTE Directive 1999/5/EC

**English:**

This equipment is in compliance with the essential requirements and other relevant provisions of Directive 1999/5/EC.

**Deutsch:**

Dieses Gerät entspricht den grundlegenden Anforderungen und den weiteren entsprechenden Vorgaben der Richtlinie 1999/5/EU.

**Dansk:**

Dette udstyr er i overensstemmelse med de væsentlige krav og andre relevante bestemmelser i Directiv 1999/5/EF.

**Español:**

Este equipo cumple con los requisitos esenciales así como con otras disposiciones de la Directiva 1999/5/EC.

**Greek:**

ΜΕ ΤΗΝ ΠΑΡΟΥΣΑ Airspan ΔΗΛΩΝΕΙ ΟΤΙ Ο ΕΞΟΠΛΙΣΜΟΣ ΣΥΜΜΟΡΦΩΝΕΤΑΙ ΠΡΟΣ ΤΙΣ ΟΥΣΙΩΔΕΙΣ ΑΠΑΙΤΗΣΕΙΣ ΚΑΙ ΤΙΣ ΛΟΙΠΕΣ ΣΧΕΤΙΚΕΣ ΔΙΑΤΑΞΕΙΣ ΤΗΣ ΟΔΗΓΙΑΣ 1999/5/ΕΚ.

**Français:**

Cet appareil est conforme aux exigences essentielles et aux autres dispositions pertinentes de la Directive 1999/5/EC.

**Íslenska:**

Þessi búnaður samrýmist lögboðnum kröfum og öðrum ákvæðum tilskipunar 1999/5/ESB.

**Italiano:**

Questo apparato é conforme ai requisiti essenziali ed agli altri principi sanciti dalla Direttiva 1999/5/EC.

**Nederlands:**

Deze apparatuur voldoet aan de belangrijkste eisen en andere voorzieningen van richtlijn 1999/5/EC.

**Norsk:**

Dette utstyret er i samsvar med de grunnleggende krav og andre relevante bestemmelser i EU-directiv 1999/5/EC.

**Português:**

Este equipamento satisfaz os requisitos essenciais e outras provisões da Directiva 1999/5/EC.

**Suomalainen:**

Tämä laite täyttää direktiivin 1999/5/EY oleelliset vaatimukset ja on siinä asetettujen muidenkin ehtojen mukainen.

**Svenska:**

Denna utrustning är i överensstämmelse med de väsentliga kraven och andra relevanta bestämmelser i Direktiv 1999/5/EC.

**Român:**

Acest echipament este în conformitate cu cerințele esențiale și alte prevederi relevante ale Directivei 1999/5/CE.

The Declaration of Conformity related to this product can be obtained from [product\\_management@Airspan.com](mailto:product_management@Airspan.com)

---

## FCC Notice

### Federal Communication Commission Notice

This equipment has been tested and found to comply with the limits for a Class A digital device, pursuant to part 15 of the FCC Rules. These limits are designed to provide reasonable protection against harmful interference when the equipment is operated in a commercial environment. This equipment generates, uses, and can radiate radio frequency energy and, if not installed and used in accordance with the instruction manual, may cause harmful interference to radio communications. Operation of this equipment in a residential area is likely to cause harmful interference in which case the user will be required to correct the interference at his/her own expense.

Fixed and base stations transmitting a signal with an emission bandwidth greater than 1 MHz must not exceed an ERP of 1000 watts/MHz and an antenna height of 305 m HAAT, except that antenna heights greater than 305 m HAAT are permitted if power levels are reduced below 1000 watts/MHz ERP.

### GPS Compliance

The GPS is in compliance with the essential requirements and other relevant provisions of Directive 1999/5/EC."

The GPS complies with the following EMC Common Regulatory Testing standards:

- EN55022: Radiated and Conducted Emissions
- CISPR 22: Class B
- EN 50081-1: Generic Emissions Class B
- EN 50082-1: Generic Immunity Class B
- EN 61000-4-2: Electrostatic Discharge Immunity
- EN 61000-4-3: Radiated RF EM Field Immunity Test
- EN 61000-4-4: Electrical Fast Transient/Burst Test
- EN 61000-4-6: Conducted Immunity
- EN 61000-4-8: Magnetic Field Immunity



**Note:** A GPS is required for synchronizing between TDD sectors.



**Note:** A GPS Lightning/Surge protector is required. (ordered separately)

---

## Maximum Output TX Power

**Table 1 - uMAXe FCC Maximum Output TX Power**

Frequency Band	FCC		Antenna Gain
	TX	EIRP	
1.4 GHz	33dBm	pending	pending
2.3 GHz	36.12dBm	54.12dBm	18dBi
3.65 GHz	36.08dBm	38.08dBm	2dBi

**Table 2 - uMAXe ETSI Maximum Output TX Power**

Frequency Band	ETSI		Rest of the World		Antenna Gain
	TX	EIRP	TX	EIRP	
2290-2350 MHz	36dBm	54dBm	36dBm	54dBm	18dBi
3650-3700 MHz	36dBm	38dBm	36dBm	38dBm	2dBi



**Caution:** Do not set maximum output TX power to higher than local regulations.

Under Industry Canada regulations, this radio transmitter may only operate using an antenna of a type and maximum (or lesser) gain approved for the transmitter by Industry Canada. To reduce potential radio interference to other users, the antenna type and its gain should be so chosen that the equivalent isotropically radiated power (e.i.r.p.) is not more than that necessary for successful communication.

This radio transmitter **uMAXe 3600 3.62-3.7GHz** has been approved by Industry Canada to operate with the antenna types listed below with the maximum permissible gain and required antenna impedance for each antenna type indicated. Antenna types not included in this list, having a gain greater than the maximum gain indicated for that type, are strictly prohibited for use with this device.

This device complies with Industry Canada Standard RSS-197. Operation is subject to the following two conditions: (1) this device may not cause interference, and (2) this device must accept any interference that may cause undesired operation of the device.

## Power Consumption

**Table 3 - Power Consumption**

uMAXe	Watts
3.x	230 Max
2.x	370 Max
1.4	370 Max

## Antenna Types

**Table 4 – 1.4 GHz Antenna Types -Technical**

Type	Frequency range	Gain	Part number
60° 13.5 dBi Dual X-Polar	pending	pending	pending
90° 12.5 dBi Dual X-Polar	pending	pending	pending
OMNI Directional	pending	pending	pending

OMNI Directional	pending	pending	pending
------------------	---------	---------	---------

**Table 5 - 2.x GHz Antenna Types - Technical**

Type	Frequency range	Gain	Part number
60° Dual Slant X-Polar	2.3-2.7 GHz	18.0 dBi	SEC60X-2.X-RC-1
90° Dual Slant X-Polar	2.3-2.7 GHz	17.0 dBi	SEC90X-2.X-RC-1
Omni 10dBi Vertical External	2.3-2.49 GHz	10 dBi	ANT2300OV10-360

**Table 6 - 3.x GHz Antenna Types - Technical**

Type	Frequency range	Gain	Part number
60° Dual Slant X-Polar	3.3 - 3.8 GHz	18.0 dBi	SEC60X-3.5-RC-1
90° Dual Slant X-Polar	3.3-3.8 GHz	17.0 dBi	SEC90X-3.5-RC-1
Omni- directional Vertical Sector	3.3 – 3.5 GHz	10.0 dBi	OMNIV-3.4-RC-2
Omni- directional Vertical Sector	3.3 – 3.72 GHz	10.0 dBi	OMNIV-3.5-RC-1
Omni- directional Vertical Sector	3.4 – 3.6 GHz	10.0 dBi	OMNIV-3.5-RC-2
Omni- directional Vertical Sector	3.6 – 3.8 GHz	10.0 dBi	OMNIV-3.7-RC-2
Blade Antenna	3.6-4.0 GHz	2.0 dBi	SBA-3800-D1/1040

### uMAXe Antenna Usage

uMAXe has two (2) RF ports that can be connected to either:

- A single 2-port antenna
- Two single-port antennas



**Note:** Appropriate mounting kit (included) for the dual port and omni antennas are required.

- Dual slant cross polarized (X-Pol) antenna with two (2) ports - connected via 2 RF jumper cables to uMAXe.
- Omni antennas – for 360 degree coverage using a single uMAXe - requires an Omni antenna for each receiver – 2 Omni antennas.



**Note:** The Omni antennas must be separated – with at least one meter separation from each other.

The following table describes different antenna arrays when using either two (2) receivers:

**Table 7 - Antenna arrays**

Frequency Band	# of Receivers	Sector	Antenna Type	# of Antennas
1.4 GHz	2	60°	1390-1435 MHz 60° 13.5 dBi Dual X-Polar - mounting included - pending	1
2.3 GHz	2	60°	2.3-2.7 GHz 60° Dual Slant X-Polar Antenna - mounting included	1



## uMAXe Installation Guide



3.65 GHz	2	60°	3.3-3.8 GHz 60° Dual Slant X-Polar -4° tilt - mounting included	1
3.65 GHz	2	60°	3.3-3.8 GHz 60° Dual Slant X-Polar 0° tilt - mounting included	1
1.4 GHz	2	90°	1390-1435 MHz 90° 12.5 dBi Dual X-Polar - mounting included - pending	1
2.3 GHz	2	90°	2.3-2.7 GHz 90° Dual Slant X-Polar - mounting included	1
3.65 GHz	2	90°	3.3-3.8 GHz 90° Dual Slant X-Polar -4° tilt - mounting included	1
3.65 GHz	2	90°	3.3-3.8 GHz 90° Dual Slant X-Polar 0° tilt - mounting included	1
1.4 GHz	2	360°	1390-1435 MHz Omni 5dB/7dBi Vertical External Antenna - pending	2
2.3 GHz	2	360°	2.3-2.9 GHz Omni 10 dBi Vertical External Antenna	2
3.65 GHz	2	360°	3.6-3.8 GHz Omni Reg Compl Vertical Sector	2

## 1 About this Guide

This section discusses the purpose, intended audience, conventions, referenced documentation and organization for this guide.

### 1.1 Purpose

This guide provides the workflow and step-by-step procedures for installing the uMAXe. These procedures include:






- Verify Prerequisites
- Install the uMAXe
- Connect and Manage Cables
- Set Power System

### 1.2 Intended Audience

This guide is intended for persons who are responsible for installing the uMAXe. These persons should have a working knowledge of the WiMAX system.

### 1.3 Conventions

This document uses the following informational conventions.

Icon	Description
	<b>Checkpoint:</b> Marks a point in the workflow where there may be an exit or branch to some other procedure. At each <b>Checkpoint</b> the reason for an exit or branch is given along with specific directions to locate the entry point in the other procedure.
	<b>Reference:</b> Gives a resource in the workflow that may be needed to complete a procedure along with specific directions to use the resource.
	<b>Caution:</b> Describes a possible risk and how to lessen or avoid the risk.
	<b>Advice:</b> Provides a recommendation based on best practice.
	<b>Note:</b> Provides useful information.

### 1.4 Referenced Documentation

- uMAXe Product Description

### 1.5 Organization of this Guide

This guide is organized into the following Sections:

- About this Guide
- Introduction
- Get Started
- Verify Prerequisites
- Install the uMAXe
- Connect and Manage Cables



## uMAXe Installation Guide



- 
- Set Power System
  - Appendixes [Review Job Sheet, Securing the cables, Glossary of Terms, Installation Checklist, Contact information and Revision history]



## 2 Introduction

This section provides a descriptive overview of the uMAXe and its place in the product suite.

### 2.1 uMAXe

uMAXe is a highly integrated macro-cell base station with all-in-one packaging of RF and baseband components. uMAXe includes integrated dual RF transceivers to support dual channel diversity and MIMO. It is available as an all outdoor solution for Mobile WiMAX applications to minimize physical footprint and operator OPEX.

uMAXe fully supports the interoperable R6 reference point for interworking with ASN Gateways. uMAXe also has a “Stand Alone” mode for fixed/nomadic applications which do not require seamless handover. When uMAXe is used in “Stand Alone” mode there is no need for an ASN Gateway. uMAXe supports IP CS and Ethernet CS. It even supports a hybrid mode where both IP CS and Ethernet CS (including VLAN support) are supported. uMAXe implements dual 40dBm (10W) transmitters in 2.x GHz, dual 38 dBm (6.3W) in 1.4 GHz and dual 37dBm (5W) transmitters in 3.x GHz band.

uMAXe is an outdoor radio that is mounted outside on a pole or wall. uMAXe is available in numerous frequency bands and in numerous channels see: [uMAXe Frequency Ranges](#). uMAXe is managed by an SNMP-based network management system (Netspan) using standard and proprietary MIBs. Basic preliminary management can be performed using any standard Web browser.



**Note:** For management refer to uMAXe Commissioning documentation.

### 2.2 uMAXe Frequency Ranges

The table below lists the frequency range of uMAXe variants currently available. This table will grow as more variants become available.

**Table 8 - uMAXe frequency ranges**

Band	Variant	Lower Frequency	Upper Frequency	Channel Bandwidth	Duplex
<b>1.4 GHz (pending)</b>	1400	1390 MHz	1435 MHz	➤ 3.5MHz	TDD
				➤ 5MHz	
				➤ 7MHz	
				➤ 10MHz	
<b>2.3 GHz WCS</b>	WCS	2315 MHz	2320 MHz	➤ 3.5MHz @ 2316.75	TDD
		2345 MHz	2350 MHz	➤ 3.5MHz @ 2348.25	
<b>3.65 GHz</b>	3600	3600 MHz	3700 MHz	➤ 3.5MHz	TDD
				➤ 5MHz	
				➤ 7MHz	
				➤ 10MHz	

#### 2.2.1 Architecture

A highly flexible and scalable WiMAX Base Station, the uMAXe is capable of supporting Mobile WiMAX profiles across multiple frequency bands.



**Note:** The following is for illustration only; actual layout may differ as infrastructure is installation-specific.

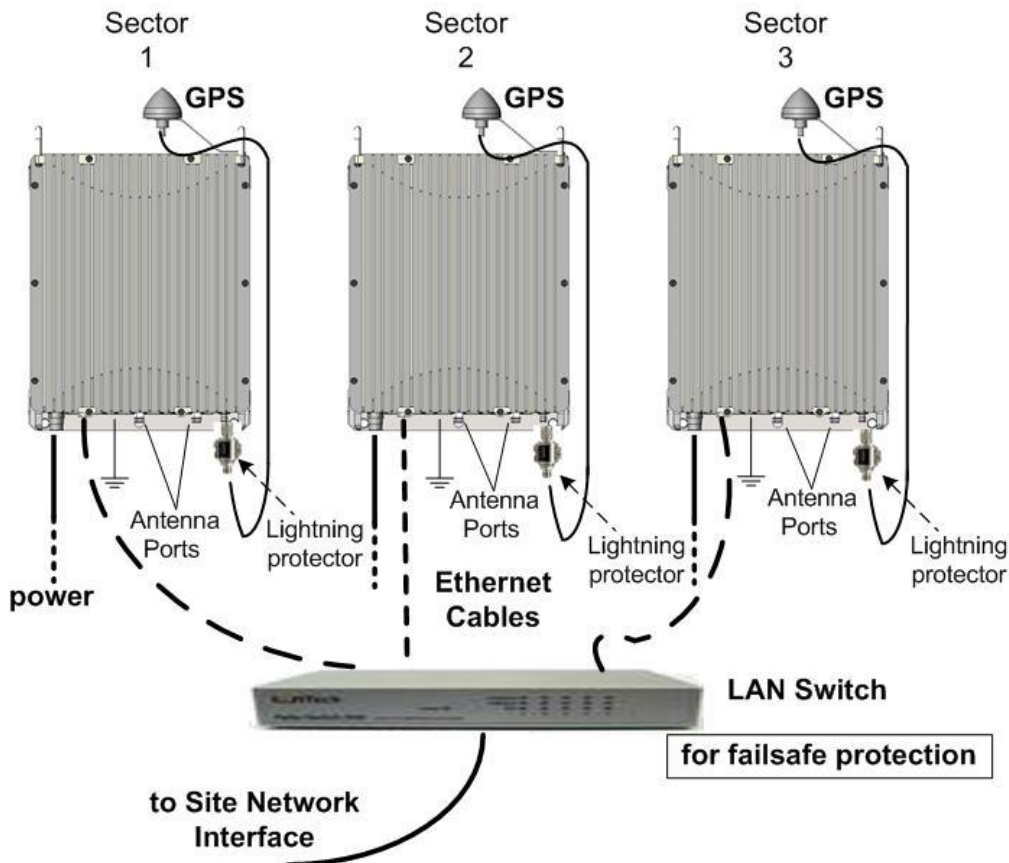


**Note:** uMAXe must be properly grounded according with NEC and other local safety code requirements.



**Note:** Installation of the GPS Lightning/Surge protector (ordered separately) is necessary to protect the GPS antenna.

Examples of three (3) sectors are illustrated below:



**Figure 1 – uMAXe –network interface**

An alternative architecture, where each sector is connected separately to the backhaul/backbone solution, therefore avoiding a single point of failure, as shown below:

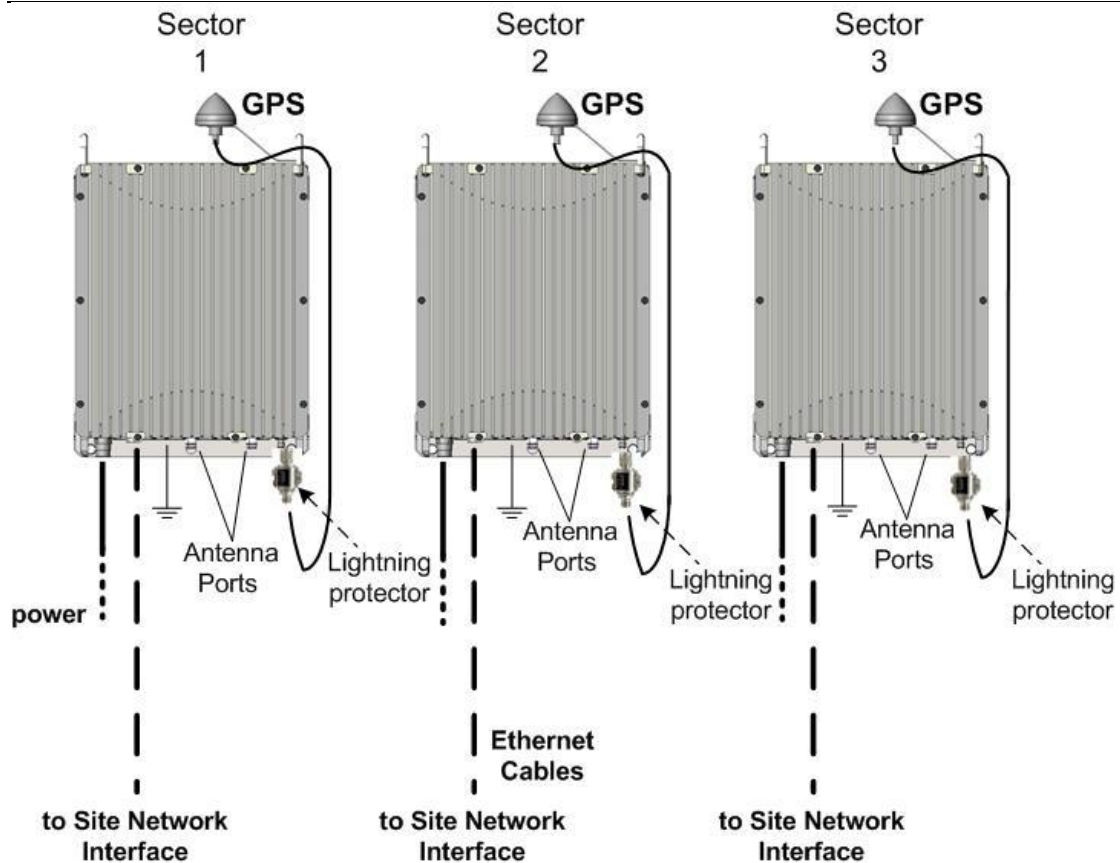


Figure 2 – each sector connected separately



**Note:** uMAXe can also be connected via a LAN Switch for greater Failsafe protection.



**Note:** Auto-negotiation must always be enabled on the core network side.



**Note:** Illustrations above displays the GPS mounted directly to the top of the units there is also an option to mount the GPS antennae remotely.

The uMAXe is a fully integrated all outdoor base station sector that contains all RF, Baseband and GPS Synchronization functionality. In one box it comprises the following functional elements:

- Dual Receiver / Dual Transmitter
- SDR Card
- GPS

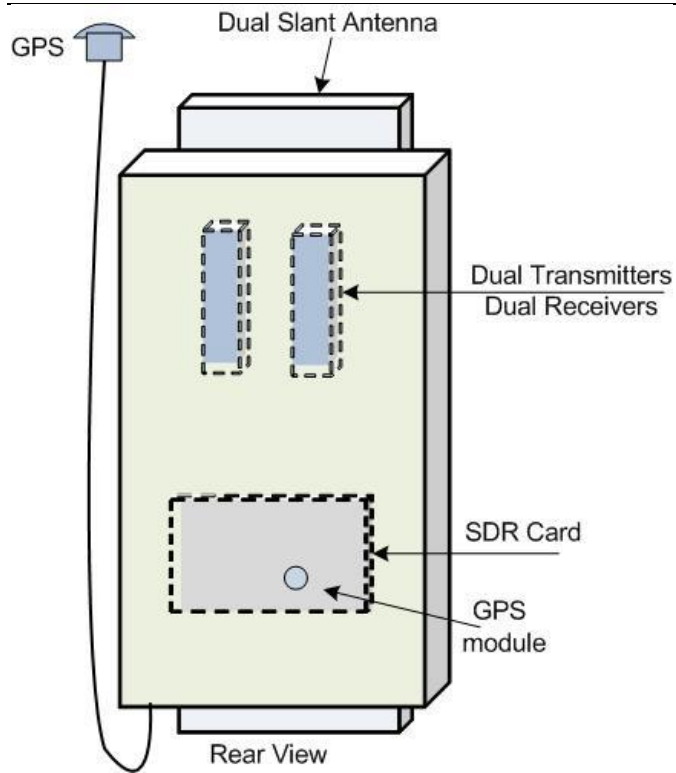


Figure 3 – uMAXe Functional Components

### 3 Getting Started

#### 3.1 Workflow of Installation

The Workflow to install the uMAXe is shown in the following diagram:

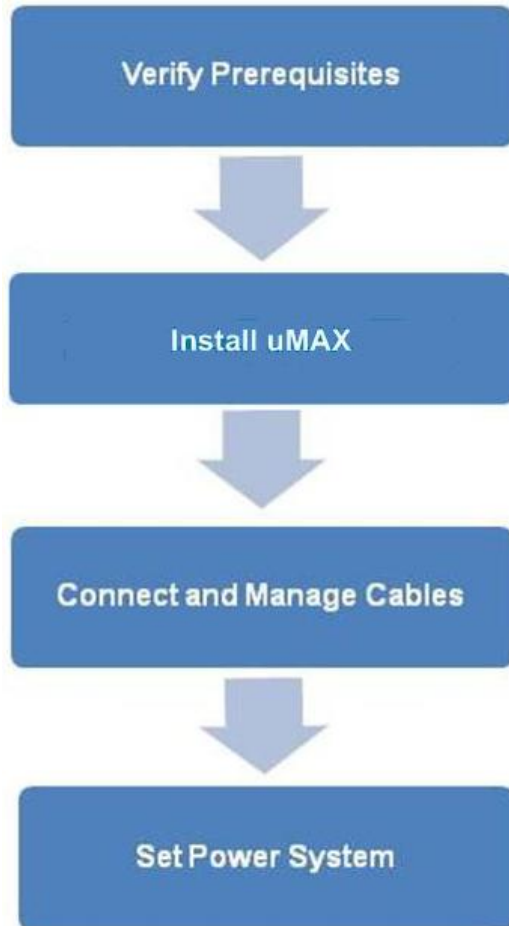


Figure 4 – Workflow of Installation



**Caution:** Antennas 1 & 2 Tx/Rx must be connected and attached before uMAXe is powered on.

#### 3.2 uMAXe Installation Checklist

Plan the installation of the uMAXe by using the Installation Checklist, which you can find as a removable job aid in [Appendix A](#) for this guide.

---

## 4 Verify Prerequisites

Prior to installing the uMAXe, verify the required safety, power, tools, parts and components.



**Reference:** Set up requirements for the installation is detailed in the *Job Sheet*, see [Appendix A](#) for this guide.

---

### 4.1 Verify Safety Requirements

Read and follow all warning notices and instructions marked on the product or included in this manual.

When installed in the final configuration, the product must comply with the applicable Safety Standards and regulatory requirements of the country in which it is installed. If necessary, consult with the appropriate regulatory agencies and inspection authorities to ensure compliance.

Ascertain the radiation hazards when working in an environment close to other antennas and Electromagnetic fields, e.g. working on towers with other microwave transmitters etc. and act accordingly.

#### 4.1.1 Warning of Hazardous Voltages

On AC installations, hazardous voltages exist. Use caution when verifying or working with AC power. Remove metal jewelry that could come into contact with AC power.

On DC sections, short circuiting the low voltage, low impedance circuits can cause severe arcing that may result in burns or eye damage. Remove rings, watches etc. to avoid shorting DC circuits.



**Note:** Airspan products do not contain hazardous substances (as defined in UK Control of Substances Hazardous to Health Regulations 1989 and the Dangerous Substances Regulations 1990). At the end of any Airspan products life cycle, the customer should consult with Airspan to ensure that the product is disposed of in conformance with the relevant regulatory requirements.

---



**Caution:** Any modifications to this device not expressly authorized by the manufacturer could void the user's authority to operate this device.

---

## 4.2 Verify Installation Requirements

### 4.2.1 Verify the Tools

**Table 9 - uMAXe installation tools**

Tool
Large Crosshead Screw driver Phillips # 3 or Pozidrive # 3
Small flat blade screwdriver
Medium flat blade screwdriver
13mm or 1/2 inch open ended spanner
10mm or 13/32 inch open ended spanner
Wire strippers
Wire cutters
Ring terminals crimp tool
RJ45 crimp tool

### 4.2.2 Verify the Parts and Kits

**Table 10 - uMAXe installation parts and kits**

UMAXE Base Station parts	Consisting of
1 x uMAXe unit	Base station unit
1 x RJ45 Weatherproof Connector Covers	Weatherproof connector covers for use with standard cat 5 RJ45 network connections.
1 x mains cable 14AWG x2 (ordered separately)	30 meter lead with M17 3 pole plug
When distance from outdoor Power supply to Base Station is <b>over</b> 30 meters additional power cable must be connected via a junction box (ordered separately) for total distance of up to 130 meters.	
	14AWG x2 (ordered separately) – up to 40 meters
	12AWG x6 (ordered separately) – up to 100 meters
1 x Ethernet RJ45 environmental shroud	LTW IP68 or Amphenol environmental connector
Filter (Cavity filter) Kit (for 2.3 GHz variant <b>only</b> )	2 x Cavity Filters – 141-00-148 4 x antenna cables – 689-000-47



## uMAXe Installation Guide



UMAXE Base Station parts	Consisting of
Wall mounting kit (ordered separately)	1 x Rear panel – PN 402-00-118 1 x Top adaptor – PN 402-00-119 1 x Bottom adaptor – PN 402-00-120 2 x Screw M12x180 DIN 933 – PN 501-02-034 4 x Spring washer M12 DIN 127B – PN 501-04-007 4 x Flat washer M12 DIN 125 – PN 501-04-006 2 x Nut M12 DIN 934 – PN 501-03-003 4 x SEMS screw M8x20 with 2 washers – PN 501-05-011
Pole mounting kit Dia.60 – 120mm – plus fixing accessories. (ordered separately)	1 x Rear panel – PN 402-00-118 1 x Top adaptor – PN 402-00-119 1 x Bottom adaptor – PN 402-00-120 2 x Screw M12x180 DIN 933 – PN 501-02-034 4 x Spring washer M12 DIN 127B – PN 501-04-007 4 x Flat washer M12 DIN 125 – PN 501-04-006 2 x Nut M12 DIN 934 – PN 501-03-003 8 x SEMS screw M8x20 with 2 washers – PN 501-05-011 2 x Pole bracket for 60-120mm pole – PN 402-00-121
1 x earth kit	1 x M5 screws 1 x M5 washers 1 x M5 spring washers Alternative: SEMS screw (includes 2 washers)
GPS antenna & accessories (each ordered separately)	<p>1x GPS Antenna. An active GPS antenna which, by using the appropriate mounting bracket, can be used with uMAXe for network synchronization.</p> <p>For mounting directly to the top of uMAXe, this GPS Antenna should be used in conjunction with uMAXe GPS Antenna mounting bracket w/Handle pre-assembled on the UMAXE and the 80cm GPS Cable RG58 TNC-TNC.</p> <p>When mounting remotely from the base station unit, this antenna should be used in conjunction with the Remote GPS Antenna Mounting Bracket (GPS-MNT-1) and the 16m GPS Cable RG58 TNC-TNC.</p> <p>80cm or 16m Cable Assembly - 80cm (CBL-GPS-TNC-0.8-1) or 16m (CBL-GPS-TNC-16-1) RG58 cable. 16m connects remote mounted GPS Antenna (GPS-ANT-1) to the UMAXE via TNC connectors. The 80cm, cable for mounting GPS directly to the top of UMAXE.</p>
GPS Lightning/Storm protector (ordered separately)	1x Lightning/Storm protector (required)
AC/DC Power Supply (PS)	Indoor power converter for 1.4 GHz
	Indoor power converter for 2.x GHz

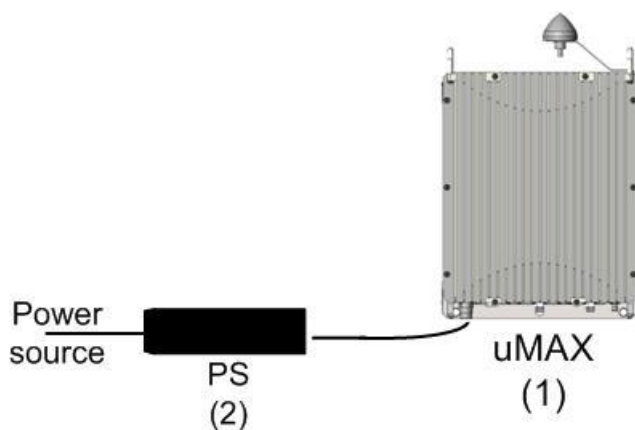


UMAXe Base Station parts	Consisting of
	Outdoor power converter for 3.x GHz
Type-IC DC Power Cable	Available either in - 10, 15 or 30 meter lengths. Additional lengths available.
Multimode fiber pigtail cable (not included) (optional) (ordered separately)	Multimode fiber pigtail cable – ODC - LC connector. Terminates the outdoor fiber cable and provides an indoor LC connector. 2 meter length.
Grounding Cable (required) (not included)	Circular earth braid, 120A current (16 mm <sup>2</sup> ), jacketed or not with cable size = AWG 4 – 6 with lug (terminal) on enclosure side with hole M6

The uMAXe power supply (PS) can be installed with various cable lengths according to the site requirements. The cable lengths are determined by the length of the run between the PS and the uMAXe. Use the following table to determine the required power supply output to ensure proper operation of the uMAXe.

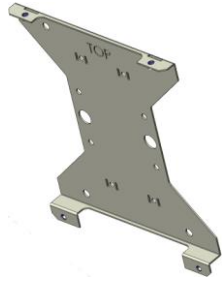



**Table 11 - Input Power for uMAXe**

	uMAXe 2x10 (2.3-2.7 GHz) & uMAXe 1.4 (1390-1435 MHz)	uMAXe 3x05 (3.3-3.38 GHz)
Input Voltage to uMAXe (1)	-38 VDC to -60 VDC	-38 VDC to -60 VDC
PS output Voltage – 30 meter cable (2)	-42 VDC min	-41 VDC min
PS output Voltage – 75 meter cable (2)	-50 VDC min	-46 VDC min
PS output Voltage – 100 meter cable (2)	-53 VDC min	-49 VDC min


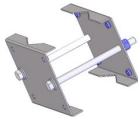


**Figure 5 - PS – uMAXe**

**Table 12 - uMAXe wall mount installation parts**

Parts		Images
1	Rear panel	
1	Top adapter	
3	Bottom adapter	
4	GPS Antenna mounting bracket (shown with GPS attached) (pre-assembled)	


**Table 13 - uMAXe pole mount installation parts**

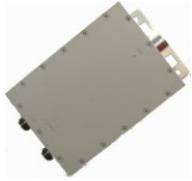

Parts		Images
 <b>Note:</b> in addition to the Wall mounting kit.		
2	Pole bracket for 60 > 120 MM (shown assembled)	

**Table 14 - uMAXe additional parts and kits**






Additional Common Accessories (not provided by Airspan)
Spare RJ45 connectors
Cable ties
Ring terminal for earth strap. M5 / M6
Earth strap cable (4-6 mm) (yellow and green cable)
Weatherproof / Outdoor mains cable splice kit or termination box.


**Table 15 - Cavity filter (for 2.3 variant only)**

Parts	Images
 <b>Note:</b> the exact filter might appear different than shown.	

Parts		Images
2	Filter (Cavity filter) (for 2.3 variant <b>only</b> ) + 4 x antenna cables	
4	4x pole bands (stainless steel), as required according to on site pole size, (not included)	

**Table 16 - Junction box (optional)**

Optional Junction Box	Consisting of
1 x Junction box (ordered separately)	Junction box
1 x PG11 Weatherproof gland (connector), included with junction box	Weatherproof connector 
1 x PG16 Weatherproof gland (connector) , included with junction box	Weatherproof connector 
1 x PG29 Weatherproof gland (connector) , included with junction box	Weatherproof connector 
Additional power cable	14AWG x2 (ordered separately) – up to 40 meters
	12AWG x6 (ordered separately) – up to 100 meters
2x mounting bracket(s) for pole and wall mounting	Bracket (x2) 
2x pole bands (stainless steel), as required, supplied.	52 – 76 mm (3") 

Optional Junction Box	Consisting of
2x pole bands (stainless steel), as required, supplied.	78 – 102 mm (4") 
Mounting screws – for mounting brackets to junction box.	EJOT WN1412 – K50 x 12 – 4 supplied.
Wall mounting fasteners	Hole size = 7 mm
Sufficient cable wires ties, as required	(not supplied - customer responsibility)

### 4.2.3 Verify Components

uMAXe is shown below from the Ethernet termination and RF port end views respectively.



**Figure 6 – uMAXe Base Station Unit, Ethernet termination and RF ports**

#### 4.2.3.1 Physical Dimensions

uMAXe BS is in an all outdoor enclosure.

**Table 17 - uMAXe physical dimensions**

Parameter	Value	Comment
Height	416 mm (16.38 inches)	The physical dimensions exclude handles and connectors.
Width	336 mm (13.3 inches)	
Depth	107 mm (4.2 inches)	
Weight	Aprox. 12 kg (26.45 lbs.)	

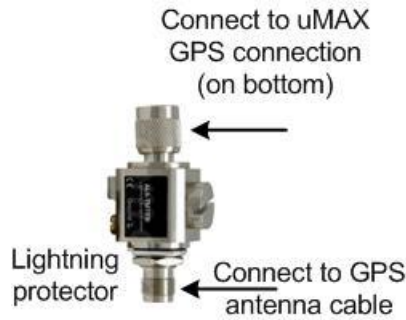
RF Ports for antenna connections are N-Type Female connectors located on the bottom of the uMAXe enclosure. Adjacent to these are SMA connectors used for RF monitoring purposes during installation / maintenance. For normal operation, these are covered with a weatherproof cap.

A 16m RG58 cable connects a remote mounted GPS antenna to the uMAXe or 80cm cable for connection directly on the uMAXe by way of TNC connectors. Alternatively, an 80cm, cable

connects the GPS directly to the top of uMAXe. The cable assembly for the remote GPS antenna is shown below.



**Figure 7 – uMAXe Cable Assembly for GPS Antenna**



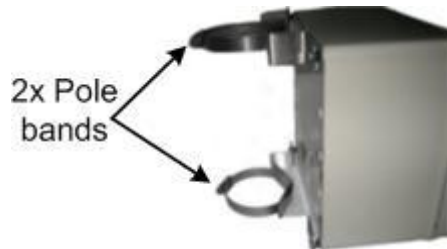
**Figure 8 - Lightning/Surge protector (required)**

### 4.2.3.2 Junction Box (Optional)

The Junction box (optional) is an outdoor enclosure that measures 160 mm (6.3 in.), 160 mm (6.3 in.) and 75 mm (2.95 in.). The unit is shown below with the pole mounting bands assembled. The Junction box is required when the distance from the outdoor Power supply to Base Station is **over** 30 meters for total distance of up to 130 meters.



**Note:** If – 48 volt DC can be verified and guaranteed the Junction box may not be required. Contact customer support to determine.



**Figure 9 - Junction box with pole assembly**

## 5 Install uMAXe

Install the uMAXe base station by pole mount, wall mount, or single point. The uMAXe can be deployed as a remote radio head (RRH) connected to a pair of single (usually vertically polarized) or single independently mounted antennas via standard RF coaxial cables. Antennas are positioned with up to 10 wavelengths horizontal separation to give optimal Downlink and Uplink MIMO performance.



**Caution:** Proper local rigging and hoisting practices should be followed when installing the uMAXe. The pre-assembled handles are **not** to be used for hanging, attaching or hoisting the unit into place.

### 5.1 Pole mount configuration

The following image shows the pole mount assembly.

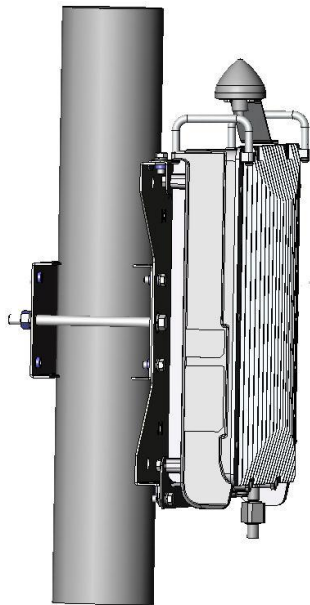


Figure 10 – Pole Mounted uMAXe Assembly

To mount the uMAXe in the pole mount configuration (for poles 60 > 120 MM), perform the following steps:

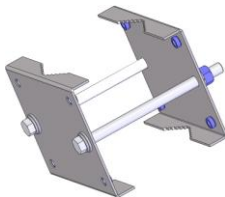
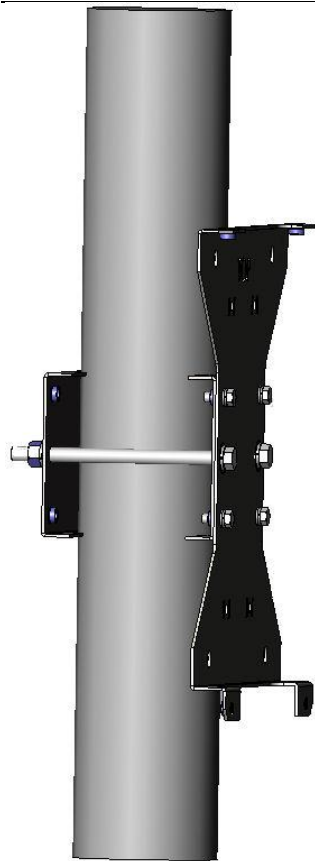


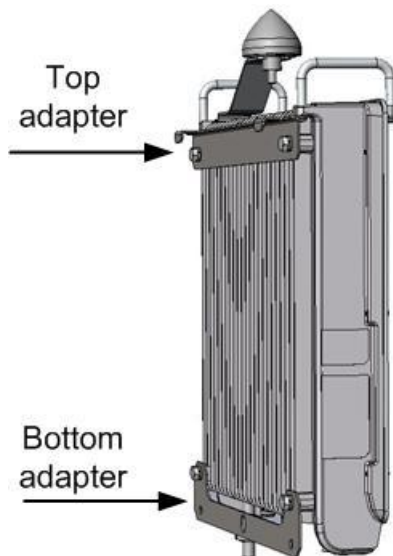
Figure 11 - pole mounting brackets (shown assembled)

1. Adjust the pole mounting brackets to properly fit on the pole. Loosely tighten the M12 screws and nuts in preparation for attachment of the Rear panel with the M8 screws, as shown below:



**Figure 12 - pole bracket brackets with Rear panel**

2. Attach the Top and Bottom adapters to the back of the uMAXe enclosure using the supplied M8 screws.



**Figure 13 - adapters on back**

3. Align and position the Top adapter so the hooks enter the notches in the Rear panel. Insert the M8 screws and washers (supplied) in the Top adapter and fasten to the Rear panel.



**Caution:** These units weigh approximately 12 kg (26.45 lbs.) take care when lifting.

4. Screw two M8 screws and washers through the Bottom adapter into the two bottom standoff fittings in the Rear panel.
5. Check and tighten all the fixing screws.

## 5.2 Wall mount configuration

The following image shows the wall mount assembly.

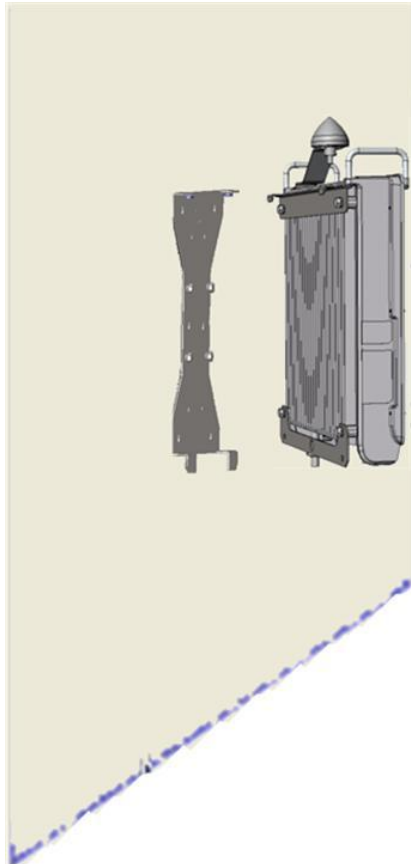


Figure 14 – Wall mounting uMAXe

To mount the uMAXe in the wall mount configuration, perform the following steps:

1. Attach the Rear panel to the wall at the height required to attach the uMAXe.
2. Fasten the Top and Bottom adapters to the rear side of the uMAXe enclosure.
3. Align and position the Top adapter so the hooks enter the notches in the Rear panel. Insert the M8 screws and washers (supplied) in the Top adapter and fasten to the Rear panel.



**Caution:** These units weigh approximately 12 kg (26.45 lbs.) take care when lifting.

4. Screw two M8 screws and washers through the Bottom adapter into the two bottom standoff fittings in the Rear panel.
5. Check and tighten all the fixing screws.



### 5.2.1 Mounting Example

The following displays a typical wall mount.

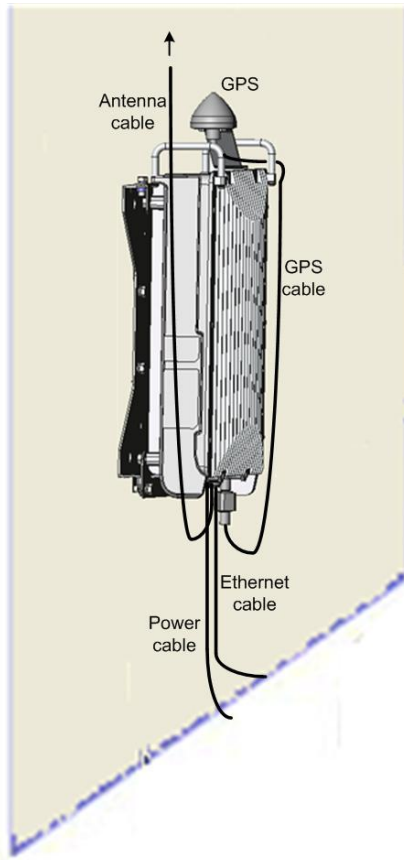


Figure 15 - Wall mount

### 5.3 uMAXe Connections

The following diagram displays the connections on the bottom side of the uMAXe.

The base station requires a secure ground connection. The cable should also be grounded to the tower which is grounded at the tower base. A grounding screw fitted with a flat washer and lock washer is provided on the bottom of the chassis clearly marked with the universal ground symbol as shown below.

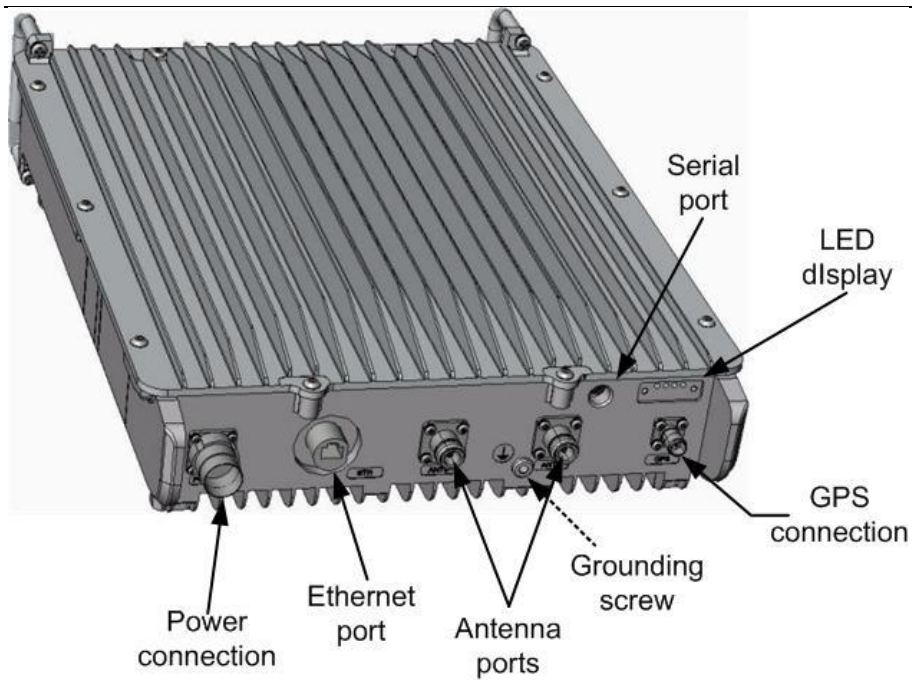


Figure 16 - uMAXe connections (bottom)

### 5.3.1 LED Display

The LED's are a visual display to indicate basic BS status, see [LED Display](#) below for a description of the LED display.

### 5.4 Install uMAXe Antennas

Use this procedure to install a linear dual slant antenna for the uMAXe in the mast mount configuration.



**Note:** Separate antenna distance according to RF planning.

---

### 5.4.1 Install Dual Slant Antenna



Figure 17 - uMAXe Antenna Dual Slant Mast Mount Configuration



**Note:** Mounting kit (50 > 115 mm) is included.

---

To mount the dual slant antenna for the uMAXe in the mast mount configuration, perform the following steps:

1. Attach the Antenna brackets to the top and bottom of the radome.
2. Attach the tilt arm to the top bracket of the radome.
3. Fasten the ends of the adjustable pipe mounts to the top and bottom brackets of the radome.
4. Lift the radome and place the screws through the adjustable pipe mounts and position the radome so that the top mounting holes retain the unit.
5. Screw the bottom two screws and washers into the two standoff fittings at the bottom of the radome assembly.
6. Tighten all fixing screws.
7. Attach, connect and secure antenna RF cable between the antenna and the appropriate uMAXe Antenna RF connection on the bottom of the unit.

#### 5.4.1.1 Antenna Mounting Clamps for Dual Slant Antennae

The following are some adjustable antenna mounting clamp options for Dual Slant antenna scenarios.

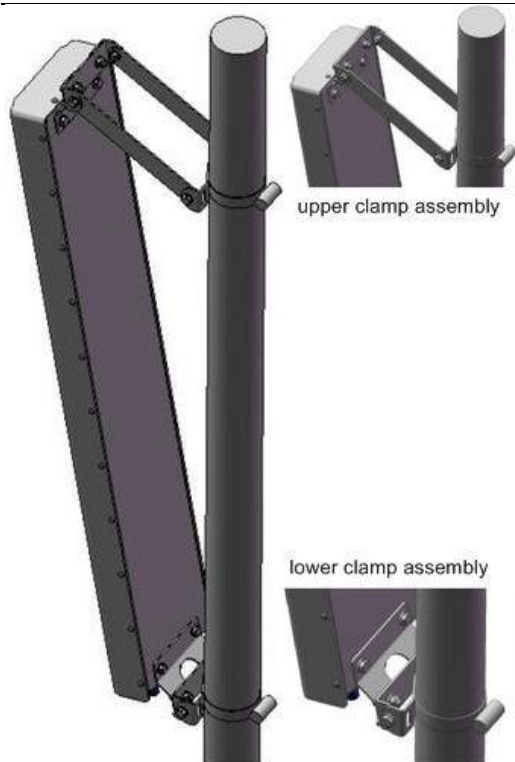


Figure 18 - Adjustable Mounting Kit, with Snaplock Stainless Steel Bands



Figure 19 - Adjustable Mounting Kit, with 'V' Blocks

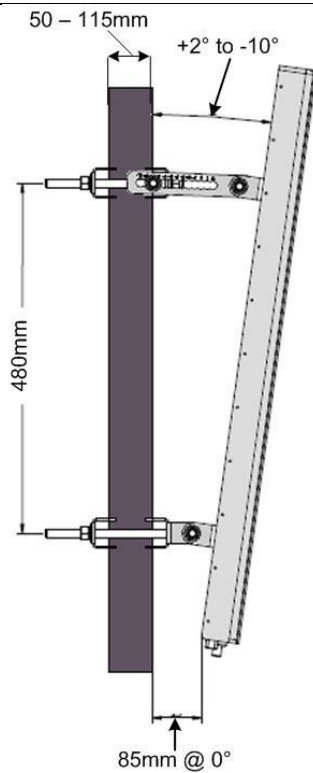


Figure 20 - Adjustable Mounting Kit 2, with 'V' Blocks

#### 5.4.2 Install Omni Antenna

This describes the mounting of the Omni mast mount antenna (ordered separately).



Figure 21 - possible Omni antenna array

To mount the Omni antenna for the uMAXe in a mast mount configuration, perform the following steps:

1. Assemble Omni antenna array on the ground at the installation site.
2. Attach the antennas to the mast and connect the cables while on the ground.
3. Use the mounting brackets provided with the antenna(s).
4. Carefully connect the antenna and mast assembly to its mounting bracket and tighten the clamp bolts.



**Note:** This assembly requires more than one (1) person to assemble in place.

The recommended distance between Omni antennas is determined by the frequency band, as shown in the table below:

Frequency	Distance between antennas
3.x	0.85 meters
2.x	1.20 meters
1.4	4 meters

### 5.5 Optional Mounting Antenna on uMAXe

Either Antenna shown can be mounted on the uMAXe unit or mast mounted.



**Caution:** Antennas 1 & 2 Tx/Rx must be connected and attached before uMAXe is powered on.



**Caution:** Attach the appropriate cable to the antenna and hand-tighten. Torque the N-Type connector to 6.2 - 9.7 in-lbs or 0.7 - 1.1 N-m using either a 19mm or 13/16" open end Torque wrench (depending on coupling type).



**Caution:** Power down uMAXe prior to disconnecting antenna.

The following describes the antenna connection:

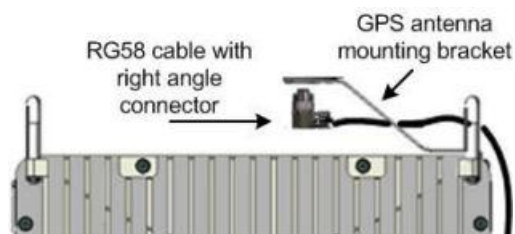
**Table 18 - Antenna connection**

uMAXe port	Port Label on uMAXe	Port on the quad port antenna
Tx/Rx	ANT 1	+45 degree of "first antenna"
Tx/Rx	ANT 2	-45 degree of "second antenna"

### 5.6 GPS Antenna Assembly

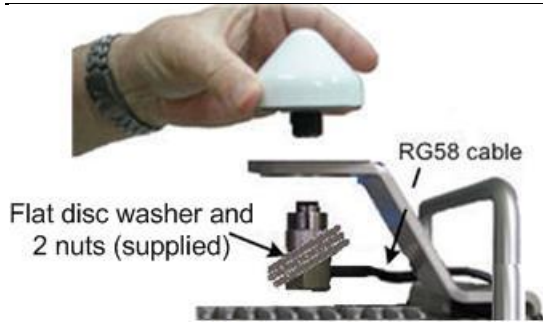
To mount the GPS antenna directly on the uMAXe:

1. Route the RG58 cable through the flat washer and the 2 nuts (supplied).
2. Position the RG58 cable below the mounting hole on the GPS antenna mounting bracket, as shown below:



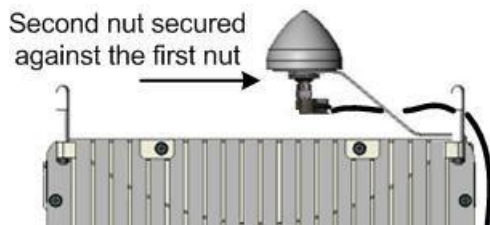
**Figure 22 - GPS cable assembly prior to mounting**

3. Hand-tighten the RG58 cable TNC (90°) connector to the mating connector on the GPS antenna.



**Figure 23 - Attach GPS antenna to RG58 cable**

4. Slide the flat washer up to the underside of the mounting bracket, then thread 1 nut onto the GPS antenna threaded base and tighten.
5. The second nut is then secured and tightened against the first nut to create a clamp load against the first nut, as shown below:



**Figure 24 - GPS antenna assembled on bracket**

6. Connect the RG58 cable attached to the GPS Lightning/Surge protector (required) to the GPS connection on the bottom uMAXe.

## 5.7 LED Display

When powering up refer to the following for indication of BS current status:

**Table 19 - LED Display**

LED	Name	Color	Status	Description
PWR	Power	Green	On	Power on
			Off	Power off
ALM	Alarm	Red	On	Alarm detected
NML	Network Link	Green	Steady on	Network link detected
			Blinking	Traffic currently flowing
STA	In service	Green	On	Software running

## 5.8 Install Junction Box (Optional)



**Note:** Contact Airspan customer-service to determine whether junction box installation is required. Installation may be required, depending on the distance between the external power-supply and the BS, as well as the minimum voltage supplied by the power-supply.

The Junction box (optional) can be pole-mounted or wall-mounted.



**Warning:** Mount the junction box in an orientation such that the cable ports (located on the bottom) face downwards. This prevents rain water from settling on the ports, thereby, avoiding damage.

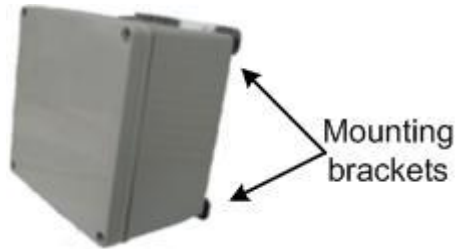


Figure 25 - Junction box with mounting brackets assembled

For either mounting method, the mounting bracket provides mounting holes (displayed below):

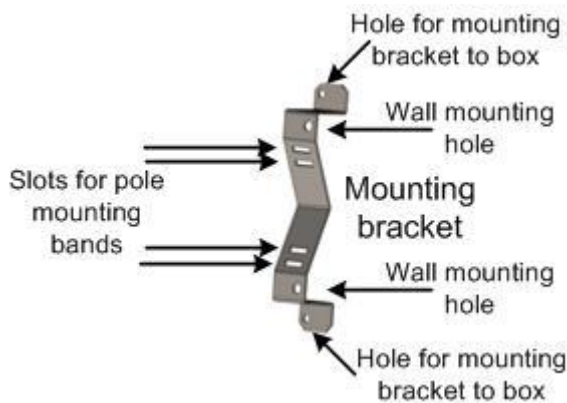


Figure 26 - mounting bracket (2 required)

### 5.8.1 Junction Box Installation

To install the junction box:

1. Prior to installation connect the 2 mounting brackets to the back of the junction box fastening to the provided holes. The wall mounting hole orientation should be towards the outer edges of the junction box.
2. Remove the junction box's cover, leaving the rubber gasket in place.
3. Prepare the cables for connection by performing the following:
  - a. Strip about 25.4 mm (1 inch) of the outer jacket of the cable to expose the wires.
  - b. Using a wire-stripping tool, expose about 6.3 mm (0.25 inch) of each of the wires by stripping the wires' insulation.
4. Determine which cable entry holes are to be used and remove the appropriate plug.

Table 20 - Cable hole sizes

Cable Entry hole determination
Gland hole PG11 (M18) for cable terminating at MicroMAXe
Gland hole PG29 (M36) for cable 12AWG x6
Gland hole PG16 (M22) for cable 14AWG x2



**Note:** Save the rubber grommets from the plugs to be used on the weatherproof glands (connectors).



5. Remove the nut on the weatherproof connector and slide the rubber grommet onto the threaded shaft.
6. Set the weatherproof connector into the hole and from inside the box, thread the included nut onto the shaft until tight.
7. Insert the exposed wires into the relevant screw-type terminal block (+ to + and – to –) and then secure them in place by tightening the screw of each terminal.
8. Fasten the Junction box onto the pole or wall as required within the required distance of the uMAXe enclosure.
9. Perform the same procedure (steps 3-7) with the cable terminating in the in the uMAXe enclosure.
10. Open the connector clamp collar and feed about 101.6 mm (4 inches) of cable from the uMAXe through it and into the box. Tighten the collar around the cable, forcing the seal to compress around the cable.
11. Replace the cover by using the four (4) screws, ensuring the gasket (for weatherproofing) is firmly in place on the rim of the cover.



---

**Note:** It is important to provide strain relief and drip loop for the cables. Create a drip loop and strain relief using cable tie, to tie cable to pole.

---

## 6 Connect and Manage Cables

The Ethernet cable is connected to the uMAXe using a standard RJ45 connector protected by a harsh environment protective casing.



Figure 27 – Ethernet connector cable termination

### 6.1 Assemble Ethernet Connector

1. Pass the Cat 5 cable through the seal, front connector, body and tail nut of the environmental connector casing as shown above.
2. Remove clear protector and paste the front seal on the collar of the connector body.
3. Terminate the Ethernet cable with an RJ45 connector plug.
4. Seat the RJ45 connector plug securely into the body cavity.
5. Tighten the tail nut on to the body forcing the seal to compress around the cable.



Figure 28 – Ethernet environmental connector assembly

## 7 Set Power System



**Hazardous voltage!** Before working, ensure that the power is removed from the power connection cables. When the system is powered on, **do not touch the power terminals.**

### 7.1 Power Input - DC

Each unit is provided with a 3/10/30 meter 48 volt power cable terminated with a female connector at one end to be connected to the Power connector on the bottom panel of the uMAXe and bare wires at the other.



**Caution:** It is important that the power connector is attached at the correct end or damage to the connector/equipment will result.



**Note:** Check Power Supply for proper polarization.

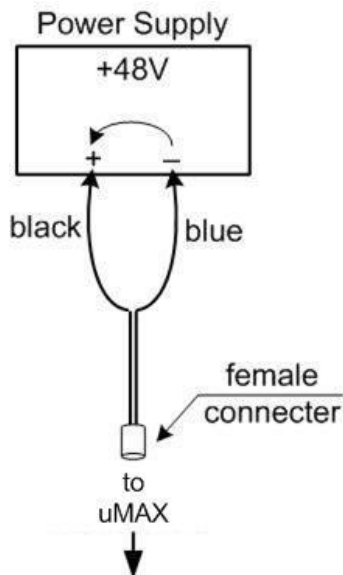


Figure 29 – DC Power connection

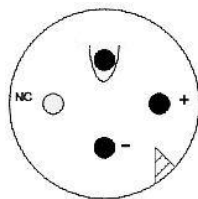


Figure 30 - Power connector – uMAXe bottom panel

## 8 Initial WEB Configuration

Configure an uMAXe base station using the built in web based interface. This prepares the equipment for connection to Netspan.

### 8.1 Initial configuration

To set initial configuration, perform the following:



**Caution:** The GPS antenna should be installed and attached before uMAXe is powered on.



**Caution:** Wait two minutes before performing other actions.

1. Apply power to the uMAXe.
2. With the uMAXe powered-up connect the PC to the Ethernet port.
3. Configure the PC with an IP address in the 192.168.0.xxx range (e.g. 192.168.0.xxx subnet 255.255.255.0).
4. In a browser, open web page with address 192.168.0.1 (uMAXe default IP address).
5. Enter the default username and password:

Username = macromaxe

Password = macromaxe

#### 8.1.1 General Config

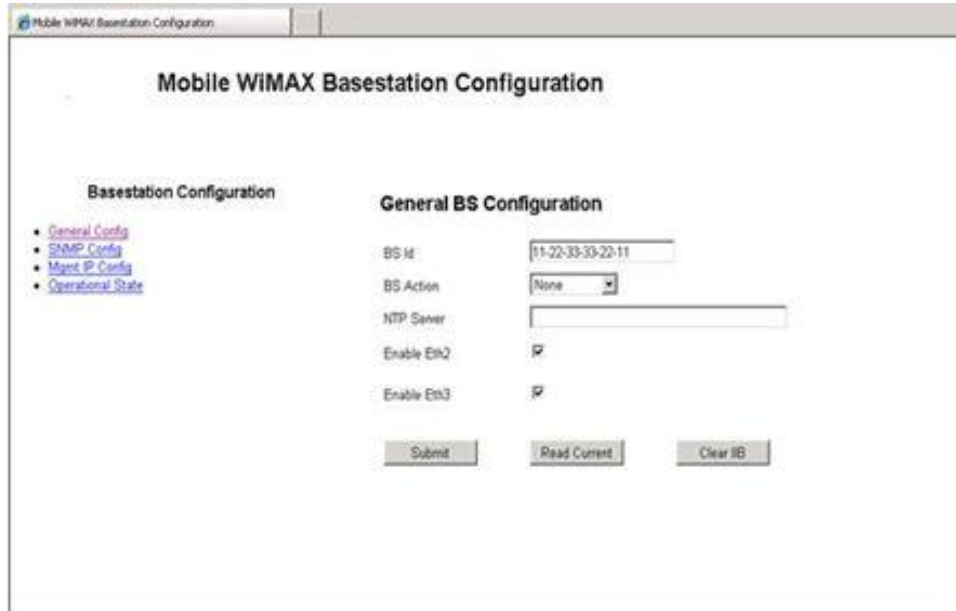


Figure 31 – General BS Configuration Initial

6. Enter the **BS ID**



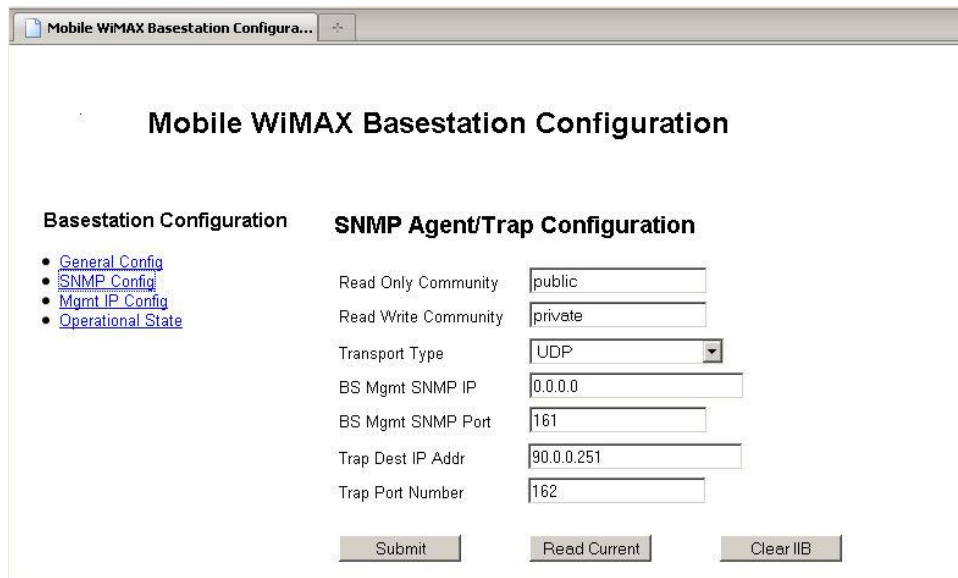
**Note:** The format of the BS ID is important: NN-NN-NN-nn-nn-nn (where NN-NN-NN is the Operator ID and nn-nn-nn is a unique address ID).

7. Select the **BS Action** from the available list.

8. Leave **NTP Server** as is (blank).
9. Click **Submit**. (Read Current = ignore/no action) (Clear IIB = ignore/no action)

### 8.1.2 SNMP Agent/Trap Configuration

1. Click **SNMP Config**, as displayed below:



The screenshot shows a web browser window titled "Mobile WiMAX Basestation Configuration". The main heading is "Mobile WiMAX Basestation Configuration". On the left, there is a navigation menu with links: "General Config", "SNMP Config", "Mgmt IP Config", and "Operational State". The "SNMP Config" link is selected. The main content area is titled "SNMP Agent/Trap Configuration" and contains the following fields and buttons:

Read Only Community	<input type="text" value="public"/>
Read Write Community	<input type="text" value="private"/>
Transport Type	<input type="text" value="UDP"/>
BS Mgmt SNMP IP	<input type="text" value="0.0.0.0"/>
BS Mgmt SNMP Port	<input type="text" value="161"/>
Trap Dest IP Addr	<input type="text" value="90.0.0.251"/>
Trap Port Number	<input type="text" value="162"/>

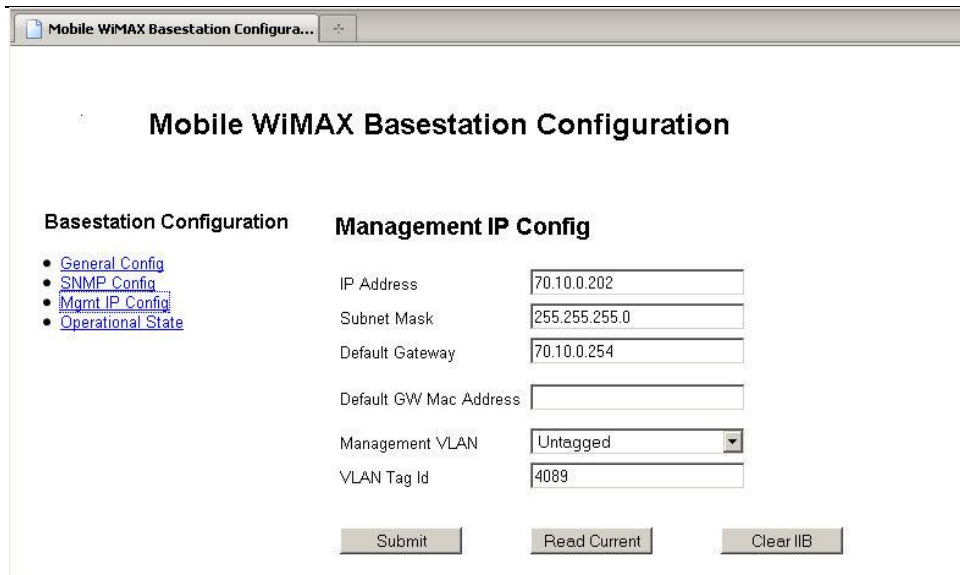
At the bottom of the configuration area, there are three buttons: "Submit", "Read Current", and "Clear IIB".

Figure 32 - SNMP Initial Configuration

2. Define **Read Only Community** - SNMP read only community name defined by the BS network provider
3. Define **Read Write Community** - SNMP read/write community name defined by the BS network provider.
4. Leave **Transport Type** as is.
5. Leave **BS Mgmt SNMP IP** as is.
6. Leave the **BS Mgmt SNMP Port** number as is. Default = 161
7. Define the SNMP **Trap Dest IP Addr**. (IP address of Netspan)
8. Set the SNMP **Trap Port Number** (for communications with Netspan) to 162.
9. Click **Submit**. (Read Current = ignore/no action) (Clear IIB = ignore/no action)

### 8.1.3 Mgmt IP Config

1. Click **Mgmt IP Config**, as displayed below:



The screenshot shows a web browser window titled "Mobile WiMAX Basestation Configuration". The main heading is "Mobile WiMAX Basestation Configuration". On the left, there is a navigation menu with links: "General Config", "SNMP Config", "Mgmt IP Config", and "Operational State". The "Mgmt IP Config" section is active and contains the following fields:

- IP Address: 70.10.0.202
- Subnet Mask: 255.255.255.0
- Default Gateway: 70.10.0.254
- Default GW Mac Address: (empty)
- Management VLAN: Untagged (dropdown menu)
- VLAN Tag Id: 4089

At the bottom of the form, there are three buttons: "Submit", "Read Current", and "Clear IIB".

Figure 33 - Management IP Configuration

2. Define the **IP address**.
3. Define the **Subnet Mask**.
4. Define the **Default GW MAC Address**.



**Caution:** Define Default GW only if required for Network Security. Consult with Provider.

5. Set the **Management VLAN** set to Untagged. Set to Tagged when with VLAN Tag ID. Consult with Provider.
6. Define the **VLAN Tag ID** – only when Management VLAN is set to Tagged. Consult with Provider.
7. Click **Submit**. (Read Current = ignore/no action)



**Caution:** After **Submit** changes are applied immediately to the BS. Therefore the PC must now be re-configured to the new configuration (IP address and Subnet mask) to re-establish communication.

1. Return to [General Config](#) and in the **BS Action**.
2. Select **Reset BS** from the dropdown list.
3. Click **Submit** to perform a reset of the BS.

### 8.1.4 BS Operational State



**Note:** Leave settings on BS Operational State as is. No configuration is required.

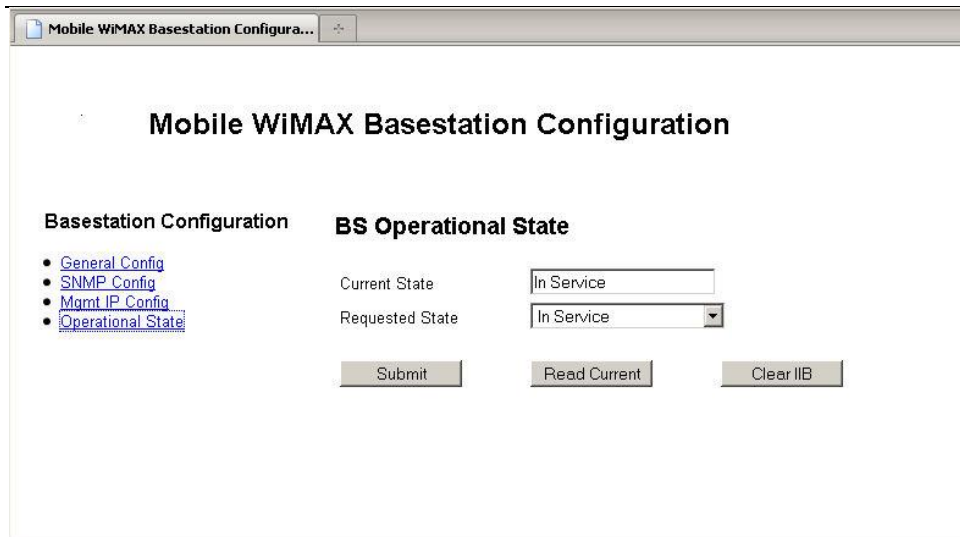


Figure 34 - Operational State

## 9 Appendix A

### 9.1 Review Job Sheet

The *Job Sheet* should include the following information:

- **BS location and identity.**
- **A BSID is required for each BS TRx.** This should be in a format xxxxxx:xxxxxx where x is a decimal digit.
- Network configuration information for the BS TRx.
- **Traffic Port:** Not applicable.
- **IP Address:** Should only be set if Management IP Mode is set to Static IP Address. See below for Management IP Mode parameter.
- **Netmask:** Should only be set if Management IP Mode is set to Static IP Address. See below for Management IP Mode parameter.
- **Default Gateway:** Should only be set if Management IP Mode is set to Static IP Address. See below for Management IP Mode parameter.
- **Management VLAN:** Specified as either Untagged or Tagged
- **Management VLAN Tag:** Should only be set if Management VLAN is set to Tagged
- **Management IP Mode:** Specified as Static IP Address or Obtain IP Address via DHCP
- **Ethernet Mode:** Specified as Auto-negotiate or Fixed
- **Ethernet Rate:** Need only be configured if Ethernet Mode is set to Fixed, specified as 10M or 100M.
- **Ethernet Duplex:** Need only be configured if Ethernet Mode is set to Fixed, specified as Full or Half.
  - **SNMP configuration information.** This will allow events from the BS to arrive at the specified Netspan server. This will include the following information:
    - **Read Only Community:** This should be specified to the same value as in Netspan Discovery Parameters (found under Server on Netspan left hand panel).
    - **Read Write Community:** This should be specified to the same value as in Netspan Discovery Parameters (found under "Server" on Netspan left hand panel).
    - **SNMP Port Number:** This should be specified to the same value as in Netspan Discovery Parameters (found under "Server" on Netspan left hand panel).
    - **IP Address:** This specifies Netspan IP address (found under Server Global Configuration, which is under Server on Netspan left hand panel).
    - **Community:** Normally specified to the same value as for Read Only Community.
    - **Port Number:** Normally specified to a value of 9023.
  - **NTP configuration.** This specifies a list of NTP servers.



---

## 10 Appendix C – Glossary of Terms

AAA	Authentication, Authorization and Accounting
AAS	Advanced Antenna System
AF	Application Function
ARQ	Automatic Repeat reQuest
ASN	Access Service Network
ASN GW	ASN Gateway
ATCA	Advanced Telecommunications Computing Architecture
BS	Base Station
BWA	Broadband Wireless Access
CHAP	Challenge Handshake Authentication Protocol
CPE	Customer Premises Equipment
CQI	Channel Quality Indicator
CSN	Connectivity Service Network
DSM	Digital Surface Model
DTM	Digital Terrain Model
EAP	Extensible Authentication Protocol
FA	Foreign Agent
FBSS	Fast Base Station Switching
GUI	Graphical User Interface
HA	Home Agent
H-ARQ	Hybrid Automatic Repeat reQuest
HO	Handover/Handoff
IMS	IP Multimedia Subsystem
IP	Internet Protocol
IPsec	IP security
LR	Location Register
MAC	Media Access Control
MDH	Macro Diversity Handover
MIMO	Multiple Input Multiple Output
MIP	Mobile IP
MRC	Maximal Ratio Combining
MS	Mobile Station
NAP	Network Access Provider
NAS	Network Access Server
NLOS	Non Line of Sight
NSP	Network Service Provider
NWG	Network Working Group



## uMAXe Installation Guide



---

OBSAI	Open Base Station Standard Initiative
OFDMA	Orthogonal Frequency Division Multiplexing (Multiple Access)
PA	Paging Agent
PAAA	Proxy AAA
PC	Paging Controller
PF	Policy Function
PHY	PHYsical Layer
PMIP	Proxy MIP
PPP	Point-to-Point Protocol
RADIUS	Remote Authentication Dial In User Service
RRA	Radio Resource Agent
RRC	Radio Resource Controller
RRM	Radio Resource Management
SAS	Smart Antenna System
SDR	Software Defined Radio
SFA	Service Flow Authorization
SFM	Service Flow Management
SIM	Subscriber Identity Module
SIP	Session Initiation Protocol
SOFDMA	Scalable Orthogonal Frequency Division Multiplexing (Multiple Access)
STC	Space Time Coding
TDD	Time Division Duplex
VoIP	Voice over IP
X.509	ITU-T standard for PKI digital certificates

## 11 Appendix D – Installation Checklist

The Checklist below gives the high-level steps in the Workflow for this procedure. Detach or print this page to use as a job-aid for completing the actions this procedure requires.

**Table 21 - Checklist for Procedure**

Procedure	Actions	Outcome
1. Verify Prerequisites	Verify safety requirements Verify installation requirements	All requirements are in place for a successful commissioning of uMAXe.
2. Install UMAXE	Pole mount configuration Wall mount configuration Install uMAXe antennas	
3. Connect and manage cables	Assemble Ethernet connector <i>or</i> Disassemble Ethernet connector, <i>then</i> Assemble LTW Ethernet connector	
4. Set power system	Power input Power output	



---

## 12 Appendix E

### 12.1 Revision History

Revision	Originator	Date	Description
Draft 1 & 2	M. Falik	3-2011	Initial document
Rev A	M. Falik	5-2011	First release

### 12.2 Contact Information

#### Customer Service Help-Desk for customer service emergency

Airspan Networks have introduced the Airspan Tracker application to enable prompt and efficient Customer Support services.

If you do not have an Airspan Tracker account, please obtain login credentials by filling-in the form in the main page [www.airspan.com/Support](http://www.airspan.com/Support) Register New Account

#### Worldwide Headquarters:

Airspan Networks Inc.  
777, Yamato Road, Suite 310,  
Boca Raton, FL 33431, USA  
Tel: +1 561 893 8670

[www.airspan.com](http://www.airspan.com)

#### Feedback:

To provide feedback on this document, please send comments to the following email address: [documentfeedback@airspan.com](mailto:documentfeedback@airspan.com)