

# TEST REPORT

ACCORDING TO: FCC 47CFR part 15 subpart C § 15.247 and subpart B

FOR:

**Airspan Networks (Israel) Ltd.**

**Base station**

**Model: MicroMax-SOC 5.8 GHz**

This report is in conformity with ISO/IEC 17025. The A2LA logo endorsement applies only to the test methods and the standards that are listed in the scope of Hermon Laboratories accreditation. The test results relate only to the items tested. This test report shall not be reproduced in any form except in full with the written approval of Hermon Laboratories Ltd.

## Table of contents

1	Applicant information.....	3
2	Equipment under test attributes .....	3
3	Manufacturer information .....	3
4	Test details.....	3
5	Tests summary.....	4
6	EUT description.....	5
6.1	General information.....	5
6.2	Ports and lines .....	5
6.3	Support and test equipment .....	5
6.4	Operating frequencies.....	5
6.5	Changes made in the EUT .....	5
6.6	Test configuration.....	6
6.7	Transmitter characteristics .....	7
7	Transmitter tests according to 47CFR part 15 subpart C requirements .....	8
7.1	Minimum 6 dB bandwidth.....	8
7.2	Peak output power .....	16
7.3	Spurious emissions at RF antenna connector.....	24
7.4	Field strength of spurious emissions .....	46
7.5	Peak spectral power density .....	75
7.6	Conducted emissions.....	83
7.7	Antenna requirements.....	86
8	Emission tests according to 47CFR part 15 subpart B requirements .....	87
8.1	Conducted emissions.....	87
8.2	Radiated emission measurements .....	90
9	APPENDIX A Test equipment and ancillaries used for tests.....	98
10	APPENDIX B Measurement uncertainties.....	100
11	APPENDIX C Test facility description .....	101
12	APPENDIX D Specification references .....	101
13	APPENDIX E Abbreviations and acronyms.....	102
14	APPENDIX F Test equipment correction factors.....	103

## 1 Applicant information

**Client name:** Airspan Networks (Israel) Ltd.  
**Address:** 1, Harava street, "Unitronics" building, POB 199, Airport City, 70100, Israel  
**Telephone:** +972 3977 7444  
**Fax:** +972 3977 7400  
**E-mail:** zlevi@Airspan.com  
**Contact name:** Mr. Zion Levi

## 2 Equipment under test attributes

**Product name:** Base station  
**Product type:** Transceiver  
**Model(s):** MicroMax -SOC 5.8 GHz  
**Serial number:** 799F66C11111  
**Software release:** V12.9  
**Hardware version:** A2  
**Receipt date:** 7/6/2006

## 3 Manufacturer information

**Manufacturer name:** Airspan Networks (Israel) Ltd.  
**Address:** 1, Harava street, "Unitronics" building, POB 199, Airport City, 70100, Israel  
**Telephone:** +972 3977 7444  
**Fax:** +972 3977 7400  
**E-Mail:** zlevi@Airspan.com  
**Contact name:** Mr. Zion Levi



## 4 Test details

**Project ID:** 17233  
**Location:** Hermon Laboratories Ltd. P.O.Box 23, Binyamina 30500, Israel  
**Test started:** 7/6/2006  
**Test completed:** 7/24/2006; 10/8/2006  
**Test specification(s):** FCC 47CFR part 15:2005, subpart C §§15.247, subpart B  
**Test suite:** FCC\_15.247\_DTS\_with\_RF\_connector (5/4/2004 10:53:46 AM, modified)

## 5 Tests summary

Test	Status
<b>Transmitter characteristics</b>	
Section 15.247(a)2, 6 dB bandwidth	Pass
Section 15.247(b)3, Peak output power	Pass
Section 15.247(e)(i), RF exposure	Pass, provided in Exhibit to Application
Section 15.247(c), Conducted spurious emissions	Pass
Section 15.247(c), Radiated spurious emissions	Pass
Section 15.247(d), Peak power density	Pass
Section 15.207(a), Conducted emission	Pass
Section 15.203, Antenna requirement	Pass
<b>Unintentional emissions</b>	
Section 15.107, Conducted emission at AC power port	Pass
Section 15.109, Radiated emission	Pass
Section 15.111, Conducted emission at receiver antenna port	Not required

Testing was completed against all relevant requirements of the test standard. Results obtained indicate that the product under test complies in full with the requirements tested.  
The test results relate only to the items tested. Pass/ fail decision was based on nominal values.

	Name and Title	Date	Signature
<b>Tested by:</b>	Mr. A. Adelberg, test engineer	July 24, 2006	
	Mr. A. Lane, test engineer	October 8, 2006	
<b>Reviewed by:</b>	Mrs. M. Cherniavsky, certification engineer	October 12, 2006	
<b>Approved by:</b>	Mr. M. Nikishin, EMC and Radio group leader	October 12, 2006	

## 6 EUT description

### 6.1 General information

The EUT, model name MicroMax-SOC, connects IP-enabled devices directly to WiMAX networks providing high-speed broadband Internet access and a Fast Ethernet connection to the subscriber's local area network (LAN). It supports IP services in both uplink and downlink operating with 3.5-MHz channels. The EUT uses the OFDM signaling format, providing non line-of-sight (NLOS) performance. The EUT is an outdoor unit powered from the mains via AC/DC adapter.

### 6.2 Ports and lines

Port type	Port description	Connected		Connector type	Qty.	Cable type	Cable length
		From	To				
Power	48 V DC	EUT	SDA	D-type 15 pin	1	unshielded	4 m
RF	Antenna	EUT	Antenna	N-type	1	coax	1 m
Signal	RS232	EUT	Laptop	D-type 9 pin	1	unshielded	3 m

### 6.3 Support and test equipment

Description	Manufacturer	Model number	Serial number
SDA	Airspan	SDA-1	045D3C0199
Laptop	Dell	Ppx	48985
Adapter to laptop	Dell	AA20031	93640
Mouse	Microsoft	PS/2	X04-72169

### 6.4 Operating frequencies

Source	Frequency, MHz
Digital board	10
Tx IF1	466
Tx IF2	36
Rx IF1	546
Rx IF2	44

### 6.5 Changes made in the EUT

No changes were implemented.

## 6.6 Test configuration

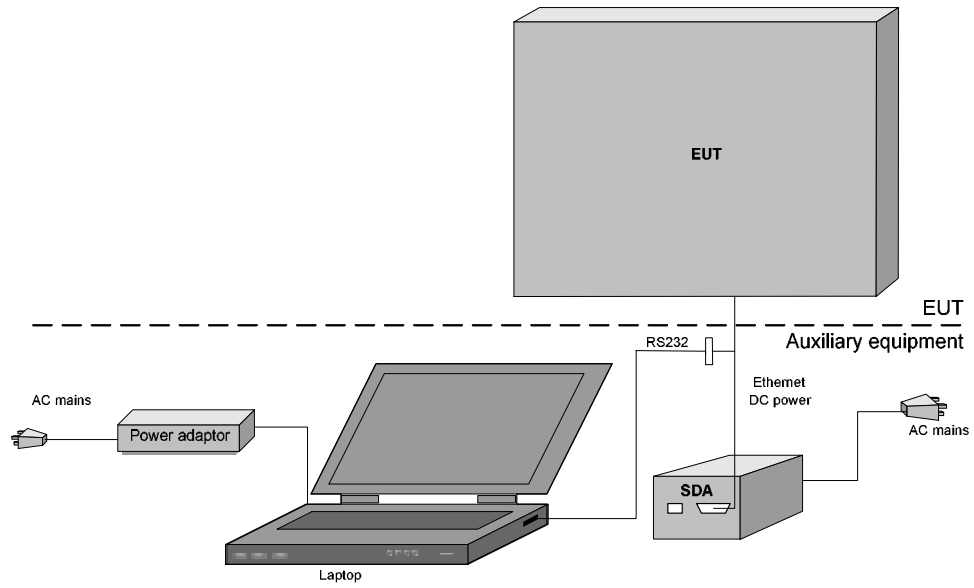

## 6.7 Transmitter characteristics

<b>Type of equipment</b>			
<input checked="" type="checkbox"/>	Stand-alone (Equipment with or without its own control provisions)		
	Combined equipment (Equipment where the radio part is fully integrated within another type of equipment)		
	Plug-in card (Equipment intended for a variety of host systems)		
<b>Intended use</b>		<b>Condition of use</b>	
<input checked="" type="checkbox"/>	fixed	Always at a distance more than 2 m from all people	
	mobile	Always at a distance more than 20 cm from all people	
	portable	May operate at a distance closer than 20 cm to human body	
<b>Assigned frequency range</b>		5725 - 5850 MHz	
<b>Operating frequency range</b>		5728 - 5847 MHz	
<b>Rated output power</b>		At transmitter 50 Ω RF output connector	21.9 dBm
<b>Is transmitter output power variable?</b>			
		No	
			continuous variable
<input checked="" type="checkbox"/>	Yes	<input checked="" type="checkbox"/>	stepped variable with stepsize 1 dB
			minimum RF power -30 dBm
			maximum RF power 21.9 dBm
<b>Antenna connection</b>			
<input type="checkbox"/>	unique coupling	<input checked="" type="checkbox"/>	standard connector
<input type="checkbox"/>		<input checked="" type="checkbox"/>	Integral
<input checked="" type="checkbox"/>			with temporary RF connector
<input type="checkbox"/>			without temporary RF connector
<b>Antenna/s technical characteristics</b>			
Type	Manufacturer	Model number	Gain
Integrated	MARS	MA-WC55-AS16	14 dBi
<b>Transmitter 99% power bandwidth</b>		5 MHz, 10 MHz	
<b>Transmitter aggregate data rate/s</b>		5 MHz BW: BPSK - 2.095 MBps, QPSK - 4.19 MBps, 16QAM - 12.565 MBps, 64QAM - 18.85 MBps	
		10 MHz BW: BPSK - 4.19 MBps, QPSK - 8.38 MBps, 16QAM - 25.13 MBps, 64QAM - 37.7 MBps	
<b>Type of modulation</b>		BPSK, QPSK, 16QAM, 64QAM	
<b>Type of multiplexing</b>		TDMA	
<b>Modulating test signal (baseband)</b>		WiMAX	
<b>Maximum transmitter duty cycle in normal use</b>		85%	
<b>Transmitter power source</b>			
<input checked="" type="checkbox"/>	DC	<b>Nominal rated voltage</b>	Battery type
	AC mains	<b>Nominal rated voltage</b>	Frequency Hz
		48 V	
<b>Common power source for transmitter and receiver</b>		<input checked="" type="checkbox"/>	yes no

<b>Test specification:</b>		<b>Section 15.247(a)2, 6 dB bandwidth</b>	
<b>Test procedure:</b> FR Vol.62, page 26243, Section 15.247(a)2			
<b>Test mode:</b> Compliance		<b>Verdict:</b> PASS	
<b>Date &amp; Time:</b> 7/11/2006 1:16:29 PM			
<b>Temperature:</b> 24°C	<b>Air Pressure:</b> 1010 hPa	<b>Relative Humidity:</b> 36 %	<b>Power Supply:</b> 120 VAC
<b>Remarks:</b>			

## 7 Transmitter tests according to 47CFR part 15 subpart C requirements

### 7.1 Minimum 6 dB bandwidth

#### 7.1.1 General

This test was performed to measure 6 dB bandwidth of the EUT carrier frequency. Specification test limits are given in Table 7.1.1.

Table 7.1.1 The 6 dB bandwidth limits

Assigned frequency, MHz	Modulation envelope reference points*, dBc	Minimum bandwidth, kHz
902.0 – 928.0	6.0	500.0
2400.0 – 2483.5		
5725.0 – 5850.0		

\* - Modulation envelope reference points provided in terms of attenuation below the peak of modulated carrier.

#### 7.1.2 Test procedure

7.1.2.1 The EUT was set up as shown in Figure 7.1.1, energized and its proper operation was checked.

7.1.2.2 The EUT was set to transmit modulated carrier.

7.1.2.3 The transmitter minimum 6 dB bandwidth was measured with spectrum analyzer as frequency delta between reference points on modulation envelope and provided in Table 7.1.2 and associated plot.

Figure 7.1.1 The 6 dB bandwidth test setup

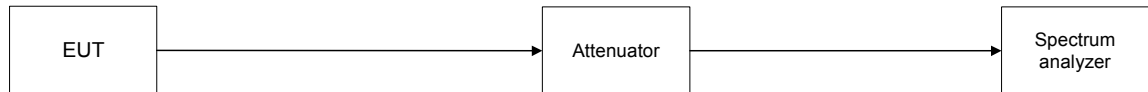



<b>Test specification:</b>		<b>Section 15.247(a)2, 6 dB bandwidth</b>	
<b>Test procedure:</b>		FR Vol.62, page 26243, Section 15.247(a)2	
<b>Test mode:</b>	Compliance	<b>Verdict:</b>	<b>PASS</b>
<b>Date &amp; Time:</b>	7/11/2006 1:16:29 PM		
<b>Temperature:</b> 24°C	<b>Air Pressure:</b> 1010 hPa	<b>Relative Humidity:</b> 36 %	<b>Power Supply:</b> 120 VAC
<b>Remarks:</b>			

**Table 7.1.2 The 6 dB bandwidth test results**

ASSIGNED FREQUENCY BAND: 5725 – 5850 MHz  
DETECTOR USED: Peak  
SWEEP MODE: Single  
SWEEP TIME: Auto  
MODULATION ENVELOPE REFERENCE POINTS: 6.0 dBc  
MODULATING SIGNAL: PRBS

Carrier frequency, MHz	6 dB bandwidth, kHz	Limit, kHz	Margin, kHz	Verdict
<b>5 MHz channel spacing:</b>				
<b>BPSK:</b>				
5740	4551	500	4051	Pass
5785	4543	500	4043	Pass
5835	4527	500	4027	Pass
<b>64QAM:</b>				
5740	4552	500	4052	Pass
5785	4564	500	4064	Pass
5835	4563	500	4063	Pass
<b>10 MHz channel spacing:</b>				
<b>BPSK:</b>				
5740	9073	500	8573	Pass
5785	9070	500	8570	Pass
5835	9171	500	8671	Pass
<b>64QAM:</b>				
5740	9142	500	8642	Pass
5785	9055	500	8555	Pass
5835	9054	500	8554	Pass

**Reference numbers of test equipment used**

HL 1653	HL 2254	HL 2909					
---------	---------	---------	--	--	--	--	--

Full description is given in Appendix A.

<b>Test specification:</b>	<b>Section 15.247(a)2, 6 dB bandwidth</b>		
<b>Test procedure:</b>	FR Vol.62, page 26243, Section 15.247(a)2		
<b>Test mode:</b>	Compliance	<b>Verdict:</b>	<b>PASS</b>
<b>Date &amp; Time:</b>	7/11/2006 1:16:29 PM		
<b>Temperature:</b> 24°C	<b>Air Pressure:</b> 1010 hPa	<b>Relative Humidity:</b> 36 %	<b>Power Supply:</b> 120 VAC
<b>Remarks:</b>			

Plot 7.1.1 The 6 dB bandwidth test result at low frequency, 5 MHz channel spacing, BPSK

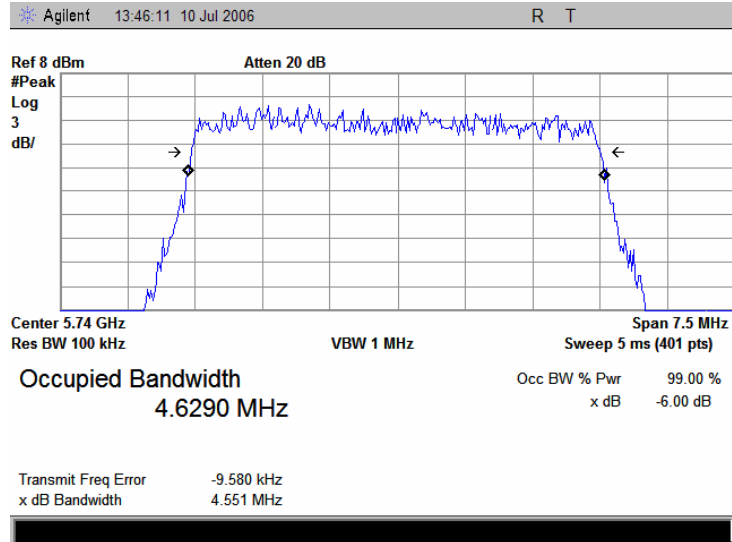

Plot 7.1.2 The 6 dB bandwidth test result at mid frequency, 5 MHz channel spacing, BPSK

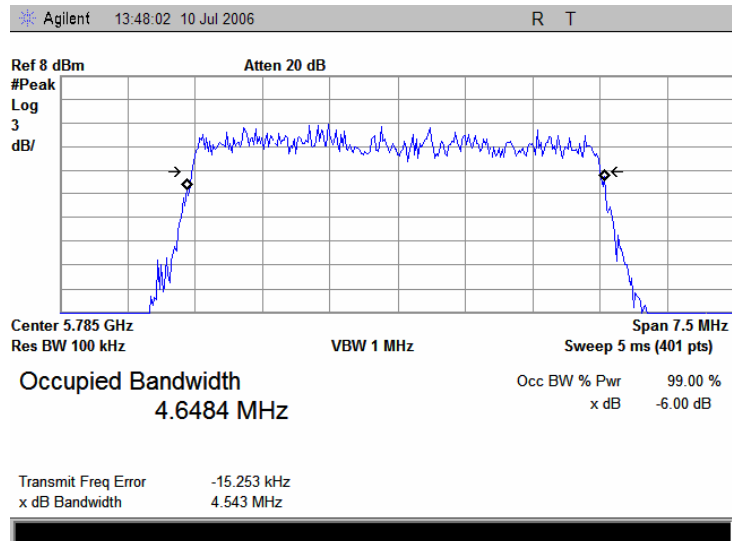

<b>Test specification:</b>	<b>Section 15.247(a)2, 6 dB bandwidth</b>		
<b>Test procedure:</b>	FR Vol.62, page 26243, Section 15.247(a)2		
<b>Test mode:</b>	Compliance	<b>Verdict:</b>	<b>PASS</b>
<b>Date &amp; Time:</b>	7/11/2006 1:16:29 PM		
<b>Temperature:</b> 24°C	<b>Air Pressure:</b> 1010 hPa	<b>Relative Humidity:</b> 36 %	<b>Power Supply:</b> 120 VAC
<b>Remarks:</b>			

Plot 7.1.3 The 6 dB bandwidth test result at high frequency, 5 MHz channel spacing, BPSK

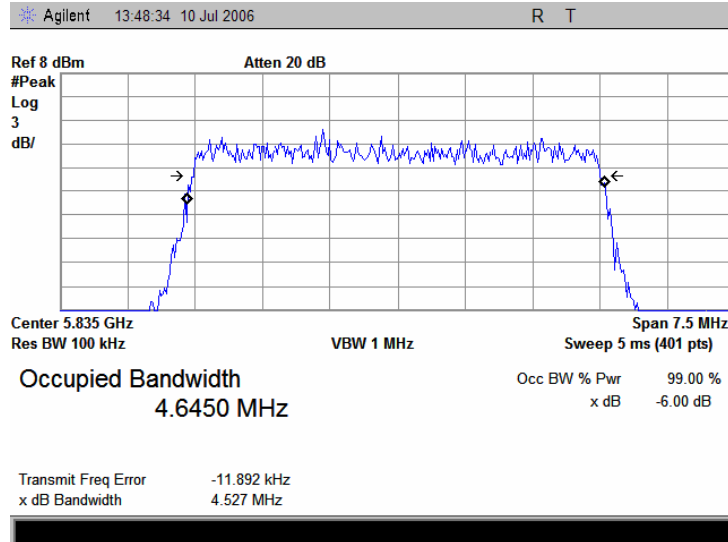

Plot 7.1.4 The 6 dB bandwidth test result at low frequency, 5 MHz channel spacing, 64QAM

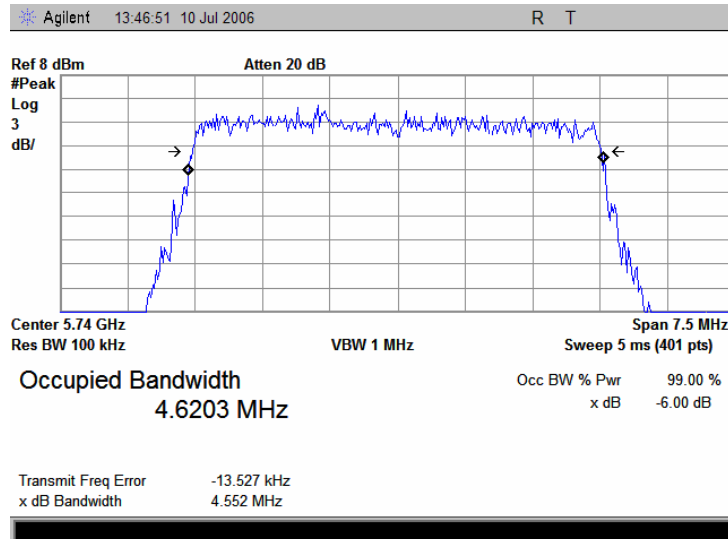

<b>Test specification:</b>	<b>Section 15.247(a)2, 6 dB bandwidth</b>		
<b>Test procedure:</b>	FR Vol.62, page 26243, Section 15.247(a)2		
<b>Test mode:</b>	Compliance	<b>Verdict:</b>	<b>PASS</b>
<b>Date &amp; Time:</b>	7/11/2006 1:16:29 PM		
<b>Temperature:</b> 24°C	<b>Air Pressure:</b> 1010 hPa	<b>Relative Humidity:</b> 36 %	<b>Power Supply:</b> 120 VAC
<b>Remarks:</b>			

Plot 7.1.5 The 6 dB bandwidth test result at mid frequency, 5 MHz channel spacing, 64QAM

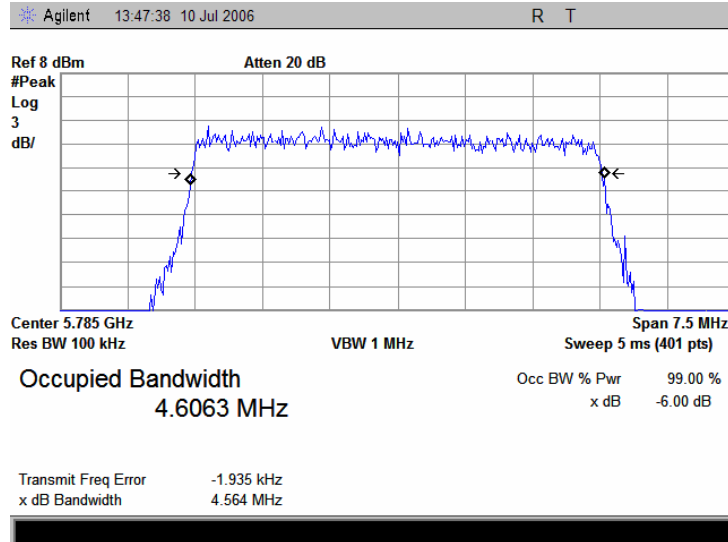

Plot 7.1.6 The 6 dB bandwidth test result at high frequency, 5 MHz channel spacing, 64QAM

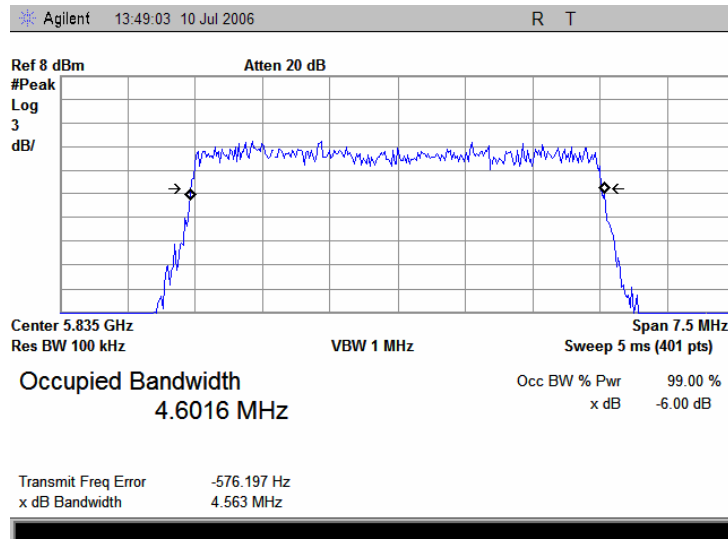

<b>Test specification:</b> Section 15.247(a)2, 6 dB bandwidth			
<b>Test procedure:</b> FR Vol.62, page 26243, Section 15.247(a)2			
<b>Test mode:</b> Compliance	<b>Verdict:</b> PASS		
<b>Date &amp; Time:</b> 7/11/2006 1:16:29 PM			
<b>Temperature:</b> 24°C	<b>Air Pressure:</b> 1010 hPa	<b>Relative Humidity:</b> 36 %	<b>Power Supply:</b> 120 VAC
<b>Remarks:</b>			

Plot 7.1.7 The 6 dB bandwidth test result at low frequency, 10 MHz channel spacing, BPSK

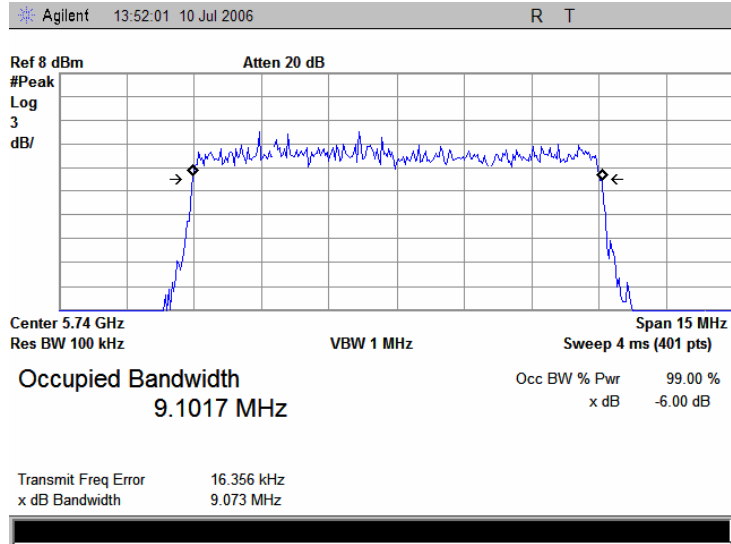

Plot 7.1.8 The 6 dB bandwidth test result at mid frequency, 10 MHz channel spacing, BPSK

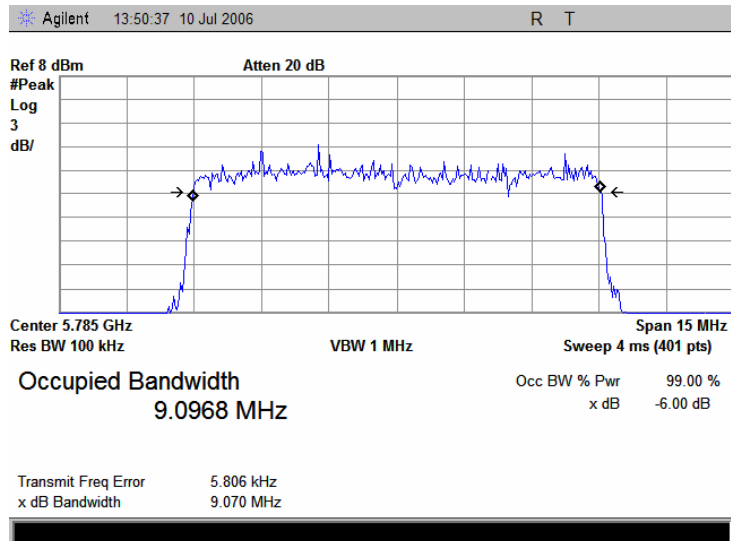

<b>Test specification:</b>	<b>Section 15.247(a)2, 6 dB bandwidth</b>		
<b>Test procedure:</b>	FR Vol.62, page 26243, Section 15.247(a)2		
<b>Test mode:</b>	Compliance	<b>Verdict:</b>	<b>PASS</b>
<b>Date &amp; Time:</b>	7/11/2006 1:16:29 PM		
<b>Temperature:</b> 24°C	<b>Air Pressure:</b> 1010 hPa	<b>Relative Humidity:</b> 36 %	<b>Power Supply:</b> 120 VAC
<b>Remarks:</b>			

Plot 7.1.9 The 6 dB bandwidth test result at high frequency, 10 MHz channel spacing, BPSK

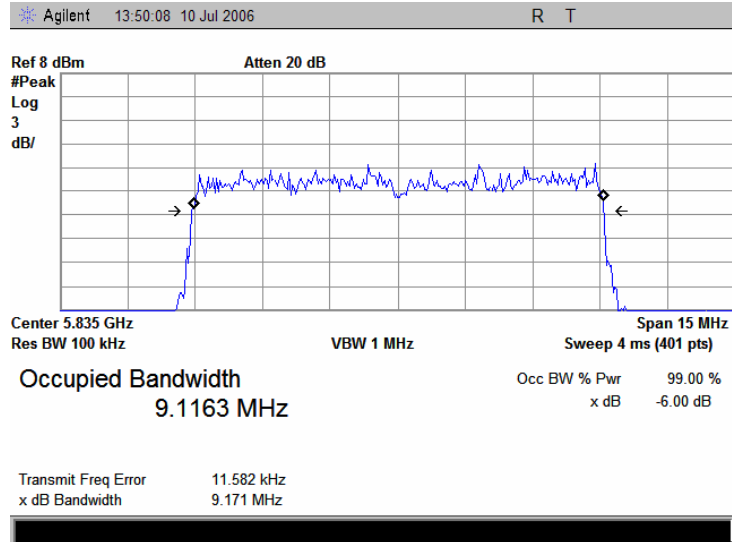

Plot 7.1.10 The 6 dB bandwidth test result at low frequency, 10 MHz channel spacing, 64QAM

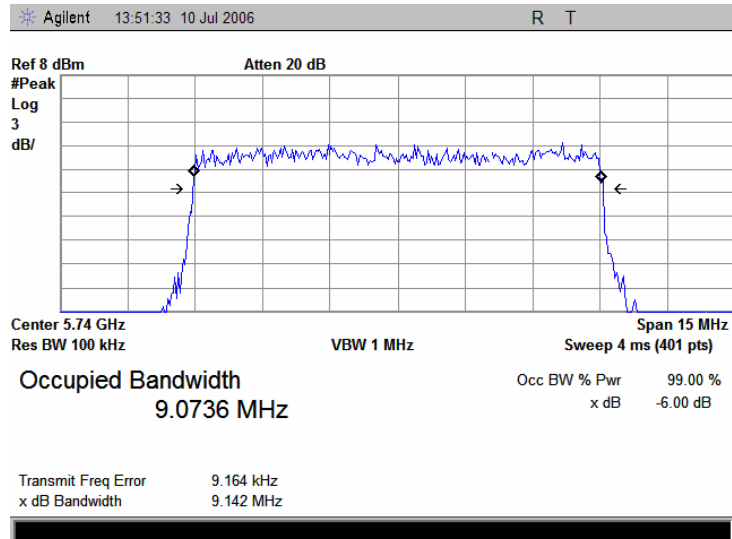

<b>Test specification:</b>	<b>Section 15.247(a)2, 6 dB bandwidth</b>		
<b>Test procedure:</b>	FR Vol.62, page 26243, Section 15.247(a)2		
<b>Test mode:</b>	Compliance	<b>Verdict:</b>	<b>PASS</b>
<b>Date &amp; Time:</b>	7/11/2006 1:16:29 PM		
<b>Temperature:</b> 24°C	<b>Air Pressure:</b> 1010 hPa	<b>Relative Humidity:</b> 36 %	<b>Power Supply:</b> 120 VAC
<b>Remarks:</b>			

Plot 7.1.11 The 6 dB bandwidth test result at mid frequency, 10 MHz channel spacing, 64QAM

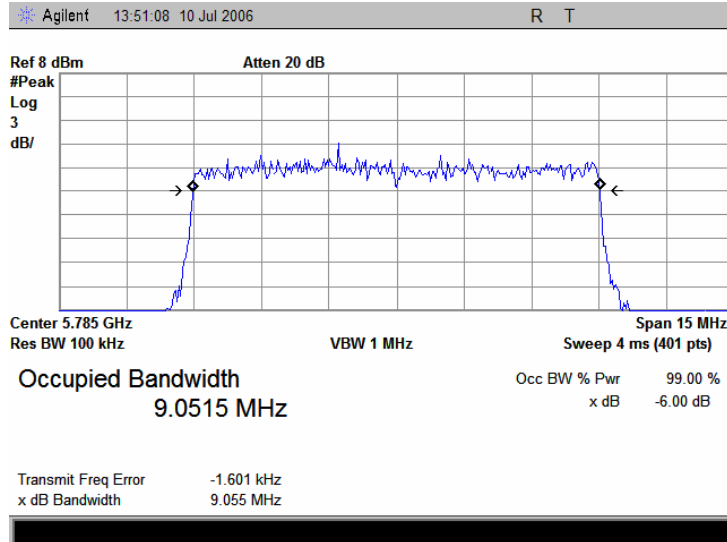

Plot 7.1.12 The 6 dB bandwidth test result at high frequency, 10 MHz channel spacing, 64QAM

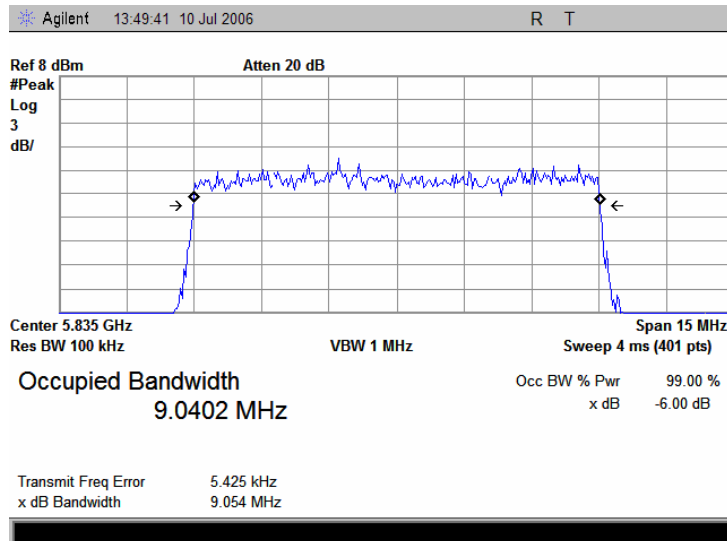

<b>Test specification:</b>		<b>Section 15.247(b)3, Peak output power</b>	
<b>Test procedure:</b>		FR Vol.62, page 26243, Section 15.247(b)	
<b>Test mode:</b>	Compliance	<b>Verdict:</b>	PASS
<b>Date &amp; Time:</b>	10/8/2006 8:58:42 AM		
<b>Temperature:</b> 22°C	<b>Air Pressure:</b> 1012 hPa	<b>Relative Humidity:</b> 48 %	<b>Power Supply:</b> 120 VAC
<b>Remarks:</b>			

## 7.2 Peak output power

### 7.2.1 General

This test was performed to measure the maximum peak output power at the transmitter RF antenna connector. Specification test limits are given in Table 7.2.1.

Table 7.2.1 Peak output power limits

Assigned frequency range, MHz	Maximum antenna gain, dBi	Peak output power*	
		W	dBm
902.0 – 928.0	6.0	1.0	30.0
2400.0 – 2483.5			
5725.0 – 5850.0			

\*- If transmitting antennas of directional gain greater than 6 dBi are used, the peak output power limit shall be reduced below the stated value as follows:

by 1 dB for every 3 dB that the directional gain of antenna exceeds 6 dBi for fixed point-to-point transmitters operate in 2400-2483.5 MHz band;

without any corresponding reduction for fixed point-to-point transmitters operate in 5725-5850 MHz band;

by the amount in dB that the directional gain of antenna exceeds 6 dBi for the rest of transmitters.

### 7.2.2 Test procedure

7.2.2.1 The EUT was set up as shown in Figure 7.2.1, energized and its proper operation was checked.

7.2.2.2 The EUT was adjusted to produce maximum available for end user RF output power.

7.2.2.3 The resolution bandwidth of spectrum analyzer was set wider than 6 dB bandwidth of the EUT and the maximum peak output power was measured as provided in Table 7.2.2 and associated plots.

Figure 7.2.1 Peak output power test setup





<b>Test specification:</b>	<b>Section 15.247(b)3, Peak output power</b>		
<b>Test procedure:</b>	FR Vol.62, page 26243, Section 15.247(b)		
<b>Test mode:</b>	Compliance	<b>Verdict:</b>	<b>PASS</b>
<b>Date &amp; Time:</b>	10/8/2006 8:58:42 AM		
<b>Temperature:</b> 22°C	<b>Air Pressure:</b> 1012 hPa	<b>Relative Humidity:</b> 48 %	<b>Power Supply:</b> 120 VAC
<b>Remarks:</b>			

**Table 7.2.2 Peak output power test results**

ASSIGNED FREQUENCY: 5725 – 5850 MHz  
 MODULATING SIGNAL: PRBS  
 TRANSMITTER OUTPUT POWER SETTINGS: Maximum  
 DETECTOR USED: Peak  
 EUT 6 dB BANDWIDTH: 5 MHz, 10 MHz  
 RESOLUTION BANDWIDTH: 300 kHz  
 VIDEO BANDWIDTH: 3 MHz

Carrier frequency, MHz	Spectrum analyzer reading, dBm	External attenuation, dB	Cable loss, dB	Peak output power, dBm	Limit*, dBm	Margin**, dB	Verdict
<b>5 MHz channel spacing:</b>							
<b>BPSK:</b>							
5728.0	21.85	included	included	21.85	22.0	-0.15	Pass
5785	21.07	included	included	21.07	22.0	-0.93	Pass
5847.0	19.20	included	included	19.20	22.0	-2.80	Pass
<b>64QAM:</b>							
5728.0	21.34	included	included	21.34	22.0	-0.66	Pass
5785	21.06	included	included	21.06	22.0	-0.94	Pass
5847.0	19.06	included	included	19.06	22.0	-2.94	Pass
<b>10 MHz channel spacing:</b>							
<b>BPSK:</b>							
5730.5	21.78	included	included	21.78	22.0	-0.22	Pass
5785	21.02	included	included	21.02	22.0	-0.98	Pass
5844.5	19.21	included	included	19.21	22.0	-2.79	Pass
<b>64QAM:</b>							
5730.5	21.74	included	included	21.74	22.0	-0.26	Pass
5785	20.97	included	included	20.97	22.0	-1.03	Pass
5844.5	19.06	included	included	19.06	22.0	-2.94	Pass

\* - Limit = max EIRP – Antenna gain = 36 – 14 = 22 dBm  
 \*\* - Margin = Peak output power – specification limit.

**Reference numbers of test equipment used**

HL 1650	HL 2254	HL 2780				
---------	---------	---------	--	--	--	--

Full description is given in Appendix A.

<b>Test specification:</b>	<b>Section 15.247(b)3, Peak output power</b>		
<b>Test procedure:</b>	FR Vol.62, page 26243, Section 15.247(b)		
<b>Test mode:</b>	Compliance	<b>Verdict:</b>	<b>PASS</b>
<b>Date &amp; Time:</b>	10/8/2006 8:58:42 AM		
<b>Temperature: 22°C</b>	<b>Air Pressure: 1012 hPa</b>	<b>Relative Humidity: 48 %</b>	<b>Power Supply: 120 VAC</b>
<b>Remarks:</b>			

Plot 7.2.1 Peak output power at low frequency, 5MHz channel spacing, BPSK

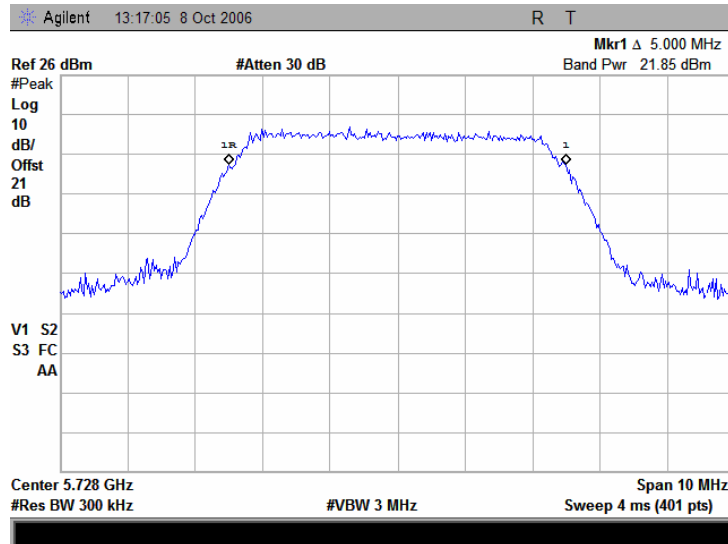

Plot 7.2.2 Peak output power at mid frequency, 5MHz channel spacing, BPSK

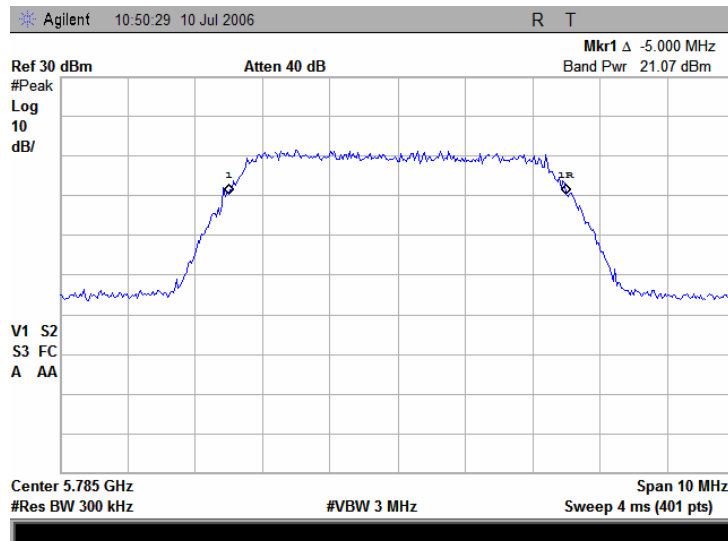

<b>Test specification:</b>	<b>Section 15.247(b)3, Peak output power</b>		
<b>Test procedure:</b>	FR Vol.62, page 26243, Section 15.247(b)		
<b>Test mode:</b>	Compliance	<b>Verdict:</b>	<b>PASS</b>
<b>Date &amp; Time:</b>	10/8/2006 8:58:42 AM		
<b>Temperature:</b> 22°C	<b>Air Pressure:</b> 1012 hPa	<b>Relative Humidity:</b> 48 %	<b>Power Supply:</b> 120 VAC
<b>Remarks:</b>			

Plot 7.2.3 Peak output power at high frequency, 5MHz channel spacing, BPSK

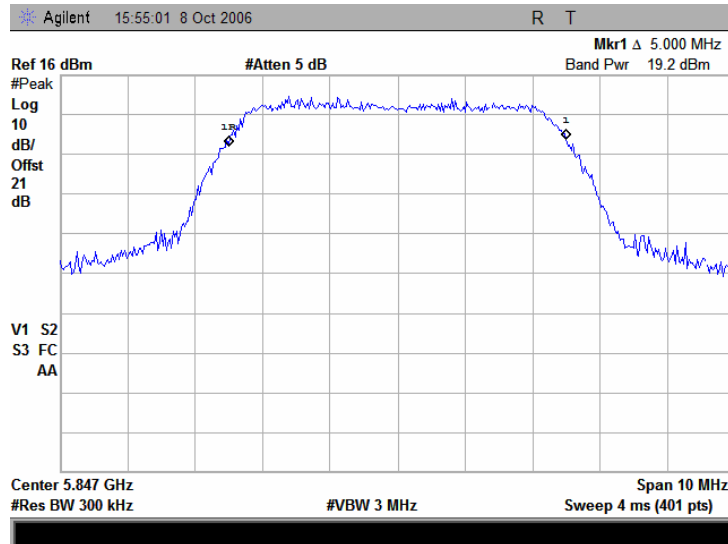

Plot 7.2.4 Peak output power at low frequency, 5MHz channel spacing, 64QAM

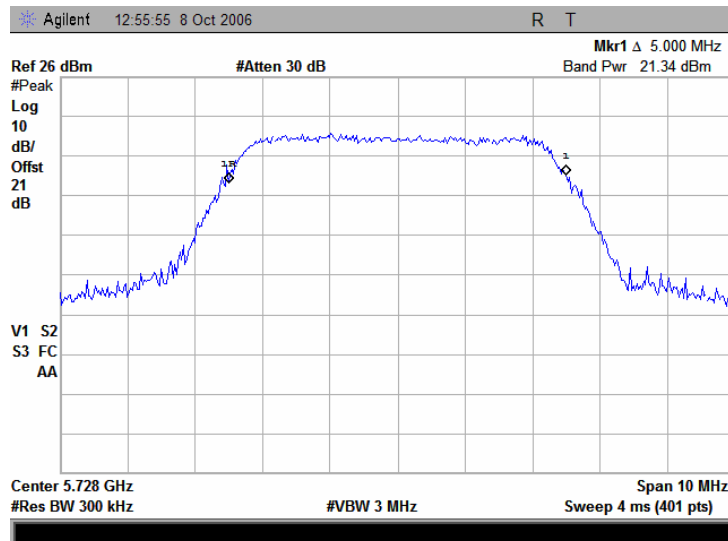

<b>Test specification:</b>	<b>Section 15.247(b)3, Peak output power</b>		
<b>Test procedure:</b>	FR Vol.62, page 26243, Section 15.247(b)		
<b>Test mode:</b>	Compliance	<b>Verdict:</b>	<b>PASS</b>
<b>Date &amp; Time:</b>	10/8/2006 8:58:42 AM		
<b>Temperature:</b> 22°C	<b>Air Pressure:</b> 1012 hPa	<b>Relative Humidity:</b> 48 %	<b>Power Supply:</b> 120 VAC
<b>Remarks:</b>			

Plot 7.2.5 Peak output power at mid frequency, 5MHz channel spacing, 64QAM

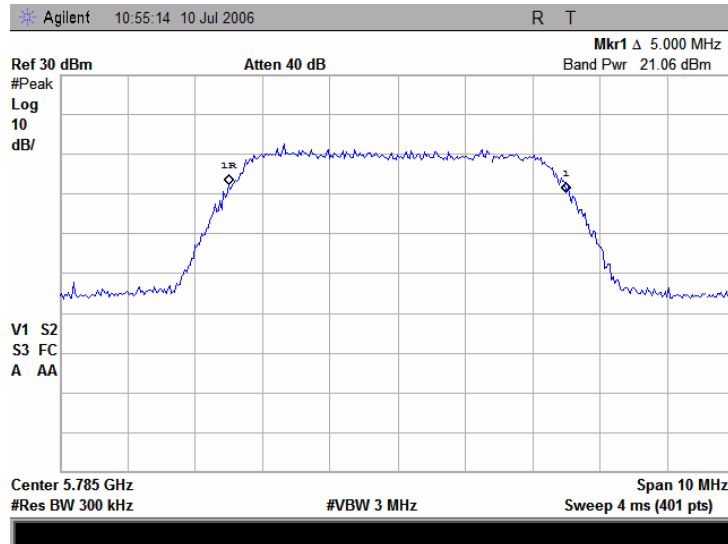

Plot 7.2.6 Peak output power at high frequency, 5MHz channel spacing, 64QAM

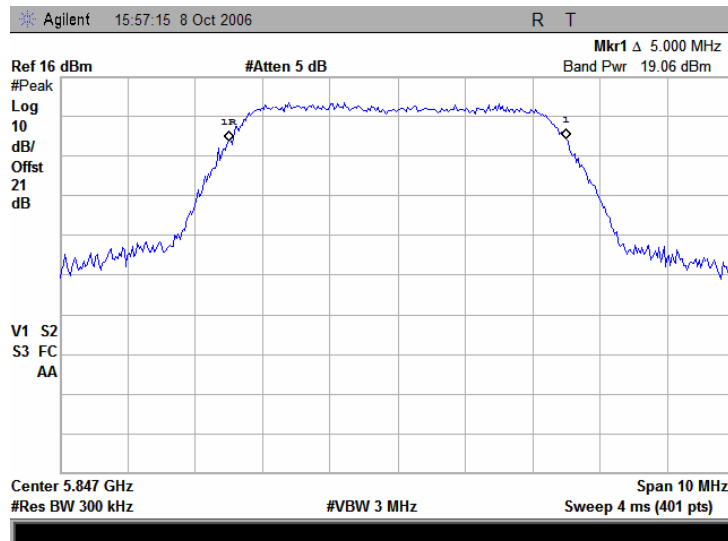

<b>Test specification:</b>	<b>Section 15.247(b)3, Peak output power</b>		
<b>Test procedure:</b>	FR Vol.62, page 26243, Section 15.247(b)		
<b>Test mode:</b>	Compliance	<b>Verdict:</b>	<b>PASS</b>
<b>Date &amp; Time:</b>	10/8/2006 8:58:42 AM		
<b>Temperature:</b> 22°C	<b>Air Pressure:</b> 1012 hPa	<b>Relative Humidity:</b> 48 %	<b>Power Supply:</b> 120 VAC
<b>Remarks:</b>			

Plot 7.2.7 Peak output power at low frequency, 10 MHz channel spacing, BPSK

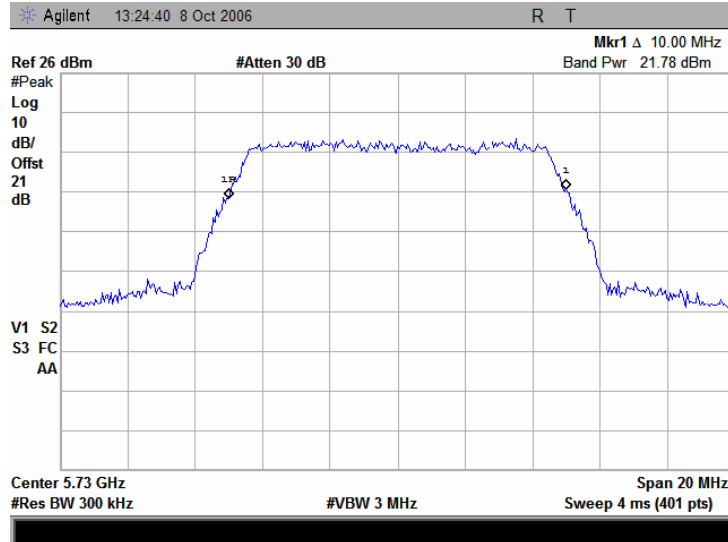

Plot 7.2.8 Peak output power at mid frequency, 10 MHz channel spacing, BPSK

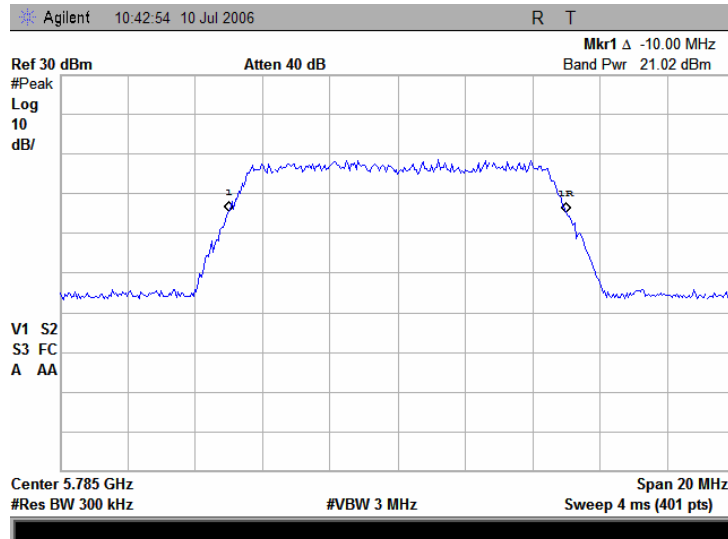

<b>Test specification:</b>	<b>Section 15.247(b)3, Peak output power</b>		
<b>Test procedure:</b>	FR Vol.62, page 26243, Section 15.247(b)		
<b>Test mode:</b>	Compliance	<b>Verdict:</b>	<b>PASS</b>
<b>Date &amp; Time:</b>	10/8/2006 8:58:42 AM		
<b>Temperature:</b> 22°C	<b>Air Pressure:</b> 1012 hPa	<b>Relative Humidity:</b> 48 %	<b>Power Supply:</b> 120 VAC
<b>Remarks:</b>			

Plot 7.2.9 Peak output power at high frequency, 10 MHz channel spacing, BPSK

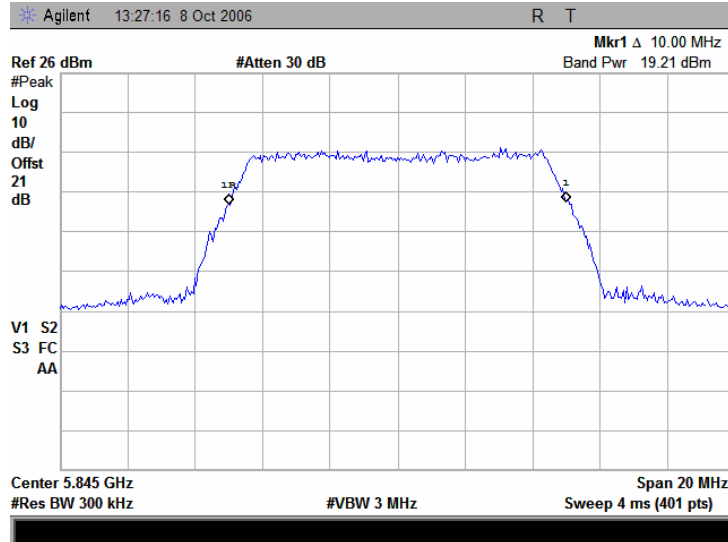

Plot 7.2.10 Peak output power at low frequency, 10 MHz channel spacing, 64QAM

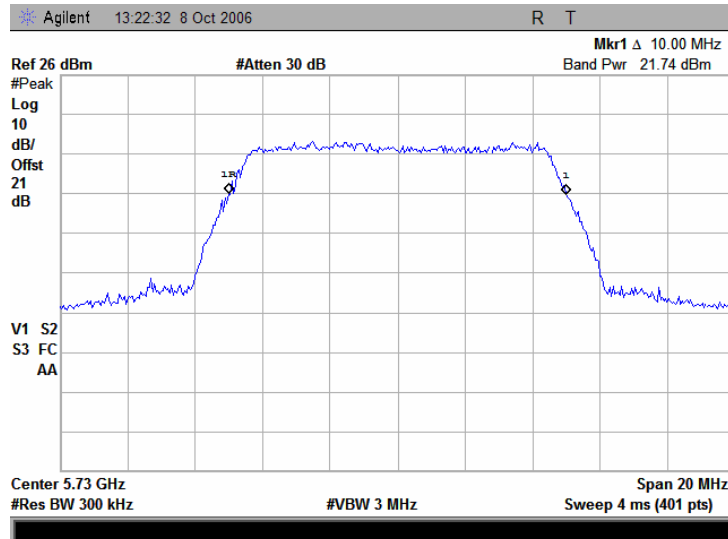

<b>Test specification:</b>	<b>Section 15.247(b)3, Peak output power</b>		
<b>Test procedure:</b>	FR Vol.62, page 26243, Section 15.247(b)		
<b>Test mode:</b>	Compliance	<b>Verdict:</b>	<b>PASS</b>
<b>Date &amp; Time:</b>	10/8/2006 8:58:42 AM		
<b>Temperature:</b> 22°C	<b>Air Pressure:</b> 1012 hPa	<b>Relative Humidity:</b> 48 %	<b>Power Supply:</b> 120 VAC
<b>Remarks:</b>			

Plot 7.2.11 Peak output power at mid frequency, 10 MHz channel spacing, 64QAM

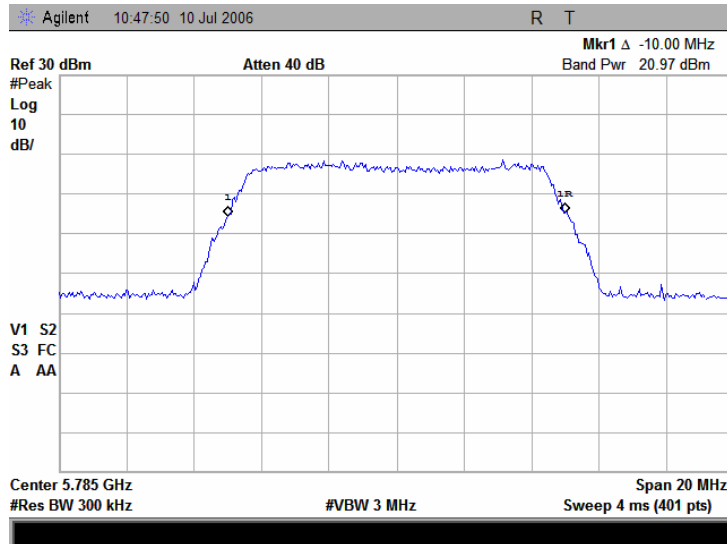

Plot 7.2.12 Peak output power at high frequency, 10 MHz channel spacing, 64QAM

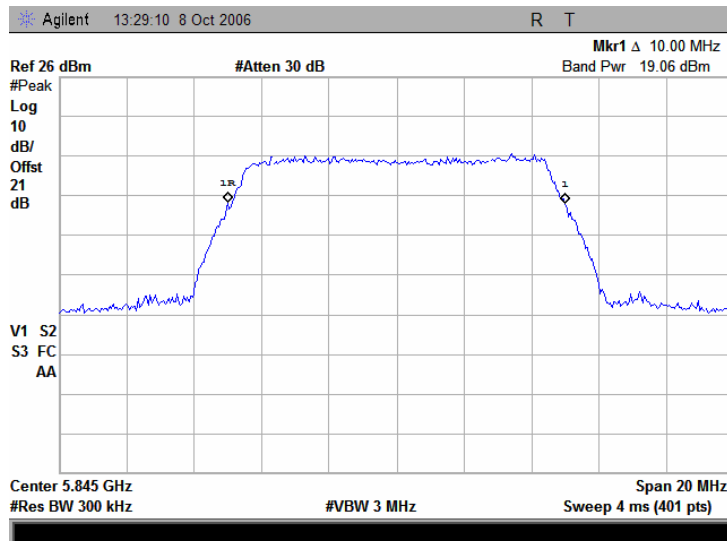

<b>Test specification:</b>	<b>Section 15.247(c), Conducted spurious emissions</b>		
<b>Test procedure:</b>	FR Vol. 62, page 26243, Section 15.247(c)		
<b>Test mode:</b>	Compliance	<b>Verdict:</b>	<b>PASS</b>
<b>Date &amp; Time:</b>	7/11/2006 1:40:05 PM		
<b>Temperature:</b> 24°C	<b>Air Pressure:</b> 1010 hPa	<b>Relative Humidity:</b> 36 %	<b>Power Supply:</b> 120 VAC
<b>Remarks:</b>			

### 7.3 Spurious emissions at RF antenna connector

#### 7.3.1 General

This test was performed to measure spurious emissions at RF antenna connector. Specification test limits are given in Table 7.3.1. The test results are provided in Table 7.3.2 and associated plots.

**Table 7.3.1 Spurious emission limits**

Frequency*, MHz	Attenuation below carrier*, dBc
0.009 – 10 <sup>th</sup> harmonic	20.0

\* - The above limits applied from the lowest radio frequency generated in the device, without going below 9 kHz up to the tenth harmonic of the highest fundamental frequency.

\*\* - Spurious emission limit is provided in terms of attenuation below the peak of modulated carrier measured with the same resolution bandwidth.

#### 7.3.2 Test procedure

**7.3.2.1** The EUT was set up as shown in Figure 7.3.1, energized and its proper operation was checked.

**7.3.2.2** The EUT was adjusted to produce maximum available to end user RF output power.

**7.3.2.3** The highest emission level within the authorized band was measured.

**7.3.2.4** The spurious emission was measured with spectrum analyzer as provided in Table 7.3.2 and associated plots and referenced to the highest emission level measured within the authorized band.

**Figure 7.3.1 Spurious emission test setup**

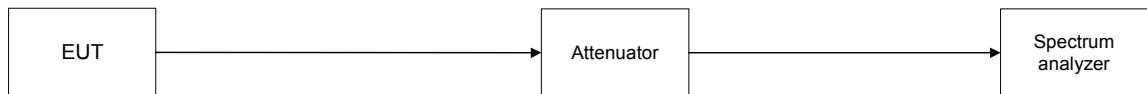



<b>Test specification:</b>		<b>Section 15.247(c), Conducted spurious emissions</b>	
<b>Test procedure:</b>		FR Vol. 62, page 26243, Section 15.247(c)	
<b>Test mode:</b>	Compliance	<b>Verdict:</b>	PASS
<b>Date &amp; Time:</b>	7/11/2006 1:40:05 PM		
<b>Temperature:</b> 24°C	<b>Air Pressure:</b> 1010 hPa	<b>Relative Humidity:</b> 36 %	<b>Power Supply:</b> 120 VAC
<b>Remarks:</b>			

**Table 7.3.2 Spurious emission test results**

ASSIGNED FREQUENCY RANGE: 5725 – 5850 MHz  
 INVESTIGATED FREQUENCY RANGE: 0.009 – 40000 MHz  
 DETECTOR USED: Peak  
 RESOLUTION BANDWIDTH: 100 kHz  
 VIDEO BANDWIDTH: 300 kHz  
 MODULATION: BPSK  
 MODULATING SIGNAL: PRBS  
 TRANSMITTER OUTPUT POWER SETTINGS: Maximum

Frequency, MHz	Spurious emission, dBm	Emission at carrier, dBm	Attenuation below carrier, dBc	Limit, dBc	Margin, dB	Verdict
<b>All carrier frequencies</b>						
All emissions were more than 20 dB below the limit						Pass

**Reference numbers of test equipment used**

HL 1424	HL 1650	HL 2254	HL 2780				
---------	---------	---------	---------	--	--	--	--

Full description is given in Appendix A.

<b>Test specification:</b>	<b>Section 15.247(c), Conducted spurious emissions</b>		
<b>Test procedure:</b>	FR Vol. 62, page 26243, Section 15.247(c)		
<b>Test mode:</b>	Compliance	<b>Verdict:</b>	<b>PASS</b>
<b>Date &amp; Time:</b>	7/11/2006 1:40:05 PM		
<b>Temperature:</b> 24°C	<b>Air Pressure:</b> 1010 hPa	<b>Relative Humidity:</b> 36 %	<b>Power Supply:</b> 120 VAC
<b>Remarks:</b>			

Plot 7.3.1 The highest emission level within the assigned band at low carrier frequency

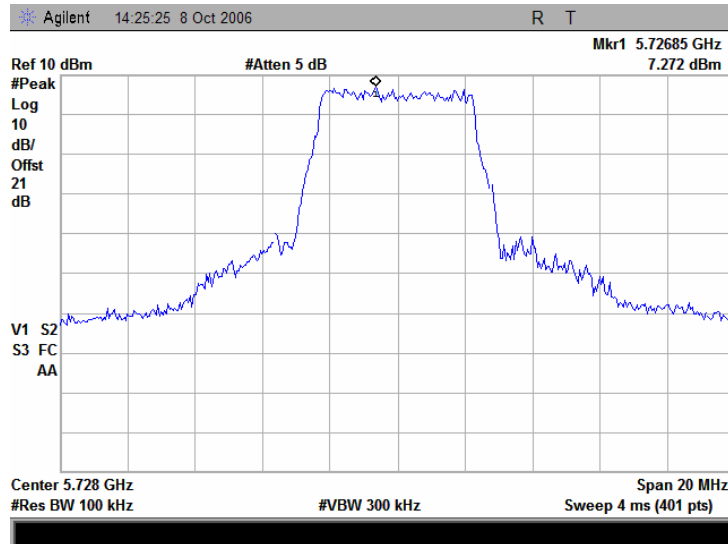

Plot 7.3.2 The highest emission level within the assigned band at mid carrier frequency

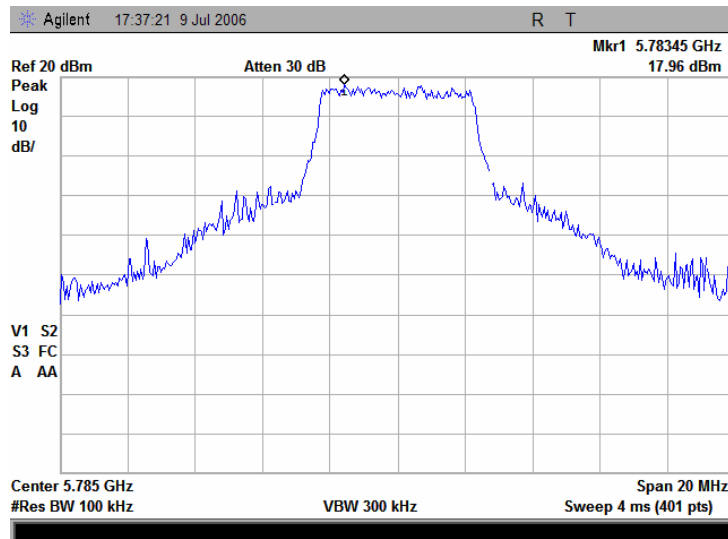

<b>Test specification:</b>	<b>Section 15.247(c), Conducted spurious emissions</b>		
<b>Test procedure:</b>	FR Vol. 62, page 26243, Section 15.247(c)		
<b>Test mode:</b>	Compliance	<b>Verdict:</b>	<b>PASS</b>
<b>Date &amp; Time:</b>	7/11/2006 1:40:05 PM		
<b>Temperature:</b> 24°C	<b>Air Pressure:</b> 1010 hPa	<b>Relative Humidity:</b> 36 %	<b>Power Supply:</b> 120 VAC
<b>Remarks:</b>			

Plot 7.3.3 The highest emission level within the assigned band at high carrier frequency

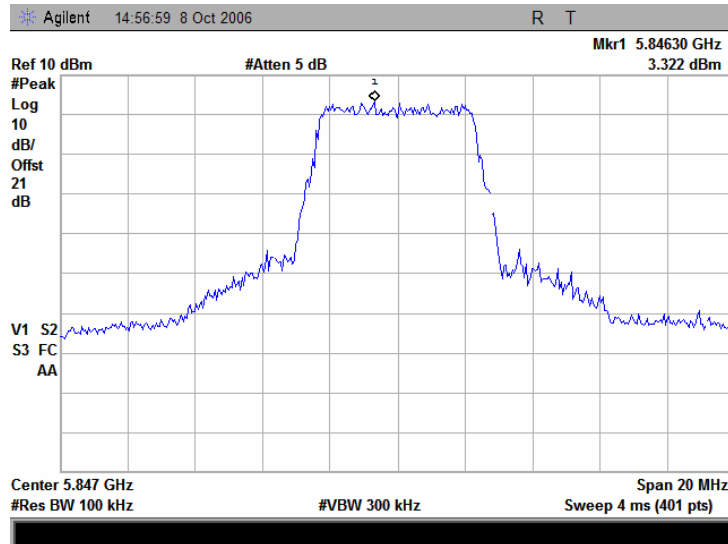

<b>Test specification:</b>	<b>Section 15.247(c), Conducted spurious emissions</b>		
<b>Test procedure:</b>	FR Vol. 62, page 26243, Section 15.247(c)		
<b>Test mode:</b>	Compliance	<b>Verdict:</b>	<b>PASS</b>
<b>Date &amp; Time:</b>	7/11/2006 1:40:05 PM		
<b>Temperature:</b> 24°C	<b>Air Pressure:</b> 1010 hPa	<b>Relative Humidity:</b> 36 %	<b>Power Supply:</b> 120 VAC
<b>Remarks:</b>			

Plot 7.3.4 Spurious emission measurements in 9 - 150 kHz range at low carrier frequency

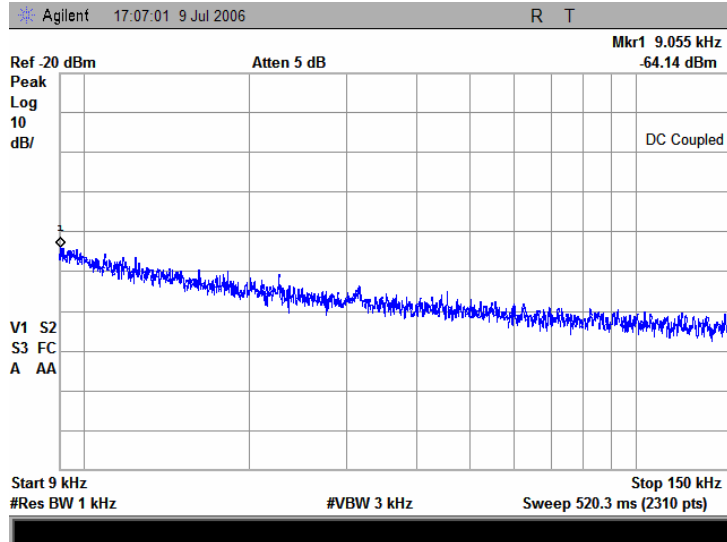

Plot 7.3.5 Spurious emission measurements in 9 - 150 kHz range at mid carrier frequency

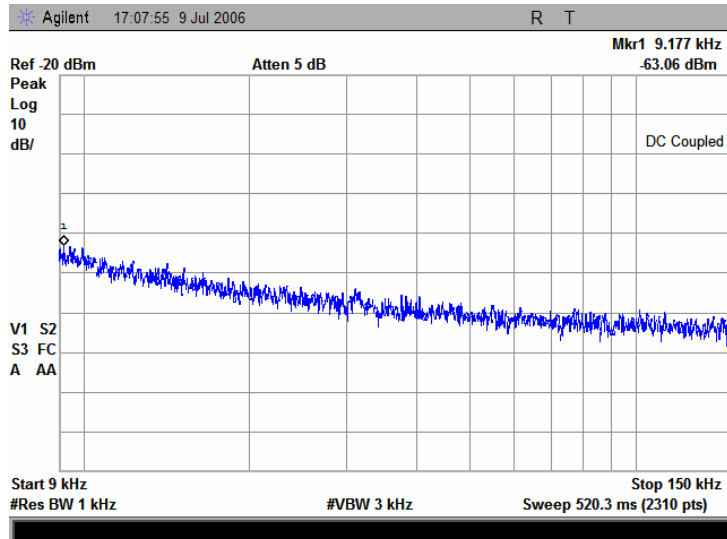

<b>Test specification:</b>	<b>Section 15.247(c), Conducted spurious emissions</b>		
<b>Test procedure:</b>	FR Vol. 62, page 26243, Section 15.247(c)		
<b>Test mode:</b>	Compliance	<b>Verdict:</b>	<b>PASS</b>
<b>Date &amp; Time:</b>	7/11/2006 1:40:05 PM		
<b>Temperature:</b> 24°C	<b>Air Pressure:</b> 1010 hPa	<b>Relative Humidity:</b> 36 %	<b>Power Supply:</b> 120 VAC
<b>Remarks:</b>			

Plot 7.3.6 Spurious emission measurements in 9 - 150 kHz range at high carrier frequency

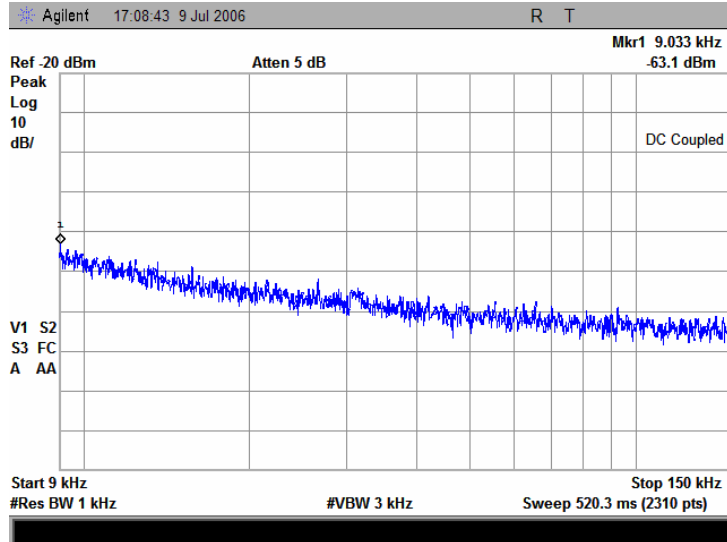

<b>Test specification:</b>	<b>Section 15.247(c), Conducted spurious emissions</b>		
<b>Test procedure:</b>	FR Vol. 62, page 26243, Section 15.247(c)		
<b>Test mode:</b>	Compliance	<b>Verdict:</b>	<b>PASS</b>
<b>Date &amp; Time:</b>	7/11/2006 1:40:05 PM		
<b>Temperature:</b> 24°C	<b>Air Pressure:</b> 1010 hPa	<b>Relative Humidity:</b> 36 %	<b>Power Supply:</b> 120 VAC
<b>Remarks:</b>			

Plot 7.3.7 Spurious emission measurements in 0.15 - 30 MHz range at low carrier frequency

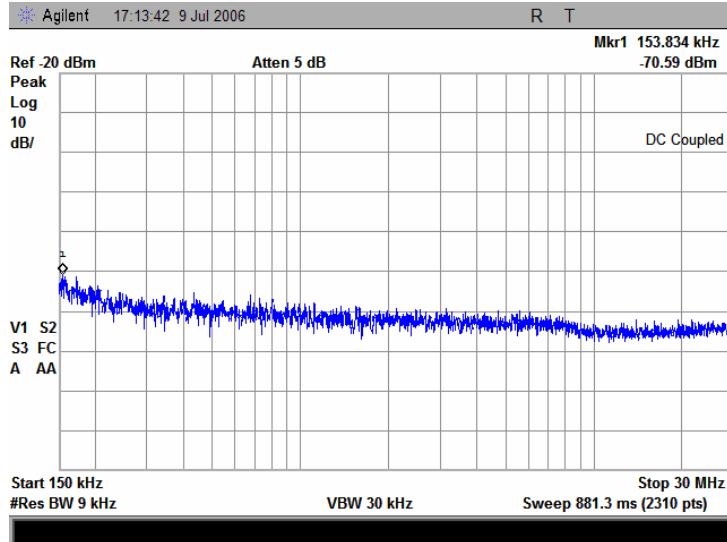

Plot 7.3.8 Spurious emission measurements in 0.15 - 30 MHz range at mid carrier frequency

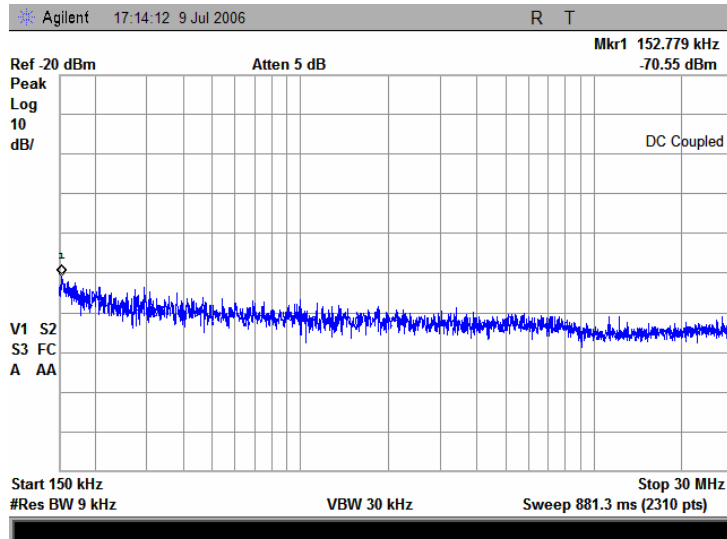

<b>Test specification:</b>	<b>Section 15.247(c), Conducted spurious emissions</b>		
<b>Test procedure:</b>	FR Vol. 62, page 26243, Section 15.247(c)		
<b>Test mode:</b>	Compliance	<b>Verdict:</b>	<b>PASS</b>
<b>Date &amp; Time:</b>	7/11/2006 1:40:05 PM		
<b>Temperature:</b> 24°C	<b>Air Pressure:</b> 1010 hPa	<b>Relative Humidity:</b> 36 %	<b>Power Supply:</b> 120 VAC
<b>Remarks:</b>			

Plot 7.3.9 Spurious emission measurements in 0.15 - 30 MHz range at high carrier frequency

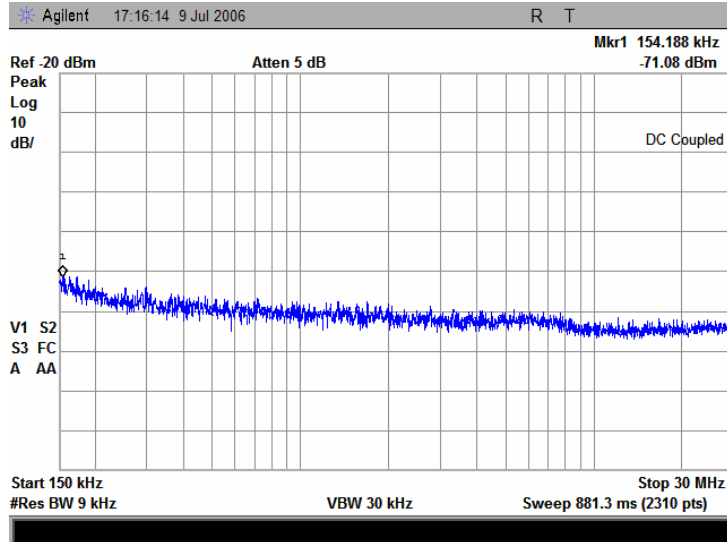

<b>Test specification:</b>	<b>Section 15.247(c), Conducted spurious emissions</b>		
<b>Test procedure:</b>	FR Vol. 62, page 26243, Section 15.247(c)		
<b>Test mode:</b>	Compliance	<b>Verdict:</b>	<b>PASS</b>
<b>Date &amp; Time:</b>	7/11/2006 1:40:05 PM		
<b>Temperature:</b> 24°C	<b>Air Pressure:</b> 1010 hPa	<b>Relative Humidity:</b> 36 %	<b>Power Supply:</b> 120 VAC
<b>Remarks:</b>			

Plot 7.3.10 Spurious emission measurements in 30 - 1000 MHz range at low carrier frequency

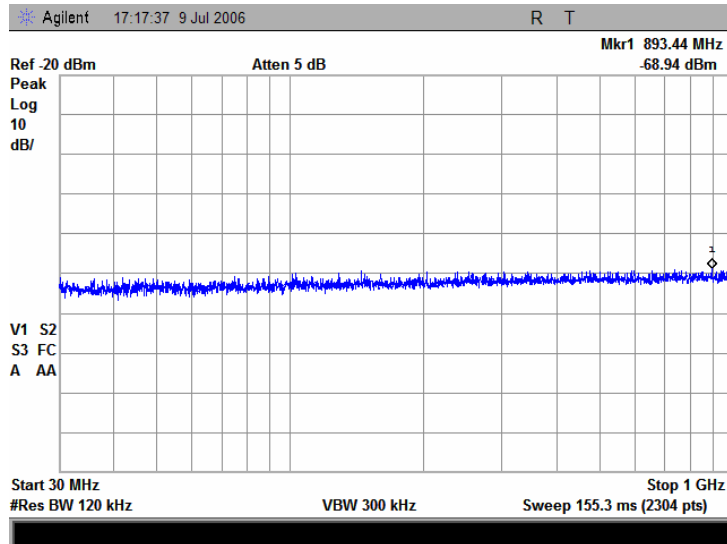

Plot 7.3.11 Spurious emission measurements in 30 - 1000 MHz range at mid carrier frequency

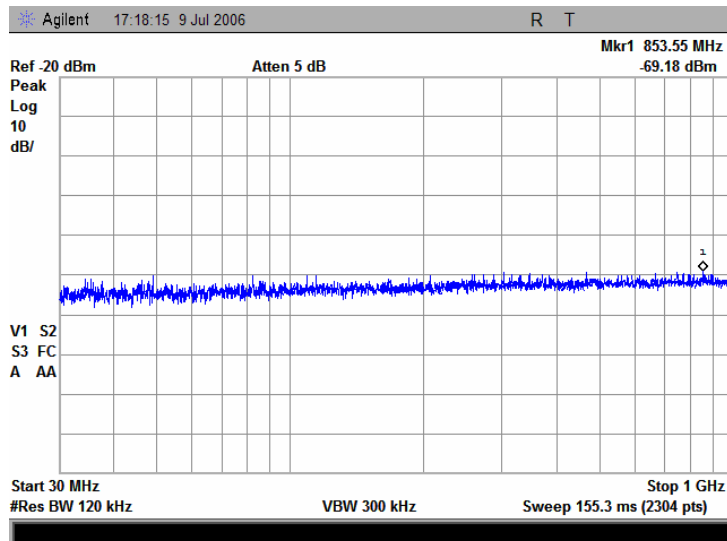



<b>Test specification:</b>	<b>Section 15.247(c), Conducted spurious emissions</b>		
<b>Test procedure:</b>	FR Vol. 62, page 26243, Section 15.247(c)		
<b>Test mode:</b>	Compliance	<b>Verdict:</b>	<b>PASS</b>
<b>Date &amp; Time:</b>	7/11/2006 1:40:05 PM		
<b>Temperature:</b> 24°C	<b>Air Pressure:</b> 1010 hPa	<b>Relative Humidity:</b> 36 %	<b>Power Supply:</b> 120 VAC
<b>Remarks:</b>			

Plot 7.3.12 Spurious emission measurements in 30 - 1000 MHz range at high carrier frequency

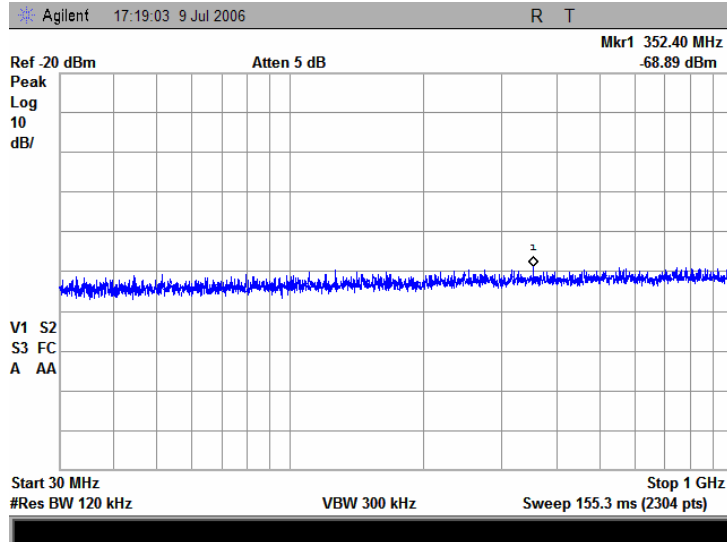

<b>Test specification:</b>	<b>Section 15.247(c), Conducted spurious emissions</b>		
<b>Test procedure:</b>	FR Vol. 62, page 26243, Section 15.247(c)		
<b>Test mode:</b>	Compliance	<b>Verdict:</b>	<b>PASS</b>
<b>Date &amp; Time:</b>	7/11/2006 1:40:05 PM		
<b>Temperature:</b> 24°C	<b>Air Pressure:</b> 1010 hPa	<b>Relative Humidity:</b> 36 %	<b>Power Supply:</b> 120 VAC
<b>Remarks:</b>			

Plot 7.3.13 Spurious emission measurements in 1000 - 5000 MHz range at low carrier frequency

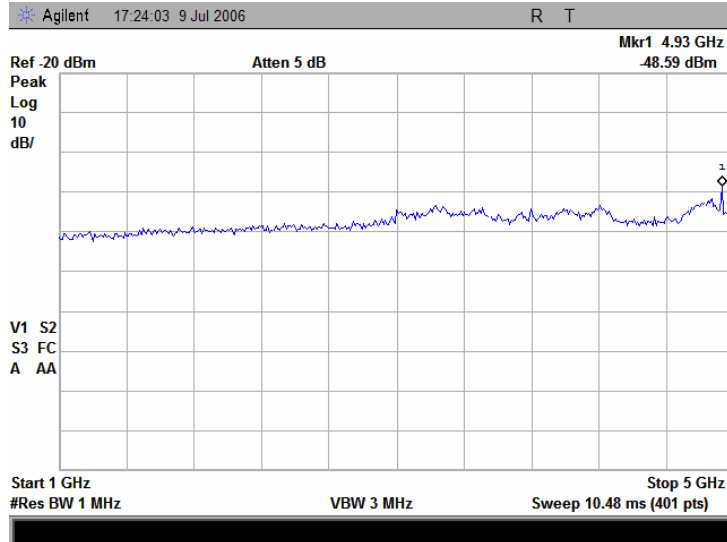

Plot 7.3.14 Spurious emission measurements in 1000 - 5000 MHz range at mid carrier frequency

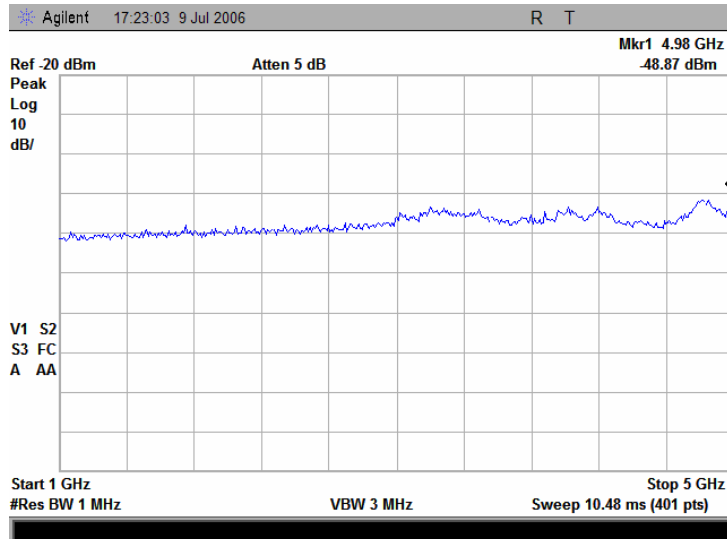

<b>Test specification:</b>	<b>Section 15.247(c), Conducted spurious emissions</b>		
<b>Test procedure:</b>	FR Vol. 62, page 26243, Section 15.247(c)		
<b>Test mode:</b>	Compliance	<b>Verdict:</b>	<b>PASS</b>
<b>Date &amp; Time:</b>	7/11/2006 1:40:05 PM		
<b>Temperature:</b> 24°C	<b>Air Pressure:</b> 1010 hPa	<b>Relative Humidity:</b> 36 %	<b>Power Supply:</b> 120 VAC
<b>Remarks:</b>			

Plot 7.3.15 Spurious emission measurements in 1000 - 5000 MHz range at high carrier frequency

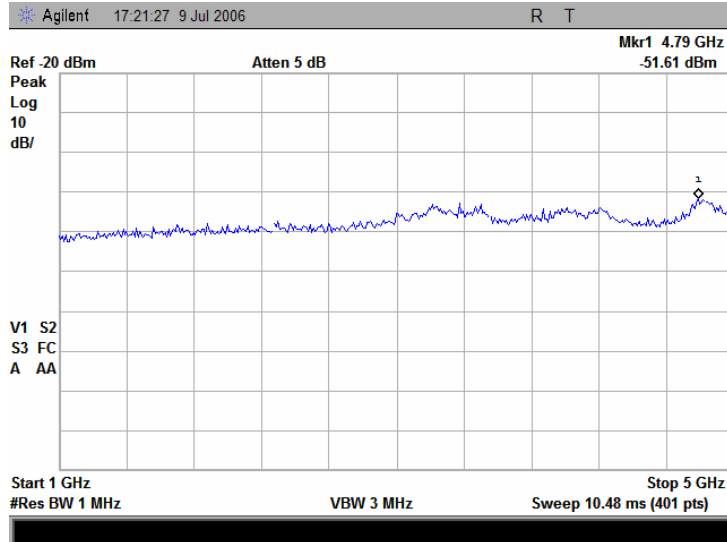

<b>Test specification:</b>	<b>Section 15.247(c), Conducted spurious emissions</b>		
<b>Test procedure:</b>	FR Vol. 62, page 26243, Section 15.247(c)		
<b>Test mode:</b>	Compliance	<b>Verdict:</b>	<b>PASS</b>
<b>Date &amp; Time:</b>	7/11/2006 1:40:05 PM		
<b>Temperature:</b> 24°C	<b>Air Pressure:</b> 1010 hPa	<b>Relative Humidity:</b> 36 %	<b>Power Supply:</b> 120 VAC
<b>Remarks:</b>			

Plot 7.3.16 Spurious emission measurements in 5000 - 5725 MHz range at low carrier frequency

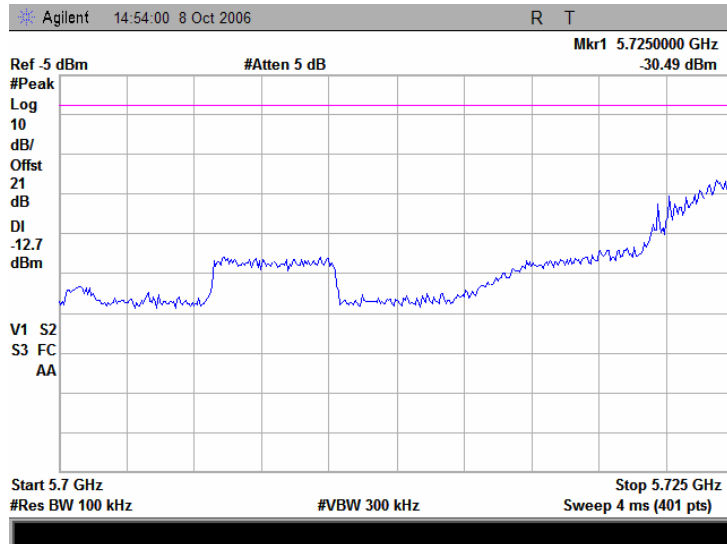

Plot 7.3.17 Spurious emission measurements in 5000 - 5725 MHz range at mid carrier frequency

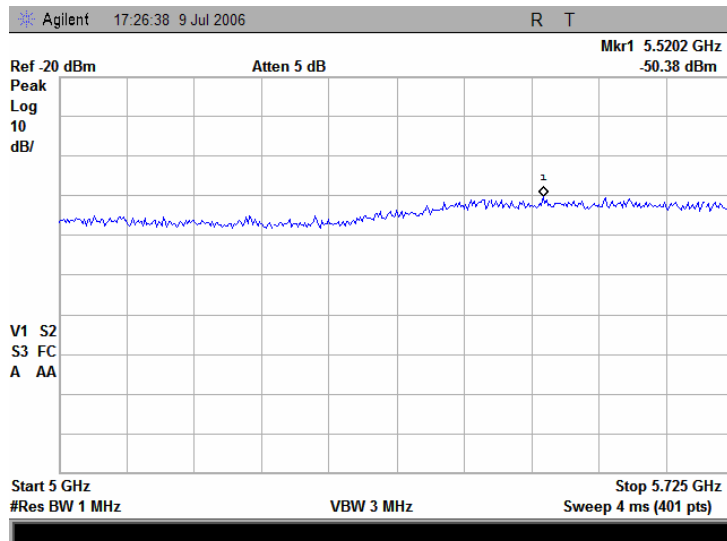

<b>Test specification:</b>	<b>Section 15.247(c), Conducted spurious emissions</b>		
<b>Test procedure:</b>	FR Vol. 62, page 26243, Section 15.247(c)		
<b>Test mode:</b>	Compliance	<b>Verdict:</b>	<b>PASS</b>
<b>Date &amp; Time:</b>	7/11/2006 1:40:05 PM		
<b>Temperature:</b> 24°C	<b>Air Pressure:</b> 1010 hPa	<b>Relative Humidity:</b> 36 %	<b>Power Supply:</b> 120 VAC
<b>Remarks:</b>			

Plot 7.3.18 Spurious emission measurements in 5000 - 5725 MHz range at high carrier frequency

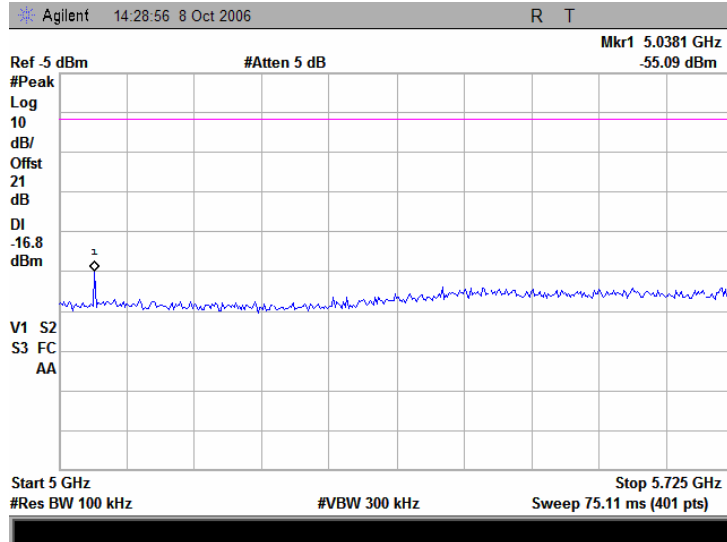

<b>Test specification:</b>	<b>Section 15.247(c), Conducted spurious emissions</b>		
<b>Test procedure:</b>	FR Vol. 62, page 26243, Section 15.247(c)		
<b>Test mode:</b>	Compliance	<b>Verdict:</b>	<b>PASS</b>
<b>Date &amp; Time:</b>	7/11/2006 1:40:05 PM		
<b>Temperature:</b> 24°C	<b>Air Pressure:</b> 1010 hPa	<b>Relative Humidity:</b> 36 %	<b>Power Supply:</b> 120 VAC
<b>Remarks:</b>			

Plot 7.3.19 Spurious emission measurements in 5850 – 6000 MHz range at low carrier frequency

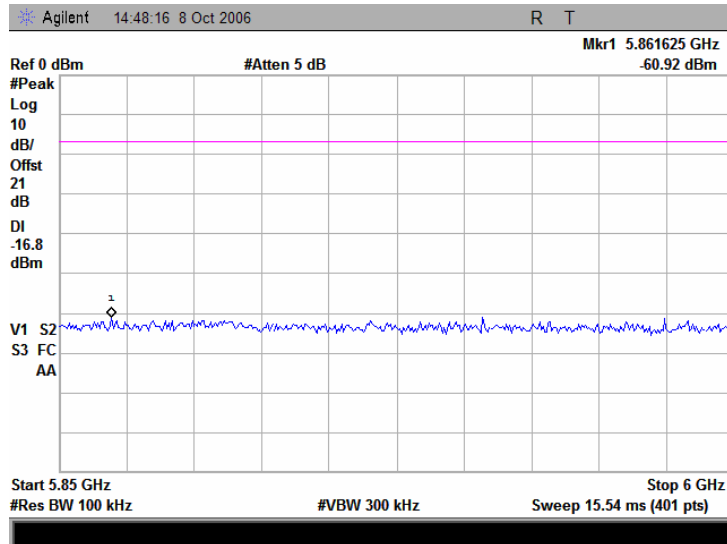

Plot 7.3.20 Spurious emission measurements in 5850 – 6000 MHz range at mid carrier frequency

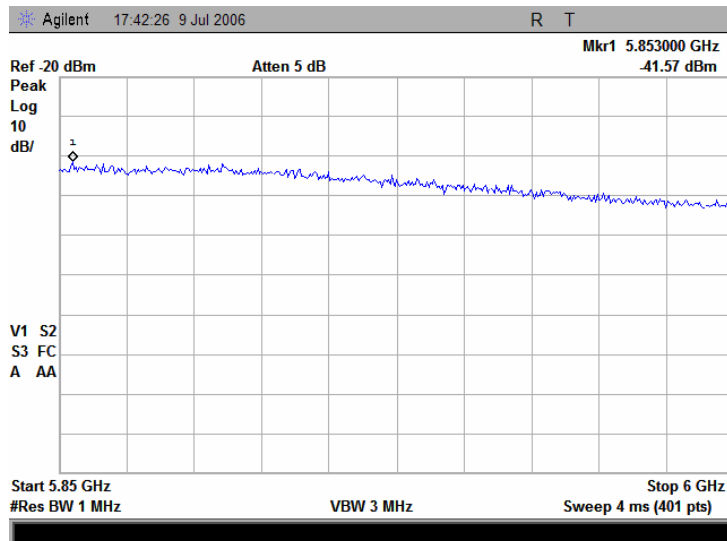

<b>Test specification:</b>	<b>Section 15.247(c), Conducted spurious emissions</b>		
<b>Test procedure:</b>	FR Vol. 62, page 26243, Section 15.247(c)		
<b>Test mode:</b>	Compliance	<b>Verdict:</b>	<b>PASS</b>
<b>Date &amp; Time:</b>	7/11/2006 1:40:05 PM		
<b>Temperature:</b> 24°C	<b>Air Pressure:</b> 1010 hPa	<b>Relative Humidity:</b> 36 %	<b>Power Supply:</b> 120 VAC
<b>Remarks:</b>			

Plot 7.3.21 Spurious emission measurements in 5850 – 5880 MHz range at high carrier frequency

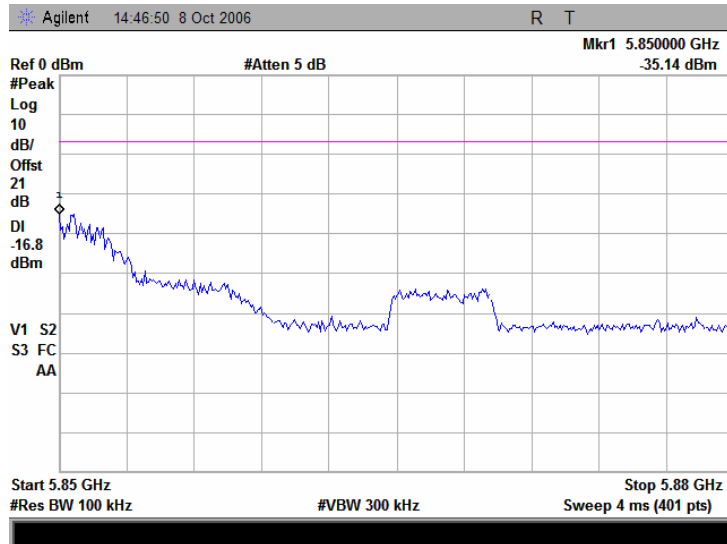

<b>Test specification:</b>	<b>Section 15.247(c), Conducted spurious emissions</b>		
<b>Test procedure:</b>	FR Vol. 62, page 26243, Section 15.247(c)		
<b>Test mode:</b>	Compliance	<b>Verdict:</b>	<b>PASS</b>
<b>Date &amp; Time:</b>	7/11/2006 1:40:05 PM		
<b>Temperature:</b> 24°C	<b>Air Pressure:</b> 1010 hPa	<b>Relative Humidity:</b> 36 %	<b>Power Supply:</b> 120 VAC
<b>Remarks:</b>			

Plot 7.3.22 Spurious emission measurements in 6 – 10 GHz range at low carrier frequency

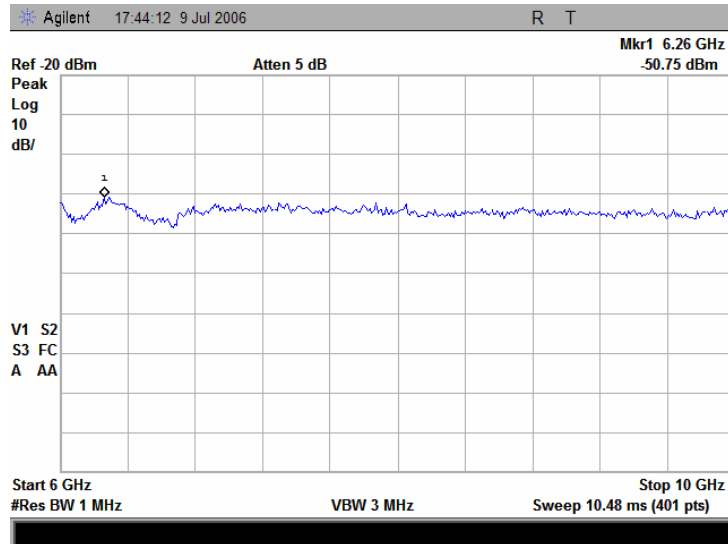

Plot 7.3.23 Spurious emission measurements in 6 – 10 GHz range at mid carrier frequency

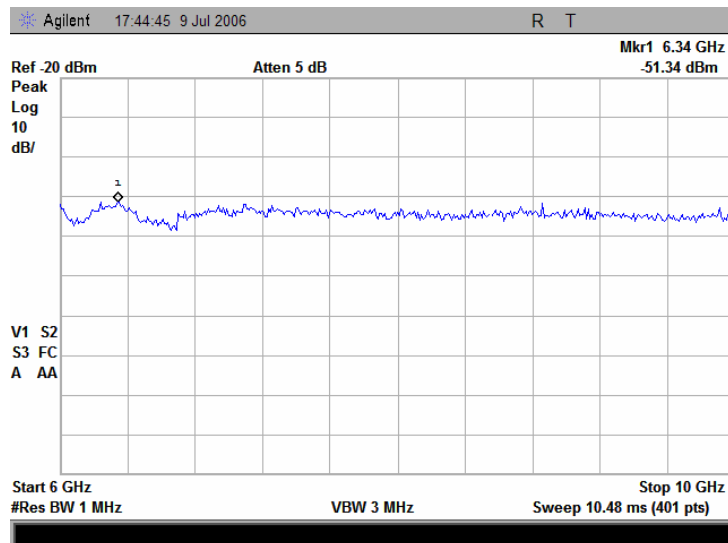



<b>Test specification:</b>	<b>Section 15.247(c), Conducted spurious emissions</b>		
<b>Test procedure:</b>	FR Vol. 62, page 26243, Section 15.247(c)		
<b>Test mode:</b>	Compliance	<b>Verdict:</b>	<b>PASS</b>
<b>Date &amp; Time:</b>	7/11/2006 1:40:05 PM		
<b>Temperature:</b> 24°C	<b>Air Pressure:</b> 1010 hPa	<b>Relative Humidity:</b> 36 %	<b>Power Supply:</b> 120 VAC
<b>Remarks:</b>			

Plot 7.3.24 Spurious emission measurements in 6 – 10 GHz range at high carrier frequency

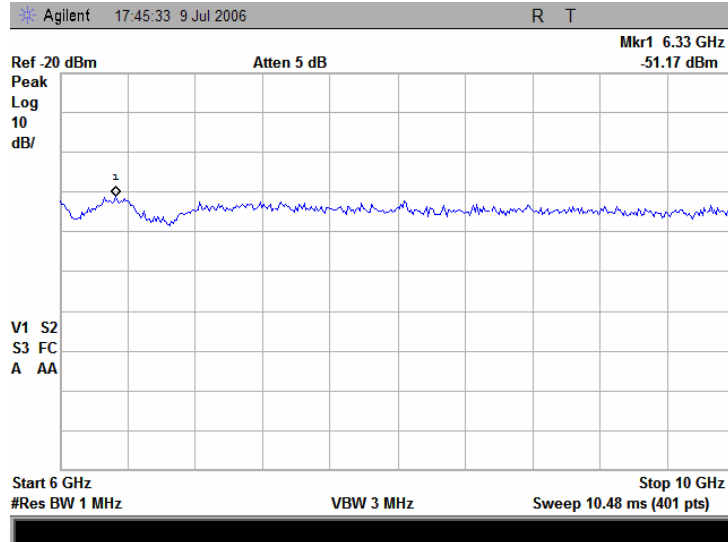

<b>Test specification:</b>	<b>Section 15.247(c), Conducted spurious emissions</b>		
<b>Test procedure:</b>	FR Vol. 62, page 26243, Section 15.247(c)		
<b>Test mode:</b>	Compliance	<b>Verdict:</b>	<b>PASS</b>
<b>Date &amp; Time:</b>	7/11/2006 1:40:05 PM		
<b>Temperature:</b> 24°C	<b>Air Pressure:</b> 1010 hPa	<b>Relative Humidity:</b> 36 %	<b>Power Supply:</b> 120 VAC
<b>Remarks:</b>			

Plot 7.3.25 Spurious emission measurements in 10 – 26.5 GHz range at low carrier frequency

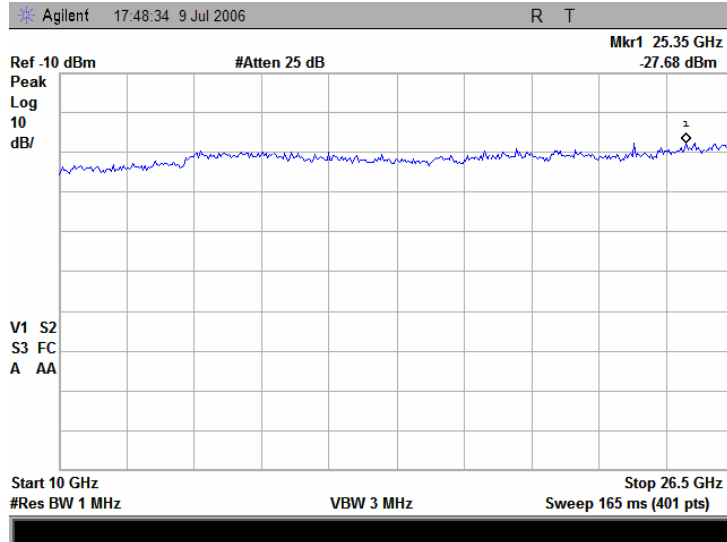

Plot 7.3.26 Spurious emission measurements in 10 – 26.5 GHz range at mid carrier frequency

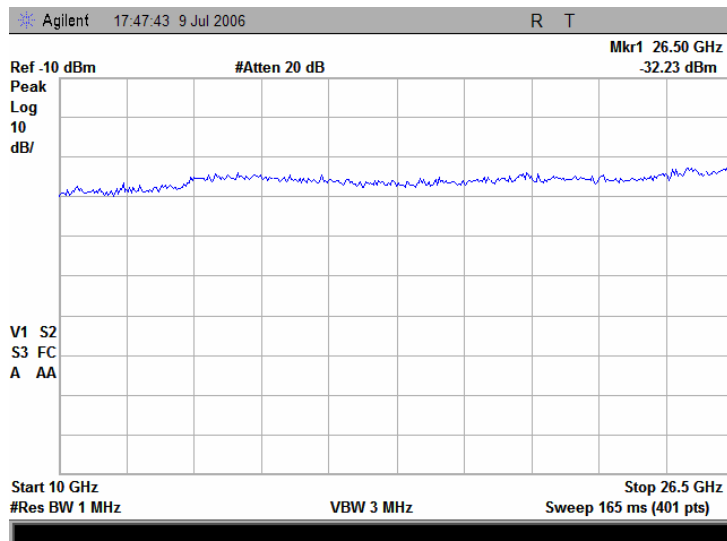

<b>Test specification:</b>	<b>Section 15.247(c), Conducted spurious emissions</b>		
<b>Test procedure:</b>	FR Vol. 62, page 26243, Section 15.247(c)		
<b>Test mode:</b>	Compliance	<b>Verdict:</b>	<b>PASS</b>
<b>Date &amp; Time:</b>	7/11/2006 1:40:05 PM		
<b>Temperature:</b> 24°C	<b>Air Pressure:</b> 1010 hPa	<b>Relative Humidity:</b> 36 %	<b>Power Supply:</b> 120 VAC
<b>Remarks:</b>			

Plot 7.3.27 Spurious emission measurements in 10 – 26.5 GHz range at high carrier frequency

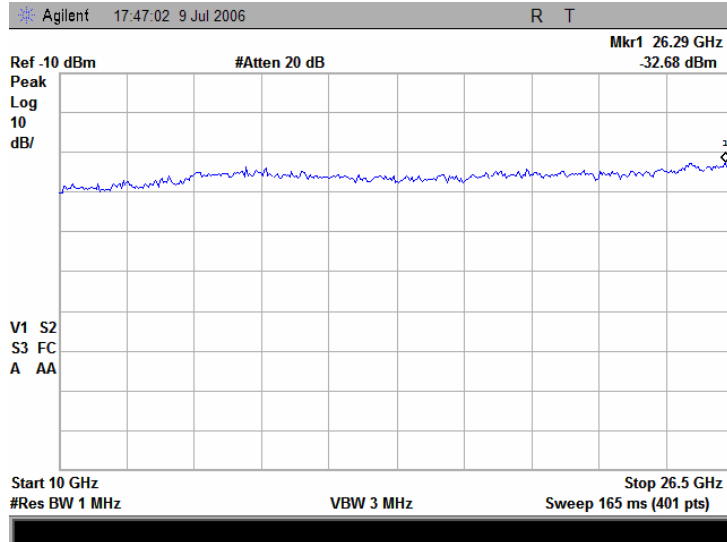

<b>Test specification:</b>	<b>Section 15.247(c), Conducted spurious emissions</b>		
<b>Test procedure:</b>	FR Vol. 62, page 26243, Section 15.247(c)		
<b>Test mode:</b>	Compliance	<b>Verdict:</b>	<b>PASS</b>
<b>Date &amp; Time:</b>	7/11/2006 1:40:05 PM		
<b>Temperature:</b> 24°C	<b>Air Pressure:</b> 1010 hPa	<b>Relative Humidity:</b> 36 %	<b>Power Supply:</b> 120 VAC
<b>Remarks:</b>			

Plot 7.3.28 Spurious emission measurements in 26.5 - 40 GHz range at low carrier frequency

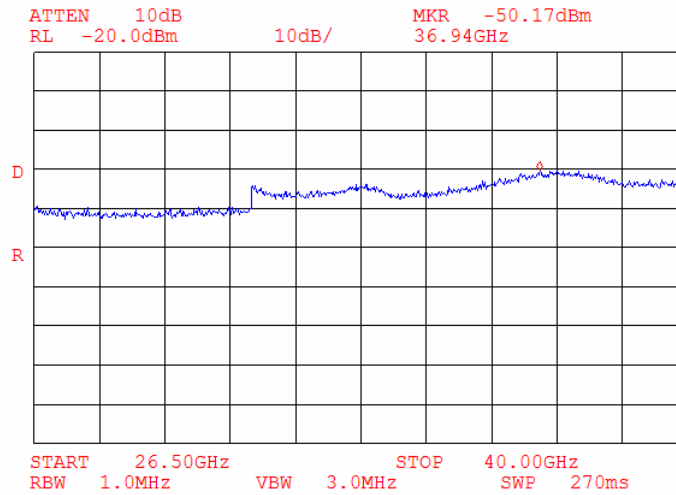

Plot 7.3.29 Spurious emission measurements in 26.5 - 40 GHz range at mid carrier frequency

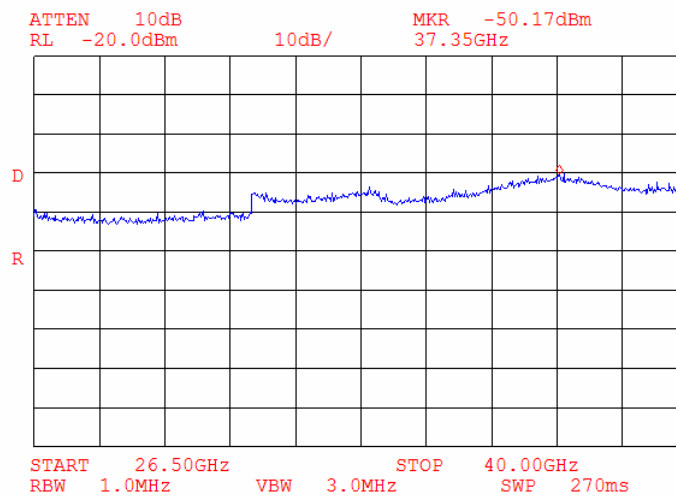

<b>Test specification:</b>	<b>Section 15.247(c), Conducted spurious emissions</b>		
<b>Test procedure:</b>	FR Vol. 62, page 26243, Section 15.247(c)		
<b>Test mode:</b>	Compliance	<b>Verdict:</b>	<b>PASS</b>
<b>Date &amp; Time:</b>	7/11/2006 1:40:05 PM		
<b>Temperature:</b> 24°C	<b>Air Pressure:</b> 1010 hPa	<b>Relative Humidity:</b> 36 %	<b>Power Supply:</b> 120 VAC
<b>Remarks:</b>			

Plot 7.3.30 Spurious emission measurements in 26.5 - 40 GHz range at high carrier frequency

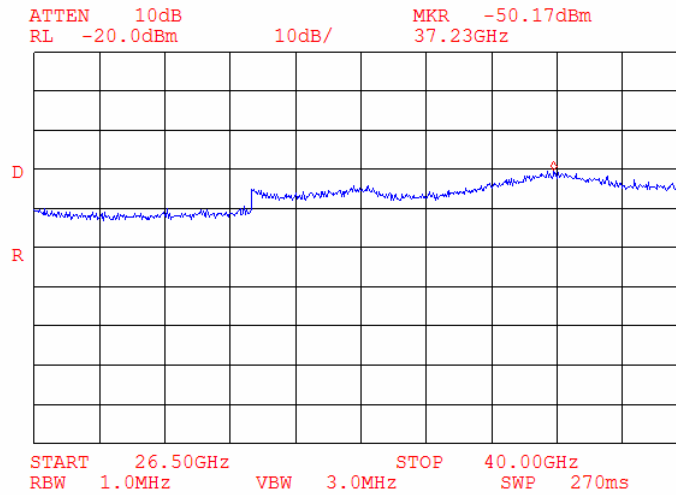

<b>Test specification:</b>		<b>Section 15.247(c), Radiated spurious emissions</b>	
<b>Test procedure:</b>		FR Vol. 62, page 26243, Section 15.247(c) / ANSI C63.4, Section 13.1.4	
<b>Test mode:</b>	Compliance	<b>Verdict:</b>	<b>PASS</b>
<b>Date &amp; Time:</b>	7/14/2006 3:07:51 PM		
<b>Temperature:</b> 24°C	<b>Air Pressure:</b> 1013 hPa	<b>Relative Humidity:</b> 48 %	<b>Power Supply:</b> 120 VAC
<b>Remarks:</b>			

## 7.4 Field strength of spurious emissions

### 7.4.1 General

This test was performed to measure field strength of spurious emissions from the EUT. Specification test limits are given in Table 7.4.1.

Table 7.4.1 Radiated spurious emissions limits

Frequency, MHz	Field strength at 3 m within restricted bands, dB(μV/m)*		
	Peak	Quasi Peak	Average
0.009 – 0.090	148.5 – 128.5	NA	128.5 – 108.5**
0.090 – 0.110	NA	108.5 – 106.8**	NA
0.110 – 0.490	126.8 – 113.8	NA	106.8 – 93.8**
0.490 – 1.705	NA	73.8 – 63.0**	NA
1.705 – 30.0*		69.5	
30 – 88		40.0	
88 – 216		43.5	
216 – 960		46.0	
960 – 1000		54.0	
1000 – 10 <sup>m</sup> harmonic	74.0	NA	54.0

\*- The limit for 3 m test distance was calculated using the inverse square distance extrapolation factor as follows:

$$\text{Lim}_{S_2} = \text{Lim}_{S_1} + 40 \log(S_1/S_2),$$

where  $S_1$  and  $S_2$  – standard defined and test distance respectively in meters.

\*\* - The limit decreases linearly with the logarithm of frequency.

\*\*\* - The field strength limits applied from the lowest radio frequency generated in the device, without going below 9 kHz up to the tenth harmonic of the highest fundamental frequency.

### 7.4.2 Test procedure for spurious emission field strength measurements in 9 kHz to 30 MHz band

7.4.2.1 The EUT was set up as shown in Figure 7.4.1, energized and the performance check was conducted.

7.4.2.2 The specified frequency range was investigated with antenna connected to spectrum analyzer/ EMI receiver. To find maximum radiation the turntable was rotated 360° and the measuring antenna was rotated around its vertical axis.

7.4.2.3 The worst test results (the lowest margins) were recorded and shown in the associated plots.

### 7.4.3 Test procedure for spurious emission field strength measurements above 30 MHz

7.4.3.1 The EUT was set up as shown in Figure 7.4.2, energized and the performance check was conducted.

7.4.3.2 The specified frequency range was investigated with antenna connected to spectrum analyzer/ EMI receiver. To find maximum radiation the turntable was rotated 360°, the measuring antenna height was changed from 1 to 4 m, its polarization was switched from vertical to horizontal.

7.4.3.3 The worst test results (the lowest margins) were recorded and shown in the associated plots.

<b>Test specification:</b>	<b>Section 15.247(c), Radiated spurious emissions</b>		
<b>Test procedure:</b>	FR Vol. 62, page 26243, Section 15.247(c) / ANSI C63.4, Section 13.1.4		
<b>Test mode:</b>	Compliance	<b>Verdict:</b>	<b>PASS</b>
<b>Date &amp; Time:</b>	7/14/2006 3:07:51 PM		
<b>Temperature:</b> 24°C	<b>Air Pressure:</b> 1013 hPa	<b>Relative Humidity:</b> 48 %	<b>Power Supply:</b> 120 VAC
<b>Remarks:</b>			

Figure 7.4.1 Setup for spurious emission field strength measurements below 30 MHz

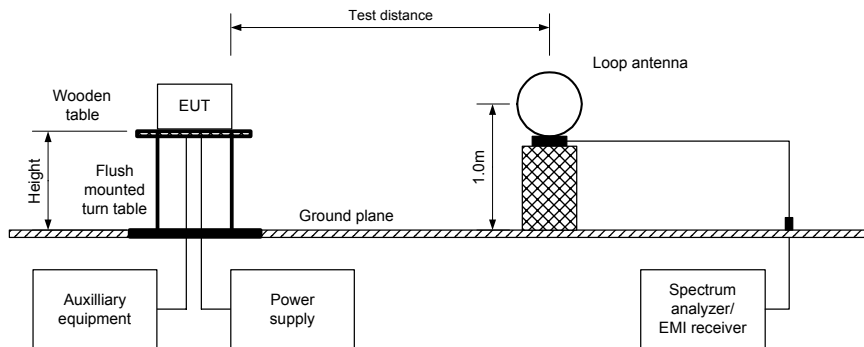
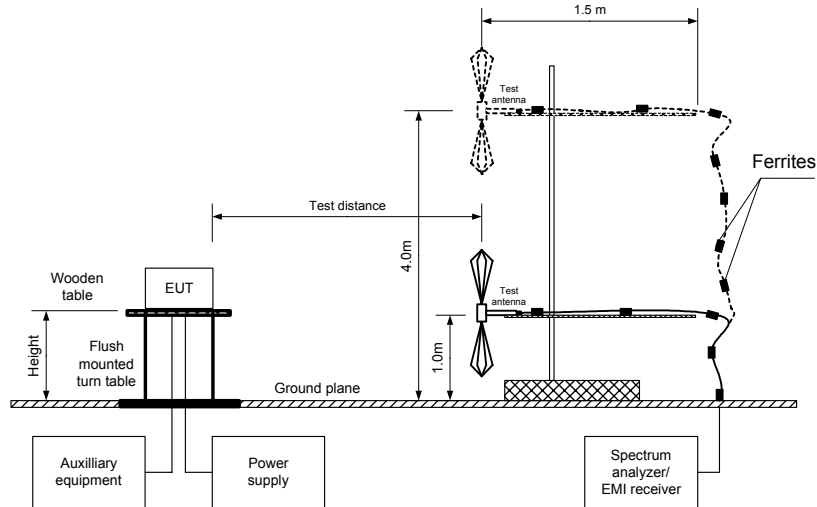

Figure 7.4.2 Setup for spurious emission field strength measurements above 30 MHz



<b>Test specification:</b>		<b>Section 15.247(c), Radiated spurious emissions</b>	
<b>Test procedure:</b>		FR Vol. 62, page 26243, Section 15.247(c) / ANSI C63.4, Section 13.1.4	
<b>Test mode:</b>	Compliance	<b>Verdict:</b>	<b>PASS</b>
<b>Date &amp; Time:</b>	7/14/2006 3:07:51 PM		
<b>Temperature:</b> 24°C	<b>Air Pressure:</b> 1013 hPa	<b>Relative Humidity:</b> 48 %	<b>Power Supply:</b> 120 VAC
<b>Remarks:</b>			

**Table 7.4.2 Field strength of spurious emissions above 1 GHz within restricted bands**

ASSIGNED FREQUENCY: 5725 – 5850 MHz  
 INVESTIGATED FREQUENCY RANGE: 1000 – 40000 MHz  
 TEST DISTANCE: 3 m  
 MODULATION: BPSK  
 MODULATING SIGNAL: PRBS  
 BIT RATE: 2.095 Mbps  
 DUTY CYCLE: 92 %  
 TRANSMITTER OUTPUT POWER SETTINGS: Maximum  
 DETECTOR USED: Peak  
 RESOLUTION BANDWIDTH: 1000 kHz  
 TEST ANTENNA TYPE: Double ridged guide (1000 – 18000 MHz)  
 Standard gain horn (above 18000 MHz)

Frequency, MHz	Antenna		Azimuth, degrees*	Peak field strength(VBW=3 MHz)			Average field strength(VBW=10 Hz)				Verdict
	Polarization	Height, m		Measured, dB(μV/m)	Limit, dB(μV/m)	Margin, dB**	Measured, dB(μV/m)	Calculated, dB(μV/m)	Limit, dB(μV/m)	Margin, dB***	
<b>Low carrier frequency</b>											
No spurious emissions were found											Pass

\*- EUT front panel refers to 0 degrees position of turntable.  
 \*\*- Margin = Measured field strength – specification limit.  
 \*\*\*- Margin = Calculated field strength – specification limit,  
 where Calculated field strength = Measured field strength + average factor.

**Table 7.4.3 Average factor calculation**

Transmission pulse		Transmission burst		Transmission train duration, ms	Average factor, dB
Duration, ms	Period, ms	Duration, ms	Period, ms		
92%					-0.8

\*- Average factor was calculated as follows  
 for pulse train shorter than 100 ms:  $Average\ factor = 20 \times \log_{10} \left( \frac{Pulse\ duration}{Pulse\ period} \times \frac{Burst\ duration}{Train\ duration} \times Number\ of\ bursts\ within\ pulse\ train \right)$   
 for pulse train longer than 100 ms:  $Average\ factor = 20 \times \log_{10} \left( \frac{Pulse\ duration}{Pulse\ period} \times \frac{Burst\ duration}{100\ ms} \times Number\ of\ bursts\ within\ 100\ ms \right)$



<b>Test specification:</b>		<b>Section 15.247(c), Radiated spurious emissions</b>	
<b>Test procedure:</b>		FR Vol. 62, page 26243, Section 15.247(c) / ANSI C63.4, Section 13.1.4	
<b>Test mode:</b>	Compliance	<b>Verdict:</b>	<b>PASS</b>
<b>Date &amp; Time:</b>	7/14/2006 3:07:51 PM		
<b>Temperature:</b> 24°C	<b>Air Pressure:</b> 1013 hPa	<b>Relative Humidity:</b> 48 %	<b>Power Supply:</b> 120 VAC
<b>Remarks:</b>			

**Table 7.4.4 Field strength of spurious emissions below 1 GHz within restricted bands**

ASSIGNED FREQUENCY: 5725 – 5850 MHz  
 INVESTIGATED FREQUENCY RANGE: 0.009 – 1000 MHz  
 TEST DISTANCE: 3 m  
 MODULATION: BPSK  
 MODULATING SIGNAL: PRBS  
 BIT RATE: 2.095 Mbps  
 DUTY CYCLE: 92 %  
 TRANSMITTER OUTPUT POWER SETTINGS: Maximum  
 RESOLUTION BANDWIDTH: 0.2 kHz (9 kHz – 150 kHz)  
 9.0 kHz (150 kHz – 30 MHz)  
 120 kHz (30 MHz – 1000 MHz)  
 VIDEO BANDWIDTH: > Resolution bandwidth  
 TEST ANTENNA TYPE: Active loop (9 kHz – 30 MHz)  
 Biconilog (30 MHz – 1000 MHz)

Frequency, MHz	Peak emission, dB(μV/m)	Quasi-peak			Antenna polarization	Antenna height, m	Turn-table position**, degrees	Verdict
		Measured emission, dB(μV/m)	Limit, dB(μV/m)	Margin, dB*				
All carrier frequency								
No spurious emissions were found								Pass

\*- Margin = Measured emission – specification limit.

\*\* - EUT front panel refer to 0 degrees position of turntable.

**Table 7.4.5 Restricted bands**

MHz	MHz	MHz	MHz	MHz	GHz
0.09 – 0.11	8.37625 – 8.38675	73 – 74.6	399.9 – 410	2690 – 2900	10.6 – 12.7
0.495 – 0.505	8.41425 – 8.41475	74.8 – 75.2	608 – 614	3260 – 3267	13.25 – 13.4
2.1735 – 2.1905	12.29 – 12.293	108 – 121.94	960 – 1240	3332 – 3339	14.47 – 14.5
4.125 – 4.128	12.51975 – 12.52025	123 – 138	1300 – 1427	3345.8 – 3358	15.35 – 16.2
4.17725 – 4.17775	12.57675 – 12.57725	149.9 – 150.05	1435 – 1626.5	3600 – 4400	17.7 – 21.4
4.20725 – 4.20775	13.36 – 13.41	156.52475 – 156.52525	1645.5 – 1646.5	4500 – 5150	22.01 – 23.12
6.215 – 6.218	16.42 – 16.423	156.7 – 156.9	1660 – 1710	5350 – 5460	23.6 – 24
6.26775 – 6.26825	16.69475 – 16.69525	162.0125 – 167.17	1718.8 – 1722.2	7250 – 7750	31.2 – 31.8
6.31175 – 6.31225	16.80425 – 16.80475	167.72 – 173.2	2200 – 2300	8025 – 8500	36.43 – 36.5
8.291 – 8.294	25.5 – 25.67	240 – 285	2310 – 2390	9000 – 9200	Above 38.6
8.362 – 8.366	37.5 – 38.25	322 – 335.4	2483.5 – 2500	9300 – 9500	

**Reference numbers of test equipment used**

HL 0410	HL 0446	HL 0768	HL 0769	HL 1200	HL 1424	HL 1425	HL 1553
HL 1566	HL 1567	HL 2259	HL 2260	HL 2261	HL 2400	HL 2697	HL 2780

Full description is given in Appendix A.

<b>Test specification:</b> Section 15.247(c), Radiated spurious emissions			
<b>Test procedure:</b> FR Vol. 62, page 26243, Section 15.247(c) / ANSI C63.4, Section 13.1.4			
<b>Test mode:</b> Compliance	<b>Verdict:</b> PASS		
<b>Date &amp; Time:</b> 7/14/2006 3:07:51 PM			
<b>Temperature:</b> 24°C	<b>Air Pressure:</b> 1013 hPa	<b>Relative Humidity:</b> 48 %	<b>Power Supply:</b> 120 VAC
<b>Remarks:</b>			

**Plot 7.4.1 Radiated emission measurements from 9 to 150 kHz at the low carrier frequency**

TEST SITE: Anechoic chamber  
TEST DISTANCE: 3 m  
ANTENNA POLARIZATION: Vertical

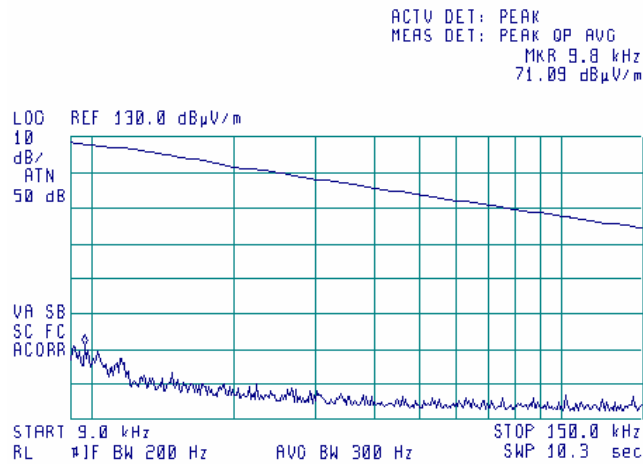

**Plot 7.4.2 Radiated emission measurements from 9 to 150 kHz at the mid carrier frequency**

TEST SITE: Anechoic chamber  
TEST DISTANCE: 3 m  
ANTENNA POLARIZATION: Vertical

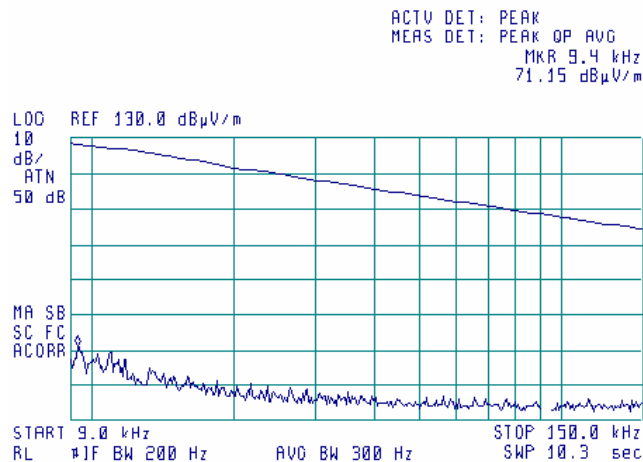

<b>Test specification:</b> Section 15.247(c), Radiated spurious emissions			
<b>Test procedure:</b> FR Vol. 62, page 26243, Section 15.247(c) / ANSI C63.4, Section 13.1.4			
<b>Test mode:</b> Compliance	<b>Verdict:</b> PASS		
<b>Date &amp; Time:</b> 7/14/2006 3:07:51 PM			
<b>Temperature:</b> 24°C	<b>Air Pressure:</b> 1013 hPa	<b>Relative Humidity:</b> 48 %	<b>Power Supply:</b> 120 VAC
<b>Remarks:</b>			

**Plot 7.4.3 Radiated emission measurements from 9 to 150 kHz at the high carrier frequency**

TEST SITE: Anechoic chamber  
TEST DISTANCE: 3 m  
ANTENNA POLARIZATION: Vertical

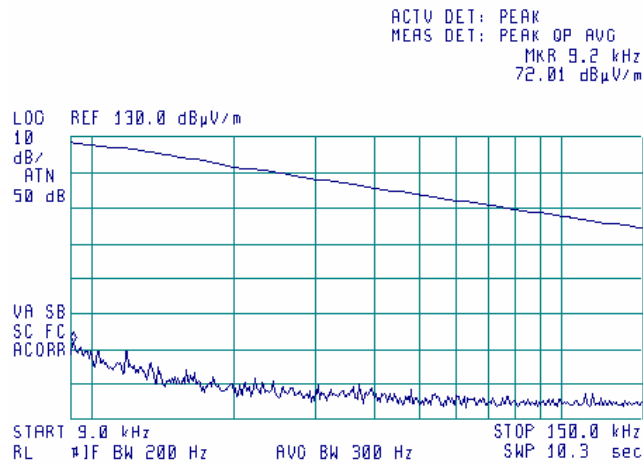

**Plot 7.4.4 Radiated emission measurements from 0.15 to 30 MHz at the low carrier frequency**

TEST SITE: Anechoic chamber  
TEST DISTANCE: 3 m  
ANTENNA POLARIZATION: Vertical

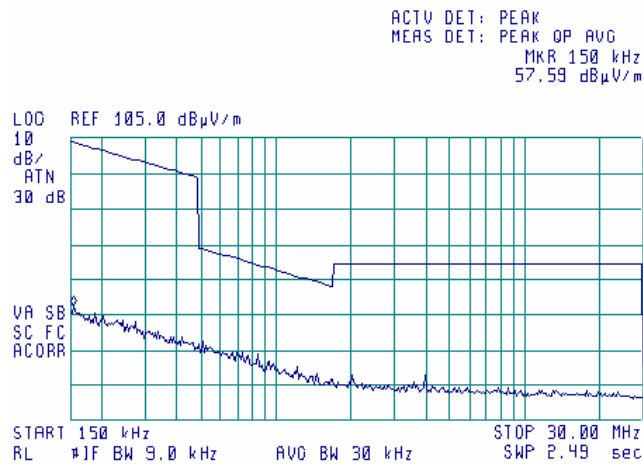

<b>Test specification:</b> Section 15.247(c), Radiated spurious emissions			
<b>Test procedure:</b> FR Vol. 62, page 26243, Section 15.247(c) / ANSI C63.4, Section 13.1.4			
<b>Test mode:</b> Compliance	<b>Verdict:</b> PASS		
<b>Date &amp; Time:</b> 7/14/2006 3:07:51 PM			
<b>Temperature:</b> 24°C	<b>Air Pressure:</b> 1013 hPa	<b>Relative Humidity:</b> 48 %	<b>Power Supply:</b> 120 VAC
<b>Remarks:</b>			

**Plot 7.4.5 Radiated emission measurements from 0.15 to 30 MHz at the mid carrier frequency**

TEST SITE: Anechoic chamber  
TEST DISTANCE: 3 m  
ANTENNA POLARIZATION: Vertical

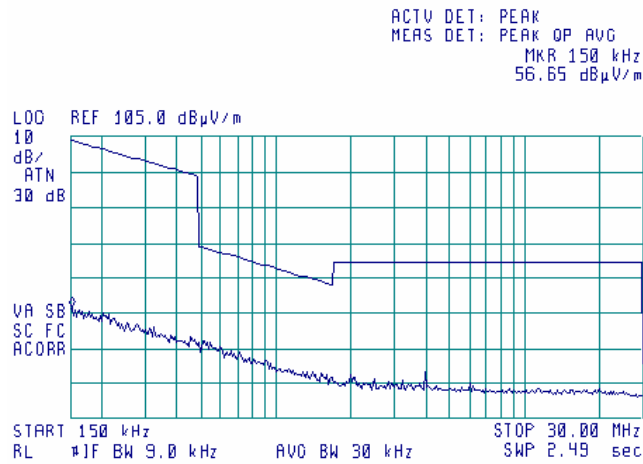

**Plot 7.4.6 Radiated emission measurements from 0.15 to 30 MHz at the high carrier frequency**

TEST SITE: Anechoic chamber  
TEST DISTANCE: 3 m  
ANTENNA POLARIZATION: Vertical

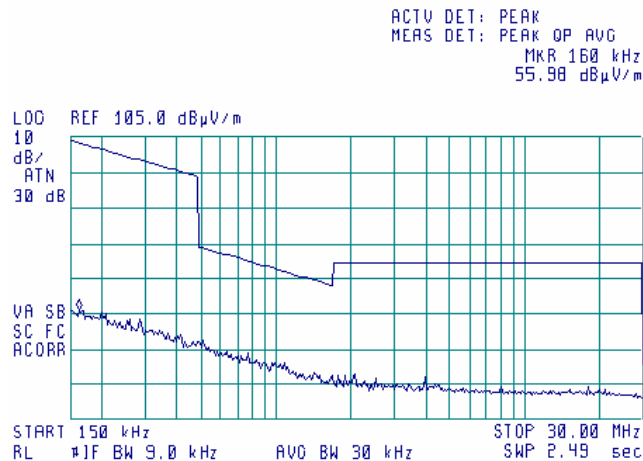

<b>Test specification:</b>		<b>Section 15.247(c), Radiated spurious emissions</b>	
<b>Test procedure:</b>		FR Vol. 62, page 26243, Section 15.247(c) / ANSI C63.4, Section 13.1.4	
<b>Test mode:</b>	Compliance	<b>Verdict:</b>	<b>PASS</b>
<b>Date &amp; Time:</b>	7/14/2006 3:07:51 PM		
<b>Temperature:</b> 24°C	<b>Air Pressure:</b> 1013 hPa	<b>Relative Humidity:</b> 48 %	<b>Power Supply:</b> 120 VAC
<b>Remarks:</b>			

**Plot 7.4.7 Radiated emission measurements from 30 to 1000 MHz at the low carrier frequency**

TEST SITE: Anechoic chamber  
TEST DISTANCE: 3 m  
ANTENNA POLARIZATION: Vertical and Horizontal

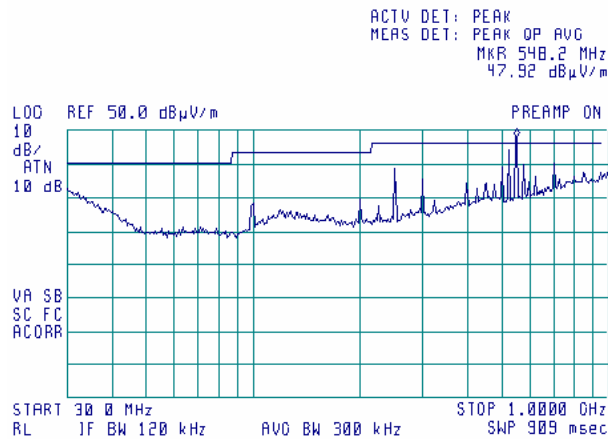

Note: 500 MHz range – outside restricted band emissions – not to be tested radiated

**Plot 7.4.8 Radiated emission measurements from 30 to 1000 MHz at the mid carrier frequency**

TEST SITE: Anechoic chamber  
TEST DISTANCE: 3 m  
ANTENNA POLARIZATION: Vertical and Horizontal

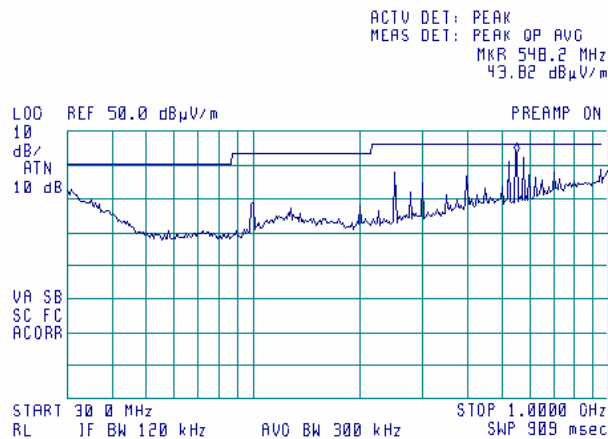

Note: 500 MHz range – outside restricted band emissions – not to be tested radiated

<b>Test specification:</b>		<b>Section 15.247(c), Radiated spurious emissions</b>	
<b>Test procedure:</b>		FR Vol. 62, page 26243, Section 15.247(c) / ANSI C63.4, Section 13.1.4	
<b>Test mode:</b>	Compliance	<b>Verdict:</b>	<b>PASS</b>
<b>Date &amp; Time:</b>	7/14/2006 3:07:51 PM		
<b>Temperature:</b> 24°C	<b>Air Pressure:</b> 1013 hPa	<b>Relative Humidity:</b> 48 %	<b>Power Supply:</b> 120 VAC
<b>Remarks:</b>			

Plot 7.4.9 Radiated emission measurements from 30 to 1000 MHz at the high carrier frequency

TEST SITE: Anechoic chamber  
TEST DISTANCE: 3 m  
ANTENNA POLARIZATION: Vertical and Horizontal

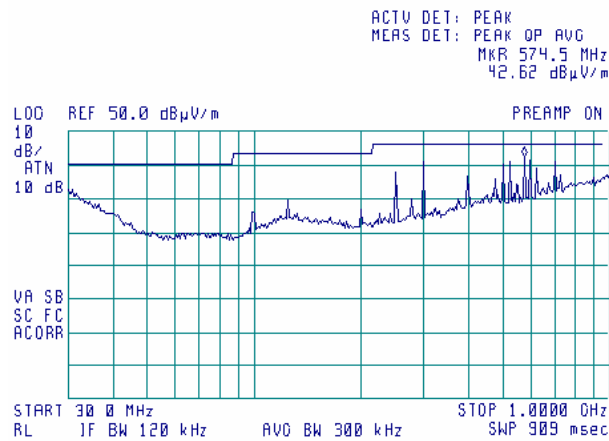

Note: 500 MHz range – outside restricted band emissions – not to be tested radiated.

<b>Test specification:</b> Section 15.247(c), Radiated spurious emissions			
<b>Test procedure:</b> FR Vol. 62, page 26243, Section 15.247(c) / ANSI C63.4, Section 13.1.4			
<b>Test mode:</b> Compliance	<b>Verdict:</b> PASS		
<b>Date &amp; Time:</b> 7/14/2006 3:07:51 PM			
<b>Temperature:</b> 24°C	<b>Air Pressure:</b> 1013 hPa	<b>Relative Humidity:</b> 48 %	<b>Power Supply:</b> 120 VAC
<b>Remarks:</b>			

**Plot 7.4.10 Radiated emission measurements from 1000 to 2900 MHz at the low carrier frequency**

TEST SITE: Anechoic chamber  
 TEST DISTANCE: 3 m  
 ANTENNA POLARIZATION: Vertical and Horizontal  
 DETECTOR: Peak

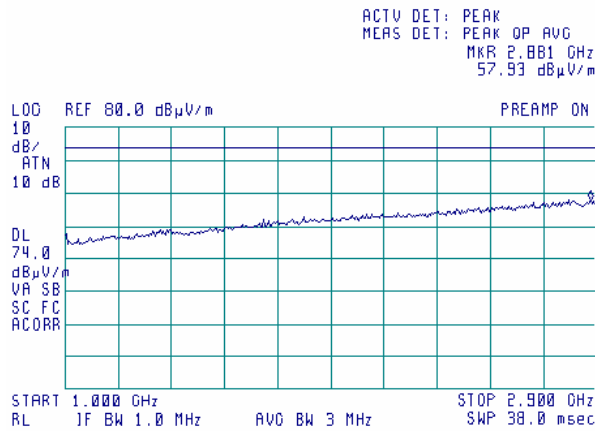

**Plot 7.4.11 Radiated emission measurements from 1000 to 2900 MHz at the low carrier frequency**

TEST SITE: Anechoic chamber  
 TEST DISTANCE: 3 m  
 ANTENNA POLARIZATION: Vertical and Horizontal  
 DETECTOR: Average

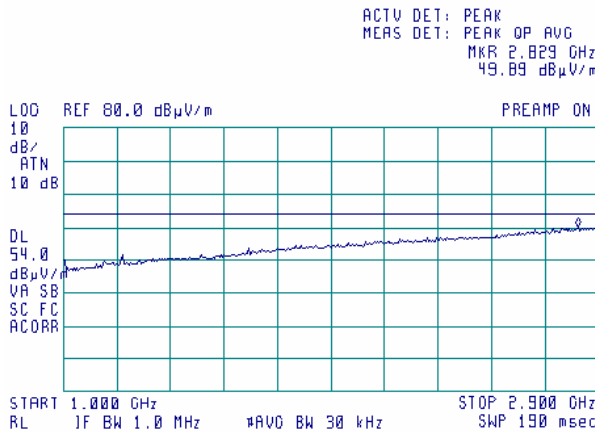

<b>Test specification:</b>		<b>Section 15.247(c), Radiated spurious emissions</b>	
<b>Test procedure:</b> FR Vol. 62, page 26243, Section 15.247(c) / ANSI C63.4, Section 13.1.4			
<b>Test mode:</b>	Compliance	<b>Verdict:</b> PASS	
<b>Date &amp; Time:</b>	7/14/2006 3:07:51 PM		
<b>Temperature:</b> 24°C	<b>Air Pressure:</b> 1013 hPa	<b>Relative Humidity:</b> 48 %	<b>Power Supply:</b> 120 VAC
<b>Remarks:</b>			

**Plot 7.4.12 Radiated emission measurements from 1000 to 2900 MHz at the mid carrier frequency**

TEST SITE: Anechoic chamber  
 TEST DISTANCE: 3 m  
 ANTENNA POLARIZATION: Vertical and Horizontal  
 DETECTOR: Peak

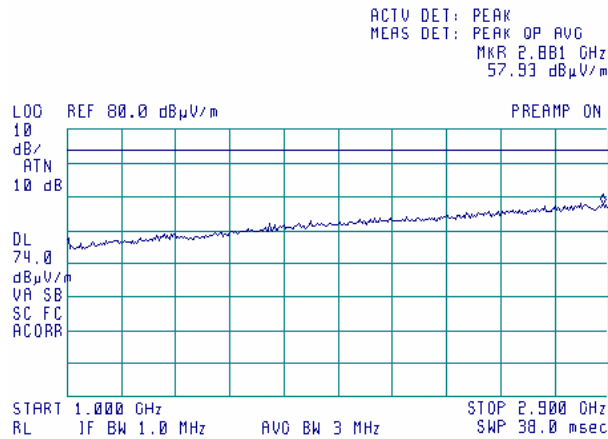

**Plot 7.4.13 Radiated emission measurements from 1000 to 2900 MHz at the mid carrier frequency**

TEST SITE: Anechoic chamber  
 TEST DISTANCE: 3 m  
 ANTENNA POLARIZATION: Vertical and Horizontal  
 DETECTOR: Average

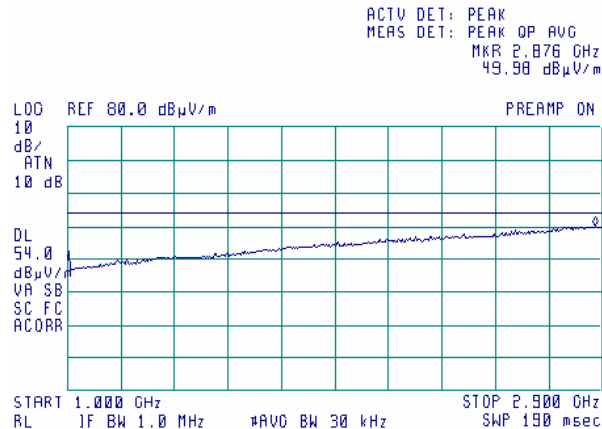



<b>Test specification:</b> Section 15.247(c), Radiated spurious emissions			
<b>Test procedure:</b> FR Vol. 62, page 26243, Section 15.247(c) / ANSI C63.4, Section 13.1.4			
<b>Test mode:</b> Compliance	<b>Verdict:</b> PASS		
<b>Date &amp; Time:</b> 7/14/2006 3:07:51 PM			
<b>Temperature:</b> 24°C	<b>Air Pressure:</b> 1013 hPa	<b>Relative Humidity:</b> 48 %	<b>Power Supply:</b> 120 VAC
<b>Remarks:</b>			

Plot 7.4.14 Radiated emission measurements from 1000 to 2900 MHz at the high carrier frequency

TEST SITE: Anechoic chamber  
TEST DISTANCE: 3 m  
ANTENNA POLARIZATION: Vertical and Horizontal  
DETECTOR: Peak

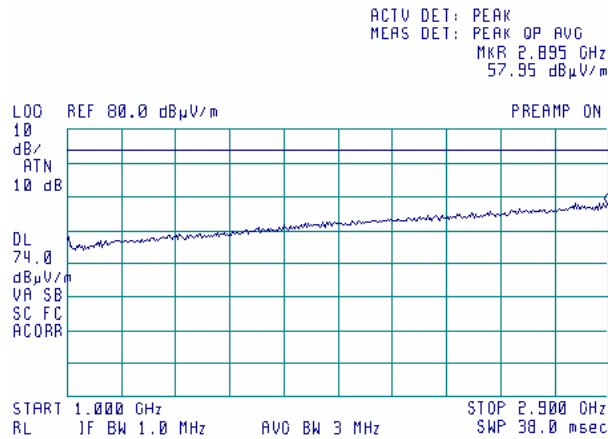

Plot 7.4.15 Radiated emission measurements from 1000 to 2900 MHz at the High carrier frequency

TEST SITE: Anechoic chamber  
TEST DISTANCE: 3 m  
ANTENNA POLARIZATION: Vertical and Horizontal  
DETECTOR: Average

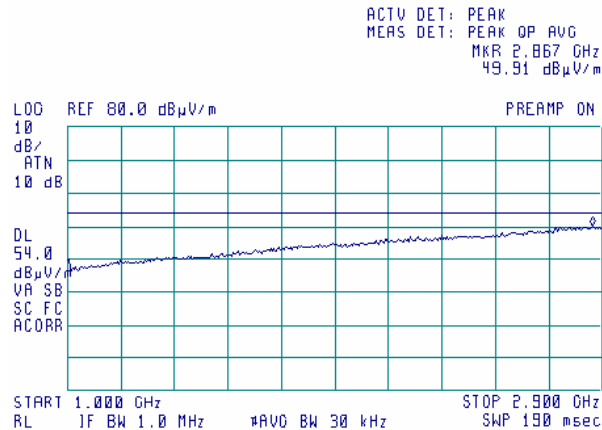

<b>Test specification:</b> Section 15.247(c), Radiated spurious emissions			
<b>Test procedure:</b> FR Vol. 62, page 26243, Section 15.247(c) / ANSI C63.4, Section 13.1.4			
<b>Test mode:</b> Compliance	<b>Verdict:</b> PASS		
<b>Date &amp; Time:</b> 7/14/2006 3:07:51 PM			
<b>Temperature:</b> 24°C	<b>Air Pressure:</b> 1013 hPa	<b>Relative Humidity:</b> 48 %	<b>Power Supply:</b> 120 VAC
<b>Remarks:</b>			

Plot 7.4.16 Radiated emission measurements from 2900 to 5460 MHz at the low carrier frequency, 5 MHz BW

TEST SITE: Anechoic chamber  
TEST DISTANCE: 3 m  
ANTENNA POLARIZATION: Vertical and Horizontal  
DETECTOR: Peak

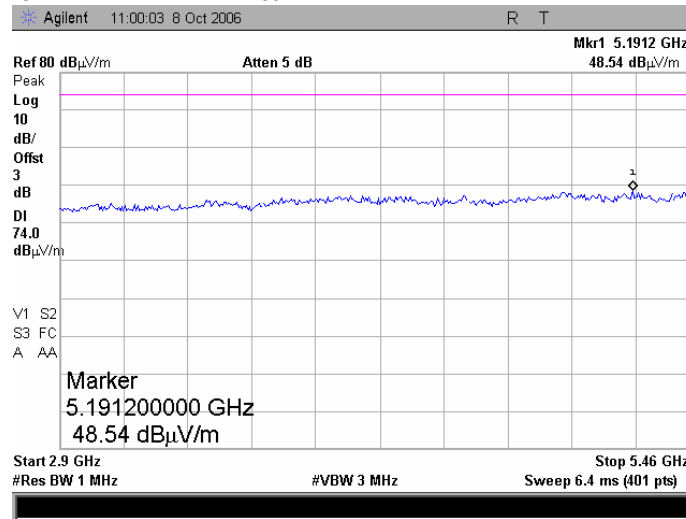

Plot 7.4.17 Radiated emission measurements from 2900 to 5460 MHz at the low carrier frequency, 10 MHz BW

TEST SITE: Anechoic chamber  
TEST DISTANCE: 3 m  
ANTENNA POLARIZATION: Vertical and Horizontal  
DETECTOR: Peak

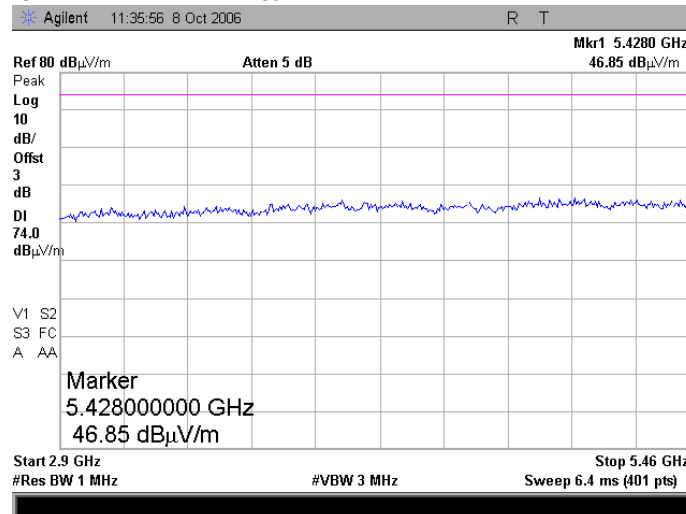

<b>Test specification:</b>	<b>Section 15.247(c), Radiated spurious emissions</b>		
<b>Test procedure:</b>	FR Vol. 62, page 26243, Section 15.247(c) / ANSI C63.4, Section 13.1.4		
<b>Test mode:</b>	Compliance	<b>Verdict:</b>	<b>PASS</b>
<b>Date &amp; Time:</b>	7/14/2006 3:07:51 PM		
<b>Temperature:</b> 24°C	<b>Air Pressure:</b> 1013 hPa	<b>Relative Humidity:</b> 48 %	<b>Power Supply:</b> 120 VAC
<b>Remarks:</b>			

**Plot 7.4.18 Radiated emission measurements from 2900 to 5460 MHz at the mid carrier frequency**

TEST SITE: Anechoic chamber  
 TEST DISTANCE: 3 m  
 ANTENNA POLARIZATION: Vertical and Horizontal  
 DETECTOR: Peak

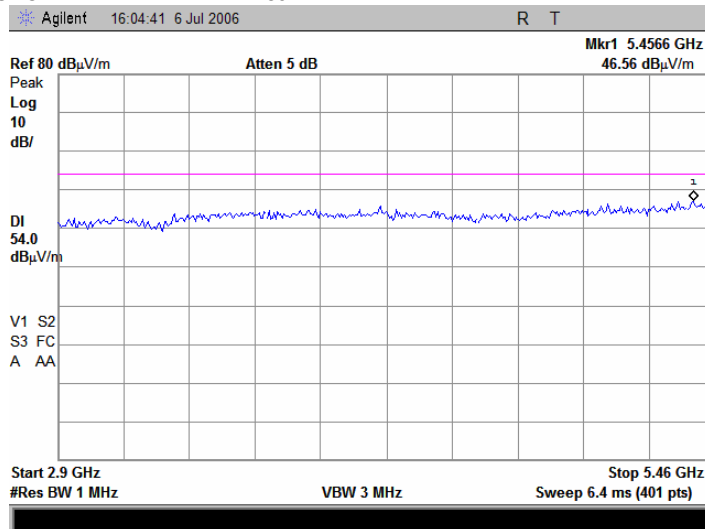

**Plot 7.4.19 Radiated emission measurements from 4900 to 5460 MHz at the mid carrier frequency**

TEST SITE: Anechoic chamber  
 TEST DISTANCE: 3 m  
 ANTENNA POLARIZATION: Vertical and Horizontal  
 DETECTOR: Average

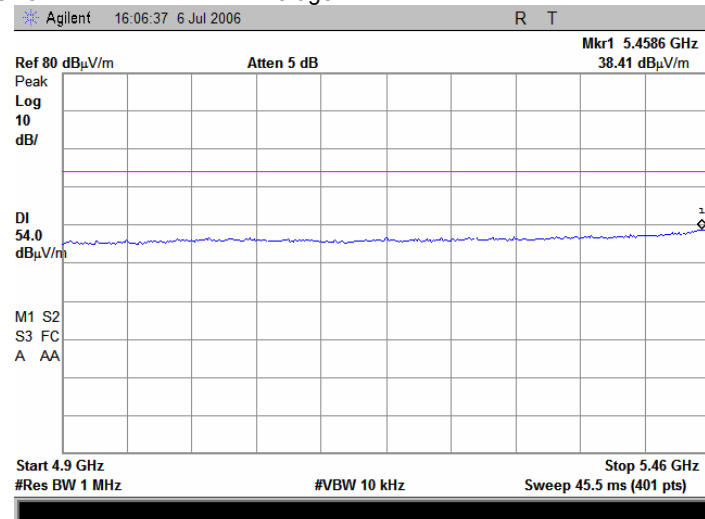

<b>Test specification:</b> Section 15.247(c), Radiated spurious emissions			
<b>Test procedure:</b> FR Vol. 62, page 26243, Section 15.247(c) / ANSI C63.4, Section 13.1.4			
<b>Test mode:</b> Compliance	<b>Verdict:</b> PASS		
<b>Date &amp; Time:</b> 7/14/2006 3:07:51 PM			
<b>Temperature:</b> 24°C	<b>Air Pressure:</b> 1013 hPa	<b>Relative Humidity:</b> 48 %	<b>Power Supply:</b> 120 VAC
<b>Remarks:</b>			

Plot 7.4.20 Radiated emission measurements from 2900 to 5460 MHz at the high carrier frequency, 5 MHz BW

TEST SITE: Anechoic chamber  
TEST DISTANCE: 3 m  
ANTENNA POLARIZATION: Vertical and Horizontal  
DETECTOR: Peak

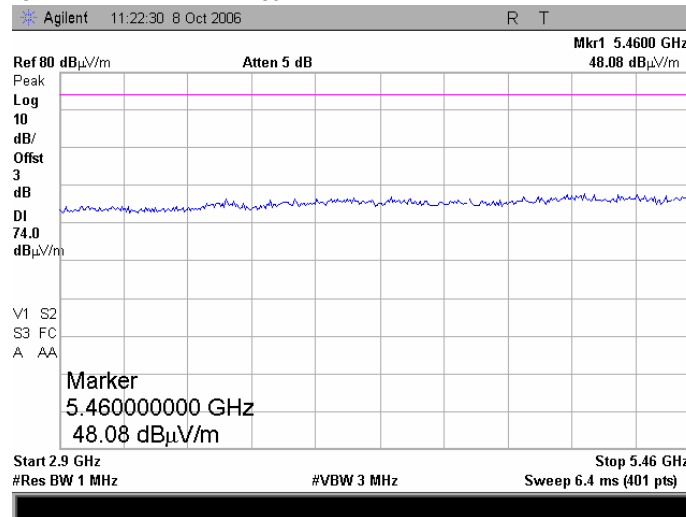

Plot 7.4.21 Radiated emission measurements from 2900 to 5460 MHz at the high carrier frequency, 10 MHz BW

TEST SITE: Anechoic chamber  
TEST DISTANCE: 3 m  
ANTENNA POLARIZATION: Vertical and Horizontal  
DETECTOR: Peak

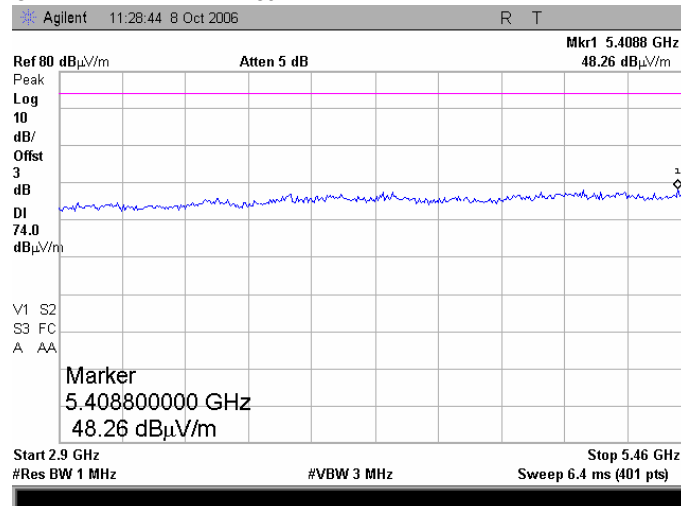

<b>Test specification:</b>	<b>Section 15.247(c), Radiated spurious emissions</b>		
<b>Test procedure:</b>	FR Vol. 62, page 26243, Section 15.247(c) / ANSI C63.4, Section 13.1.4		
<b>Test mode:</b>	Compliance	<b>Verdict:</b>	<b>PASS</b>
<b>Date &amp; Time:</b>	7/14/2006 3:07:51 PM		
<b>Temperature:</b> 24°C	<b>Air Pressure:</b> 1013 hPa	<b>Relative Humidity:</b> 48 %	<b>Power Supply:</b> 120 VAC
<b>Remarks:</b>			

**Plot 7.4.22 Radiated emission measurements from 7250 to 8000 MHz at the low carrier frequency**

TEST SITE: Anechoic chamber  
TEST DISTANCE: 3 m  
ANTENNA POLARIZATION: Vertical and Horizontal

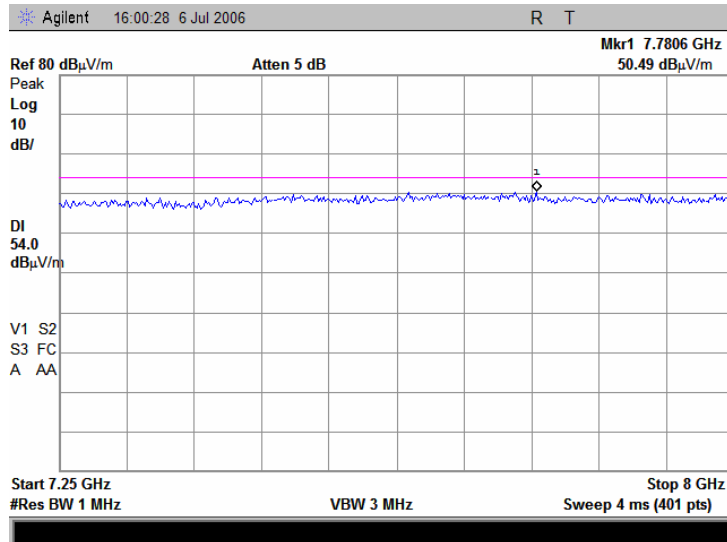

<b>Test specification:</b>	<b>Section 15.247(c), Radiated spurious emissions</b>		
<b>Test procedure:</b>	FR Vol. 62, page 26243, Section 15.247(c) / ANSI C63.4, Section 13.1.4		
<b>Test mode:</b>	Compliance	<b>Verdict:</b>	<b>PASS</b>
<b>Date &amp; Time:</b>	7/14/2006 3:07:51 PM		
<b>Temperature:</b> 24°C	<b>Air Pressure:</b> 1013 hPa	<b>Relative Humidity:</b> 48 %	<b>Power Supply:</b> 120 VAC
<b>Remarks:</b>			

**Plot 7.4.23 Radiated emission measurements from 7250 to 8000 MHz at the mid carrier frequency**

TEST SITE: Anechoic chamber  
TEST DISTANCE: 3 m  
ANTENNA POLARIZATION: Vertical and Horizontal

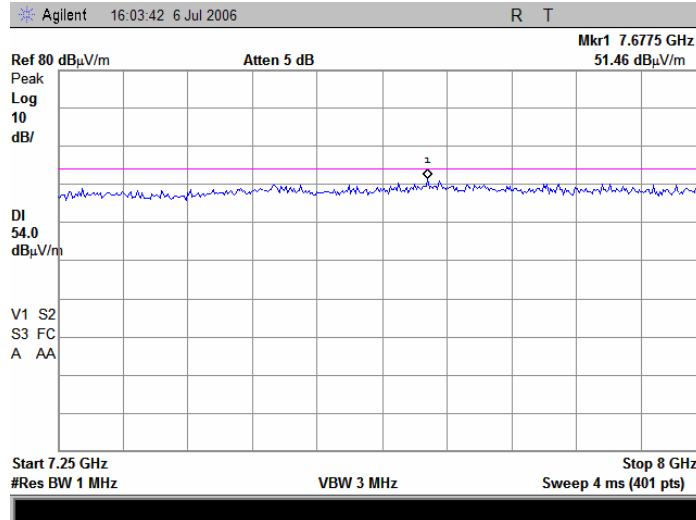

**Plot 7.4.24 Radiated emission measurements from 7250 to 8000 MHz at the high carrier frequency**

TEST SITE: Anechoic chamber  
TEST DISTANCE: 3 m  
ANTENNA POLARIZATION: Vertical and Horizontal

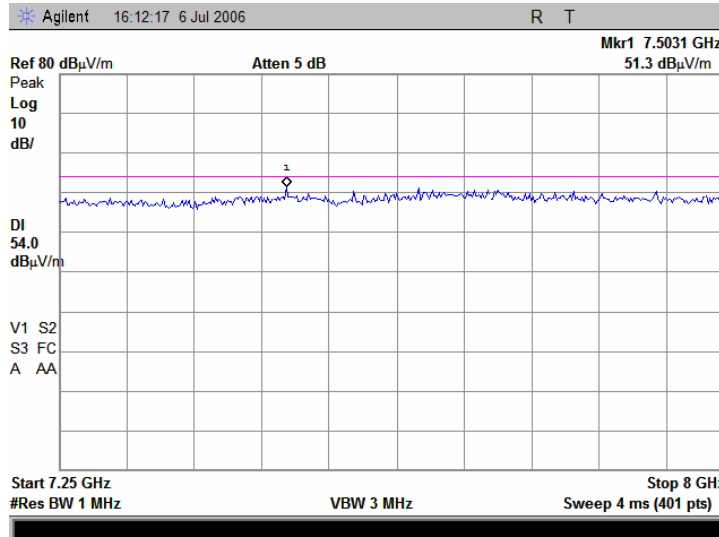

<b>Test specification:</b>	<b>Section 15.247(c), Radiated spurious emissions</b>		
<b>Test procedure:</b>	FR Vol. 62, page 26243, Section 15.247(c) / ANSI C63.4, Section 13.1.4		
<b>Test mode:</b>	Compliance	<b>Verdict:</b>	<b>PASS</b>
<b>Date &amp; Time:</b>	7/14/2006 3:07:51 PM		
<b>Temperature:</b> 24°C	<b>Air Pressure:</b> 1013 hPa	<b>Relative Humidity:</b> 48 %	<b>Power Supply:</b> 120 VAC
<b>Remarks:</b>			

**Plot 7.4.25 Radiated emission measurements from 8000 to 14000 MHz at the low carrier frequency**

TEST SITE: Anechoic chamber  
 TEST DISTANCE: 3 m  
 ANTENNA POLARIZATION: Vertical and Horizontal  
 DETECTOR: Peak

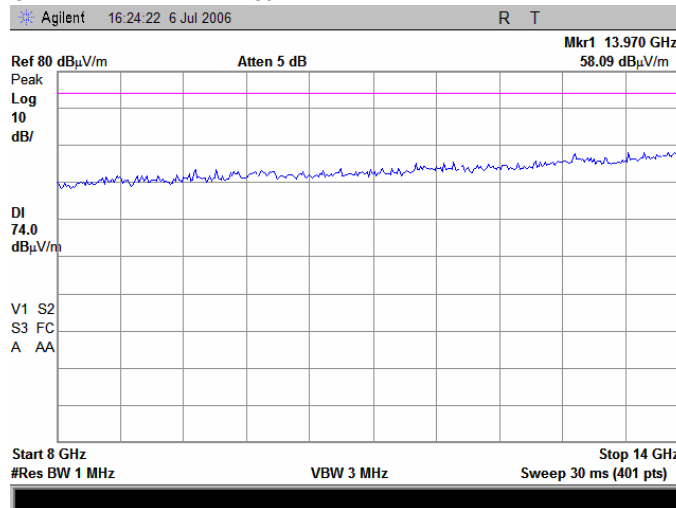

**Plot 7.4.26 Radiated emission measurements from 8000 to 14000 MHz at the low carrier frequency**

TEST SITE: Anechoic chamber  
 TEST DISTANCE: 3 m  
 ANTENNA POLARIZATION: Vertical and Horizontal  
 DETECTOR: Average

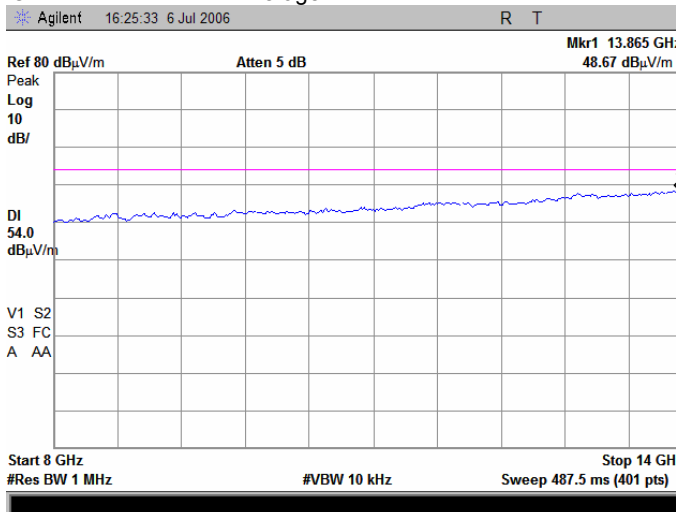

<b>Test specification:</b> Section 15.247(c), Radiated spurious emissions			
<b>Test procedure:</b> FR Vol. 62, page 26243, Section 15.247(c) / ANSI C63.4, Section 13.1.4			
<b>Test mode:</b> Compliance	<b>Verdict:</b> PASS		
<b>Date &amp; Time:</b> 7/14/2006 3:07:51 PM			
<b>Temperature:</b> 24°C	<b>Air Pressure:</b> 1013 hPa	<b>Relative Humidity:</b> 48 %	<b>Power Supply:</b> 120 VAC
<b>Remarks:</b>			

Plot 7.4.27 Radiated emission measurements from 8000 to 14000 MHz at the mid carrier frequency

TEST SITE: Anechoic chamber  
TEST DISTANCE: 3 m  
ANTENNA POLARIZATION: Vertical and Horizontal  
DETECTOR: Peak

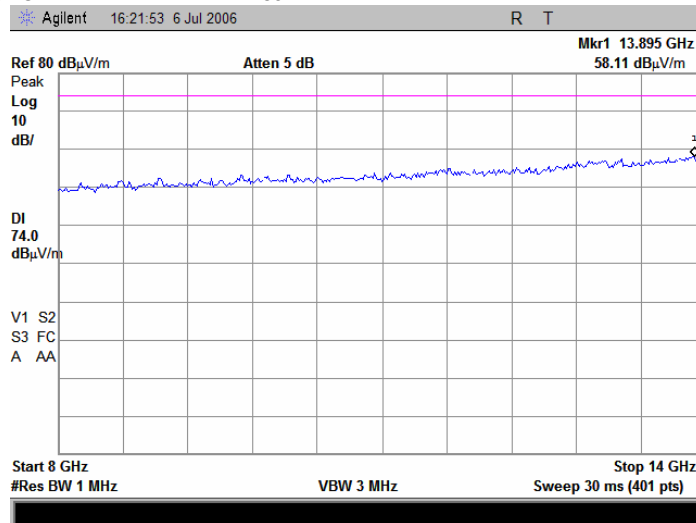

Plot 7.4.28 Radiated emission measurements from 8000 to 14000 MHz at the mid carrier frequency

TEST SITE: Anechoic chamber  
TEST DISTANCE: 3 m  
ANTENNA POLARIZATION: Vertical and Horizontal  
DETECTOR: Average

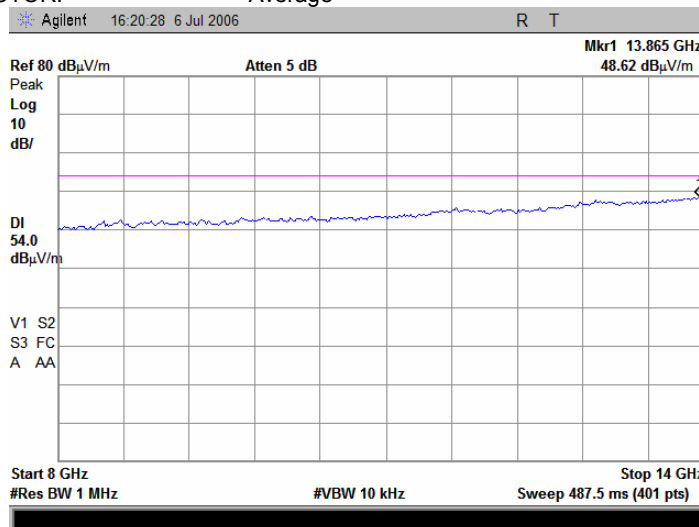



<b>Test specification:</b>	<b>Section 15.247(c), Radiated spurious emissions</b>		
<b>Test procedure:</b>	FR Vol. 62, page 26243, Section 15.247(c) / ANSI C63.4, Section 13.1.4		
<b>Test mode:</b>	Compliance	<b>Verdict:</b>	<b>PASS</b>
<b>Date &amp; Time:</b>	7/14/2006 3:07:51 PM		
<b>Temperature:</b> 24°C	<b>Air Pressure:</b> 1013 hPa	<b>Relative Humidity:</b> 48 %	<b>Power Supply:</b> 120 VAC
<b>Remarks:</b>			

**Plot 7.4.29 Radiated emission measurements from 8000 to 14000 MHz at the high carrier frequency**

TEST SITE: Anechoic chamber  
 TEST DISTANCE: 3 m  
 ANTENNA POLARIZATION: Vertical and Horizontal  
 DETECTOR: Peak

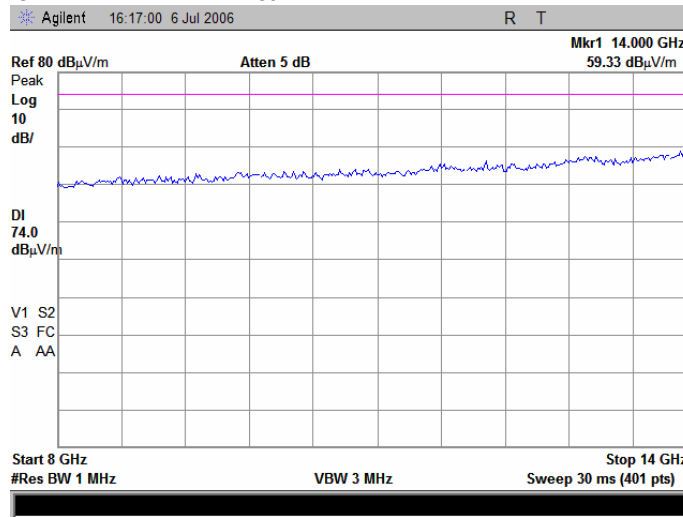

**Plot 7.4.30 Radiated emission measurements from 8000 to 14000 MHz at the high carrier frequency**

TEST SITE: Anechoic chamber  
 TEST DISTANCE: 3 m  
 ANTENNA POLARIZATION: Vertical and Horizontal  
 DETECTOR: Average

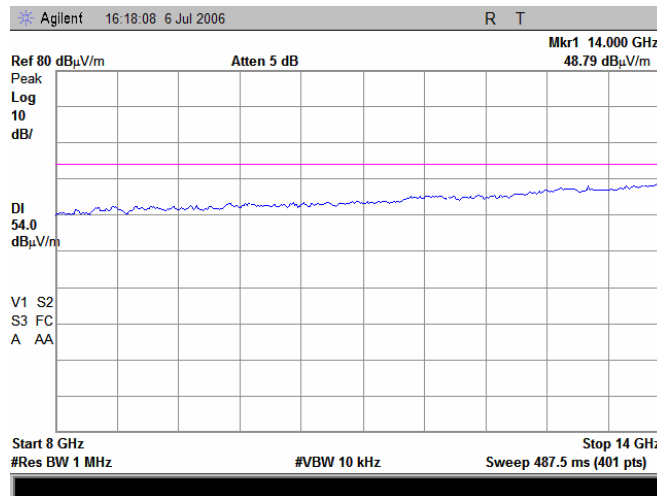

<b>Test specification:</b>	<b>Section 15.247(c), Radiated spurious emissions</b>		
<b>Test procedure:</b>	FR Vol. 62, page 26243, Section 15.247(c) / ANSI C63.4, Section 13.1.4		
<b>Test mode:</b>	Compliance	<b>Verdict:</b>	<b>PASS</b>
<b>Date &amp; Time:</b>	7/14/2006 3:07:51 PM		
<b>Temperature:</b> 24°C	<b>Air Pressure:</b> 1013 hPa	<b>Relative Humidity:</b> 48 %	<b>Power Supply:</b> 120 VAC
<b>Remarks:</b>			

**Plot 7.4.31 Radiated emission measurements from 14000 to 18000 MHz at the low carrier frequency**

TEST SITE: Anechoic chamber  
 TEST DISTANCE: 3 m  
 ANTENNA POLARIZATION: Vertical and Horizontal  
 DETECTOR: Peak

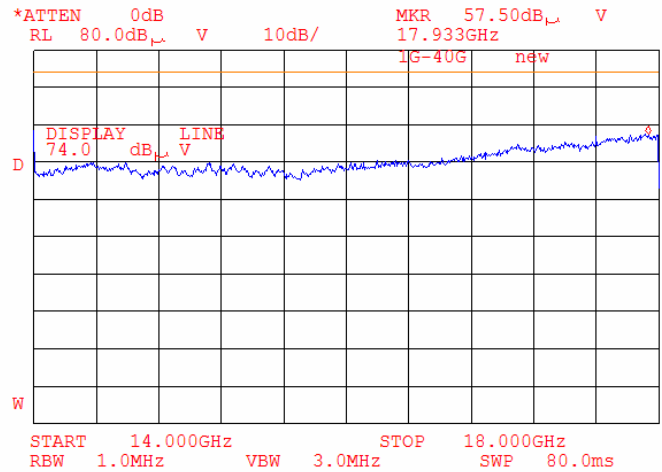

**Plot 7.4.32 Radiated emission measurements from 14000 to 18000 MHz at the low carrier frequency**

TEST SITE: Anechoic chamber  
 TEST DISTANCE: 3 m  
 ANTENNA POLARIZATION: Vertical and Horizontal  
 DETECTOR: Average

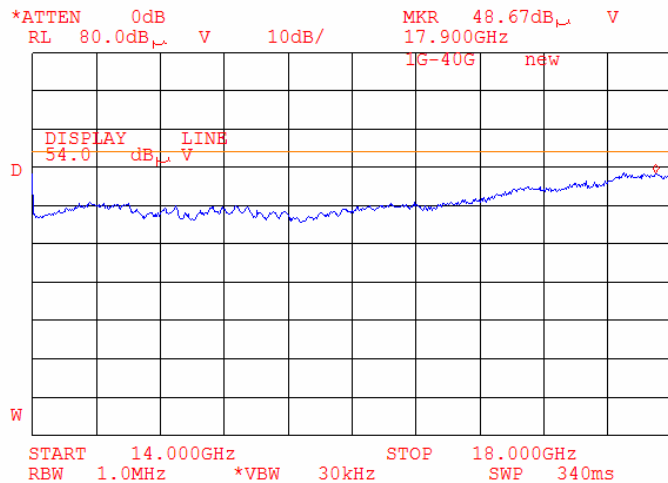

<b>Test specification:</b>	<b>Section 15.247(c), Radiated spurious emissions</b>		
<b>Test procedure:</b>	FR Vol. 62, page 26243, Section 15.247(c) / ANSI C63.4, Section 13.1.4		
<b>Test mode:</b>	Compliance	<b>Verdict:</b>	<b>PASS</b>
<b>Date &amp; Time:</b>	7/14/2006 3:07:51 PM		
<b>Temperature:</b> 24°C	<b>Air Pressure:</b> 1013 hPa	<b>Relative Humidity:</b> 48 %	<b>Power Supply:</b> 120 VAC
<b>Remarks:</b>			

Plot 7.4.33 Radiated emission measurements from 14000 to 18000 MHz at the mid carrier frequency

TEST SITE: Anechoic chamber  
 TEST DISTANCE: 3 m  
 ANTENNA POLARIZATION: Vertical and Horizontal  
 DETECTOR: Peak

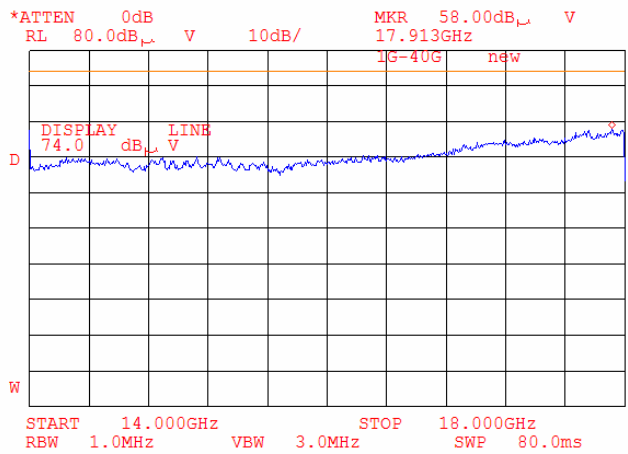

Plot 7.4.34 Radiated emission measurements from 14000 to 18000 MHz at the mid carrier frequency

TEST SITE: Anechoic chamber  
 TEST DISTANCE: 3 m  
 ANTENNA POLARIZATION: Vertical and Horizontal  
 DETECTOR: Average

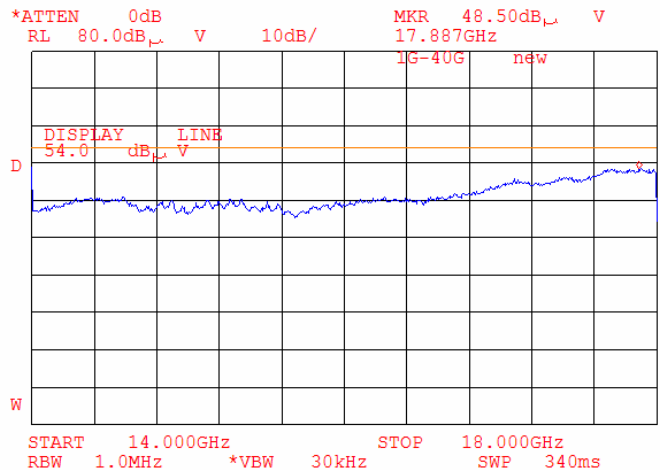

<b>Test specification:</b>	<b>Section 15.247(c), Radiated spurious emissions</b>		
<b>Test procedure:</b>	FR Vol. 62, page 26243, Section 15.247(c) / ANSI C63.4, Section 13.1.4		
<b>Test mode:</b>	Compliance	<b>Verdict:</b>	<b>PASS</b>
<b>Date &amp; Time:</b>	7/14/2006 3:07:51 PM		
<b>Temperature:</b> 24°C	<b>Air Pressure:</b> 1013 hPa	<b>Relative Humidity:</b> 48 %	<b>Power Supply:</b> 120 VAC
<b>Remarks:</b>			

**Plot 7.4.35 Radiated emission measurements from 14000 to 18000 MHz at the high carrier frequency**

TEST SITE: Anechoic chamber  
 TEST DISTANCE: 3 m  
 ANTENNA POLARIZATION: Vertical and Horizontal  
 DETECTOR: Peak

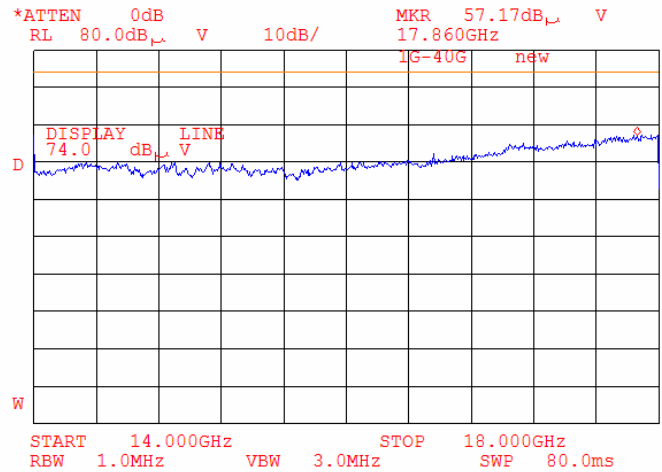

**Plot 7.4.36 Radiated emission measurements from 14000 to 18000 MHz at the high carrier frequency**

TEST SITE: Anechoic chamber  
 TEST DISTANCE: 3 m  
 ANTENNA POLARIZATION: Vertical and Horizontal  
 DETECTOR: Average

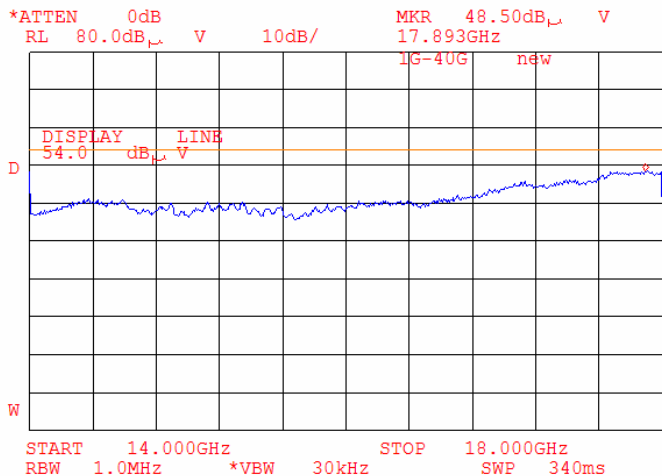

<b>Test specification:</b>	<b>Section 15.247(c), Radiated spurious emissions</b>		
<b>Test procedure:</b>	FR Vol. 62, page 26243, Section 15.247(c) / ANSI C63.4, Section 13.1.4		
<b>Test mode:</b>	Compliance	<b>Verdict:</b>	<b>PASS</b>
<b>Date &amp; Time:</b>	7/14/2006 3:07:51 PM		
<b>Temperature:</b> 24°C	<b>Air Pressure:</b> 1013 hPa	<b>Relative Humidity:</b> 48 %	<b>Power Supply:</b> 120 VAC
<b>Remarks:</b>			

**Plot 7.4.37 Radiated emission measurements from 18000 to 26500 MHz at the low carrier frequency**

TEST SITE: Anechoic chamber  
 TEST DISTANCE: 3 m  
 ANTENNA POLARIZATION: Vertical and Horizontal  
 DETECTOR: Peak

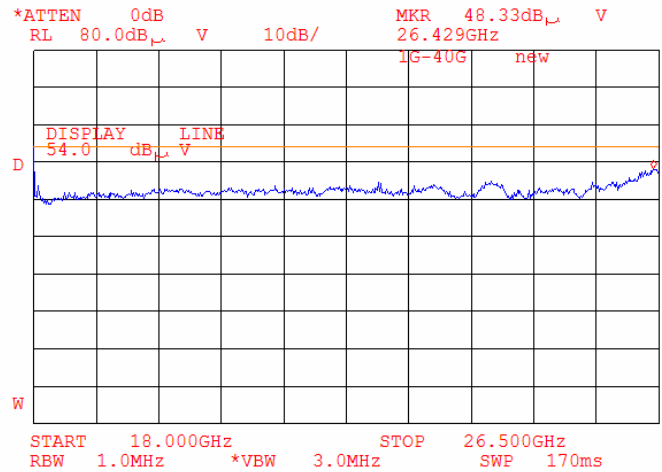

**Plot 7.4.38 Radiated emission measurements from 18000 to 26500 MHz at the mid carrier frequency**

TEST SITE: Anechoic chamber  
 TEST DISTANCE: 3 m  
 ANTENNA POLARIZATION: Vertical and Horizontal  
 DETECTOR: Peak

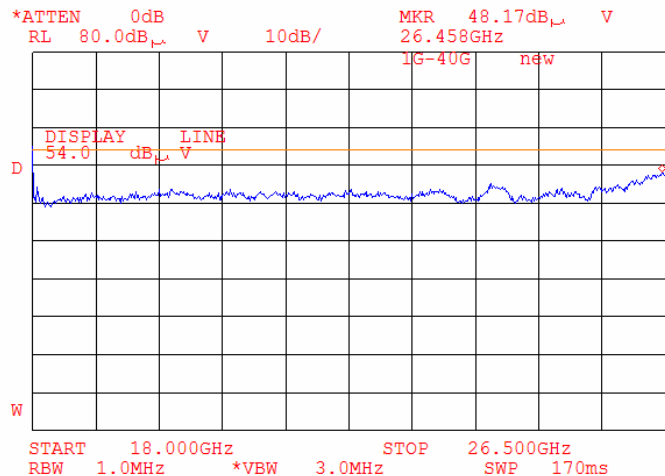

<b>Test specification:</b>		<b>Section 15.247(c), Radiated spurious emissions</b>	
<b>Test procedure:</b> FR Vol. 62, page 26243, Section 15.247(c) / ANSI C63.4, Section 13.1.4			
<b>Test mode:</b>	Compliance	<b>Verdict:</b> <b>PASS</b>	
<b>Date &amp; Time:</b>	7/14/2006 3:07:51 PM		
<b>Temperature:</b> 24°C	<b>Air Pressure:</b> 1013 hPa	<b>Relative Humidity:</b> 48 %	<b>Power Supply:</b> 120 VAC
<b>Remarks:</b>			

**Plot 7.4.39 Radiated emission measurements from 18000 to 26500 MHz at the high carrier frequency**

TEST SITE: Anechoic chamber  
 TEST DISTANCE: 3 m  
 ANTENNA POLARIZATION: Vertical and Horizontal  
 DETECTOR: Peak

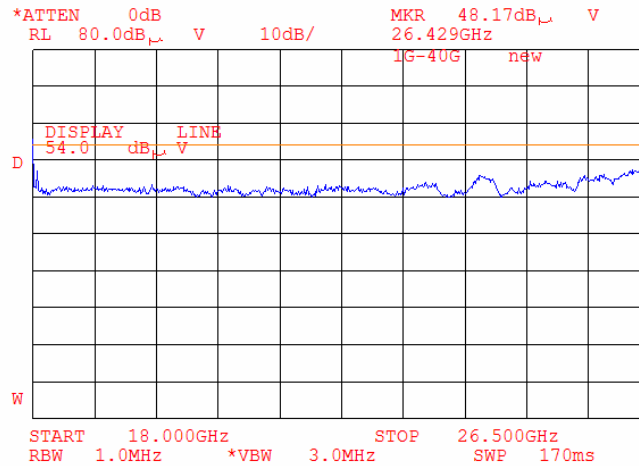

**Plot 7.4.40 Radiated emission measurements from 26500 to 33000 MHz at the low carrier frequency**

TEST SITE: Anechoic chamber  
 TEST DISTANCE: 3 m  
 ANTENNA POLARIZATION: Vertical and Horizontal  
 DETECTOR: Peak

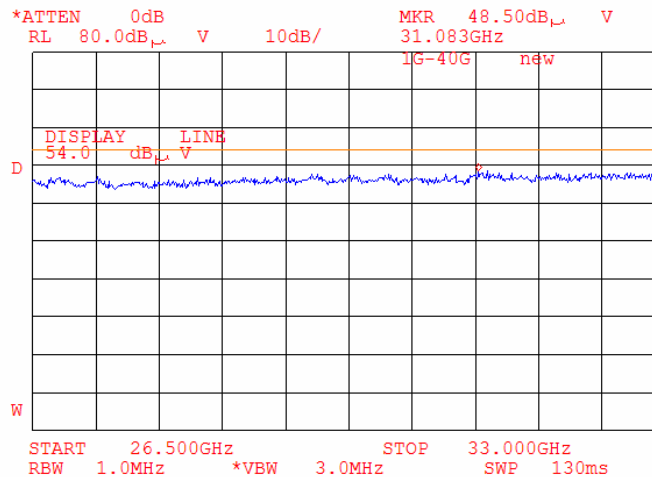

<b>Test specification:</b>	<b>Section 15.247(c), Radiated spurious emissions</b>		
<b>Test procedure:</b>	FR Vol. 62, page 26243, Section 15.247(c) / ANSI C63.4, Section 13.1.4		
<b>Test mode:</b>	Compliance	<b>Verdict:</b>	<b>PASS</b>
<b>Date &amp; Time:</b>	7/14/2006 3:07:51 PM		
<b>Temperature:</b> 24°C	<b>Air Pressure:</b> 1013 hPa	<b>Relative Humidity:</b> 48 %	<b>Power Supply:</b> 120 VAC
<b>Remarks:</b>			

**Plot 7.4.41 Radiated emission measurements from 26500 to 33000 MHz at the mid carrier frequency**

TEST SITE: Anechoic chamber  
 TEST DISTANCE: 3 m  
 ANTENNA POLARIZATION: Vertical and Horizontal  
 DETECTOR: Peak

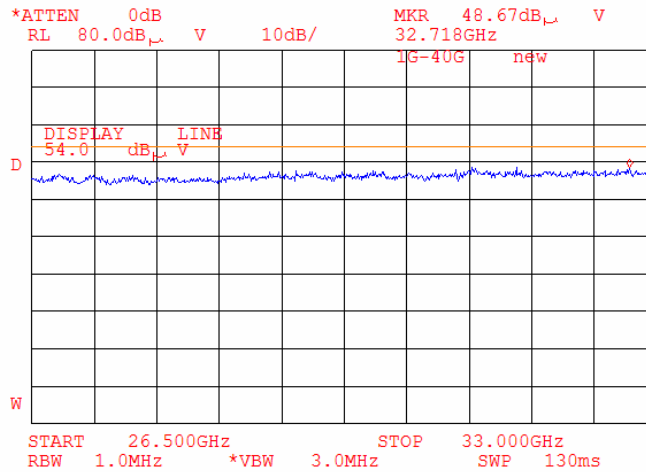

**Plot 7.4.42 Radiated emission measurements from 26500 to 33000 MHz at the high carrier frequency**

TEST SITE: Anechoic chamber  
 TEST DISTANCE: 3 m  
 ANTENNA POLARIZATION: Vertical and Horizontal  
 DETECTOR: Peak

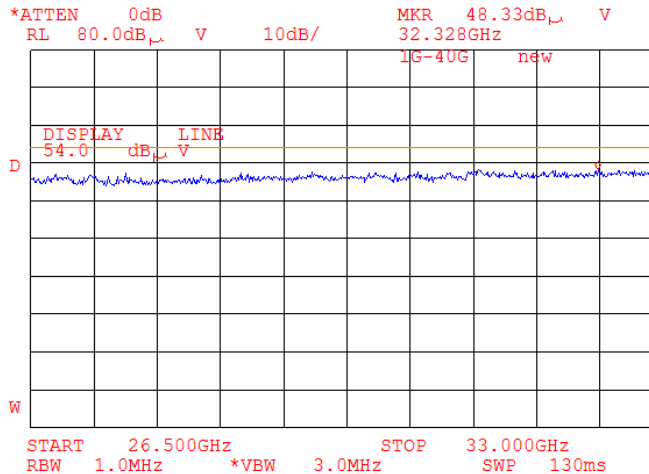

<b>Test specification:</b>		<b>Section 15.247(c), Radiated spurious emissions</b>	
<b>Test procedure:</b>		FR Vol. 62, page 26243, Section 15.247(c) / ANSI C63.4, Section 13.1.4	
<b>Test mode:</b>	Compliance	<b>Verdict:</b>	PASS
<b>Date &amp; Time:</b>	7/14/2006 3:07:51 PM		
<b>Temperature:</b> 24°C	<b>Air Pressure:</b> 1013 hPa	<b>Relative Humidity:</b> 48 %	<b>Power Supply:</b> 120 VAC
<b>Remarks:</b>			

**Plot 7.4.43 Radiated emission measurements from 33000 to 40000 MHz at the low carrier frequency**

TEST SITE: Anechoic chamber  
 TEST DISTANCE: 3 m  
 ANTENNA POLARIZATION: Vertical and Horizontal  
 DETECTOR: Peak

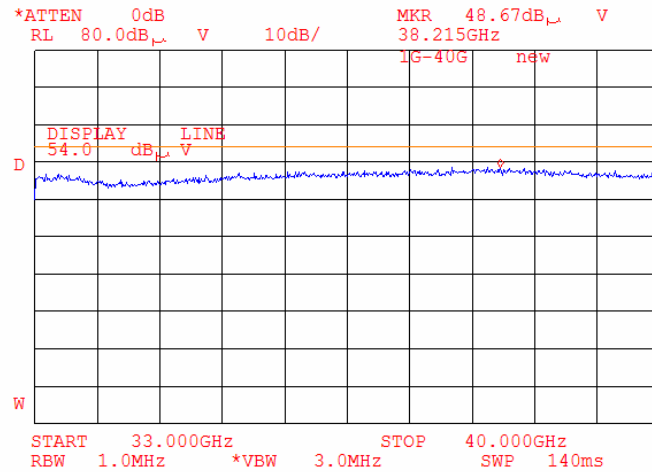

**Plot 7.4.44 Radiated emission measurements from 33000 to 40000 MHz at the mid carrier frequency**

TEST SITE: Anechoic chamber  
 TEST DISTANCE: 3 m  
 ANTENNA POLARIZATION: Vertical and Horizontal  
 DETECTOR: Peak

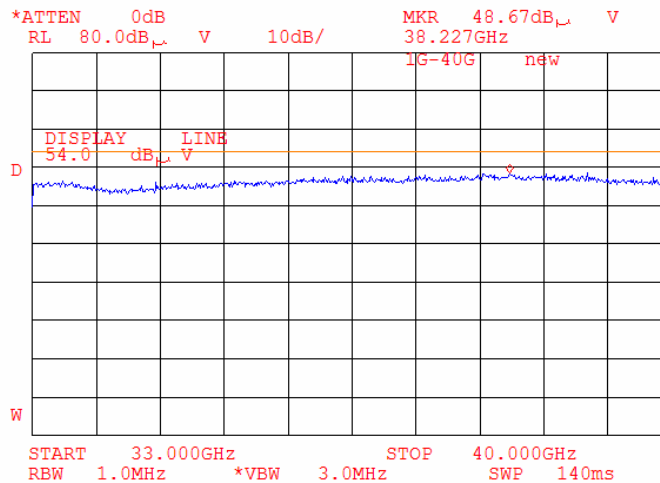



<b>Test specification:</b>	<b>Section 15.247(c), Radiated spurious emissions</b>		
<b>Test procedure:</b>	FR Vol. 62, page 26243, Section 15.247(c) / ANSI C63.4, Section 13.1.4		
<b>Test mode:</b>	Compliance	<b>Verdict:</b>	<b>PASS</b>
<b>Date &amp; Time:</b>	7/14/2006 3:07:51 PM		
<b>Temperature:</b> 24°C	<b>Air Pressure:</b> 1013 hPa	<b>Relative Humidity:</b> 48 %	<b>Power Supply:</b> 120 VAC
<b>Remarks:</b>			

**Plot 7.4.45 Radiated emission measurements from 33000 to 40000 MHz at the high carrier frequency**

TEST SITE: Anechoic chamber  
 TEST DISTANCE: 3 m  
 ANTENNA POLARIZATION: Vertical and Horizontal  
 DETECTOR: Peak

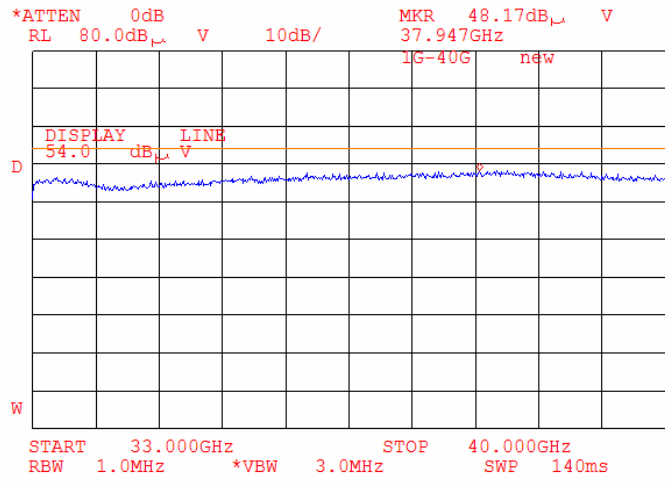

<b>Test specification:</b>	<b>Section 15.247(c), Radiated spurious emissions</b>		
<b>Test procedure:</b>	FR Vol. 62, page 26243, Section 15.247(c) / ANSI C63.4, Section 13.1.4		
<b>Test mode:</b>	Compliance	<b>Verdict:</b>	<b>PASS</b>
<b>Date &amp; Time:</b>	7/14/2006 3:07:51 PM		
<b>Temperature:</b> 24°C	<b>Air Pressure:</b> 1013 hPa	<b>Relative Humidity:</b> 48 %	<b>Power Supply:</b> 120 VAC
<b>Remarks:</b>			

Plot 7.4.46 Transmission pulse duration

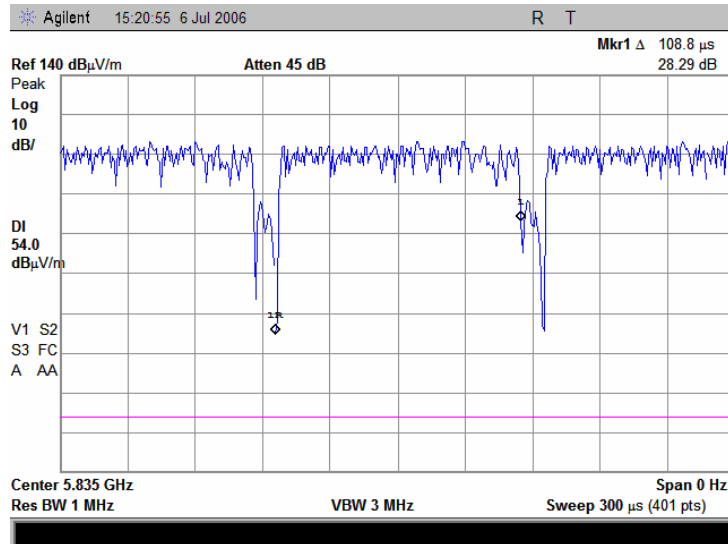

Plot 7.4.47 Transmission pulse period

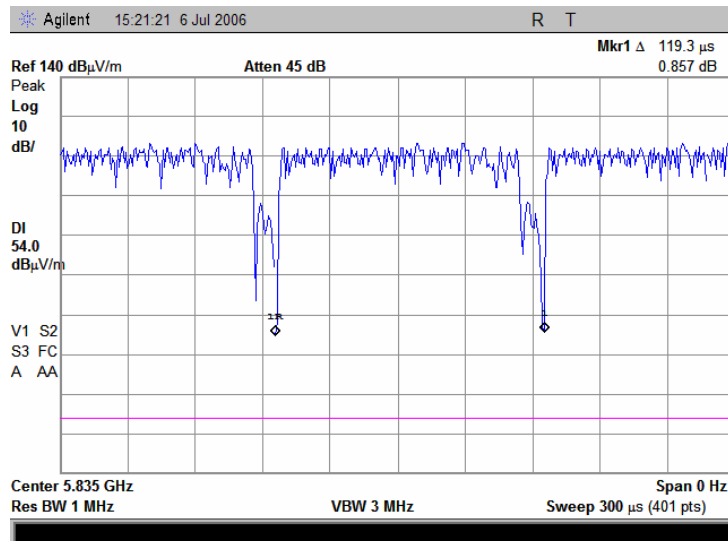

<b>Test specification:</b> Section 15.247(d), Peak power density			
<b>Test procedure:</b> FR Vol. 62, page 26243, Section 15.247(d)			
<b>Test mode:</b> Compliance	<b>Verdict:</b> PASS		
<b>Date &amp; Time:</b> 7/11/2006 1:36:44 PM			
<b>Temperature:</b> 24°C	<b>Air Pressure:</b> 1010 hPa	<b>Relative Humidity:</b> 36 %	<b>Power Supply:</b> 120 VAC
<b>Remarks:</b>			

## 7.5 Peak spectral power density

### 7.5.1 General

This test was performed to measure the peak spectral power density at the transmitter RF antenna connector. Specification test limits are given in Table 7.5.1.

Table 7.5.1 Peak spectral power density limits

Assigned frequency range, MHz	Measurement bandwidth, kHz	Peak spectral power density, dBm
5725 – 5835	3.0	8.0

### 7.5.2 Test procedure

- 7.5.2.1** The EUT was set up as shown in Figure 7.5.1, energized and its proper operation was checked.
- 7.5.2.2** The EUT was adjusted to produce maximum available to end user RF output power.
- 7.5.2.3** The frequency span of spectrum analyzer was set to capture the entire 6 dB band of the transmitter, in peak hold mode with resolution bandwidth set to 3.0 kHz, video bandwidth wider than resolution bandwidth, auto sweep time and sufficient number of sweeps was allowed for trace stabilization. The spectrum lines spacing was verified to be wider than 3 kHz. Otherwise the resolution bandwidth was reduced until individual spectrum lines were resolved and the power of individual spectrum lines was integrated over 3 kHz band.
- 7.5.2.4** The peak of emission was zoomed with span set just wide enough to capture the emission peak area and sweep time was set equal to span width divided by resolution bandwidth. Spectrum analyzer was set in peak hold mode, sufficient number of sweeps was allowed for trace stabilization and peak spectral power density was measured as provided in Table 7.5.2 and associated plots.

Figure 7.5.1 Peak spectral power density test setup

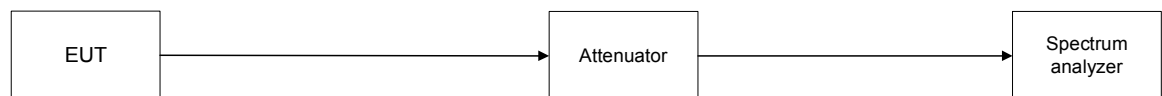

<b>Test specification:</b>		<b>Section 15.247(d), Peak power density</b>	
<b>Test procedure:</b>		FR Vol. 62, page 26243, Section 15.247(d)	
<b>Test mode:</b>	Compliance	<b>Verdict:</b>	<b>PASS</b>
<b>Date &amp; Time:</b>	7/11/2006 1:36:44 PM		
<b>Temperature:</b> 24°C	<b>Air Pressure:</b> 1010 hPa	<b>Relative Humidity:</b> 36 %	<b>Power Supply:</b> 120 VAC
<b>Remarks:</b>			

**Table 7.5.2 Peak spectral power density test results**

ASSIGNED FREQUENCY: 5725 – 5835 MHz  
 MODULATION: QAM  
 MODULATING SIGNAL: PRBS  
 TRANSMITTER OUTPUT POWER SETTINGS: Maximum  
 DETECTOR USED: Peak

Carrier frequency, MHz	Spectrum analyzer reading, dB(mW/3 kHz)	External attenuation, dB	Cable loss, dB	Peak power density*, dB(mW/3 kHz)	Limit, dBm	Margin**, dB	Verdict
<b>5 MHz channel spacing:</b>							
<b>BPSK:</b>							
5740	-45.12	included	included	-10.12	8.0	-18.12	Pass
5785	-46.14	included	included	-11.14	8.0	-19.14	Pass
5835	-47.63	included	included	-12.63	8.0	-20.63	Pass
<b>64QAM:</b>							
5740	-45.4	included	included	-10.4	8.0	-18.4	Pass
5785	-45.95	included	included	-10.95	8.0	-18.95	Pass
5835	-47.65	included	included	-12.65	8.0	-20.65	Pass
<b>10 MHz channel spacing:</b>							
<b>BPSK:</b>							
5740	-48.19	included	included	-13.19	8.0	-21.19	Pass
5785	-48.93	included	included	-13.93	8.0	-21.93	Pass
5835	-50.73	included	included	-15.73	8.0	-23.73	Pass
<b>64QAM:</b>							
5740	-48.13	included	included	-13.13	8.0	-21.13	Pass
5785	-48.95	included	included	-13.95	8.0	-21.95	Pass
5835	-50.72	included	included	-15.72	8.0	-23.72	Pass

\* - Peak power density = Spectrum analyzer reading + BW factor = SA reading + 35 dB

\*\* - Margin = Peak power density – specification limit.

**Reference numbers of test equipment used**

HL 1650	HL 2254	HL 2909					
---------	---------	---------	--	--	--	--	--

Full description is given in Appendix A.

<b>Test specification:</b>	<b>Section 15.247(d), Peak power density</b>		
<b>Test procedure:</b>	FR Vol. 62, page 26243, Section 15.247(d)		
<b>Test mode:</b>	Compliance	<b>Verdict:</b>	<b>PASS</b>
<b>Date &amp; Time:</b>	7/11/2006 1:36:44 PM		
<b>Temperature:</b> 24°C	<b>Air Pressure:</b> 1010 hPa	<b>Relative Humidity:</b> 36 %	<b>Power Supply:</b> 120 VAC
<b>Remarks:</b>			

Plot 7.5.1 Peak spectral power density at low frequency within 6 dB band, 5 MHz channel spacing, BPSK

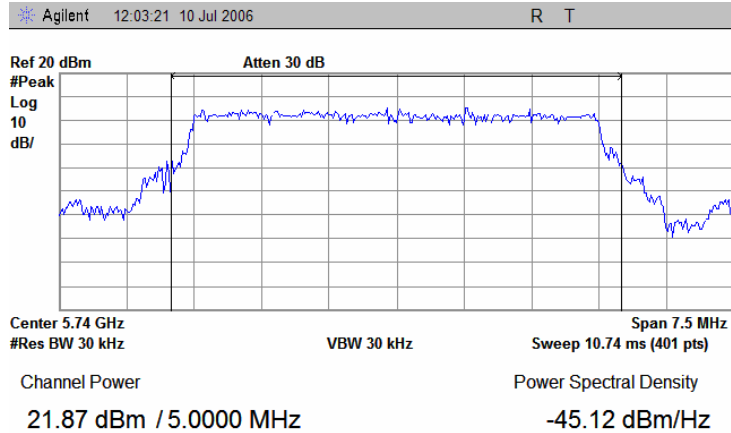

Plot 7.5.2 Peak spectral power density at mid frequency within 6 dB band, 5 MHz channel spacing, BPSK

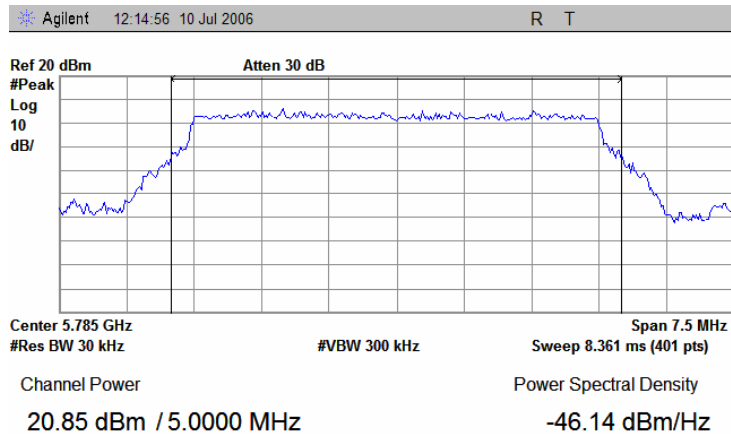

<b>Test specification:</b>	<b>Section 15.247(d), Peak power density</b>		
<b>Test procedure:</b>	FR Vol. 62, page 26243, Section 15.247(d)		
<b>Test mode:</b>	Compliance	<b>Verdict:</b>	<b>PASS</b>
<b>Date &amp; Time:</b>	7/11/2006 1:36:44 PM		
<b>Temperature:</b> 24°C	<b>Air Pressure:</b> 1010 hPa	<b>Relative Humidity:</b> 36 %	<b>Power Supply:</b> 120 VAC
<b>Remarks:</b>			

**Plot 7.5.3 Peak spectral power density at high frequency within 6 dB band, 5 MHz channel spacing, BPSK**

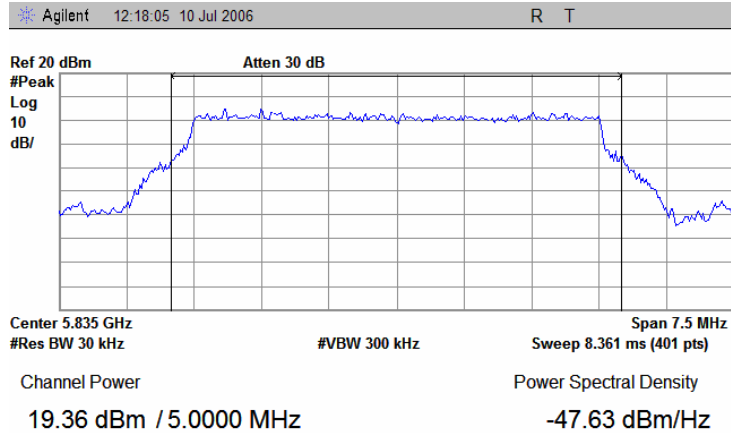

**Plot 7.5.4 Peak spectral power density at low frequency within 6 dB band, 5 MHz channel spacing, 64QAM**

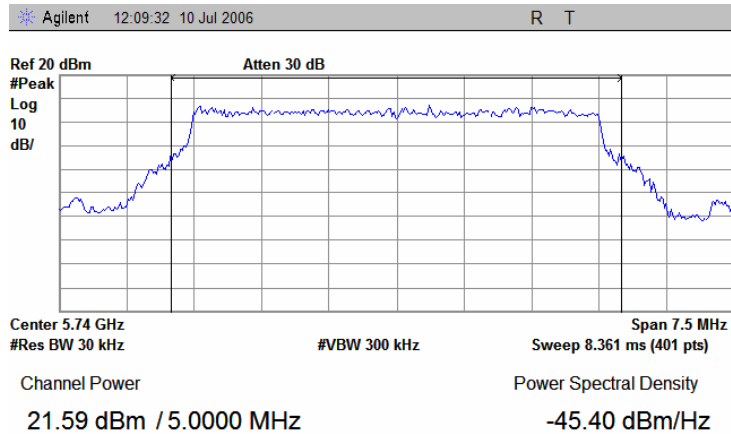

<b>Test specification:</b>	<b>Section 15.247(d), Peak power density</b>		
<b>Test procedure:</b>	FR Vol. 62, page 26243, Section 15.247(d)		
<b>Test mode:</b>	Compliance	<b>Verdict:</b>	<b>PASS</b>
<b>Date &amp; Time:</b>	7/11/2006 1:36:44 PM		
<b>Temperature:</b> 24°C	<b>Air Pressure:</b> 1010 hPa	<b>Relative Humidity:</b> 36 %	<b>Power Supply:</b> 120 VAC
<b>Remarks:</b>			

Plot 7.5.5 Peak spectral power density at mid frequency within 6 dB band, 5 MHz channel spacing, 64QAM

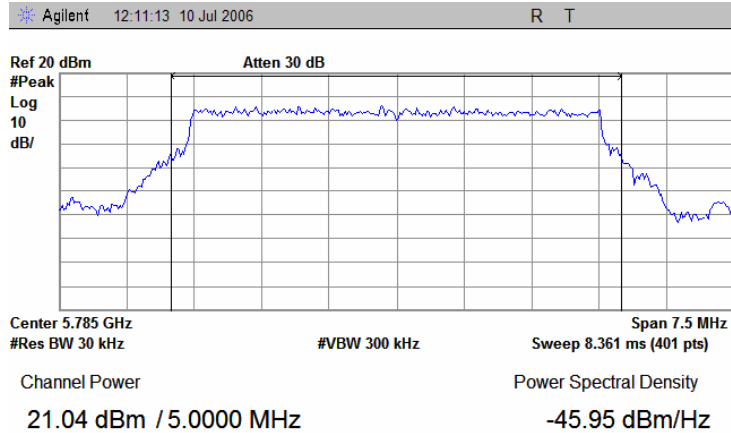

Plot 7.5.6 Peak spectral power density at high frequency within 6 dB band, 5 MHz channel spacing, 64QAM

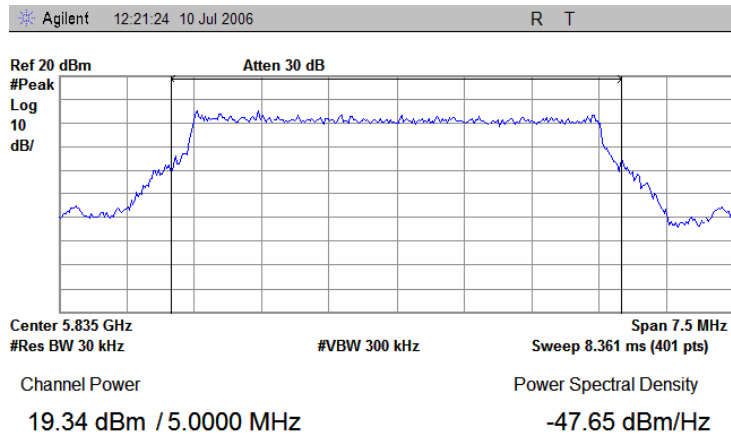

<b>Test specification:</b>	<b>Section 15.247(d), Peak power density</b>		
<b>Test procedure:</b>	FR Vol. 62, page 26243, Section 15.247(d)		
<b>Test mode:</b>	Compliance	<b>Verdict:</b>	<b>PASS</b>
<b>Date &amp; Time:</b>	7/11/2006 1:36:44 PM		
<b>Temperature:</b> 24°C	<b>Air Pressure:</b> 1010 hPa	<b>Relative Humidity:</b> 36 %	<b>Power Supply:</b> 120 VAC
<b>Remarks:</b>			

Plot 7.5.7 Peak spectral power density at low frequency within 6 dB band, 10 MHz channel spacing, BPSK

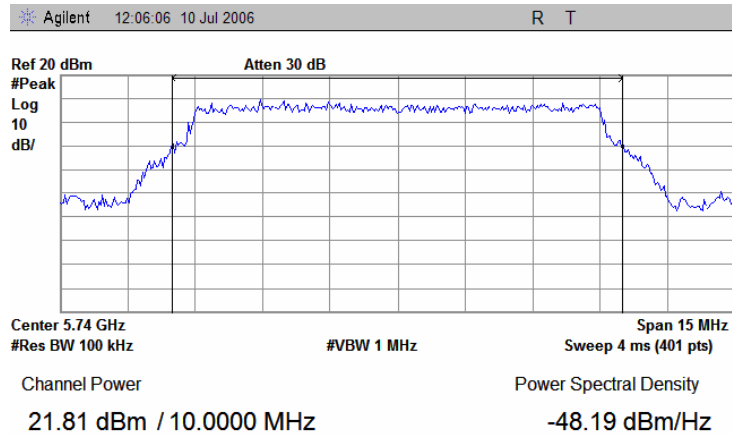

Plot 7.5.8 Peak spectral power density at mid frequency within 6 dB band, 10 MHz channel spacing, BPSK

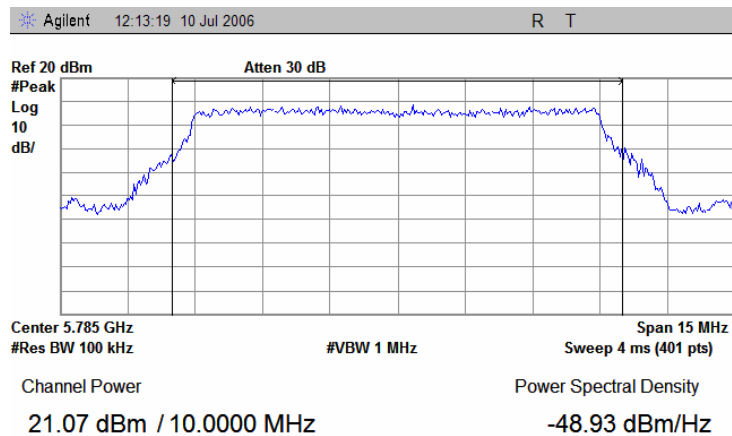



<b>Test specification:</b>	<b>Section 15.247(d), Peak power density</b>		
<b>Test procedure:</b>	FR Vol. 62, page 26243, Section 15.247(d)		
<b>Test mode:</b>	Compliance	<b>Verdict:</b>	<b>PASS</b>
<b>Date &amp; Time:</b>	7/11/2006 1:36:44 PM		
<b>Temperature:</b> 24°C	<b>Air Pressure:</b> 1010 hPa	<b>Relative Humidity:</b> 36 %	<b>Power Supply:</b> 120 VAC
<b>Remarks:</b>			

Plot 7.5.9 Peak spectral power density at high frequency within 6 dB band, 10 MHz channel spacing, BPSK

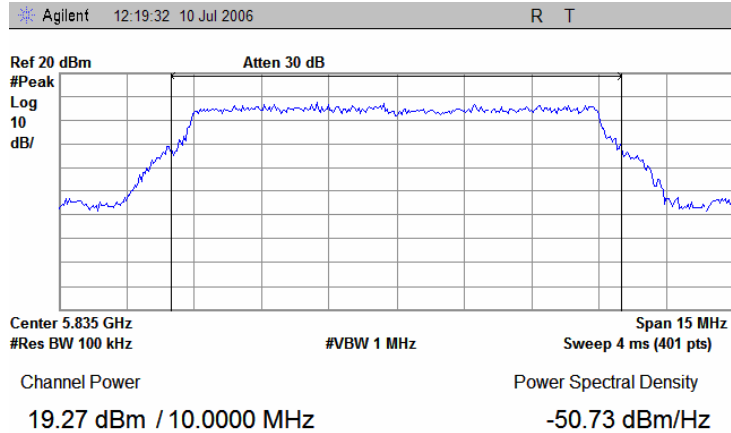

Plot 7.5.10 Peak spectral power density at low frequency within 6 dB band, 10 MHz channel spacing, 64QAM

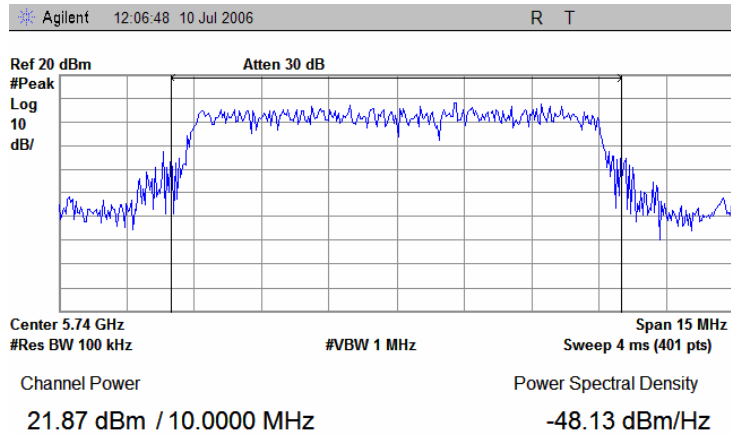

<b>Test specification:</b>	<b>Section 15.247(d), Peak power density</b>		
<b>Test procedure:</b>	FR Vol. 62, page 26243, Section 15.247(d)		
<b>Test mode:</b>	Compliance	<b>Verdict:</b>	<b>PASS</b>
<b>Date &amp; Time:</b>	7/11/2006 1:36:44 PM		
<b>Temperature:</b> 24°C	<b>Air Pressure:</b> 1010 hPa	<b>Relative Humidity:</b> 36 %	<b>Power Supply:</b> 120 VAC
<b>Remarks:</b>			

Plot 7.5.11 Peak spectral power density at mid frequency within 6 dB band, 10 MHz channel spacing, 64QAM

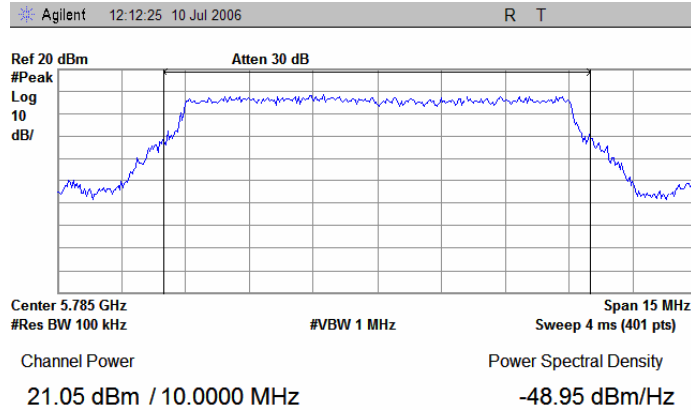

Plot 7.5.12 Peak spectral power density at high frequency within 6 dB band, 10 MHz channel spacing, 64QAM

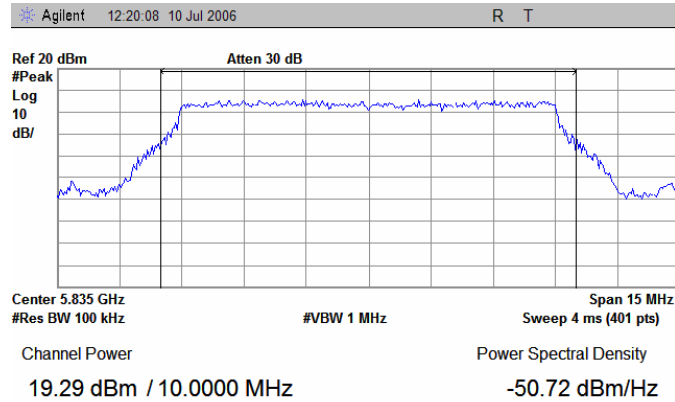

<b>Test specification:</b> Section 15.207(a), Conducted emission			
<b>Test procedure:</b> ANSI C63.4, Section 13.1.3			
<b>Test mode:</b> Compliance	<b>Verdict:</b> PASS		
<b>Date &amp; Time:</b> 7/11/2006 12:03:05 PM			
<b>Temperature:</b> 24°C	<b>Air Pressure:</b> 1010 hPa	<b>Relative Humidity:</b> 36 %	<b>Power Supply:</b> 120 VAC
<b>Remarks:</b>			

## 7.6 Conducted emissions

### 7.6.1 General

This test was performed to measure common mode conducted emissions at the power port. Specification test limits are given in Table 7.6.1. The worst test results (the lowest margins) were recorded in Table 7.6.2 and shown in the associated plots.

Table 7.6.1 Limits for conducted emissions

Frequency, MHz	Class B limit, dB(μV)	
	QP	AVRG
0.15 - 0.5	66 - 56*	56 - 46*
0.5 - 5.0	56	46
5.0 - 30	60	50

\* The limit decreases linearly with the logarithm of frequency.

### 7.6.2 Test procedure

7.6.2.1 The EUT was set up as shown in Figure 7.6.1, energized and the performance check was conducted.

7.6.2.2 The measurements were performed at power terminals with the LISN, connected to a spectrum analyzer in the frequency range referred to in Table 7.6.2. Unused coaxial connector of the LISN was terminated with 50 Ohm. Quasi-peak and average detectors were used throughout the testing.

7.6.2.3 The position of the device cables was varied to determine maximum emission level.

Figure 7.6.1 Setup for conducted emission measurements, table-top equipment

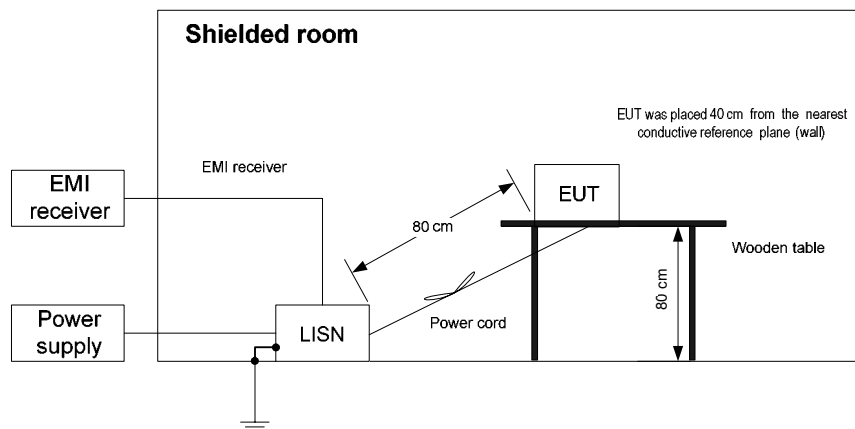

<b>Test specification:</b> Section 15.207(a), Conducted emission			
<b>Test procedure:</b> ANSI C63.4, Section 13.1.3			
<b>Test mode:</b> Compliance	<b>Verdict:</b> PASS		
<b>Date &amp; Time:</b> 7/11/2006 12:03:05 PM			
<b>Temperature:</b> 24°C	<b>Air Pressure:</b> 1010 hPa	<b>Relative Humidity:</b> 36 %	<b>Power Supply:</b> 120 VAC
<b>Remarks:</b>			

Table 7.6.2 Conducted emission test results

LINE: AC mains  
 EUT OPERATING MODE: Transmit  
 EUT SET UP: TABLE-TOP  
 TEST SITE: SHIELDED ROOM  
 DETECTORS USED: PEAK / QUASI-PEAK / AVERAGE  
 FREQUENCY RANGE: 150 kHz - 30 MHz  
 RESOLUTION BANDWIDTH: 9 kHz

Frequency, MHz	Peak emission, dB(μV)	Quasi-peak			Average			Line ID	Verdict
		Measured emission, dB(μV)	Limit, dB(μV)	Margin, dB*	Measured emission, dB(μV)	Limit, dB(μV)	Margin, dB*		
0.720389	41.17	40.82	56.00	-15.18	40.78	46.00	-5.22	L1	Pass
0.744092	36.56	35.89	56.00	-20.11	35.75	46.00	-10.25		
0.864715	44.46	44.22	56.00	-11.78	44.21	46.00	-1.79		
1.008806	45.69	45.45	56.00	-10.55	45.43	46.00	-0.57		
1.441409	38.84	37.97	56.00	-18.03	35.80	46.00	-10.20		
1.585068	37.94	37.17	56.00	-18.83	36.27	46.00	-9.73		
0.576405	37.44	36.93	56.00	-19.07	36.85	46.00	-9.15	L2	Pass
0.721064	40.95	40.65	56.00	-15.35	40.61	46.00	-5.39		
0.864824	44.17	43.94	56.00	-12.06	43.92	46.00	-2.08		
1.009715	45.33	45.10	56.00	-10.90	45.08	46.00	-0.92		
1.441712	37.01	36.28	56.00	-19.72	34.88	46.00	-11.12		
1.585859	37.23	36.30	56.00	-19.70	35.40	46.00	-10.60		

\*- Margin = Measured emission - specification limit.

Reference numbers of test equipment used

HL 0163	HL 0672	HL 0787	HL 1430	HL 1502	HL 1510		
---------	---------	---------	---------	---------	---------	--	--

Full description is given in Appendix A.

<b>Test specification:</b> Section 15.207(a), Conducted emission			
<b>Test procedure:</b> ANSI C63.4, Section 13.1.3			
<b>Test mode:</b> Compliance	<b>Verdict:</b> PASS		
<b>Date &amp; Time:</b> 7/11/2006 12:03:05 PM			
<b>Temperature:</b> 24°C	<b>Air Pressure:</b> 1010 hPa	<b>Relative Humidity:</b> 36 %	<b>Power Supply:</b> 120 VAC
<b>Remarks:</b>			

**Plot 7.6.1 Conducted emission measurements**

LINE: L1  
EUT OPERATING MODE: Transmit  
LIMIT: QUASI-PEAK, AVERAGE  
DETECTOR: PEAK

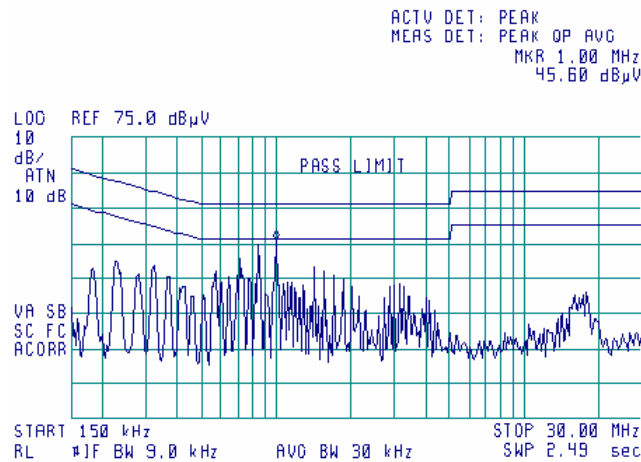

**Plot 7.6.2 Conducted emission measurements**

LINE: L2  
EUT OPERATING MODE: Transmit  
LIMIT: QUASI-PEAK, AVERAGE  
DETECTOR: PEAK

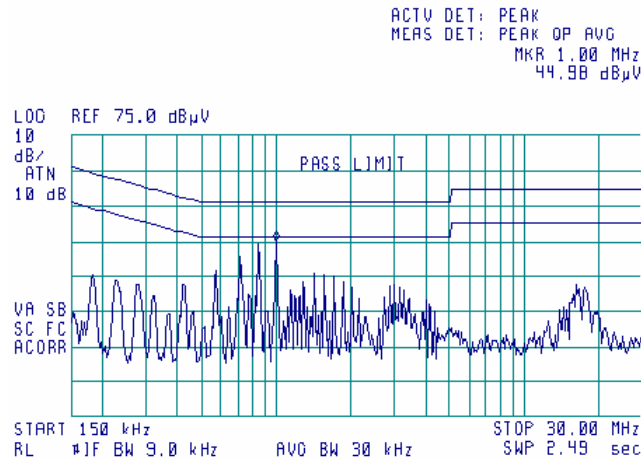

<b>Test specification:</b>	<b>Section 15.203, Antenna requirement</b>		
<b>Test procedure:</b>	Visual inspection		
<b>Test mode:</b>	Compliance	<b>Verdict:</b> PASS	
<b>Date &amp; Time:</b>	7/11/2006 1:58:42 PM		
<b>Temperature:</b> 24°C	<b>Air Pressure:</b> 1010 hPa	<b>Relative Humidity:</b> 36 %	<b>Power Supply:</b> 120 VAC
<b>Remarks:</b>			

## 7.7 Antenna requirements

The EUT was verified for compliance with antenna requirements. A transmitter shall be designed to ensure that no antenna other than that furnished by the responsible party will be used with the device. It may be either permanently attached or employs a unique antenna connector for every antenna proposed for use with the EUT. This requirement does not apply to professionally installed transmitters. The rationale for compliance with the above requirements was either visual inspection results or supplier declaration. The summary of results is provided in Table 7.7.1.

**Table 7.7.1 Antenna requirements**

Requirement	Rationale	Verdict
The transmitter antenna is permanently attached	Visual inspection	Comply
The transmitter employs a unique antenna connector	NA	
The transmitter requires professional installation	NA	

<b>Test specification:</b>		<b>Section 15.107, Conducted emission at AC power port</b>	
<b>Test procedure:</b>		ANSI C63.4, Sections 11.5 and 12.1.3	
<b>Test mode:</b>	Compliance	<b>Verdict:</b>	<b>PASS</b>
<b>Date &amp; Time:</b>	7/11/2006 12:00:49 PM		
<b>Temperature:</b> 24°C	<b>Air Pressure:</b> 1010 hPa	<b>Relative Humidity:</b> 36 %	<b>Power Supply:</b> 120 VAC
<b>Remarks:</b>			

## 8 Emission tests according to 47CFR part 15 subpart B requirements

### 8.1 Conducted emissions

#### 8.1.1 General

This test was performed to measure common mode conducted emissions at the mains power port. Specification test limits are given in Table 8.1.1. The worst test results (the lowest margins) were recorded in Table 8.1.2 and shown in the associated plots.

**Table 8.1.1 Limits for conducted emissions**

Frequency, MHz	Class B limit, dB(μV)		Class A limit, dB(μV)	
	QP	AVRG	QP	AVRG
0.15 - 0.5	66 - 56*	56 - 46*	79	66
0.5 - 5.0	56	46	73	60
5.0 - 30	60	50	73	60

\* The limit decreases linearly with the logarithm of frequency.

#### 8.1.2 Test procedure

8.1.2.1 The EUT was set up as shown in Figure 8.1.1, energized and the performance check was conducted.

8.1.2.2 The measurements were performed at power terminals with the LISN, connected to a spectrum analyzer in the frequency range referred to in Table 8.1.1. Unused coaxial connector of the LISN was terminated with 50 Ohm. Quasi-peak and average detectors were used throughout the testing.

8.1.2.3 The position of the device cables was varied to determine maximum emission level.

**Figure 8.1.1 Setup for conducted emission measurements, table-top equipment**

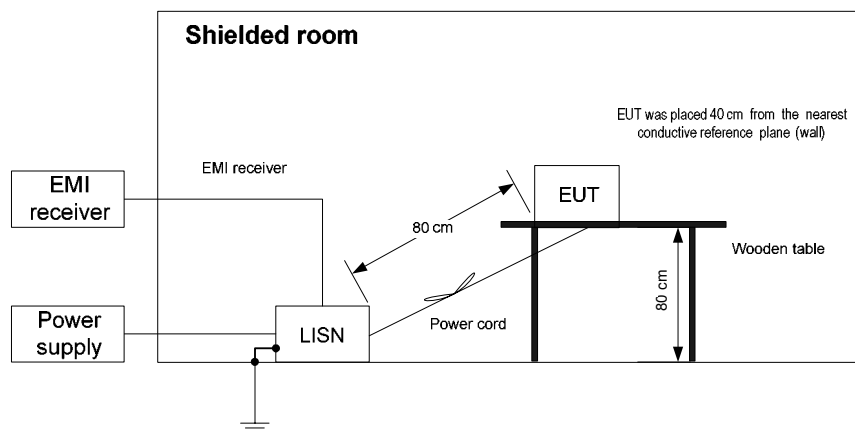

<b>Test specification:</b>		<b>Section 15.107, Conducted emission at AC power port</b>	
<b>Test procedure:</b>		ANSI C63.4, Sections 11.5 and 12.1.3	
<b>Test mode:</b>	Compliance	<b>Verdict:</b>	<b>PASS</b>
<b>Date &amp; Time:</b>	7/11/2006 12:00:49 PM		
<b>Temperature:</b> 24°C	<b>Air Pressure:</b> 1010 hPa	<b>Relative Humidity:</b> 36 %	<b>Power Supply:</b> 120 VAC
<b>Remarks:</b>			

**Table 8.1.2 Conducted emission test results**

LINE: AC mains  
LIMIT: Class B  
EUT OPERATING MODE: Receive / Stand-by  
EUT SET UP: TABLE-TOP  
TEST SITE: SHIELDED ROOM  
DETECTORS USED: PEAK / QUASI-PEAK / AVERAGE  
FREQUENCY RANGE: 150 kHz - 30 MHz  
RESOLUTION BANDWIDTH: 9 kHz

Frequency, MHz	Peak emission, dB(μV)	Quasi-peak			Average			Line ID	Verdict
		Measured emission, dB(μV)	Limit, dB(μV)	Margin, dB*	Measured emission, dB(μV)	Limit, dB(μV)	Margin, dB*		
0.577798	37.35	36.88	56.00	-19.12	36.80	46.00	-9.20	L1	Pass
0.722203	41.01	40.59	56.00	-15.41	40.55	46.00	-5.45		
0.867364	44.30	44.04	56.00	-11.96	44.01	46.00	-1.99		
1.011710	45.24	44.87	56.00	-11.13	44.84	46.00	-1.16		
1.160568	35.23	33.76	56.00	-22.24	31.73	46.00	-14.27		
1.588868	36.44	35.74	56.00	-20.26	35.63	46.00	-10.37		
0.576997	37.12	36.70	56.00	-19.30	36.62	46.00	-9.38	L2	Pass
0.721680	40.74	40.37	56.00	-15.63	40.34	46.00	-5.66		
0.866123	43.97	43.72	56.00	-12.28	43.69	46.00	-2.31		
1.010460	44.91	44.68	56.00	-11.32	44.67	46.00	-1.33		
1.587479	36.19	35.32	56.00	-20.68	35.00	46.00	-11.00		
1.731605	35.50	34.78	56.00	-21.22	34.66	46.00	-11.34		

\*- Margin = Measured emission - specification limit.

**Reference numbers of test equipment used**

HL 0163	HL 0787	HL 1430	HL 1502	HL 1510			
---------	---------	---------	---------	---------	--	--	--

Full description is given in Appendix A.



<b>Test specification:</b> Section 15.107, Conducted emission at AC power port			
<b>Test procedure:</b> ANSI C63.4, Sections 11.5 and 12.1.3			
<b>Test mode:</b> Compliance	<b>Verdict:</b> PASS		
<b>Date &amp; Time:</b> 7/11/2006 12:00:49 PM			
<b>Temperature:</b> 24°C	<b>Air Pressure:</b> 1010 hPa	<b>Relative Humidity:</b> 36 %	<b>Power Supply:</b> 120 VAC
<b>Remarks:</b>			

**Plot 8.1.1 Conducted emission measurements**

LINE: L1  
LIMIT: Class B  
EUT OPERATING MODE: Receive / Stand-by  
LIMIT: QUASI-PEAK, AVERAGE  
DETECTOR: PEAK

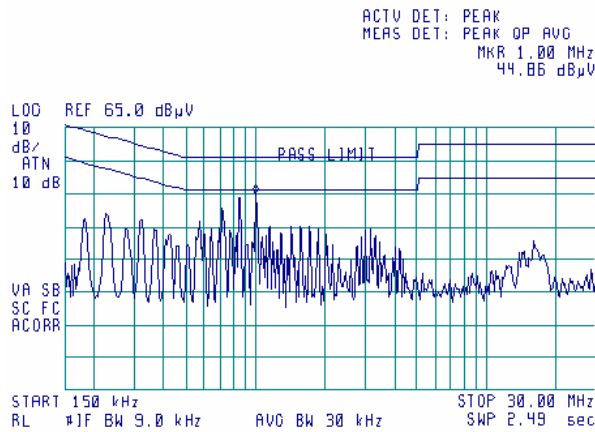

**Plot 8.1.2 Conducted emission measurements**

LINE: L2  
LIMIT: Class B  
EUT OPERATING MODE: Receive / Stand-by  
LIMIT: QUASI-PEAK, AVERAGE  
DETECTOR: PEAK

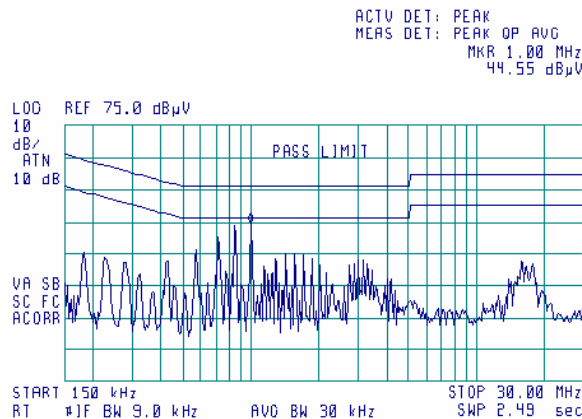

<b>Test specification:</b> Section 15.109, Radiated emission			
<b>Test procedure:</b> ANSI C63.4, Sections 11.6 and 12.1.4			
<b>Test mode:</b> Compliance	<b>Verdict:</b> PASS		
<b>Date &amp; Time:</b> 7/14/2006 3:16:50 PM			
<b>Temperature:</b> 25 °C	<b>Air Pressure:</b> 1013 hPa	<b>Relative Humidity:</b> 48 %	<b>Power Supply:</b> 120 VAC
<b>Remarks:</b>			

## 8.2 Radiated emission measurements

### 8.2.1 General

This test was performed to measure radiated emissions from the EUT enclosure. Specification test limits are given in Table 8.2.1.

Table 8.2.1 Radiated emission test limits

Frequency, MHz	Class B limit, dB(μV/m)		Class A limit, dB(μV/m)	
	10 m distance	3 m distance	10 m distance	3 m distance
30 - 88	29.5*	40.0	39.0	49.5*
88 - 216	33.0*	43.5	43.5	54.0*
216 - 960	35.5*	46.0	46.4	56.9*
Above 960	43.5*	54.0	49.5	60.0*

\* The limit for test distance other than specified was calculated using the inverse linear distance extrapolation factor as follows:  $Lim_{S_2} = Lim_{S_1} + 20 \log(S_1/S_2)$ , where  $S_1$  and  $S_2$  – standard defined and test distance respectively in meters.

### 8.2.2 Test procedure for measurements in semi-anechoic chamber

- 8.2.2.1 The EUT was set up as shown in Figure 8.2.1, energized and the performance check was conducted.
- 8.2.2.2 The specified frequency range was investigated with biconilog antenna connected to EMI receiver. To find maximum radiation the turntable was rotated 360°, the measuring antenna height was changed from 1 to 4 m, its polarization was switched from vertical to horizontal and the EUT cables position was varied.
- 8.2.2.3 The worst test results (the lowest margins) were recorded in Table 8.2.2 and shown in the associated plots.

### 8.2.3 Test procedure for measurements at OATS

- 8.2.3.1 The EUT was set up as shown in Figure 8.2.1 and associated photograph/s, energized and the performance check was conducted.
- 8.2.3.2 Preliminary measurements were performed in the anechoic chamber at 3 m test distance. The specified frequency range was investigated with biconical and log periodic antennas connected to EMI receiver. To find maximum radiation the turntable was rotated 360°, the measuring antenna height was changed, its polarization was switched from vertical to horizontal and the EUT cables position was varied.
- 8.2.3.3 The EUT was set up as shown in Figure 8.2.2, energized and the performance check was conducted.
- 8.2.3.4 Final measurements were performed at the open area test site at 10 m test distance. The EUT wires and cables were arranged to produce maximum emission as it was found during preliminary measurements. The frequencies yield the worst test results (the lowest margins) during preliminary testing were investigated with biconilog antenna connected to EMI receiver. To find maximum radiation the turntable was rotated 360°, the measuring antenna height was changed from 1 to 4 m and its polarization was changed from vertical to horizontal. At frequencies where high ambient noise was encountered, the final measurements were taken in the anechoic chamber at 3 m distance.
- 8.2.3.5 The worst test results (the lowest margins) were recorded in Table 8.2.2 and shown in the associated plots.

<b>Test specification:</b> Section 15.109, Radiated emission			
<b>Test procedure:</b> ANSI C63.4, Sections 11.6 and 12.1.4			
<b>Test mode:</b> Compliance	<b>Verdict:</b> PASS		
<b>Date &amp; Time:</b> 7/14/2006 3:16:50 PM			
<b>Temperature:</b> 25 °C	<b>Air Pressure:</b> 1013 hPa	<b>Relative Humidity:</b> 48 %	<b>Power Supply:</b> 120 VAC
<b>Remarks:</b>			

Figure 8.2.1 Setup for radiated emission measurements in anechoic chamber, table-top equipment

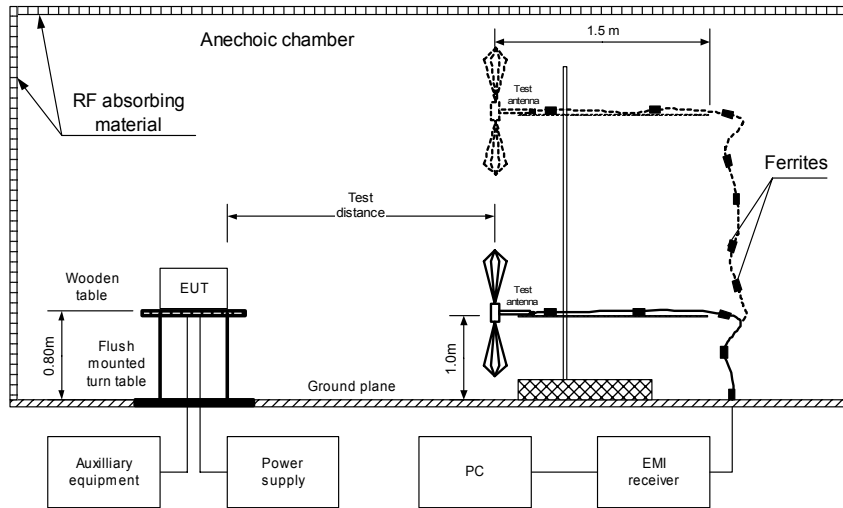
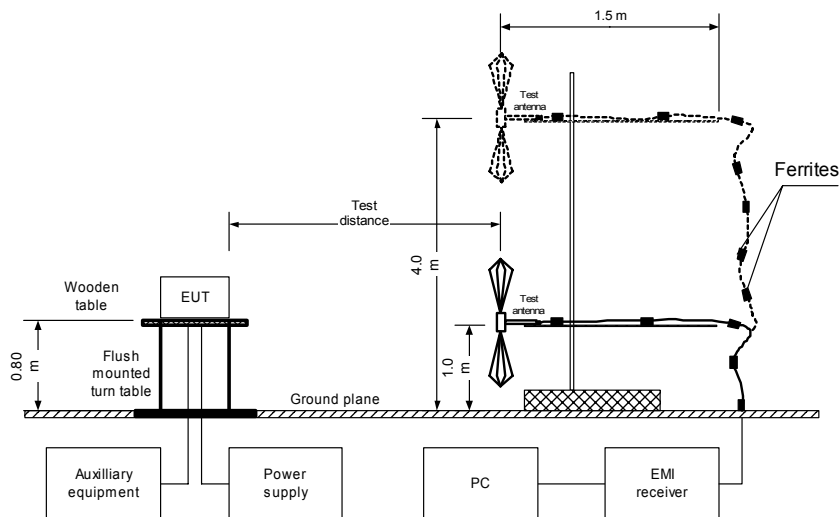

Figure 8.2.2 Setup for radiated emission measurements at OATS, table-top equipment



<b>Test specification:</b>		<b>Section 15.109, Radiated emission</b>	
<b>Test procedure:</b>		ANSI C63.4, Sections 11.6 and 12.1.4	
<b>Test mode:</b>	Compliance	<b>Verdict:</b>	<b>PASS</b>
<b>Date &amp; Time:</b>	7/14/2006 3:16:50 PM		
<b>Temperature:</b> 25 °C	<b>Air Pressure:</b> 1013 hPa	<b>Relative Humidity:</b> 48 %	<b>Power Supply:</b> 120 VAC
<b>Remarks:</b>			

**Table 8.2.2 Radiated emission test results**

EUT SET UP: TABLE-TOP  
LIMIT: Class B  
EUT OPERATING MODE: Receive / Stand-by  
TEST SITE: OATS  
TEST DISTANCE: 10 m  
DETECTORS USED: PEAK / QUASI-PEAK  
FREQUENCY RANGE: 30 MHz – 1000 MHz  
RESOLUTION BANDWIDTH: 120 kHz

Frequency, MHz	Peak emission, dB(μV/m)	Quasi-peak			Antenna polarization	Antenna height, m	Turn-table position**, degrees	Verdict
		Measured emission, dB(μV/m)	Limit, dB(μV/m)	Margin, dB*				
250.000231	33.35	30.21	35.50	-5.29	V	2.6	104	Pass
450.000000	32.12	26.67	35.50	-8.83	V	1.1	237	
500.017500	33.65	29.04	35.50	-6.46	V	1.5	207	
525.000000	33.43	27.46	35.50	-8.04	V	1.0	203	
575.000000	34.92	28.10	35.50	-7.40	V	1.4	236	

TEST SITE: SEMI ANECHOIC CHAMBER  
TEST DISTANCE: 3 m  
DETECTORS USED: PEAK / AVERAGE  
FREQUENCY RANGE: 1000 MHz – 26500 MHz  
RESOLUTION BANDWIDTH: 1000 kHz

Frequency, MHz	Peak emission, dB(μV/m)	Average			Antenna polarization	Antenna height, m	Turn-table position**, degrees	Verdict
		Measured emission, dB(μV/m)	Limit, dB(μV/m)	Margin, dB*				
No emissions were found								Pass

\*- Margin = Measured emission - specification limit.  
\*\*- EUT front panel refer to 0 degrees position of turntable.

**Reference numbers of test equipment used**

HL 1425	HL 1984	HL 2697					
---------	---------	---------	--	--	--	--	--

Full description is given in Appendix A.

<b>Test specification:</b>		<b>Section 15.109, Radiated emission</b>	
<b>Test procedure:</b>		ANSI C63.4, Sections 11.6 and 12.1.4	
<b>Test mode:</b>	Compliance	<b>Verdict:</b>	PASS
<b>Date &amp; Time:</b>	7/14/2006 3:16:50 PM		
<b>Temperature:</b> 25 °C	<b>Air Pressure:</b> 1013 hPa	<b>Relative Humidity:</b> 48 %	<b>Power Supply:</b> 120 VAC
<b>Remarks:</b>			

**Plot 8.2.1 Radiated emission measurements in 30 - 1000 MHz range, vertical and horizontal antenna polarization**

TEST SITE: Anechoic chamber  
LIMIT: Class B  
TEST DISTANCE: 3 m  
EUT OPERATING MODE: Receive / Stand-by

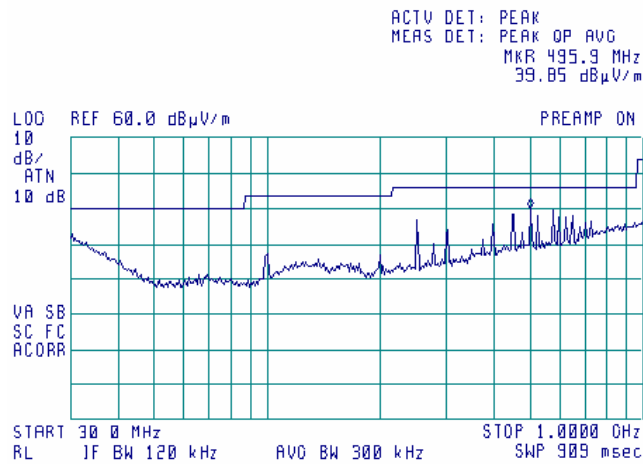

<b>Test specification:</b>	<b>Section 15.109, Radiated emission</b>		
<b>Test procedure:</b>	ANSI C63.4, Sections 11.6 and 12.1.4		
<b>Test mode:</b>	Compliance	<b>Verdict:</b>	<b>PASS</b>
<b>Date &amp; Time:</b>	7/14/2006 3:16:50 PM		
<b>Temperature:</b> 25 °C	<b>Air Pressure:</b> 1013 hPa	<b>Relative Humidity:</b> 48 %	<b>Power Supply:</b> 120 VAC
<b>Remarks:</b>			

**Plot 8.2.2 Radiated emission measurements in 1000 - 2900 MHz range**

TEST SITE: Anechoic chamber  
LIMIT: Class B  
TEST DISTANCE: 3 m  
EUT OPERATING MODE: Receive / Stand-by  
DETECTOR: Peak

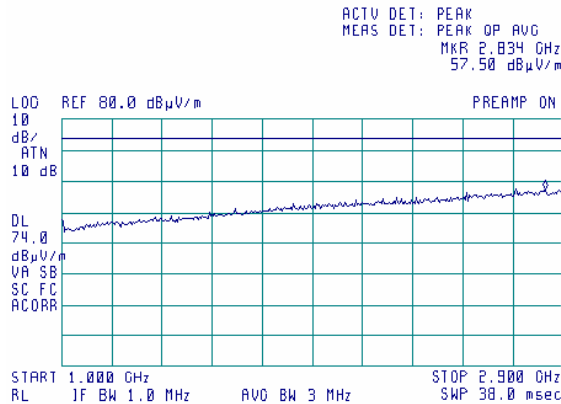

Note: according to FCC part §15.35: "...the limit on peak radio frequency emissions is 20 dB above the maximum permitted average emission limit applicable to the equipment under test."

**Plot 8.2.3 Radiated emission measurements in 1000 - 2900 MHz range**

TEST SITE: Anechoic chamber  
LIMIT: Class B  
TEST DISTANCE: 3 m  
EUT OPERATING MODE: Receive / Stand-by  
DETECTOR: Average

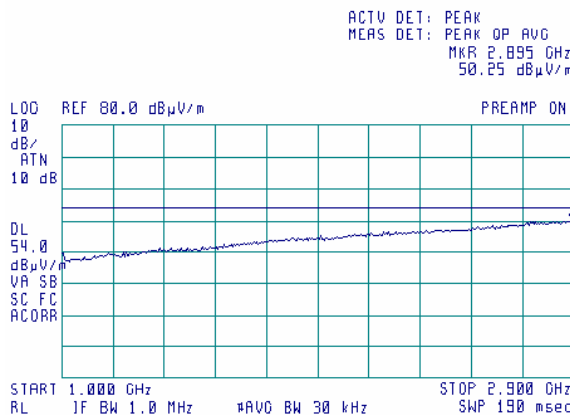

<b>Test specification:</b> Section 15.109, Radiated emission			
<b>Test procedure:</b> ANSI C63.4, Sections 11.6 and 12.1.4			
<b>Test mode:</b> Compliance	<b>Verdict:</b> PASS		
<b>Date &amp; Time:</b> 7/14/2006 3:16:50 PM			
<b>Temperature:</b> 25 °C	<b>Air Pressure:</b> 1013 hPa	<b>Relative Humidity:</b> 48 %	<b>Power Supply:</b> 120 VAC
<b>Remarks:</b>			

Plot 8.2.4 Radiated emission measurements in 2900 - 14000 MHz range

TEST SITE: Anechoic chamber  
LIMIT: Class B  
TEST DISTANCE: 3 m  
EUT OPERATING MODE: Receive / Stand-by  
DETECTOR: Peak

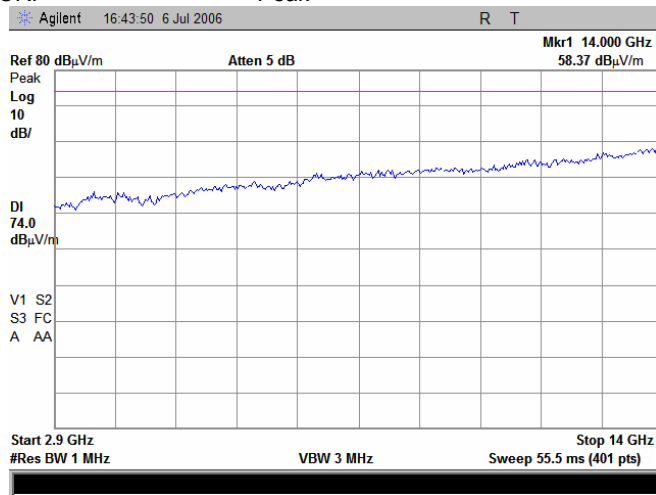

Plot 8.2.5 Radiated emission measurements in 2900 - 14000 MHz range

TEST SITE: Anechoic chamber  
LIMIT: Class B  
TEST DISTANCE: 3 m  
EUT OPERATING MODE: Receive / Stand-by  
DETECTOR: Average

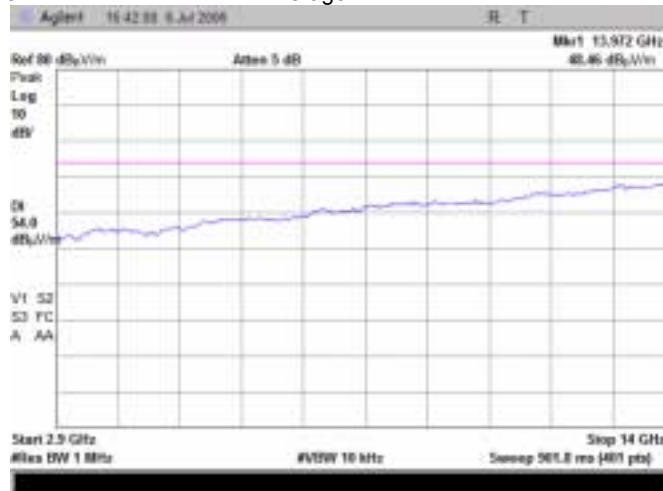

<b>Test specification:</b>	<b>Section 15.109, Radiated emission</b>		
<b>Test procedure:</b>	ANSI C63.4, Sections 11.6 and 12.1.4		
<b>Test mode:</b>	Compliance	<b>Verdict:</b>	<b>PASS</b>
<b>Date &amp; Time:</b>	7/14/2006 3:16:50 PM		
<b>Temperature:</b> 25 °C	<b>Air Pressure:</b> 1013 hPa	<b>Relative Humidity:</b> 48 %	<b>Power Supply:</b> 120 VAC
<b>Remarks:</b>			

**Plot 8.2.6 Radiated emission measurements from 14000 to 18000 MHz**

TEST SITE: Anechoic chamber  
 TEST DISTANCE: 3 m  
 ANTENNA POLARIZATION: Vertical and Horizontal  
 DETECTOR: Peak

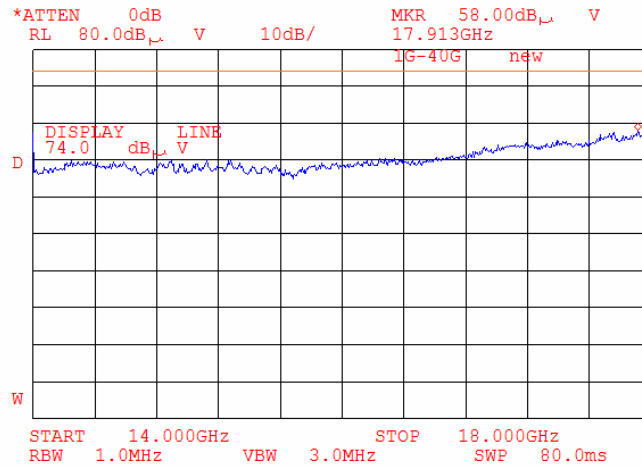

**Plot 8.2.7 Radiated emission measurements from 14000 to 18000 MHz**

TEST SITE: Anechoic chamber  
 TEST DISTANCE: 3 m  
 ANTENNA POLARIZATION: Vertical and Horizontal  
 DETECTOR: Average

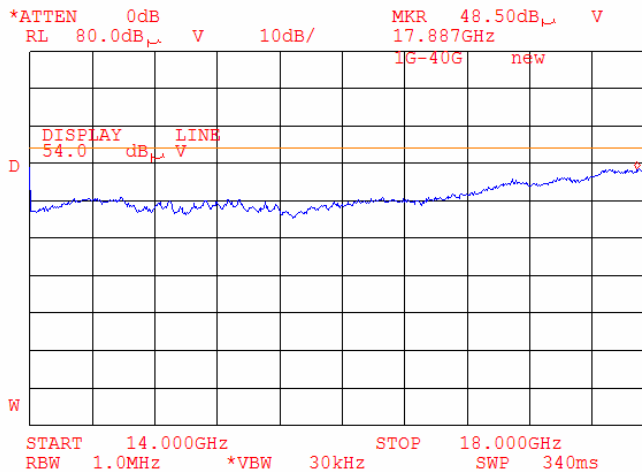



<b>Test specification:</b> Section 15.109, Radiated emission			
<b>Test procedure:</b> ANSI C63.4, Sections 11.6 and 12.1.4			
<b>Test mode:</b> Compliance	<b>Verdict:</b> PASS		
<b>Date &amp; Time:</b> 7/14/2006 3:16:50 PM			
<b>Temperature:</b> 25 °C	<b>Air Pressure:</b> 1013 hPa	<b>Relative Humidity:</b> 48 %	<b>Power Supply:</b> 120 VAC
<b>Remarks:</b>			

**Plot 8.2.8 Radiated emission measurements from 18000 to 26500 MHz**

TEST SITE: Anechoic chamber  
 TEST DISTANCE: 3 m  
 ANTENNA POLARIZATION: Vertical and Horizontal  
 DETECTOR: Peak

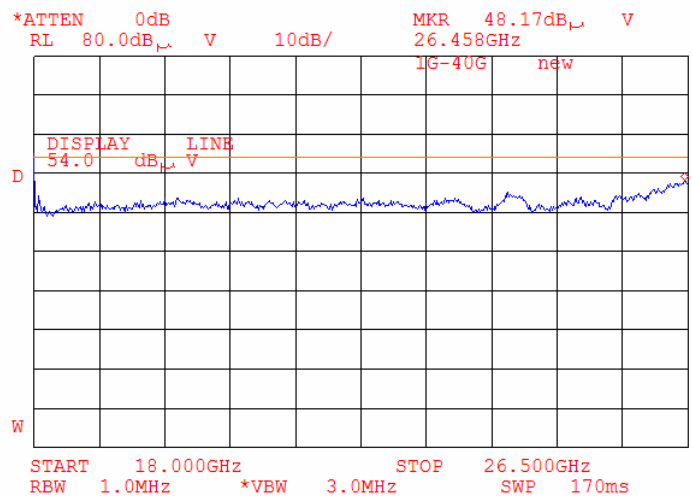

## 9 APPENDIX A Test equipment and ancillaries used for tests

HL No	Description	Manufacturer	Model	Ser. No.	Last Cal.	Due Cal.
0163	LISN FCC/VDE/MIL-STD	Electro-Metrics	ANS 25/2	1314	01-Oct-05	01-Oct-06
0410	Cable, Coax, Microwave, DC-18 GHz, N-N, 1 m	Gore	PFP01P0 1039.4	9338767	17-Oct-05	17-Oct-06
0446	Antenna, Loop active, 10kHz-30MHz	EMCO	6502	2857	28-Jun-06	28-Jun-07
0672	Shielded Room 4,6(L) x 4,2(W) x 2,4(H) m	HL	SR - 3	027	11-Nov-05	11-Nov-06
0768	Antenna Standard Gain Horn, 18-26.5 GHz, WR-42, K-band, Gain - 25 dB	Quinstar Technology	QWH-4200-BA	110	21-Jul-04	21-Jul-07
0769	Antenna Standard Gain Horn, 26.5-40 GHz, WR28, Ka band, Gain 25 dB	Quinstar Technology	QWH-2800-BA	112	21-Jul-04	21-Jul-07
0787	Transient Limiter	Hewlett Packard	11947A	3107A01877	21-Nov-05	21-Nov-06
1200	Quadruplexer 1-12 GHz (1-2 GHz; 2-4GHz;4-8 GHz; 8-12GHz)	Electronica S.p.A. - Roma	UE 84	D/00240	10-Feb-05	10-Feb-07
1424	Spectrum Analyzer, 30 Hz- 40 GHz	Agilent Technologies	8564EC	3946A00219	30-Aug-05	30-Aug-06
1425	EMI Receiver, 9 kHz - 2.9 GHz, System: HL1426, HL1427	Agilent Technologies	8542E	3710A00222, 3705A00204	01-Sep-05	01-Sep-06
1430	EMI Receiver, 9 kHz - 2.9 GHz, System: HL1431, HL1432	Agilent Technologies	8542E	3807A00262,3705A00217	01-Sep-05	01-Sep-06
1502	Cable RF, 6 m	Belden	M17/167 MIL-C-17	1502	02-Dec-05	02-Dec-06
1510	Cable RF, 8 m	Belden	M17/167 MIL-C-17	1510	02-Dec-05	02-Dec-06
1553	Cable RF, 3.5 m	Alpha Wire	RG-214	1553	02-Dec-05	02-Dec-06
1566	Cable RF, 2 m	Huber-Suhner	Sucoflex 104PE	13094/4PE	02-Dec-05	02-Dec-06
1567	Cable RF, 2 m	Huber-Suhner	Sucoflex 104PE	13095/4PE	02-Dec-05	02-Dec-06
1650	Attenuators Set (2, 3, 5, 20 dB), DC-18 GHz	M/A-COM	2082	1650	03-Jan-06	03-Jan-07
1653	Analyzer EMC 9 kHz - 1.5 GHz	Agilent Technologies	E7401A	US39440281	06-Feb-06	06-Feb-07
1984	Antenna, Double-Ridged Waveguide Horn, 1-18 GHz, 300 W, N-type	EMC Test Systems	3115	9911-5964	03-Mar-06	03-Mar-07
2254	Cable 40GHz, 0.8 m, blue	Rhophase Microwave Limited	KPS-1503A-800-KPS	W4907	21-Jun-06	21-Jun-07
2259	Amplifier Low Noise 2-20 GHz	Sophia Wireless	LNA0220-C	0223	05-Nov-05	05-Nov-06
2260	Amplifier Low Noise 14-33 GHz	Sophia Wireless	LNA28-B	0233	05-Nov-05	05-Nov-06
2261	Amplifier Low Noise 33-40 GHz	Sophia Wireless	LNA38-B	0234	05-Nov-05	05-Nov-06
2400	Cable 40GHz, 1.5 m, green	Rhophase Microwave Limited	KPS-1503A-1500-KPS	X2946	21-Jun-06	21-Jun-07

HL No	Description	Manufacturer	Model	Ser. No.	Last Cal.	Due Cal.
2697	Antenna, 30 MHz - 3.0 GHz,	Sunol Sciences Corp. Pleasanton, California USA	JB3	A022805	10-Jan-06	10-Jan-07
2780	EMS analyzer, 100 Hz to 26.5 GHz	Agilent Technologies	E7405A	MY4510246	11-Jun-06	11-Jun-07
2909	Spectrum analyzer, ESA-E, 100 Hz to 26.5 GHz	Agilent Technologies	E4407B	MY41444762	10-Apr-06	10-Apr-07

## 10 APPENDIX B Measurement uncertainties

Expanded uncertainty at 95% confidence in Hermon Labs EMC measurements

Test description	Expanded uncertainty
Conducted carrier power at RF antenna connector	Below 12.4 GHz: $\pm 1.7$ dB 12.4 GHz to 40 GHz: $\pm 2.3$ dB
Conducted emissions at RF antenna connector	9 kHz to 2.9 GHz: $\pm 2.6$ dB 2.9 GHz to 6.46 GHz: $\pm 3.5$ dB 6.46 GHz to 13.2 GHz: $\pm 4.3$ dB 13.2 GHz to 22.0 GHz: $\pm 5.0$ dB 22.0 GHz to 26.8 GHz: $\pm 5.5$ dB 26.8 GHz to 40.0 GHz: $\pm 4.8$ dB
Occupied bandwidth	$\pm 8.0$ %
Duty cycle, timing (Tx ON / OFF) and average factor measurements	$\pm 1.0$ %
Conducted emissions with LISN	9 kHz to 150 kHz: $\pm 3.9$ dB 150 kHz to 30 MHz: $\pm 3.8$ dB
Radiated emissions at 3 m measuring distance Horizontal polarization  Vertical polarization	Biconilog antenna: $\pm 5.3$ dB Biconical antenna: $\pm 5.0$ dB Log periodic antenna: $\pm 5.3$ dB Double ridged horn antenna: $\pm 5.3$ dB Biconilog antenna: $\pm 6.0$ dB Biconical antenna: $\pm 5.7$ dB Log periodic antenna: $\pm 6.0$ dB Double ridged horn antenna: $\pm 6.0$ dB

The test equipment has been calibrated according to its recommended procedures and is within the manufacturer's published limit of error. The standards and instruments used in the calibration system conform to the present requirements of ISO/IEC 17025 (or alternately ANSI/NC SL Z540-1).

The laboratory calibrates its measurement standards by a third party (traceable to NIST, USA) on a regular basis according to equipment manufacturer requirements. The Hermon Labs EMC measurements uncertainty is given in the table above.

## 11 APPENDIX C Test facility description

Tests were performed at Hermon Laboratories Ltd., which is a fully independent, private, EMC, safety, environmental and telecommunication testing facility. Hermon Laboratories is listed by the Federal Communications Commission (USA) for all parts of Code of Federal Regulations 47 (CFR 47) and by Industry Canada for electromagnetic emissions (file numbers IC 2186-1 for OATS and IC 2186-2 for anechoic chamber), certified by VCCI, Japan (the registration numbers are R-808 for OATS, R-1082 for anechoic chamber, C-845 for conducted emissions site), assessed by TNO Certification EP&S (Netherlands) for a number of EMC, telecommunications, environmental, safety standards, and by AMTAC (UK) for safety of medical devices. The laboratory is accredited by American Association for Laboratory Accreditation (USA) according to ISO/IEC 17025 for electromagnetic compatibility, product safety, telecommunications testing and environmental simulation (for exact scope please refer to Certificate No. 839.01).

Address: P.O. Box 23, Binyamina 30500, Israel.  
Telephone: +972 4628 8001  
Fax: +972 4628 8277  
e-mail: mail@hermonlabs.com  
website: www.hermonlabs.com

Person for contact: Mr. Alex Usoskin, CEO.

## 12 APPENDIX D Specification references

47CFR part 15: 2005	Radio Frequency Devices.
FR Vol.62	Federal Register, Volume 62, May 13, 1997
ANSI C63.2: 1996	American National Standard for Instrumentation-Electromagnetic Noise and Field Strength, 10 kHz to 40 GHz-Specifications.
ANSI C63.4: 2003	American National Standard for Methods of Measurement of Radio-Noise Emissions from Low-Voltage Electrical and Electronic Equipment in the Range of 9 kHz to 40 GHz.

### 13 APPENDIX E Abbreviations and acronyms

A	ampere
AC	alternating current
AM	amplitude modulation
AVRG	average (detector)
cm	centimeter
dB	decibel
dBm	decibel referred to one milliwatt
dB( $\mu$ V)	decibel referred to one microvolt
dB( $\mu$ V/m)	decibel referred to one microvolt per meter
dB( $\mu$ A)	decibel referred to one microampere
dB $\Omega$	decibel referred to one Ohm
DC	direct current
DTS	digital transmission system
EIRP	equivalent isotropically radiated power
ERP	effective radiated power
EUT	equipment under test
F	frequency
FHSS	frequency hopping spread spectrum
GHz	gigahertz
GND	ground
H	height
HL	Hermon laboratories
Hz	hertz
ITE	information technology equipment
k	kilo
kHz	kilohertz
LISN	line impedance stabilization network
LO	local oscillator
m	meter
MHz	megahertz
min	minute
mm	millimeter
ms	millisecond
$\mu$ s	microsecond
NA	not applicable
NT	not tested
OATS	open area test site
$\Omega$	Ohm
PM	pulse modulation
PS	power supply
ppm	part per million ( $10^{-6}$ )
QP	quasi-peak
RE	radiated emission
RF	radio frequency
rms	root mean square
Rx	receive
s	second
T	temperature
Tx	transmit
V	volt
VA	volt-ampere

**14 APPENDIX F Test equipment correction factors**

Correction factor  
Line impedance stabilization network  
Model ANS-25/2  
Electro-Metrics

Frequency, MHz	Correction factor, dB	Frequency, MHz	Correction factor, dB
0.01	4.7	3.0	0.1
0.02	2.1	4.0	0.1
0.03	1.1	5.0	0.1
0.04	0.7	6.0	0.1
0.05	0.5	10.0	0.1
0.1	0.2	12.0	0.1
0.2	0.1	16.0	0.1
0.4	0.1	18.0	0.1
0.6	0.1	20.0	0.1
0.8	0.1	25.0	0.1
1.0	0.1	28.0	0.1
2.0	0.1	30.0	0.1

The correction factor in dB is to be added to meter readings of an interference analyzer or a spectrum analyzer.

**Antenna Factor**  
**Active Loop Antenna**  
**EMC Test Systems, model 6502, serial number 2857, HL 0446**

Frequency, MHz	Magnetic Antenna Factor, dB(S/m)	Electric Antenna Factor, dB(1/m)
0.009	-32.8	18.7
0.010	-33.8	17.7
0.020	-38.3	13.2
0.050	-41.1	10.4
0.075	-41.3	10.2
0.100	-41.6	9.9
0.150	-41.7	9.8
0.250	-41.6	9.9
0.500	-41.8	9.7
0.750	-41.9	9.6
1.000	-41.4	10.1
2.000	-41.5	10.0
3.000	-41.4	10.1
4.000	-41.4	10.1
5.000	-41.5	10.0
10.000	-41.9	9.6
15.000	-41.9	9.6
20.000	-42.2	9.3
25.000	-42.8	8.7
30.000	-44.0	7.5

Antenna factor in dB(S/m) is to be added to receiver meter reading in dB( $\mu$ V) to convert it into field intensity in dB( $\mu$ A/m).  
Antenna factor in dB(1/m) is to be added to receiver meter reading in dB( $\mu$ V) to convert it into field intensity in dB( $\mu$ V/m).

**Antenna factor**  
**Standard gain horn antenna**  
**Quinstar Technology**  
**Model QWH**  
**Ser.No.110, HL 0768, 0769**

Frequency min, GHz	Frequency max, GHz	Antenna factor, dB(1/m)
18.000	26.500	32.01
26.500	40.000	35.48
40.000	60.000	39.03
60.000	90.000	42.55
90.000	140.000	46.23
140.000	220.000	50.11

Antenna factor in dB(1/m) is to be added to receiver meter reading in dB( $\mu$ V) to convert it into field intensity in dB( $\mu$ V/m).



**Antenna factor**  
**Double-ridged wave guide horn antenna**  
**Model 3115, S/N 9911-5964, HL1984**

Frequency, MHz	Antenna factor, dB(1/m)
1000.0	24.7
1500.0	25.7
2000.0	27.6
2500.0	28.9
3000.0	31.2
3500.0	32.0
4000.0	32.5
4500.0	32.7
5000.0	33.6
5500.0	35.1
6000.0	35.4
6500.0	34.9
7000.0	36.1
7500.0	37.8
8000.0	38.0
8500.0	38.1
9000.0	39.1
9500.0	38.3
10000.0	38.6
10500.0	38.2
11000.0	38.7
11500.0	39.5
12000.0	40.0
12500.0	40.4
13000.0	40.5
13500.0	41.1
14000.0	41.6
14500.0	41.7
15000.0	38.7
15500.0	38.2
16000.0	38.8
16500.0	40.5
17000.0	42.5
17500.0	45.9
18000.0	49.4

Antenna factor in dB(1/m) is to be added to receiver meter reading in dB( $\mu$ V) to convert it into field intensity in dB( $\mu$ V/m).

Antenna calibration  
Sunol Sciences Inc., model JB3, serial number A022805

Frequency, MHz	ACF, dB	Gain, dBi	Num gain	Frequency, MHz	ACF, dB	Gain, dBi	Num gain	Frequency, MHz	ACF, dB	Gain, dBi	Num gain	Frequency, MHz	ACF, dB	Gain, dBi	Num gain	Frequency, MHz	ACF, dB	Gain, dBi	Num gain
30	22.2	-22.5	0.01	620	19.7	6.3	4.27	1215	24.9	7.0	5.05	1810	28.3	7.1	5.08	2405	30.9	6.9	4.93
35	18.5	-17.4	0.02	625	19.7	6.5	4.42	1220	24.9	7.0	4.99	1815	28.5	6.9	4.91	2410	30.9	6.9	4.89
40	14.7	-12.5	0.06	630	19.6	6.6	4.57	1225	25.1	6.9	4.91	1820	28.6	6.8	4.74	2415	31.0	6.9	4.85
45	11.3	-8.1	0.16	635	19.7	6.5	4.48	1230	25.2	6.8	4.82	1825	28.7	6.8	4.76	2420	31.0	6.8	4.82
45	11.3	-8.1	0.16	640	19.9	6.4	4.40	1235	25.1	7.0	4.96	1830	28.7	6.8	4.76	2425	31.1	6.8	4.81
50	8.9	-4.7	0.34	645	19.9	6.5	4.45	1240	25.0	7.1	5.09	1835	28.7	6.7	4.72	2430	31.0	6.9	4.87
55	7.9	-2.8	0.52	650	19.9	6.5	4.51	1245	25.0	7.1	5.12	1840	28.8	6.7	4.69	2435	31.0	6.9	4.88
60	7.8	-2.1	0.62	655	19.9	6.6	4.60	1250	25.0	7.1	5.15	1845	28.6	6.9	4.90	2440	31.2	6.8	4.74
65	8.5	2.0	0.83	660	19.9	6.7	4.69	1255	25.0	7.2	5.25	1850	28.4	7.1	5.12	2445	31.1	6.9	4.91
70	9.0	-1.9	0.64	665	19.9	6.7	4.70	1260	24.9	7.3	5.36	1855	28.5	7.0	5.07	2450	31.0	7.0	4.96
75	8.8	-1.1	0.78	670	20.0	6.7	4.71	1265	25.0	7.3	5.31	1860	28.6	7.0	5.01	2455	31.0	7.0	5.01
80	8.4	-0.2	0.97	675	20.1	6.7	4.71	1270	25.1	7.2	5.26	1865	28.5	7.1	5.17	2460	30.9	7.2	5.19
85	8.0	0.8	1.20	680	20.1	6.7	4.71	1275	25.3	7.0	5.05	1870	28.4	7.3	5.33	2465	31.1	6.9	4.95
90	8.2	1.1	1.29	685	20.1	6.8	4.79	1280	25.5	6.8	4.94	1875	28.4	7.2	5.28	2470	31.3	6.8	4.76
95	9.2	0.5	1.13	690	20.1	6.9	4.88	1285	25.4	7.0	4.97	1880	28.5	7.2	5.22	2475	31.4	6.7	4.69
100	10.6	-0.4	0.92	695	20.2	6.8	4.82	1290	25.3	7.1	5.10	1885	28.5	7.2	5.22	2480	31.3	6.8	4.79
105	11.7	-1.1	0.78	700	20.3	6.8	4.76	1295	25.3	7.2	5.22	1890	28.6	7.2	5.21	2485	31.1	7.0	5.00
110	12.6	-1.6	0.70	705	20.4	6.8	4.75	1300	25.2	7.3	5.31	1895	28.6	7.2	5.24	2490	31.1	7.0	4.99
115	13.3	-1.9	0.65	710	20.5	6.8	4.75	1305	25.2	7.3	5.21	1900	28.6	7.2	5.27	2495	31.2	7.0	4.99
120	13.9	-2.1	0.62	715	20.5	6.8	4.80	1310	25.5	7.1	5.09	1905	28.5	7.3	5.36	2500	30.9	7.2	5.27
125	14.2	-2.0	0.63	720	20.5	6.9	4.85	1315	25.4	7.2	5.23	1910	28.5	7.4	5.45	2505	31.1	7.1	5.15
130	14.2	-1.7	0.68	725	20.6	6.8	4.81	1320	25.3	7.3	5.36	1915	28.5	7.3	5.38	2510	31.0	7.2	5.22
135	13.8	-1.0	0.79	730	20.7	6.8	4.77	1325	25.5	7.2	5.21	1920	28.6	7.3	5.31	2515	31.0	7.2	5.26
140	13.4	0.3	0.94	735	20.9	6.7	4.65	1330	25.6	7.0	5.06	1925	28.6	7.3	5.38	2520	31.2	7.0	5.05
145	13.1	0.3	1.08	740	21.0	6.6	4.53	1335	25.7	7.1	5.07	1930	28.6	7.3	5.39	2525	30.8	7.4	5.54
150	12.9	0.8	1.21	745	21.0	6.6	4.59	1340	25.7	7.1	5.09	1935	28.5	7.4	5.54	2530	31.0	7.3	5.37
160	12.7	1.6	1.44	755	21.0	6.8	4.74	1350	25.7	7.1	5.17	1945	28.5	7.5	5.69	2540	31.2	7.1	5.09
165	12.5	2.0	1.59	760	21.0	6.8	4.83	1355	25.8	7.0	5.06	1950	28.6	7.4	5.48	2545	31.0	7.3	5.43
170	12.6	2.6	1.83	765	21.1	6.8	4.73	1360	25.8	7.1	5.17	1955	28.5	7.4	5.45	2550	31.0	7.3	5.39
175	11.8	3.3	2.13	770	21.3	6.7	4.64	1365	26.0	6.9	4.95	1960	28.6	7.5	5.65	2555	31.1	7.2	5.30
180	11.6	3.7	2.36	775	21.3	6.7	4.68	1370	26.0	7.0	4.96	1965	28.7	7.4	5.47	2560	31.0	7.4	5.47
190	11.6	4.2	2.61	785	21.3	6.8	4.77	1380	26.0	7.0	5.06	1975	28.9	7.2	5.22	2570	31.1	7.3	5.37
200	13.1	3.2	2.07	795	21.4	6.8	4.79	1390	26.1	6.9	4.92	1985	29.1	7.1	5.11	2580	31.6	6.9	4.87
205	14.4	4.4	2.78	800	21.5	6.8	4.77	1395	26.2	6.9	4.94	1990	29.0	7.0	5.06	2585	31.6	6.9	4.79
210	11.0	5.6	3.66	805	21.6	6.7	4.71	1400	26.2	7.0	4.96	1995	29.1	7.1	5.09	2590	31.6	6.9	4.88
215	11.3	5.6	3.99	810	21.7	6.7	4.65	1405	26.1	7.0	5.02	2000	29.1	7.1	5.11	2595	31.5	7.0	4.97
220	11.6	5.5	3.62	815	21.7	6.7	4.72	1410	26.1	7.1	5.09	2005	29.1	7.1	5.16	2600	31.6	6.9	4.86
225	11.7	5.5	3.55	820	21.7	6.8	4.80	1415	26.2	7.0	5.02	2010	29.1	7.1	5.15	2605	31.3	7.2	5.30
230	11.9	5.5	3.57	825	21.7	6.8	4.82	1420	26.3	7.0	4.96	2015	29.2	7.1	5.13	2610	31.4	7.1	5.15
235	12.1	5.5	3.56	830	21.7	6.8	4.85	1425	26.2	7.1	5.10	2020	29.2	7.1	5.18	2615	31.7	6.9	4.88
240	12.3	5.5	3.54	835	21.8	6.8	4.82	1430	26.1	7.2	5.25	2025	29.3	7.1	5.08	2620	31.6	7.0	4.97
245	12.3	5.7	3.71	840	21.9	6.8	4.80	1435	26.1	7.2	5.24	2030	29.3	7.0	5.05	2625	31.4	7.1	5.17
250	12.3	5.9	3.88	845	21.9	6.8	4.83	1440	26.2	7.2	5.24	2035	29.3	7.1	5.07	2630	31.6	7.0	5.00
255	12.5	5.9	3.85	850	21.9	6.9	4.86	1445	26.3	7.1	5.11	2040	29.3	7.1	5.13	2635	31.8	6.8	4.82
260	12.7	5.8	3.83	855	22.0	6.8	4.80	1450	26.5	7.0	4.98	2045	29.2	7.2	5.23	2640	31.7	7.0	4.98
265	13.2	5.5	3.54	860	22.1	6.8	4.74	1455	26.4	7.1	5.07	2050	29.2	7.2	5.27	2645	31.7	6.9	4.93
270	13.7	5.2	3.27	865	22.0	6.9	4.92	1460	26.4	7.1	5.17	2055	29.3	7.2	5.21	2650	31.8	6.9	4.85
275	13.7	5.3	3.39	870	21.9	7.1	5.11	1465	26.4	7.2	5.19	2060	29.5	7.0	5.02	2655	31.8	6.9	4.85
280	13.7	5.4	3.50	875	22.0	7.1	5.08	1470	26.4	7.2	5.22	2065	29.4	7.1	5.08	2660	31.7	7.0	5.02
285	13.7	5.6	3.61	880	22.1	7.0	5.05	1475	26.4	7.1	5.17	2070	29.4	7.1	5.10	2665	32.0	6.7	4.71
290	13.7	5.7	3.72	885	22.1	7.0	5.06	1480	26.5	7.1	5.12	2075	29.5	7.0	5.01	2670	32.0	6.7	4.67
295	13.8	5.8	3.77	890	22.1	7.0	5.08	1485	26.5	7.1	5.14	2080	29.8	6.8	4.78	2675	31.9	6.8	4.81
300	13.9	5.8	3.81	895	22.2	7.1	5.09	1490	26.5	7.1	5.17	2085	29.7	6.8	4.88	2680	31.6	7.0	5.04
305	14.0	5.9	3.85	900	22.2	7.1	5.12	1495	26.5	7.2	5.24	2090	29.7	6.9	4.86	2685	31.9	6.8	4.83
310	14.1	5.9	3.88	905	22.3	7.1	5.09	1500	26.5	7.2	5.31	2095	29.8	6.8	4.78	2690	32.1	6.7	4.72
315	14.3	5.9	3.89	910	22.3	7.0	5.05	1505	26.5	7.2	5.27	2100	29.9	6.8	4.75	2695	32.1	6.7	4.71
320	14.4	5.9	3.90	915	22.4	7.0	4.99	1510	26.6	7.2	5.23	2105	29.8	6.8	4.81	2700	32.0	6.8	4.81
325	14.5	5.9	3.92	920	22.6	6.9	4.92	1515	26.6	7.2	5.30	2110	29.9	6.8	4.78	2705	32.0	6.8	4.80
330	14.6	5.9	3.93	925	22.7	6.9	4.85	1520	26.5	7.3	5.38	2115	29.9	6.8	4.76	2710	32.1	6.8	4.79
335	14.7	6.0	4.02	930	22.8	6.8	4.77	1525	26.6	7.3	5.37	2120	29.9	6.8	4.84	2715	32.1	6.8	4.71
340	14.7	6.2	4.12	935	22.8	6.8	4.83	1530	26.6	7.3	5.36	2125	29.9	6.9	4.89	2720	32.4	6.5	4.47
345	14.9	6.1	4.06	940	22.8	6.9	4.89	1535	26.6	7.4	5.44	2130	29.9	6.9	4.80	2725	32.2	6.7	4.63
350	15.1	6.0	3.99	945	22.8	6.9	4.87	1540	26.5	7.4	5.53	2135	29.8	6.9	4.94	2730	31.9	7.0	5.05
360	15.6	5.8	3.78	955	23.0	6.8	4.81	1550	26.5	7.5	5.63	2145	29.9	6.9	4.92	2740	31.6	7.1	5.46
365	15.5	5.9	3.89	960	23.1	6.8	4.77	1555	26.7	7.3	5.39	2150	29.9	7.0	4.98	2745	31.9	7.0	5.36
370	15.5	6.0	4.01	965	23.1	6.7	4.73	1560	26.9	7.1	5.16	2155	29.8	7.1	5.10	2750	32.0	6.9	4.94
375	15.6	6.1	4.03	970	23.2	6.7	4.69	1565	26.9	7.2	5.23	2160	29.8	7.1	5.09	2755	32.0	7.0	4.98
380	15.7	6.1	4.05	975	23.3														

**Cable loss**  
**Cable GORE, HL 0410**

No.	Frequency, GHz	Cable loss, dB
1	0.5	0.16
2	1	0.28
3	2	0.38
4	4	0.55
5	6	0.85
6	8	0.90
7	10	1.07
8	12	1.11
9	14	1.29
10	16	1.41
11	18	1.73

**Cable loss**  
**Cable coaxial, 6 m, model: M17/167 MIL-C-17, HL 1502**

Frequency, MHz	Cable loss, dB
0.1	0.02
1	0.07
3	0.15
5	0.17
10	0.26
30	0.43
50	0.57
80	0.72
100	0.81
300	1.48
500	2.00
800	2.70
1000	3.09

**Cable loss**  
**Cable M17/167 MIL-C-17, HL 1510**

No.	Frequency, MHz	Cable loss, dB
1	0.1	0.05
2	1	0.09
3	3	0.16
4	5	0.18
5	10	0.27
6	30	0.44
7	50	0.58
8	80	0.69
9	100	0.82
10	300	1.48
11	500	2.01
12	800	2.65
13	1000	3.12

**Cable loss**  
**RF cable 3.5 m, Alpha Wire, model RG-214, S/N 149, HL 1553**

No.	Frequency, MHz	Cable loss, dB	Measurement uncertainty, dB
1	1	0.01	±0.05
2	10	0.07	
3	30	0.12	
4	50	0.22	
5	100	0.26	
6	200	0.40	
7	300	0.52	
8	400	0.60	
9	500	0.70	
10	600	0.77	
11	700	0.84	
12	800	1.00	
13	900	1.00	
14	1000	1.05	
15	2000	1.70	

**Cable loss**  
Cable RF, 2m, model: Sucoflex 104PE, S/N 13094/4PE, HL 1566

No.	Frequency, MHz	Cable loss, dB	Tolerance, dB	Measurement uncertainty, dB
1	30	0.10	≤ 5.0	±0.12
2	50	0.13		
3	100	0.20		
4	300	0.33		
5	500	0.45		
6	800	0.60		
7	1000	0.65		
8	1500	0.91		
9	2000	1.08		
10	2500	1.19		
11	3000	1.28		
12	3500	1.49		
13	4000	1.63		
14	4500	1.63	≤ 5.0	±0.17
15	5000	1.66		
16	5500	1.88		
17	6000	1.96		
18	6500	1.93		
19	7000	2.07		
20	7500	2.37		
21	8000	2.34		
22	8500	2.64		
23	9000	2.68		
24	9500	2.64		
25	10000	2.70		
26	10500	2.84		
27	11000	2.88		
28	11500	3.19		
29	12000	3.15	≤ 5.0	±0.26
30	12500	3.20		
31	13000	3.22		
32	13500	3.47		
33	14000	3.41		
34	14500	3.59		
35	15000	3.79		
36	15500	4.24		
37	16000	4.12		
38	16500	4.46		
39	17000	4.50		
40	17500	4.49		
41	18000	4.45		

**Cable loss**  
Cable RF, 2 m, model: Sucoflex 104PE, s/n 13095/4PE, HL 1567

No.	Frequency, MHz	Cable loss, dB
1	30	0.09
2	50	0.15
3	100	0.23
4	300	0.31
5	500	0.46
6	800	0.63
7	1000	0.67
8	1500	0.89
9	2000	1.05
10	2500	1.18
11	300	1.26
12	5300	1.51
13	4000	1.66
14	4500	1.61
15	5000	1.67
16	5500	1.91
17	6000	1.98
18	6500	1.91
19	7000	2.04
20	7500	2.36
21	8000	2.36
22	8500	2.61
23	9000	2.69
24	9500	2.62
25	10000	2.73
26	10500	2.83
27	11000	2.84
28	11500	3.22
29	12000	3.17
30	12500	3.17
31	13000	3.18
32	13500	3.49
33	14000	3.43
34	14500	3.57
35	15000	3.76
36	15500	4.20
37	16000	4.10
38	16500	4.49
39	17000	4.53
40	17500	4.46
41	18000	4.47

**Cable loss**  
**Cable 40 GHz, 0.8 m, blue, model: KPS-1503A-800-KPS, S/N W4907, HL 2254**

Frequency, GHz	Cable loss, dB	Frequency, GHz	Cable loss, dB	Frequency, GHz	Cable loss, dB
0.03	0.04	5.10	0.80	15.00	1.49
0.05	0.07	5.30	0.83	15.50	1.49
0.10	0.09	5.50	0.83	16.00	1.46
0.20	0.15	5.70	0.84	16.50	1.47
0.30	0.19	5.90	0.87	17.00	1.50
0.40	0.25	6.10	0.86	17.50	1.57
0.50	0.29	6.30	0.89	18.00	1.63
0.60	0.33	6.50	0.90	18.50	1.57
0.70	0.37	6.70	0.89	19.00	1.63
0.80	0.41	6.90	0.93	19.50	1.65
0.90	0.44	7.10	0.92	20.00	1.64
1.00	0.45	7.30	0.95	20.50	1.75
1.10	0.48	7.50	0.96	21.00	1.72
1.20	0.51	7.70	0.97	21.50	1.78
1.30	0.53	7.90	1.01	22.00	1.76
1.40	0.54	8.10	1.00	22.50	1.72
1.50	0.57	8.30	1.05	23.00	1.83
1.60	0.59	8.50	1.04	23.50	1.80
1.70	0.04	8.70	1.07	24.00	1.90
1.80	0.07	8.90	1.11	24.50	1.81
1.90	0.09	9.10	1.09	25.00	1.98
2.00	0.15	9.30	1.14	25.50	1.91
2.10	0.19	9.50	1.12	26.00	2.02
2.20	0.25	9.70	1.15	26.50	1.92
2.30	0.29	9.90	1.16	27.00	1.97
2.40	0.33	10.10	1.16	28.00	2.02
2.50	0.37	10.30	1.19	29.00	1.95
2.60	0.41	10.50	1.14	30.00	1.94
2.70	0.44	10.70	1.19	31.00	2.11
2.80	0.45	10.90	1.17	32.00	2.17
2.90	0.48	11.10	1.13	33.00	2.27
3.10	0.61	11.30	1.20	34.00	2.27
3.30	0.64	11.50	1.13	35.00	2.29
3.50	0.65	11.70	1.20	36.00	2.35
3.70	0.68	11.90	1.18	37.00	2.37
3.90	0.69	12.10	1.14	38.00	2.40
4.10	0.71	12.40	1.19	39.00	2.57
4.30	0.73	13.00	1.34	40.00	2.36
4.50	0.75	13.50	1.33		
4.70	0.77	14.00	1.48		
4.90	0.79	14.50	1.45		

**Cable loss**  
Cable coaxial, 40GHz, 1.5 m, green, Rhophase Microwave Limited, model: KPS-1503A-1500-KPS,  
HL 2400

Frequency, GHz	Cable loss, dB	Frequency, GHz	Cable loss, dB	Frequency, GHz	Cable loss, dB
0.03	0.06	6.5	1.46	15.50	2.34
0.05	0.08	6.7	1.49	16.00	2.34
0.1	0.15	6.9	1.50	16.50	2.40
0.2	0.23	7.1	1.51	17.00	2.46
0.3	0.29	7.3	1.55	17.50	2.54
0.5	0.37	7.5	1.56	18.00	2.61
0.7	0.46	7.7	1.58	18.50	2.59
0.9	0.53	7.9	1.60	19.00	2.59
1.1	0.58	8.1	1.61	19.50	2.67
1.3	0.65	8.3	1.68	20.00	2.62
1.5	0.66	8.5	1.68	20.50	2.73
1.7	0.72	8.7	1.75	21.00	2.71
1.9	0.76	8.9	1.74	21.50	2.78
2.1	0.79	9.1	1.81	22.00	2.83
2.3	0.85	9.3	1.79	22.50	2.81
2.5	0.90	9.5	1.86	23.50	2.91
2.7	0.91	9.7	1.85	24.00	2.97
2.9	0.97	9.9	1.87	24.50	2.98
3.1	0.97	10.1	1.88	25.00	2.97
3.3	1.03	10.30	1.82	25.50	3.03
3.5	1.06	10.50	1.92	26.00	3.04
3.7	1.10	10.70	1.86	26.50	3.11
3.9	1.13	10.90	1.96	27.00	2.97
4.1	1.16	11.10	1.90	28.00	3.15
4.3	1.18	11.30	1.99	29.00	3.07
4.5	1.21	11.50	1.95	30.00	3.13
4.7	1.23	11.70	2.00	31.00	3.13
4.9	1.26	11.90	2.01	32.00	3.18
5.1	1.28	12.10	1.99	33.00	3.31
5.3	1.31	12.40	2.06	34.00	3.32
5.5	1.32	13.00	2.11	35.00	3.37
5.7	1.36	13.50	2.17	36.00	3.36
5.9	1.37	14.00	2.36	37.00	3.46
6.1	1.38	14.50	2.32	39.00	3.49
6.3	1.44	15.00	2.30	40.00	3.52