



A D T

FCC TEST REPORT

(Part 90 Subpart Z)

REPORT NO.: RF980630L08F

MODEL NO.: V72-370I

RECEIVED: Jun. 30, 2009

TESTED: May 13, 2010

ISSUED: May 18, 2010

APPLICANT: Airspan Networks Inc

ADDRESS: 777 Yamato Rd Suite 310, Boca Raton, Florida,
United States, 33431

ISSUED BY: Bureau Veritas Consumer Products Services
(H.K.) Ltd., Taoyuan Branch

LAB ADDRESS: No. 47, 14th Ling, Chia Pau Tsuen, Lin Kou
Hsiang, Taipei Hsien 244, Taiwan, R.O.C.

TEST LOCATION: No. 19, Hwa Ya 2nd Rd, Wen Hwa Tsuen, Kwei
Shan Hsiang, Taoyuan Hsien 333, Taiwan, R.O.C.

This test report consists of 138 pages in total. It may be duplicated completely for legal use with the approval of the applicant. It should not be reproduced except in full, without the written approval of our laboratory. The client should not use it to claim product endorsement by any government agencies. The test results in the report only apply to the tested sample.



TABLE OF CONTENTS

1	CERTIFICATION.....	4
2	SUMMARY OF TEST RESULTS	5
2.1	MEASUREMENT UNCERTAINTY.....	5
3	GENERAL INFORMATION.....	6
3.1	GENERAL DESCRIPTION OF EUT	6
3.2	DESCRIPTION OF TEST MODES	8
3.2.1	CONFIGURATION OF SYSTEM UNDER TEST	9
3.2.2	TEST MODE APPLICABILITY AND TESTED CHANNEL DETAIL	10
3.3	GENERAL DESCRIPTION OF APPLIED STANDARDS	13
3.4	DESCRIPTION OF SUPPORT UNITS	13
4	TEST TYPES AND RESULTS	14
4.1	OUTPUT POWER AND POWER DENSITY MEASUREMENT	14
4.1.1	LIMITS OF OUTPUT POWER AND POWER DENSITY	14
4.1.2	TEST INSTRUMENTS.....	14
4.1.3	TEST PROCEDURES	15
4.1.4	TEST SETUP.....	16
4.1.5	EUT OPERATING CONDITIONS	16
4.1.6	TEST RESULTS	17
4.2	FREQUENCY STABILITY MEASUREMENT.....	37
4.2.1	LIMITS OF FREQUENCY STABILITY MEASUREMENT	37
4.2.2	TEST INSTRUMENTS.....	37
4.2.3	TEST PROCEDURE.....	38
4.2.4	TEST SETUP.....	38
4.2.5	EUT OPERATING CONDITIONS	38
4.2.6	TEST RESULTS	39
4.3	EMISSION BANDWIDTH MEASUREMENT	43
4.3.1	LIMITS OF EMISSION BANDWIDTH MEASUREMENT	43
4.3.2	TEST INSTRUMENTS.....	43
4.3.3	TEST PROCEDURE.....	43
4.3.4	TEST SETUP.....	43
4.3.5	EUT OPERATING CONDITIONS	43
4.3.6	TEST RESULTS	44
4.4	EMISSION MASKS.....	60
4.4.1	LIMITS OF EMISSION MASKS	60
4.4.2	TEST INSTRUMENTS.....	60
4.4.3	TEST SETUP.....	60
4.4.4	TEST PROCEDURES	61
4.4.5	EUT OPERATING CONDITION.....	61
4.4.6	TEST RESULTS	62
4.5	CONDUCTED SPURIOUS EMISSIONS	74
4.5.1	LIMITS OF CONDUCTED SPURIOUS EMISSIONS MEASUREMENT.....	74
4.5.2	TEST INSTRUMENTS.....	74
4.5.3	TEST PROCEDURE.....	75
4.5.4	TEST SETUP.....	75
4.5.5	EUT OPERATING CONDITIONS	75
4.5.6	TEST RESULTS	76
4.6	RADIATED EMISSION MEASUREMENT (BELOW 1GHz).....	112
4.6.1	LIMITS OF RADIATED EMISSION MEASUREMENT.....	112
4.6.2	TEST INSTRUMENTS.....	113
4.6.3	TEST PROCEDURES	114



A D T

4.6.4	DEVIATION FROM TEST STANDARD	114
4.6.5	TEST SETUP	115
4.6.6	EUT OPERATING CONDITIONS	115
4.6.7	TEST RESULTS	116
4.7	RADIATED EMISSION MEASUREMENT (ABOVE 1GHz)	124
4.7.1	LIMITS OF RADIATED EMISSION MEASUREMENT	124
4.7.2	TEST INSTRUMENTS	124
4.7.3	TEST PROCEDURES	124
4.7.4	DEVIATION FROM TEST STANDARD	124
4.7.5	TEST SETUP	124
4.7.6	EUT OPERATING CONDITIONS	124
4.7.7	TEST RESULTS	125
5	PHOTOGRAPHS OF THE TEST CONFIGURATION	137
6	INFORMATION ON THE TESTING LABORATORIES	138



A D T

1 CERTIFICATION

PRODUCT: MIMAX Pro ODU

MODEL: V72-370I

BRAND: Airspan

APPLICANT: Airspan Networks Inc

TESTED: May 13, 2010

TEST SAMPLE: ENGINEERING SAMPLE

TEST STANDARDS: FCC Part 90, Subpart Z

The above equipment (Model No.: V72-370I) has been tested by **Bureau Veritas Consumer Products Services (H.K.) Ltd., Taoyuan Branch**, and found compliance with the requirement of the above standards. The test record, data evaluation & Equipment Under Test (EUT) configurations represented herein are true and accurate accounts of the measurements of the sample's EMC characteristics under the conditions specified in this report.

PREPARED BY : Pettie Chen , **DATE:** May 18, 2010
Pettie Chen / Specialist

TECHNICAL ACCEPTANCE : Long Chen , **DATE:** May 18, 2010
Responsible for RF Long Chen / Senior Engineer

APPROVED BY : Gary Chang , **DATE:** May 18, 2010
Gary Chang / Assistant Manager



A D T

2 SUMMARY OF TEST RESULTS

The EUT has been tested according to the following specifications:

STANDARD SECTION	TEST TYPE AND LIMIT	RESULT	REMARK
FCC Part 2& Part 90			
2.1046 90.1321	Maximum Peak Output Power Limit: max. 25Watt / 25MHz EIRP.	PASS	Meet the requirement of limit.
2.1055 90.213	Frequency Stability Stay with the authorized bands of operation	PASS	Meet the requirement of limit.
2.1049 90.1323	Emission Bandwidth	PASS	Meet the requirement of limit.
90.210	Emission masks	PASS	Meet the requirement of limit.
2.1051 90.1323	Conducted Spurious Emissions	PASS	Meet the requirement of limit.
2.1053 90.1323	Radiated Spurious Emissions	PASS	Meet the requirement of limit. Minimum passing margin is -10.80dB at 7345.0MHz.

2.1 MEASUREMENT UNCERTAINTY

Where relevant, the following measurement uncertainty levels have been estimated for tests performed on the EUT as specified in CISPR 16-4-2:

MEASUREMENT	FREQUENCY	UNCERTAINTY
Conducted emissions	150kHz~30MHz	2.44 dB
Radiated emissions	30MHz ~ 200MHz	3.19 dB
	200MHz ~1000MHz	3.21 dB
	1GHz ~ 18GHz	2.26 dB
	18GHz ~ 40GHz	1.94 dB

This uncertainty represents an expanded uncertainty expressed at approximately the 95% confidence level using a coverage factor of $k = 2$.



3 GENERAL INFORMATION

3.1 GENERAL DESCRIPTION OF EUT

PRODUCT	MIMAX Pro ODU
MODEL NO.	V72-370I
FCC ID	PIDMIMAX365
POWER SUPPLY	48Vdc from PoE
MODULATION TYPE	BPSK, QPSK, 16QAM, 64QAM (refer to NOTE for more details)
CODING RATE	1/2, 2/3, 3/4, 5/6 (refer to NOTE for more details)
MODULATION TECHNOLOGY	OFDMA
DUPLEX METHOD	TDD
MULTIPLE ACCESS METHOD	TDMA
OPERATING FREQUENCY	3651.75MHz ~ 3673.25MHz
CHANNEL BANDWIDTH	3.5MHz, 5MHz, 7MHz, 10MHz
MAX. E.I.R.P. POWER (AV)	38.03dBm
ANTENNA TYPE	Patched antenna with 15dBi gain
OPERATION TEMPERATURE RANGE	-40°C ~ 70°C
DATA CABLE	1.7m shielded RJ45 cable without core
I/O PORTS	RJ45
ACCESSORY DEVICES	PoE

NOTE:

1. This report is issued as a supplementary report of BV ADT report no.: RF980630L08E. The differences are changing the product name, model name, brand name, applicant, adding 3.5MHz bandwidth and adding a POE. Therefore, all tests had been re-tested.

2. The EUT was operated with following PoEs.

POE 1	
BRAND:	PowerDsine™ 3001
MODEL:	PD-3001/AC
INPUT:	100-250Vac, 50/60Hz, 0.5A
OUTPUT:	48Vdc, 0.35A
POWER LINE:	AC 1.8m non-shielded cable without core

POE 2	
BRAND:	PHIHONG
MODEL:	POE16U-480
INPUT:	100-240Vac, 50-60Hz, 0.4A
OUTPUT:	48Vdc, 0.32A

3. For the EUT with modulation type and coding rate. After pre-testing in test items of output power and spurious emissions, QPSK was found to be worst case and was selected for the final test configuration.

DOWN LINK		UP LINK	
MODULATION	CODING RATE	MODULATION	CODING RATE
QPSK	1/2	QPSK	1/2
	3/4		3/4
16QAM	1/2	16QAM	1/2
	3/4		3/4
64QAM	1/2	/	
	2/3		
	3/4		
	5/6		
BPSK	1/2		

4. EUT can supports different UL / DL ratio, max transmit ratio is up to 21 (UL): 26 (DL). After pretesting of output power and spurious emission, 21 (UL): 26 (DL) was found to be worst case and was selected for the final test configuration.

5. The above EUT information was declared by manufacturer and for more detailed features description please refers to the manufacturer's specifications or User's Manual.



3.2 DESCRIPTION OF TEST MODES

Three channels had been tested for each channel bandwidth.

CHANNEL BANDWIDTH: 3.5MHz	CHANNEL BANDWIDTH: 5MHz
Low channel (L): 3651.75MHz	Low channel (L): 3652.5MHz
Middle channel (M): 3662.5MHz	Middle channel (M): 3662.5MHz
High channel (H): 3673.25MHz	High channel (H): 3672.5MHz

CHANNEL BANDWIDTH: 7 MHz	CHANNEL BANDWIDTH: 10MHz
Low channel (L): 3653.5MHz	Low channel (L): 3655.0MHz
Middle channel (M): 3662.5MHz	Middle channel (M): 3662.5MHz
High channel (H): 3671.5MHz	High channel (H): 3670.0MHz

3.2.1 CONFIGURATION OF SYSTEM UNDER TEST

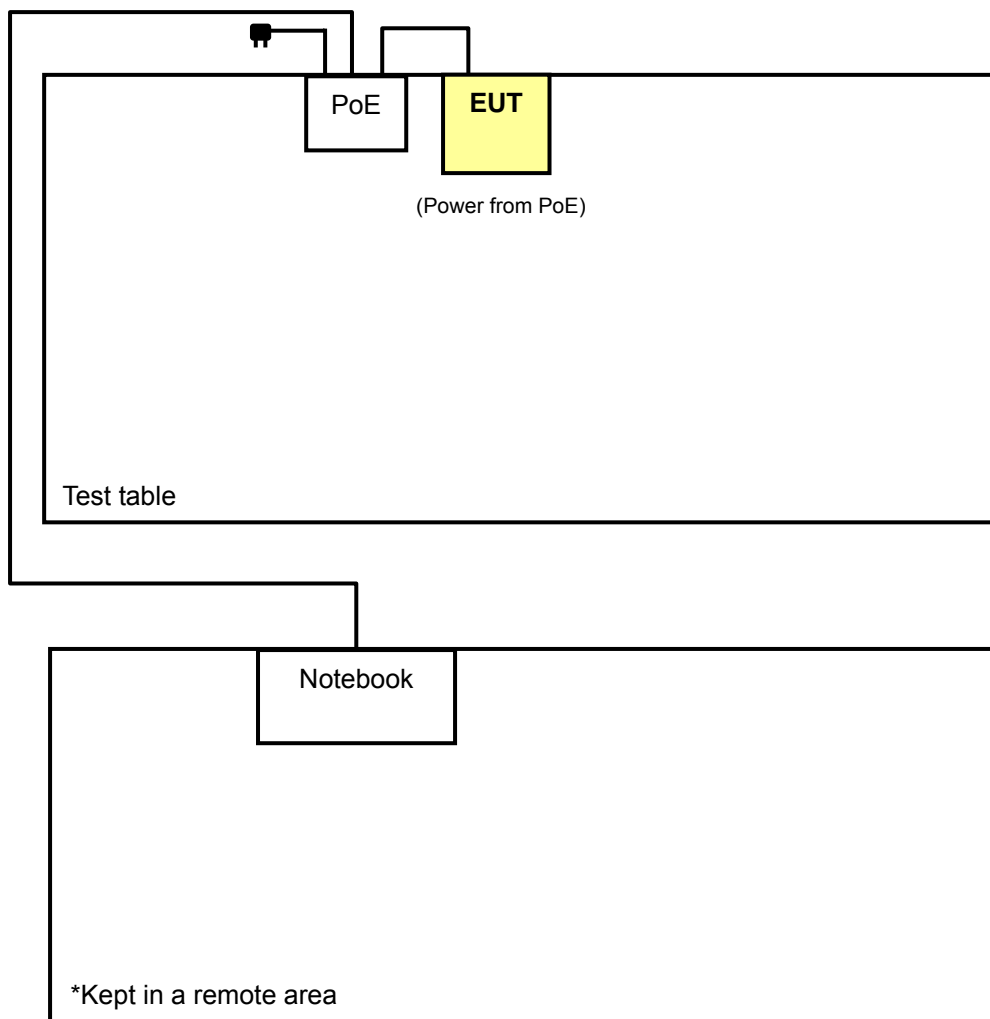



3.2.2 TEST MODE APPLICABILITY AND TESTED CHANNEL DETAIL

EUT CONFIGURE MODE	APPLICABLE TO							DESCRIPTION
	OP	FS	EB	EM	CSE	RE<1G	RE≥1G	
A	√	√	√	√	√	√	√	Power from POE 1
B	-	-	-	-	-	√	-	Power from POE 2

Where **OP**: Output power **FS**: Frequency stability
EB: Emission bandwidth **EM**: Emission masks
CSE: Conducted spurious emissions **RE<1G**: Radiated emission below 1GHz
RE≥1G: Radiated emission above 1GHz **NOTE**: "-": Means no effect.

OUTPUT POWER MEASUREMENT:

- Pre-Scan has been conducted to determine the worst-case mode from all possible combinations between available modulations, coding rate and antenna ports (if EUT with antenna diversity architecture).
- Following channel(s) was (were) selected for the final test as listed below.

EUT CONFIGURE MODE	TESTED CHANNEL	MODULATION TECHNOLOGY	CHANNEL BANDWIDTH	MODULATION TYPE	CODING RATE
A	L, M, H	OFDMA	3.5MHz	QPSK	1/2
A	L, M, H	OFDMA	5MHz	QPSK	1/2
A	L, M, H	OFDMA	7MHz	QPSK	1/2
A	L, M, H	OFDMA	10MHz	QPSK	1/2

FREQUENCY STABILITY MEASUREMENT:

- Pre-Scan has been conducted to determine the worst-case mode from all possible combinations between available modulations, coding rate, and antenna ports (if EUT with antenna diversity architecture).
- Following channel(s) was (were) selected for the final test as listed below.

EUT CONFIGURE MODE	TESTED CHANNEL	MODULATION TECHNOLOGY	CHANNEL BANDWIDTH	MODULATION TYPE	CODING RATE
A	L	OFDMA	3.5MHz	QPSK	1/2
A	L	OFDMA	5MHz	QPSK	1/2
A	L	OFDMA	7MHz	QPSK	1/2
A	L	OFDMA	10MHz	QPSK	1/2



A D T

EMISSION BANDWIDTH MEASUREMENT:

- Pre-Scan has been conducted to determine the worst-case mode from all possible combinations between available modulations, coding rate, and antenna ports (if EUT with antenna diversity architecture).
- Following channel(s) was (were) selected for the final test as listed below.

EUT CONFIGURE MODE	TESTED CHANNEL	MODULATION TECHNOLOGY	CHANNEL BANDWIDTH	MODULATION TYPE	CODING RATE
A	L, M, H	OFDMA	3.5MHz	QPSK	1/2
A	L, M, H	OFDMA	5MHz	QPSK	1/2
A	L, M, H	OFDMA	7MHz	QPSK	1/2
A	L, M, H	OFDMA	10MHz	QPSK	1/2

EMISSION MASKS MEASUREMENT:

- Pre-Scan has been conducted to determine the worst-case mode from all possible combinations between available modulations, coding rate, and antenna ports (if EUT with antenna diversity architecture).
- Following channel(s) was (were) selected for the final test as listed below.

EUT CONFIGURE MODE	TESTED CHANNEL	MODULATION TECHNOLOGY	CHANNEL BANDWIDTH	MODULATION TYPE	CODING RATE
A	L, M, H	OFDMA	3.5MHz	QPSK	1/2
A	L, M, H	OFDMA	5MHz	QPSK	1/2
A	L, M, H	OFDMA	7MHz	QPSK	1/2
A	L, M, H	OFDMA	10MHz	QPSK	1/2

CONDUCTED SPURIOUS EMISSIONS MEASUREMENT:

- Pre-Scan has been conducted to determine the worst-case mode from all possible combinations between available modulations, coding rate, and antenna ports (if EUT with antenna diversity architecture).
- Following channel(s) was (were) selected for the final test as listed below.

EUT CONFIGURE MODE	TESTED CHANNEL	MODULATION TECHNOLOGY	CHANNEL BANDWIDTH	MODULATION TYPE	CODING RATE
A	L, M, H	OFDMA	3.5MHz	QPSK	1/2
A	L, M, H	OFDMA	5MHz	QPSK	1/2
A	L, M, H	OFDMA	7MHz	QPSK	1/2
A	L, M, H	OFDMA	10MHz	QPSK	1/2



RADIATED EMISSION MEASUREMENT (BELOW 1 GHz):

- Pre-Scan has been conducted to determine the worst-case mode from all possible combinations between available modulations, coding rate and antenna ports (if EUT with antenna diversity architecture).
- Following channel(s) was (were) selected for the final test as listed below.

EUT CONFIGURE MODE	TESTED CHANNEL	MODULATION TECHNOLOGY	CHANNEL BANDWIDTH	MODULATION TYPE	CODING RATE
A, B	L	OFDMA	3.5MHz	QPSK	1/2
A, B	L	OFDMA	5MHz	QPSK	1/2
A, B	H	OFDMA	7MHz	QPSK	1/2
A, B	L	OFDMA	10MHz	QPSK	1/2

RADIATED EMISSION MEASUREMENT (ABOVE 1 GHz):

- Pre-Scan has been conducted to determine the worst-case mode from all possible combinations between available modulations, coding rate and antenna ports (if EUT with antenna diversity architecture).
- Following channel(s) was (were) selected for the final test as listed below.

EUT CONFIGURE MODE	TESTED CHANNEL	MODULATION TECHNOLOGY	CHANNEL BANDWIDTH	MODULATION TYPE	CODING RATE
A	L, M, H	OFDMA	3.5MHz	QPSK	1/2
A	L, M, H	OFDMA	5MHz	QPSK	1/2
A	L, M, H	OFDMA	7MHz	QPSK	1/2
A	L, M, H	OFDMA	10MHz	QPSK	1/2

TEST CONDITION:

APPLICABLE TO	ENVIRONMENTAL CONDITIONS	INPUT POWER (SYSTEM)	TESTED BY
OP	25deg°C, 65%RH, 991hPa	120Vac, 60Hz	Mark Liao
FS	25deg°C, 65%RH, 991hPa	120Vac, 60Hz	Mark Liao
EB	25deg°C, 65%RH, 991hPa	120Vac, 60Hz	Mark Liao
EM	25deg°C, 65%RH, 991hPa	120Vac, 60Hz	Mark Liao
CSE	25deg°C, 65%RH, 991hPa	120Vac, 60Hz	Mark Liao
RE < 1G	25deg°C, 68%RH, 991hPa	120Vac, 60Hz	Sun Lin
RE ≥ 1G	25deg°C, 68%RH, 991hPa	120Vac, 60Hz	Sun Lin

3.3 GENERAL DESCRIPTION OF APPLIED STANDARDS

The EUT is a RF product. According to the specifications of the manufacturer, it must comply with the requirements of the following standards:

FCC 47 CFR Part 2

FCC 47 CFR Part 90

965270 D01 Pwr Meas Part 90 Z Equipment v01

ANSI/TIA/EIA-603-C-2004

All test items have been performed and recorded as per the above standards.

NOTE: The EUT is also considered as a kind of computer peripheral, because the connection to computer is necessary for typical use. It has been verified to comply with the requirements of FCC Part 15, Subpart B, Class B (DoC). The test report has been issued separately.

3.4 DESCRIPTION OF SUPPORT UNITS

The EUT has been tested as an independent unit together with other necessary accessories or support units. The following support units or accessories were used to form a representative test configuration during the tests.

NO.	PRODUCT	BRAND	MODEL NO.	SERIAL NO.	FCC ID
1	NOTEBOOK COMPUTER	DELL	PP05L	12130898320	E2K24CLNS

NO.	SIGNAL CABLE DESCRIPTION OF THE ABOVE SUPPORT UNITS
1	NA

NOTE: All power cords of the above support units are non shielded (1.8m).



4 TEST TYPES AND RESULTS

4.1 OUTPUT POWER AND POWER DENSITY MEASUREMENT

4.1.1 LIMITS OF OUTPUT POWER AND POWER DENSITY

PER FCC PART 90.1321

BASE AND FIXED STATIONS

Base and fixed stations are limited to 25 Watts/25 MHz equivalent isotropical radiated power (EIRP). In any event, the peak EIRP power density shall not exceed 1 Watt in any one-megahertz slice of spectrum.

MOBILE AND PORTABLE STATIONS

Mobile and portable stations are limited to 1 Watt/25 MHz EIRP. In any event, the peak EIRP density shall not exceed 40 milliWatts in any one-megahertz slice of spectrum.

4.1.2 TEST INSTRUMENTS

DESCRIPTION & MANUFACTURER	MODEL NO.	SERIAL NO.	DATE OF CALIBRATION	DUE DATE OF CALIBRATION
Spectrum Analyzer Agilent	E4446A	MY44360128	Feb. 23, 2010	Feb. 22, 2011
RF cable	SUCOFLEX 104	257029	Sep. 12, 2009	Sep. 11, 2010
DC-6GHz 20dB 50W Fixed attenuator Woken	MDC9331N-20	0724	May 15, 2009	May 14, 2010

NOTE: The calibration interval of the above test instruments is 12 months and the calibrations are traceable to NML/ROC and NIST/USA.



4.1.3 TEST PROCEDURES

OUTPUT POWER

1. Connect the DUT transmitter output to the spectrum analyzer via coaxial cable while ensuring proper impedance matching.
2. Tune the analyzer to the nominal center frequency of the emission bandwidth (EBW).
3. Set the span to twice the nominal EBW (span = 2 x EBW).
4. Set the resolution bandwidth (RBW) to approximately 1% of EBW.
5. Set the video bandwidth (VBW) to 3 x RBW.
6. Select the average power (RMS) display detector.
7. Set the number of measurement points to ≥ 1001 .
8. Use auto-coupled sweep time.
9. Perform measurement over an interval of time when the transmission is continuous and at its maximum power level.
10. Utilize trace averaging over 100 traces in the power averaging mode.
11. Use the Band/Channel Power function to determine the integrated power over the full EBW.
12. Record the band power level.
13. Adjust the recorded level by applying appropriate correction factors for the measurement set-up.
14. Determine the EIRP by adding the effective antenna gain to the adjusted power level.

POWER DENSITY

1. Connect the transmitter to the spectrum analyzer via coaxial cable while ensuring proper impedance matching.
2. Tune the analyzer to the nominal center frequency of the emission bandwidth (EBW).
3. Set the span to twice the nominal EBW (span = 2 x EBW).
4. Set the resolution bandwidth (RBW) to 1 MHz.
5. Set the video bandwidth (VBW) to 3MHz.
6. Select the average power (RMS) display detector.
7. Set the number of measurement points to ≥ 1001 .
8. Use auto-coupled sweep time.
9. Perform the measurement over an interval of time when the transmission is continuous and at its maximum power level.
10. Utilize trace averaging over 100 traces in the power averaging mode.
11. Find the maximum trace amplitude (peak search) and record.
12. Adjust the recorded level by applying appropriate correction factors for the measurement set-up.
13. Determine the EIRP by adding the effective antenna gain to the adjusted power level.

4.1.4 TEST SETUP

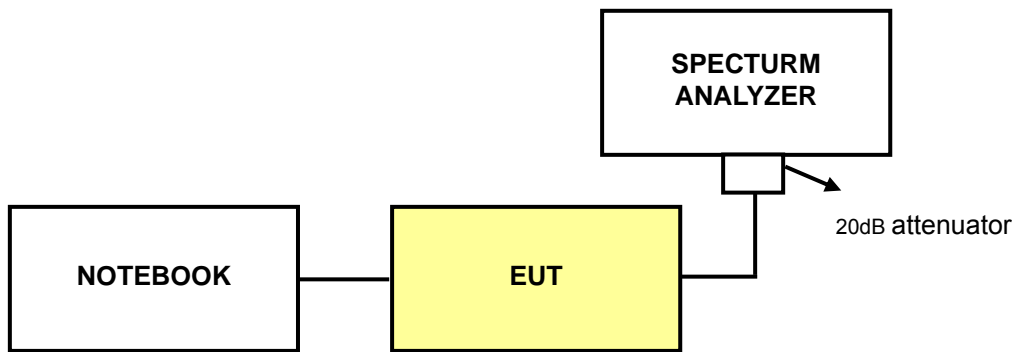

4.1.5 EUT OPERATING CONDITIONS

- Placed the EUT on the testing table.
- Prepared one notebook system outside of testing area to act as a communication partners.
- The communication partner connected with EUT via a RJ45 UTP cable and run a test program (provided by manufacturer) to enable EUT under transmission condition continuously at specific channel frequency.



A D T

4.1.6 TEST RESULTS

CHANNEL BANDWIDTH: 3.5MHz

EIRP POWER						
CHANNEL	FREQUENCY (MHz)	CONDUCTED POWER (dBm)	ANTENNA GAIN (dBi)	EIRP (dBm)	EIRP (W)	Limit (W)
Low	3651.75	18.64	15.00	33.64	2.312	3.50
Middle	3662.50	18.53	15.00	33.53	2.254	3.50
High	3673.25	18.63	15.00	33.63	2.307	3.50

NOTE: EIRP = Conducted power + Antenna Gain

EIRP PEAK DENSITY						
CHANNEL	FREQUENCY (MHz)	CONDUCTED POWER DENSITY (dBm/MHz)	ANTENNA GAIN (dBi)	EIRP PEAK DENSITY (dBm/MHz)	EIRP PEAK DENSITY (W/MHz)	Limit (W/MHz)
Low	3651.75	14.24	15.00	29.24	0.839	1.00
Middle	3662.50	14.33	15.00	29.33	0.857	1.00
High	3673.25	14.27	15.00	29.27	0.845	1.00

NOTE: EIRP density = Conducted power density + Antenna Gain



A D T

OUTPUT POWER

LOW CHANNEL

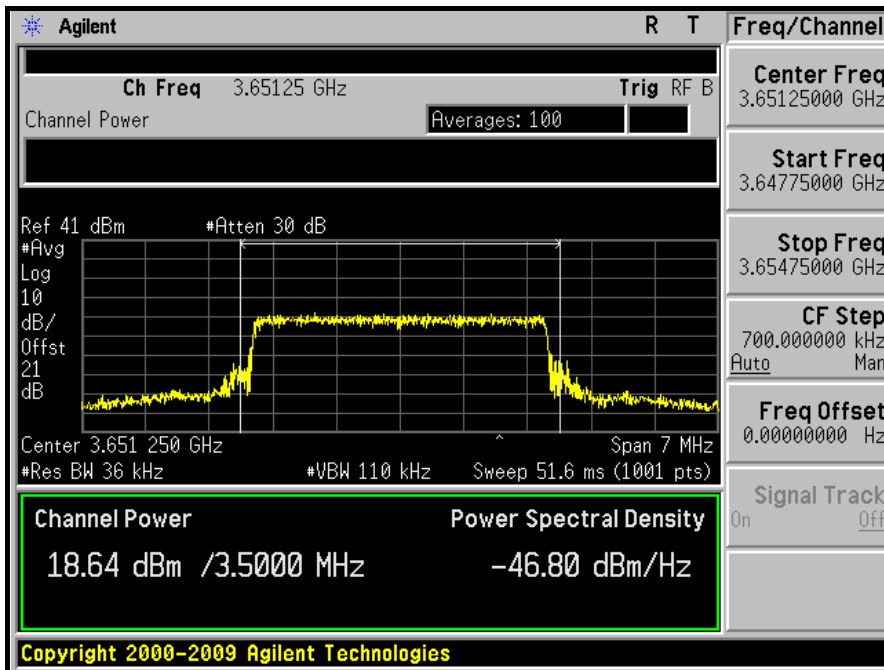

MIDDLE CHANNEL

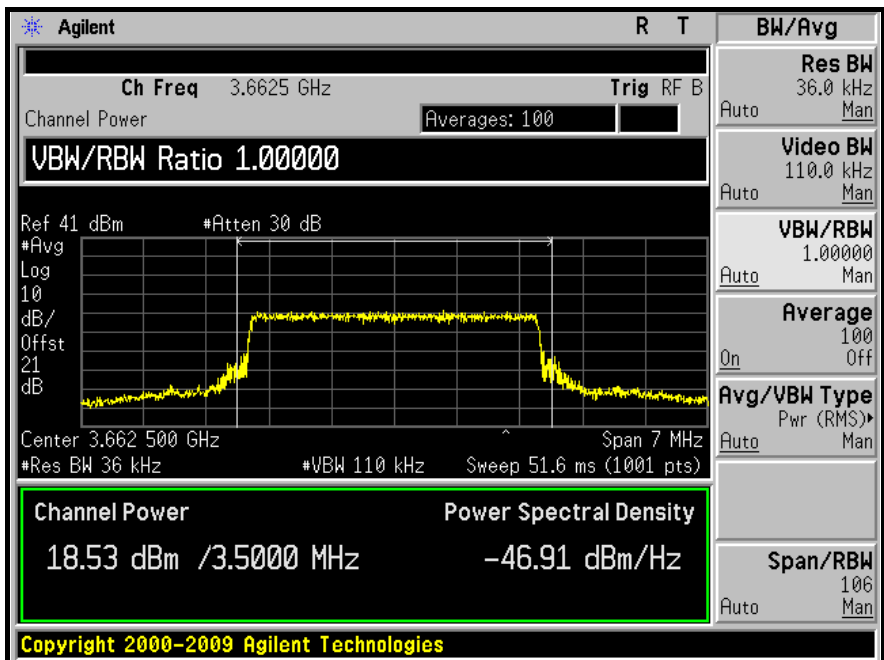



A D T

HIGH CHANNEL

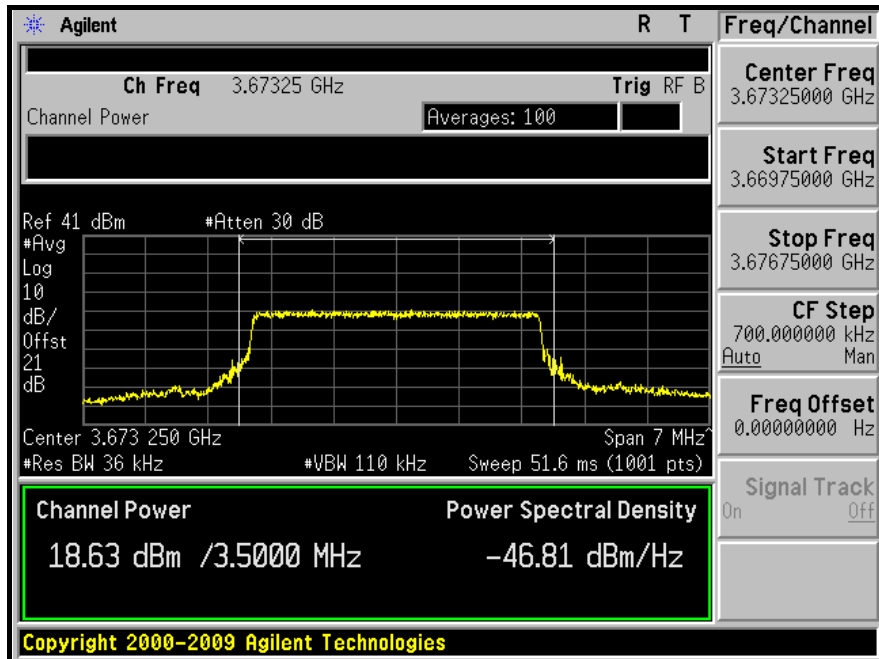



A D T

POWER DENSITY

LOW CHANNEL

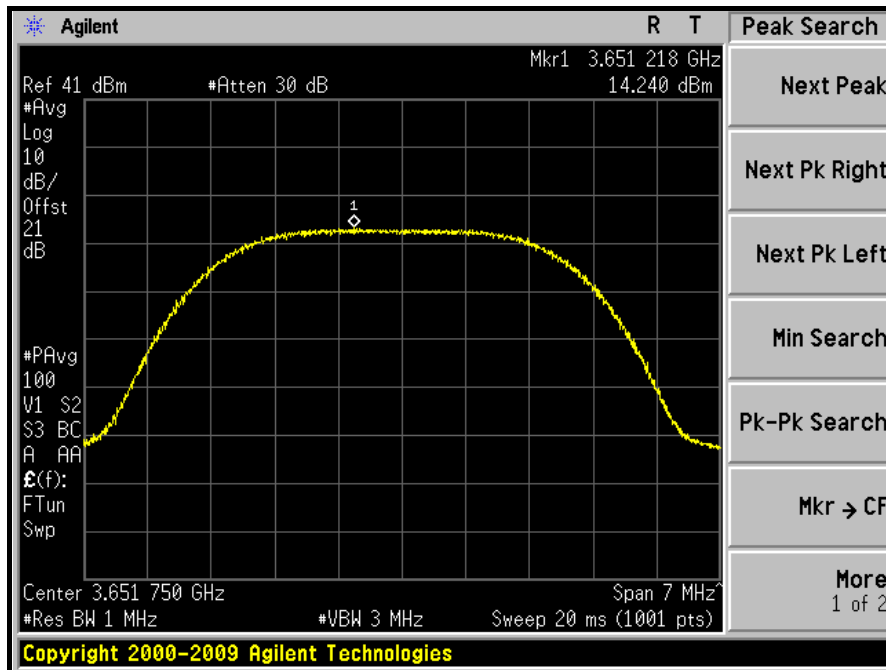

MIDDLE CHANNEL

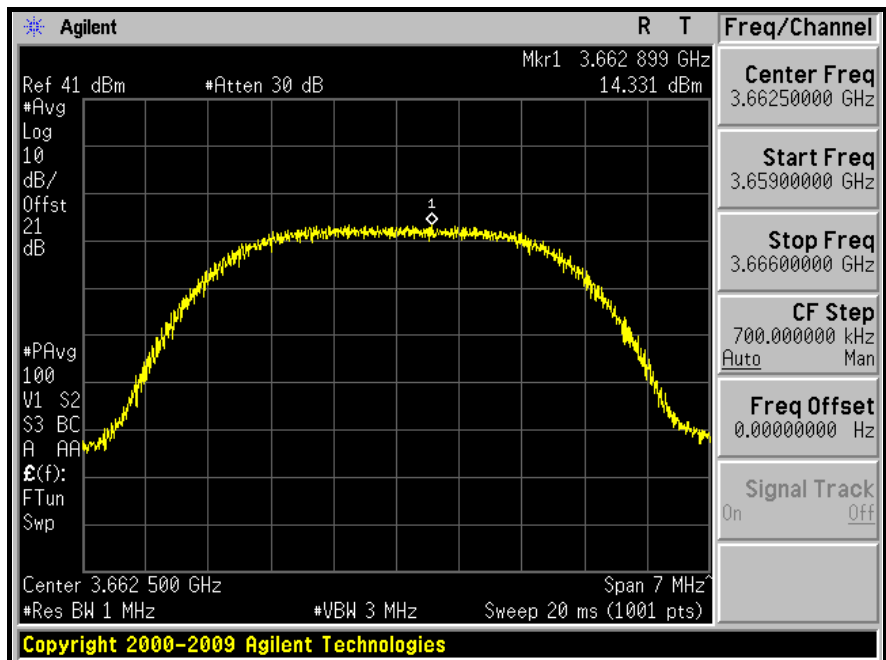



A D T

HIGH CHANNEL

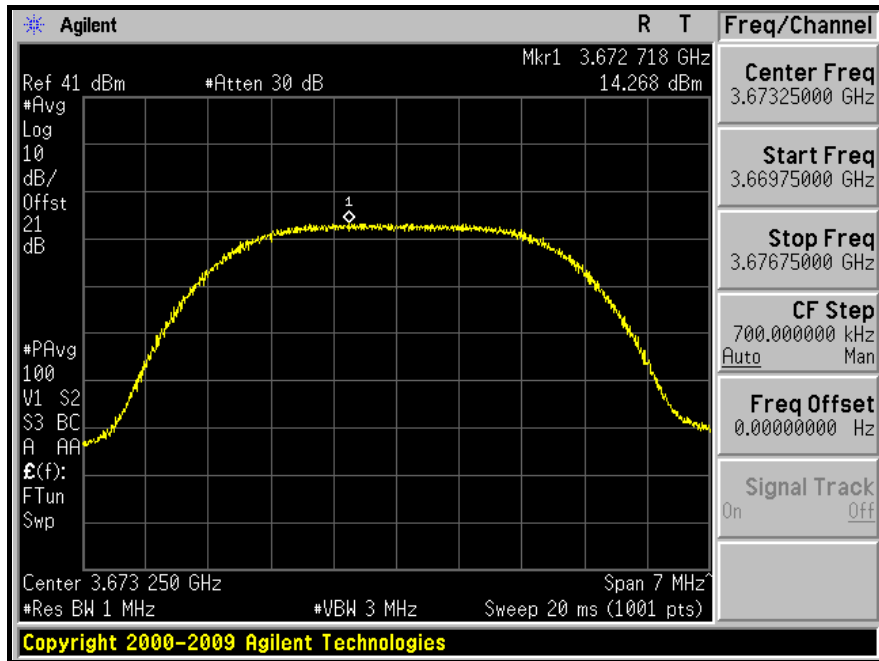



A D T

CHANNEL BANDWIDTH: 5.0MHz

EIRP POWER						
CHANNEL	FREQUENCY (MHz)	CONDUCTED POWER (dBm)	ANTENNA GAIN (dBi)	EIRP (dBm)	EIRP (W)	Limit (W)
Low	3652.50	20.46	15.00	35.46	3.516	5.00
Middle	3662.50	19.96	15.00	34.96	3.133	5.00
High	3672.50	19.59	15.00	34.59	2.877	5.00

NOTE: EIRP = Conducted power + Antenna Gain

EIRP PEAK DENSITY						
CHANNEL	FREQUENCY (MHz)	CONDUCTED POWER DENSITY (dBm/MHz)	ANTENNA GAIN (dBi)	EIRP PEAK DENSITY (dBm/MHz)	EIRP PEAK DENSITY (W/MHz)	Limit (W/MHz)
Low	3652.50	14.38	15.00	29.38	0.867	1.00
Middle	3662.50	14.64	15.00	29.64	0.920	1.00
High	3672.50	14.21	15.00	29.21	0.834	1.00

NOTE: EIRP density = Conducted power density + Antenna Gain



A D T

OUTPUT POWER

LOW CHANNEL

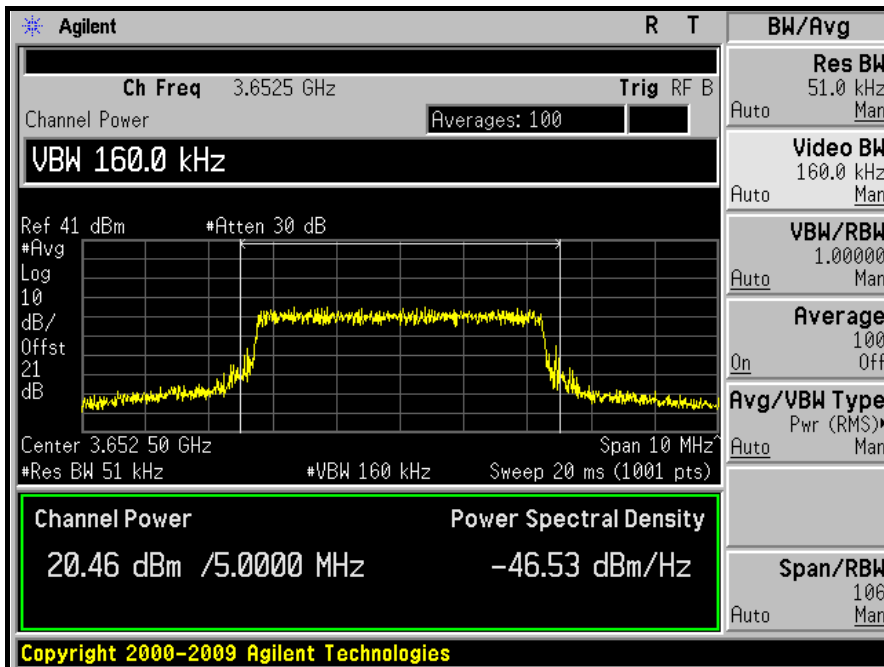

MIDDLE CHANNEL

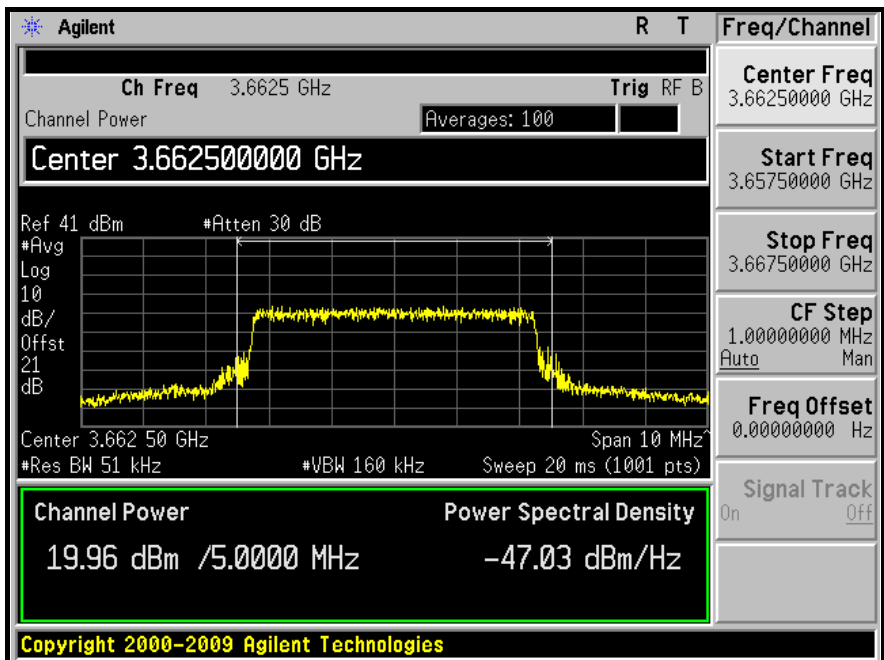



A D T

HIGH CHANNEL

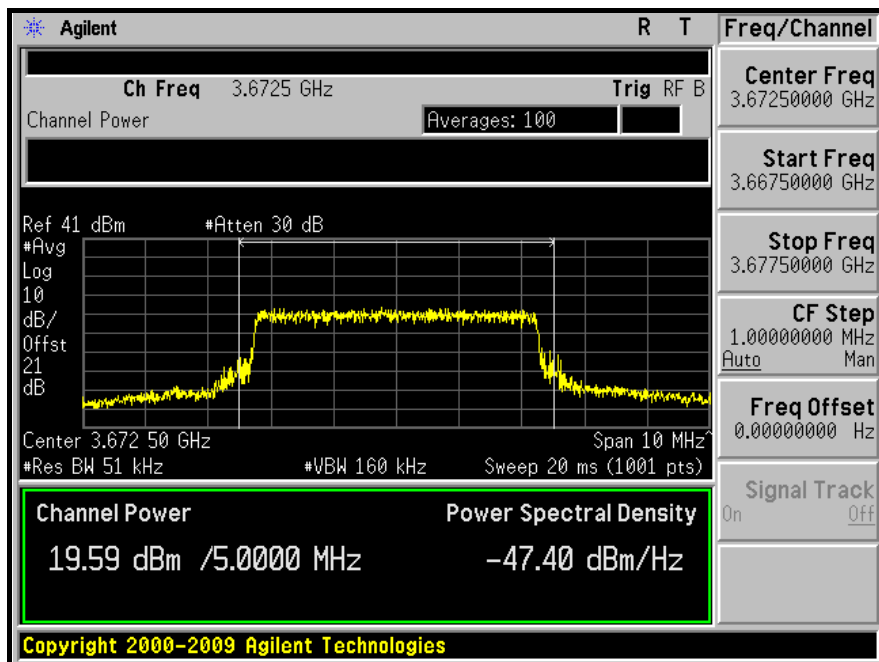



A D T

POWER DENSITY

LOW CHANNEL

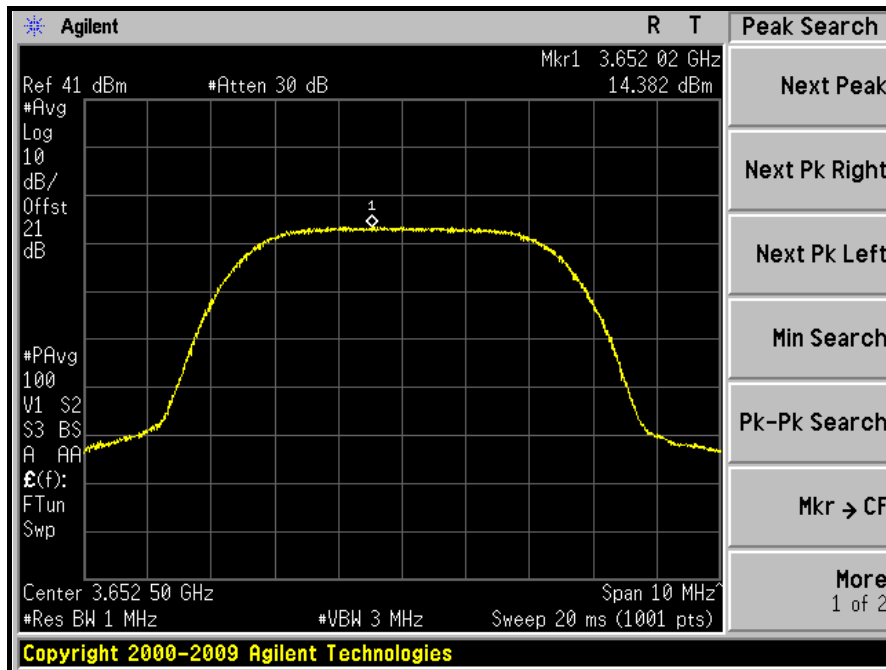

MIDDLE CHANNEL

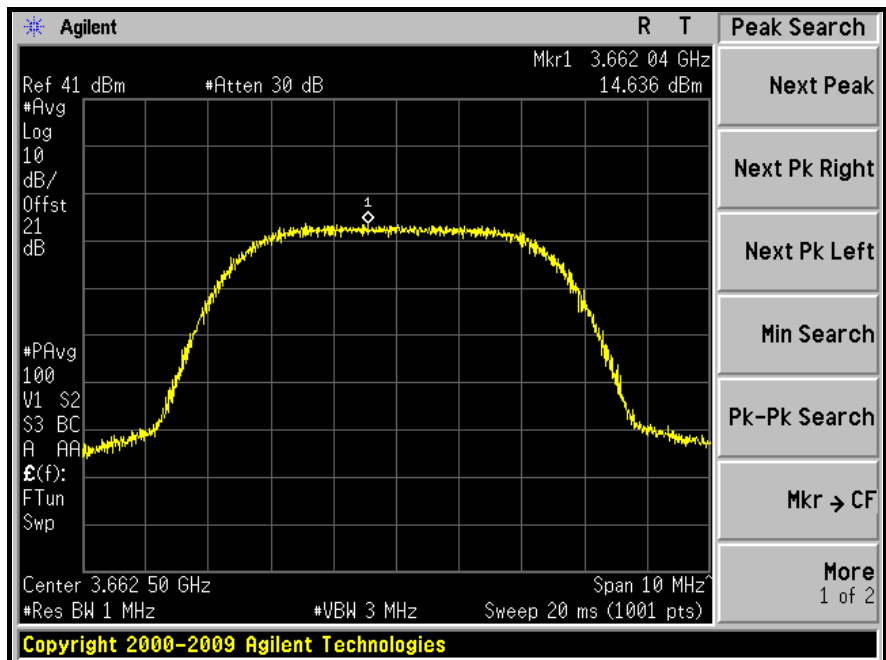



A D T

HIGH CHANNEL

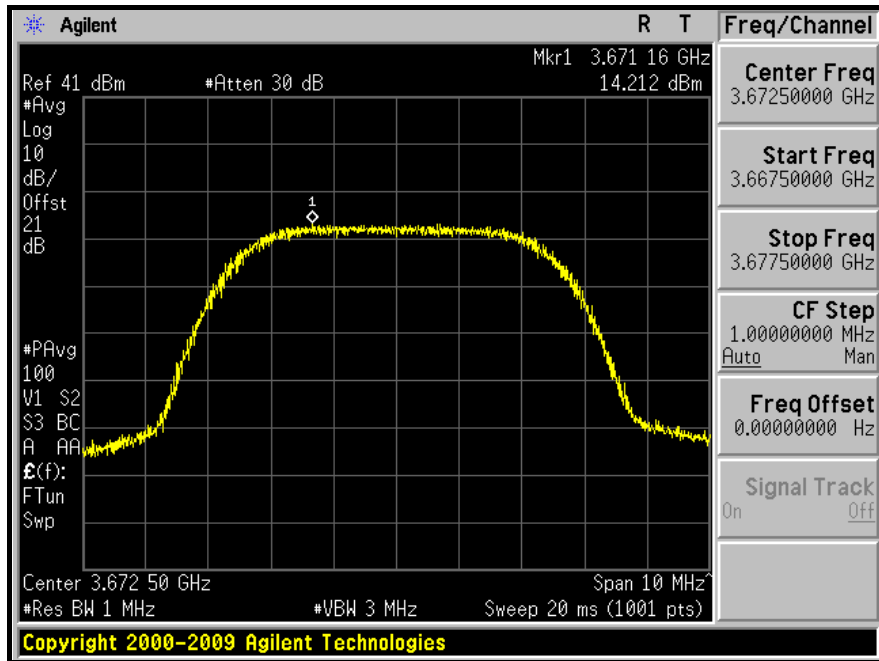



A D T

CHANNEL BANDWIDTH: 7.0MHz

EIRP POWER						
CHANNEL	FREQUENCY (MHz)	CONDUCTED POWER (dBm)	ANTENNA GAIN (dBi)	EIRP (dBm)	EIRP (W)	Limit (W)
Low	3653.5	20.59	15.00	35.59	3.622	7.00
Middle	3662.5	21.15	15.00	36.15	4.121	7.00
High	3671.5	20.83	15.00	35.83	3.828	7.00

NOTE: EIRP = Conducted power + Antenna Gain

EIRP PEAK DENSITY						
CHANNEL	FREQUENCY (MHz)	CONDUCTED POWER DENSITY (dBm/MHz)	ANTENNA GAIN (dBi)	EIRP PEAK DENSITY (dBm/MHz)	EIRP PEAK DENSITY (W/MHz)	Limit (W/MHz)
Low	3653.5	14.23	15.00	29.23	0.838	1.00
Middle	3662.5	14.43	15.00	29.43	0.877	1.00
High	3671.5	14.71	15.00	29.71	0.936	1.00

NOTE: EIRP density = Conducted power density + Antenna Gain



A D T

OUTPUT POWER

LOW CHANNEL

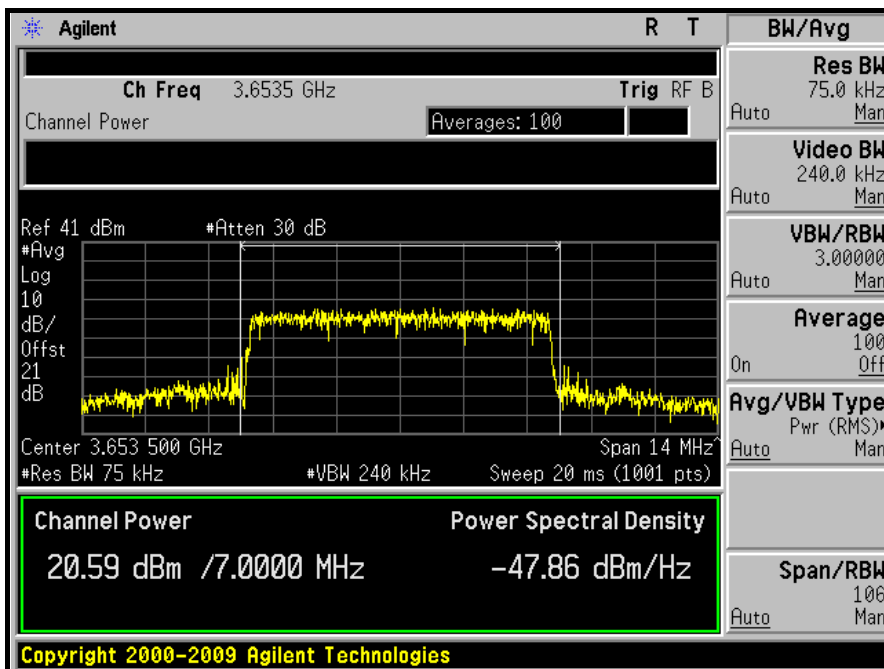

MIDDLE CHANNEL

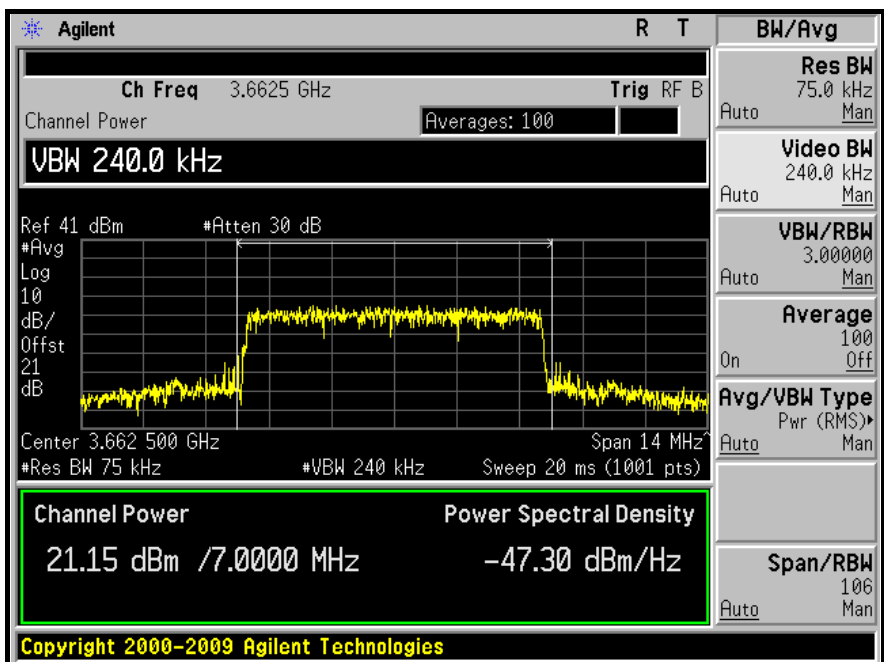



A D T

HIGH CHANNEL

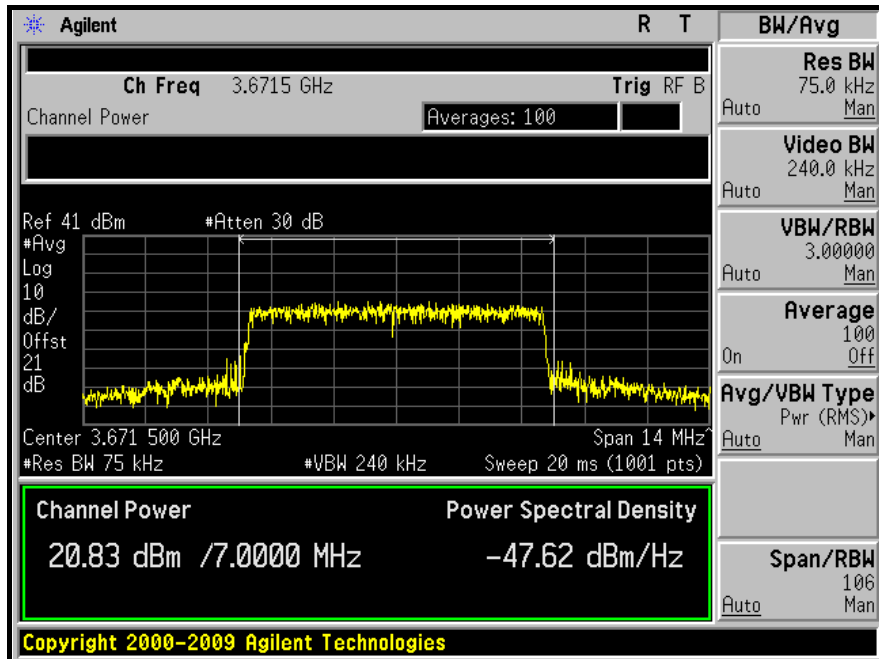



A D T

POWER DENSITY

LOW CHANNEL

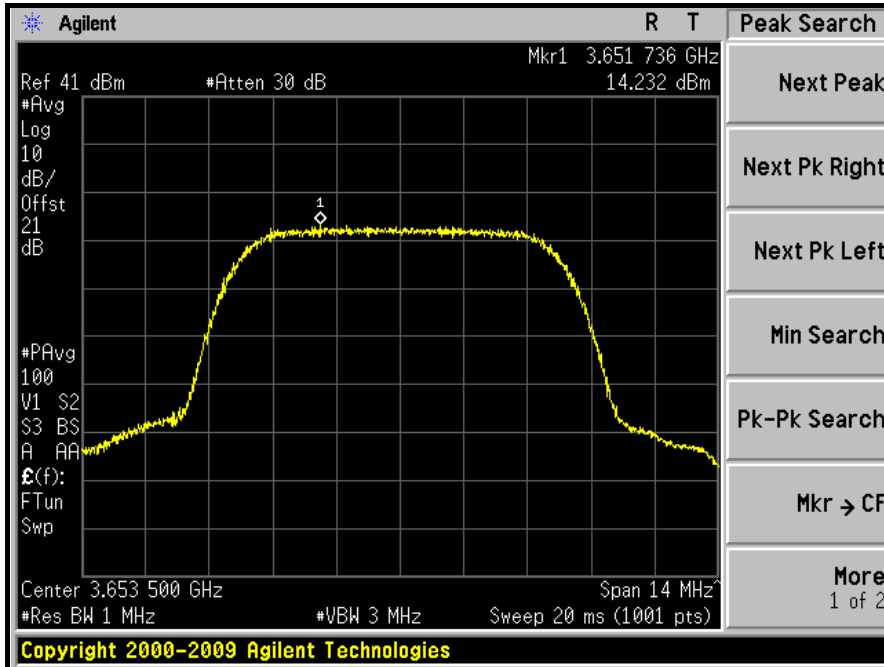

MIDDLE CHANNEL

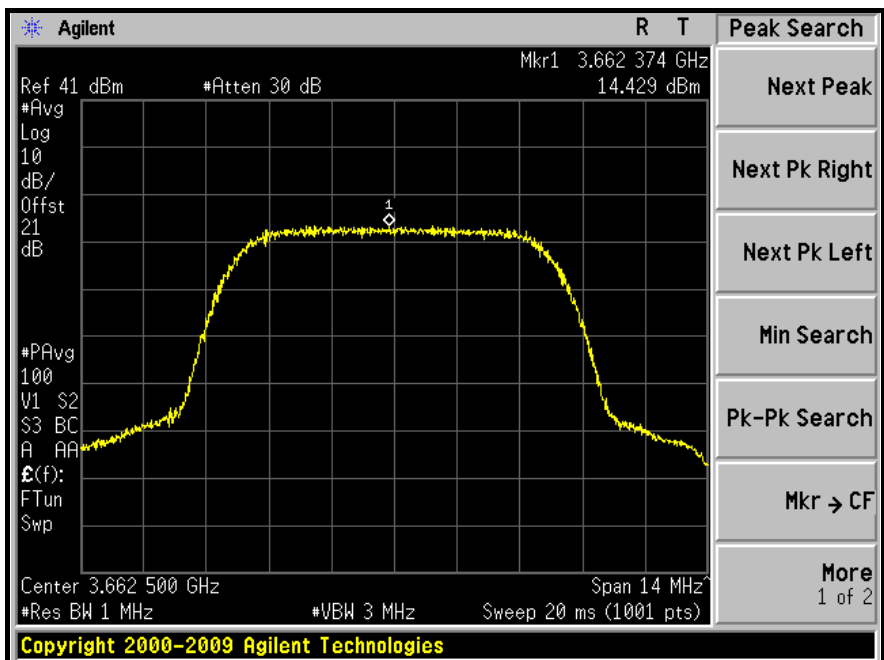



A D T

HIGH CHANNEL

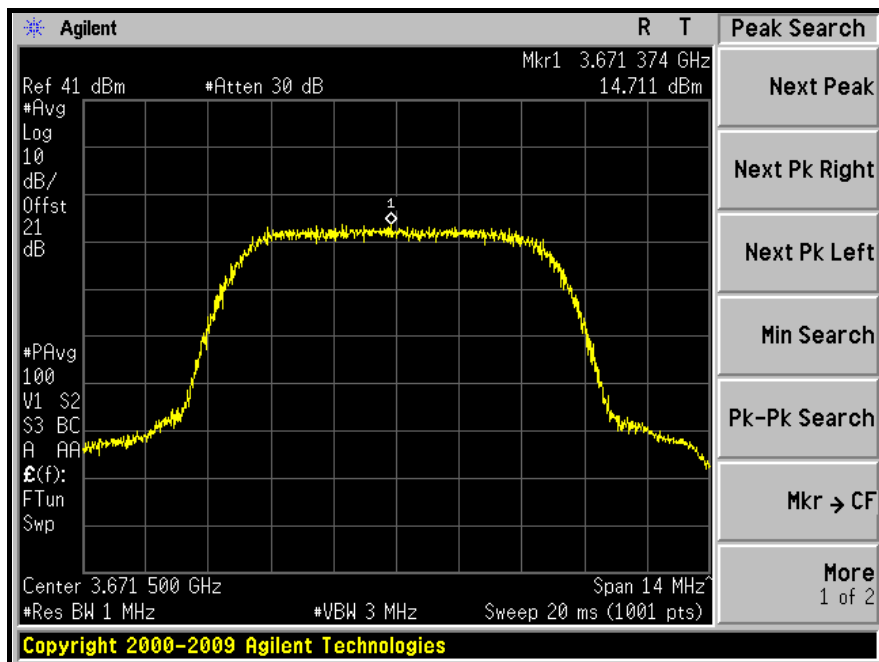



A D T

CHANNEL BANDWIDTH: 10.0MHz

EIRP POWER						
CHANNEL	FREQUENCY (MHz)	CONDUCTED POWER (dBm)	ANTENNA GAIN (dBi)	EIRP (dBm)	EIRP (W)	Limit (W)
Low	3655.00	23.03	15.00	38.03	6.353	10.00
Middle	3662.50	22.99	15.00	37.99	6.295	10.00
High	3670.00	23.00	15.00	38.00	6.310	10.00

NOTE: EIRP = Conducted power + Antenna Gain

EIRP PEAK DENSITY						
CHANNEL	FREQUENCY (MHz)	CONDUCTED POWER DENSITY (dBm/MHz)	ANTENNA GAIN (dBi)	EIRP PEAK DENSITY (dBm/MHz)	EIRP PEAK DENSITY (W/MHz)	Limit (W/MHz)
Low	3655.00	14.65	15.00	29.65	0.923	1.00
Middle	3662.50	14.55	15.00	29.55	0.901	1.00
High	3670.00	14.80	15.00	29.80	0.955	1.00

NOTE: EIRP density = Conducted power density + Antenna Gain



A D T

OUTPUT POWER

LOW CHANNEL

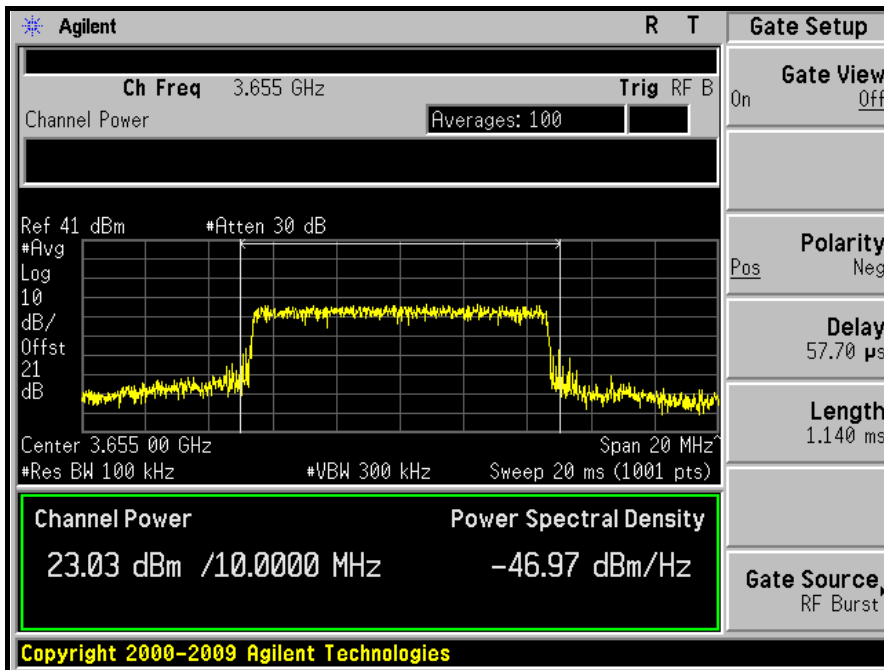

MIDDLE CHANNEL

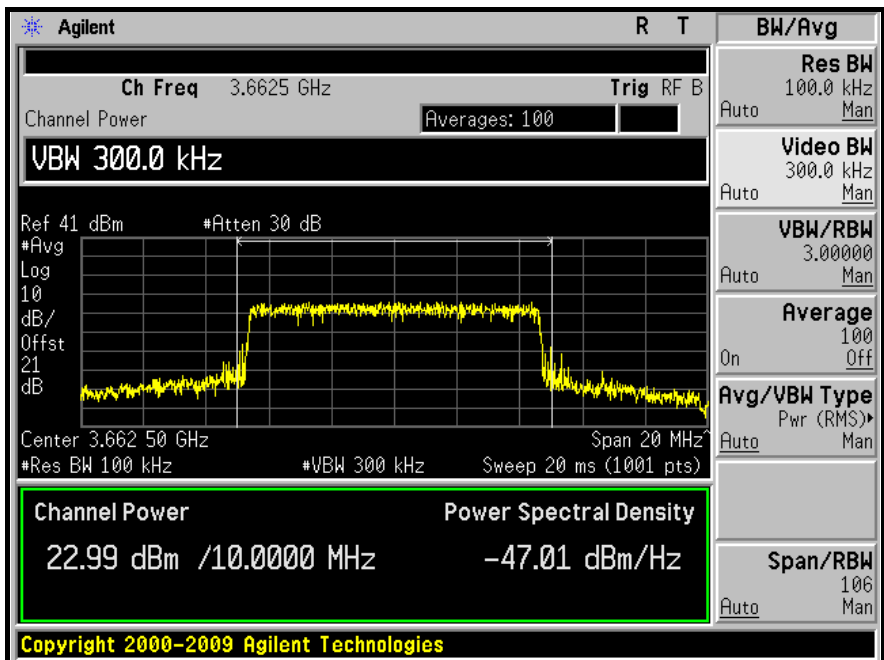



A D T

HIGH CHANNEL

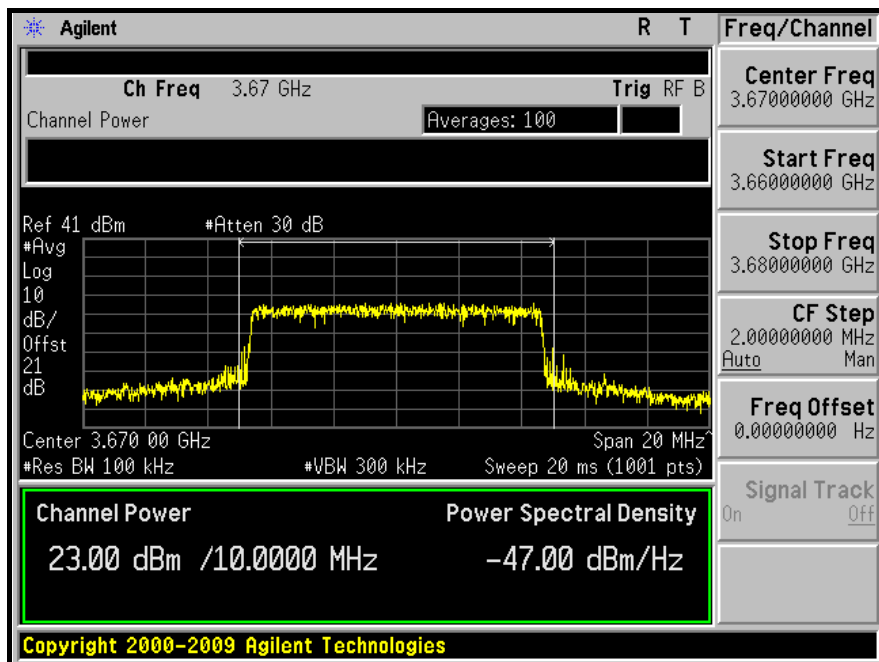



A D T

POWER DENSITY

LOW CHANNEL

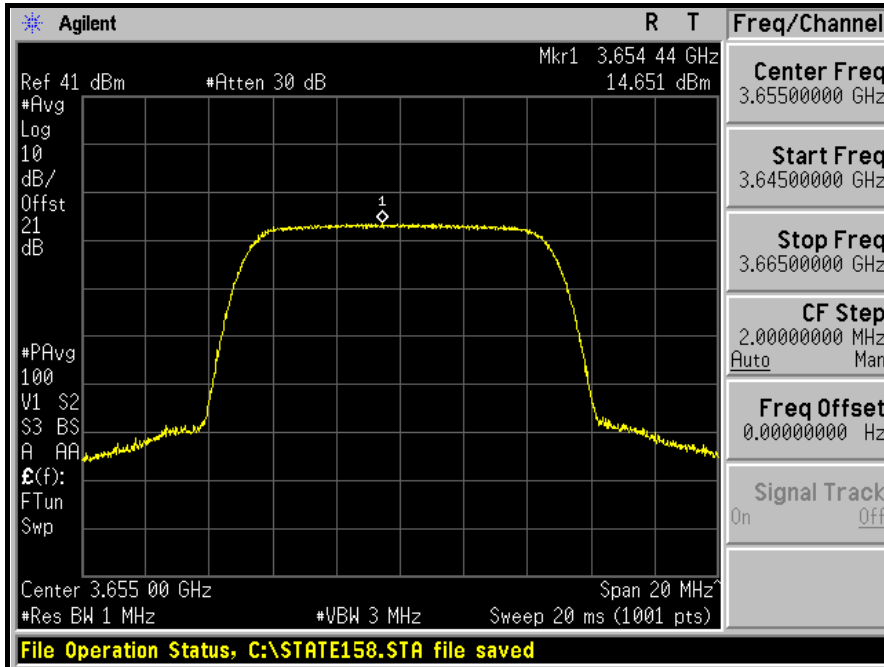

MIDDLE CHANNEL

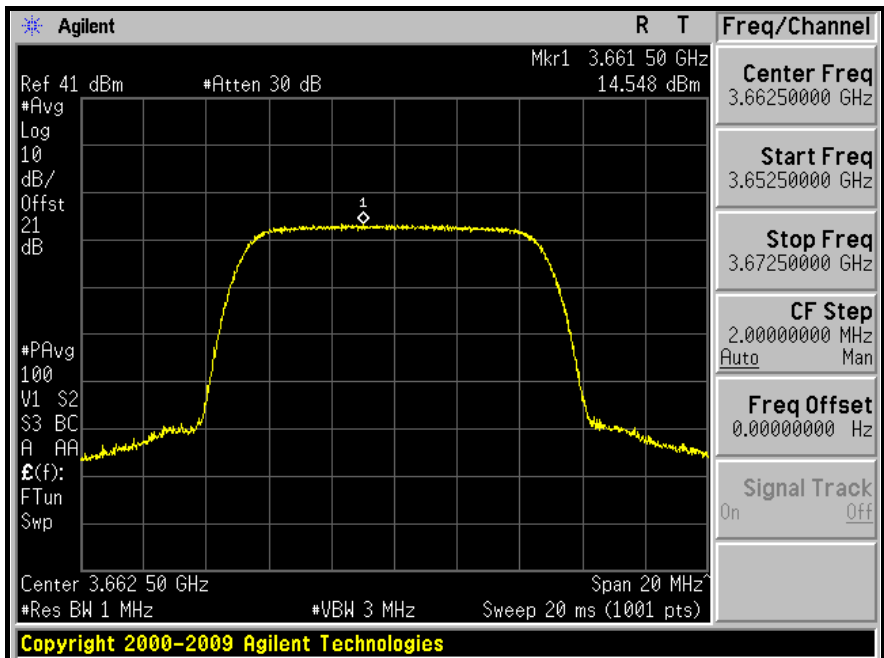



A D T

HIGH CHANNEL

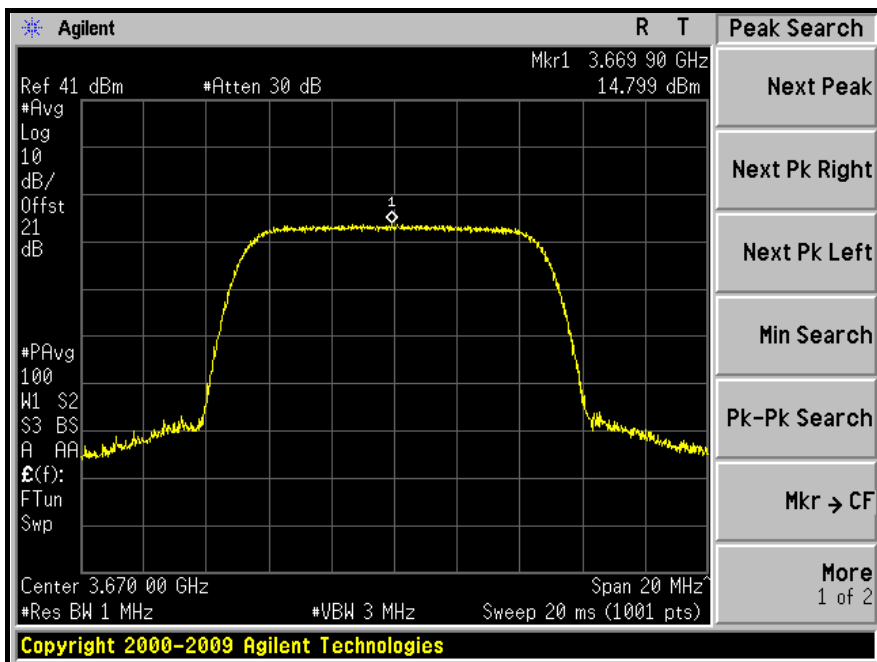

4.2 FREQUENCY STABILITY MEASUREMENT

4.2.1 LIMITS OF FREQUENCY STABILITY MEASUREMENT

According to the FCC part 2.1055 shall be tested the frequency stability. The rule is defined that "The frequency stability shall be sufficient to ensure that the fundamental emission stays within the authorized frequency block." The test extreme voltage is according to the 2.1055(d)(1) Vary primary supply voltage from 85 to 115 percent of the nominal value for other than hand carried battery equipment and the extreme temperature rule is comply with specification of EUT $-40^{\circ}\text{C} \sim 70^{\circ}\text{C}$.

4.2.2 TEST INSTRUMENTS

DESCRIPTION & MANUFACTURER	MODEL NO.	SERIAL NO.	DATE OF CALIBRATION	DUE DATE OF CALIBRATION
Spectrum Analyzer	E4446A	MY44360128	Feb. 23, 2010	Feb. 22, 2011
RF cable	SUCOFLEX 104	257029	Sep. 12, 2009	Sep. 11, 2010
WIT Standard Temperature & Humidity Chamber	TH-4S-C	W981030	Jun. 24, 2009	Jun. 23, 2010

NOTE: The calibration interval of the above test instruments is 12 months and the calibrations are traceable to NML/ROC and NIST/USA.

4.2.3 TEST PROCEDURE

- a. Power must be removed when changing from one temperature to another or one voltage to another voltage. Power warm up is at least 15 min and power applied should perform before recording frequency error.
- b. EUT is connected the external power supply to control the AC input power. The various Volts from the minimum 93.5 Volts to 126.5 Volts. Each step shall be record the frequency error rate.
- c. The temperature range step is 10 degrees in this test items. All temperature levels shall be hold the $\pm 0.5^{\circ}\text{C}$ during the measurement testing.
- d. The each temperature step shall be at least 0.5 hours, consider the EUT could be test under the stability condition.

4.2.4 TEST SETUP

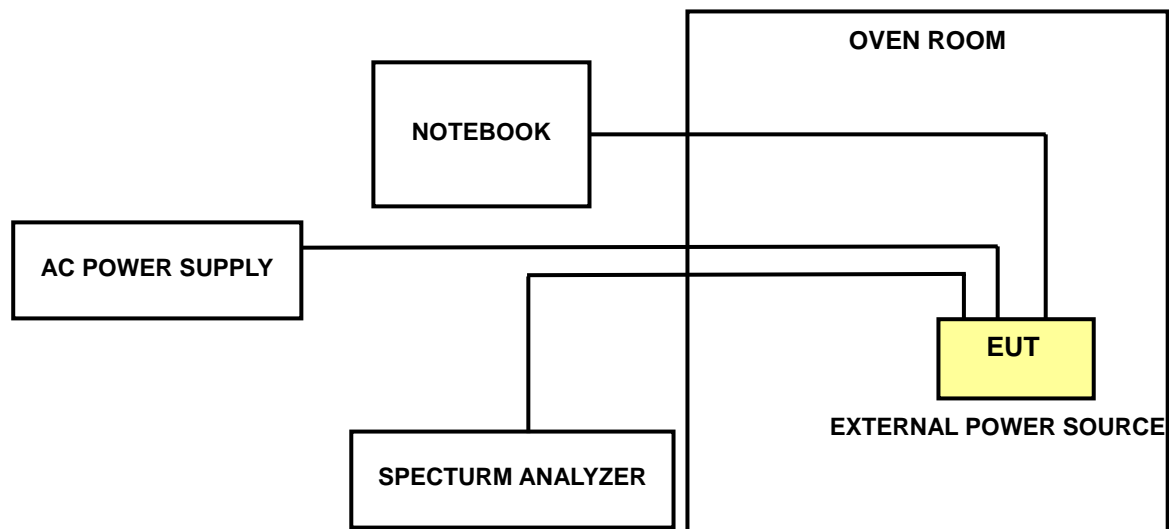

4.2.5 EUT OPERATING CONDITIONS

The EUT connected to the notebook. Use software to control the EUT channel and transmit a single tone.



A D T

4.2.6 TEST RESULTS

CHANNEL BANDWIDTH: 3.5MHz

AFC FREQUENCY ERROR VS. VOLTAGE		
VOLTAGE (Volts)	FREQUENCY (MHz)	FREQUENCY ERROR (ppm)
93.5	3651.752526	0.692
110.0	3651.752771	0.759
126.5	3651.752939	0.805

AFC FREQUENCY ERROR VS. TEMP.		
TEMP. (°C)	FREQUENCY (MHz)	FREQUENCY ERROR (ppm)
70	3651.752784	0.762
60	3651.752553	0.699
50	3651.752428	0.665
40	3651.752376	0.651
30	3651.752464	0.675
20	3651.752771	0.759
10	3651.752498	0.684
0	3651.752385	0.653
-10	3651.752534	0.694
-20	3651.752312	0.633
-30	3651.752244	0.614
-40	3651.752421	0.663



A D T

CHANNEL BANDWIDTH: 5MHz

AFC FREQUENCY ERROR VS. VOLTAGE		
VOLTAGE (Volts)	FREQUENCY (MHz)	FREQUENCY ERROR (ppm)
93.5	3652.502610	0.715
110.0	3652.502627	0.719
126.5	3652.502552	0.699

AFC FREQUENCY ERROR VS. TEMP.		
TEMP. (°C)	FREQUENCY (MHz)	FREQUENCY ERROR (ppm)
70	3652.502784	0.762
60	3652.502792	0.764
50	3652.503318	0.908
40	3652.501993	0.546
30	3652.502310	0.632
20	3652.502627	0.719
10	3652.502353	0.644
0	3652.501941	0.531
-10	3652.503144	0.861
-20	3652.502436	0.667
-30	3652.502028	0.555
-40	3652.502533	0.693



A D T

CHANNEL BANDWIDTH: 7MHz

AFC FREQUENCY ERROR VS. VOLTAGE		
VOLTAGE (Volts)	FREQUENCY (MHz)	FREQUENCY ERROR (ppm)
93.5	3653.502890	0.791
110.0	3653.503530	0.966
126.5	3653.502512	0.688

AFC FREQUENCY ERROR VS. TEMP.		
TEMP. (°C)	FREQUENCY (MHz)	FREQUENCY ERROR (ppm)
70	3653.503222	0.882
60	3653.502912	0.797
50	3653.502947	0.807
40	3653.502371	0.649
30	3653.502401	0.657
20	3653.503530	0.966
10	3653.501993	0.546
0	3653.502204	0.603
-10	3653.503776	1.034
-20	3653.502609	0.714
-30	3653.502185	0.598
-40	3653.502942	0.805



A D T

CHANNEL BANDWIDTH: 10MHz

AFC FREQUENCY ERROR VS. VOLTAGE		
VOLTAGE (Volts)	FREQUENCY (MHz)	FREQUENCY ERROR (ppm)
93.5	3655.003613	0.989
110.0	3655.003457	0.946
126.5	3655.002807	0.768

AFC FREQUENCY ERROR VS. TEMP.		
TEMP. (°C)	FREQUENCY (MHz)	FREQUENCY ERROR (ppm)
70	3655.002806	0.768
60	3655.003444	0.942
50	3655.002562	0.701
40	3655.002597	0.711
30	3655.003106	0.850
20	3655.003457	0.946
10	3655.002361	0.646
0	3655.002142	0.586
-10	3655.003497	0.957
-20	3655.002366	0.647
-30	3655.002820	0.772
-40	3655.002951	0.807

4.3 EMISSION BANDWIDTH MEASUREMENT

4.3.1 LIMITS OF EMISSION BANDWIDTH MEASUREMENT

According to FCC 90.1323 specified that emission bandwidth is defined as the width of the signal between two points, one below the carrier center frequency and one above the carrier center frequency, outside of which all emissions are attenuated at least 26dB below the transmitter power.

4.3.2 TEST INSTRUMENTS

DESCRIPTION & MANUFACTURER	MODEL NO.	SERIAL NO.	DATE OF CALIBRATION	DUE DATE OF CALIBRATION
Spectrum Analyzer Agilent	E4446A	MY44360128	Feb. 23, 2010	Feb. 22, 2011
RF cable	SUCOFLEX 104	257029	Sep. 12, 2009	Sep. 11, 2010
DC-6GHz 20dB 50W Fixed attenuator Woken	MDC9331N-20	0724	May 15, 2009	May 14, 2010

NOTE: The calibration interval of the above test instruments is 12 months and the calibrations are traceable to NML/ROC and NIST/USA.

4.3.3 TEST PROCEDURE

The transmitter output was connected to the spectrum analyzer through an attenuator. The bandwidth of the fundamental frequency was measured by spectrum analyzer with RBW = 36kHz (3.5MHz bandwidth), 51kHz (5MHz bandwidth), 75kHz (7MHz bandwidth), 100kHz (10MHz bandwidth), VBW = 110kHz (3.5MHz bandwidth), 160kHz (5MHz bandwidth), 240kHz (7MHz bandwidth), 300kHz (10MHz bandwidth). The emission bandwidth is defined as the width of the signal between two points, one below the carrier center frequency and one above the carrier center frequency, outside of which all emissions are attenuated at least 26 dB below the transmitter power.

4.3.4 TEST SETUP

Same as 4.1.4

4.3.5 EUT OPERATING CONDITIONS

Same as 4.1.5



A D T

4.3.6 TEST RESULTS

CHANNEL BANDWIDTH: 3.5MHz

CHANNEL	-26dBc BANDWIDTH (MHz)
Low	3.47
Middle	3.41
High	3.45



A D T

LOW CHANNEL

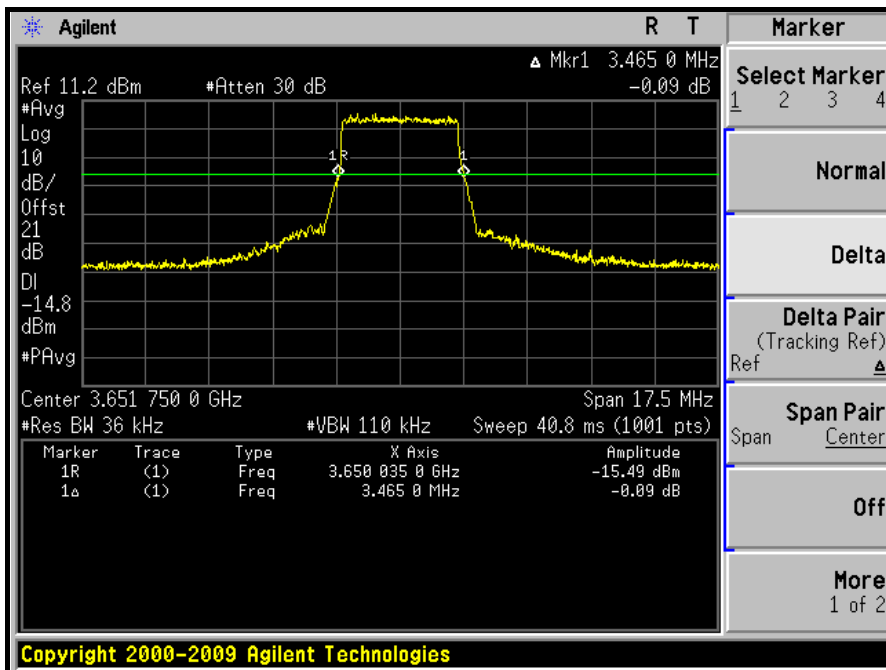
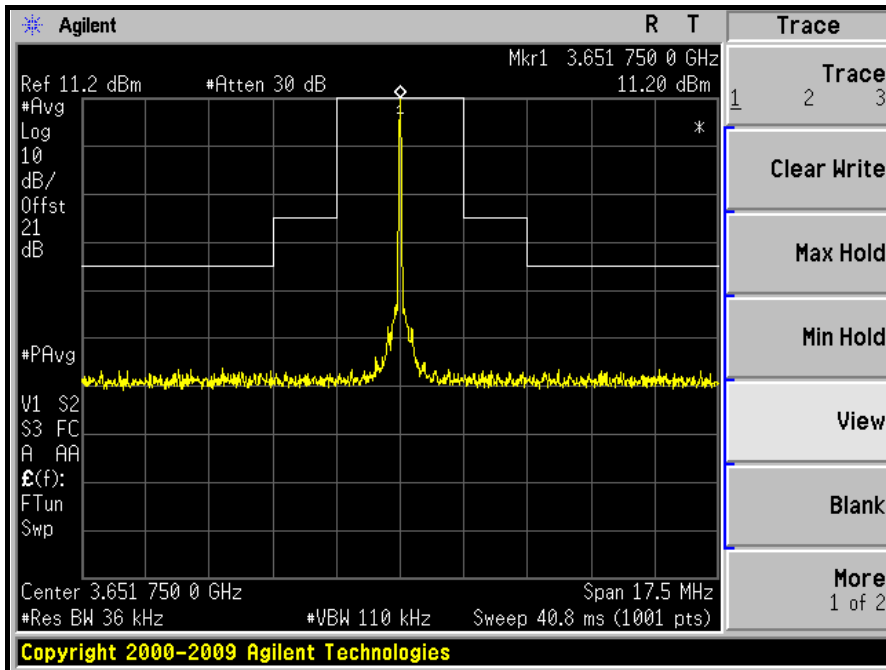



A D T

MIDDLE CHANNEL

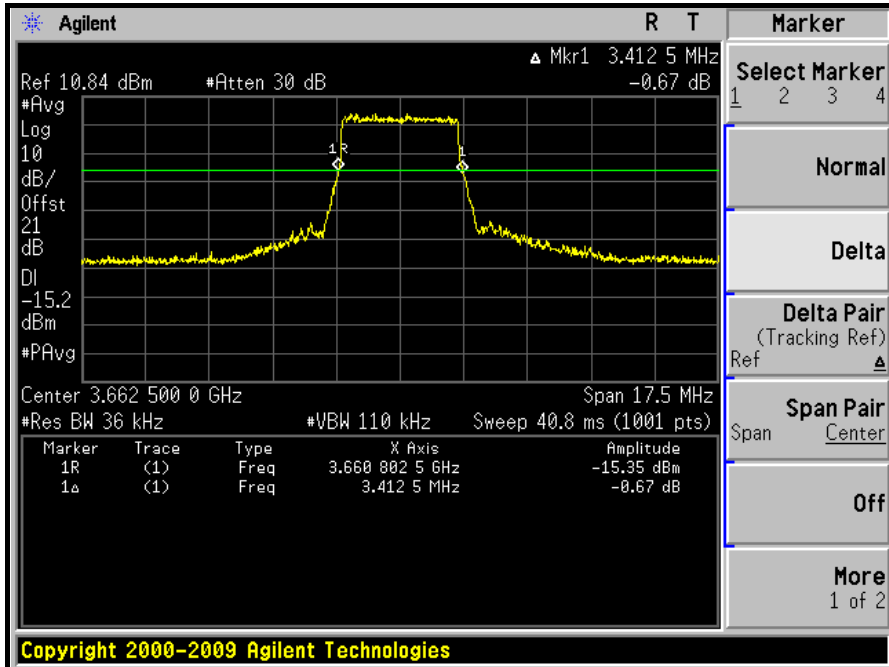
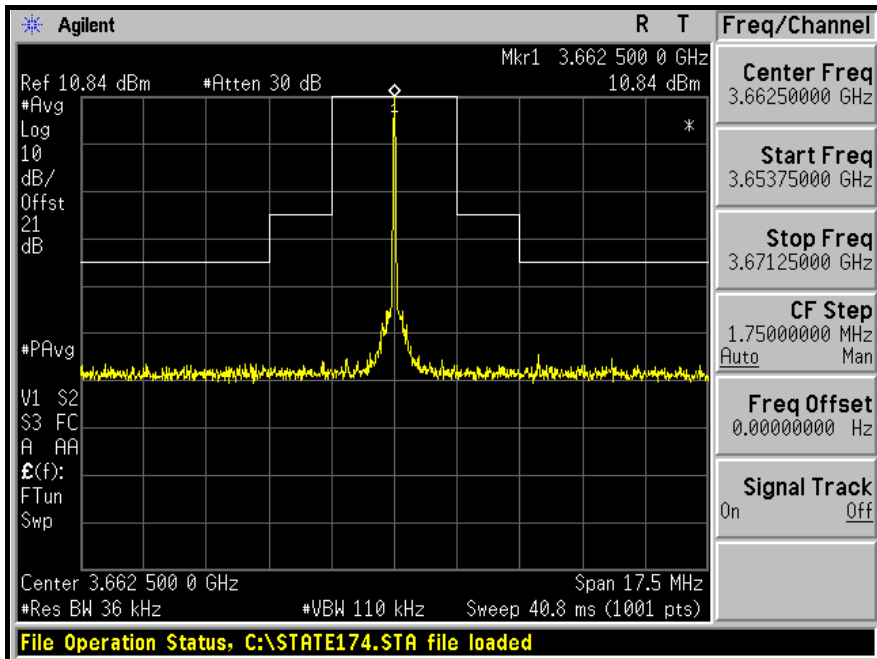



A D T

HIGH CHANNEL

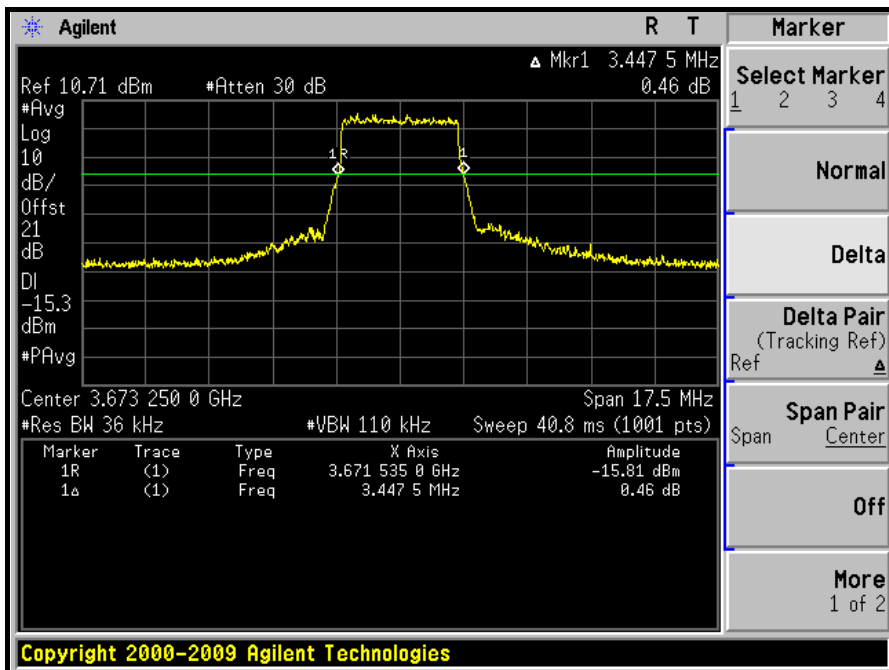
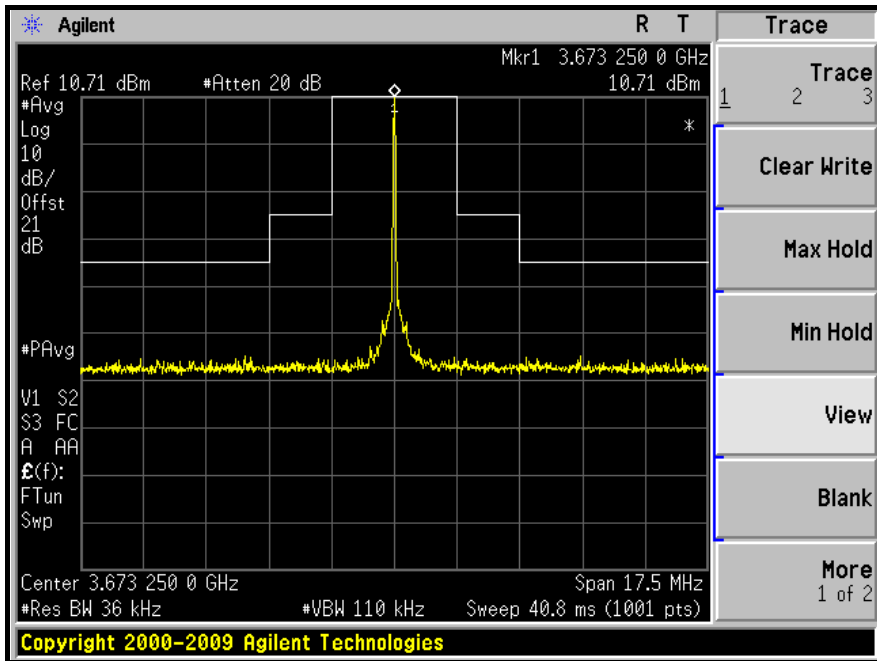



A D T

CHANNEL BANDWIDTH: 5MHz

CHANNEL	-26dBc BANDWIDTH (MHz)
Low	4.88
Middle	4.80
High	4.93



A D T

LOW CHANNEL

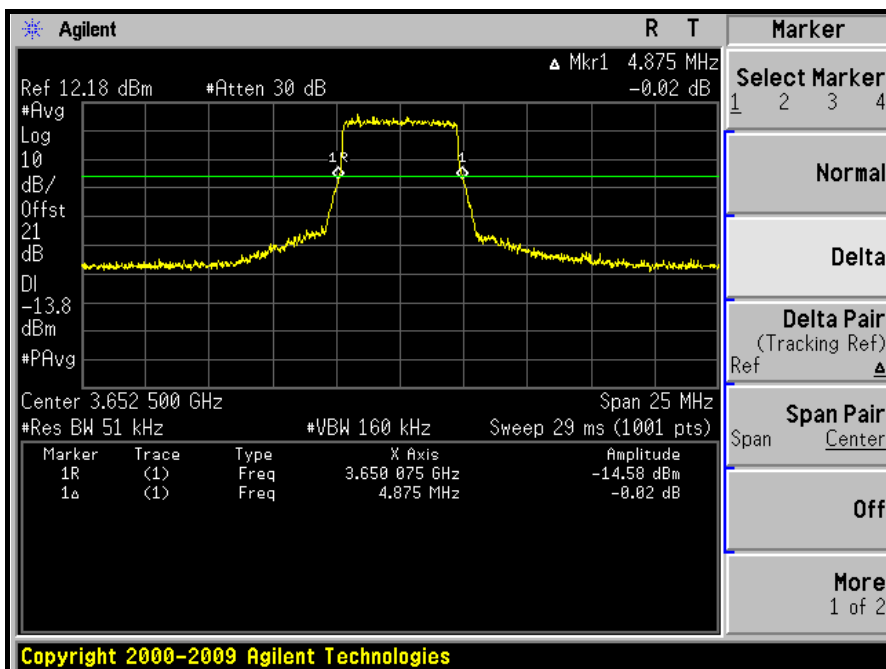
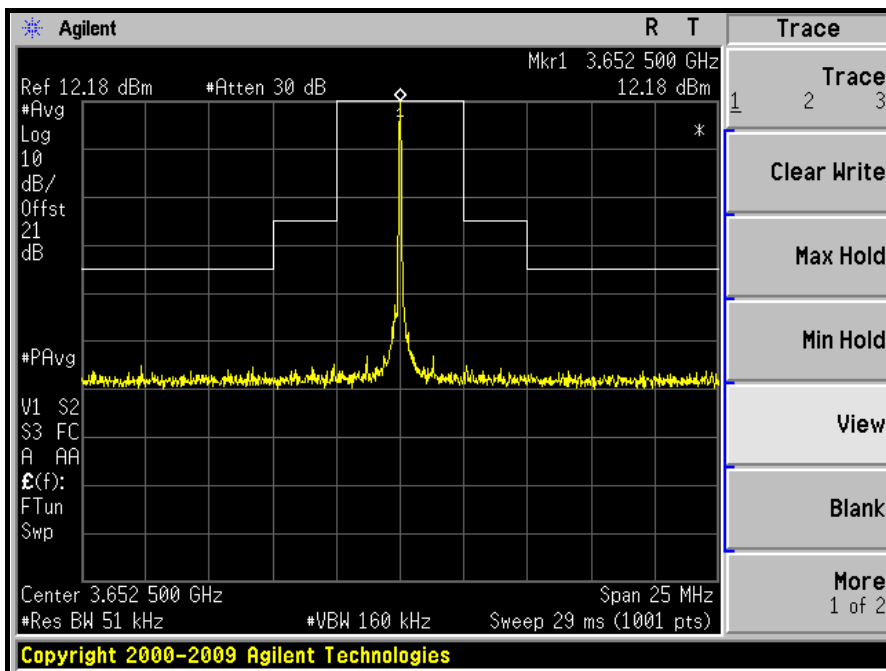



A D T

MIDDLE CHANNEL

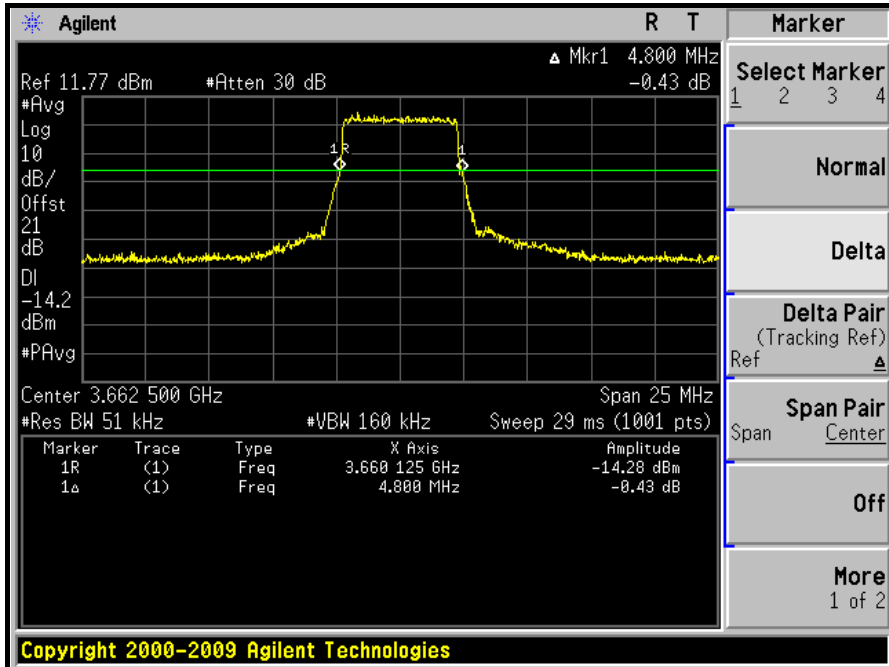
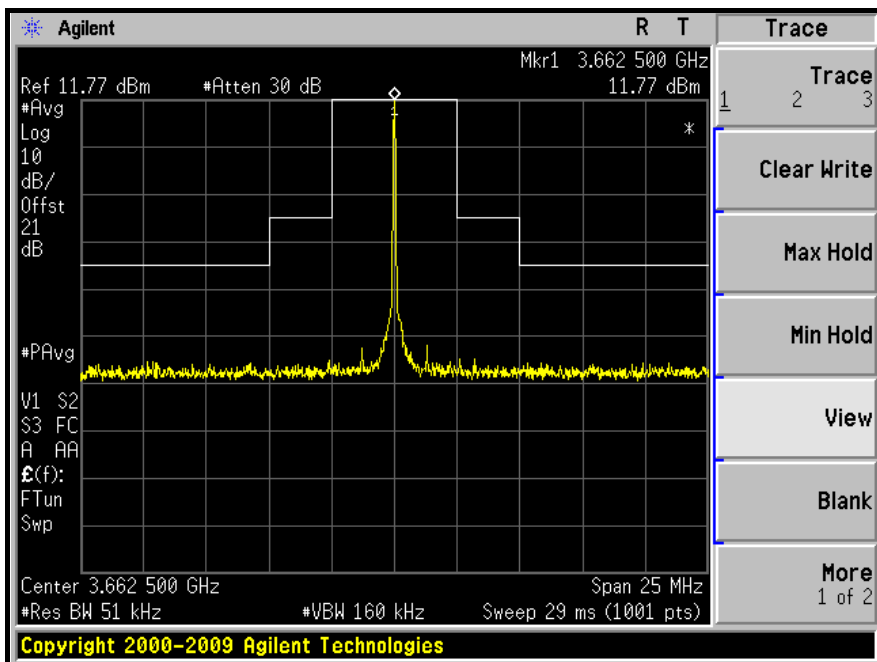



A D T

HIGH CHANNEL

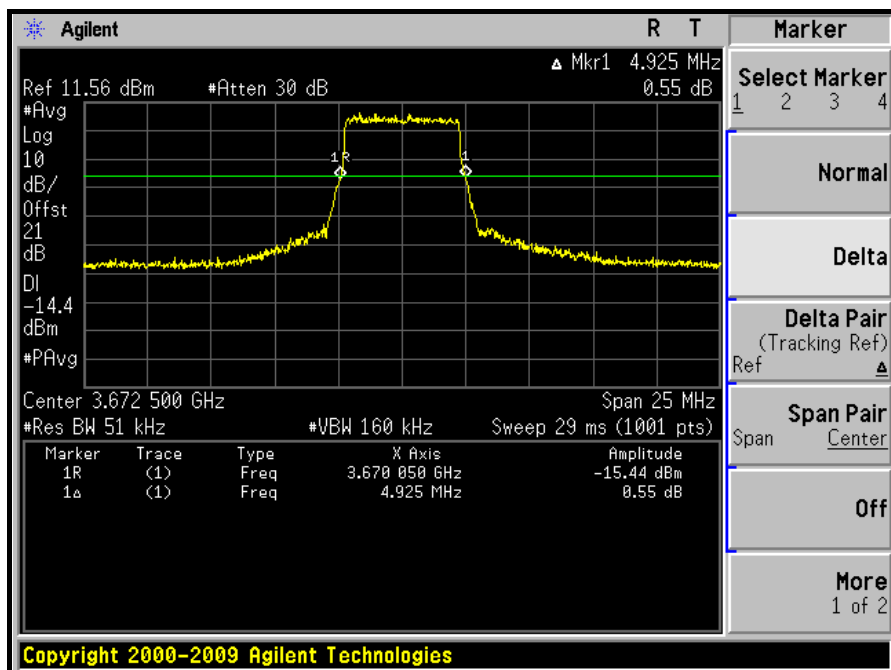
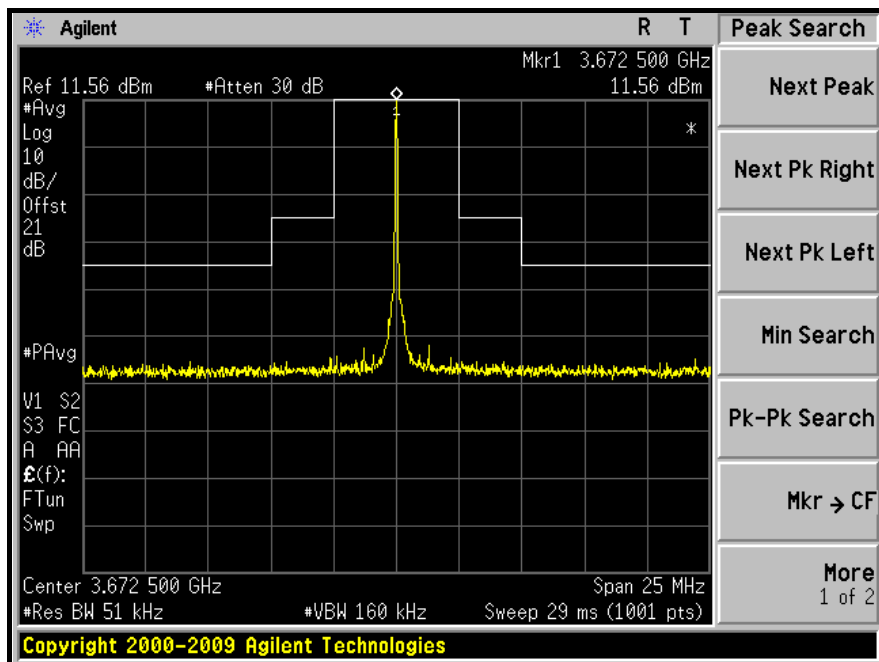



A D T

CHANNEL BANDWIDTH: 7MHz

CHANNEL	-26dBc BANDWIDTH (MHz)
Low	6.83
Middle	6.79
High	6.83



A D T

LOW CHANNEL

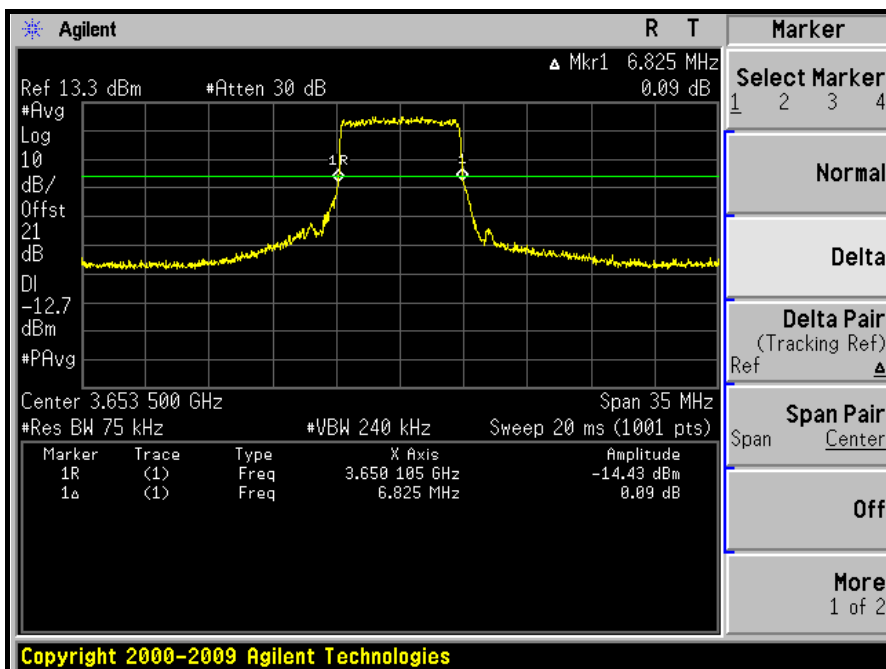
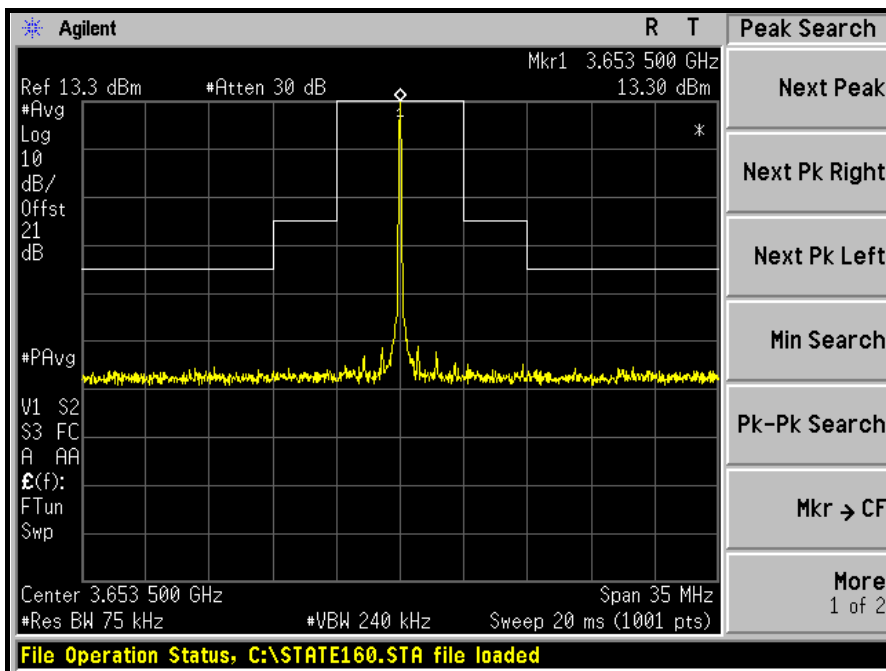



A D T

MIDDLE CHANNEL

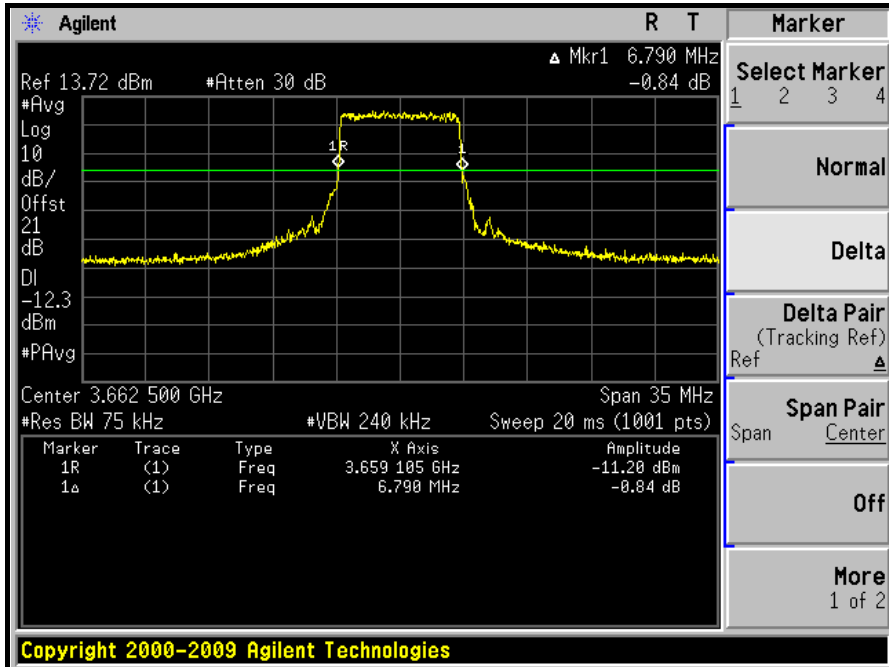
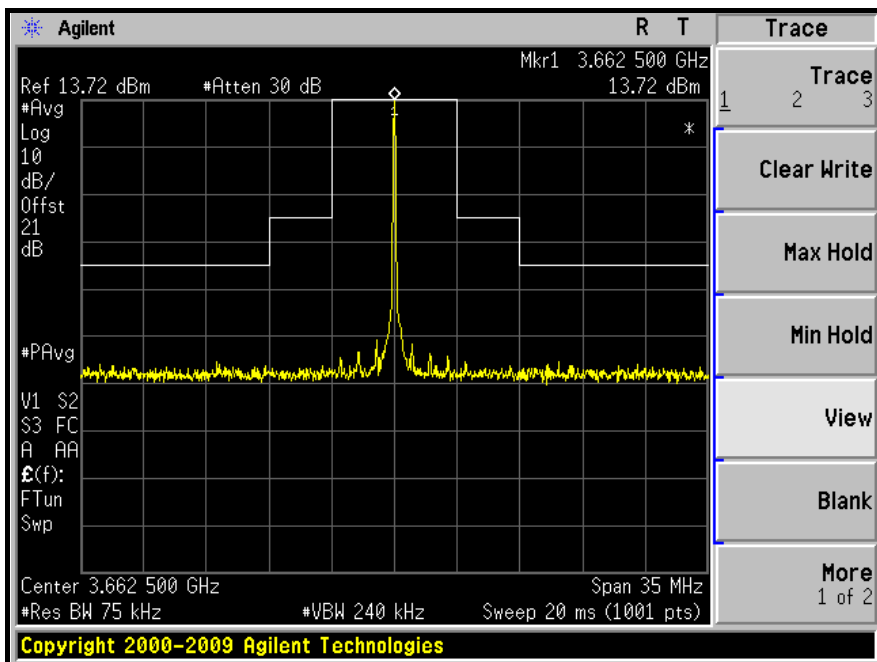



A D T

HIGH CHANNEL

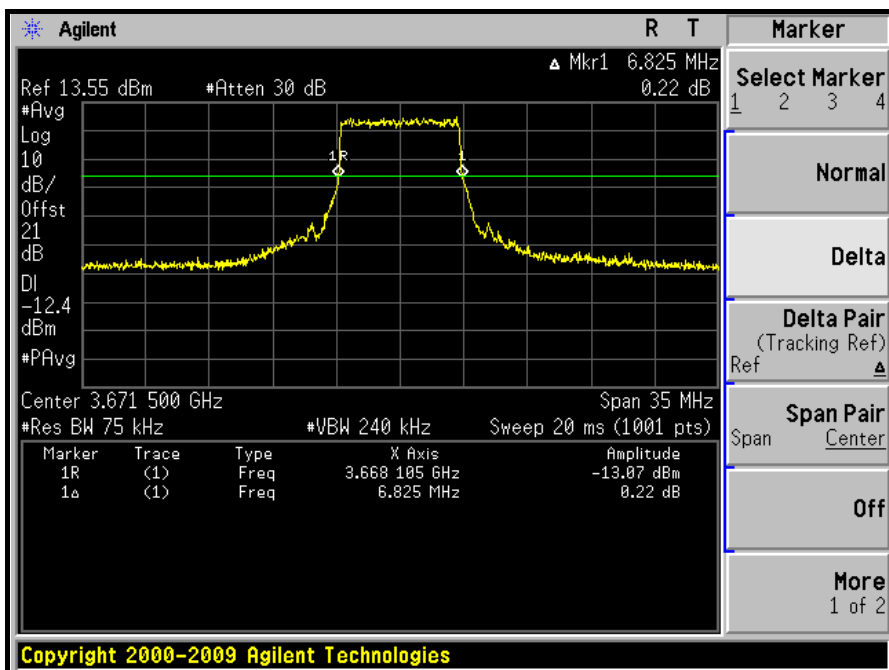
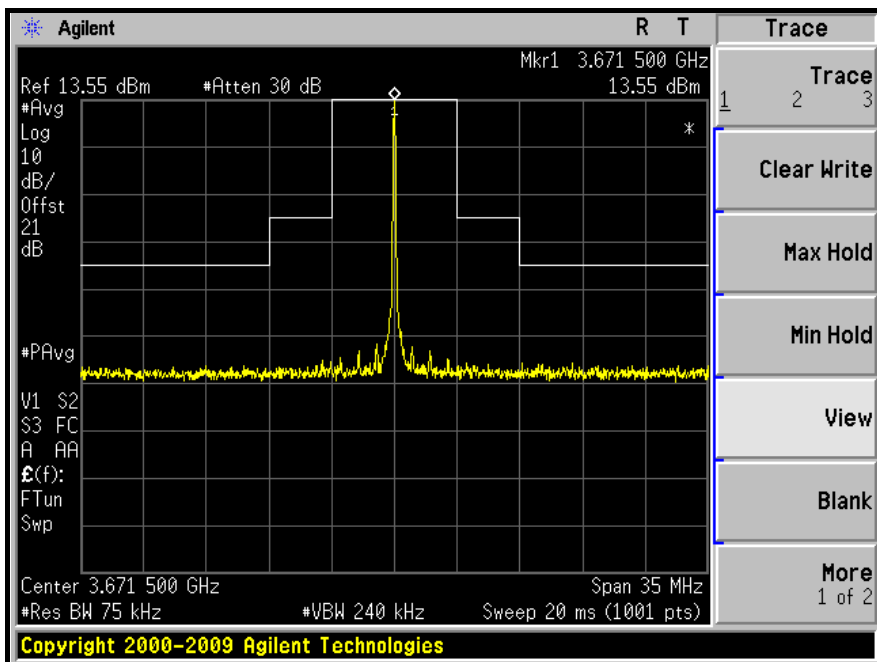



A D T

CHANNEL BANDWIDTH: 10MHz

CHANNEL	-26dBc BANDWIDTH (MHz)
Low	9.55
Middle	9.55
High	9.50



A D T

LOW CHANNEL

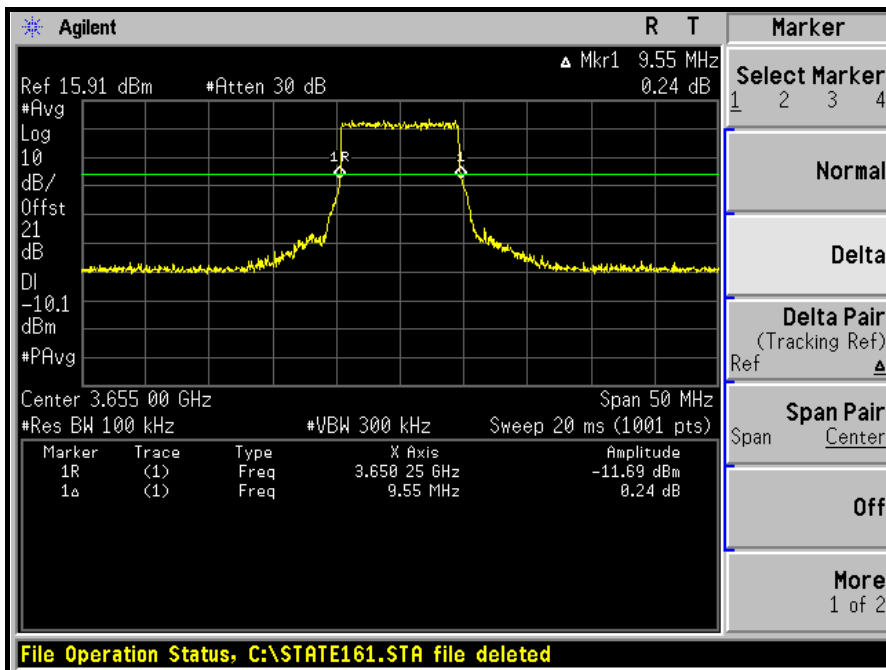
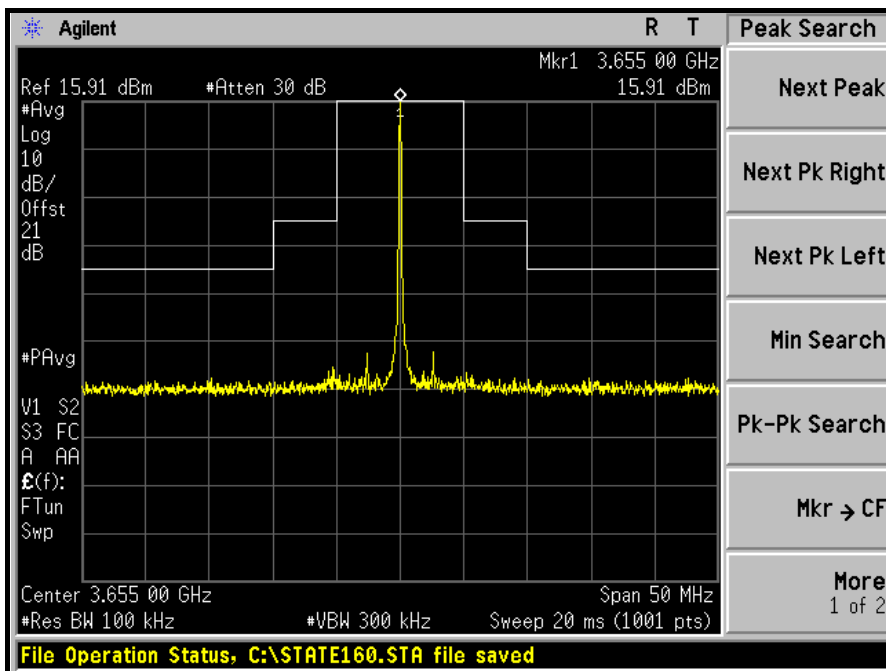



A D T

MIDDLE CHANNEL

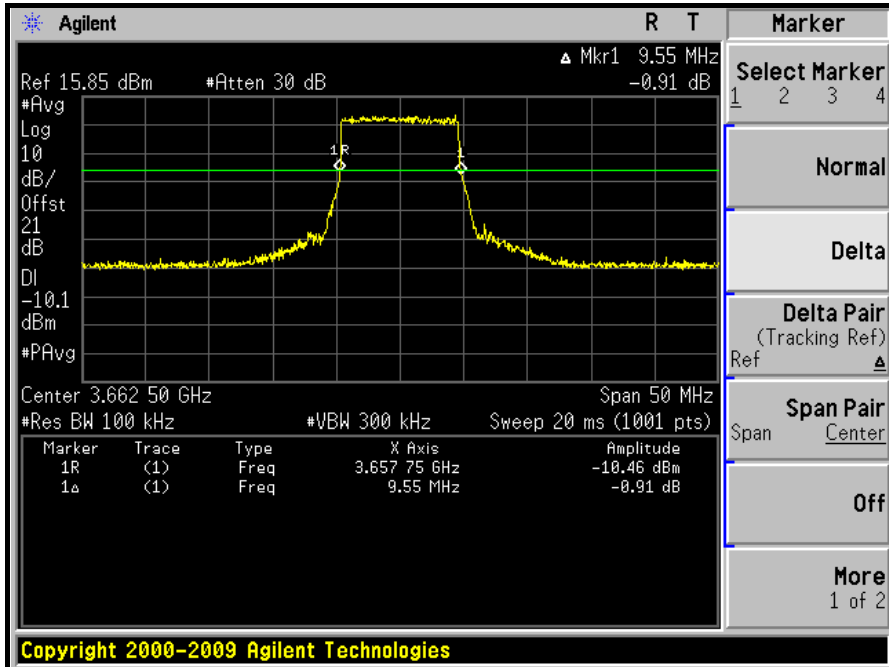
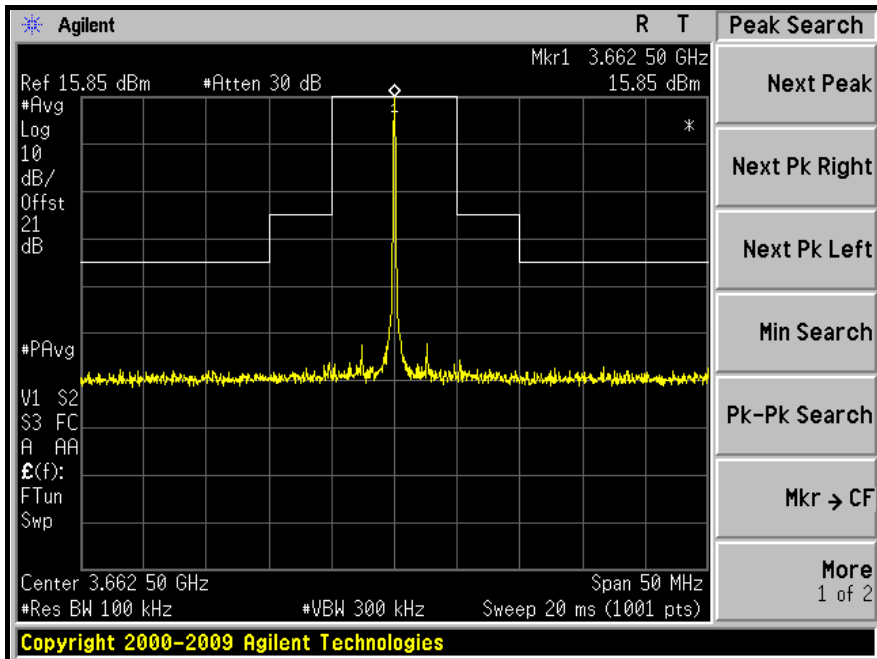



A D T

HIGH CHANNEL

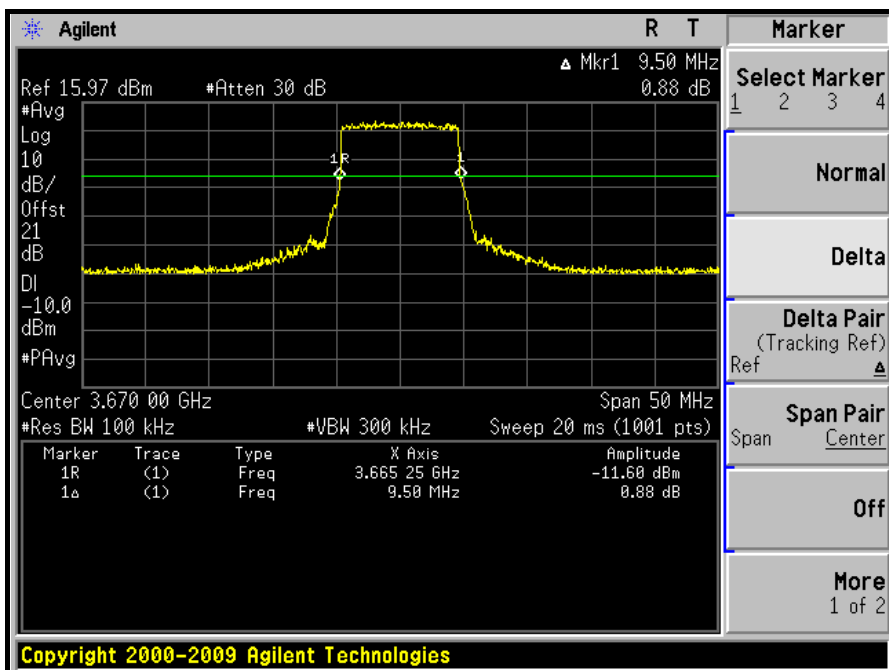
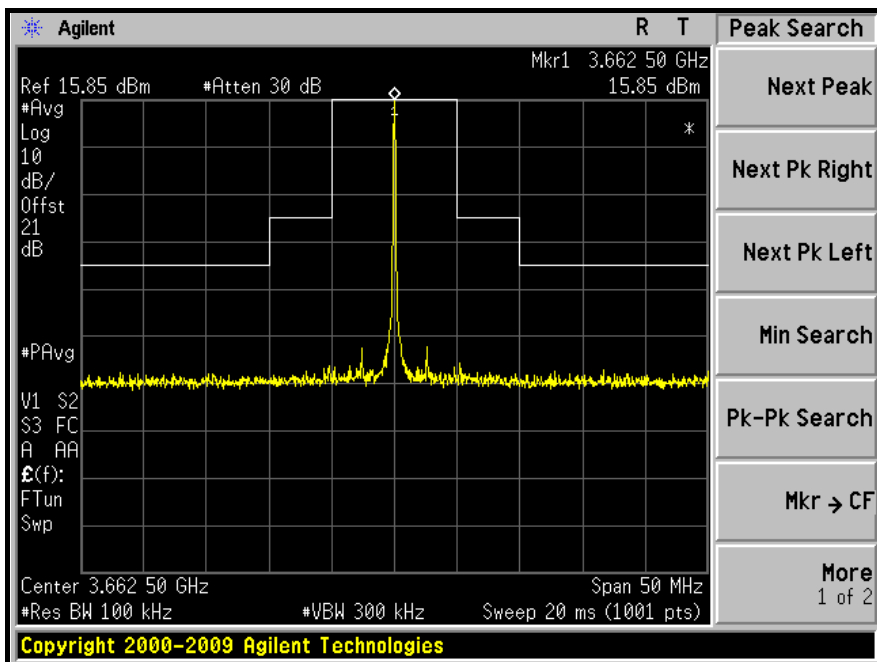

4.4 EMISSION MASKS

4.4.1 LIMITS OF EMISSION MASKS

For transmitters that are equipped with an audio low-pass filter, the power of any emission must be attenuated below the unmodulated carrier power (P) as follows:

- (1) On any frequency removed from the assigned frequency by more than 50 percent, but not more than 100 percent of the authorized bandwidth: At least 25 dB.
- (2) On any frequency removed from the assigned frequency by more than 100 percent, but not more than 250 percent of the authorized bandwidth: At least 35 dB.
- (3) On any frequency removed from the assigned frequency by more than 250 percent of the authorized bandwidth: At least $43 + 10\log(P)$ dB.

4.4.2 TEST INSTRUMENTS

DESCRIPTION & MANUFACTURER	MODEL NO.	SERIAL NO.	DATE OF CALIBRATION	DUE DATE OF CALIBRATION
Spectrum Analyzer Agilent	E4446A	MY44360128	Feb. 23, 2010	Feb. 22, 2011
RF cable	SUCOFLEX 104	257029	Sep. 12, 2009	Sep. 11, 2010
DC-6GHz 20dB 50W Fixed attenuator Woken	MDC9331N-20	0724	May 15, 2009	May 14, 2010

NOTE: The calibration interval of the above test instruments is 12 months and the calibrations are traceable to NML/ROC and NIST/USA.

4.4.3 TEST SETUP

Same as 4.1.4

4.4.4 TEST PROCEDURES

- a. The bandwidth of the fundamental frequency was measured by spectrum analyzer with RBW = 36kHz (3.5MHz bandwidth), 51kHz (5MHz bandwidth), 75kHz (7MHz bandwidth), 100kHz (10MHz bandwidth), VBW = 110kHz (3.5MHz bandwidth), 160kHz (5MHz bandwidth), 240kHz (7MHz bandwidth), 300kHz (10MHz bandwidth).
- b. Set EUT to transmit signal at un-modulation mode to get reference level, R_L .
- c. According R_L and Channel bandwidth to define Emission Mask range.
- d. Set EUT to transmit signal at modulation mode to check signal can comply with Emission Mask or not.

4.4.5 EUT OPERATING CONDITION

Same as 4.1.5



A D T

4.4.6 TEST RESULTS

CHANNEL BANDWIDTH: 3.5MHz

LOW CHANNEL

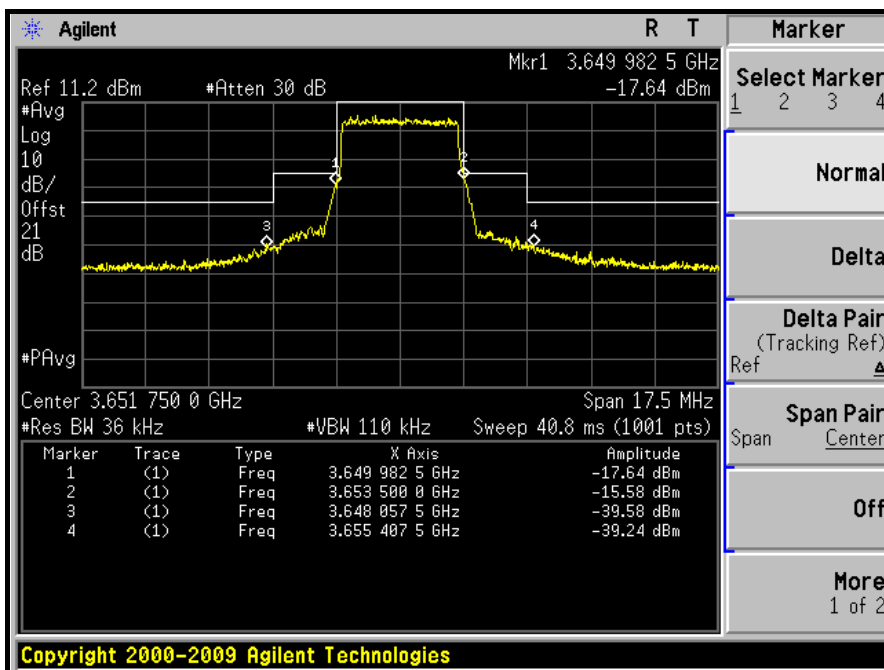
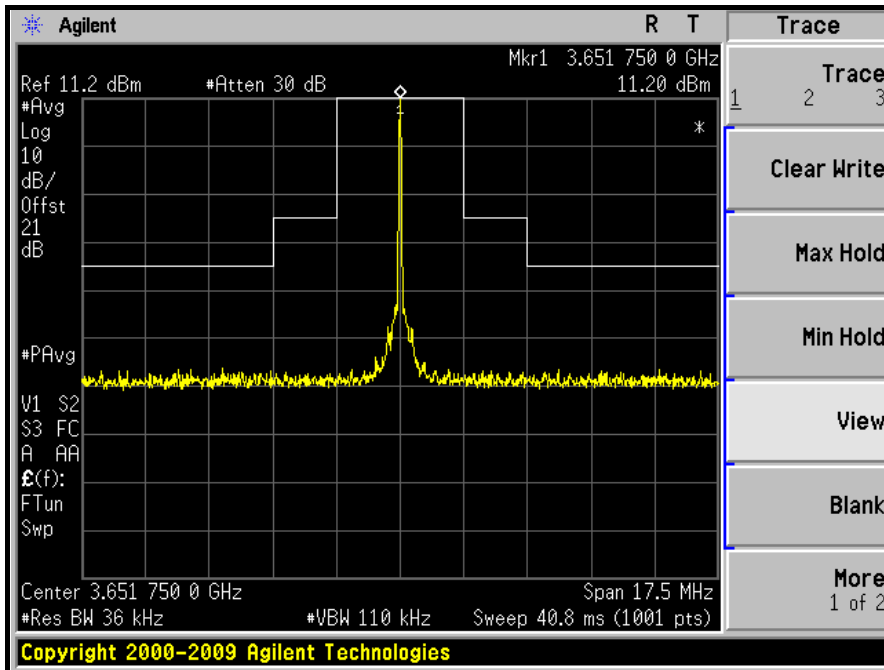



A D T

MIDDLE CHANNEL

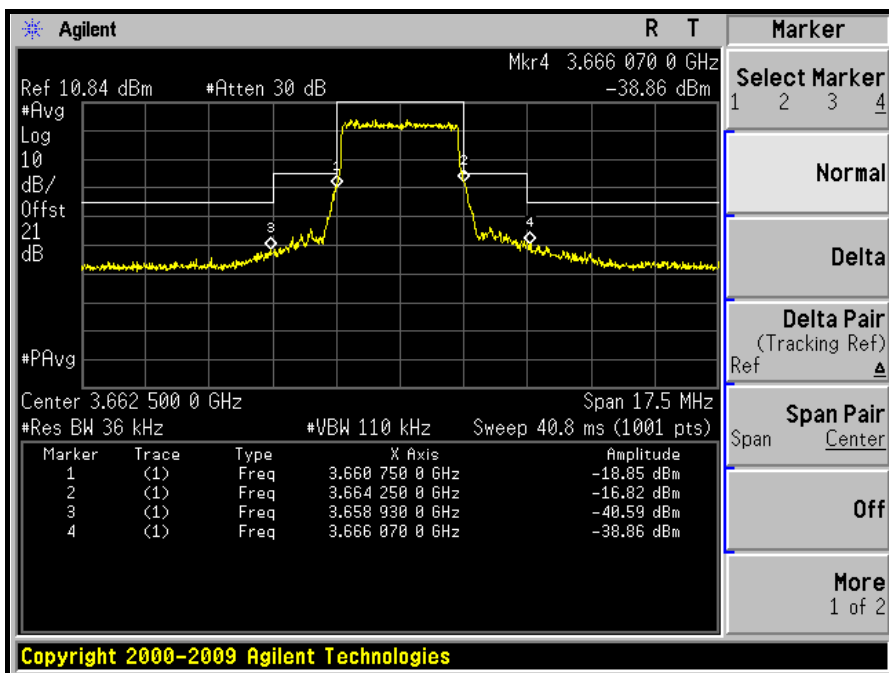
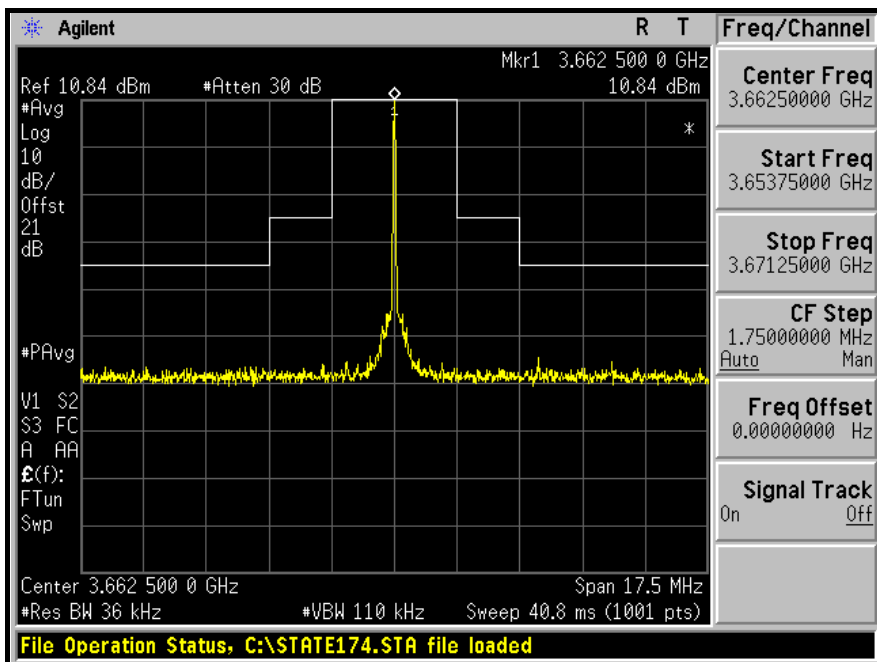



A D T

HIGH CHANNEL

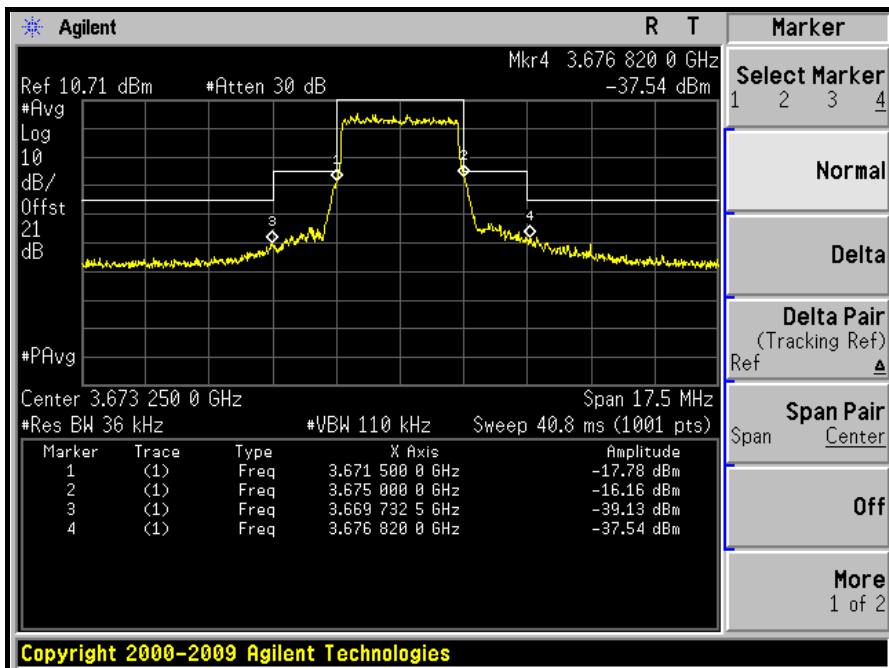
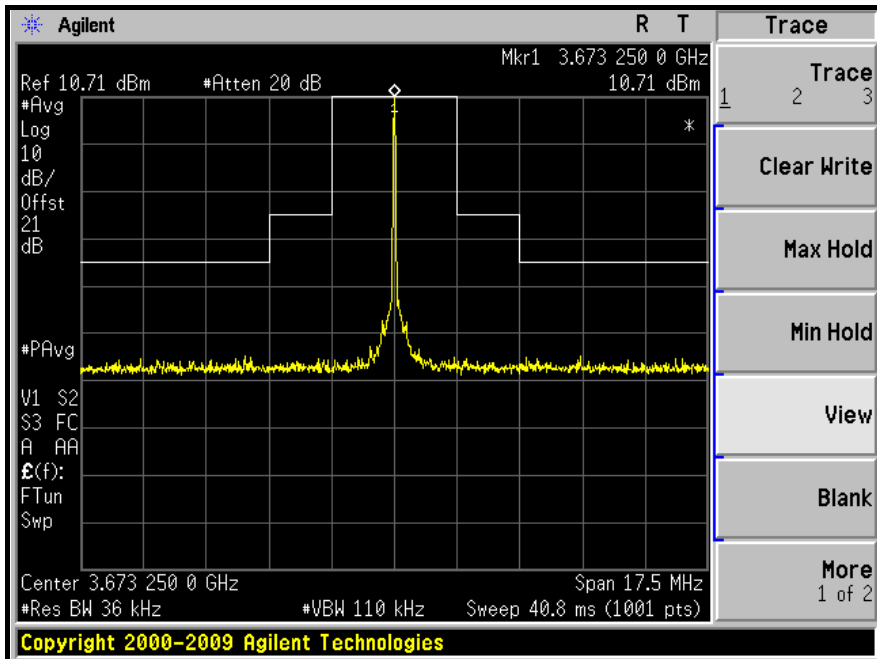



A D T

CHANNEL BANDWIDTH: 5MHz

LOW CHANNEL

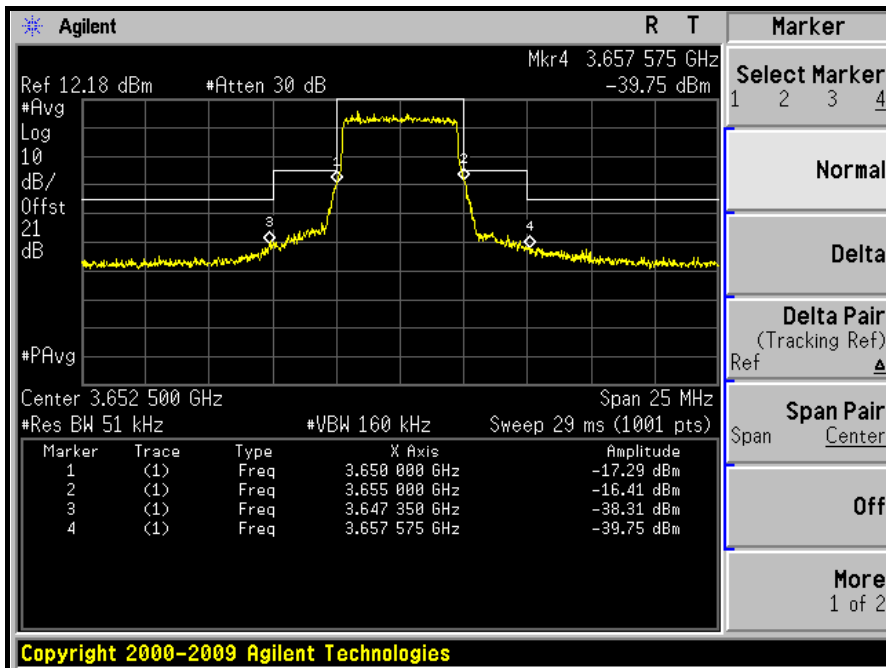
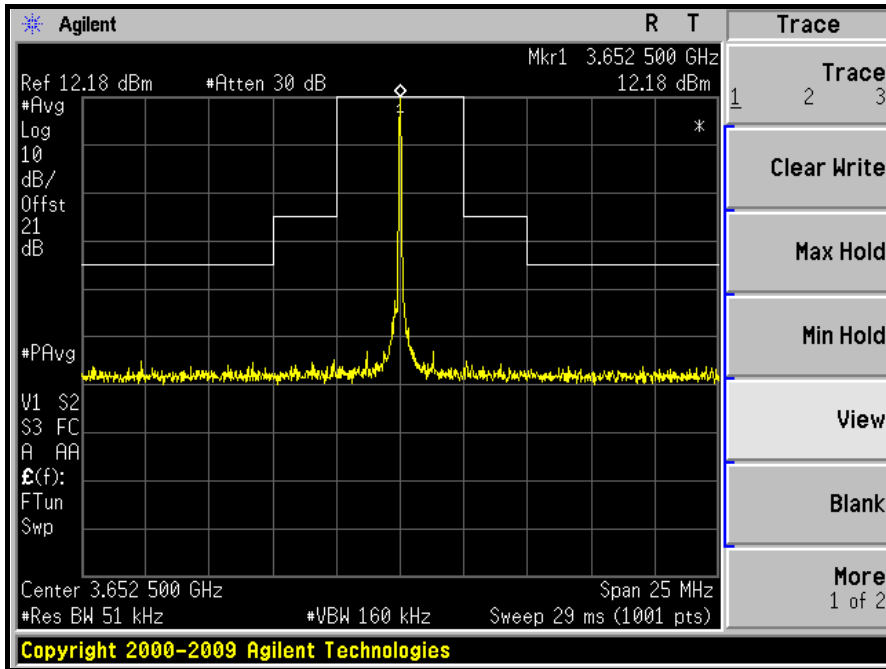



A D T

MIDDLE CHANNEL

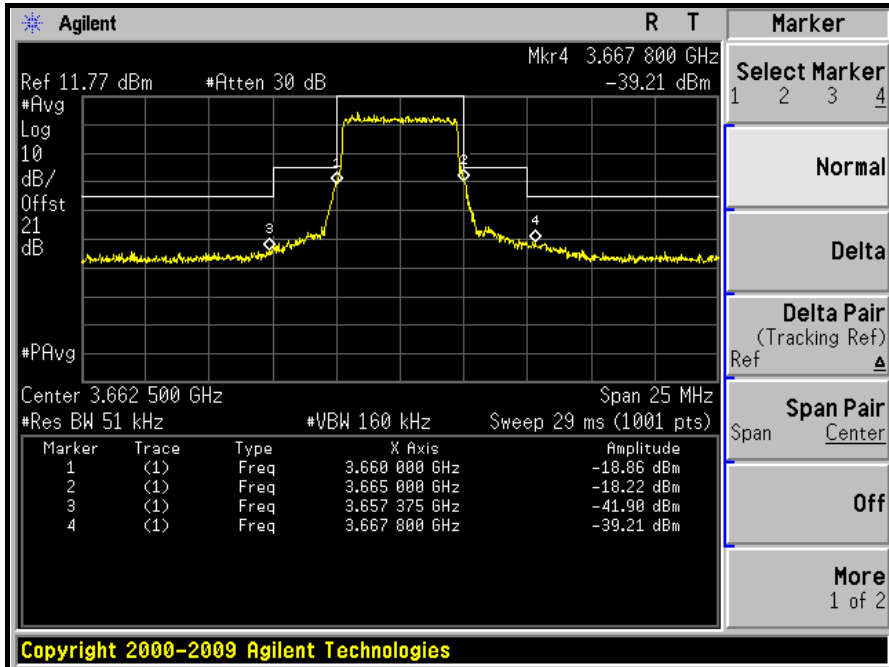
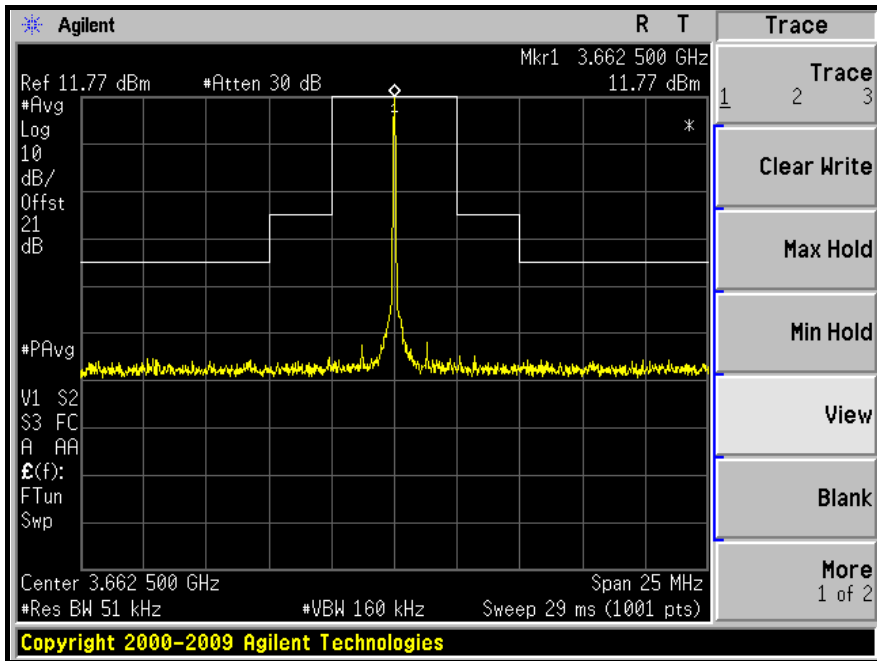



A D T

HIGH CHANNEL

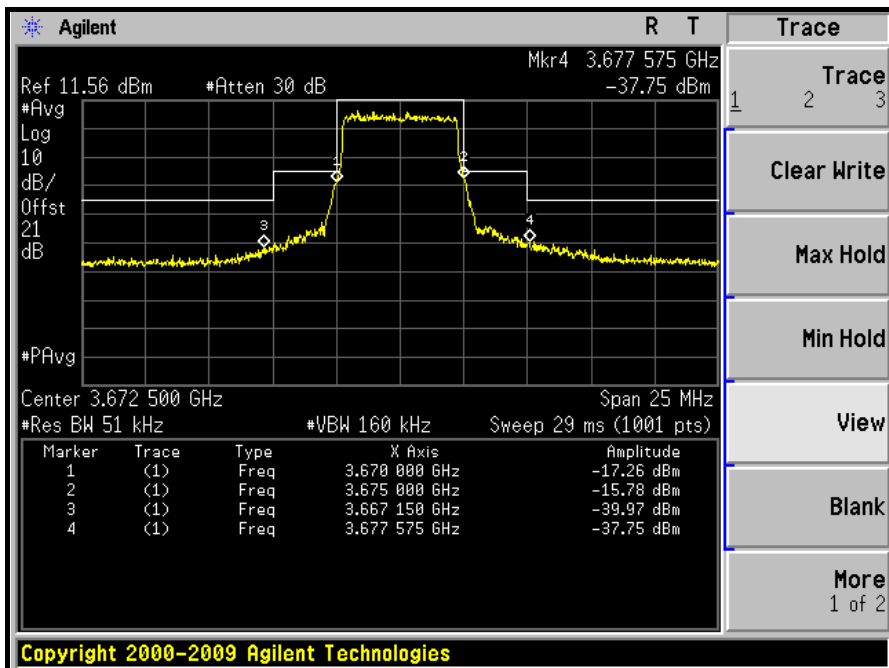
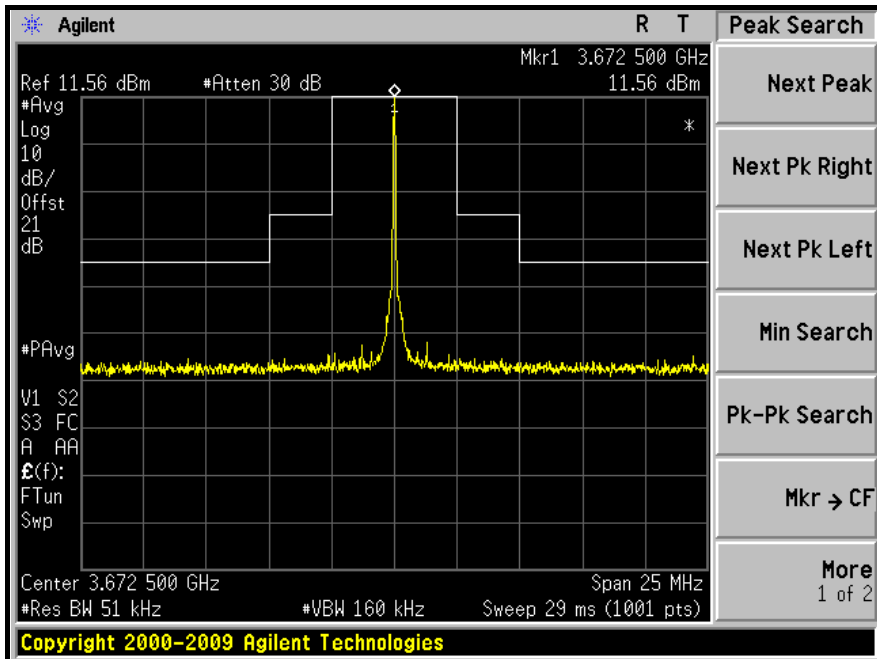



A D T

CHANNEL BANDWIDTH: 7MHz

LOW CHANNEL

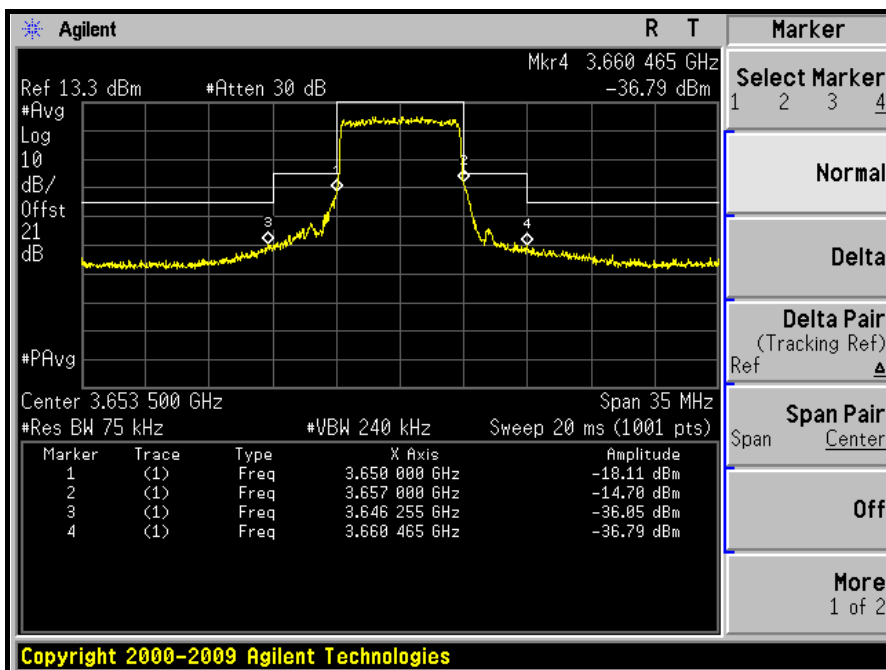
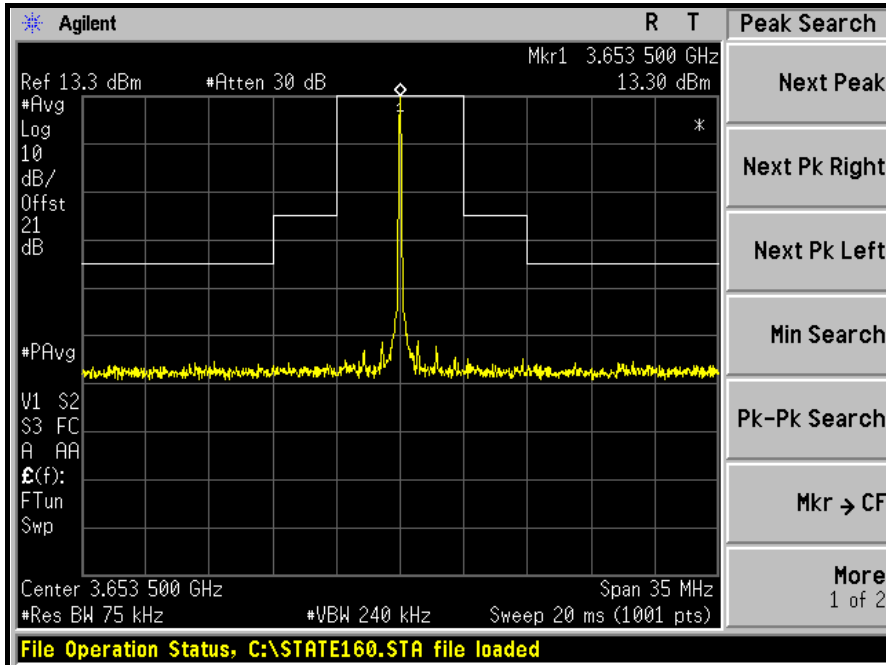



A D T

MIDDLE CHANNEL

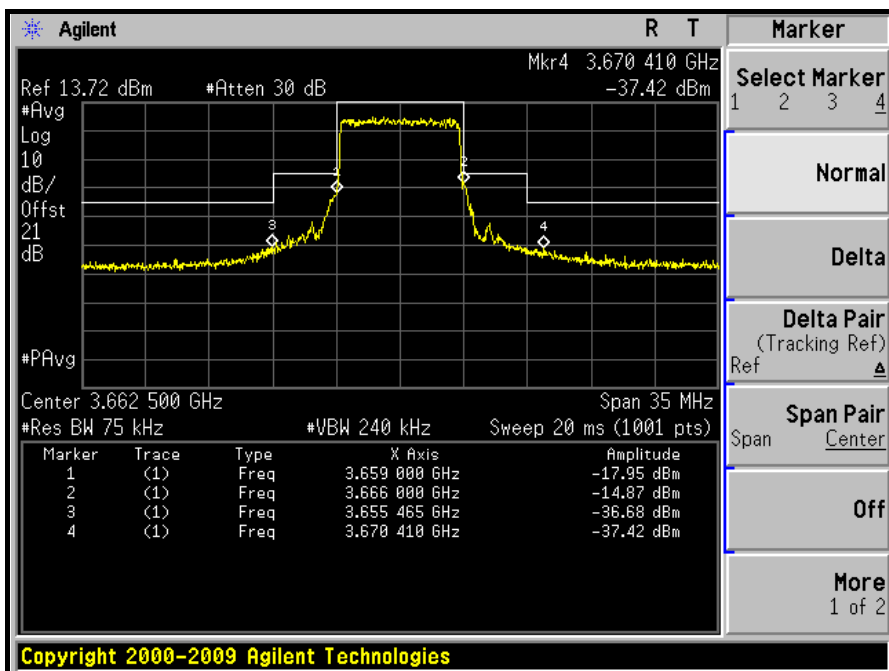
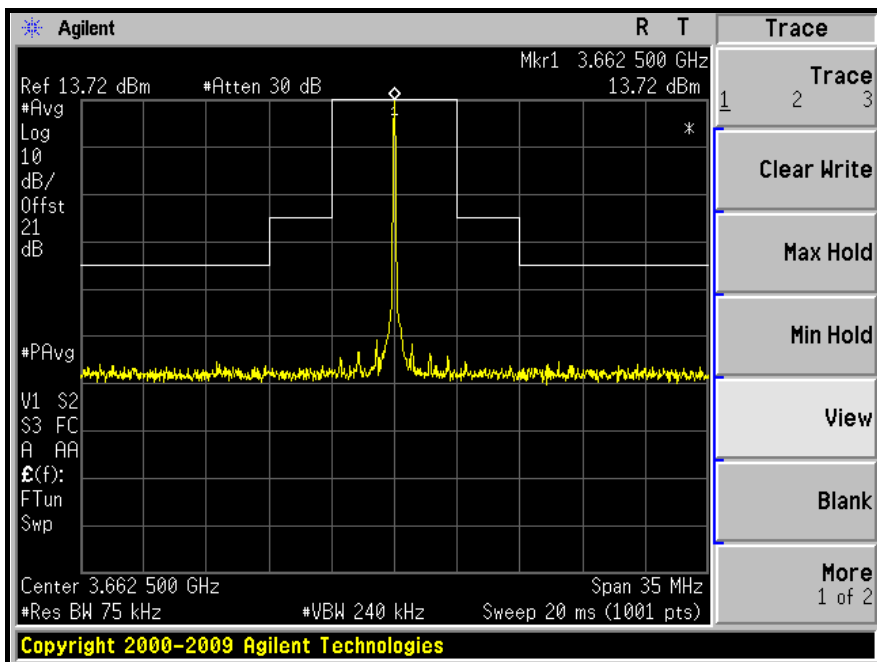



HIGH CHANNEL

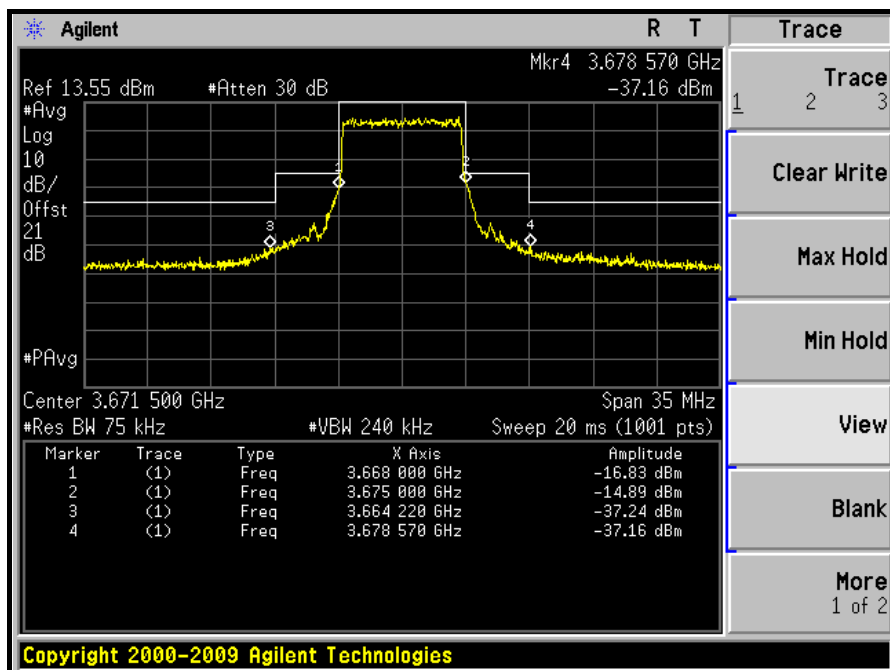
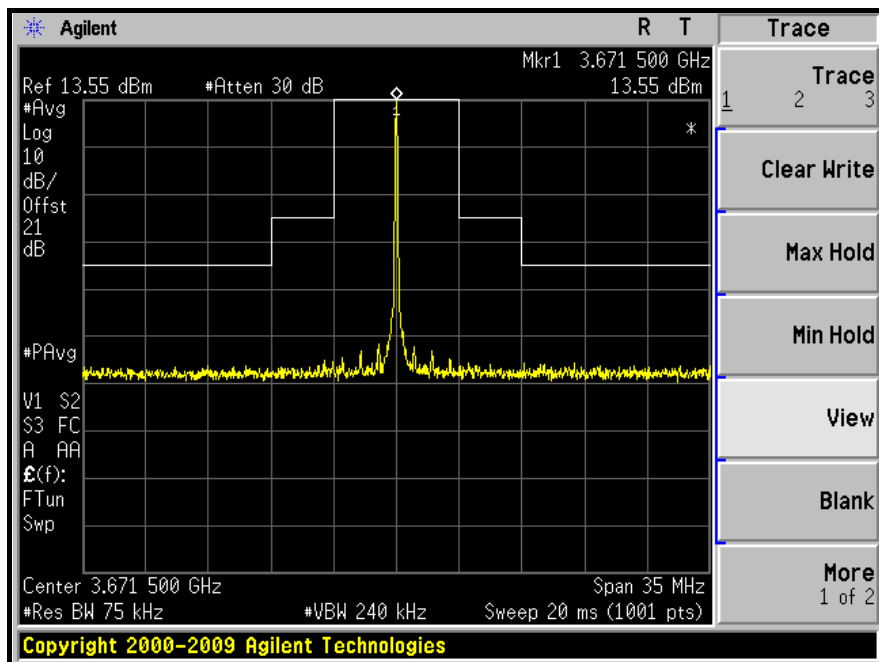



A D T

CHANNEL BANDWIDTH: 10MHz

LOW CHANNEL

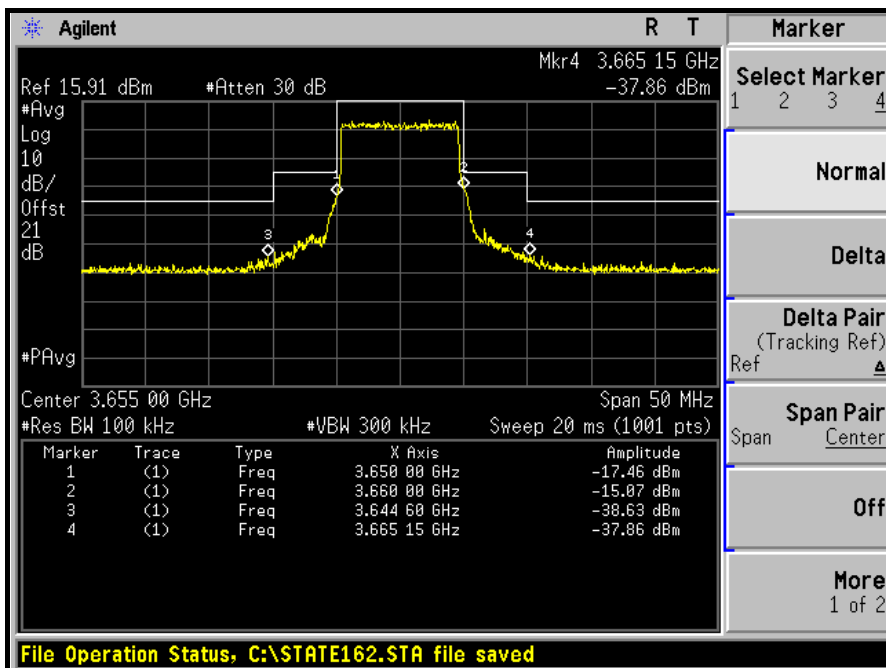
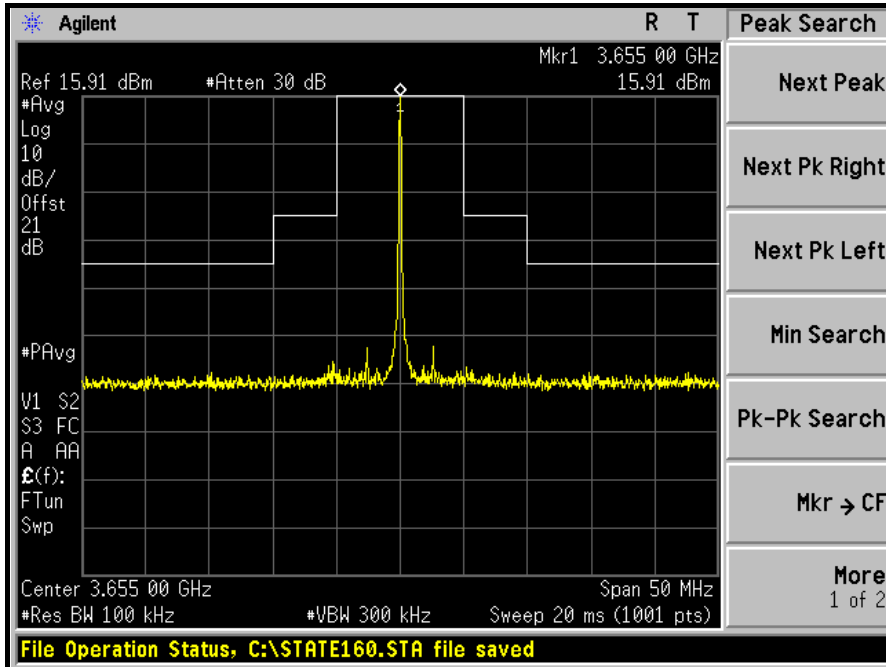



A D T

MIDDLE CHANNEL

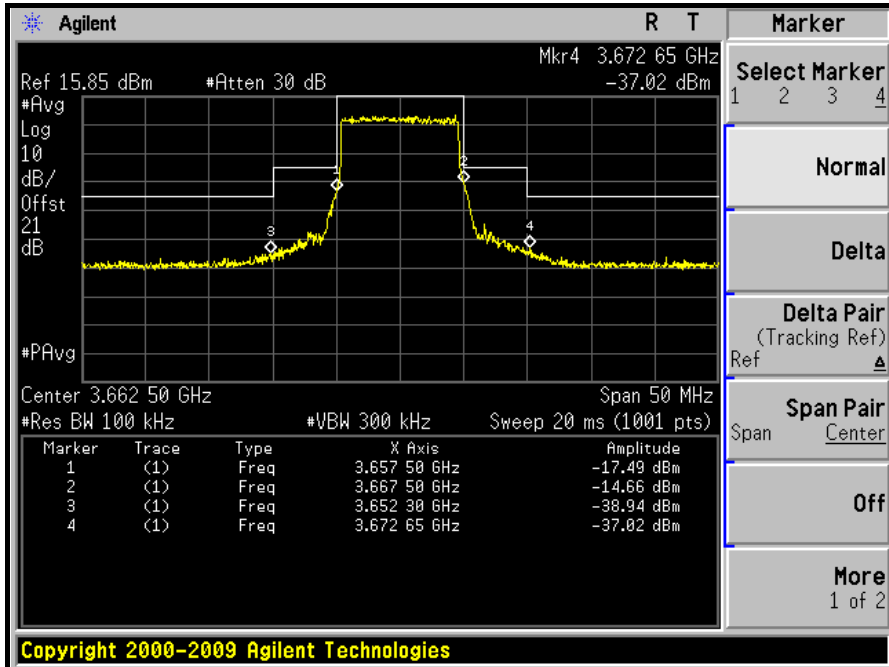
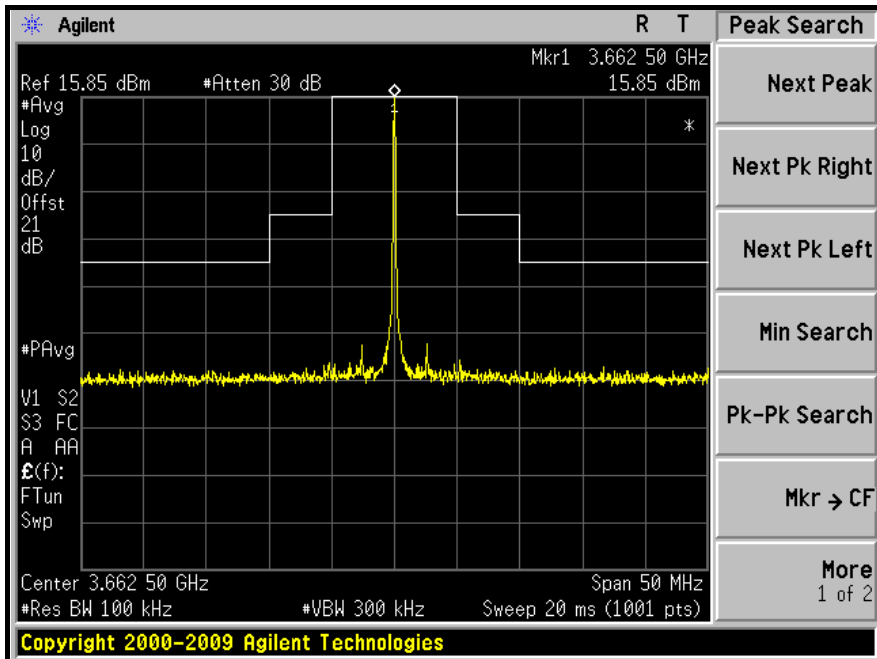



HIGH CHANNEL

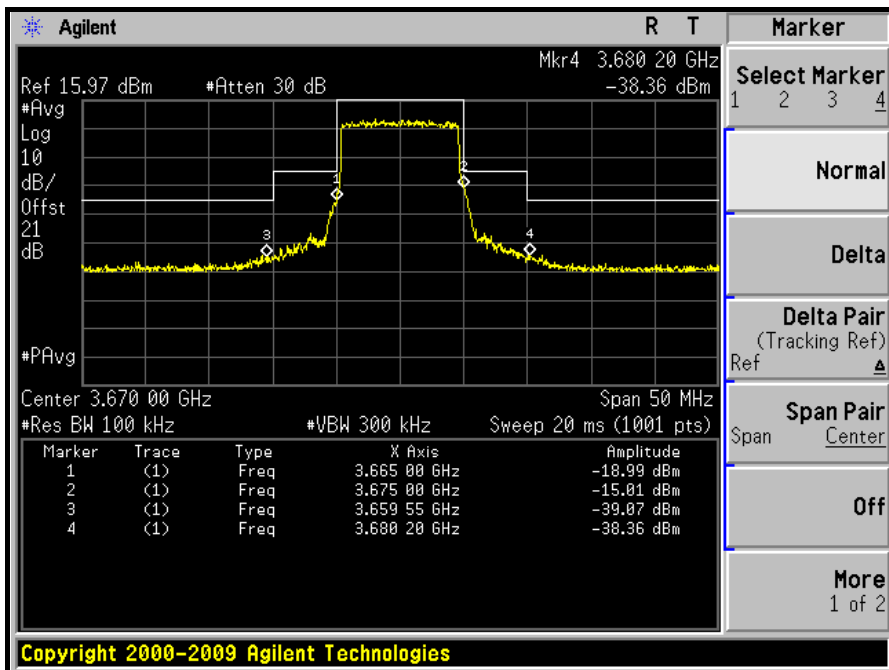
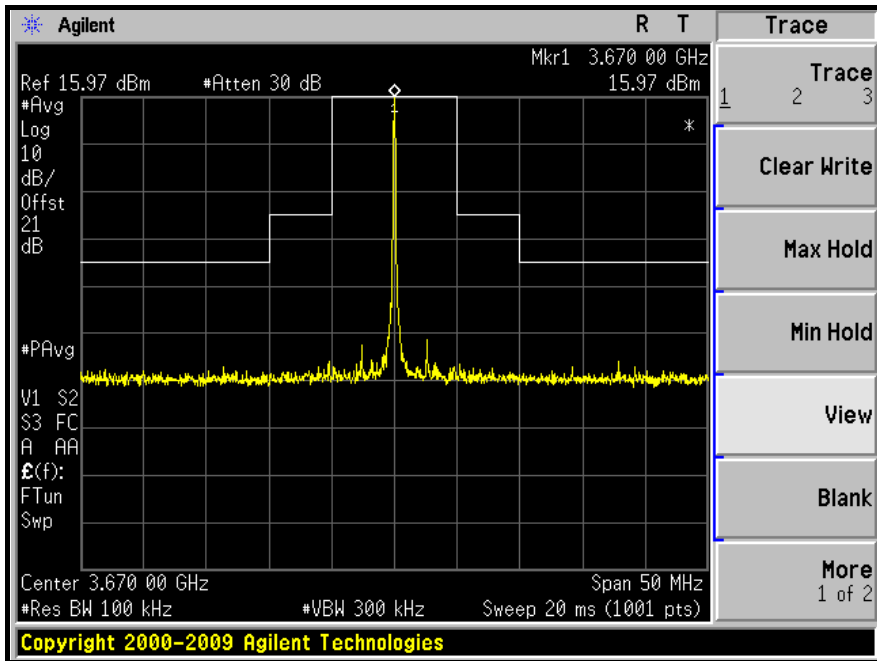

4.5 CONDUCTED SPURIOUS EMISSIONS

4.5.1 LIMITS OF CONDUCTED SPURIOUS EMISSIONS MEASUREMENT

According to FCC 90.1323 specified that the power of any emission outside a licensee's frequency band(s) of operation shall be attenuated below the transmitter power (P) within the licensed band(s) of operation, measured in Watts, by at least $43 + 10 \log (P)$ dB. The limit of emission equal to -13dBm Compliance with this provision is based on the use of measurement instrumentation employing a resolution bandwidth of 1 MHz or less, but at least one percent of the emission bandwidth of the fundamental emission of the transmitter, provided the measured energy is integrated over a 1 MHz bandwidth

4.5.2 TEST INSTRUMENTS

DESCRIPTION & MANUFACTURER	MODEL NO.	SERIAL NO.	DATE OF CALIBRATION	DUE DATE OF CALIBRATION
Spectrum Analyzer Agilent	E4446A	MY44360128	Feb. 23, 2010	Feb. 22, 2011
RF cable	SUCOFLEX 104	257029	Sep. 12, 2009	Sep. 11, 2010
DC-6GHz 20dB 50W Fixed attenuator Woken	MDC9331N-20	0724	May 15, 2009	May 14, 2010
Wainwright Instruments High Pass Filter	WHKX4.5/18G -10SS	NA	NA	NA

NOTE: The calibration interval of the above test instruments is 12 months and the calibrations are traceable to NML/ROC and NIST/USA.

4.5.3 TEST PROCEDURE

- a. All measurements were done at 3 channels: low, middle and high operational frequency range.
- b. When the spectrum scanned from 30MHz to 4.5GHz, it shall be connected to the 20dB pad attenuated the carried frequency. The spectrum set RB = 1MHz, VB = 3MHz.
- c. When the spectrum scanned from 4.5GHz to 40GHz, it shall be connected to the high pass filter attenuated the carried frequency. The spectrum set RB = 1MHz, VB = 3MHz.

4.5.4 TEST SETUP

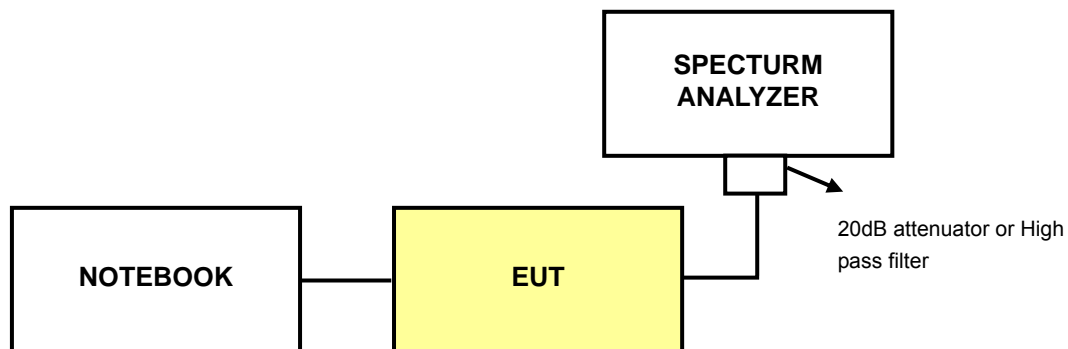

4.5.5 EUT OPERATING CONDITIONS

Same as 4.1.5

4.5.6 TEST RESULTS

CHANNEL BANDWIDTH: 3.5MHz

LOW CHANNEL: 30MHz ~ 1GHz:

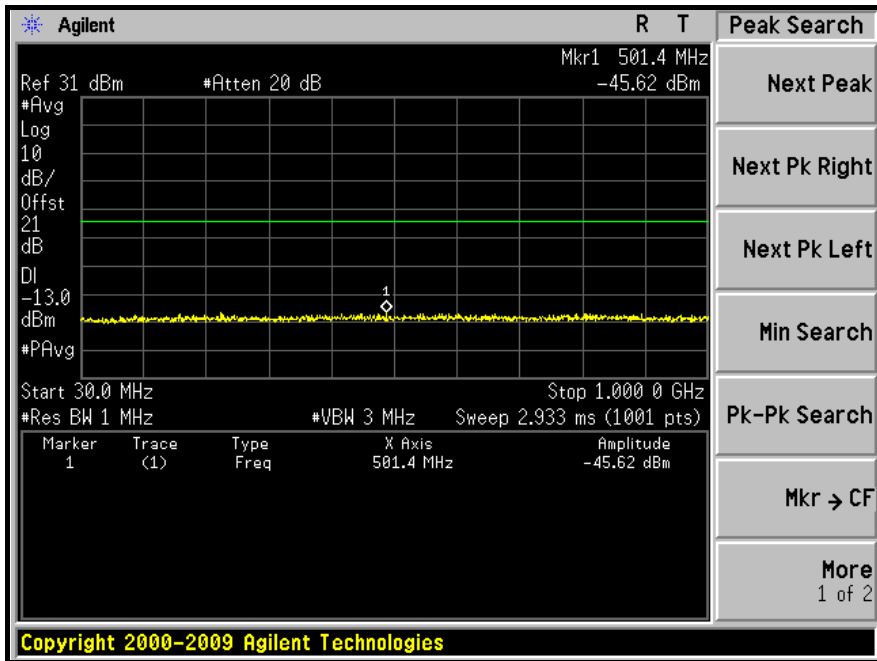

1GHz ~ 4.5GHz:

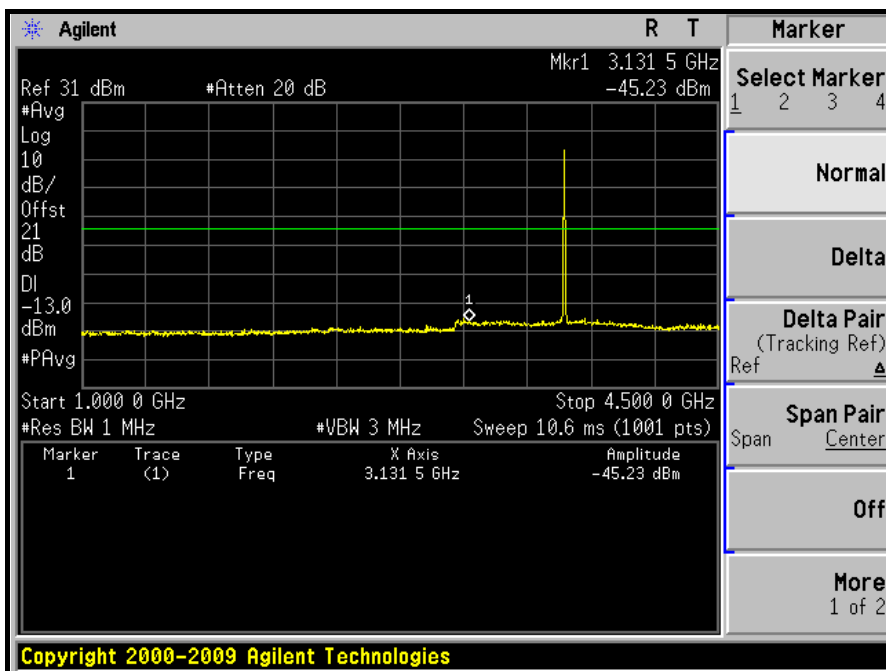



A D T

4.5GHz ~ 10GHz:

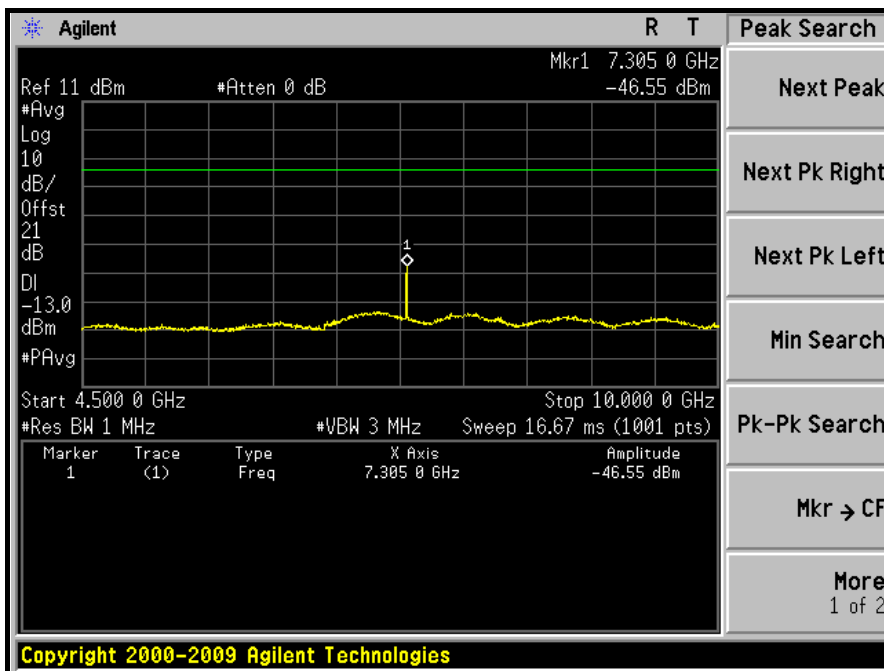

10GHz ~ 20GHz:

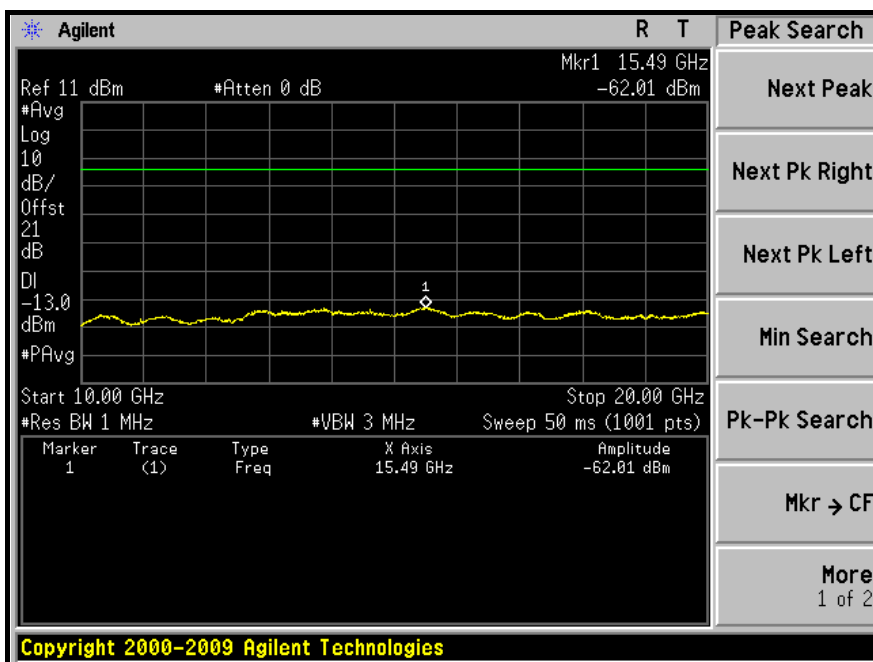



A D T

20GHz ~ 30GHz:

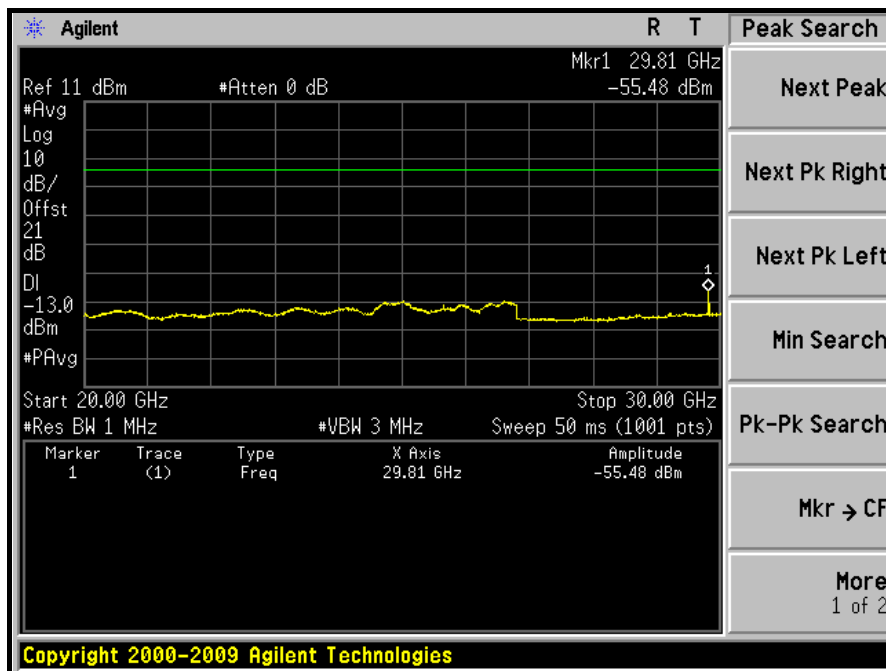

30GHz ~ 40GHz:

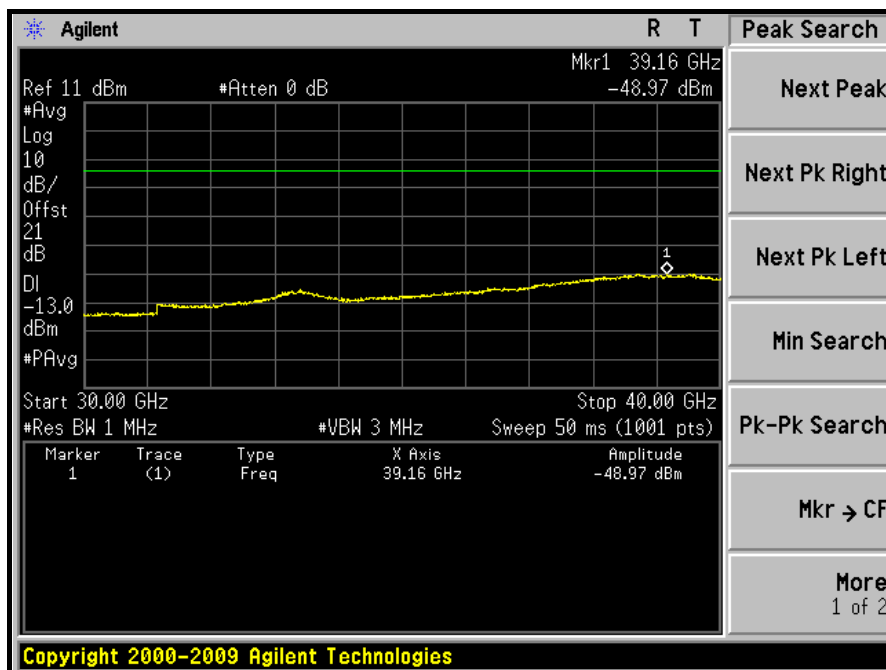



A D T

MIDDLE CHANNEL: 30MHz ~ 1GHz:

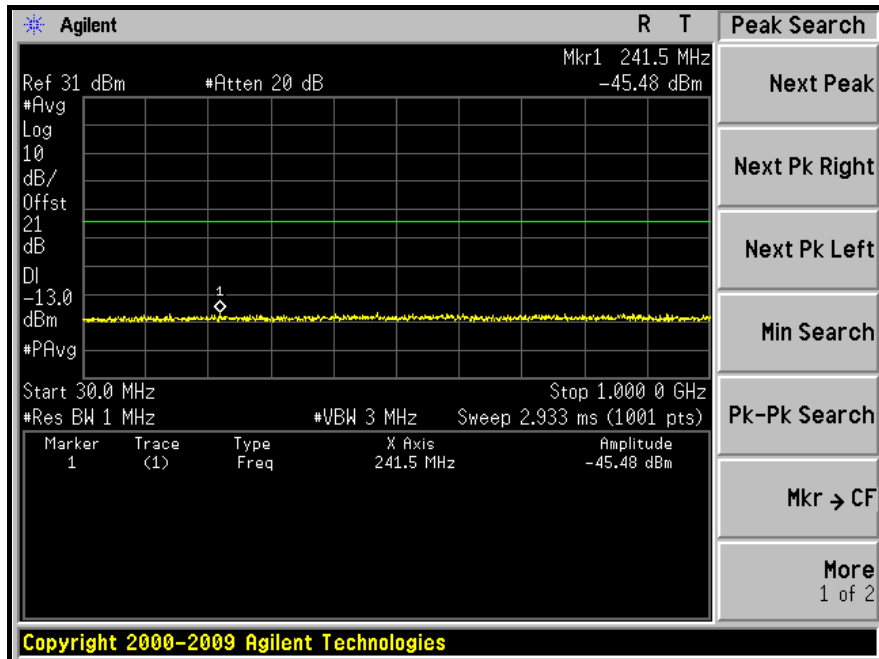

1GHz ~ 4.5GHz:

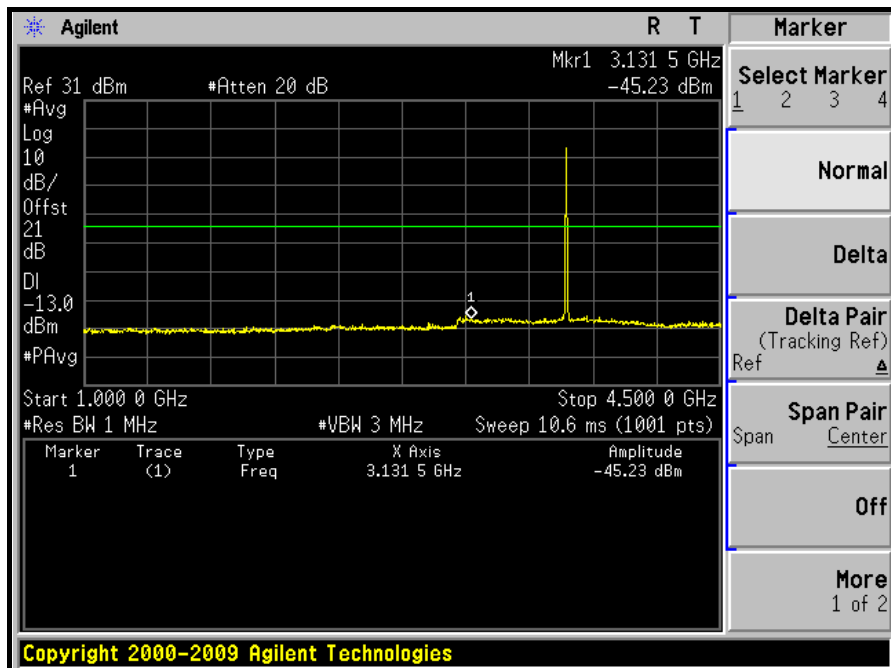



A D T

4.5GHz ~ 10GHz:

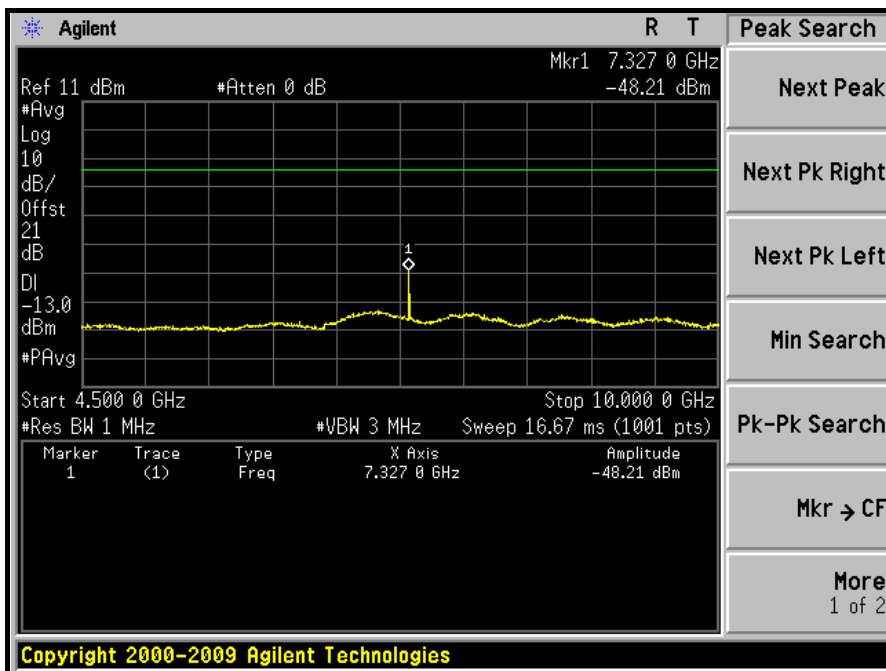

10GHz ~ 20GHz:

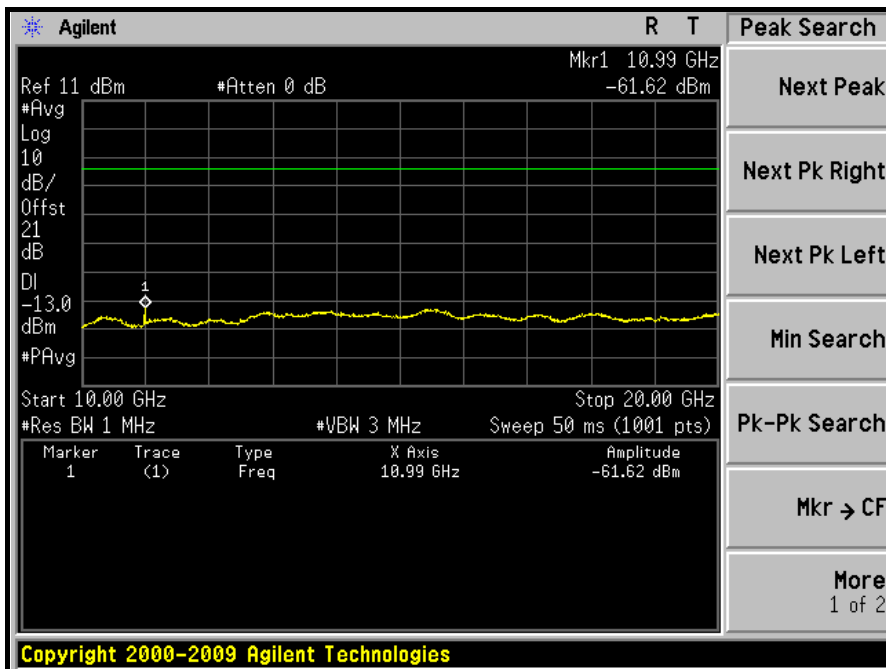



A D T

20GHz ~ 30GHz:

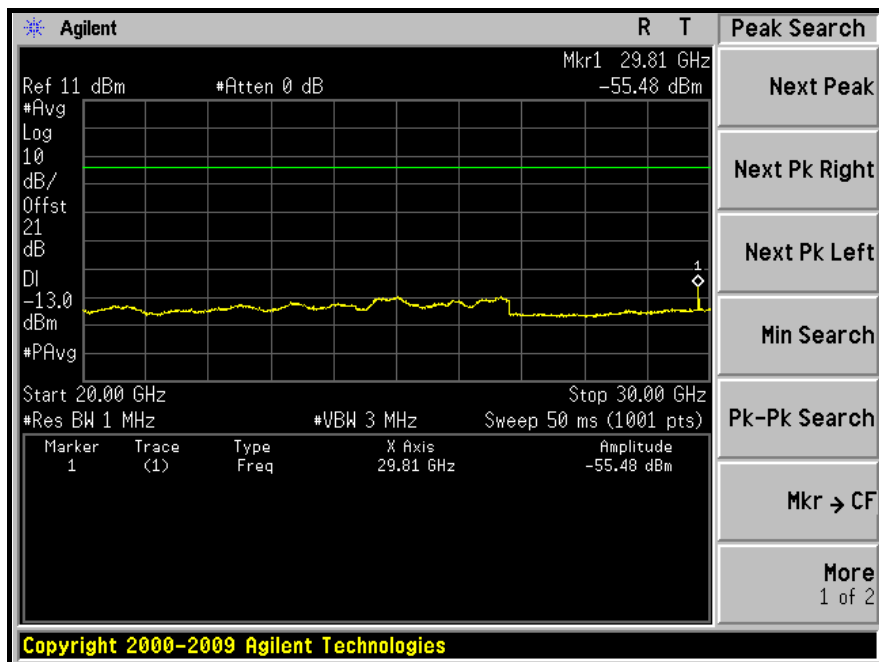

30GHz ~ 40GHz:

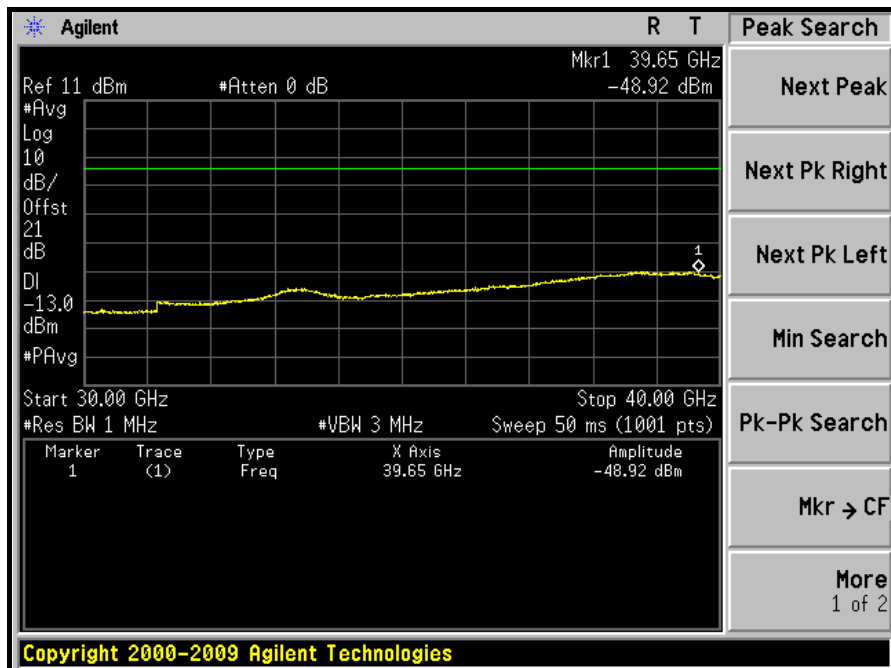



A D T

HIGH CHANNEL: 30MHz ~ 1GHz:

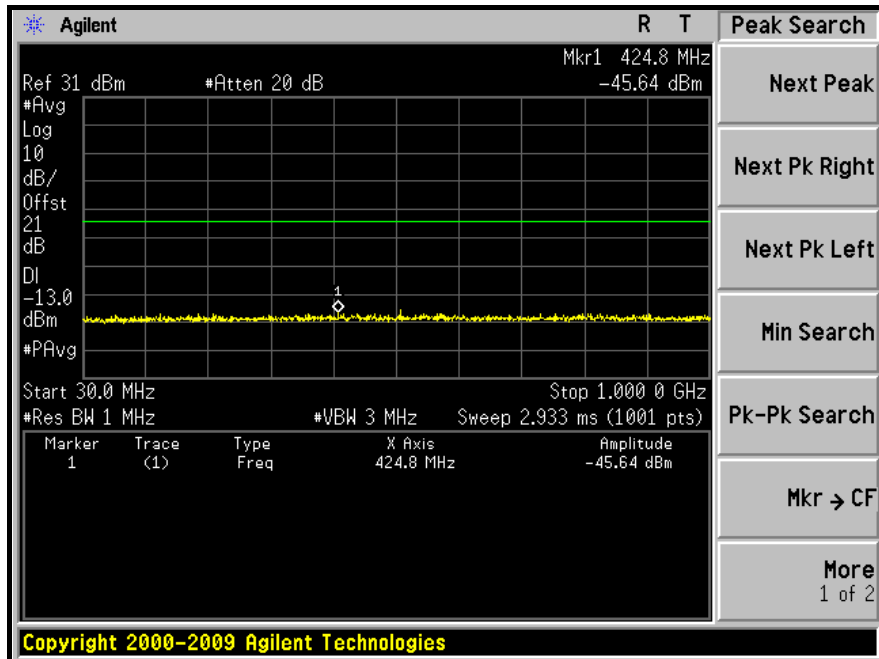

1GHz ~ 4.5GHz:

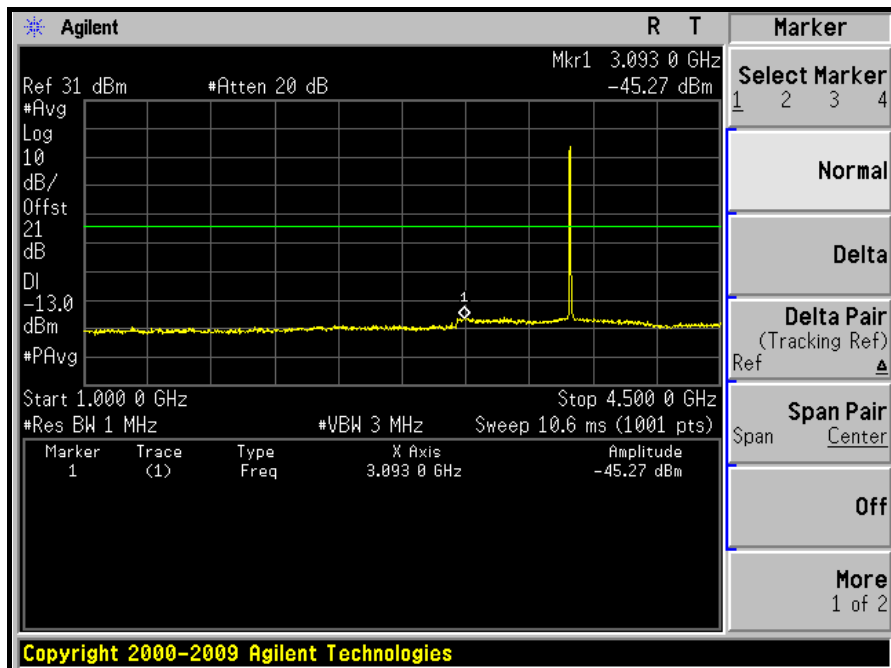



A D T

4.5GHz ~ 10GHz:

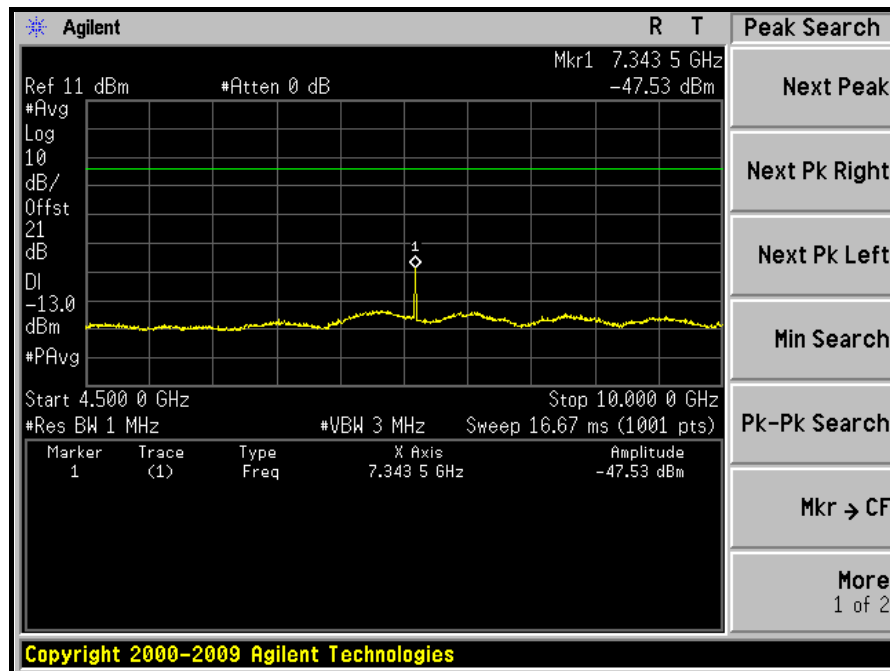

10GHz ~ 20GHz:

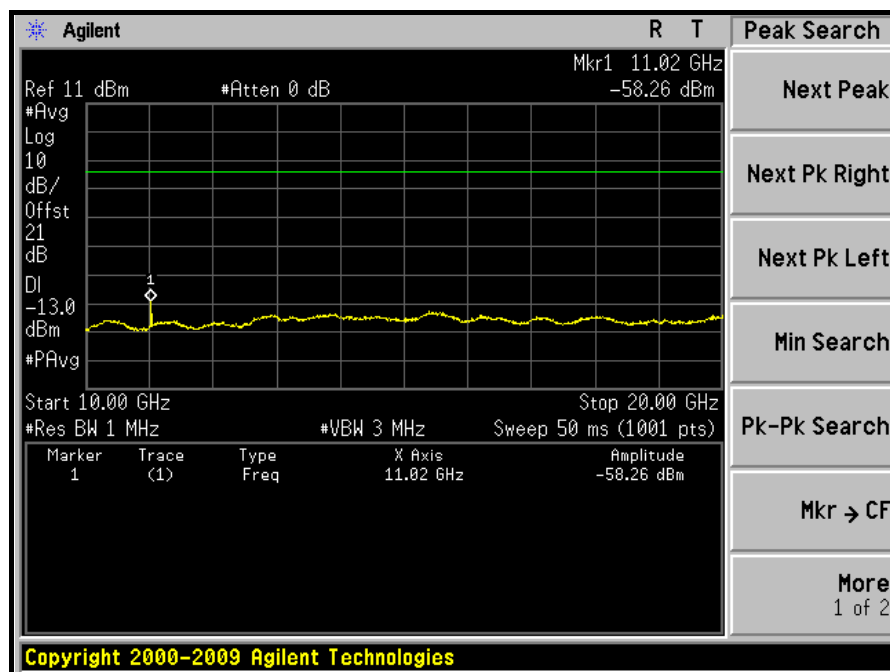



A D T

20GHz ~ 30GHz:

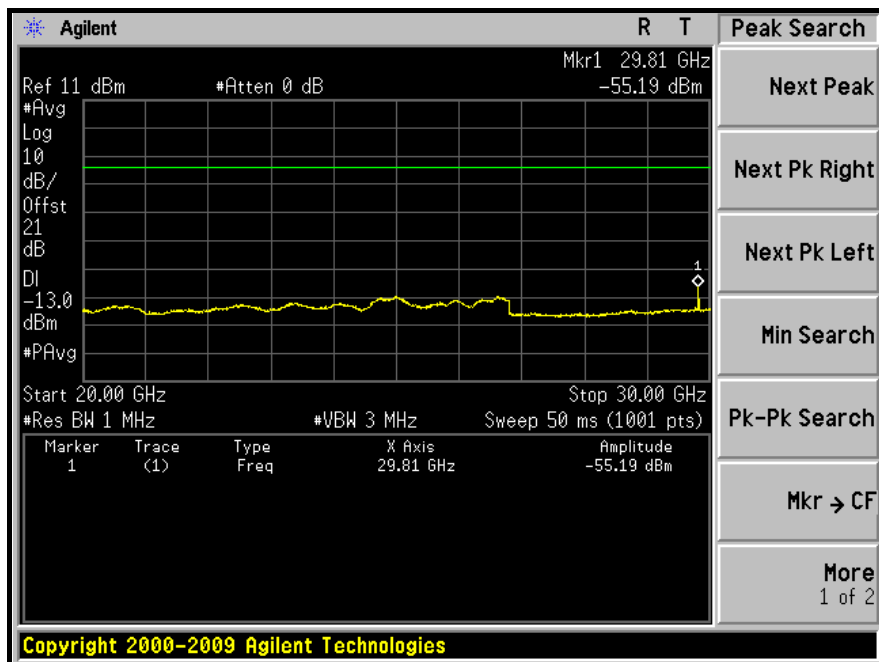

30GHz ~ 40GHz:

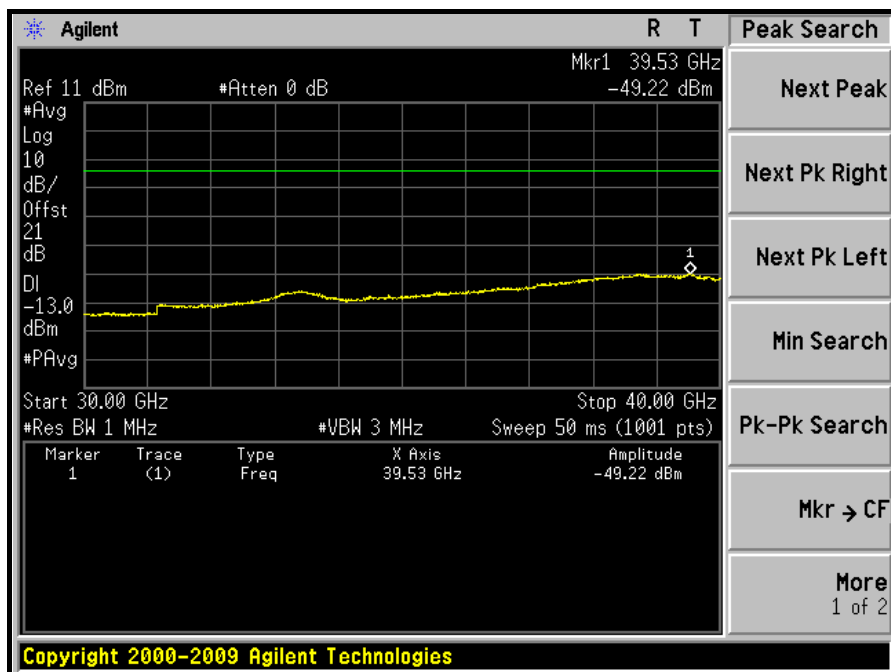



A D T

CHANNEL BANDWIDTH: 5MHz

LOW CHANNEL: 30MHz ~ 1GHz:

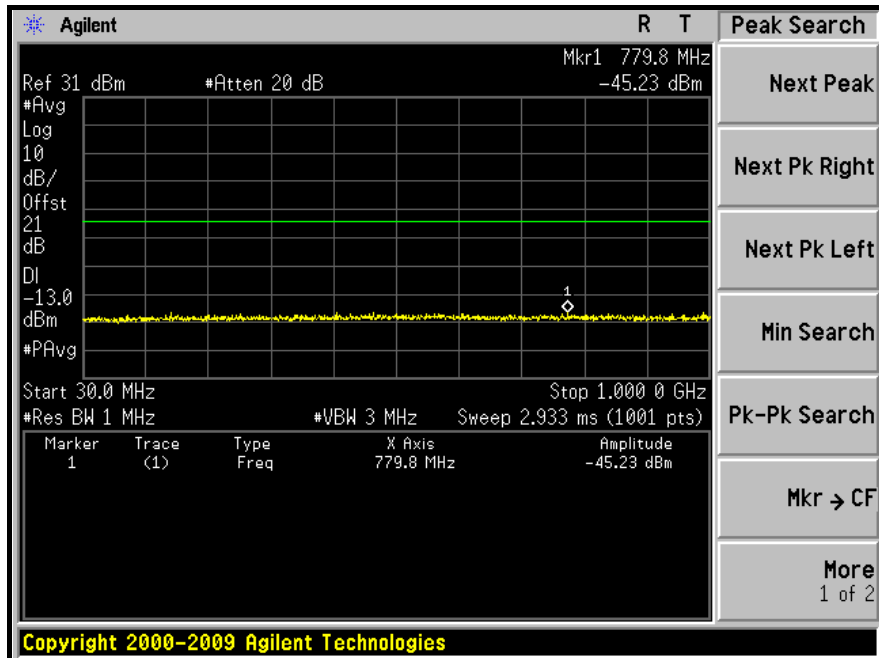

1GHz ~ 4.5GHz:

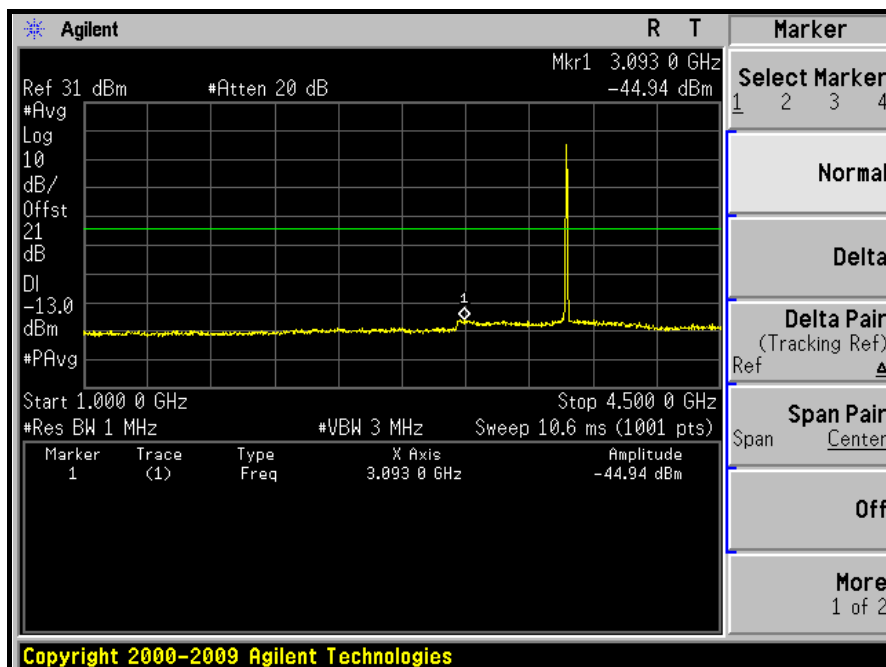



A D T

4.5GHz ~ 10GHz:

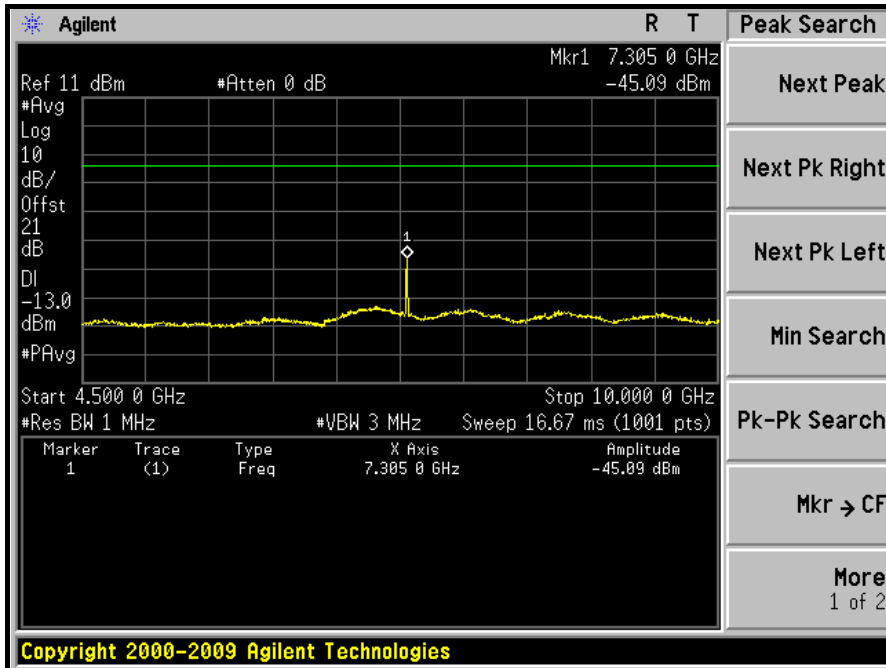

10GHz ~ 20GHz:

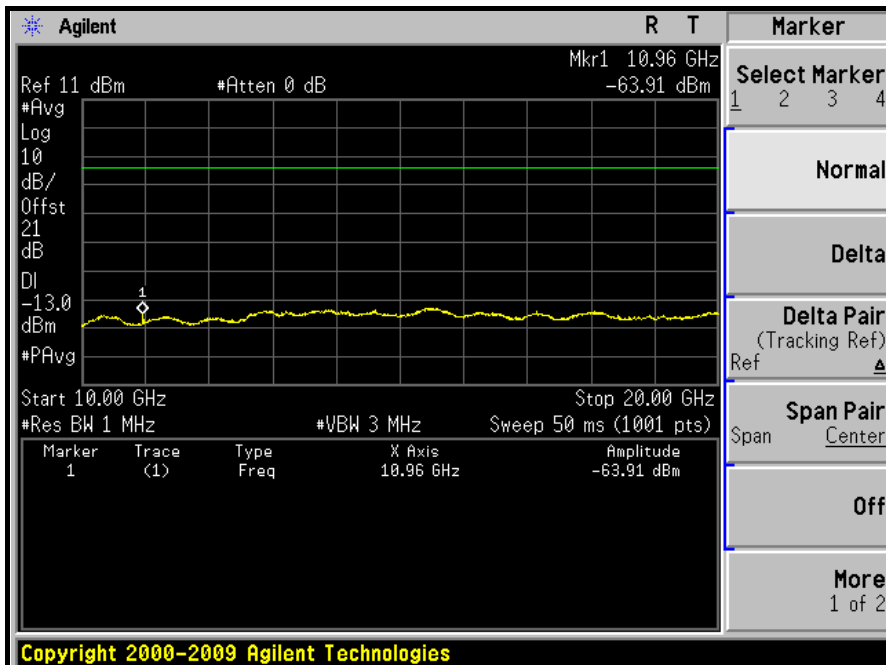



A D T

20GHz ~ 30GHz:

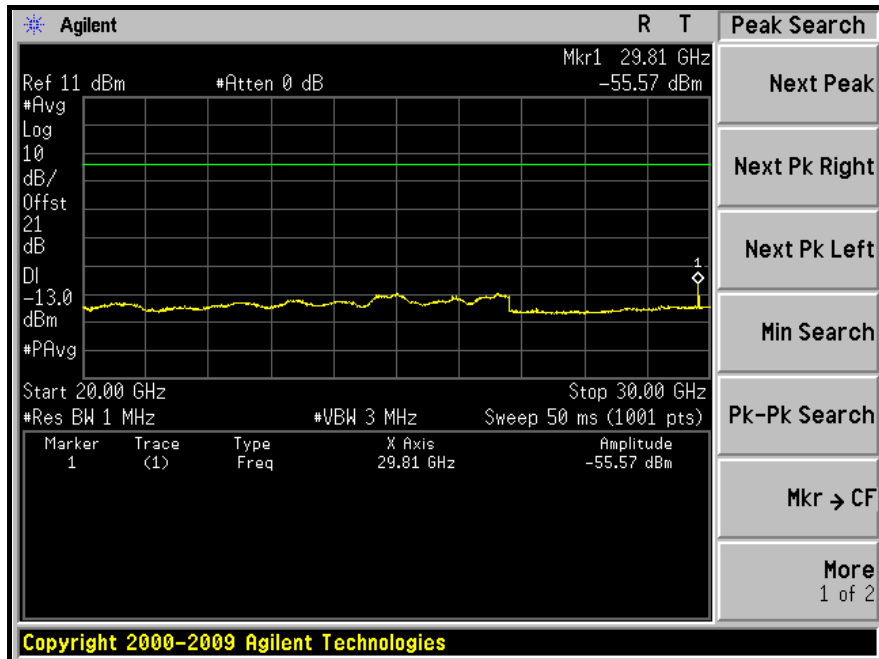

30GHz ~ 40GHz:

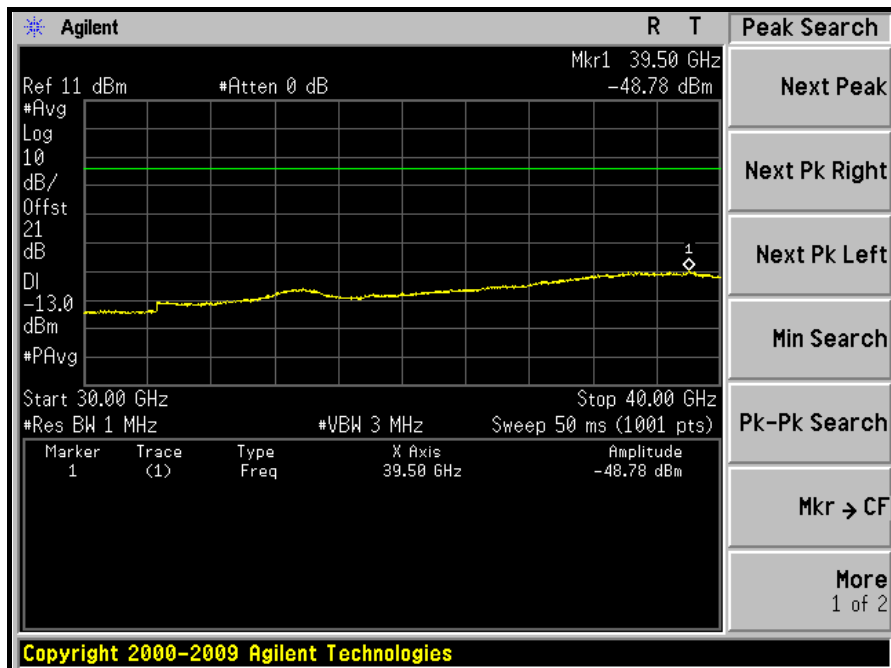



A D T

MIDDLE CHANNEL: 30MHz ~ 1GHz:

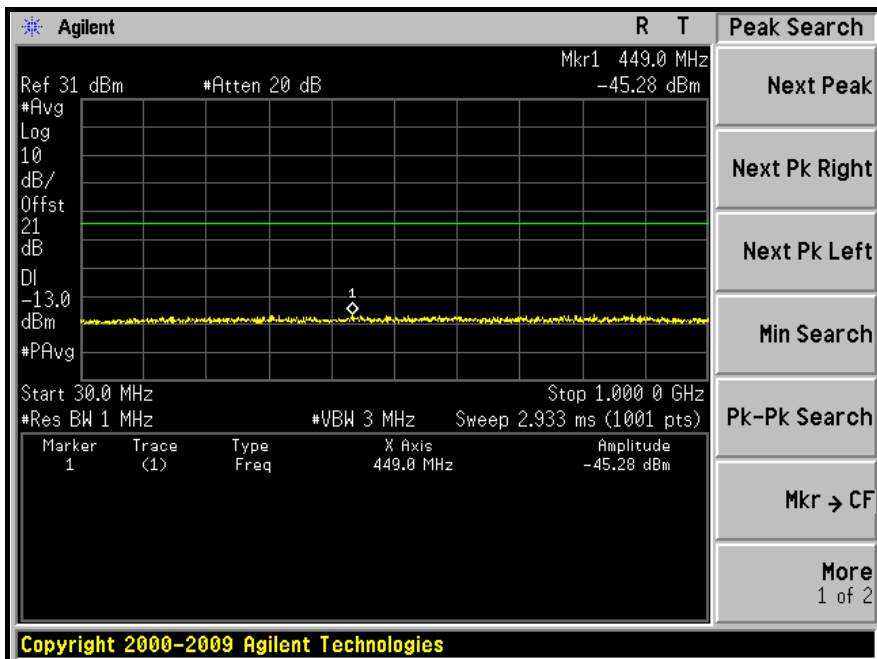

1GHz ~ 4.5GHz:

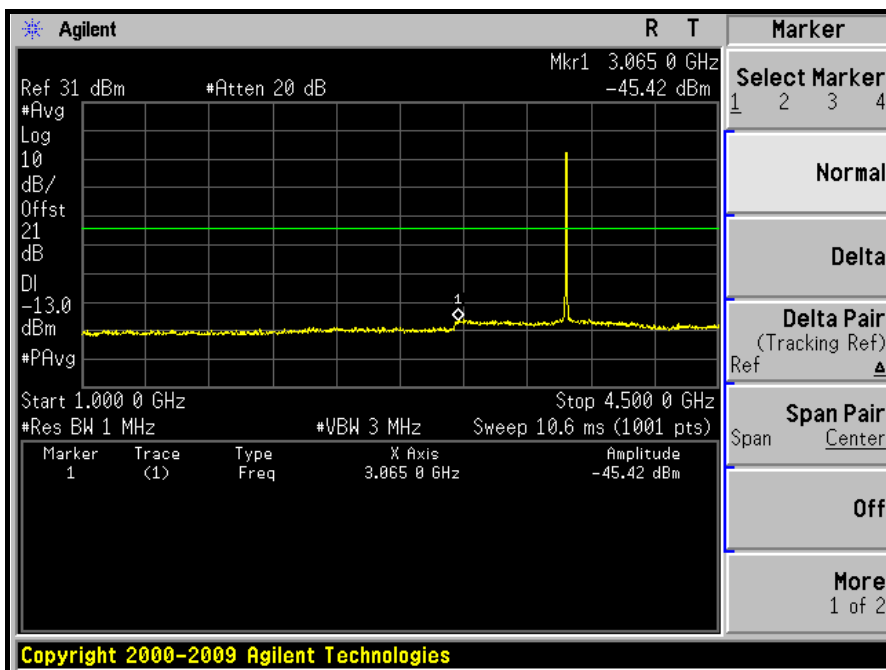



A D T

4.5GHz ~ 10GHz:

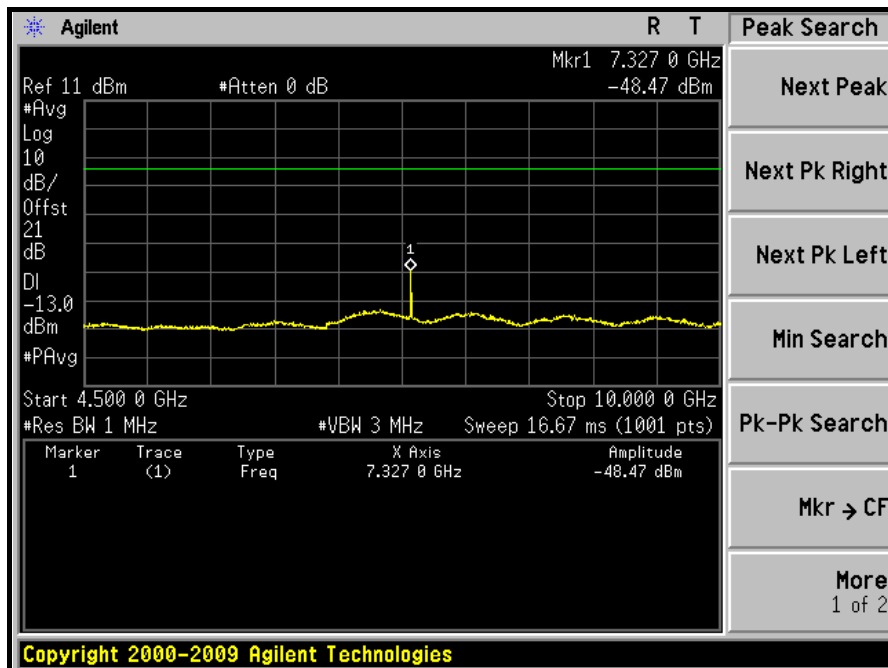

10GHz ~ 20GHz:

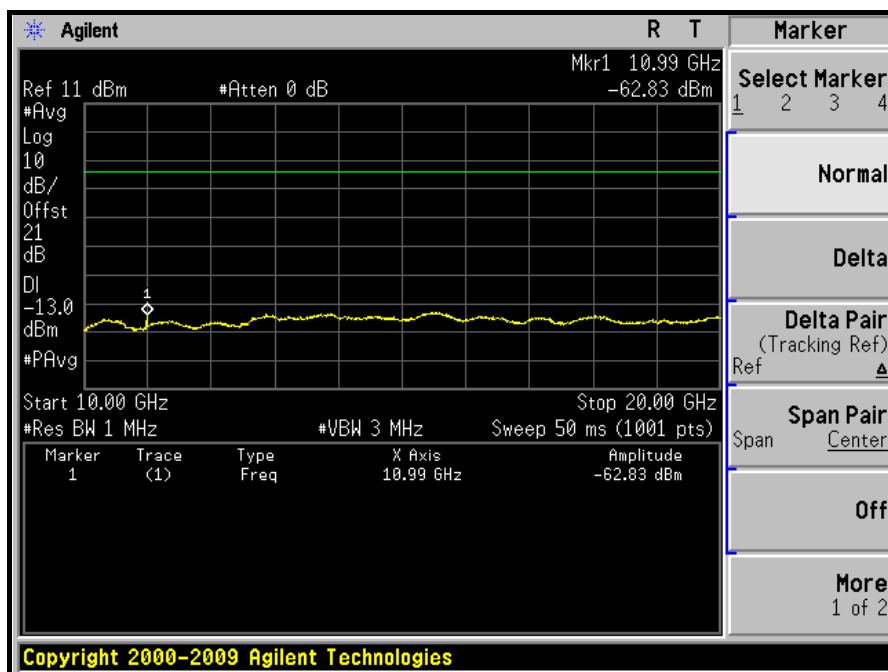



A D T

20GHz ~ 30GHz:

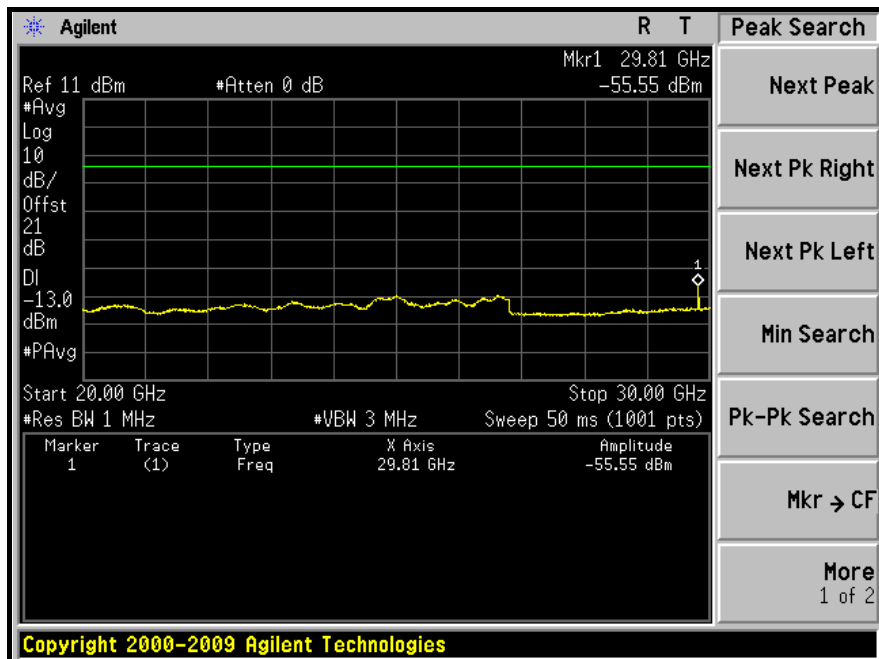

30GHz ~ 40GHz:

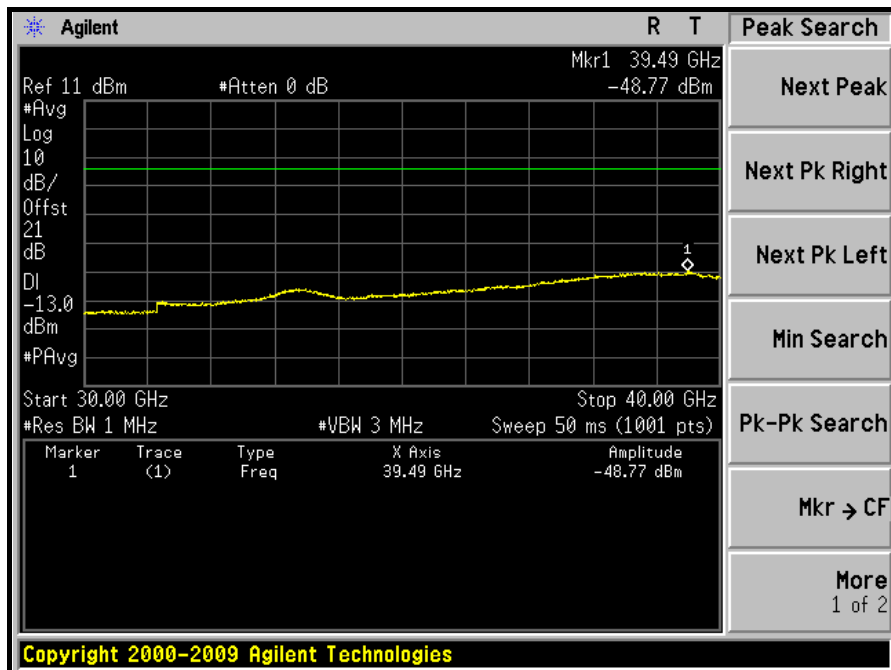



A D T

HIGH CHANNEL: 30MHz ~ 1GHz:

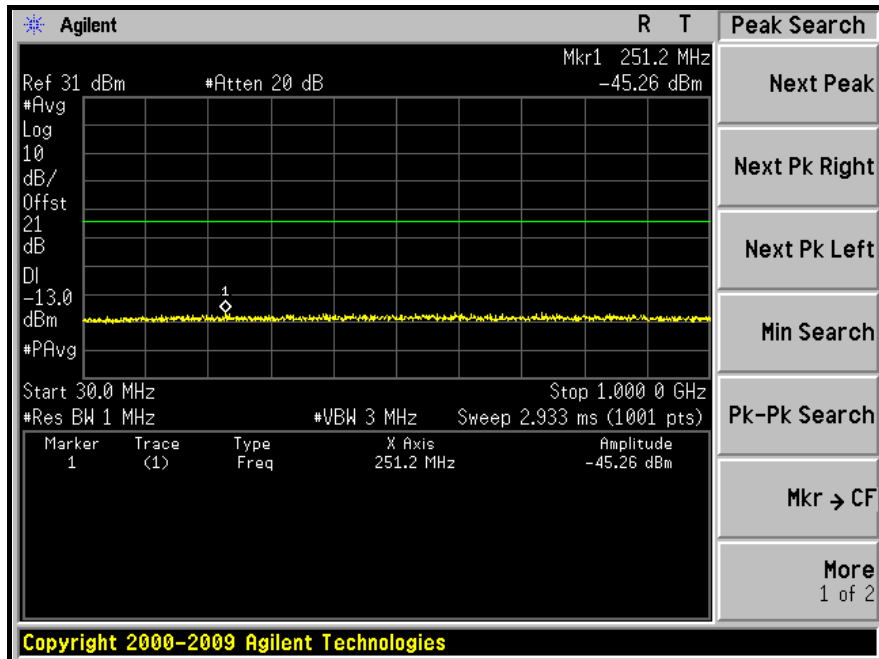

1GHz ~ 4.5GHz:

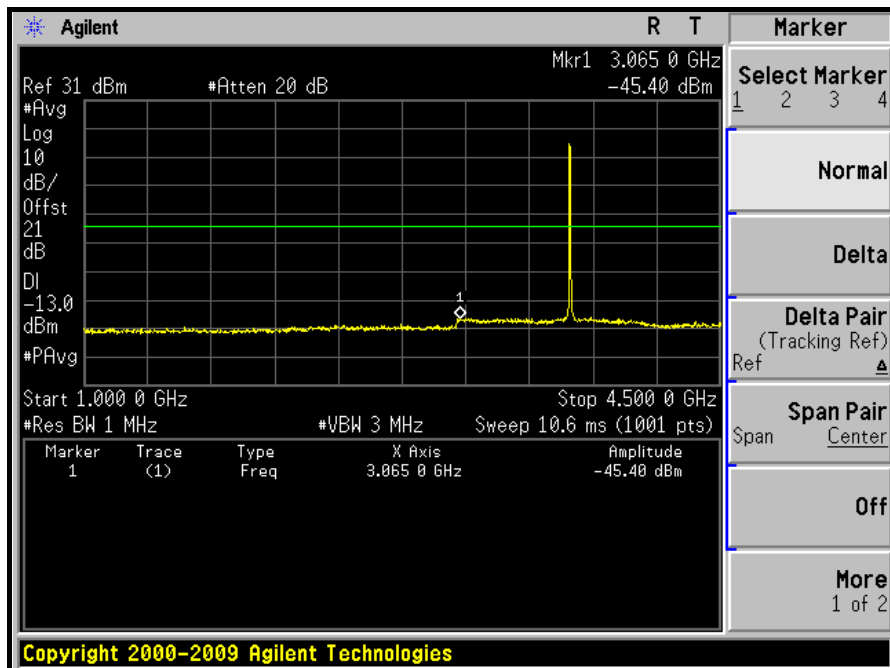



A D T

4.5GHz ~ 10GHz:

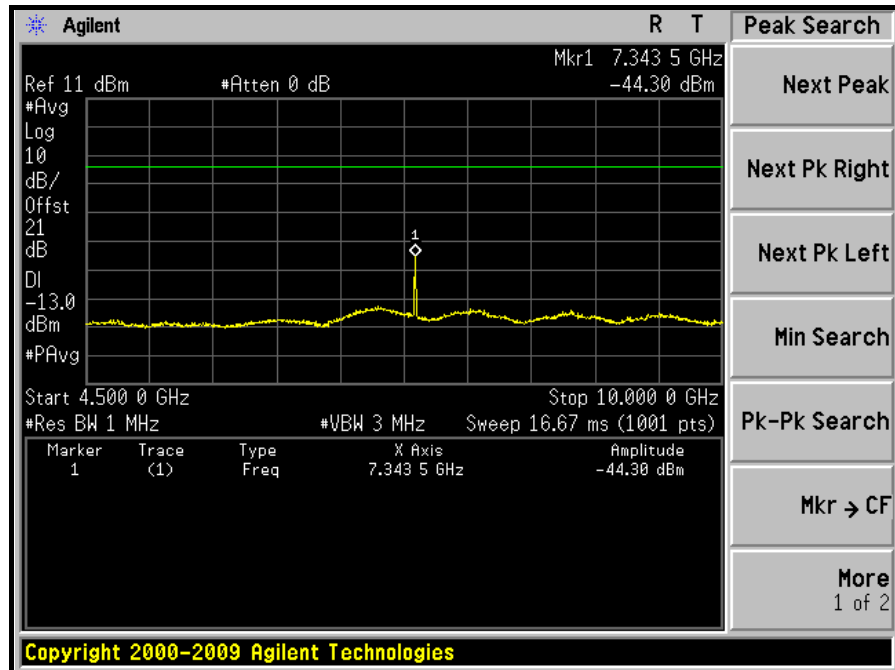

10GHz ~ 20GHz:

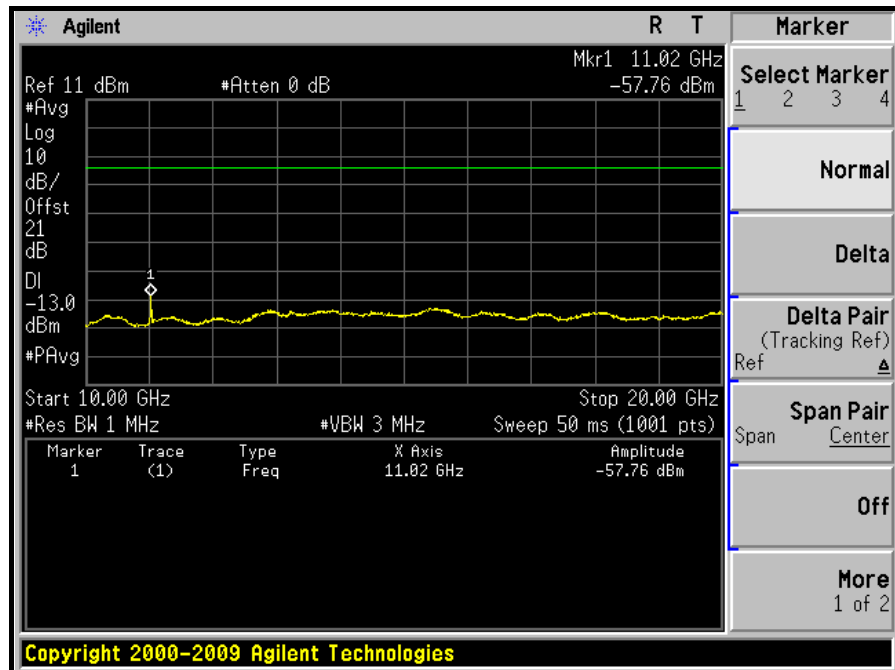



A D T

20GHz ~ 30GHz:

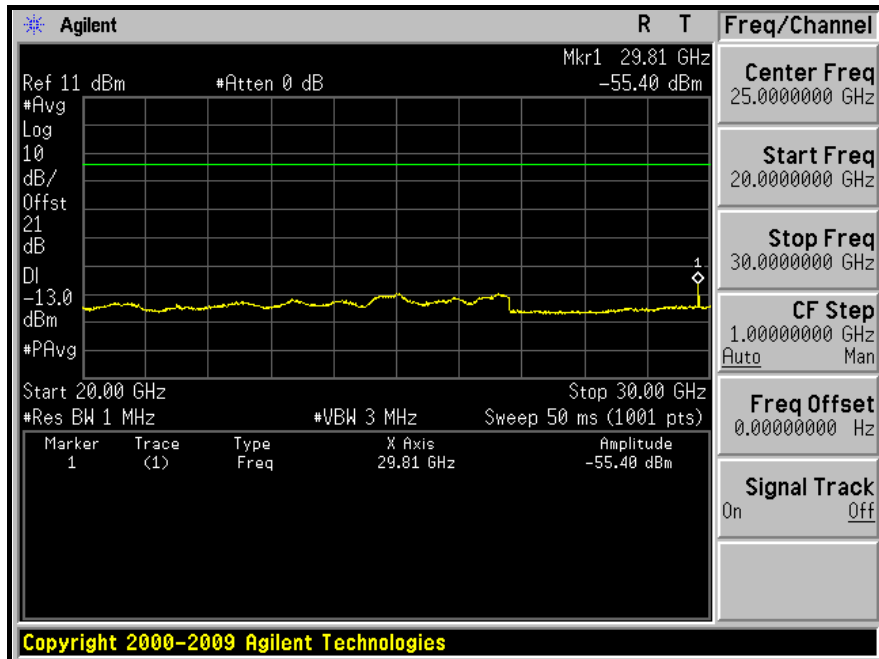

30GHz ~ 40GHz:

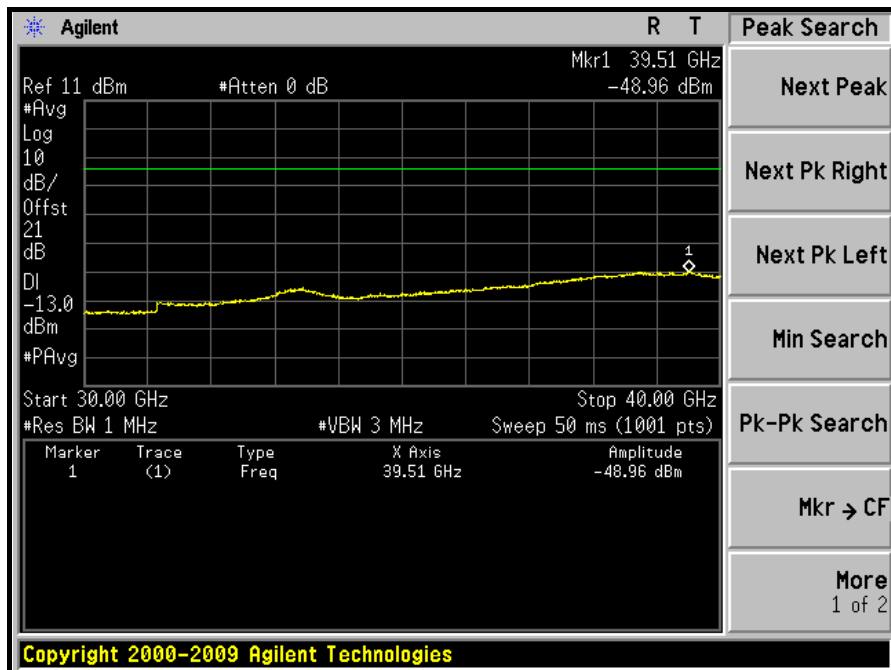



A D T

CHANNEL BANDWIDTH: 7MHz

LOW CHANNEL: 30MHz ~ 1GHz:

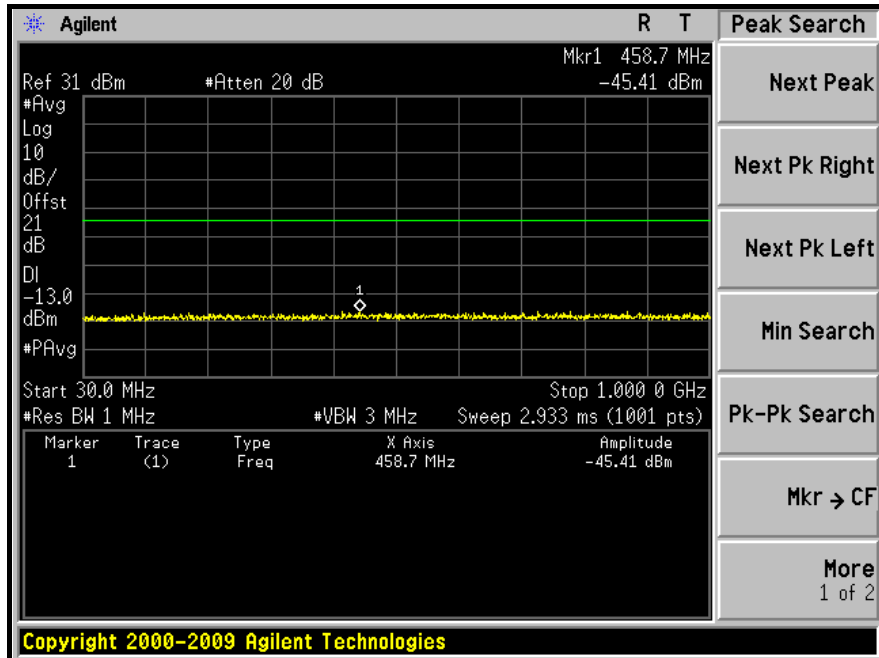

1GHz ~ 4.5GHz:

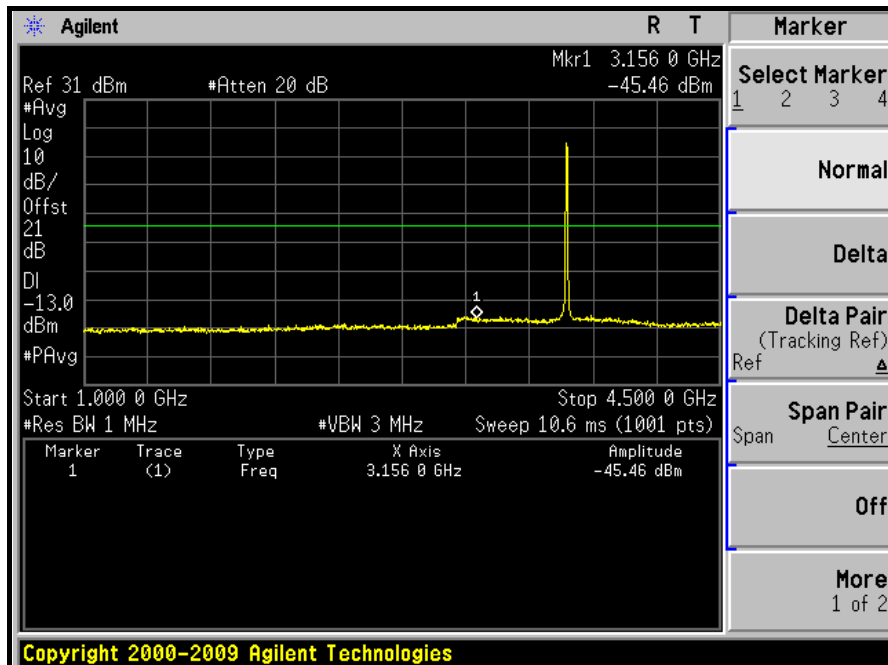



A D T

4.5GHz ~ 10GHz:

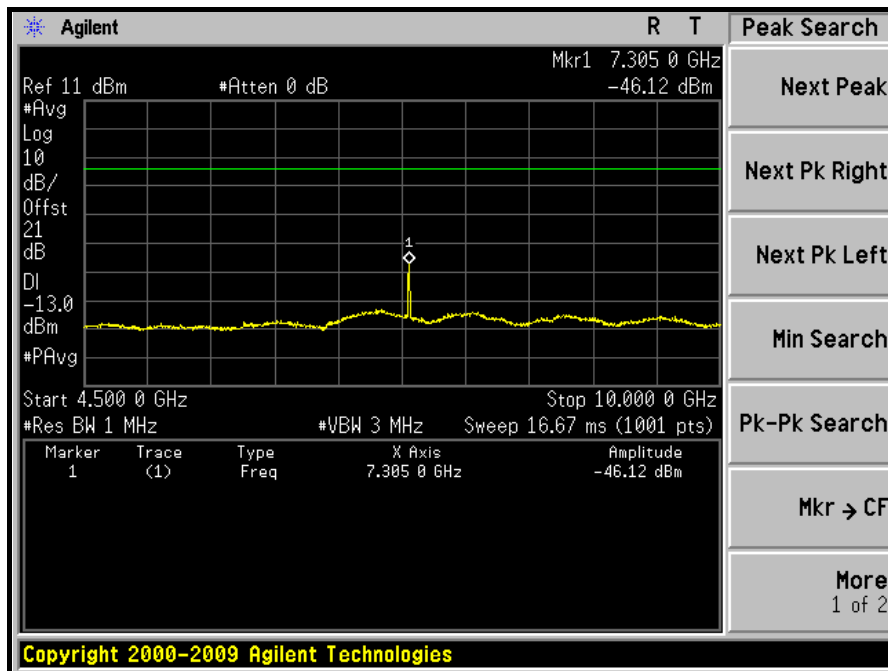

10GHz ~ 20GHz:

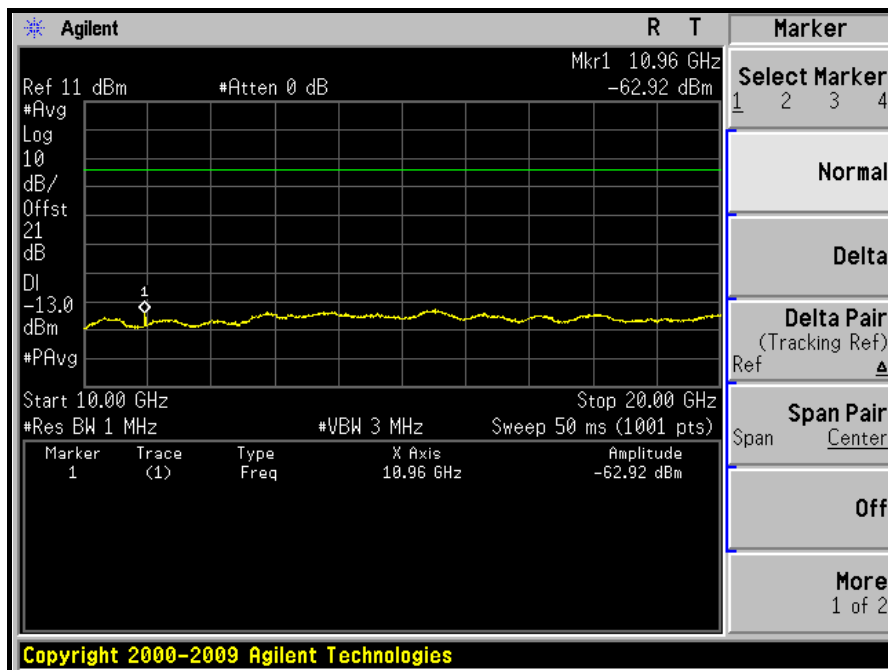



A D T

20GHz ~ 30GHz:

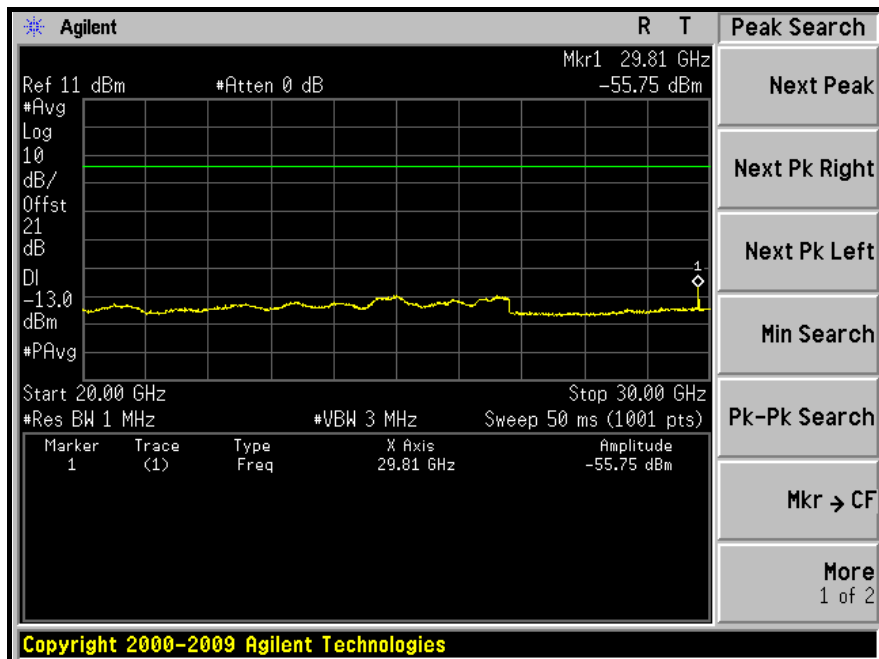

30GHz ~ 40GHz:

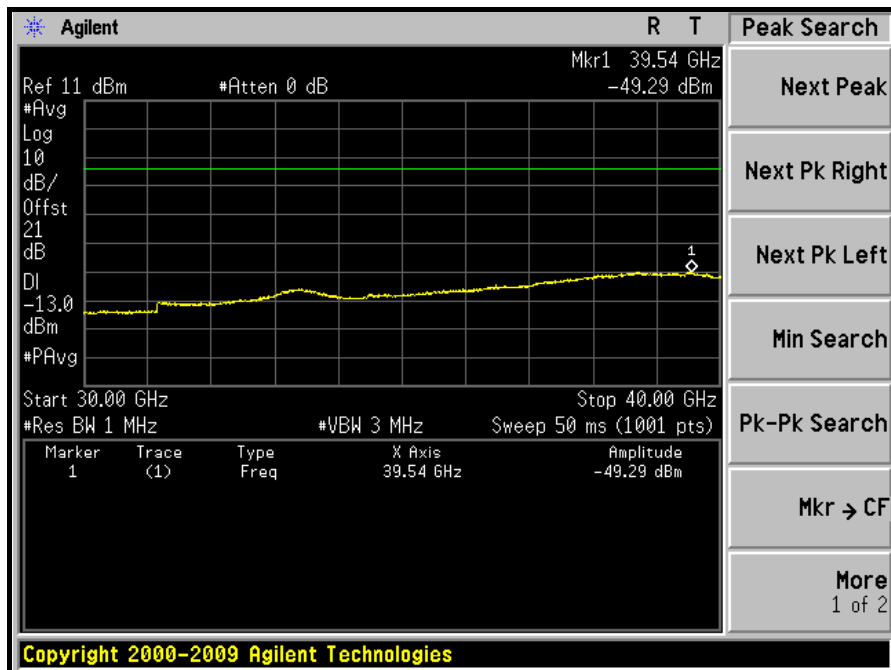



A D T

MIDDLE CHANNEL: 30MHz ~ 1GHz:

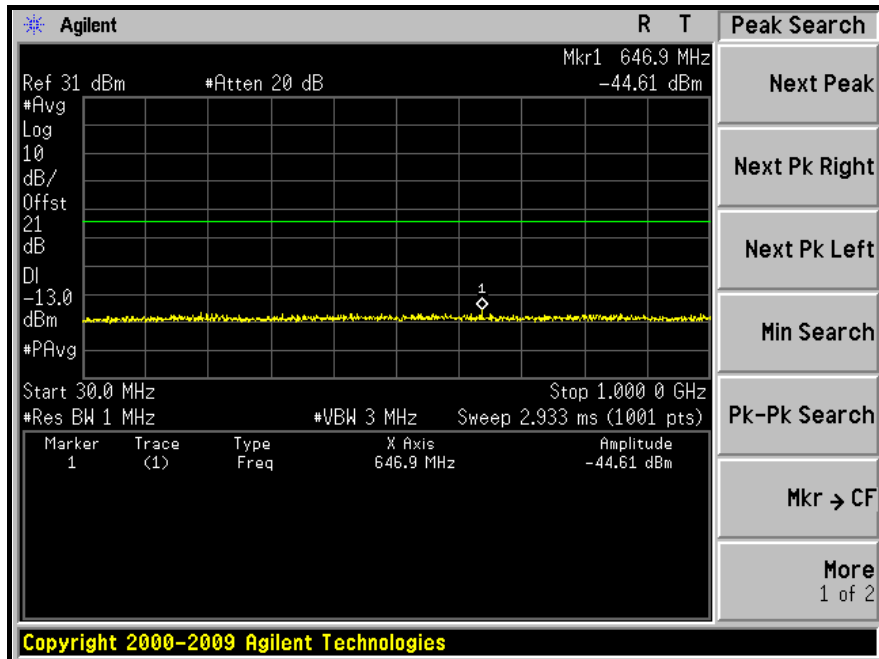

1GHz ~ 4.5GHz:

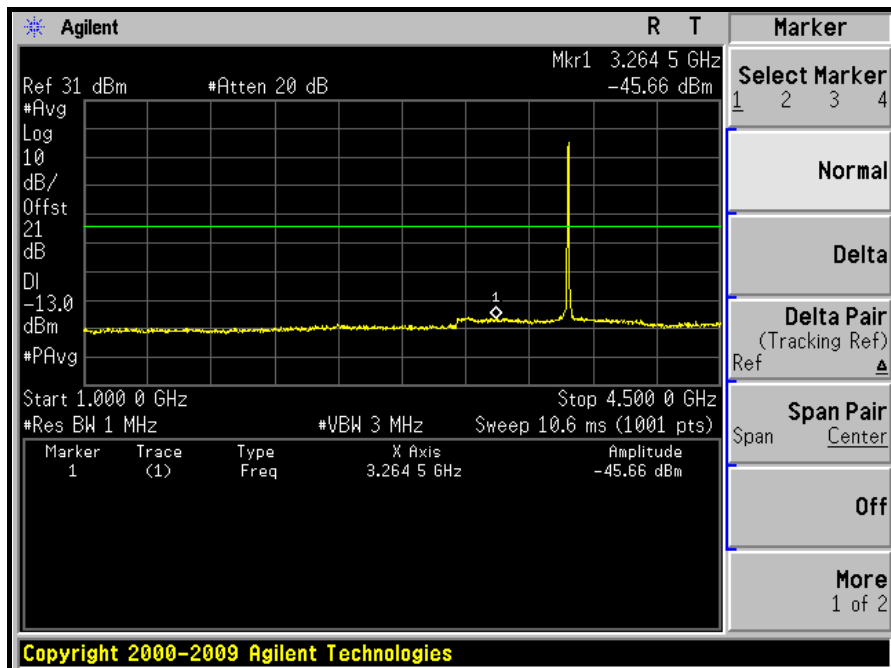



A D T

4.5GHz ~ 10GHz:

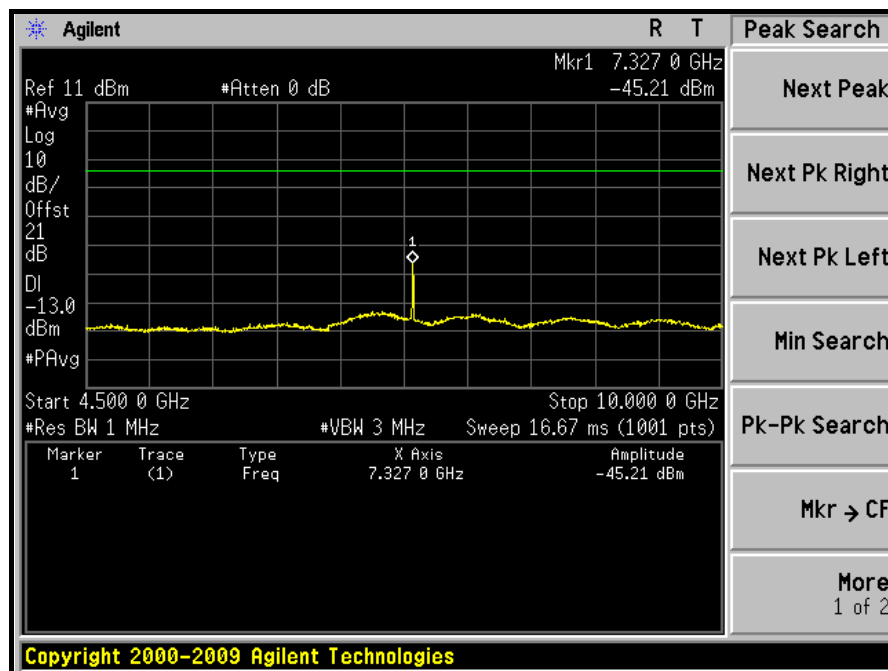

10GHz ~ 20GHz:

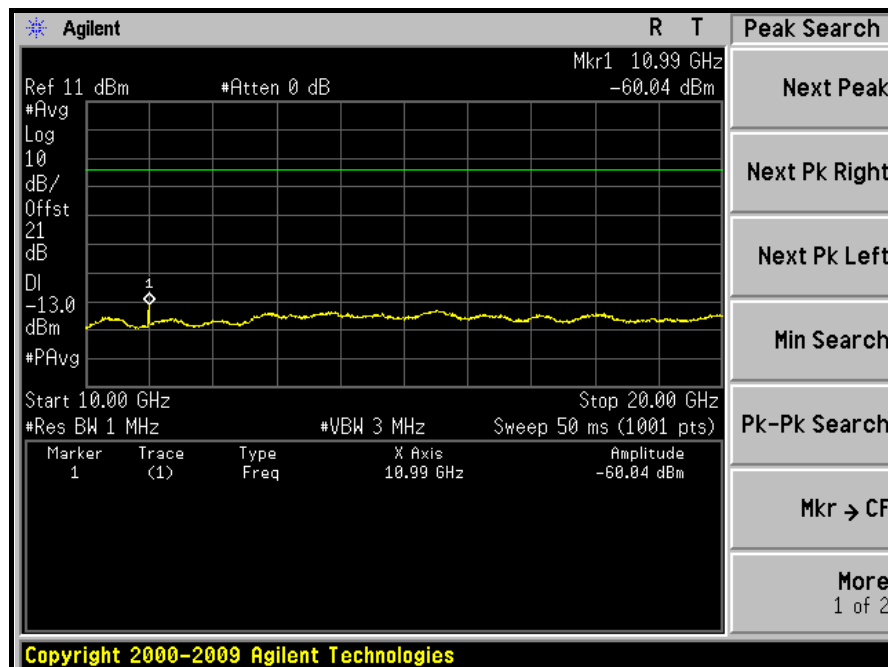

20GHz ~ 30GHz:

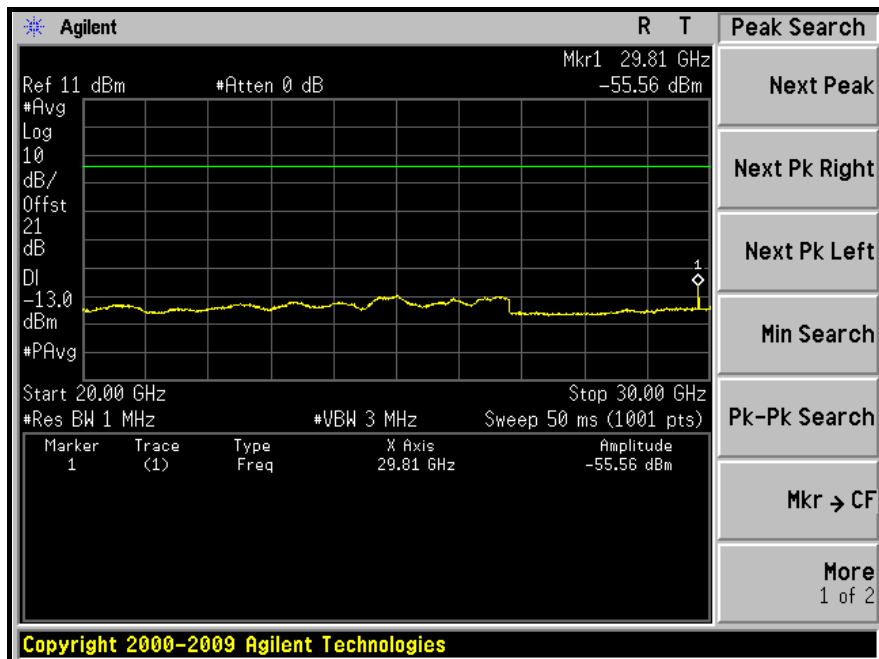

30GHz ~ 40GHz:

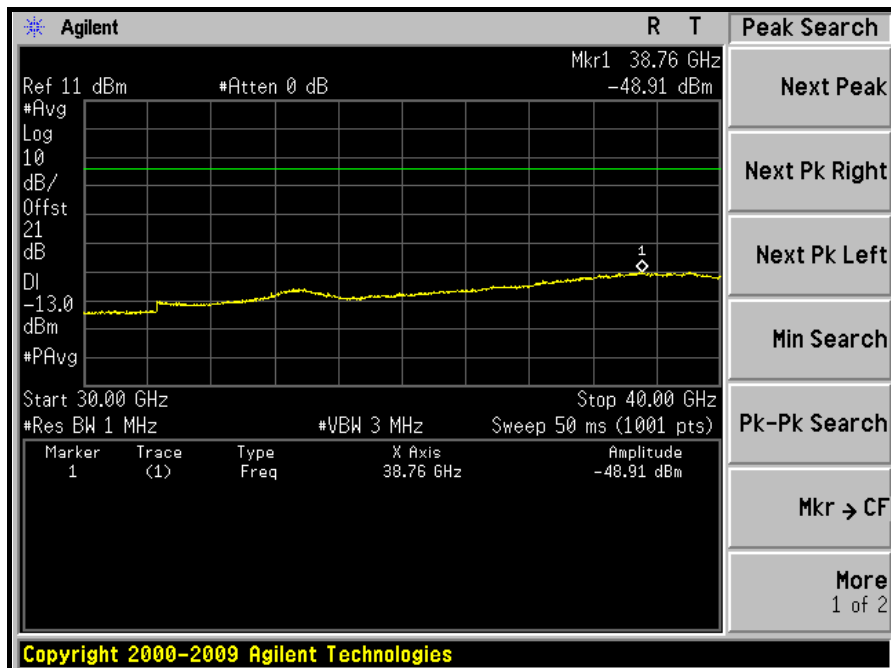



A D T

HIGH CHANNEL: 30MHz ~ 1GHz:

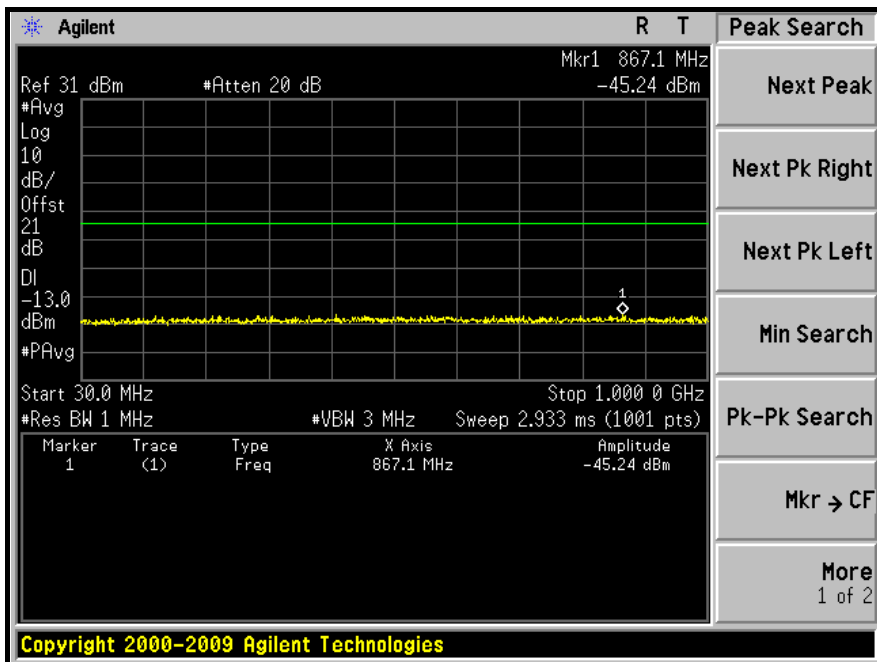

1GHz ~ 4.5GHz:

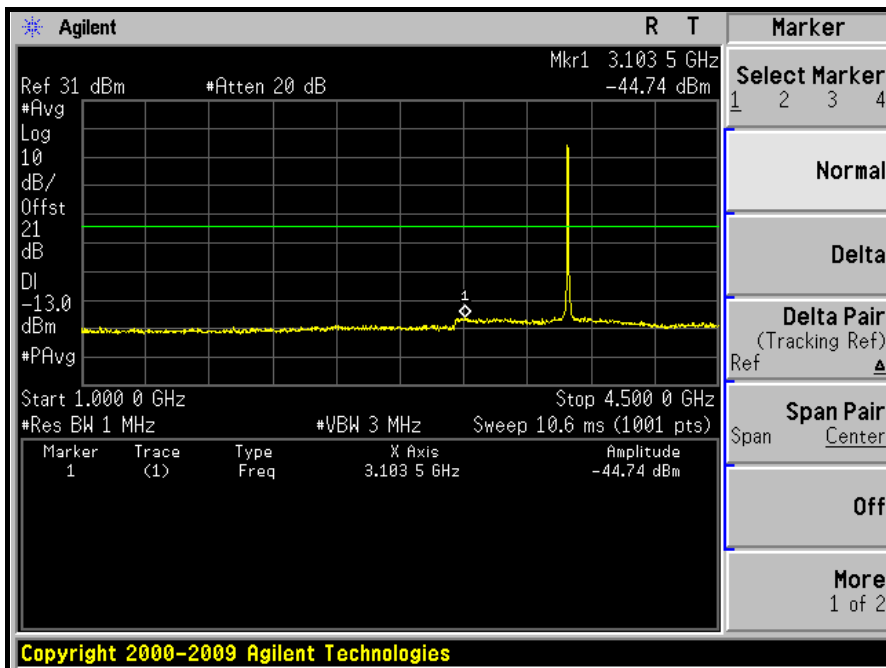



A D T

4.5GHz ~ 10GHz:

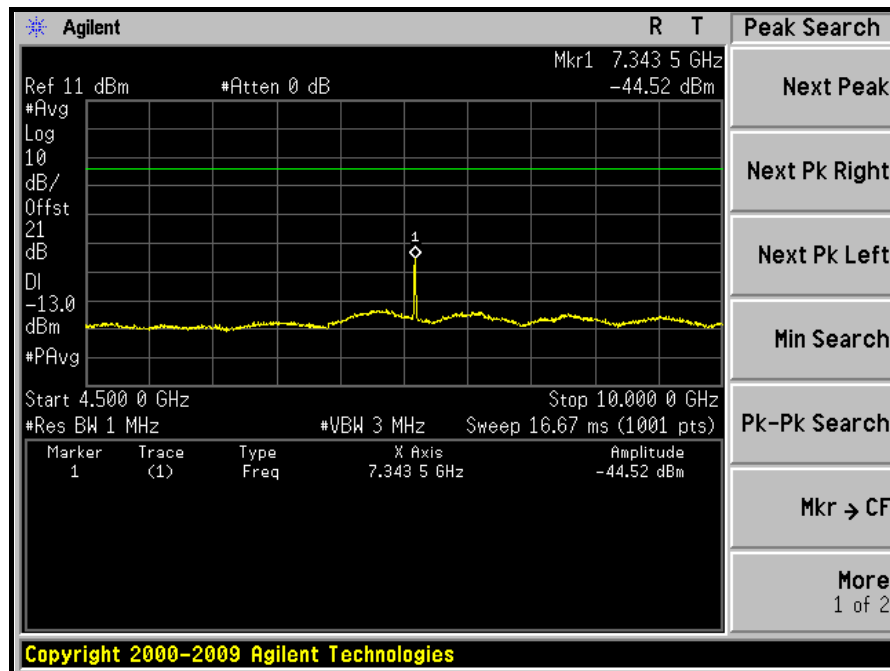

10GHz ~ 20GHz:

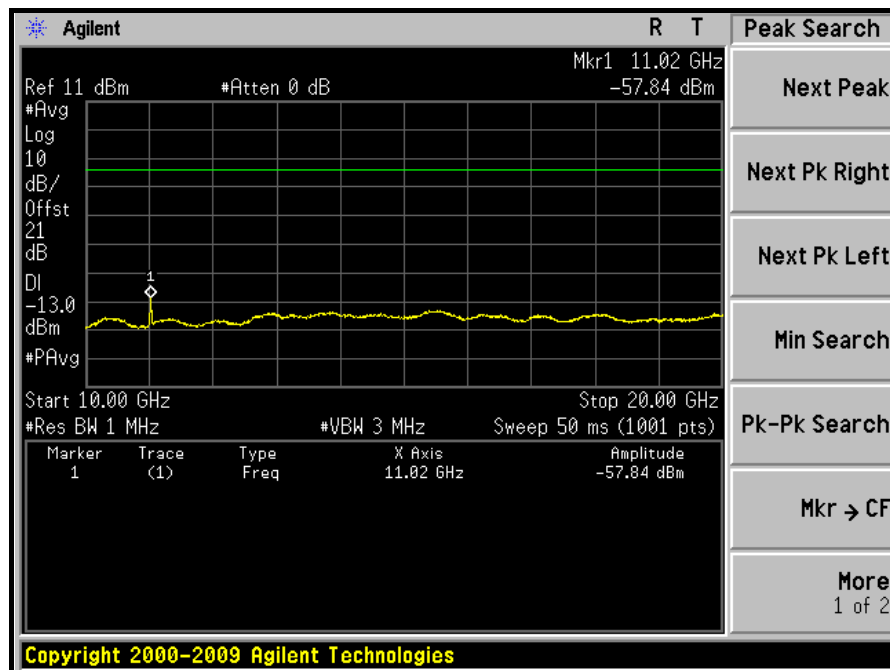



A D T

20GHz ~ 30GHz:

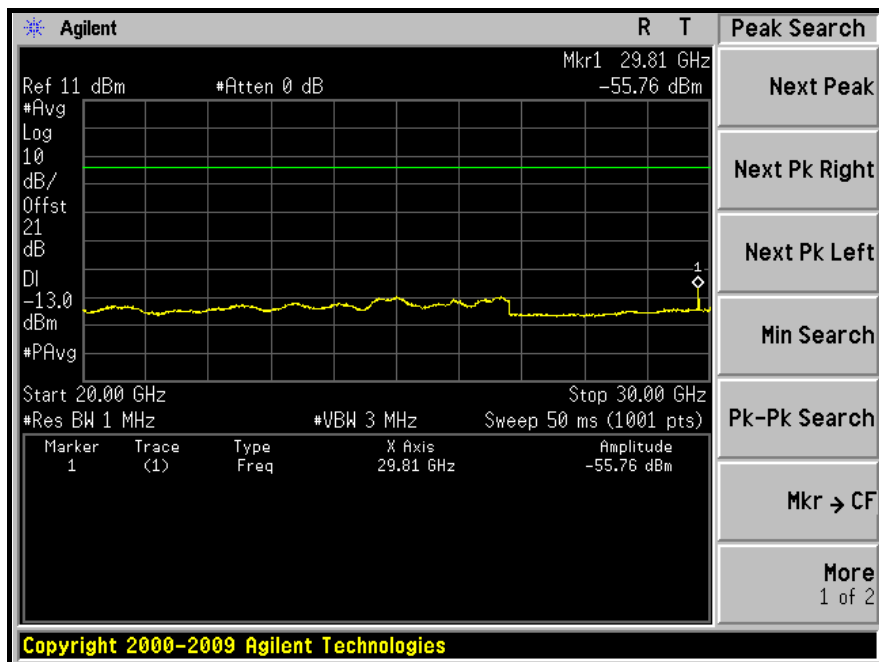

30GHz ~ 40GHz:

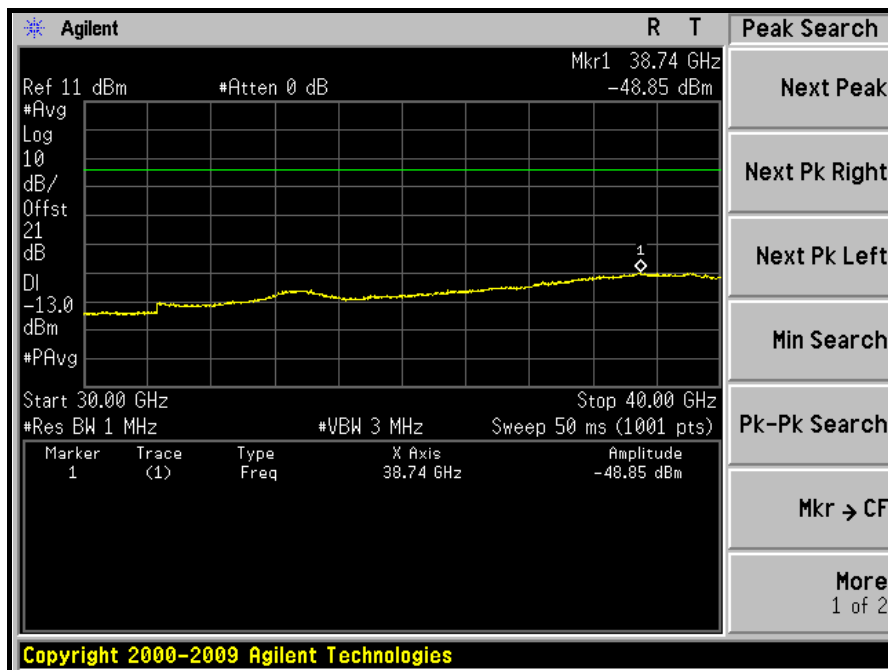



A D T

CHANNEL BANDWIDTH: 10MHz

LOW CHANNEL: 30MHz ~ 1GHz:

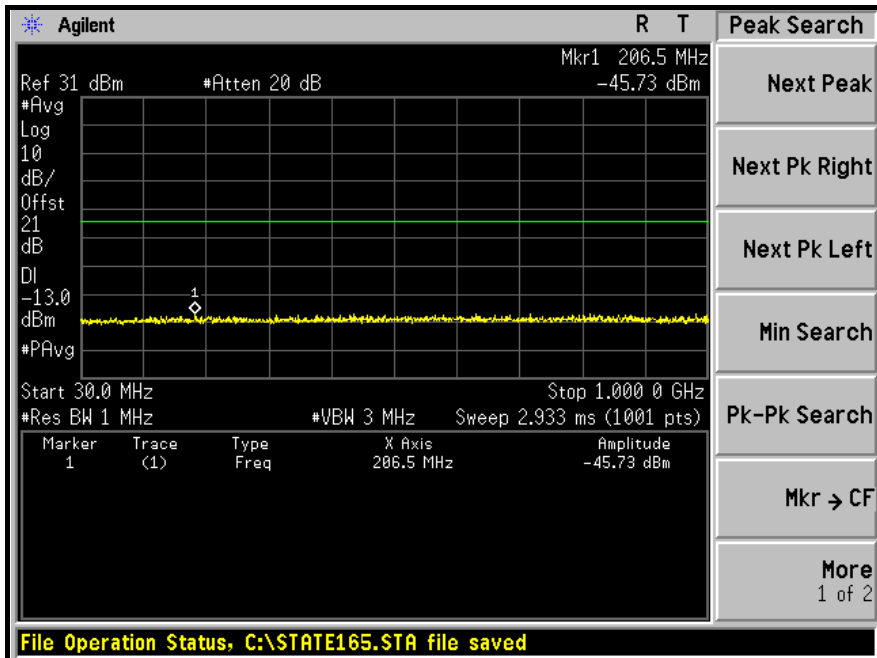

1GHz ~ 4.5GHz:

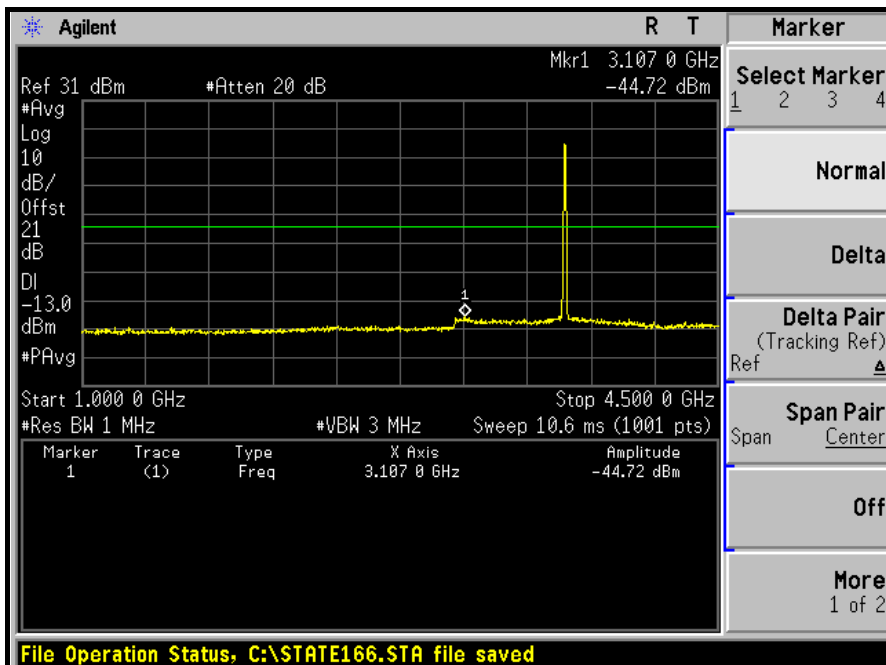



A D T

4.5GHz ~ 10GHz:

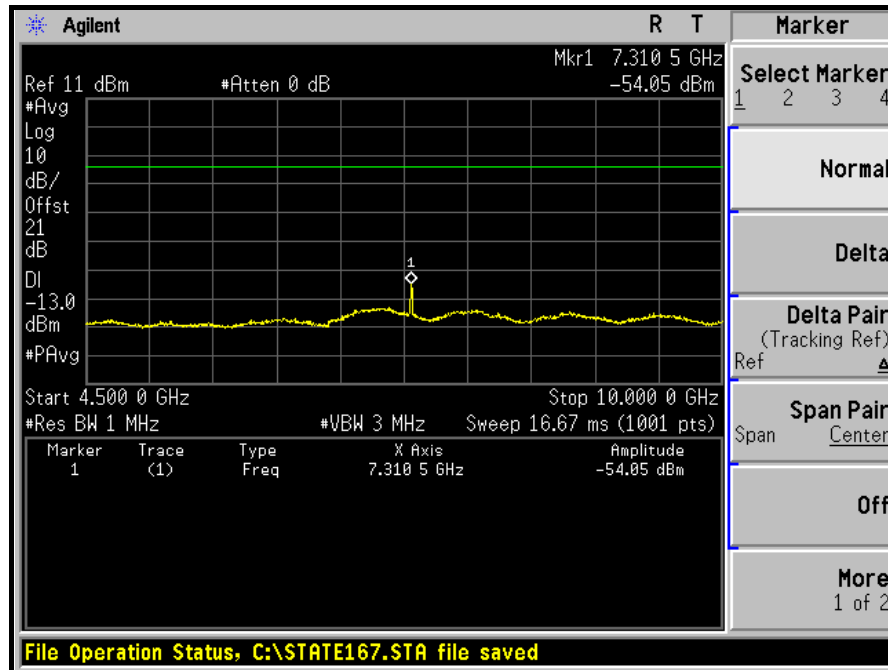

10GHz ~ 20GHz:

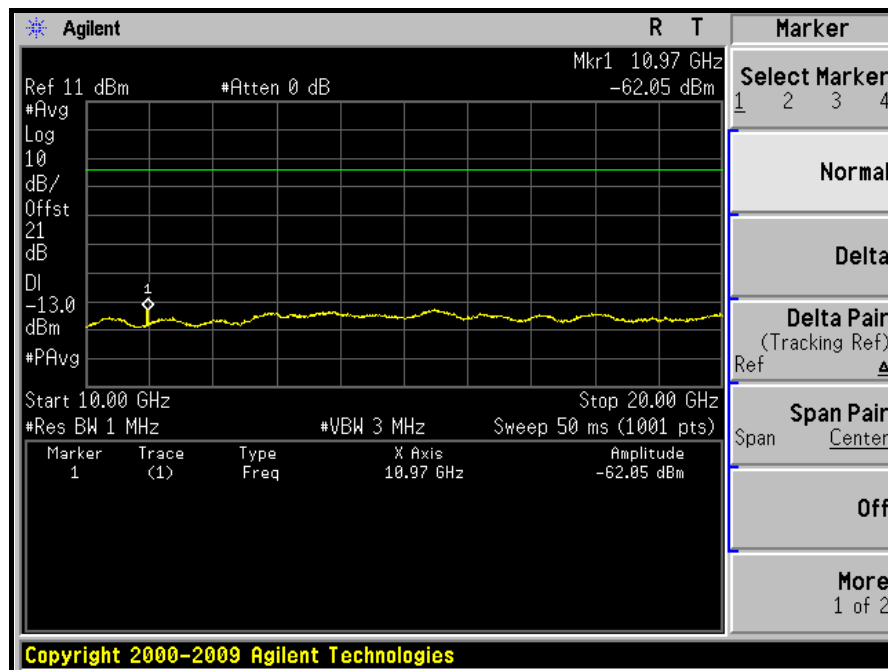



A D T

20GHz ~ 30GHz:

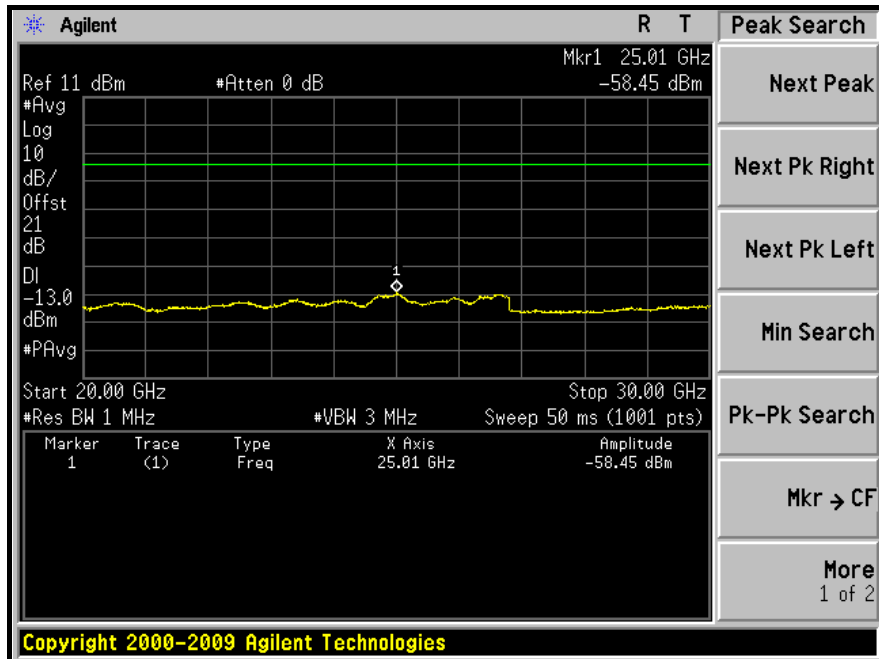

30GHz ~ 40GHz:

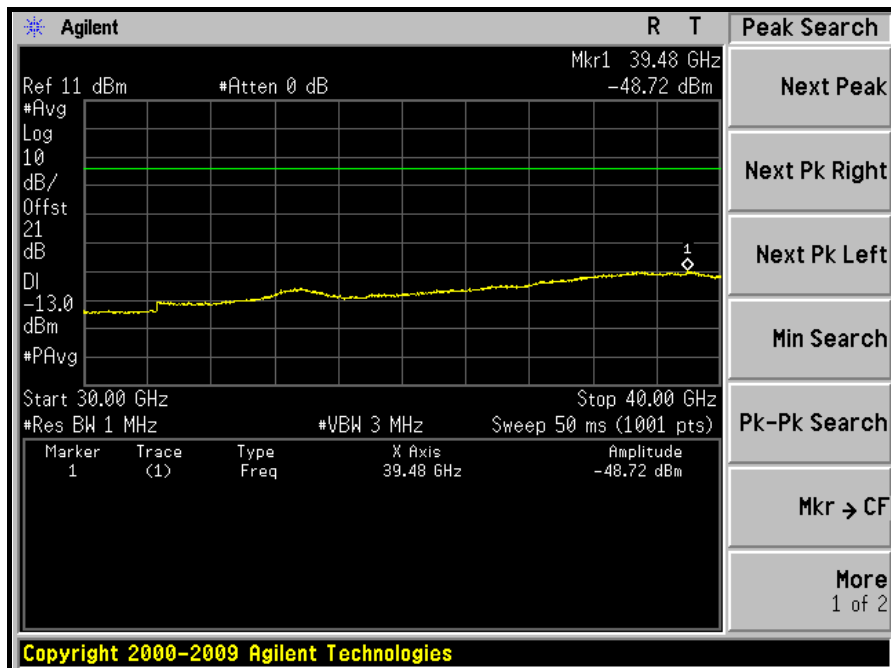



A D T

MIDDLE CHANNEL: 30MHz ~ 1GHz:

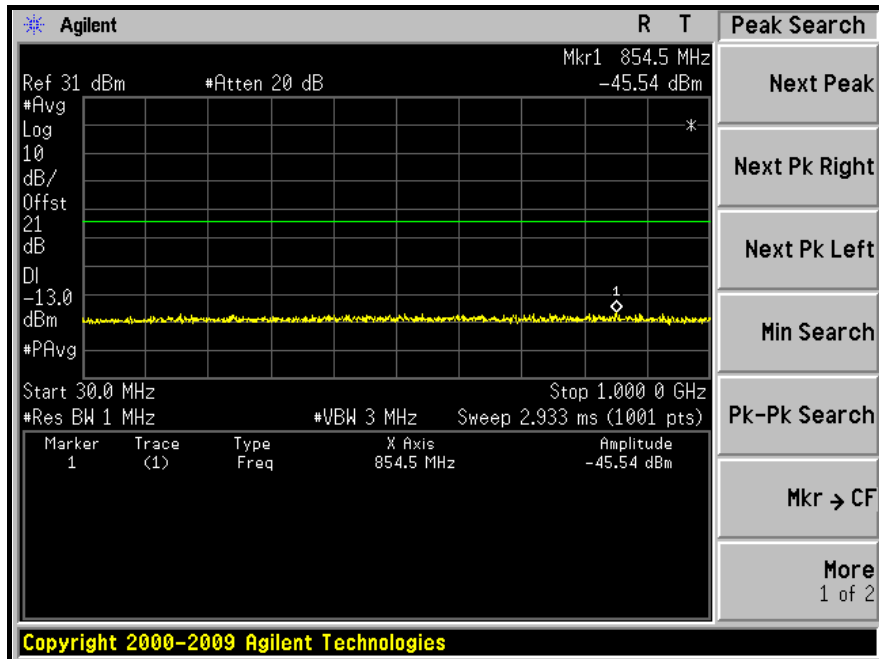

1GHz ~ 4.5GHz:

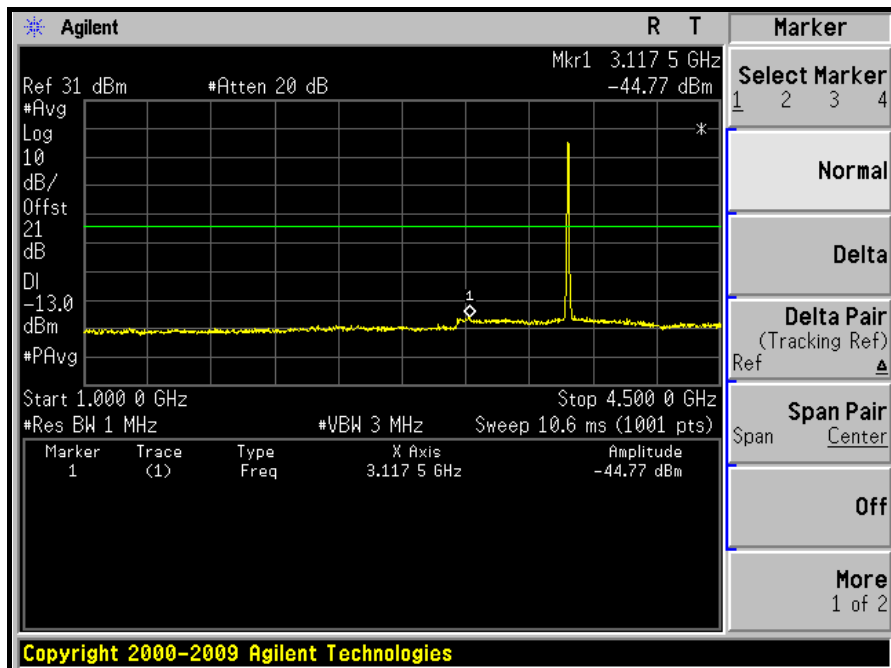



A D T

4.5GHz ~ 10GHz:

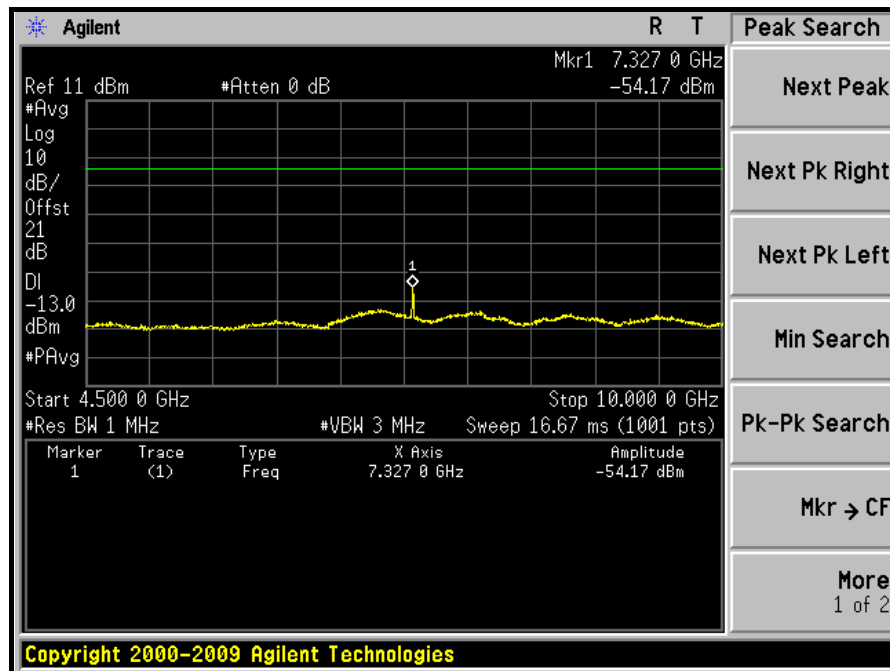

10GHz ~ 20GHz:

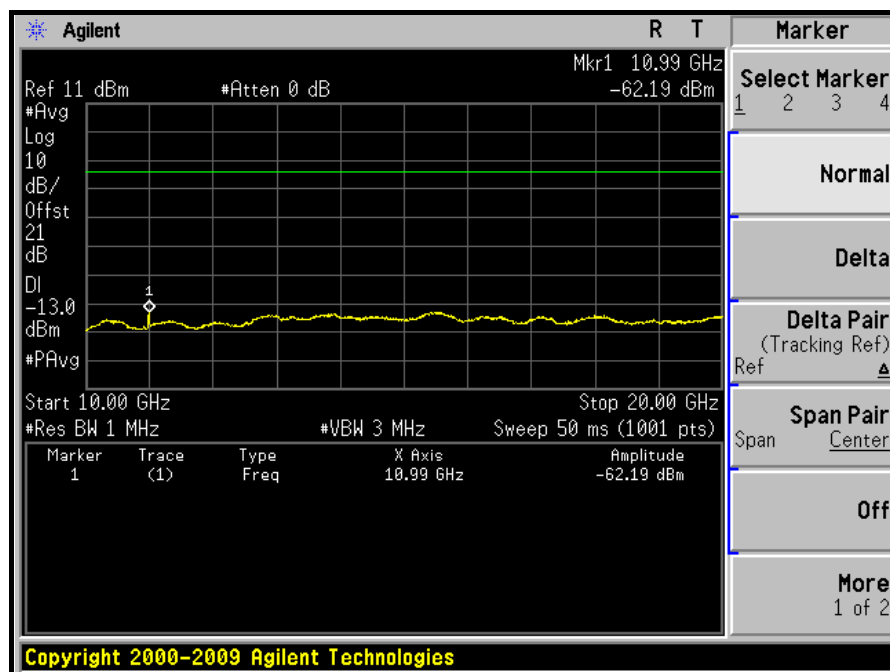



A D T

20GHz ~ 30GHz:

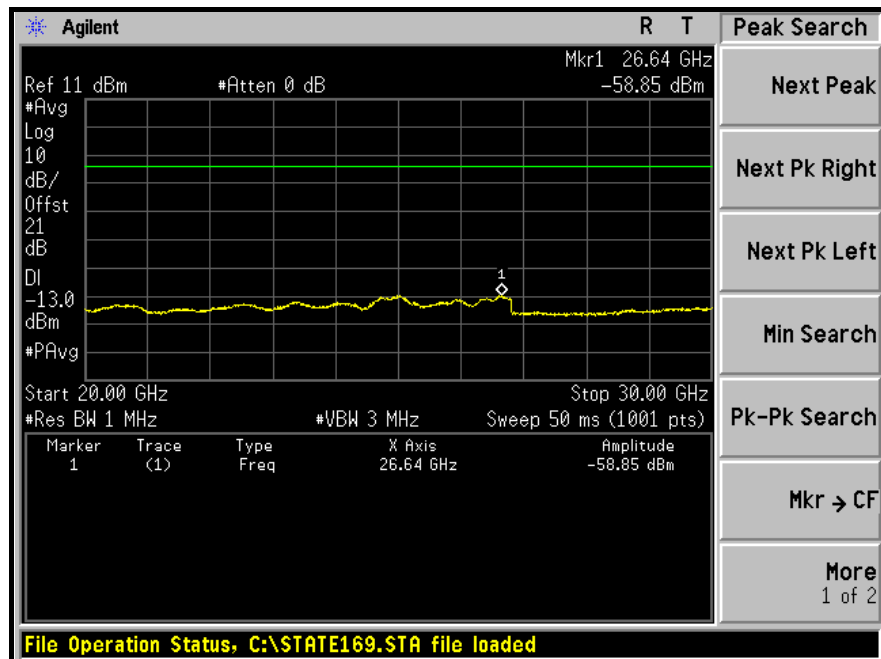

30GHz ~ 40GHz:

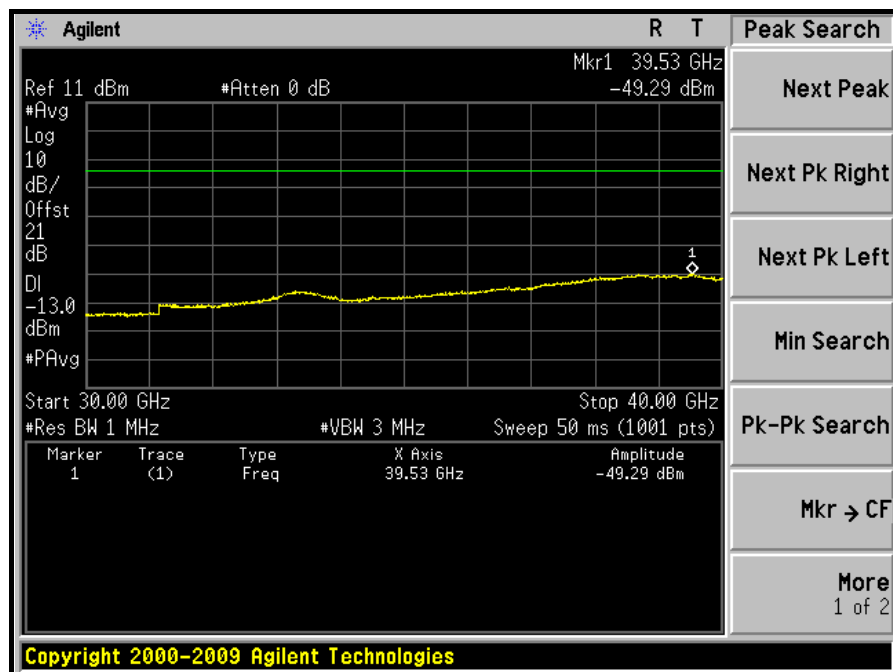



A D T

HIGH CHANNEL: 30MHz ~ 1GHz:

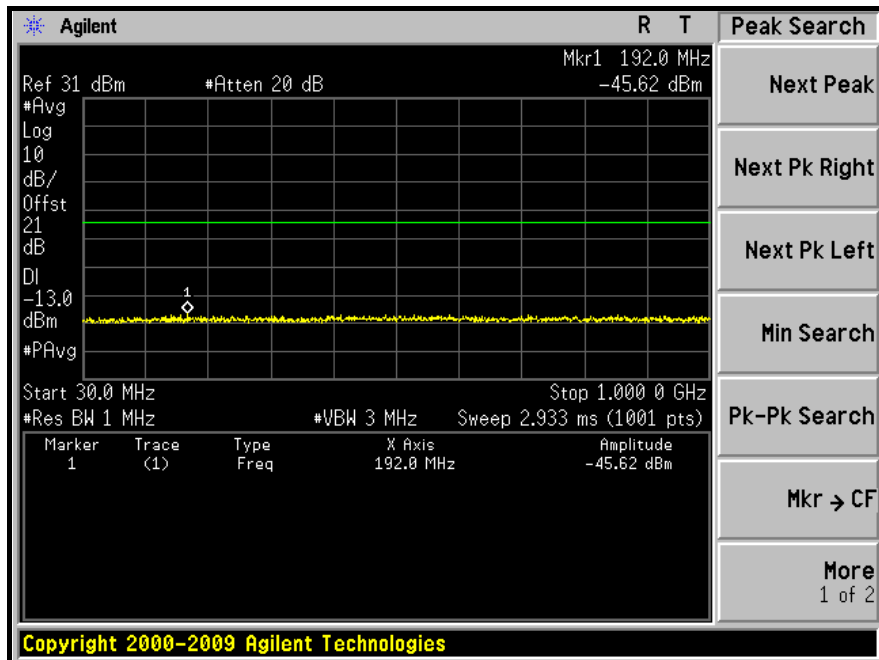

1GHz ~ 4.5GHz:

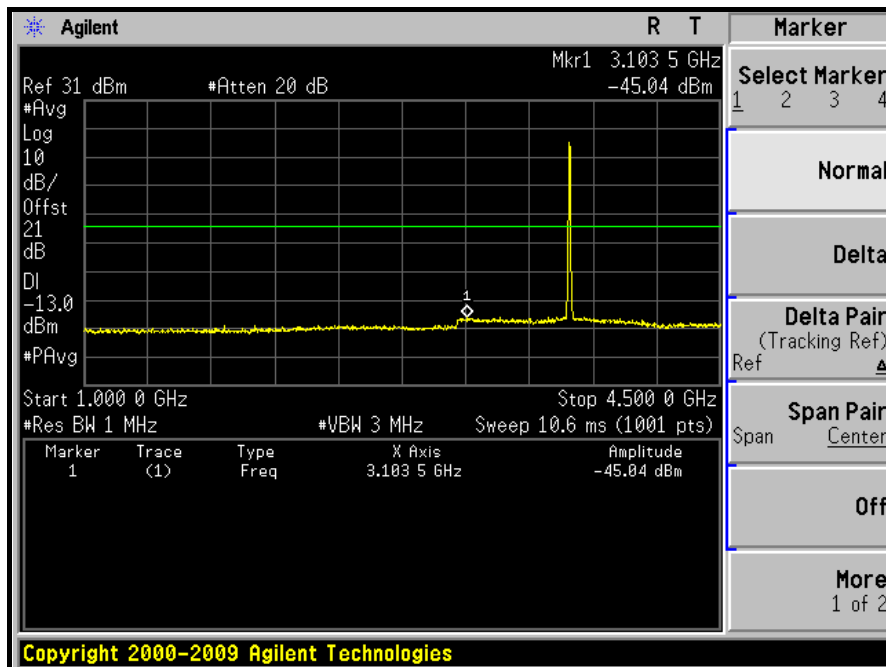



A D T

4.5GHz ~ 10GHz:

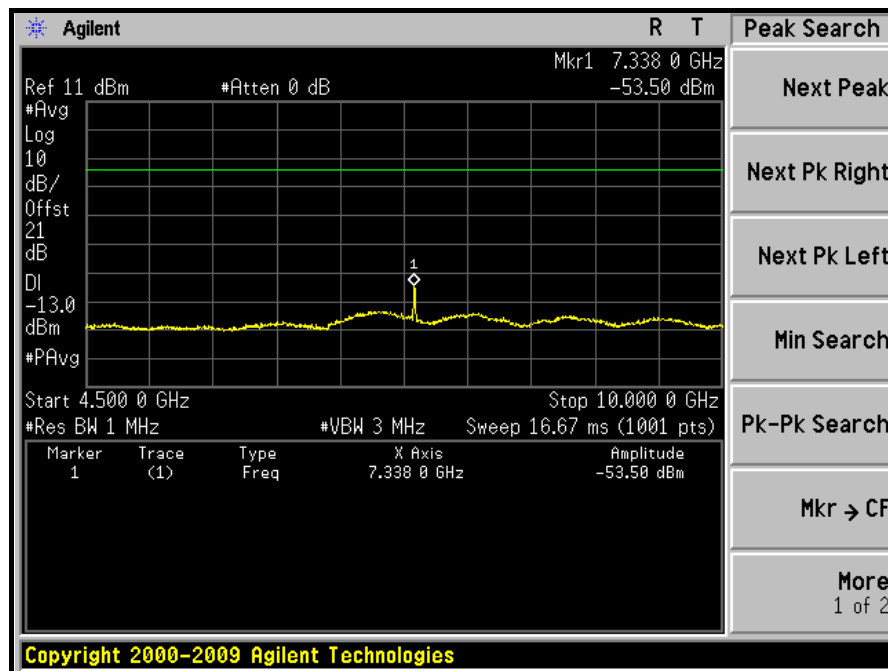

10GHz ~ 20GHz:

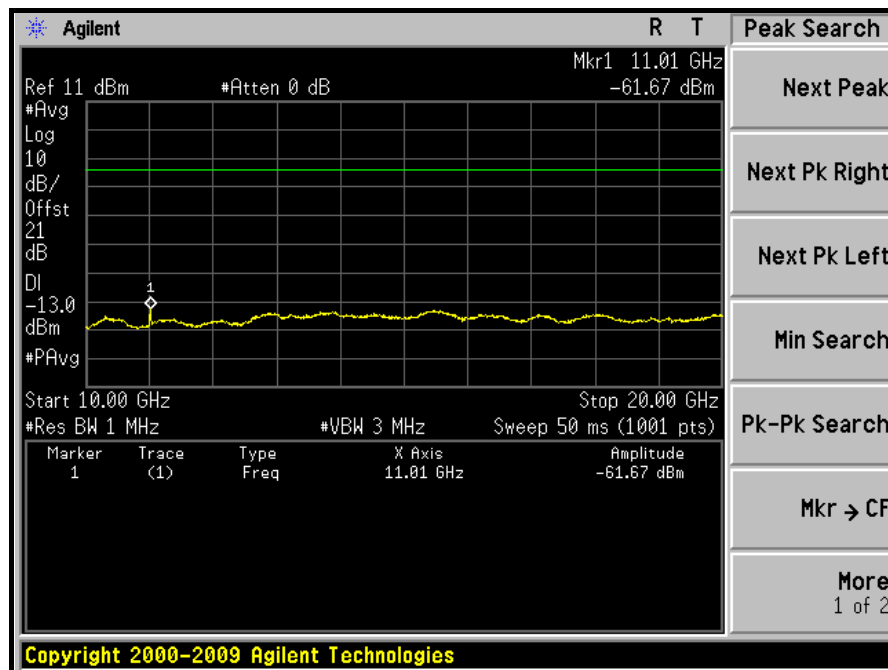



A D T

20GHz ~ 30GHz:

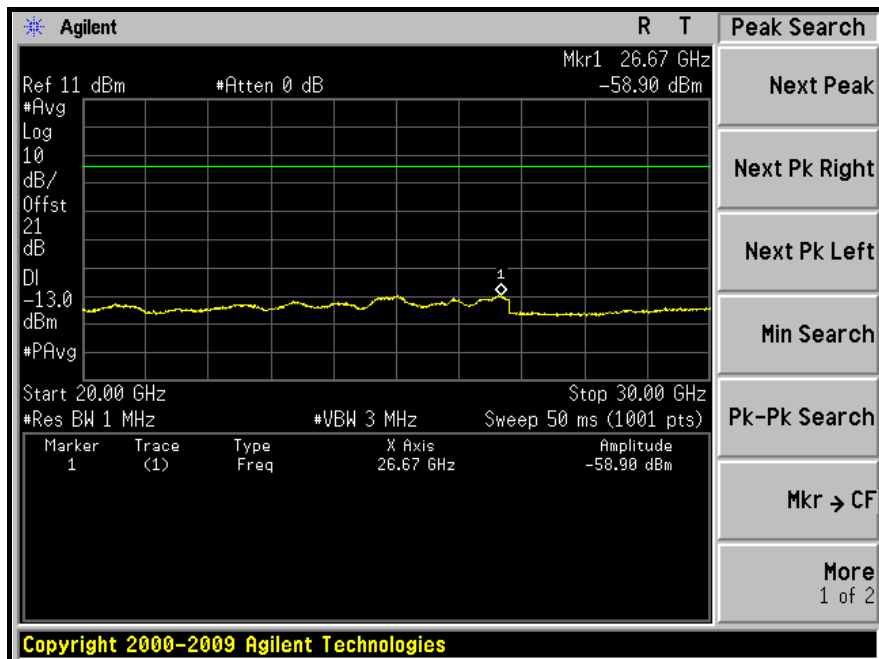

30GHz ~ 40GHz:

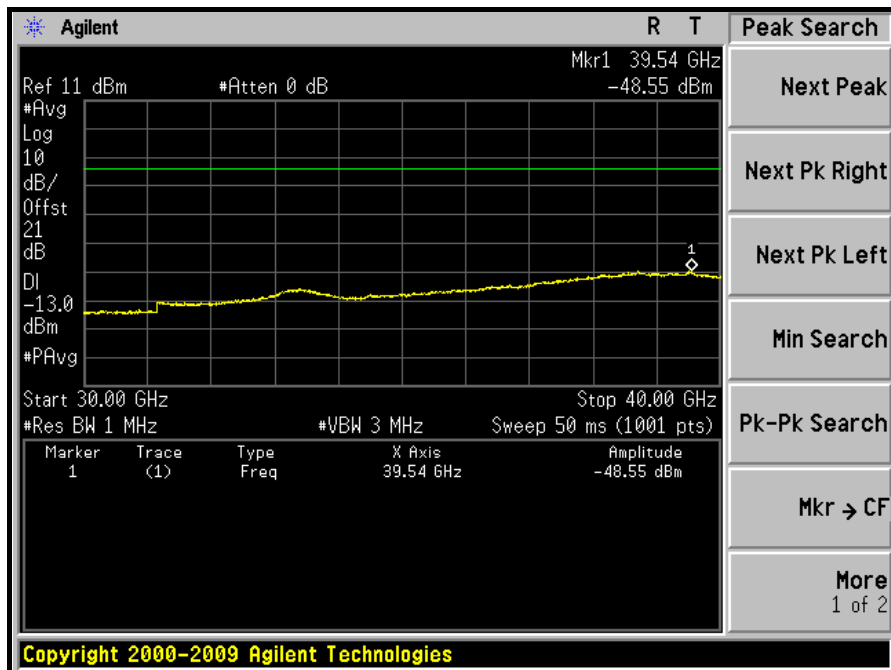

4.6 RADIATED EMISSION MEASUREMENT (BELOW 1GHz)

4.6.1 LIMITS OF RADIATED EMISSION MEASUREMENT

According to FCC 90.1323 specified that the power of any emission outside a licensee's frequency band(s) of operation shall be attenuated below the transmitter power (P) within the licensed band(s) of operation, measured in Watts, by at least $43 + 10 \log (P)$ dB. The limit of emission equal to -13dBm Compliance with this provision is based on the use of measurement instrumentation employing a resolution bandwidth of 1 MHz or less, but at least one percent of the emission bandwidth of the fundamental emission of the transmitter, provided the measured energy is integrated over a 1 MHz bandwidth.

4.6.2 TEST INSTRUMENTS

DESCRIPTION & MANUFACTURER	MODEL NO.	SERIAL NO.	DATE OF CALIBRATION	DUE DATE OF CALIBRATION
Test Receiver ROHDE & SCHWARZ	ESI7	838496/016	Dec. 29, 2009	Dec. 28, 2010
Spectrum Analyzer ROHDE & SCHWARZ	FSP40	100040	Jul. 07, 2009	Jul. 06, 2010
BILOG Antenna SCHWARZBECK	VULB9168	9168-155	Apr. 29, 2010	Apr. 28, 2011
HORN Antenna SCHWARZBECK	BBHA 9120D	9120D-209	Jul. 01, 2009	Jun. 30, 2010
HORN Antenna SCHWARZBECK	BBHA 9170	BBHA9170242	Dec. 25, 2009	Dec. 24, 2010
Preamplifier Agilent	8449B	3008A01961	Nov. 04, 2009	Nov. 03, 2010
Preamplifier Agilent	8447D	2944A10738	Nov. 04, 2009	Nov. 03, 2010
RF signal cable HUBER+SUHNNER	SUCOFLEX 104	274041/4	Aug. 28, 2009	Aug. 27, 2010
RF signal cable HUBER+SUHNNER	SUCOFLEX 104	283397/4	Aug. 28, 2009	Aug. 27, 2010
Software ADT.	ADT_Radiated_ V7.6.15.9.2	NA	NA	NA
Antenna Tower inn-co GmbH	MA 4000	010303	NA	NA
Antenna Tower Controller inn-co GmbH	CO2000	019303	NA	NA
Turn Table ADT.	TT100.	TT93021704	NA	NA
Turn Table Controller ADT.	SC100.	SC93021704	NA	NA

- NOTE:**
1. The calibration interval of the above test instruments is 12 months and the calibrations are traceable to NML/ROC and NIST/USA.
 2. The test was performed in HwaYa Chamber 4.
 3. The horn antenna and HP preamplifier (model: 8449B) are used only for the measurement of emission frequency above 1GHz if tested.
 4. The FCC Site Registration No. is 988962.
 5. The IC Site Registration No. is IC7450F-4.

4.6.3 TEST PROCEDURES

- a. Substitution method is used for E.I.R.P measurement. In the semi-anechoic chamber, EUT placed on the 0.8m height of Turn Table, rotated the table around 360 degrees to search the maximum radiation power and receiver antenna shall be rotated vertical and horizontal polarization and moved height from 1m to 4m to find the maximum polar radiated power. The “Read Value” is the spectrum reading the maximum power value.
- b. The substitution antenna is substituted for EUT at the same position and signals generator export the CW signal to the substitution antenna via a tx cable. Rotated the Turn Table and moved receiving antenna to find the maximum radiation power. Adjust output power level of S.G to get a Value of spectrum reading equal to “Read Value” of step a. Record the power level of S.G

EIRP = Output power level of S.G – TX cable loss + Antenna gain of Substitution antenna

NOTE: The resolution bandwidth of spectrum analyzer is 1 MHz and the video bandwidth is 3 MHz.

4.6.4 DEVIATION FROM TEST STANDARD

No deviation

4.6.5 TEST SETUP

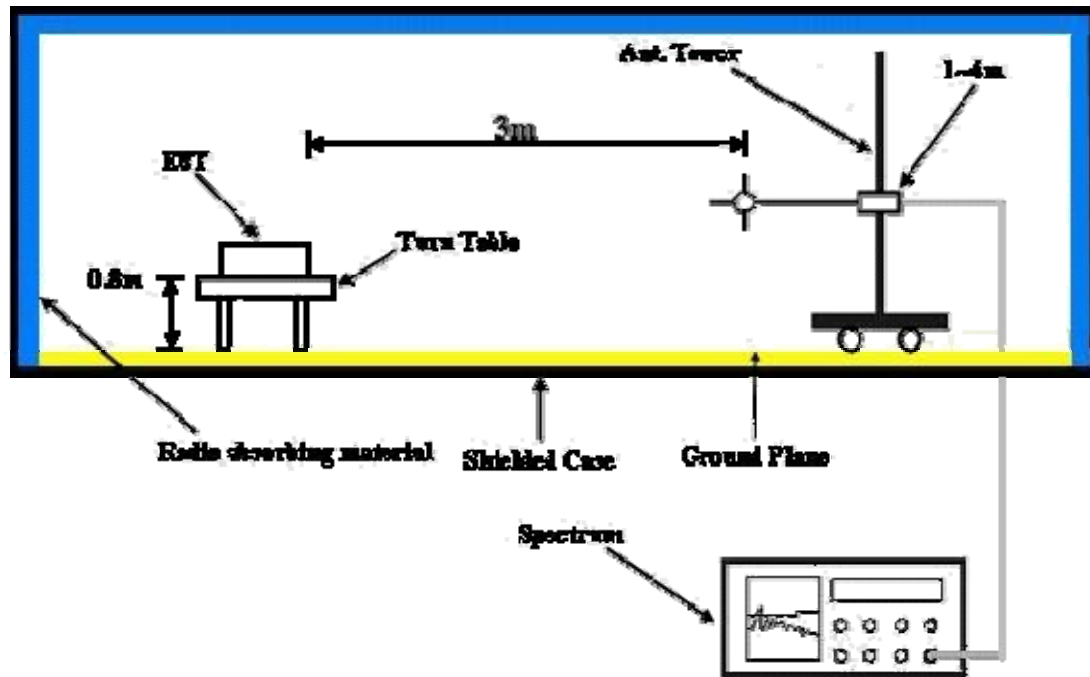

For the actual test configuration, please refer to the related item – Photographs of the Test Configuration.

4.6.6 EUT OPERATING CONDITIONS

Same as 4.1.5.



A D T

4.6.7 TEST RESULTS

MODE	Low channel	FREQUENCY RANGE	Below 1000MHz
INPUT POWER	120Vac, 60Hz	ENVIRONMENTAL CONDITIONS	25deg°C, 65%RH 991hPa
TESTED BY	Sun Lin	CHANNEL BANDWIDTH	3.5MHz
TEST MODE	A		

ANTENNA POLARITY & TEST DISTANCE: HORIZONTAL AT 3m						
NO.	FREQ. (MHz)	EMISSION LEVEL (dBuV)	LIMIT (dBm)	S.G POWER VALUE (dBm)	CORRECTION FACTOR (dB)	POWER VALUE (dBm)
1	103.83	47.6	-13.0	-39.0	-7.7	-46.7
2	148.50	46.7	-13.0	-39.7	-7.7	-47.4
3	203.08	42.7	-13.0	-43.9	-7.7	-51.6
4	255.36	41.4	-13.0	-45.0	-7.7	-52.7
5	321.47	46.6	-13.0	-39.5	-7.8	-47.3
6	377.98	38.5	-13.0	-47.8	-7.8	-55.6
ANTENNA POLARITY & TEST DISTANCE: VERTICAL AT 3m						
NO.	FREQ. (MHz)	EMISSION LEVEL (dBuV/m)	LIMIT (dBm)	S.G POWER VALUE (dBm)	CORRECTION FACTOR (dB)	POWER VALUE (dBm)
1	45.58	56.4	-13.0	-29.8	-7.7	-37.5
2	103.88	52.8	-13.0	-33.7	-7.7	-41.4
3	189.53	37.6	-13.0	-48.9	-7.7	-56.6
4	259.39	38.6	-13.0	-47.6	-7.7	-55.3
5	335.47	45.6	-13.0	-41.0	-7.8	-48.8
6	393.58	37.3	-13.0	-49.1	-7.8	-56.9

NOTE: Power Value (dBum) = S.G Power Value (dBm) + Correction Factor (dB).



A D T

MODE	Low channel	FREQUENCY RANGE	Below 1000MHz
INPUT POWER	120Vac, 60Hz	ENVIRONMENTAL CONDITIONS	25deg°C, 65%RH 991hPa
TESTED BY	Sun Lin	CHANNEL BANDWIDTH	5.0MHz
TEST MODE	A		

ANTENNA POLARITY & TEST DISTANCE: HORIZONTAL AT 3m						
NO.	FREQ. (MHz)	EMISSION LEVEL (dBuV)	LIMIT (dBm)	S.G POWER VALUE (dBm)	CORRECTION FACTOR (dB)	POWER VALUE (dBm)
1	102.87	46.3	-13.0	-40.2	-7.7	-47.9
2	147.85	45.7	-13.0	-41.1	-7.7	-48.8
3	202.77	41.7	-13.0	-44.8	-7.7	-52.5
4	256.17	42.7	-13.0	-44.1	-7.7	-51.8
5	322.78	45.7	-13.0	-40.9	-7.8	-48.7
6	378.23	39.6	-13.0	-46.6	-7.8	-54.4
ANTENNA POLARITY & TEST DISTANCE: VERTICAL AT 3m						
NO.	FREQ. (MHz)	EMISSION LEVEL (dBuV/m)	LIMIT (dBm)	S.G POWER VALUE (dBm)	CORRECTION FACTOR (dB)	POWER VALUE (dBm)
1	42.47	56.9	-13.0	-29.3	-7.7	-37.0
2	65.86	53.0	-13.0	-33.7	-7.7	-41.4
3	75.89	59.0	-13.0	-27.8	-7.7	-35.5
4	136.21	44.7	-13.0	-41.9	-7.7	-49.6
5	349.54	36.3	-13.0	-50.1	-7.8	-57.9
6	372.56	38.9	-13.0	-47.8	-7.8	-55.6

NOTE: Power Value (dBum) = S.G Power Value (dBm) + Correction Factor (dB).



A D T

MODE	Low channel	FREQUENCY RANGE	Below 1000MHz
INPUT POWER	120Vac, 60Hz	ENVIRONMENTAL CONDITIONS	25deg°C, 65%RH 991hPa
TESTED BY	Sun Lin	CHANNEL BANDWIDTH	7MHz
TEST MODE	A		

ANTENNA POLARITY & TEST DISTANCE: HORIZONTAL AT 3m						
NO.	FREQ. (MHz)	EMISSION LEVEL (dBuV)	LIMIT (dBm)	S.G POWER VALUE (dBm)	CORRECTION FACTOR (dB)	POWER VALUE (dBm)
1	76.69	50.7	-13.0	-36.1	-7.7	-43.8
2	86.58	51.3	-13.0	-35.6	-7.7	-43.3
3	142.35	51.4	-13.0	-35.2	-7.7	-42.9
4	182.05	44.3	-13.0	-42.4	-7.7	-50.1
5	370.92	43.5	-13.0	-42.8	-7.8	-50.6
6	726.47	42.6	-13.0	-43.5	-7.9	-51.4
ANTENNA POLARITY & TEST DISTANCE: VERTICAL AT 3m						
NO.	FREQ. (MHz)	EMISSION LEVEL (dBuV/m)	LIMIT (dBm)	S.G POWER VALUE (dBm)	CORRECTION FACTOR (dB)	POWER VALUE (dBm)
1	41.63	57.6	-13.0	-29.1	-7.7	-36.8
2	64.89	53.5	-13.0	-33.2	-7.7	-40.9
3	76.26	57.4	-13.0	-29.2	-7.7	-36.9
4	135.78	45.4	-13.0	-41.4	-7.7	-49.1
5	348.93	37.7	-13.0	-48.7	-7.8	-56.5
6	371.78	39.3	-13.0	-47.4	-7.8	-55.2

NOTE: Power Value (dBum) = S.G Power Value (dBm) + Correction Factor (dB).



A D T

MODE	Low channel	FREQUENCY RANGE	Below 1000MHz
INPUT POWER	120Vac, 60Hz	ENVIRONMENTAL CONDITIONS	25deg°C, 65%RH 991hPa
TESTED BY	Sun Lin	CHANNEL BANDWIDTH	10MHz
TEST MODE	A		

ANTENNA POLARITY & TEST DISTANCE: HORIZONTAL AT 3m						
NO.	FREQ. (MHz)	EMISSION LEVEL (dBuV)	LIMIT (dBm)	S.G POWER VALUE (dBm)	CORRECTION FACTOR (dB)	POWER VALUE (dBm)
1	101.22	45.8	-13.0	-40.7	-7.7	-48.4
2	146.23	44.7	-13.0	-42.1	-7.7	-49.8
3	203.18	41.0	-13.0	-45.4	-7.7	-53.1
4	255.03	41.5	-13.0	-45.1	-7.7	-52.8
5	322.72	44.9	-13.0	-41.8	-7.8	-49.6
6	378.23	39.6	-13.0	-47.1	-7.8	-54.9
ANTENNA POLARITY & TEST DISTANCE: VERTICAL AT 3m						
NO.	FREQ. (MHz)	EMISSION LEVEL (dBuV/m)	LIMIT (dBm)	S.G POWER VALUE (dBm)	CORRECTION FACTOR (dB)	POWER VALUE (dBm)
1	46.26	55.8	-13.0	-30.9	-7.7	-38.6
2	102.63	53.3	-13.0	-33.3	-7.7	-41.0
3	188.63	36.5	-13.0	-49.9	-7.7	-57.6
4	258.48	37.4	-13.0	-49.2	-7.7	-56.9
5	336.61	44.7	-13.0	-41.5	-7.8	-49.3
6	392.93	36.6	-13.0	-49.7	-7.8	-57.5

NOTE: Power Value (dBum) = S.G Power Value (dBm) + Correction Factor (dB).



A D T

MODE	Low channel	FREQUENCY RANGE	Below 1000MHz
INPUT POWER	120Vac, 60Hz	ENVIRONMENTAL CONDITIONS	25deg°C, 65%RH 991hPa
TESTED BY	Sun Lin	CHANNEL BANDWIDTH	3.5MHz
TEST MODE	B		

ANTENNA POLARITY & TEST DISTANCE: HORIZONTAL AT 3m						
NO.	FREQ. (MHz)	EMISSION LEVEL (dBuV)	LIMIT (dBm)	S.G POWER VALUE (dBm)	CORRECTION FACTOR (dB)	POWER VALUE (dBm)
1	30.00	45.8	-13.0	-40.9	-7.7	-48.6
2	105.82	46.3	-13.0	-40.0	-7.7	-47.7
3	191.34	47.6	-13.0	-39.1	-7.7	-46.8
4	220.50	46.4	-13.0	-40.2	-7.7	-47.9
5	294.38	43.0	-13.0	-43.4	-7.7	-51.1
6	360.49	38.6	-13.0	-47.7	-7.8	-55.5

ANTENNA POLARITY & TEST DISTANCE: VERTICAL AT 3m						
NO.	FREQ. (MHz)	EMISSION LEVEL (dBuV/m)	LIMIT (dBm)	S.G POWER VALUE (dBm)	CORRECTION FACTOR (dB)	POWER VALUE (dBm)
1	30.00	61.6	-13.0	-25.0	-7.7	-32.7
2	63.05	50.4	-13.0	-36.2	-7.7	-43.9
3	96.09	50.7	-13.0	-36.2	-7.7	-43.9
4	140.80	46.0	-13.0	-40.4	-7.7	-48.1
5	175.79	47.7	-13.0	-38.9	-7.7	-46.6
6	232.16	43.3	-13.0	-43.5	-7.7	-51.2

NOTE: Power Value (dBum) = S.G Power Value (dBm) + Correction Factor (dB).



A D T

MODE	Low channel	FREQUENCY RANGE	Below 1000MHz
INPUT POWER	120Vac, 60Hz	ENVIRONMENTAL CONDITIONS	25deg°C, 65%RH 991hPa
TESTED BY	Sun Lin	CHANNEL BANDWIDTH	5MHz
TEST MODE	B		

ANTENNA POLARITY & TEST DISTANCE: HORIZONTAL AT 3m						
NO.	FREQ. (MHz)	EMISSION LEVEL (dBuV)	LIMIT (dBm)	S.G POWER VALUE (dBm)	CORRECTION FACTOR (dB)	POWER VALUE (dBm)
1	30.00	45.8	-13.0	-40.5	-7.7	-48.2
2	76.63	43.3	-13.0	-43.5	-7.7	-51.2
3	138.86	44.7	-13.0	-42.2	-7.7	-49.9
4	175.85	48.4	-13.0	-38.2	-7.7	-45.9
5	267.25	42.9	-13.0	-43.5	-7.7	-51.2
6	358.28	38.7	-13.0	-47.9	-7.8	-55.7
ANTENNA POLARITY & TEST DISTANCE: VERTICAL AT 3m						
NO.	FREQ. (MHz)	EMISSION LEVEL (dBuV/m)	LIMIT (dBm)	S.G POWER VALUE (dBm)	CORRECTION FACTOR (dB)	POWER VALUE (dBm)
1	31.95	61.6	-13.0	-25.1	-7.7	-32.8
2	72.78	49.9	-13.0	-36.7	-7.7	-44.4
3	140.83	44.4	-13.0	-42.3	-7.7	-50.0
4	230.23	43.7	-13.0	-43.1	-7.7	-50.8
5	319.53	40.4	-13.0	-45.8	-7.8	-53.6
6	500.41	37.6	-13.0	-48.5	-7.8	-56.3

NOTE: Power Value (dBum) = S.G Power Value (dBm) + Correction Factor (dB).



A D T

MODE	Low channel	FREQUENCY RANGE	Below 1000MHz
INPUT POWER	120Vac, 60Hz	ENVIRONMENTAL CONDITIONS	25deg°C, 65%RH 991hPa
TESTED BY	Sun Lin	CHANNEL BANDWIDTH	7MHz
TEST MODE	B		

ANTENNA POLARITY & TEST DISTANCE: HORIZONTAL AT 3m						
NO.	FREQ. (MHz)	EMISSION LEVEL (dBuV)	LIMIT (dBm)	S.G POWER VALUE (dBm)	CORRECTION FACTOR (dB)	POWER VALUE (dBm)
1	30.00	45.7	-13.0	-41.0	-7.7	-48.7
2	107.76	45.0	-13.0	-41.6	-7.7	-49.3
3	138.83	44.3	-13.0	-42.5	-7.7	-50.2
4	192.17	48.0	-13.0	-38.8	-7.7	-46.5
5	230.03	44.9	-13.0	-41.5	-7.7	-49.2
6	292.48	42.8	-13.0	-43.5	-7.7	-51.2
ANTENNA POLARITY & TEST DISTANCE: VERTICAL AT 3m						
NO.	FREQ. (MHz)	EMISSION LEVEL (dBuV/m)	LIMIT (dBm)	S.G POWER VALUE (dBm)	CORRECTION FACTOR (dB)	POWER VALUE (dBm)
1	31.94	63.0	-13.0	-23.5	-7.7	-31.2
2	72.72	49.6	-13.0	-36.7	-7.7	-44.4
3	138.86	44.6	-13.0	-41.6	-7.7	-49.3
4	231.47	42.5	-13.0	-44.2	-7.7	-51.9
5	304.09	42.4	-13.0	-44.3	-7.8	-52.1
6	500.42	38.3	-13.0	-48.1	-7.8	-55.9

NOTE: Power Value (dBum) = S.G Power Value (dBm) + Correction Factor (dB).



A D T

MODE	Low channel	FREQUENCY RANGE	Below 1000MHz
INPUT POWER	120Vac, 60Hz	ENVIRONMENTAL CONDITIONS	25deg°C, 65%RH 991hPa
TESTED BY	Sun Lin	CHANNEL BANDWIDTH	10MHz
TEST MODE	B		

ANTENNA POLARITY & TEST DISTANCE: HORIZONTAL AT 3m						
NO.	FREQ. (MHz)	EMISSION LEVEL (dBuV)	LIMIT (dBm)	S.G POWER VALUE (dBm)	CORRECTION FACTOR (dB)	POWER VALUE (dBm)
1	31.93	46.0	-13.0	-40.3	-7.7	-48.0
2	96.09	46.3	-13.0	-40.4	-7.7	-48.1
3	138.86	44.9	-13.0	-41.6	-7.7	-49.3
4	173.83	46.9	-13.0	-39.7	-7.7	-47.4
5	292.43	43.6	-13.0	-43.1	-7.7	-50.8
6	391.78	34.9	-13.0	-51.3	-7.8	-59.1
ANTENNA POLARITY & TEST DISTANCE: VERTICAL AT 3m						
NO.	FREQ. (MHz)	EMISSION LEVEL (dBuV/m)	LIMIT (dBm)	S.G POWER VALUE (dBm)	CORRECTION FACTOR (dB)	POWER VALUE (dBm)
1	31.97	62.7	-13.0	-24.0	-7.7	-31.7
2	61.12	50.5	-13.0	-36.3	-7.7	-44.0
3	96.07	50.5	-13.0	-36.2	-7.7	-43.9
4	177.72	45.7	-13.0	-40.8	-7.7	-48.5
5	228.28	42.6	-13.0	-43.9	-7.7	-51.6
6	306.09	42.8	-13.0	-43.9	-7.8	-51.7

NOTE: Power Value (dBum) = S.G Power Value (dBm) + Correction Factor (dB).



A D T

4.7 RADIATED EMISSION MEASUREMENT (ABOVE 1GHz)

4.7.1 LIMITS OF RADIATED EMISSION MEASUREMENT

According to FCC 90.1323 specified that the power of any emission outside a licensee's frequency band(s) of operation shall be attenuated below the transmitter power (P) within the licensed band(s) of operation, measured in Watts, by at least $43 + 10 \log (P)$ dB. The limit of emission equal to -13dBm Compliance with this provision is based on the use of measurement instrumentation employing a resolution bandwidth of 1 MHz or less, but at least one percent of the emission bandwidth of the fundamental emission of the transmitter, provided the measured energy is integrated over a 1 MHz bandwidth.

4.7.2 TEST INSTRUMENTS

Same as 4.6.2.

4.7.3 TEST PROCEDURES

Same as 4.6.3.

4.7.4 DEVIATION FROM TEST STANDARD

No deviation

4.7.5 TEST SETUP

Same as 4.6.5.

4.7.6 EUT OPERATING CONDITIONS

Same as 4.1.5



A D T

4.7.7 TEST RESULTS

MODE	Low channel	FREQUENCY RANGE	Above 1000MHz
INPUT POWER	120Vac, 60Hz	ENVIRONMENTAL CONDITIONS	25deg°C, 65%RH 991hPa
TESTED BY	Mark Liao	CHANNEL BANDWIDTH	3.5MHz
TEST MODE	A		

ANTENNA POLARITY & TEST DISTANCE: HORIZONTAL AT 3m						
NO.	FREQ. (MHz)	EMISSION LEVEL (dBuV)	LIMIT (dBm)	S.G POWER VALUE (dBm)	CORRECTION FACTOR (dB)	POWER VALUE (dBm)
1	7303.50	51.3	-13.0	-52.3	9.5	-42.8
2	10955.25	50.4	-13.0	-51.7	7.8	-43.9
ANTENNA POLARITY & TEST DISTANCE: VERTICAL AT 3m						
NO.	FREQ. (MHz)	EMISSION LEVEL (dBuV/m)	LIMIT (dBm)	S.G POWER VALUE (dBm)	CORRECTION FACTOR (dB)	POWER VALUE (dBm)
1	7303.50	53.1	-13.0	-50.6	9.5	-41.1
2	10955.25	50.3	-13.0	-51.8	7.8	-44.0

NOTE: Power Value (dBum) = S.G Power Value (dBm) + Correction Factor (dB).



A D T

MODE	Middle channel	FREQUENCY RANGE	Above 1000MHz
INPUT POWER	120Vac, 60Hz	ENVIRONMENTAL CONDITIONS	25deg°C, 65%RH 991hPa
TESTED BY	Mark Liao	CHANNEL BANDWIDTH	3.5MHz
TEST MODE	A		

ANTENNA POLARITY & TEST DISTANCE: HORIZONTAL AT 3m						
NO.	FREQ. (MHz)	EMISSION LEVEL (dBuV)	LIMIT (dBm)	S.G POWER VALUE (dBm)	CORRECTION FACTOR (dB)	POWER VALUE (dBm)
1	7325.00	52.1	-13.0	-51.8	9.7	-42.1
2	10987.50	50.6	-13.0	-51.6	7.8	-43.8

ANTENNA POLARITY & TEST DISTANCE: VERTICAL AT 3m						
NO.	FREQ. (MHz)	EMISSION LEVEL (dBuV/m)	LIMIT (dBm)	S.G POWER VALUE (dBm)	CORRECTION FACTOR (dB)	POWER VALUE (dBm)
1	7325.00	53.2	-13.0	-50.7	9.7	-41.0
2	10987.50	51.5	-13.0	-50.7	7.8	-42.9

NOTE: Power Value (dBum) = S.G Power Value (dBm) + Correction Factor (dB).



A D T

MODE	High channel	FREQUENCY RANGE	Above 1000MHz
INPUT POWER	120Vac, 60Hz	ENVIRONMENTAL CONDITIONS	25deg°C, 65%RH 991hPa
TESTED BY	Mark Liao	CHANNEL BANDWIDTH	3.5MHz
TEST MODE	A		

ANTENNA POLARITY & TEST DISTANCE: HORIZONTAL AT 3m						
NO.	FREQ. (MHz)	EMISSION LEVEL (dBuV)	LIMIT (dBm)	S.G POWER VALUE (dBm)	CORRECTION FACTOR (dB)	POWER VALUE (dBm)
1	7346.50	53.7	-13.0	-50.2	9.7	-40.5
2	11019.75	52.4	-13.0	-49.7	7.8	-41.9
ANTENNA POLARITY & TEST DISTANCE: VERTICAL AT 3m						
NO.	FREQ. (MHz)	EMISSION LEVEL (dBuV/m)	LIMIT (dBm)	S.G POWER VALUE (dBm)	CORRECTION FACTOR (dB)	POWER VALUE (dBm)
1	7346.50	53.8	-13.0	-49.9	9.7	-40.2
2	11019.75	52.7	-13.0	-49.2	7.8	-41.4

NOTE: Power Value (dBum) = S.G Power Value (dBm) + Correction Factor (dB).



A D T

MODE	Low channel	FREQUENCY RANGE	Above 1000MHz
INPUT POWER	120Vac, 60Hz	ENVIRONMENTAL CONDITIONS	25deg°C, 63%RH 991hPa
TESTED BY	Dean Wang	CHANNEL BANDWIDTH	5MHz
TEST MODE	A		

ANTENNA POLARITY & TEST DISTANCE: HORIZONTAL AT 3m						
NO.	FREQ. (MHz)	EMISSION LEVEL (dBuV)	LIMIT (dBm)	S.G POWER VALUE (dBm)	CORRECTION FACTOR (dB)	POWER VALUE (dBm)
1	7305.00	66.3	-13.0	-37.5	9.5	-28.0
2	10957.50	58.3	-13.0	-43.6	7.8	-35.8

ANTENNA POLARITY & TEST DISTANCE: VERTICAL AT 3m						
NO.	FREQ. (MHz)	EMISSION LEVEL (dBuV/m)	LIMIT (dBm)	S.G POWER VALUE (dBm)	CORRECTION FACTOR (dB)	POWER VALUE (dBm)
1	7305.00	65.2	-13.0	-38.5	9.5	-29.0
2	10957.50	58.0	-13.0	-44.2	7.8	-36.4

NOTE: Power Value (dBum) = S.G Power Value (dBm) + Correction Factor (dB).



A D T

MODE	Middle channel	FREQUENCY RANGE	Above 1000MHz
INPUT POWER	120Vac, 60Hz	ENVIRONMENTAL CONDITIONS	25deg°C, 63%RH 991hPa
TESTED BY	Dean Wang	CHANNEL BANDWIDTH	5MHz
TEST MODE	A		

ANTENNA POLARITY & TEST DISTANCE: HORIZONTAL AT 3m						
NO.	FREQ. (MHz)	EMISSION LEVEL (dBuV)	LIMIT (dBm)	S.G POWER VALUE (dBm)	CORRECTION FACTOR (dB)	POWER VALUE (dBm)
1	7325.00	69.9	-13.0	-33.8	9.7	-24.1
2	10987.50	60.3	-13.0	-41.8	7.8	-34.0
ANTENNA POLARITY & TEST DISTANCE: VERTICAL AT 3m						
NO.	FREQ. (MHz)	EMISSION LEVEL (dBuV/m)	LIMIT (dBm)	S.G POWER VALUE (dBm)	CORRECTION FACTOR (dB)	POWER VALUE (dBm)
1	7325.00	66.8	-13.0	-36.9	9.7	-27.2
2	10987.50	59.7	-13.0	-42.0	7.8	-34.2

NOTE: Power Value (dBum) = S.G Power Value (dBm) + Correction Factor (dB).



A D T

MODE	High channel	FREQUENCY RANGE	Above 1000MHz
INPUT POWER	120Vac, 60Hz	ENVIRONMENTAL CONDITIONS	25deg°C, 63%RH 991hPa
TESTED BY	Dean Wang	CHANNEL BANDWIDTH	5MHz
TEST MODE	A		

ANTENNA POLARITY & TEST DISTANCE: HORIZONTAL AT 3m						
NO.	FREQ. (MHz)	EMISSION LEVEL (dBuV)	LIMIT (dBm)	S.G POWER VALUE (dBm)	CORRECTION FACTOR (dB)	POWER VALUE (dBm)
1	7345.00	70.5	-13.0	-33.5	9.7	-23.8
2	11017.50	59.0	-13.0	-43.0	7.8	-35.2
ANTENNA POLARITY & TEST DISTANCE: VERTICAL AT 3m						
NO.	FREQ. (MHz)	EMISSION LEVEL (dBuV/m)	LIMIT (dBm)	S.G POWER VALUE (dBm)	CORRECTION FACTOR (dB)	POWER VALUE (dBm)
1	7345.00	66.4	-13.0	-37.5	9.7	-27.8
2	11017.50	59.7	-13.0	-42.1	7.8	-34.3

NOTE: Power Value (dBum) = S.G Power Value (dBm) + Correction Factor (dB).



A D T

MODE	Low channel	FREQUENCY RANGE	Above 1000MHz
INPUT POWER	120Vac, 60Hz	ENVIRONMENTAL CONDITIONS	25deg°C, 65%RH 991hPa
TESTED BY	Mark Liao	CHANNEL BANDWIDTH	7MHz
TEST MODE	A		

ANTENNA POLARITY & TEST DISTANCE: HORIZONTAL AT 3m						
NO.	FREQ. (MHz)	EMISSION LEVEL (dBuV)	LIMIT (dBm)	S.G POWER VALUE (dBm)	CORRECTION FACTOR (dB)	POWER VALUE (dBm)
1	7307.00	59.7	-13.0	-44.0	9.5	-34.5
2	10960.50	60.5	-13.0	-41.8	7.8	-34.0
ANTENNA POLARITY & TEST DISTANCE: VERTICAL AT 3m						
NO.	FREQ. (MHz)	EMISSION LEVEL (dBuV/m)	LIMIT (dBm)	S.G POWER VALUE (dBm)	CORRECTION FACTOR (dB)	POWER VALUE (dBm)
1	7307.00	60.4	-13.0	-43.5	9.5	-34.0
2	10960.50	63.1	-13.0	-38.6	7.8	-30.8

NOTE: Power Value (dBum) = S.G Power Value (dBm) + Correction Factor (dB).



A D T

MODE	Middle channel	FREQUENCY RANGE	Above 1000MHz
INPUT POWER	120Vac, 60Hz	ENVIRONMENTAL CONDITIONS	25deg°C, 65%RH 991hPa
TESTED BY	Mark Liao	CHANNEL BANDWIDTH	7MHz
TEST MODE	A		

ANTENNA POLARITY & TEST DISTANCE: HORIZONTAL AT 3m						
NO.	FREQ. (MHz)	EMISSION LEVEL (dBuV)	LIMIT (dBm)	S.G POWER VALUE (dBm)	CORRECTION FACTOR (dB)	POWER VALUE (dBm)
1	7325.00	60.5	-13.0	-43.3	9.7	-33.6
2	10987.50	61.7	-13.0	-40.4	7.8	-32.6
ANTENNA POLARITY & TEST DISTANCE: VERTICAL AT 3m						
NO.	FREQ. (MHz)	EMISSION LEVEL (dBuV/m)	LIMIT (dBm)	S.G POWER VALUE (dBm)	CORRECTION FACTOR (dB)	POWER VALUE (dBm)
1	7325.00	61.4	-13.0	-42.3	9.7	-32.6
2	10987.50	63.9	-13.0	-38.3	7.8	-30.5

NOTE: Power Value (dBum) = S.G Power Value (dBm) + Correction Factor (dB).



A D T

MODE	High channel	FREQUENCY RANGE	Above 1000MHz
INPUT POWER	120Vac, 60Hz	ENVIRONMENTAL CONDITIONS	25deg°C, 65%RH 991hPa
TESTED BY	Mark Liao	CHANNEL BANDWIDTH	7MHz
TEST MODE	A		

ANTENNA POLARITY & TEST DISTANCE: HORIZONTAL AT 3m						
NO.	FREQ. (MHz)	EMISSION LEVEL (dBuV)	LIMIT (dBm)	S.G POWER VALUE (dBm)	CORRECTION FACTOR (dB)	POWER VALUE (dBm)
1	7343.00	58.7	-13.0	-45.1	9.7	-35.4
2	11014.50	61.9	-13.0	-40.0	7.8	-32.2
ANTENNA POLARITY & TEST DISTANCE: VERTICAL AT 3m						
NO.	FREQ. (MHz)	EMISSION LEVEL (dBuV/m)	LIMIT (dBm)	S.G POWER VALUE (dBm)	CORRECTION FACTOR (dB)	POWER VALUE (dBm)
1	7343.00	60.4	-13.0	-43.7	9.7	-34.0
2	11014.50	62.6	-13.0	-39.4	7.8	-31.6

NOTE: Power Value (dBum) = S.G Power Value (dBm) + Correction Factor (dB).



A D T

MODE	Low channel	FREQUENCY RANGE	Above 1000MHz
INPUT POWER	120Vac, 60Hz	ENVIRONMENTAL CONDITIONS	25deg°C, 63%RH 991hPa
TESTED BY	Dean Wang	CHANNEL BANDWIDTH	10MHz
TEST MODE	A		

ANTENNA POLARITY & TEST DISTANCE: HORIZONTAL AT 3m						
NO.	FREQ. (MHz)	EMISSION LEVEL (dBuV)	LIMIT (dBm)	S.G POWER VALUE (dBm)	CORRECTION FACTOR (dB)	POWER VALUE (dBm)
1	7310.00	64.0	-13.0	-39.6	9.5	-30.1
2	10965.00	56.4	-13.0	-45.8	7.8	-38.0
ANTENNA POLARITY & TEST DISTANCE: VERTICAL AT 3m						
NO.	FREQ. (MHz)	EMISSION LEVEL (dBuV/m)	LIMIT (dBm)	S.G POWER VALUE (dBm)	CORRECTION FACTOR (dB)	POWER VALUE (dBm)
1	7310.00	63.3	-13.0	-40.5	9.5	-31.0
2	10965.00	57.7	-13.0	-44.2	7.8	-36.4

NOTE: Power Value (dBum) = S.G Power Value (dBm) + Correction Factor (dB).



A D T

MODE	Middle channel	FREQUENCY RANGE	Above 1000MHz
INPUT POWER	120Vac, 60Hz	ENVIRONMENTAL CONDITIONS	25deg°C, 63%RH 991hPa
TESTED BY	Dean Wang	CHANNEL BANDWIDTH	10MHz
TEST MODE	A		

ANTENNA POLARITY & TEST DISTANCE: HORIZONTAL AT 3m						
NO.	FREQ. (MHz)	EMISSION LEVEL (dBuV)	LIMIT (dBm)	S.G POWER VALUE (dBm)	CORRECTION FACTOR (dB)	POWER VALUE (dBm)
1	7325.00	67.7	-13.0	-36.3	9.7	-26.6
2	10987.50	56.8	-13.0	-45.4	7.8	-37.6

ANTENNA POLARITY & TEST DISTANCE: VERTICAL AT 3m						
NO.	FREQ. (MHz)	EMISSION LEVEL (dBuV/m)	LIMIT (dBm)	S.G POWER VALUE (dBm)	CORRECTION FACTOR (dB)	POWER VALUE (dBm)
1	7325.00	61.7	-13.0	-42.5	9.7	-32.8
2	10987.50	55.9	-13.0	-46.1	7.8	-38.3

NOTE: Power Value (dBum) = S.G Power Value (dBm) + Correction Factor (dB).



A D T

MODE	High channel	FREQUENCY RANGE	Above 1000MHz
INPUT POWER	120Vac, 60Hz	ENVIRONMENTAL CONDITIONS	25deg°C, 63%RH 991hPa
TESTED BY	Dean Wang	CHANNEL BANDWIDTH	10MHz
TEST MODE	A		

ANTENNA POLARITY & TEST DISTANCE: HORIZONTAL AT 3m						
NO.	FREQ. (MHz)	EMISSION LEVEL (dBuV)	LIMIT (dBm)	S.G POWER VALUE (dBm)	CORRECTION FACTOR (dB)	POWER VALUE (dBm)
1	7340.00	67.0	-13.0	-36.6	9.7	-26.9
2	11010.00	55.9	-13.0	-45.9	7.8	-38.1

ANTENNA POLARITY & TEST DISTANCE: VERTICAL AT 3m						
NO.	FREQ. (MHz)	EMISSION LEVEL (dBuV/m)	LIMIT (dBm)	S.G POWER VALUE (dBm)	CORRECTION FACTOR (dB)	POWER VALUE (dBm)
1	7340.00	58.6	-13.0	-45.6	9.7	-35.9
2	11010.00	56.8	-13.0	-45.4	7.8	-37.6

NOTE: Power Value (dBum) = S.G Power Value (dBm) + Correction Factor (dB).



A D T

5 PHOTOGRAPHS OF THE TEST CONFIGURATION

Please refer to the attached file (Test Setup Photo).



A D T

6 INFORMATION ON THE TESTING LABORATORIES

We, Bureau Veritas Consumer Products Services (H.K.) Ltd., Taoyuan Branch, were founded in 1988 to provide our best service in EMC, Radio, Telecom and Safety consultation. Our laboratories are accredited and approved according to ISO/IEC 17025.

Copies of accreditation certificates of our laboratories obtained from approval agencies can be downloaded from our web site:

www.adt.com.tw/index.5/phtml. If you have any comments, please feel free to contact us at the following:

Linko EMC/RF Lab:

Tel: 886-2-26052180

Fax: 886-2-26051924

Hsin Chu EMC/RF Lab:

Tel: 886-3-5935343

Fax: 886-3-5935342

Hwa Ya EMC/RF/Safety/Telecom Lab: Web Site: www.adt.com.tw

Tel: 886-3-3183232

Fax: 886-3-3185050

The address and road map of all our labs can be found in our web site also.

---END---