



# **WipLL**

Wireless IP-Based Local Loop System  
Release 2.0.1

## **WipLL System Description**

**1QDF10134AAP-SYD-FCC**

**Issue 03**  
**4 Mbit - Draft 05**

This product is marked with a **CE** Mark. This mark has been affixed to demonstrate full product compliance with the following European directives:

- a) Directive 73/23/EEC - Council Directive of 19/02/1973 on the harmonization of the laws of Member States relating to electrical equipment designed for use within certain voltage limits.
- b) Directive 89/336/EEC - Council Directive of 3/05/1989 on the approximation of laws of the Member States relating to Electro-Magnetic Compatibility (EMC).



This product has been tested and found to comply with the requirements listed in **FCC** Regulations Part 15 for Class "B" digital devices. Compliance with these requirements provides a reasonable level of assurance that use of this product in a residential environment will not result in harmful interference with other electronic devices.

This equipment generates/uses radio frequencies and if not installed and used according to the instructions found in the manuals, may cause interference harmful to the operation of other electronic devices.

This equipment has been tested and found to comply with the limits for a Class B digital device, pursuant to part 15 of the **FCC** rules. These limits are designed to provide reasonable protection against harmful interference in a residential installation. This equipment generates, uses and can radiate radio frequency energy and, if not installed and used in accordance with the instructions, may cause harmful interference to radio communications. However, there is no guarantee that interference will not occur in a particular installation. If this equipment does cause harmful interference to radio or television reception, which can be determined by turning the equipment off and on, the user is encouraged to try to correct the interference by one or more of the following measures:

- Reorient or relocate the receiving antenna
- Increase the separation between the equipment and the receiver
- Connect the equipment into an outlet on a circuit different from that to which the receiver is connected
- Consult the dealer or an experienced radio/TV technician for help

Changes or modifications to this equipment not expressly approved by Marconi Ltd., could void the user's authority to operate the equipment.

The information contained in this document is proprietary and is subject to all relevant copyright, patent and other laws protecting intellectual property, as well as any specific agreement protecting **MARCONI COMMUNICATIONS LTD.**'s rights in the aforesaid information. Neither this document nor the information contained herein may be published, reproduced or disclosed to third parties, in whole or in part, without the express, prior, written permission of **MARCONI COMMUNICATIONS LTD.** In addition, any use of this document or the information contained herein for any purposes other than those for which it was disclosed is strictly forbidden.

**MARCONI COMMUNICATIONS LTD.** reserves the right, without prior notice or liability, to make changes in equipment design or specifications.

Information supplied by **MARCONI COMMUNICATIONS LTD.** is believed to be accurate and reliable. However, no responsibility is assumed by **MARCONI COMMUNICATIONS LTD.** for the use thereof nor for the rights of third parties which may be affected in any way by the use thereof.

Any representation(s) in this document concerning performance of **MARCONI COMMUNICATIONS LTD.** product(s) are for informational purposes only and are not warranties of future performance, either express or implied. **MARCONI COMMUNICATIONS LTD.** standard limited warranty, stated in its sales contract or order confirmation form, is the only warranty offered by **MARCONI COMMUNICATIONS LTD.** in relation thereto.

This document may contain flaws, omissions or typesetting errors; no warranty is granted nor liability assumed in relation thereto unless specifically undertaken in **MARCONI COMMUNICATIONS LTD.** sales contract or order confirmation. Information contained herein is periodically updated and changes will be incorporated into subsequent editions. If you have encountered an error, please notify **MARCONI COMMUNICATIONS LTD.** All specifications are subject to change without prior notice.

Issue Date: 6-Feb-02

Revision Record: WipLL System Description		
Pub. Rev.	Date	Update Description
1.2	Nov-00	First edition and printing. Author: MCIL
1.4	Mar-01	WipLL Release 1.4 Issue 03
2.0	Apr-01	WipLL Release 2.0 Issue 01
Issue Date: 6-Feb-02		
Publication No. 1QDF10134AAP-SYD-FCC		

© Copyright by **MARCONI COMMUNICATIONS LTD.**, 2001. All rights reserved worldwide.



**QUESTIONS / COMMENTS**

If you have questions or comments about this publication, please e-mail to [wipll.doc@marconi.com](mailto:wipll.doc@marconi.com)

Name \_\_\_\_\_ Company \_\_\_\_\_

Tel/Fax/e-mail: \_\_\_\_\_

Publication Name: \_\_\_\_\_ Catalogue No. \_\_\_\_\_

My question/comment is: \_\_\_\_\_

\_\_\_\_\_

\_\_\_\_\_

\_\_\_\_\_

\_\_\_\_\_

\_\_\_\_\_

\_\_\_\_\_

\_\_\_\_\_

\_\_\_\_\_

\_\_\_\_\_

\_\_\_\_\_

Thank you.

Marconi Communications Ltd  
Marketing Department

*This page intentionally left blank*

# Contents

<b>1</b>	<b>GENERAL OVERVIEW .....</b>	<b>1-1</b>
	1.1. Components of the System .....	1-4
	1.1.1. The Subscriber Site .....	1-5
	1.1.2. Base Station Components .....	1-6
	1.1.3. Coverage .....	1-7
	1.2. Management, and Commissioning .....	1-9
	1.2.1. WipManage .....	1-10
	1.2.2. WipConfig .....	1-10
<b>2</b>	<b>MAIN FEATURES, PROTOCOL AND QoS .....</b>	<b>2-1</b>
	2.1. Features .....	2-1
	2.1.1. User Perspective .....	2-1
	2.1.2. Operator Perspective .....	2-2
	2.1.3. Capacity .....	2-2
	2.1.4. QoS .....	2-2
	2.1.5. Configuration .....	2-3
	2.1.6. Installation and Commissioning .....	2-3
	2.1.7. Security .....	2-4
	2.1.8. MAC Protocol .....	2-4
	2.1.9. Radio Communications .....	2-5
	2.1.10. Management .....	2-5
	2.1.10.1. Network Management Systems (NMS) .....	2-5
	2.1.11. System Parameters .....	2-6
	2.1.12. RF .....	2-6
	2.1.13. Network .....	2-6
	2.1.14. Application .....	2-6
	2.2. PPMA Protocol .....	2-7



## WipLL System Description

---

2.2.1. What is PPMA? .....	2-7
2.2.1.1. Concept.....	2-7
2.2.1.2. Slotted Aloha Process.....	2-7
2.2.1.3. Packet Transmission.....	2-8
2.2.1.4. Polling Sequence .....	2-8
2.3. Security .....	2-9
2.3.1. Login Mechanism .....	2-9
2.4. QoS .....	2-10
2.5. Echo Management .....	2-11
<b>3 APPLICATIONS AND SERVICES.....</b>	<b>3-1</b>
3.1. Applications.....	3-1
3.1.1. Fixed Cellular Access System .....	3-1
3.1.2. Connecting the Base Station to the Network Backbone .....	3-3
3.1.3. Remote Base Station Backhaul .....	3-4
3.1.3.1. Indoor Coverage (Not for use in North America) ...	3-6
3.2. Services .....	3-7
3.2.1. Broadband Data Access.....	3-7
3.2.2. High Speed Internet Access .....	3-7
3.2.3. Private Networks .....	3-8
3.2.4. Remote Access .....	3-9
3.2.5. Video Over IP .....	3-9
<b>4 BSR.....</b>	<b>4-1</b>
4.1. Base Station Radio .....	4-1
4.1.1. BSR Default Accessories .....	4-2
4.2. Network Management .....	4-3
4.2.1. Capabilities .....	4-3
4.2.2. Physical Interfaces .....	4-4
4.2.3. Communication Interfaces.....	4-5



## Contents

---

4.2.4. Features and Protocols .....	4-6
4.2.4.1. Features .....	4-6
4.2.4.2. Protocols .....	4-6
<b>5 BSDU .....</b>	<b>5-1</b>
5.1. Base Station Distribution Unit .....	5-1
5.2. Network Management .....	5-2
5.2.1. Management Information Base .....	5-2
5.2.2. Capabilities .....	5-2
5.3. Physical Interfaces .....	5-2
5.3.1. Connectors .....	5-2
5.3.2. Communication Interfaces .....	5-3
5.4. Features and Protocols .....	5-3
5.4.1. Features .....	5-3
5.4.2. Protocols .....	5-3
5.5. Table of Specifications - BSDU .....	5-3
5.5.1. Network Specifications .....	5-3
5.5.2. Power Requirements .....	5-4
5.5.3. Environmental Conditions .....	5-4
5.5.4. Network Interface .....	5-4
5.5.5. Standards Compliance .....	5-4
5.5.6. Physical Dimensions .....	5-4
<b>6 SPR .....</b>	<b>6-1</b>
6.1. Subscriber Premises Radio .....	6-1
6.2. SPR/BSR Communications .....	6-2
6.2.1. SPR Configurations .....	6-3
6.2.2. SPR Standard Accessories .....	6-3
6.2.3. Network Management .....	6-3
6.2.4. Capabilities .....	6-4



## WipLL System Description

---

6.2.5. Physical Interfaces .....	6-4
6.2.5.1. Connectors:.....	6-4
6.2.5.2. Communication Interfaces: .....	6-4
6.2.6. Features and Protocols .....	6-4
6.2.6.1. Features.....	6-4
6.2.6.2. Protocols.....	6-5
6.3. Interface Connectors.....	6-10
<b>7 Customer Interface Adaptors.....</b>	<b>7-1</b>
7.1. General .....	7-1
7.1.1. Configurations .....	7-1
7.2. SDA.....	7-1
7.2.1. SDA Specifications.....	7-2
<b>8 BSPS.....</b>	<b>8-1</b>
8.1. General.....	8-2
8.2. Main Rack.....	8-3
8.2.1. Main Rack.....	8-3
8.2.2. Front Panel .....	8-4
8.2.3. Rear Panel.....	8-4
8.3. Extension Rack (optional).....	8-5
8.3.1. Overview .....	8-5
8.3.2. Front Panel .....	8-6
8.3.3. Rear Panel.....	8-7
8.4. DC Distribution Rack (optional) .....	8-7
8.4.1. Overview .....	8-7
8.4.2. Front Panel .....	8-8
8.4.3. Rear Panel.....	8-8
8.5. Basic Rectifier Module.....	8-9
8.5.1. Block Diagram.....	8-10





## Contents

---

8.5.2. Front Panel .....	8-11
8.6. System Controller Module .....	8-12
8.6.1. Front Panel .....	8-12
8.6.2. Main Functions.....	8-13
8.6.3. Host Communication.....	8-14
8.7. Communication Protocol & Data .....	8-14
8.7.1. Master	8-15
8.7.2. Slave	8-15
<b>Appendix.....</b>	<b>9-1</b>
9.1. New Features – Release 2.0.1.....	9-1
9.2. New Features – Release 1.4.....	9-1
9.3. BSPS.....	9-1
9.4. Improved Quality of Service (QoS).....	9-2
9.5. Bandwidth limitations .....	9-2
9.6. SNMP support for BSDU.....	9-3
9.7. IntraCom.....	9-3
9.8. Configuring IP on the air .....	9-3
9.9. Default configurations via WipConfig & WipManage.....	9-4
9.10. RSSI analysis in WipConfig.....	9-4
9.11. What is RFC 1918?.....	9-4

## Figures

Figure 1-1: Typical WipLL System Partitioning .....	1-2
Figure 1-2: Typical WipLL System .....	1-3
Figure 1-3: Typical Subscriber Configuration.....	1-5
Figure 1-4: Base Station Units .....	1-6
Figure 1-5: Base Station Covering 360° .....	1-7
Figure 1-6: Base Station Giving Partial Cover .....	1-8
Figure 1-7: Base Station with Complete BSR Redundancy .....	1-8
Figure 1-8: Base Station Sector.....	1-9
Figure 2-1: WipLL QoS Mechanism.....	2-10
Figure 2-2: Echo Control.....	2-11
Figure 3-1: WipLL Cell .....	3-2
Figure 3-2: WipLL Coverage Planning.....	3-4
Figure 3-4: WipLL Backhauling.....	3-5
Figure 3-6: WipLL Indoor Coverage.....	3-6
Figure 3-7: WipLL Private Networking .....	3-8
Figure 4-1: Typical BSR Installation.....	4-2
Figure 4-2: BSR Assembly.....	4-4
Figure 5-1: The WipLL BSDU .....	5-1
Figure 6-1: Typical SPR Installation.....	6-1
Figure 6-2: Typical Subscriber Site.....	6-2
Figure 6-3: SPR Assembly.....	6-10
Figure 7-1: Subscriber Data Adapter (SDA) .....	7-3
Figure 8-1: BSPS Block Diagram.....	8-2
Figure 8-2: BSPS Main Rack - Front Panel .....	8-4
Figure 8-3: BSPS Main Rack - Rear Panel.....	8-5
Figure 8-4: BSPS Extension Rack - Front Panel .....	8-6
Figure 8-5: BSPS Extension Rack - Rear Panel.....	8-7

Figure 8-6: BSPS DC Distribution Rack - Front Panel..... 8-8

Figure 8-7: BSPS DC Distribution Rack - Rear Panel ..... 8-8

Figure 8-8: BSPS Rectifier - Simplified Block Diagram..... 8-10

Figure 8-9: BSPS Rectifier Module - Front Panel ..... 8-11

Figure 8-10: BSPS System Controller - Front Panel..... 8-12

Figure 8-11: DB9 Connector ..... 8-14



## Tables

Table 4-1: Antenna Unit Connectors.....	4-5
Table 4-2: BSR and MAC Specifications .....	4-7
Table 4-3: BSR Agency Certification .....	4-8
Table 4-4: BSR Network Specifications .....	4-8
Table 4-5: BSR Power Requirements.....	4-8
Table 4-6: BSR Environmental Conditions .....	4-8
Table 4-7: BSR Network Interface .....	4-9
Table 4-8: BSR Physical Dimensions .....	4-9
Table 5-1: BSDU Physical Dimensions.....	5-4
Table 6-1: Radio and MAC Specifications .....	6-6
Table 6-2: Agency Certification.....	6-6
Table 6-3: Network Specifications .....	6-8
Table 6-4: Power Requirements .....	6-8
Table 6-5: Environmental Considerations.....	6-8
Table 6-6: Network Interface.....	6-8
Table 6-7: SPR Physical Dimensions (w/o High Gain Antenna).....	6-9
Table 6-8: SPR Physical Dimensions (with High Gain Antenna).....	6-9
Table 6-9: SPR Connectors .....	6-11
Table 7-1: Data Connections .....	7-3
Table 8-1: Rectifier Specifications .....	8-11

## Glossary

<b>ACK</b> .....	Acknowledge
<b>API</b> .....	Application Program Interface
<b>BER</b> .....	Bit Error Rate
<b>BSDU</b> .....	Base Station Distribution Unit
<b>BSPS</b> .....	Base Station Power System
<b>BSR</b> .....	Base Station Radio
<b>CLI</b> .....	Call Level Interface
<b>CRC</b> .....	Cyclic Redundancy Check
<b>CROL</b> .....	Call Rollout
<b>CTS</b> .....	Clear to Send
<b>DHCP</b> .....	Dynamic Host Configuration Protocol
<b>DNS</b> .....	Domain Name System
<b>ELCB</b> .....	Earth Leakage Circuit Breaker
<b>FTP</b> .....	File Transfer Protocol
<b>ICMP</b> .....	Internet Control Message Protocol
<b>IDC</b> .....	Insulation Displacement Connector
<b>IP</b> .....	Internet Protocol
<b>LVD</b> .....	Low Voltage Disconnect
<b>MAC</b> .....	Media Access Control
<b>MCB</b> .....	Main Circuit Breaker
<b>MIB</b> .....	Management Information Base
<b>NMS</b> .....	Network Management System



## WipLL System Description

---

<b>NOC</b>	.....	Network Operations Centre
<b>ODBC</b>	.....	Open Database Connectivity
<b>PING</b>	.....	Package Internet Groper
<b>PMPT</b>	.....	Point-to-Multi-Point
<b>PPMA</b>	.....	Pre-emptive Polling Multiple Access
<b>PPP</b>	.....	Point to Point Protocol
<b>QoS</b>	.....	Quality of Service
<b>RCCB</b>	.....	Residual Current Circuit Breaker
<b>RCD</b>	.....	Residual Current Device
<b>RSSI</b>	.....	Received Signal Strength Indicator
<b>RTS</b>	.....	Request to Send
<b>SDA</b>	.....	Subscriber Data Adapter
<b>SNMP</b>	.....	Simple Network Management Protocol
<b>SPE</b>	.....	Subscriber Premises Equipment
<b>SPR</b>	.....	Subscriber Premises Radio
<b>TCP</b>	.....	Transmission Control Protocol
<b>TDMA</b>	.....	Time Division Multiple Access
<b>TFTP</b>	.....	Trivial File Transfer Protocol
<b>TTL</b>	.....	Time to Live
<b>UDP</b>	.....	User Datagram Protocol
<b>URL</b>	.....	Uniform Resource Locator
<b>VoIP</b>	.....	Voice over Internet Protocol

## GENERAL OVERVIEW

WipLL is a broadband fixed cellular Wireless Access system. It provides an "all-in-one" broadband access solution for operators and network service providers supporting data applications including "toll quality" telephony service<sup>1</sup> over a single integrated platform. WipLL utilizes air protocol that enables one of WipLL's unique features - the ability to recognize the type of the transmission and assign bandwidth and other resources accordingly.

As an integrated broadband cellular wireless system WipLL is a complete system solution for carriers and providers of multiple fixed access services to the SME (small to medium enterprises), SOHO (small office / home office) and residential marketplace demanding video, voice and data access.

The WipLL system can be considered as functionally divided between three sites as described in Figure 1-1:

- Subscriber Premises Sites
- Base Station Sites
- A Network Operations Center (NOC) and planning site

The Base Station Site and the Subscriber Premises site each contain WipLL hardware whilst the NOC uses software and associated hardware platforms to plan, configure and manage the WipLL system.

---

<sup>1</sup> From WipLL Release 1.4.

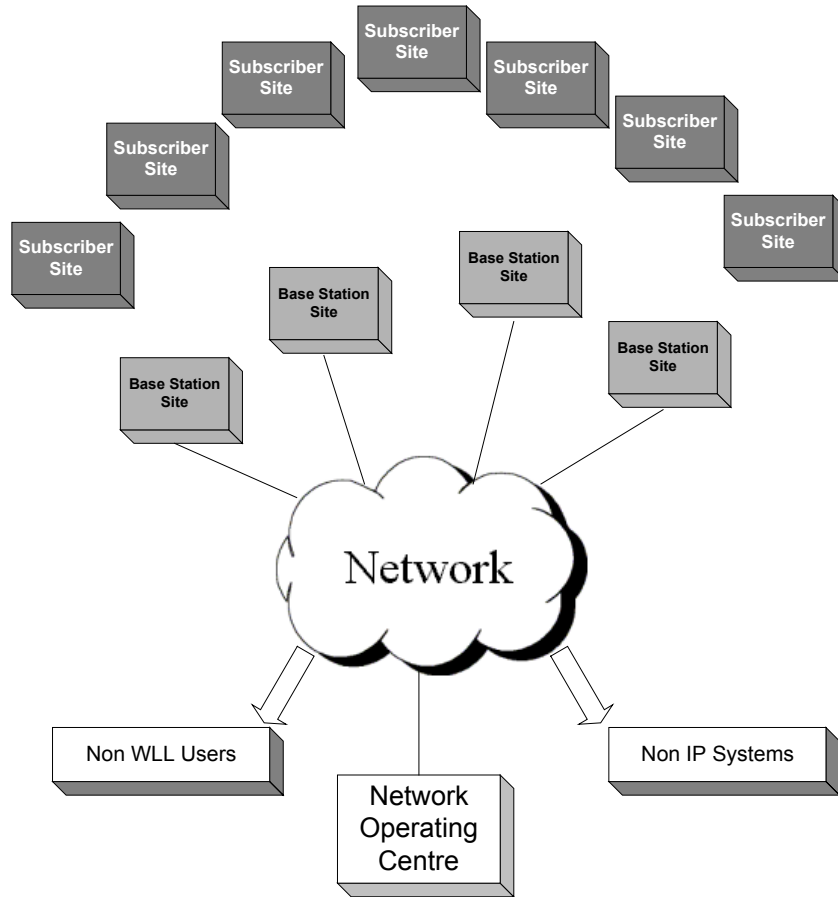

**Figure 1-1: Typical WipLL System Partitioning**

WipLL provides a radio link between the end-user of the telecom network (the subscriber) and the network itself to give high-speed data access. WipLL uses Internet Protocol (IP) to communicate between subscribers.

WipLL comprises radio transceivers installed at subscriber premises and further transceivers at local base stations. A transceiver at a subscriber premises links



through radio to its local base station. The base station then links through an Ethernet connection to datacom or IP network.

Each local base station serves numerous subscribers in its vicinity. The WipLL components at the subscribers' premises and at the base stations can be remotely controlled and configured by a management system using Simple Network Management Protocol (SNMP).

Figure 1-2 shows a diagram of a Typical WipLL installation.

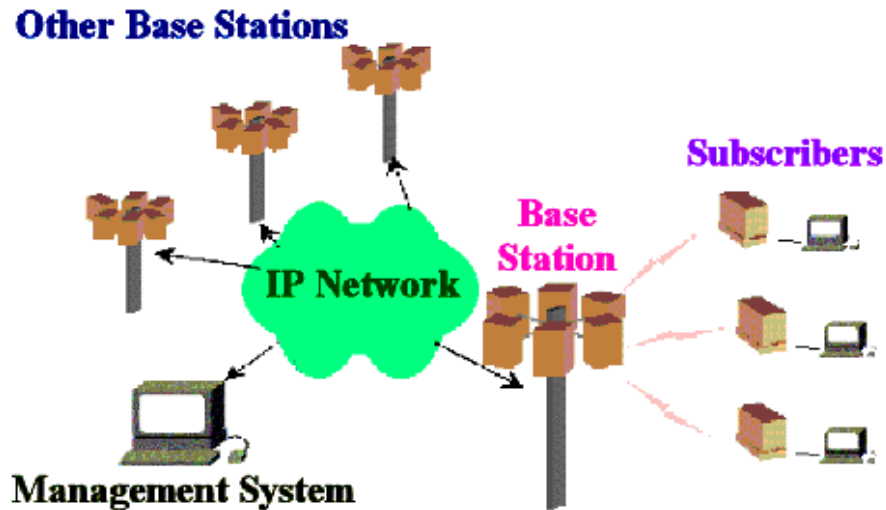

Figure 1-2: Typical WipLL System

WipLL supports multiple applications integrated on a single platform, such as:

- High-rate data transfer
- Video conferencing
- Internet access



## WipLL System Description

---

- Voice over IP

### 1.1. Components of the System

The WipLL system comprises three main components as indicated in Figure 1-1:

- 1) Subscriber site
- 2) Base station
- 3) Coverage

#### 1.1.1. The Subscriber Site

Each subscriber site contains Subscriber Premises Equipment (SPE) that links the subscriber to the WipLL system.

The SPE consists of:

- A Subscriber Premises Radio (SPR)
- A subscriber adapter or one of a set selected per application

The SPE performs routing functions between the customer site and the base station. The SPE also performs local Quality of Service (QoS) functions, such as re-ordering packets and assigning Time-to-Live (TTL).

The following drawing shows a current typical subscriber site installation:

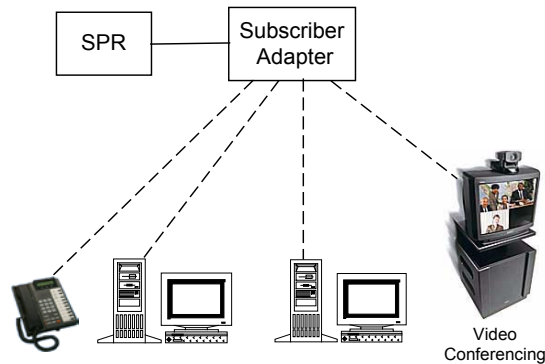

**Figure 1-3: Typical Subscriber Configuration**

## 1.1.2. Base Station Components

Each base station site contains several components that enable:

- Connection to telecom system
- Internal switching of traffic
- Power supply
- Radio communications.

Some of these components are mandatory and others optional depending on the configuration of the site and the particular type of network backbone interconnection.

Each Base Station Radio (BSR) is optionally physically connected to a Base Station Distribution Unit (BSDU), which provides data connectivity, power, and local switching functionality. A BSDU can serve up to six BSRs, and up to four BSDUs can be chained in a single base station to support up to 24 BSRs.

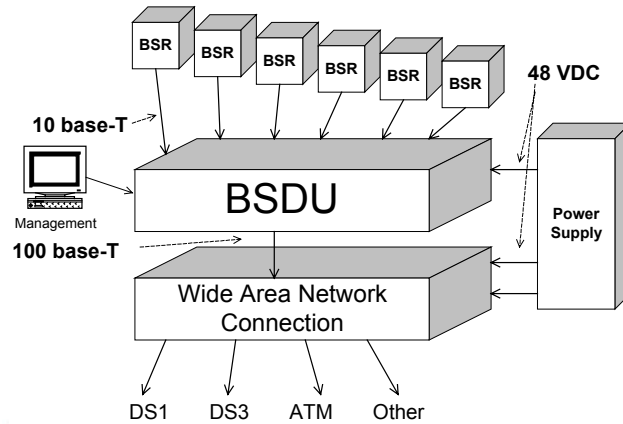

**Figure 1-4: Base Station Units**

A BSR can maintain a 4 Mbit air link with customers in its sector (net throughput of 3.2 Mb/s). A single base station has a capacity of up to 96 Mb/s and can support up to 3024 customer sites. The area covered by a single base station is called a cell and can extend to a radius of up to 25 km in ideal locations, about 6 km in suburban locations and about 2 km in urban locations dependent on locally permitted RF transmission power.

### 1.1.3. Coverage

Each base station provides a wireless link to all subscribers in the base station's area or domain. For full coverage several base stations can be set up over an extended area.

WipLL works in accordance with the operator's backbone and uses the backbone to connect between base stations, the central management station, and other resources on the network. WipLL assumes a network backbone that uses IP. The area covered by a base station is divided into sectors. Each sector is built around a Base Station Radio (BSR) unit which is the central coordinator of the sector.

Chapter 1 - GENERAL OVERVIEW

The BSR can transmit and receive through a 60 degree sector. To cover a full 360 degree sweep, requires six BSRs at the base station which will comprise six sectors each covered by a BSR.

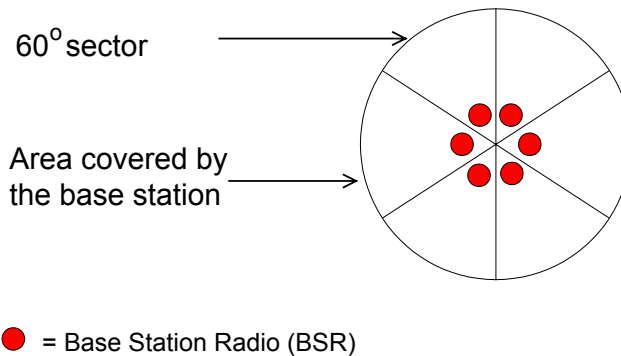

Figure 1-5: Base Station Covering 360°

Not all six sectors need be equipped. For example at a housing development that faces open farmland, one could site a base station that only covers 180 degrees to provide facilities only to the housing development.

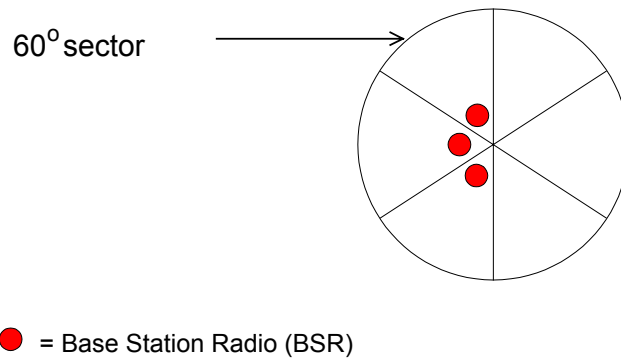
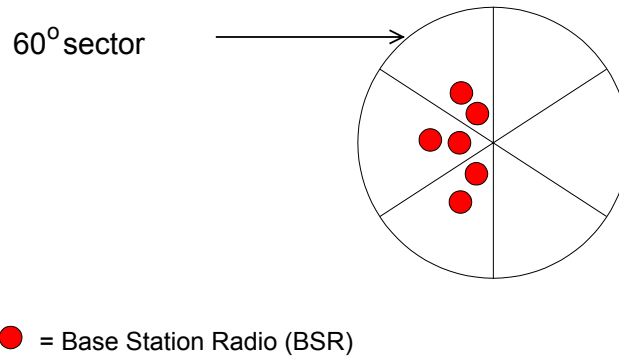

Figure 1-6: Base Station Giving Partial Cover



**Figure 1-7: Base Station with Complete BSR Redundancy**

Alternatively, the base station can have up to twenty-four BSRs, each covering 60 degrees. This allows either:

- Complete BSR redundancy with two or more BSRs covering each sector - see Figure 1-7

or

- Partial sector overlap with each layer of BSRs offset to the one above it - see Figure 1-8. This gives more capacity in areas where high demand requires more bandwidth.

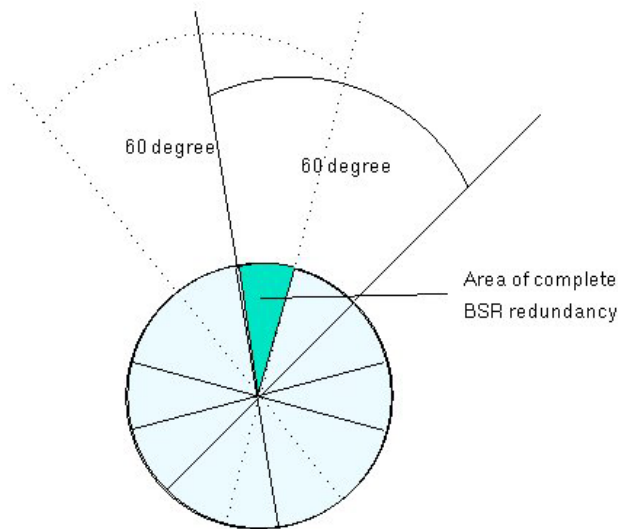

Figure 1-8: Base Station Sector

## 1.2. Management, and Commissioning

WipLL uses two tools for management and commissioning both implemented as software programs:

- The WipLL network management tool - WipManage
- WipConfig

Further information on the use of these tools can be found in the Operations and Maintenance Manual.



## WipLL System Description

---

### 1.2.1. WipManage

WipManage™ is the primary WipLL network management tool for every WipLL unit. It enables:

- Configuration
- Fault isolation
- Performance monitoring
- Software upgrade

WipManage can access each unit in the system and manage it remotely using standard SNMP protocols for communicating with the WipLL unit, private and standard MIBs for setting and retrieving parameters from the units.

The top hierarchy of WipManage™ is a base-station site view from which one can zoom into every Subscriber Premises Radio (SPR).

WipManage™ can also be run as a stand-alone program running on Microsoft Windows NT.

Inputs to WipManage™ include the manual entry of parameters and retrieval of parameters directly from the WipLL units. WipManage™ outputs are sent either to the WipLL units or saved to the database as required.

### 1.2.2. WipConfig

WipConfig is a configuration tool for the WipLL units. It provides the flexibility to configure the units before leaving the shop or after the actual installation at the customer site.

WipConfig enables:

- Technicians to configure and monitor parameters at the WipLL units.





## Chapter 1 - GENERAL OVERVIEW

---

- Use of inputs from either a .CFG file that is produced by a database application or manually by typing the parameters into the appropriate fields of the program.
- Configuration and monitoring of the WipLL units via a serial or Ethernet port. It supports Microsoft Windows 9x and Windows 2000 platforms.



**WipLL System Description**

---

*This page intentionally left blank*

## **MAIN FEATURES, PROTOCOL AND QoS**

The WipLL system is designed to provide internet access and telephony service using spread spectrum frequency hopping technology to minimize interference in the 2.4 GHz ISM, 3.5 GHz band, and 4GHz bands

Data is transmitted as Internet Protocol (IP) packets. Each packet is divided into fragments, and fragments can be repeated several times to ensure Quality of Service (QoS). Other techniques such as CRC and space diversity further enhance the system performance.

WipLL is an IP based platform that enables multiple applications over a single platform utilizing a quality of service mechanism that ensures the transmission of packets according to a pre-defined policy.

This chapter lists the most significant features and advantages of the WipLL system, including its protocol and Quality of Service (QoS) mechanism.

### **2.1. Features**

WipLL was designed with the future in mind. Users, operators, service providers and installers can benefit from WipLL's unique features.

#### **2.1.1. User Perspective**

- Always connected.
- Standard 10Base-T connection.
- High throughput.



## WipLL System Description

---

- Leverages new technologies and applications.
- Built-in security features.

### 2.1.2. Operator Perspective

Very efficient network due to:

- Single access platform for multiple applications.
- Bandwidth used only when there is real data to transmit.
- Shared bandwidth between users.
- No dedicated bandwidth to customer but capabilities to ensure throughput to the users.
- Uncommitted direction of transmission, no need to commit to full duplex.
- Control of bandwidth and delay according to pre-defined policy.

### 2.1.3. Capacity

- High bit rate – up to 4Mbps per channel (using 1MHz of bandwidth at 1, 2, and 3Mb/s and 2MHz at 4Mb/s).
- Synchronization between BSRs to enable wide area coverage (Not in North America).

### 2.1.4. QoS

- Recognition of packet and session type and assignment of resources accordingly.
- Multiple applications over the same connection.
- Bandwidth on demand.
- Service on demand.

### 2.1.5. Configuration

- Integrated IP router.
- Single outdoor box solution, i.e. no external SPR antennas or RF cables.
- Up to 100 meters of standard category 5 cable from the radio unit to the indoor adapter.
- Standard 10Base-T interface to the subscriber site and 100Base-T interface to the network backbone.

### 2.1.6. Installation and Commissioning

- Easy installation and commissioning – using the WipConfig tool.
- Real time signal strength indication.
- No RF cables involved.
- All parameters can be configured locally or remotely.



**Important!!**

- BSR-2.4 and SPR-2.4 outdoor units with internal antennas should be installed ONLY by experienced installation professionals who are familiar with local building and safety codes and, wherever applicable, are licensed by the appropriate government regulatory authorities. Failure to do so may void the MARCONI product warranty and may expose the end user or the service provider to legal and financial liabilities. MARCONI and its resellers or distributors are not liable for violation of regulations associated with the installation of outdoor units.



## **WipLL System Description**

---

- All installed units are installed with a separation distance of at least 2 meters from all person during normal operation.
- Both the BSR and SPR (as well as antenna) must be mechanically and electronically isolated from and not co-located with any other antenna or transmitter.

### **2.1.7. Security**

- Login process with authentication mechanism.
- Data scrambling using public and private keys.

### **2.1.8. MAC Protocol**

- Supports up to 126 subscriber sites per BSR, up to 3024 subscriber sites per base station.
- High efficiency – 80% of the bit rate.
- Automatic rate control to maximize throughput under high Bit Error Rate (BER).
- Re-transmission of lost packets – reliable operation in a high BER environment
- Centrally coordinated air protocol – designed for point to multipoint environment.
- No transmission collisions.
- Real-time assessments on required and available bandwidth resources to control data flow.
- Intelligent polling of SPRs.

### **2.1.9. Radio Communications**

- Frequency hopping spread spectrum system (FH-CDMA).
- Integrated antenna diversity in a single box.
- The BSR also has an N-Type connector for attaching an optional 3<sup>rd</sup>-party external antenna i.e. omni-antenna for 360° coverage by a single BSR.<sup>1</sup>
- Variety of antenna types, internal and external.
- Configurable maximum output power – up to 27dBm.
- Automatic power control to minimize interference between cells and to reduce transmission power where possible.
- Configurable frequency tables for efficient re-use of available bandwidth.

### **2.1.10. Management**

#### **2.1.10.1. Network Management Systems (NMS)**

- SNMP agent at each WipLL unit.
- Comprehensive network management system based on SNMP for local and remote management.
- Standard and proprietary Management Information Bases (MIB).
- Configuration management.
- Fault isolation.
- Performance monitoring.

---

<sup>1</sup> For 2.4GHz application only, an external antenna may have a gain of 11dbi. Responsibility of compliance is left to the customer.



## WipLL System Description

---

- Software upgrade of every WipLL unit using TFTP.
- Support for standard IP protocols – ARP, DHCP relay, TFTP, ICMP, and SNMP.

### 2.1.11. System Parameters

- Temperature range of –30°C to +60°C.
- Compliance with ETSI and FCC Regulations.

### 2.1.12. RF

This environment consists of point to multi-point directional antennas pointing towards the base station. Distances between stations and the base station may differ. Some may be near while others may be far away.

Additional features include:

- Multi-site – mutual interference.
- Frequency hopping.
- Multi-rate: Sensitivity of the receiver changes and is dependent on the bit rate.

### 2.1.13. Network

- Ethernet packets – between 64 and 1518 bytes.
- Burst of packets or constant flow to/from users – depending on the application.

### 2.1.14. Application

Data – different types of applications generate requirements for:

- Assignment of delays.



- Allowed packet loss rate that applications can sustain.
- Bandwidth for the application - video requires constant signal flow:
  - Packets are generated usually every 30ms. (depending on the Residential Access Gateway (RAG) and sampling rate)
  - Requires minimal delay.
  - Silence suppression – no packets

## **2.2. PPMA Protocol**

This section describes the Pre-emptive Polling Multiple Access (PPMA) protocol. It discusses the environment in which this protocol operates, its task and description of the PPMA protocol as used by WipLL.

To support the above environment the main task of the PPMA protocol is to combine all these requirements in the most efficient manner.

### **2.2.1. What is PPMA?**

#### **2.2.1.1. Concept**

PPMA is a centrally coordinated protocol. The BSR performs the task of coordination over the air. It constantly gathers information from the Subscriber Premises Radio (SPR) regarding their requirements for resources. These are rated according to the combination of parameters such as the number of packets in the SPR queues and the maximum allowed delay for the first packet in the queue. Once the BSR has determined the requirements of resources for the next few milliseconds it starts to poll the SPRs accordingly. SPRs that receive the highest score are polled first and the others follow in order.

#### **2.2.1.2. Slotted Aloha Process**

The constant gathering of information regarding the required resources from the SPRs is performed by using a mechanism called "Slotted Aloha".



## WipLL System Description

---

From time to time (and not exceeding every 100mS) the BSR sends a "Channel Clear" message which is an invitation for SPRs to send the score of their requirements. It then waits for a while and receives these requirements from the SPRs. The waiting time is called **Slotted Aloha** due to the fact that the BSR waits for a time that is equivalent to 16 messages of "Request to Send" (RTS). The messages are synchronized so that an SPR does not transmit a message before the previous message is ended. The timing of each RTS message is represented as a "Slot".

SPRs are independent to choose which slots to use for sending their requirements. Occasionally a collision between SPRs can occur on a slot and then the probability is that the request is lost. Each SPR can use more than one slot to send its request. An SPR that was not allowed to transmit might try again during the next Slotted Aloha process.

This system ensures that all SPRs eventually get a fair chance to transmit their requests.

### 2.2.1.3. Packet Transmission

After the BSR has gathered the requests from the SPRs and decided on the priorities, it sends a "Clear to Send" (CTS) message to the first SPR. The packet is then transmitted from the SPR.

In the header of each packet more information about the status of the queues is included thus avoiding the need for the SPR to participate in the next Slotted Aloha process.

The data packet is divided into fragments and each fragment is added with CRC (Cyclic Redundancy Check). After the packet is complete, an "Acknowledge" (ACK) message is sent by the BSR that includes information about all fragments that were reported as errors. These fragments can be repeated several times until the entire message is successfully transmitted.

### 2.2.1.4. Polling Sequence

Each time the BSR sends a CTS (Clear to Send) message to one of the SPRs it is considered as if the SPR is being polled.

Polling of SPRs can happen according to the information gathered during the Slotted Aloha process or in a periodic manner – every few milliseconds – regardless of the Slotted Aloha process depending on the application transmitting data at the time. The polling sequence of data applications is managed by the BSR based on the information gathered during the Slotted Aloha process. Data applications can sustain relatively long delays before expecting a response and therefore their packets can be delayed within the SPRs before being sent to the BSR and on to the network. Other applications which require a smaller delay for their packets are polled first. Some applications are configured to transmit a burst of several packets in a row before expecting any response from the other party. In such a case the polling mechanism is able to support several polls of an SPR one after the other. This mode is called "PPMA" (Preemptive Polling Multiple Access). Real-time applications such as video often sends a constant flow of packets. In this case the BSR polls the SPR that is related to such an application in accordance with the flow of the packets. IP Telephony systems send packets about every 30ms and require a very small delay. Therefore, an SPR that was recognized as sending packets is polled usually every 30ms (see 2.1.14) without having to go through the Slotted Aloha process to inform the BSR about each packet. This mode is called "Adaptive TDMA" (Time Division Multiple Access).

## **2.3. Security**

Being a centrally coordinated protocol gives PPMA several options of security that are independent of other layers.

### **2.3.1. Login Mechanism**

In order to be served by a BSR an SPR must be registered to it. This registration process is based on the SPR's MAC address and the BSR address that is configured by the network management.

When a new SPR tries to register to the BSR it sends a "Request to Send" message during the "Slotted Aloha" time. The BSR then checks if the SPR MAC address is listed as an "Allowed SPR" list. This list is maintained by the network management system. If it is listed as such then an "Association" message is sent to the SPR that includes information about the cell such as the public key for the encoding, number



## WipLL System Description

---

of users, etc. The SPR then sends its own information to the BSR. It is then considered as being "associated" with the BSR and can start sending and receiving messages from it.

In case the SPR is not included in the "Allowed SPR" list or the address it provides for the BSR is incorrect no message will be sent to it and the association process will be terminated.

### 2.4. QoS

Quality of Service (QoS) is the ability to recognize the type of the transmission and assign bandwidth and other resources accordingly.

Resources are not necessarily only in terms of bandwidth but also in terms of delays, packet loss rate and whether or not data needs to be retransmitted in case it is lost.

Figure 2-1 represents the idea behind the QoS. Some applications require more network resources than others.

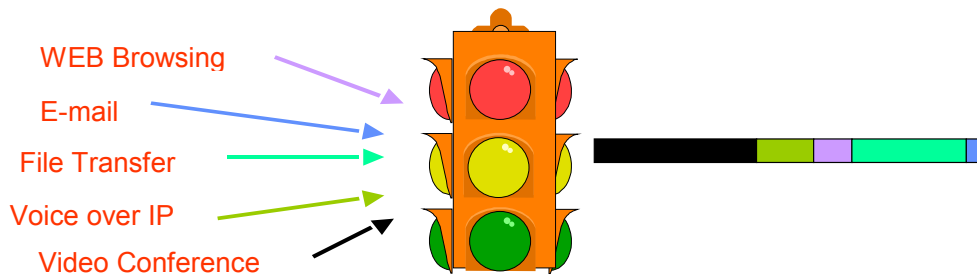

Figure 2-1: WipLL QoS Mechanism

QoS measurements are based on 2 factors, assigned traffic priority (0 through 7) and Time-To-Live (TTL) factor (1 through 5):

- 1) **Network protocol - IP**
- 2) **Transport protocol – TCP, UDP, ICMP**
- 3) **Transport protocol and port number** (based on application type)
- 4) **IP address**

5) Session type - VoIP

## 2.5. Echo Management

Packet based systems are likely to introduce more delay (and variable) than circuit switched systems. Increased delay could present quality problems with time bounded services such as voice communication.

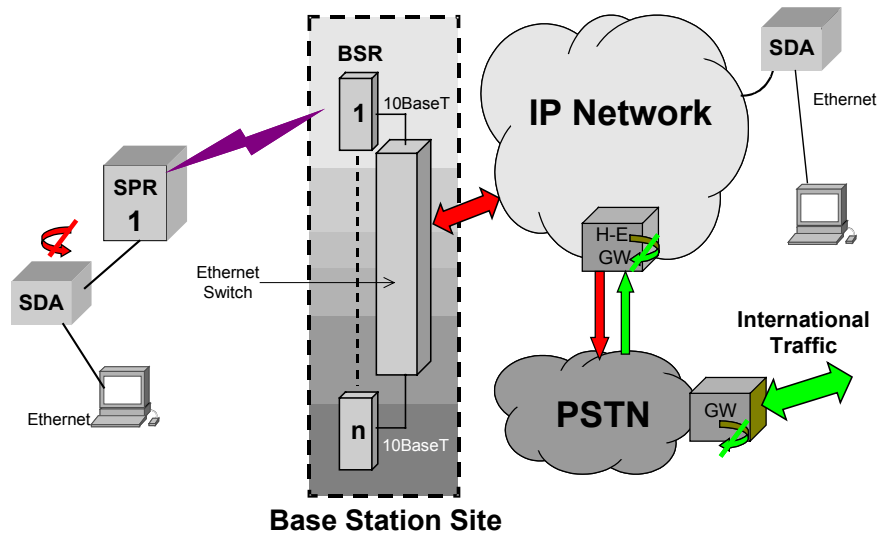

Figure 2-2: Echo Control

As can be seen from Figure 2-2, echo becomes an issue when a voice call is established between a customer connected to an SDA and a PSTN customer. Echo is generated at the 2 wire-4 wire hybrid in the PSTN customer's line card and has to be cancelled.



## **WipLL System Description**

---

PSTN has traditionally been a low delay network and has not bothered with echo cancellation, at least in smaller countries, if the round trip delay is below 50ms. Echo cancellers are used in international calls between different PSTNs.

The key principle is that the network that causes the echo should cancel it. Applying this principle to the introduction of IP based WLL systems means that echo should be handled in the access system. To this end, in Marconi Communications' WipLL system echo cancellation has been implemented in both the SDA (up to 8ms) and the head-end gateways (up to 64ms).

## APPLICATIONS AND SERVICES

WipLL can be installed in several configurations to support different required applications. The following paragraphs discuss some of the applications and services that can be provided with WipLL.

### 3.1. Applications

#### 3.1.1. Fixed Cellular Access System

Typically WipLL is used as a broadband fixed wireless access system. It is installed in a cellular structure where many base station sites are installed in a way that provides full coverage of an area for enabling access for all potential customers in the area.

Each cell consists of sectors that are determined by base station radios (BSRs).

The following figure shows the structure of a typical WipLL cell.

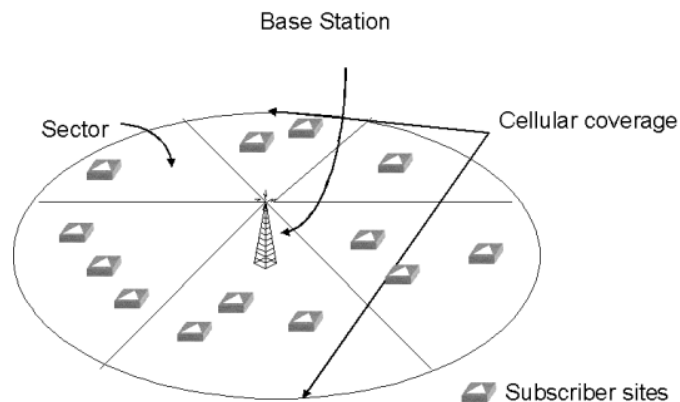



## WipLL System Description

---

**Figure 3-1: WipLL Cell**

Subscriber Premises Radios (SPRs) are normally installed on a rooftop or a wall which has a direct line of sight to the base station radio (BSR) and are pointed towards the nearest base station or the base station that was assigned according to the pre-planning of the site.

Base stations typically contain several BSRs for providing a full (360°) coverage as well as enough capacity to accommodate the requirements of subscribers.

When a full area is covered, WipLL can provide services to tens of thousands of users. The backbone must be able to carry the required capacity, delays and connectivity in order to support the services and requirements of all users.

Prior to installation, a full site planning is required. Such planning normally includes forecasts of the required capacity based on the number of users, typical subscription contract, types of service, required bit rate per subscriber, etc.

It also includes radio planning for determining the best locations for BSRs – to ensure full coverage, frequency allocation – to minimize mutual interference and tilting options to determine the covered area for each sector of a base station.



**Important!!**

- BSR-2.4 and SPR-2.4 outdoor units with internal antennas should be installed ONLY by experienced installation professionals who are familiar with local building and safety codes and, wherever applicable, are licensed by the appropriate government regulatory authorities. Failure to do so may void the MARCONI product warranty and may expose the end user or the service provider to legal and financial liabilities. MARCONI and its resellers or distributors are not liable for violation of regulations associated with the installation of outdoor units.
- All installed units are installed with a separation distance of at least 2 meters from all person during normal operation.

### **3.1.2. Connecting the Base Station to the Network Backbone**

The base station connects to the network backbone via  $2 \times$  RJ45 100Base-T connections.

Figure 3-2 shows planning of a few base stations that cover an area.

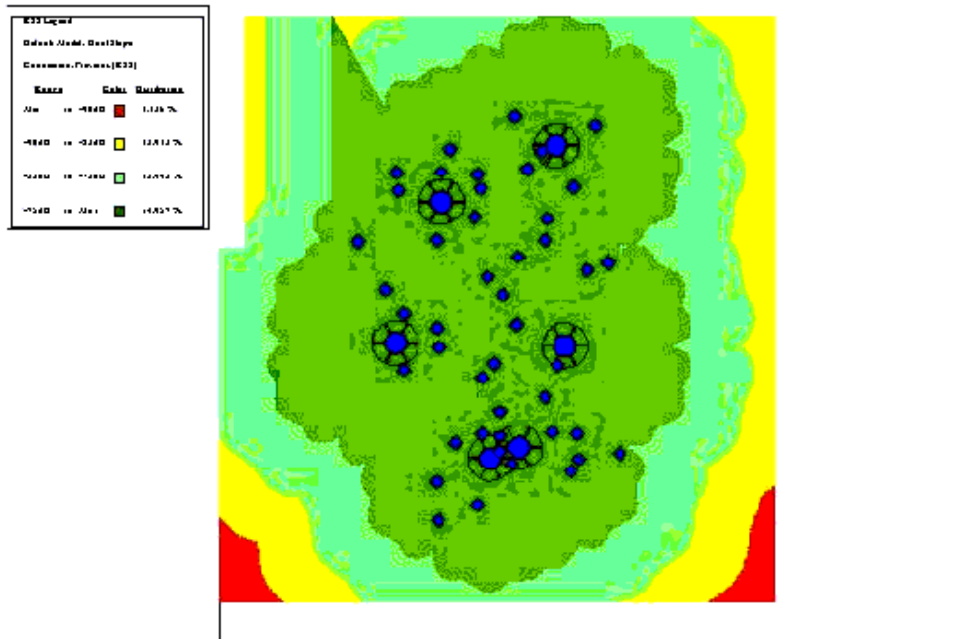

Figure 3-2: WipLL Coverage Planning

### 3.1.3. Remote Base Station Backhaul

Occasionally, when base stations are providing services to a small number of subscribers or when large capacity is not required, WipLL SPRs and BSRs can be used for backhauling.

Such configurations can be considered in most cases as a point-to-point (PTP) connection.

Each PTP connection can provide up to 4Mbps of bandwidth and is equivalent or better than a typical point-to-multi-point (PMP) connection that is used in a typical base station installation.

Figure 3-3 shows a typical backhauling of a base station using WipLL.

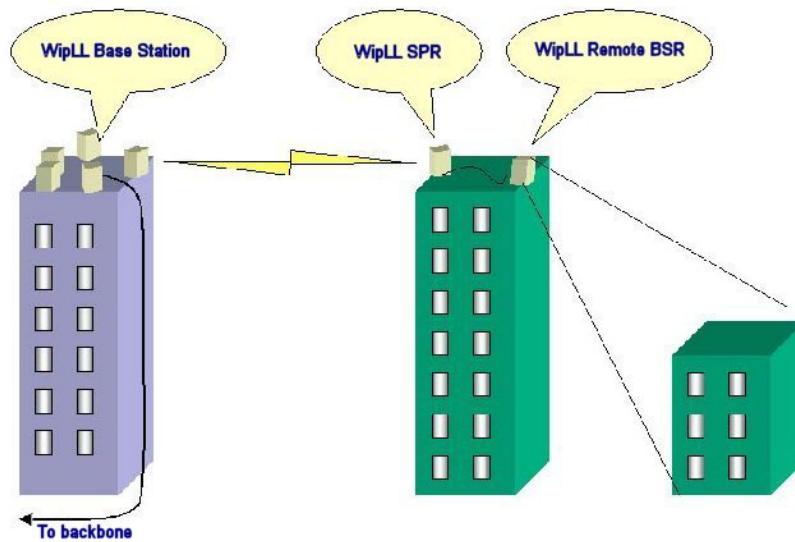

Figure 3-3: WipLL Backhauling

Remote base stations are typically required when the main base station sites cannot cover an area due to lack of line-of-sight or when the distance exceeds the capability of the radios to provide services.

It is recommended that a maximum of two hops be used between a main base station and a subscriber site.

**Note:** Each such connection adds about 15 to 25ms delay to each packet.

### 3.1.3.1. Indoor Coverage (Not for use in North America)

In many applications there is a need to provide access to users located in the lower floors of a building. These users usually do not have a direct line-of-sight with a base station. WipLL can be used for indoor coverage for apartment buildings and office areas.

There are ways to achieve such a configuration either by placing the BSR in an adjacent building and covering one or two sides of the building or placing a BSR on the roof pointed towards the adjacent building to receive the reflections of the RF signals, or by placing the BSR inside the building and transmitting sufficient power to penetrate walls.

The following figures show some ways of providing indoor coverage.

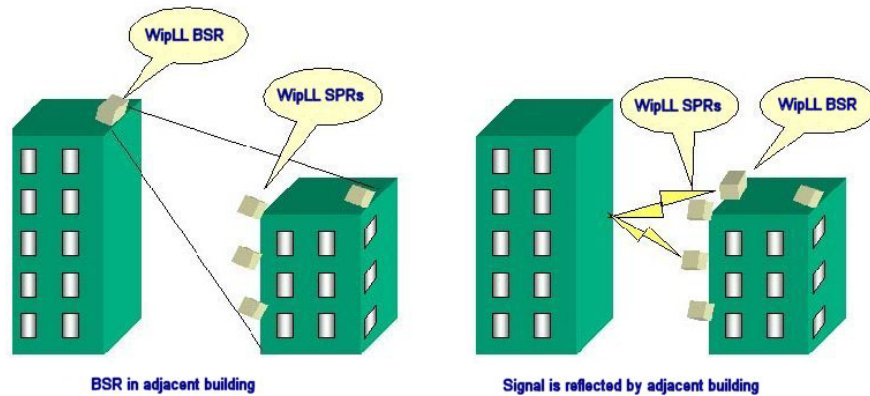

Figure 3-4: WipLL Indoor Coverage

## **3.2. Services**

### **3.2.1. Broadband Data Access**

Using a standard PSTN modem in circuit-switched networks customers are limited to 56Kbps of throughput and in most cases to 28.8Kbps.

From the operator's perspective once a customer has dialed with a PSTN modem a full 128Kbps channel is occupied for as long as the session lasts.

With WipLL customers are limited only by configuration, with a maximum of 4Mbps, 50 times faster than the fastest PSTN modem.

However, they do not necessarily consume more bandwidth from the operator since bandwidth is used only when there is an actual data packet to transmit. This happens about 10% of the time.

As a result, assuming the same bandwidth utilization of 128Kbps per customer an operator may actually commit 128Kbps to each customer, thus over-selling bandwidth without having any effect on the performance of the connection.

These characteristics of WipLL make it suitable for providing data access to users while maintaining best usage of bandwidth and capacity.

The following paragraphs discuss some of the services available with the broadband access that WipLL can offer.

### **3.2.2. High Speed Internet Access**

One of the advantages of WipLL is the fact that users are "always on". This means that there is no dialing process and no need for the hassle involved with dialup access. You need only open your web browser or email program to be instantly connected.



## WipLL System Description

WipLL can also distinguish between applications and users, thus enabling the operator to provide different class of service to users. For example, it can provide different services to web browsing and email, prioritizing web browsing for ensuring best "Internet experience".

### 3.2.3. Private Networks

WipLL allows the configuration for providing connectivity to branch offices. In this configuration the branch office can be connected to a central office or any other destination without allowing access from any other source.

Figure 3-5 illustrates two customers, A and B, with private networks to branch offices.

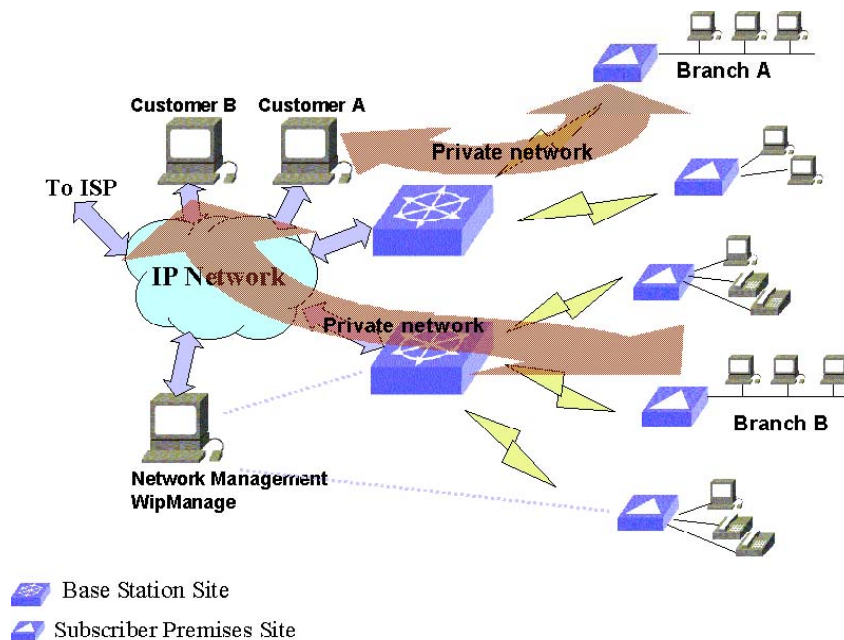

Figure 3-5: WipLL Private Networking

### **3.2.4. Remote Access**

WipLL is very suitable for tele-workers who require high speed access combined with private network and flexible configuration.

The interface to the system is 10Base-T and enables seamless configuration between office and remote location.

### **3.2.5. Video Over IP**

The fact that WipLL can provide Mbps of throughput to the user, together with its ability to set different delays and priorities to different applications and provide QoS, makes it a good solution for enabling applications like video over IP.

This means that customers can do high quality video conferencing.

The system can prioritize video packets in such a way that delays and jitter are minimized and the video packets pass smoothly through the system.



**WipLL System Description**

---

*This page intentionally left blank*



## BSR

### 4.1. Base Station Radio

A BSR is the centre of a WipLL sector. It has several roles in both the MAC layer as well as in the networking and transport layers. In the MAC layer the BSR is responsible for synchronizing the SPRs in terms of frequency hopping sequence.

At the network layer the BSR performs routing functions between the base station's Ethernet network and the wireless stations, containing a routing table that can support up to 126 stations addresses. The transport layer at a BSR makes decisions on how to support an application in terms of bandwidth, delays and mode of operation.

There are two modes of operation - Pre-emptive Polling (PPMA) and Time Division Multiple Access (TDMA). Although the WipLL BSR employs PPMA, it also recognizes the traffic type and emulates TDMA where necessary.

The BSRs are connected to the wired backbone through a BSDU with a 10Base-T Ethernet connection which allows a cable length of up to 100 meters.

Each of the BSRs contains two internal high gain, flat plate antennas, to support functionality of antenna diversity which helps to overcome multi-path effects.

There are typically several BSRs at each base station site. Each BSR can cover an azimuth angle (yaw) of 60 degrees and therefore 6 BSRs can provide a full 360 degrees coverage of the entire cell if needed. The antenna may also be tilted vertically (pitch) to reduce interference between adjacent BSRs. The maximum number of radios that can be connected depends mainly on the radio bandwidth allocated to the system. 6 radios can coexist at the base-station providing as much as 24 Mbit/s per base station to be shared among the remote users. Each individual BSR delivers up to 4Mbps using only a minimal 2MHz of radio bandwidth. As capacity demand grows, more BSR's can be added to a total of 24 per cell and



## WipLL System Description

---

connection to up to 3,024 discrete subscriber sites, however such a configuration would require a bandwidth allocation of at least 75 MHz.



Figure 4-1: Typical BSR Installation

### 4.1.1. BSR Default Accessories

- Mechanical mounting kit. Each BSR comes with a kit for mounting the unit on a pole with means for tilting.
- Data connector. A DB15 connector with waterproof cover included with the BSR.

## **4.2. Network Management**

The BSR is managed using SNMP and standard proprietary MIBs for the specific configurations of the BSR

### **4.2.1. Capabilities**

- Configuration - network parameters (IP address, ports, routing tables, etc.), RF parameters (frequency tables, allowed CS, etc.)
- Traps - sends traps as per configuration.
- Fault management - debugging options.
- Counters - for statistics on packet loss.

### 4.2.2. Physical Interfaces

- DB15 connector - power, Ethernet, sync and serial.
- DB9 connector - for serial interface.



**Signal lines from the DB15 are internally connected in parallel to the DB9 for setup and testing purposes**

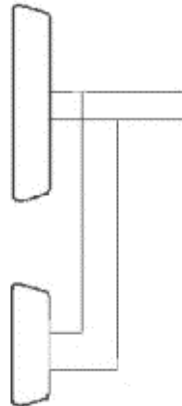

Figure 4-2: BSR Assembly

**Table 4-1: Antenna Unit Connectors**

<b>9 Pin Communications Connector</b>		<b>15 Pin Data/Power Connector</b>	
<b>1</b>	nc	<b>1</b>	+ VIN F
<b>2</b>	Rx	<b>2</b>	- VIN F
<b>3</b>	Tx	<b>3</b>	Ethernet Tx +
<b>4</b>	nc	<b>4</b>	Ethernet Tx -
<b>5</b>	Ground	<b>5</b>	Ethernet Rx +
<b>6</b>	nc	<b>6</b>	Ethernet Rx -
<b>7</b>	Ground	<b>7</b>	nc
<b>8</b>	nc	<b>8</b>	nc
<b>9</b>	+5vDC	<b>9</b>	+VIN F
		<b>10</b>	- VIN F
		<b>11</b>	VCC
		<b>12</b>	GND
		<b>13</b>	nc
		<b>14</b>	232 Rx
		<b>15</b>	232 Tx

### 4.2.3. Communication Interfaces

- Ethernet, 10Mbps.
- Serial, RS-232.



## **4.2.4. Features and Protocols**

### **4.2.4.1. Features**

- Synchronization of hops between BSRs.
- Software upgrade - with TFTP.
- Static routing tables - 16 entries per each SPR plus 32 entries for the Ethernet side, total 256 x 16 entries - 4096 routing entries.
- QoS - proprietary.
- Network management - SNMPv2
- Multiple concurrent open sessions - up to 50

### **4.2.4.2. Protocols**

- ARP
- DHCP / BOOTP relay
- TFTP
- ICMP
- SNMP

**Table 4-2: BSR and MAC Specifications**

<b>Parameter</b>	<b>Value</b>	<b>Comment</b>
Operating frequency range Rel 1.2 Rel 1.4	2.4 – 2.5GHz 3.4 – 3.6GHz	
Spectrum spreading method	Frequency hopping CDMA 2.4GHz 3.5GHz	Per ETSI EN300 328 ETS 300 328 EN 301 253
Duplex method	Time division (TDD) - 2.4GHz	
Transmit bit rates	Up to 4Mbps	BER and distance dependent.
Channel spacing at 1, 2 and 3Mb/s Channel spacing at 4Mb/s	1MHz 2MHz	Will be configured at the factory
Output power from the radio at 1, 2 and 3Mb/s Output power from the radio at 4Mb	Up to 23dBm, configurable 16dBm	Depending on local regulations maximum output power will be set at factory
Effective Isotropic Radiated Power (EIRP) at 1, 2 and 3Mb/s Effective Isotropic Radiated Power (EIRP) at 4Mb/s	Up to 34dBm, configurable 27dBm	Depending on local regulations maximum output power will be set at factory
Modulation method	8 level CPFSK	
Channel access method	PPMA / Adaptive TDMA	
Protocol efficiency	Up to 80%	At BER = 10 <sup>-5</sup> , depending on the application
Number of SPR per BSR	Up to 126	62 concurrently



## WipLL System Description

---

**Table 4-3: BSR Agency Certification**

Parameter	Value	Comment
Emissions / Immunity	EN 300 339 EN 300 386-2 ETS300 328	
Safety	EN / IEC 60950	
Environmental	ETS 300 019-2-x	

**Table 4-4: BSR Network Specifications**

Parameter	Value	Comment
Filtering Rate	10500 Frames / sec	
Forwarding Rate	1400 Frames / sec	
Routing table length	64 x 16	
Data open-sessions per BSR	50	

**Table 4-5: BSR Power Requirements**

Parameter	Value	Comment
Voltage Minimum: Maximum:	48Vdc nominal 30Vdc 55Vdc	Fed from the BSDU
Amperes Maximum:	500mA	

**Table 4-6: BSR Environmental Conditions**

Parameter	Value	Comment
Operating Temperature Outdoor units (BSR,SPR)	-30°C to +60°C	Optional range of -40°C to +70°C
Storage Temperature	-40°C to +80°C	



**Table 4-7: BSR Network Interface**

<b>Parameter</b>	<b>Value</b>	<b>Comment</b>
Ethernet Network	UTP EIA/TIA	Category 5
Standards Compliance	ANSI/IEEE 802.3 and ISO/IEC 8802-3 10 Base-T compliant	
Serial Port	RS-232	

**Table 4-8: BSR Physical Dimensions**

<b>Parameter</b>	<b>Value</b>	<b>Comment</b>
Height	400mm	Excluding mounting kit
Width	317mm	
Depth	65.5mm	
Weight	4.7kg	



**WipLL System Description**

---

*This page intentionally left blank*

## BSDU

### 5.1. Base Station Distribution Unit

The Base Station Distribution Unit (BSDU) is a major building block of the base station. It performs the main indoor functions of the WipLL base-station. This mainly refers to the interfacing function between the Base Station Radios (BSRs), the Wide Area Network (WAN) and the DC power system.

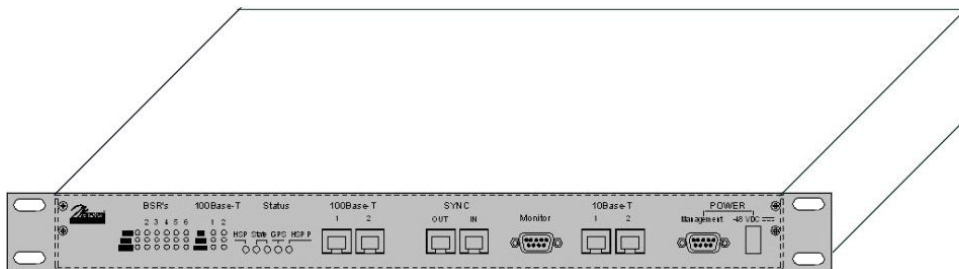

Figure 5-1: The WipLL BSDU

The functions implemented by the BSDU in the WipLL system's base station are:

- Data switching. - between 6 BSRs to a fast Ethernet 100Base-T port.
- Power distribution - DC power from a single -48Vdc connection to six BSRs.
- Domestic functions - focusing on local functions of the base station such as frequency hopping, power alarms, etc.

The BSDU is a 19" rack mount device. The front fascia has 2 × 100Base-T RJ45 sockets, 2 × 10Base-T RJ45 sockets, Sync in and Sync out RJ45 sockets, a DB9 socket for a monitor and a DB9 socket for management. The rear of the device has 6



## WipLL System Description

---

× DB15 connectors for connecting to each of the BSRs, cables and connectors for connecting to other BSDUs plus mechanical brackets for mounting the BSDU unit in a 19" rack

## 5.2. Network Management

### 5.2.1. Management Information Base

- Standard Management Information Base (MIB) - Ethernet, switch. From WipLL Release 1.4, WipManage also controls the BSDU using SNMP.
- Marconi proprietary MIBS for managing the frequency hopping

### 5.2.2. Capabilities

- Configuration - network parameters
- Traps - sends traps as per configuration.
- Fault management - debugging options.
- Statistical counters - packet loss, etc.

## 5.3. Physical Interfaces

### 5.3.1. Connectors

- 6 × DB15 connectors for power, Ethernet, sync and connection to the BSRs.
- 2 × DB9 connectors for monitor and management.
- 2 × RJ45 for 100Base-T.
- 2 × RJ45 for 10Base-T.

### 5.3.2. Communication Interfaces

- Fast Ethernet, 100Base-T
- Ethernet, 10Mbps.
- Serial, RS-232.

## 5.4. Features and Protocols

### 5.4.1. Features

- Software upgrade - with TFTP.
- Network management - SNMPv2

### 5.4.2. Protocols

- ARP
- TFTP
- ICMP
- SNMP

## 5.5. Table of Specifications - BSDU

### 5.5.1. Network Specifications

- Filtering rate - 105 000 frames / sec.
- Forwarding rate - 62 500 frames / sec.



### 5.5.2. Power Requirements

- Voltage- 48v DC nominal
- Power consumption - Maximum 300W (including the feeding of 6 × BSRs)

### 5.5.3. Environmental Conditions

- Operating temperature 0°C to +50°C
- Storage temperature -40°C to +80°C

### 5.5.4. Network Interface

- Ethernet Network - RJ45: UTP EIA/TIA - Category 5

### 5.5.5. Standards Compliance

- ANSI/IEEE 802.3, ISO/IEC 8802-3 10/100 Base-T compliant
- Serial port - RS-232

### 5.5.6. Physical Dimensions

Table 5-1: BSDU Physical Dimensions

Parameter	Value
Height	4.32 cm
Width	48.26 cm
Depth	22.86 cm
Weight	2.9 kg

## SPR

### 6.1. Subscriber Premises Radio

The subscriber site typically includes a Subscriber Premises Radio (SPR) and a Subscriber Data Adapter (SDA).

Figure 6-1 shows a typical SPR installation.



**Figure 6-1: Typical SPR Installation**

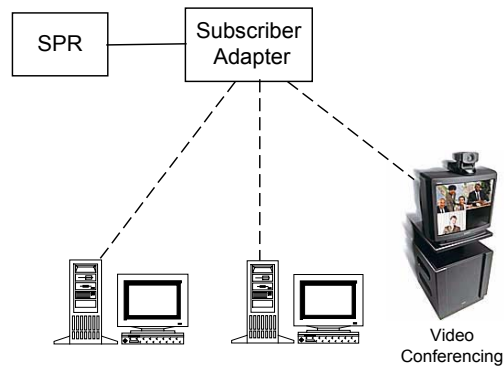

**Figure 6-2: Typical Subscriber Site**

## 6.2. SPR/BSR Communications

The SPR transmits and receives data to and from the base station. It is typically located on the roof or external wall of the subscriber premises. The SPR has the reference number of the Base Station Radio (BSR) coded into it. This prevents the SPR from being removed and placed at a different location without authorisation.

The SPR contains a high-gain directional antenna. The standard 2.4Ghz model covers an area of 23 degrees with a gain of 15dBi

At the network layer, the SPR performs routing functions between the subscriber's Ethernet network and the wireless network and contains a routing table that can support up to 16 entries.

The transport layer of the SPR makes decisions on how to support an application in terms of bandwidth, delays and mode of operation. There are two modes of operation - pre-emptive polling and Time Division Multiple Access (TDMA). The BSR's admission control makes the decision on which mode each unit of the cell will operate at a given moment.



The SPR is connected to the wired network through an SDA supplied with WipLL Release 1.4, with a 10Base-T Ethernet connection which allows a cable length of up to 100 meters. The capacity of each SPR is up to 4Mbps.

### **6.2.1. SPR Configurations**

Different versions of the SPR are available. Options include different mechanical, memory and antenna beam span configurations.

### **6.2.2. SPR Standard Accessories**

- Mechanical mounting brackets - for mounting the units on a wall.
- DB15 connector for the data port with waterproof cover.

### **6.2.3. Network Management**

- MIB - standard MIBs - Ethernet, router
- Marconi proprietary



## WipLL System Description

---

### 6.2.4. Capabilities

- **Configuration** - network parameters (IP address, ports, routing tables, etc.), RF parameters (frequency tables, allowed BSRs, etc.).
- **Traps** - send traps as per configuration.
- **Fault management** - debugging options.
- **Statistical counters** - for packet loss, etc.

### 6.2.5. Physical Interfaces

#### 6.2.5.1. Connectors:

- DB15 - power, Ethernet and serial.
- DB9 - serial interface.

#### 6.2.5.2. Communication Interfaces:

- Ethernet - 10 Mbps.
- Serial - RS-232.

### 6.2.6. Features and Protocols

#### 6.2.6.1. Features

- Software upgrade - with TFTP.
- Static routing tables - 16 entries per Ethernet port.

- QoS - Proprietary.
- Network management - SNMPv2
- Concurrent open sessions - 50

#### **6.2.6.2. Protocols**

- - ARP
- - DHCP / BOOTP relay (server located on the BSR's LAN)
- - TFTP
- - ICMP
- - SNMP



## WipLL System Description

---

**Table 6-1: Radio and MAC Specifications**

Parameter	Value	Comment
Operating frequency Release 1.2 Release 1.4	2.4 GHz 2.4 GHz	
Spectrum spreading method	Frequency hopping CDMA	Per ETSI EN300 328
Duplexing Method	Time Div. Duplex (TDD) 2.4GHz	
Transmit Bit Rates	Up to 4Mbps	BER and distance dependent
Channel spacing at 1, 2 and 3Mb/s Channel spacing at 4Mb/s	1MHz 2MHz	Will be configured at the factory.
Output power from the radio at 1, 2 and 3Mb/s Output power from the radio at 4Mb/s	Up to 19dBm 12dBm	Will be configured at the factory.
Effective Isotropic Radiated Power (EIRP) at 1, 2 and 3Mb/s Effective Isotropic Radiated Power (EIRP) at 4Mb/s	Up to 34dBm 27dBm	Depending on local regulations maximum output power can be set at factory
Modulation method	8 level CPFSK	
Channel access method	PPMA / Adaptive TDMA	
Protocol efficiency	Up to 80%	At BER = $10^{-5}$ , depending on the application

**Table 6-2: Agency Certification**

Parameter	Value	Comment
Emissions / Immunity	EN 300 339 EN 300 386-2 ETS 300 328	
Safety	EN/IEC 60950	

Environmental	ETS 300 019-2-x	
---------------	-----------------	--



## WipLL System Description

---

**Table 6-3: Network Specifications**

Parameter	Value	Comment
Filtering rate	10500 frames / sec	
Forwarding rate	1300 frames / sec	
Routing table length	16	

**Table 6-4: Power Requirements**

Parameter	Value	Comment
Voltage Minimum Maximum	48Vdc nominal 30Vdc 55Vdc	Fed from either the SDA
Consumption	Maximum	500mA

**Table 6-5: Environmental Considerations**

Parameter	Value	Comment
Operating temperature Outdoor units (BSR,SPR)	-30°C to +60°C	Optional range of -40°C to +70°C
Storage temperature	-40°C to +80°C	

**Table 6-6: Network Interface**

Parameter	Value	Comment
Ethernet Network	UTP EIA / TIA	Category 5
Standards Compliance	ANSI/IEEE 802.3 and ISO/IEC 8802-3 10 Base-T compliant	
Serial Port	RS-232	

**Table 6-7: SPR Physical Dimensions (w/o High Gain Antenna)**

<b>Parameter</b>	<b>Value</b>	<b>Comment</b>
Height	311mm	Excluding mounting kit
Width	244mm	
Depth	65.5mm	
Weight	2.5kg	

**Table 6-8: SPR Physical Dimensions (with High Gain Antenna)**

<b>Parameter</b>	<b>Value</b>	<b>Comment</b>
Height	400mm	Excluding mounting kit
Width	317mm	
Depth	65.5mm	
Weight	4.7kg	

**Note:** The cable and connector are the same as for the base station.

### 6.3. Interface Connectors

Figure 6-3 and Table 6-9 detail the pin configuration for the SPR interfaces.



**Signal lines from the DB15 are internally connected in parallel to the DB9 for setup and testing purposes**

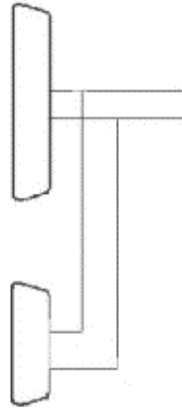

Figure 6-3: SPR Assembly



**Table 6-9: SPR Connectors**

<b>9 Pin Communications Connector</b>		<b>15 Pin Data/Power Connector</b>	
<b>1</b>	nc	<b>1</b>	+ VIN F
<b>2</b>	Rx	<b>2</b>	- VIN F
<b>3</b>	Tx	<b>3</b>	Ethernet Tx +
<b>4</b>	nc	<b>4</b>	Ethernet Tx -
<b>5</b>	Ground	<b>5</b>	Ethernet Rx +
<b>6</b>	nc	<b>6</b>	Ethernet Rx -
<b>7</b>	Ground	<b>7</b>	nc
<b>8</b>	nc	<b>8</b>	nc
<b>9</b>	+5vDC	<b>9</b>	+VIN F
		<b>10</b>	- VIN F
		<b>11</b>	VCC
		<b>12</b>	GND
		<b>13</b>	nc
		<b>14</b>	232 Rx
		<b>15</b>	232 Tx

The cable run must be mechanically protected and supported at maximum 1 meter intervals in a 20mm galvanised steel flexible conduit for external runs and in 20mm PVC conduit for internal runs. Communications output must be in 50mm x 20mm PVC trunking.



**WipLL System Description**

---

*This page intentionally left blank*

# Chapter 7

## Customer Interface Adaptors

### 7.1. General

WipLL uses Internet Protocol (IP) to communicate between subscribers. Analog telephony signals are also converted to IP packets at the subscriber's side, and back to PSTN signaling by IP Telephony Gateways. WipLL subscriber units contain the client-side IP Telephony gateway. The PSTN gateway can be located anywhere within the network.

#### 7.1.1. Configurations

WipLL's subscriber data and telephony adapter is located at the subscriber premises. The subscriber adapters' job is to interface the WipLL system with the subscriber premises equipment. It also provides power to the subscriber premises radio (SPR), which is located outdoors and performs IP routing and transmits and receive data from the base station, using radio frequencies (RF). Lightning protection is also done at the subscriber adapter.

There are several configurations for the subscriber adapters that are related mainly to the interface required by the subscriber and to the configuration of the system.

### 7.2. SDA

The Subscriber Data Adapter (SDA) is an Ethernet HUB that provides 2 10-BaseT connections to host computers or a network. It also provides power, lightning



## WipLL System Description

---

protection and data connection to the SPR. It connects to the main power and includes LEDs for display of network connection and data traffic.

The SDA box can be wall mounted, in a communications closet or sited on a desk.

### 7.2.1. SDA Specifications

- Dimensions: 150mm Height x 150mm width x 58.5mm depth
- Weight: .65kg
- Power Consumption: 6 watts (AC)
- Input Voltage: 117-230 Vac 50/60Hz
- Output Voltage: 48Vdc
- Power Capacity: 50 watts (DC)
- Environmental Conditions
  - Temperature: -25°C to +55°C
  - Humidity: 90% at 30°C.
- Connections
  - 8-pin connector to SPR or BSR (See Table 7-1, page 7-3)
  - RJ45 socket for Ethernet LAN
  - RJ45 socket for a PC interface
- Optional accessories
  - Wall mounting kit.

## Chapter 7 - Customer Interface Adaptors



**Figure 7-1: Subscriber Data Adapter (SDA)**

The SDA includes lightning arrestors to protect the customer's local network from lightning. The SDA is connected to a standard power outlet (110-240vAC). The units are generally installed indoors in a communications cabinet or mounted on a wall. An SDA can also be placed on a table or shelf next to the customer's communications equipment.

Table 7-1 illustrates the data connector pinouts.

**Table 7-1: Data Connections**

8-way Connector		J3		J2	
1	nc	1	+Tx2	1	+Rx3
2	nc	2	-Tx2	2	-Rx3
3	-48v	3	+Rx2	3	+Tx3
4	+48v	4	nc	4	nc
5	-Tx	5	nc	5	nc
6	+Tx	6	-Rx2	6	-Tx3
7	-Rx	7	nc	7	nc
8	+RX	8	nc	8	nc



**WipLL System Description**

---

*This page intentionally left blank*

## Chapter

# 8

## **BSPS**

The Marconi Base Station Power System (BSPS) supplies the following:

- Provides off-line power to sensitive equipment
- Charges the battery bank that provides backup power during a mains failure. Thus, this system is essentially a DC-UPS with a battery connected to it. The size of the battery determines the backup and charging time. Since the system is current limited, the maximum battery size is based on that limit.
- Monitors the operation and communicates with a PC or a host to provide full (remote) control and indication.

## 8.1. General

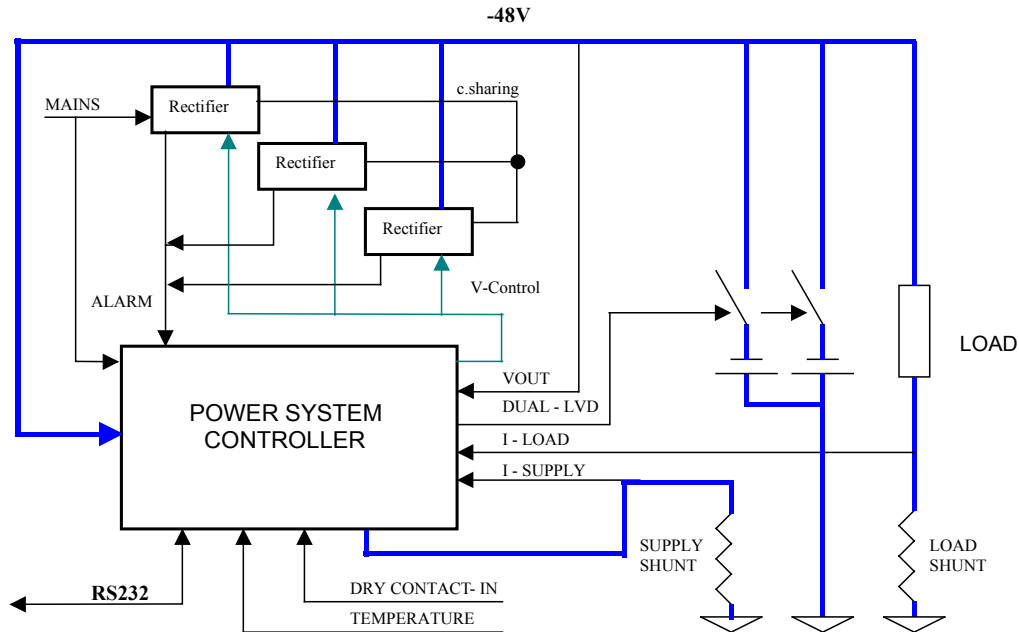

Figure 8-1: BSPS Block Diagram

As shown in Figure 8-1, 3 rectifiers (or more) are chained in parallel to provide the current capacity needed. The output voltage of the rectifiers feeds the load and charges the batteries through the dual LVD.

A dedicated bus that connects all rectifier modules does current sharing.

This is done autonomously and not related to the system controller.

All rectifiers are sharing a voltage control bus (V-CONTROL) by which it is possible to change the output DC voltage of the system, around the default value of the modules.

This bus is controlled by the system controller in order to change the output.



Another bus (ALARM) sends the information of a faulty rectifier module to the system controller.

Two accurate shunt-resistors are contained in the system to monitor the load and the total current.

The battery current is then calculated by the controller to be the difference between the two.

Two temperature sensors are connected to measure the battery temperature. The average temperature is calculated and demonstrated.

The status of the various circuit breakers (CB's) is monitored constantly by using their auxiliary switches. The opening of a CB will result in an audio/visual alarm. When the reason for alarm is removed, the alarm clears and stops.

## **8.2. Main Rack**

### **8.2.1. Main Rack**

The main rack is the core of the Full-Redundancy 48VDC-power system. It can contain between one to three rectifiers and a system controller. Listed below are the components that are housed in the main rack (see Figure 8-2).

- Rectifier modules
- System controller
- LVLD contactors (commanded by the system controller)
- Load and battery circuit breakers for DC protection and distribution

## 8.2.2. Front Panel

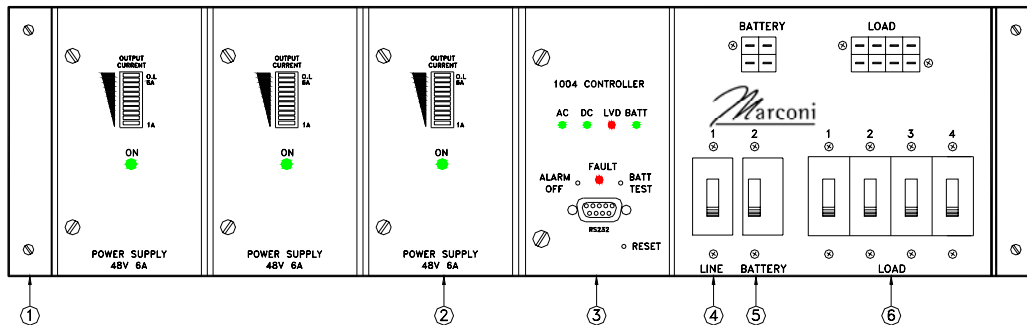

**Figure 8-2: BPS Main Rack - Front Panel**

The following components are illustrated in Figure 8-3:

- 1) Adjustable 19" mounting flange
- 2) Rectifier module
- 3) System controller module
- 4) Line breaker
- 5) Battery breaker
- 6) Load breakers

## 8.2.3. Rear Panel

The following components are shown in Figure 8-4:

- 1) **LINE IN** - AC line input terminations
- 2) **LINE OUT** - connection for the extension rack (when exists)

- 3) **COMM** - data and communication connection for extension rack
- 4) **P.S. EXT** - DC connection to the extension rack
- 5) **LVD BYPASS** - connection for the DC distribution rack
- 6) **TEMP SENSOR** - temperature sensor terminals (four wires)
- 7) **GND** - Ground terminal

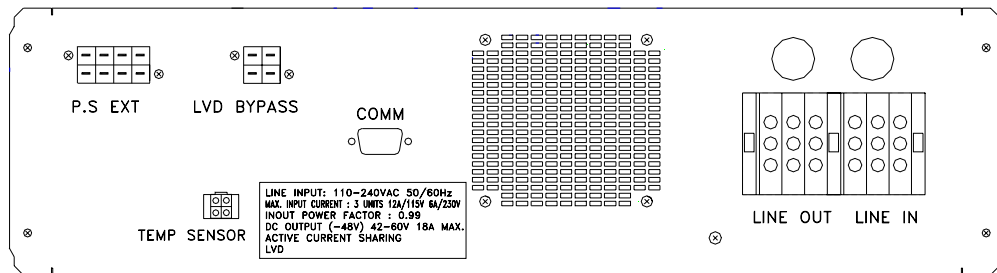

Figure 8-3: BPS Main Rack - Rear Panel

## 8.3. Extension Rack (optional)

### 8.3.1. Overview

The extension rack is optional and is used only for getting more power from the system. It can house up to 6 rectifiers. A fully equipped system with the extension contains 9 rectifiers with a total capability of 54A output current.

### 8.3.2. Front Panel

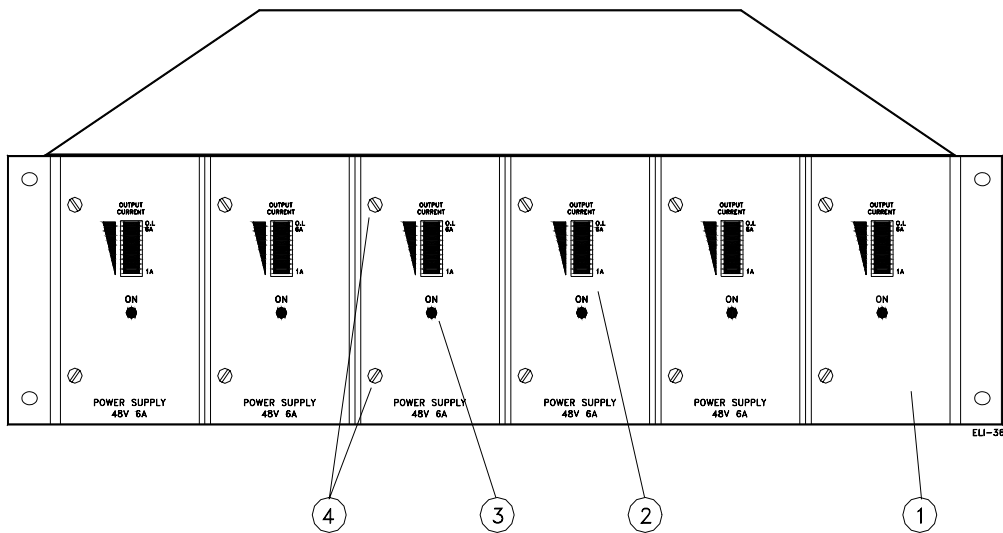

**Figure 8-4: BPS Extension Rack - Front Panel**

The following are the components illustrated in Figure 8-4:

- 1) Rectifier module
- 2) Rectifier load bar graph
- 3) Rectifier status green LED
- 4) Rectifier module fasteners

### 8.3.3. Rear Panel

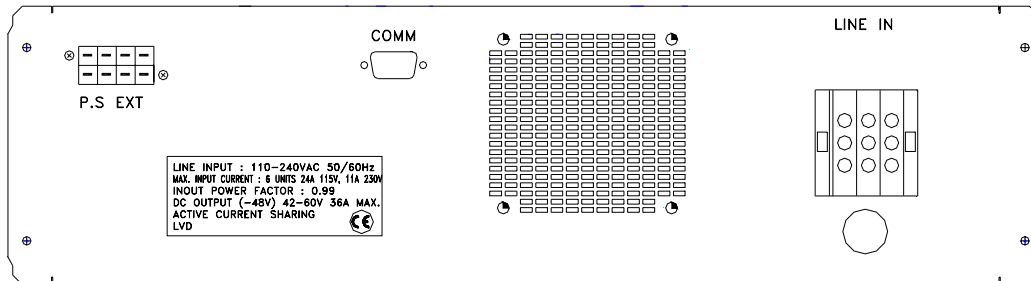

Figure 8-5: BPS Extension Rack - Rear Panel

The following are the components specified in Figure 8-5:

- 1) *LINE IN* - AC line input terminations
- 2) *COMM* - data and communication connection to the main rack
- 3) *P.S. EXT* - DC connection to the main rack
- 4) *GND* - Ground terminal

## 8.4. DC Distribution Rack (optional)

### 8.4.1. Overview

This section is optional and provides more circuit-breakers (CB's) for the sake of distributing the output current to more separate consumers.

This rack contains as well a bypass switch to bypass the LVD.

When this switch is activated the battery is no longer protected against deep discharge and the system controller alarm will be thus activated.



## WipLL System Description

The distribution rack also contains the terminations for connecting to other parts of the system (main and extension racks).

### 8.4.2. Front Panel

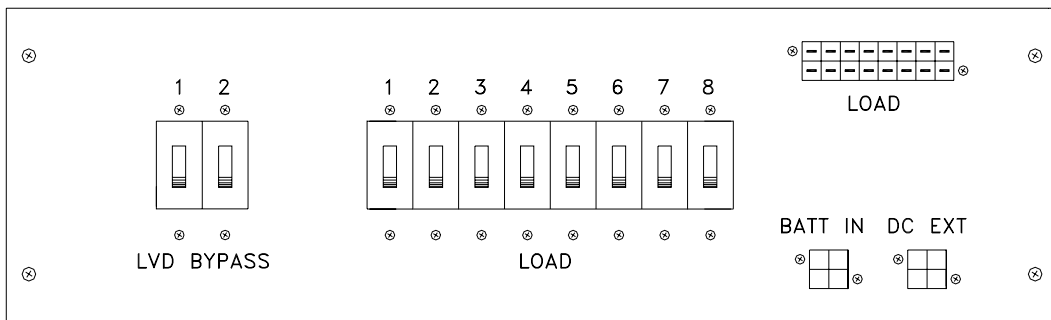

Figure 8-6: BPS DC Distribution Rack - Front Panel

### 8.4.3. Rear Panel

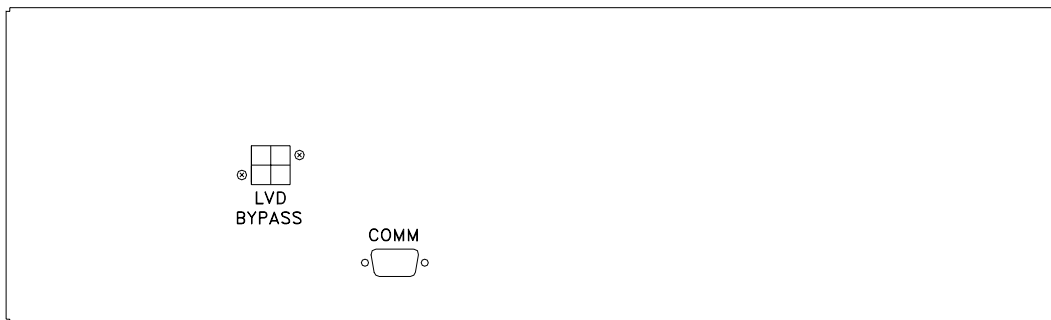

Figure 8-7: BPS DC Distribution Rack - Rear Panel

## 8.5. Basic Rectifier Module

The PFC50-6 rectifier module is the heart of the Full-Redundancy 48VDC power system. It is a plugged-in module designed specifically for modular systems. The power factor correction (PFC) device at the input enables clean, stable, sinusoidal current consumption from the mains. This converter produces a 382VDC output, which is then converted to the 50V output.

A current sharing circuit is responsible for current sharing among the rectifiers. This enables each one of the rectifiers to slightly increase its output voltage.

The rectifiers follow the highest output voltage of the rectifiers that are used.

For example:

There are 2 rectifiers in the system, one of the rectifiers has an output voltage that is greater than that of the other rectifier. The rectifier with the higher output voltage will become the master and dictate the output voltage of the total system. The second rectifier raises its voltage slightly until its output current equals the output current of the master rectifier. Hence, one rectifier in the system is the master and the other rectifiers are slaves.

When the master rectifier fails to operate, the rectifier with the next highest initial output automatically becomes the new master of the system.

**Note:** The sharing mechanism tends to raise the system's output voltage. A limit of approximately one-volt of correction is applied to the system.

The output current indication is indicated by the LED bar graph shown on the front panel (see Figure 8-8). This bar graph is used to verify current sharing operation, and to indicate the percentage of the full load.

An RFI input filter built into the input stage suppresses the generated noise travelling to the line.

### 8.5.1. Block Diagram

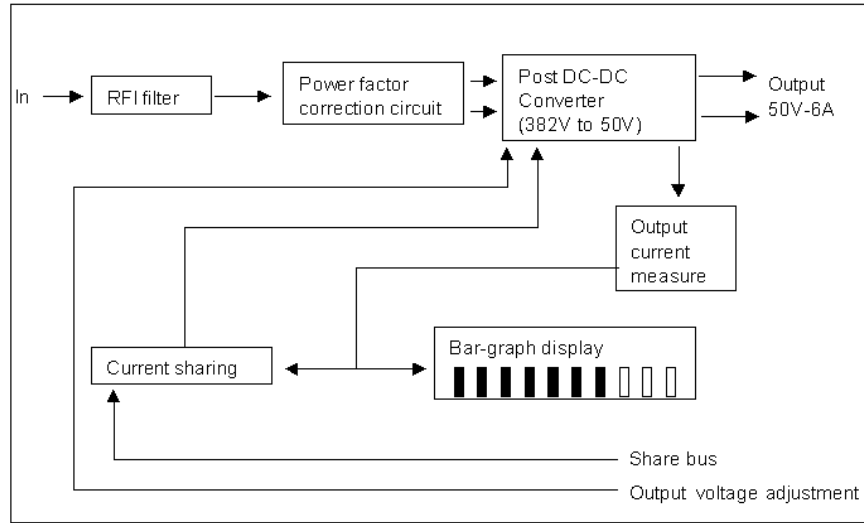

Figure 8-8: BPS Rectifier - Simplified Block Diagram



### 8.5.2. Front Panel

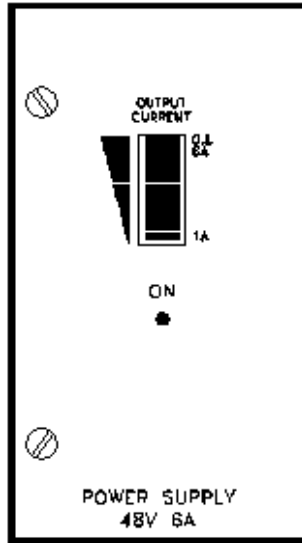

Figure 8-9: BSPS Rectifier Module - Front Panel

Table 8-1: Rectifier Specifications

INPUT	Voltage	90VAC to 270VAC
	Current (nominal)	1.6A @ 230V / 3.2A @ 115V
	Frequency	47Hz to 63Hz
	Power factor (nominal line/load)	$\geq 0.993$
	Inrush current (at 25°C ambient)	$< 65A@230V / 33A@115V$
OUTPUT	Voltage (default)	53.5VDC
	Regulation (line & load) (1)	$\pm 0.4\%$
	Adjustable range	47 to 58 VDC
	Current	6A @ 54V

	Ripple & noise	50mVp-p
--	----------------	---------

## 8.6. System Controller Module

### 8.6.1. Front Panel

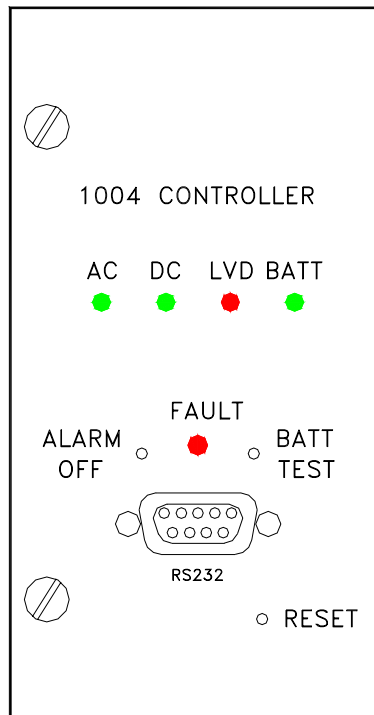

Figure 8-10: BPS System Controller - Front Panel

**Description:**

AC - Input AC voltage is normal (green)

DC - Output DC voltage is normal (green)

LVD - Low Voltage Disconnect circuit is open (battery is disconnected, red)

BATT - Battery test passed (green)

FAULT - General alarm fault (red-continuous), Faulty rectifier (red-blinks)

BATT TEST - Manual battery test, use a pencil tip to initiate

ALARM OFF - Silences the internal buzzer, use a pencil tip

RESET - Resetting the controller, use a pencil tip

RS232 - Connector for the host

## 8.6.2. Main Functions

The 1004 system controller supports these functions:

- 1) RS232 communication with a host
- 2) Controlling dual-LVD for managing two branches of batteries. LVD voltages are settable and nonvolatile
- 3) Boost/Float charging, voltages are settable and nonvolatile
- 4) Battery test for two branches
- 5) Three dry-contacts for alarm, user-defined
- 6) Audio-visual alarm
- 7) LED's indicators for AC, DC, LVD, battery and general fault
- 8) Optional: 2x3 digits display for system voltage/current metering
- 9) Faulty rectifier detection
- 10) Open breakers detection (any of them)
- 11) LVD bypass activation alarm

12) Abnormal condition detection (AC, DC, battery, over-temperature etc.)

### 8.6.3. Host Communication

The detailed protocol of communication is described in section **8.7 Communication Protocol & Data**, page 8-14.

The RS232 plug, located at the front panel is used for the connection with the host. pin assignment for the DB9 connector is as follows:

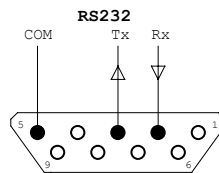

Figure 8-11: DB9 Connector

### 8.7. Communication Protocol & Data

- 1) The host and the controller communicate in Half-Duplex RS232 9600.N.1 RX, TX, COM lines, no flow control (neither h/w nor s/w).
- 2) The **HOST** is always the **MASTER**, and the **controller** is always a **slave**.
- 3) Data is binary with no dedicated control chars.
- 4) Data transmitted by each end has a constant length.
- 5) There are 3 elements for data reliability: **3 bytes - header**.
- 6) **1 byte - checksum**.
- 7) **3 bytes - termination**.
- 8) Upon reception of a valid packet, the controller will respond in 50mSec as of the end of the received packet.

- 9) Upon a reception of a **header start (0xAC)** there will be a start of a reception window 500mSec long. In case that a valid packet has been received it will be processed. Otherwise, the controller will initialize the reception counter.

This protocol provides the user with the ability of controlling the power system parameters as well as retrieving data and status from the system.

### 8.7.1. Master

The master sends its packet including **header, opcode, data, checksum** and **termination**. The 4-byte **opcode** bit-combination gives the user the ability to perform one or more functions at the same time.

The 32-byte **data** to be sent should include relevant data according to the operation, set as an **opcode** by the user.

### 8.7.2. Slave

The slave responds as soon as a valid packet is received including **header, received opcode, received\_checksum, id, data, checksum** and **termination**.

The **received\_opcode** is the last received opcode from the master.

The **received\_checksum** is the last received checksum from the master.

The 4-byte **id** consists of 3 pre-programmed bytes and an additional byte that can be programmed by the master.

The 32-byte **data** always include all the data/status that the user may request, meaning that every transaction from the master to the slave will always result with retrieving all possible data that the slave is able to provide.

**NOTE:** The data retrieved in a transaction does not include the changes made by the host in its command (if any). Another retrieval should take place in order to get the values that were affected in the previous command.



**WipLL System Description**

---

*This page intentionally left blank*

# Chapter 9

## Appendix

### 9.1. New Features – Release 2.0.1

S/N	Feature	Remarks
1		

### 9.2. New Features – Release 1.4

S/N	Feature	Remarks
2	BSPS	Provides power to the Base Station
3	Improved QoS	Eight (8) priorities
4	Bandwidth limitations	Each SPR may have a max. bit rate
5	SNMP support for BSDU	MIB-II and private MIB Via WipManage
6	IntraCom	Traffic among SPRs can be centrally monitored or not
7	Configuring IP on the air	More IP addressing related flexibility of the network
8	Default configurations via WipConfig & WipManage	
9	RSSI analysis in WipConfig	

### 9.3. BSPS

- Base Station Power System (BSPS) is released as part of a cabinet, to provide power to the BSDUs at the base station.



## 9.4. Improved Quality of Service (QoS)

- QoS is the ability to recognize the type of transmission and assign optimal resources accordingly. This is especially important for VoIP applications, that are sensitive to delay and jitter and should therefore be prioritized over other applications.
- QoS is used for packets leaving the SPRs towards the BSR as well as among SPRs making sure that the BSR assigns the correct priority to the correct SPR.
- WipLL 1.4 now provides eight (8) levels of priority: 0 through 7. Priorities are based on source IP address or ranges of addresses, destination IP address or ranges of addresses, protocol type (UDP, TCP, ICMP) and TCP/UDP ports which actually define the applications, such as a WEB application on port 80).
- When a packet arrives from the Ethernet network to an SPR, the system recognizes the type of the packet and assigns it with a Time-To-Live (TTL) value.
- TTL determines which packets go first, where packets share the same priority.
- Each packet is marked whether critical or not, to determine if it should be sent when TTL expires or it should be dropped.
- Higher priority packets always go first regardless of the TTL of lower priority packets.

## 9.5. Bandwidth limitations

The BSR receives and transmits data to multiple SPRs. Using WipManage the user can set the maximum bandwidth values for different SPRs.

With good planning and minimal system congestion, each SPR can use the maximum defined bandwidth, so long as does not exceed the maximum overall bandwidth.

In a congested network, the real maximum bandwidth for an SPR cannot reach the defined value, but is still in proportion to the value configured. For example, an SPR



that is set to a maximum of 256Kbps can reach a maximum bandwidth significantly larger than the maximum standard bandwidth of an SPR set to a 64Kbps.

## **9.6. SNMP support for BSDU**

The BSDU is a major building block in a base station site. As such it is required to be remotely managed by WipManage. As part of release 1.4, WipManage now supports the BSDU that has an SNMP agent and supports Management Information Base II (MIB-II) and private MIB.

## **9.7. IntraCom**

The enabling/disabling IntraCom feature provides an option of controlling the packets transferred among SPRs with the help of a router or a firewall connected to the BSR in the base station:

- If IntraCom is allowed, traffic can be routed among the SPRs (via the BSR) without the involvement of any external router or firewall.
- If IntraCom is not allowed, then traffic among SPRs is routed via the BSR to a central router or firewall. The central router or firewall controls the traffic. This capability is often requested by users interested in central control of the traffic among sites, for reasons such as security.

## **9.8. Configuring IP on the air**

The IP addresses of the air ports of BSRs and SPRs can be configured by the user

Previous releases do not allow this configuration. The IP addresses of the air ports were fixed IP addresses from the range of 192.168.0.0 .

This feature now increases the flexibility of WipLL, permits more efficient use of IP addresses in the user's network and often avoids a need of changing IP addresses in pre-existing networks. For example a user that uses private IP addresses from the



## WipLL System Description

---

range of 192.168.0.0 does not have to change IP addresses in the network when installing WipLL.

### 9.9. Default configurations via WipConfig & WipManage

In order to simplify WipLL's configuration and installation, release 1.4 provides 2 layers of default configurations for SPRs:

1. Customer defaults – located in ROM and loaded during manufacturing. These parameters are customer specific.
2. Protected parameters – basic parameters that enable connectivity of the SPR such as its IP address, subnet mask and community strings.

Undo operation enables restoring to the previous parameter settings.

### 9.10. RSSI analysis in WipConfig

WipConfig shows the RSSI value of each SPR. The RSSI value provides important RF-related information when installing WipLL.

### 9.11. What is RFC 1918?

Address allocation permits full network layer connectivity among all hosts inside an enterprise as well as among all public hosts of different enterprises. The cost of using private internet address space is the potentially costly effort to renumber hosts and networks between public and private.

The industry standard is that whenever possible, users of unregistered (or "dirty") networks use the reserved addresses in RFC 1918 on any networks inside the firewall.

The RFC 1918 addresses that can be used are:

- Class A: **10.x.x.x**

- Class B range: **172.16.0.0-172.31.0.0**
- Class C range: **192.168.1.x-192.168.254.x**

The advantages of using these numbers on the inside of the firewall are twofold:

- Internal IP networks can now be “grown” without fear of running out of addresses
- There is no longer a risk of inadvertently using other networks’ legitimate addresses.

For example, if arbitrarily using the Class C range of 192.31.7.0 for network addresses on the inside of your firewall, you will find that your computers will never be able to connect to another machine having a legitimate IP address such as 192.31.7.31, because the hosts will forever be trying to reach a machine on the inside of your firewall that does not exist.



**WipLL System Description**

---

*This page intentionally left blank*

# INDEX

## A

Audio/visual alarm, 8-3

## B

Base Station, 9-1  
  Distribution Unit, 1-6, 5-1  
  Giving Partial Cover, 1-8  
  Power System, 9-1  
  Radio, 1-6, 1-7, 5-1, 6-2  
  Sector, 1-9  
  Site, 1-1  
  Units, 1-6  
Basic Rectifier  
  Front panel of, 8-11  
Batteries, 8-2  
Battery, 8-1, 8-3, 8-7, 8-13  
  bank, 8-1  
  circuit breakers, 8-3  
  size, 8-1  
  temperature, 8-3  
  test, 8-13  
    manual, 8-13  
BSPS  
  Block Diagram, 8-2  
  DC Distribution Rack, 8-8  
  Extension Rack, 8-6, 8-7  
  Main Rack, 8-4, 8-5  
  Rectifier, 8-10, 8-11

System Controller, 8-12  
BSR Redundancy, 1-8  
BSRs  
  IP addresses of air ports of, 9-3

## C

Communication Protocol  
  8 .8, 8-14  
Communications equipment  
  customer's, 7-3

## D

DB15 connector, 4-2, 4-4, 5-2, 6-3, 6-4  
DB9 connector, 4-4, 5-2, 6-4, 8-14  
DC Distribution Rack, 8-7

## E

Ethernet  
  connection, 1-3  
  hub, 7-1  
  network, 9-2  
  port, 1-10

## F

Firewall, 9-3, 9-4, 9-5  
Front Panel, 8-4, 8-6, 8-8, 8-11, 8-12



## WipLL System Description

---

### H

Housing development, *1-8*

### I

Internet address space, *9-4*  
Internet Protocol, *1-2, 7-1*  
    packets, *2-1*  
IntraCom feature, *9-3*  
IP Telephony gateway, *7-1*

### L

LED bar graph, *8-9*  
Low Voltage Disconnect circuit, *8-13*

### M

Maintenance Manual, *1-9*  
Management Information Base II, *9-3*  
Management Information Bases  
    proprietary, *2-5*  
Marconi Base Station Power System,  
    *8-1*  
Mbytes/s air link, *1-7*

### N

Network Operations Center, *1-1*

### O

Opcode, *8-15*

### P

P.S. EXT, *8-7*  
Permits full network layer  
    connectivity  
    Address allocation, *9-4*  
PFC50-6 rectifier, *8-9*  
Pinouts  
    connector, *7-3*  
Preemptive Polling Multiple Access  
    protocol, *2-7*

### Q

Quality of Service functions, *1-5*

### R

Radio, *1-2, 1-5, 3-2*  
    bandwidth, *4-1*  
    communications, *1-6*  
    frequencies, *7-1*  
    link, *1-2*  
    transceivers, *1-2*  
Rear Panel, *8-5, 8-7, 8-8*  
Received\_checksum, *8-15*  
Received\_opcode, *8-15*  
Rectifier, *8-9*  
    Faulty, *8-13*  
Rectifier load bar graph, *8-6*  
Rectifier module, *8-3*  
    PFC50-6, *8-9*  
Rectifier module fasteners, *8-6*  
Rectifier modules, *8-2*  
Rectifier Specifications, *8-11*

Rectifier status, 8-6  
Rectifiers, 8-2, 8-5, 8-9  
Release 1.4, 1-1  
RFC 1918, 9-4  
RFI input filter, 8-9  
RS232 communication, 8-13  
RSSI value of each SPR, 9-4

**S**

Settable, 8-13  
Simple Network Management  
Protocol, 1-3  
Simplified Block Diagram, 8-10  
Slotted Aloha process, 2-9  
SPR  
connectivity of, 9-4  
SPR set, 9-3  
Steel flexible conduit, 6-11  
Subscriber Data Adapter, 6-1, 7-1, 7-3  
Subscriber Premises, 1-1  
Subscriber Premises Equipment, 1-5  
Subscriber Premises Radio, 1-10, 2-7,  
6-1

**T**

TCP/UDP ports, 9-2  
Telecom  
backbone, 1-6  
network, 1-2

Telephony  
adapter, 7-1  
service, 2-1  
signals, 7-1  
Telephony service  
toll quality, 1-1  
Time Division Multiple Access, 4-1,  
6-2  
Transceiver, 1-2  
Transceivers, 1-2  
radio, 1-2  
TTL of lower priority packets, 9-2

**W**

Windows 95, 1-10  
Windows NT, 1-10  
WipConfig, 9-1  
WipConfig & WipManage, 9-4  
WipLL  
broadband cellular wireless system,  
1-1  
hardware, 1-1  
network management tool, 1-10  
system, 1-1, 1-4, 1-5  
unit, 1-10  
WipManage \i, 9-1  
Wireless Access system  
broadband fixed cellular, 1-1



**WipLL System Description**

---

*This page intentionally left blank*