



HERMON LABORATORIES



Electrical

Hermon Laboratories Ltd.  
P.O.Box 23  
Binyamina 30550, Israel  
Tel. +972 46288001  
Fax. +972 46288277  
e-mail: [mail@hermonlabs.com](mailto:mail@hermonlabs.com)

## ELECTROMAGNETIC EMISSIONS TEST REPORT

according to FCC Part 15 subpart C, §15.247

for

**Marconi Communications LTD.**

EQUIPMENT UNDER TEST:

**Base Station Radio Unit of Wireless Local Loop System (WipLL),  
model BSR-2.4 (bit rate 4 Mbit/s)**

This report is in conformity with ISO/IEC 17025. The A2LA logo endorsement applies only to the test methods and the standards that are listed in the scope of Hermon Laboratories accreditation.

The test results relate only to the items tested. **This test report must not be reproduced in any form except in full with the approval of Hermon Laboratories Ltd.**

Document ID: MARRAD\_FCC.14551-4.doc

Date of Issue: November 01

Page 1 of 156



### Description of equipment under test

Test items	Base station frequency hopping transceiver
Manufacturer	Marconi Communications Ltd.
Types (Models)	BSR-2.4 (with bit rate 4 Mbit/s)
Receipt date	September 5, 2001

### Applicant information

Applicant's representative & responsible person	Mr. Shmuel Bleichman, VP engineering
Company	Marconi Communications Ltd.
Address	1 Hamelacha street
Postal code	71293
City	Lod
Country	Israel
Telephone number	+972 8977 7015
Telefax number	+972 8977 7050

### Test performance

Project Number:	14551
Location	Hermon Laboratories
Test performed	September 5 to September 23, 2001
Purpose of test	EUT certification according to FCC requirements
Test specification(s)	FCC Part 15, subpart C, §15.247, §§15.205, 15.207, 15.209, subpart B §§15.107, 15.109



# Contents

- 1 SUMMARY AND SIGNATURES.....4**
- 2 GENERAL INFORMATION.....5**
  - 2.1 ABBREVIATIONS AND ACRONYMS .....5
  - 2.2 SPECIFICATION REFERENCES .....6
  - 2.3 EUT DESCRIPTION .....6
  - 2.4 EUT TEST CONFIGURATION .....7
- 3 TEST FACILITY DESCRIPTION .....8**
  - 3.1 GENERAL .....8
  - 3.2 EQUIPMENT CALIBRATION .....8
  - 3.3 STATEMENT OF QUALIFICATION .....9
- 4 EMISSION MEASUREMENTS .....10**
  - 4.1 FREQUENCY HOPPING CHANNELS SEPARATION AND HOPPING FREQUENCY USAGE TEST  
ACCORDING TO §15.247(A)(1)(III) .....10
  - 4.2 OCCUPIED BANDWIDTH TEST ACCORDING TO §15.247(A)(1)(III).....15
  - 4.3 TIME OF OCCUPANCY, DEFINITION ACCORDING TO § 15.247(A)(1)(III) .....19
  - 4.4 TOTAL SPAN OF HOPPING CHANNELS TEST ACCORDING TO § 15.247(A)(1)(III).....22
  - 4.5 MAXIMUM PEAK OUTPUT POWER TEST ACCORDING TO §15.247 (B)(1), (3)(I) .....25
  - 4.6 BAND EDGE COMPLIANCE OF RF CONDUCTED EMISSIONS TEST ACCORDING TO §15.247(C)...30
  - 4.7 OUT OF BAND ANTENNA CONDUCTED EMISSIONS TEST ACCORDING TO §15.247(C).....35
  - 4.8 OUT OF BAND RADIATED EMISSIONS TEST ACCORDING TO §15.247(C) AND § 15.205,  
§15.209(A) .....79
  - 4.9 UNINTENTIONAL RADIATED EMISSIONS (CLASS B DIGITAL DEVICE) TEST ACCORDING TO  
§15.109, §15.209 .....135
  - 4.10 UNINTENTIONAL CONDUCTED EMISSIONS (CLASS B DIGITAL DEVICE) TEST ACCORDING TO  
§15.107 .....147
- APPENDIX A – TEST EQUIPMENT AND ANCILLARIES USED FOR TESTS .....153**

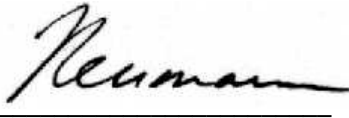


## 1 Summary and signatures

The EUT, BSR-2.4 base station radio unit, was tested according to FCC part 15 subpart C, §.15.247, subpart B §§15.107, 15.109 and found to comply with the standard requirements.

**Test performed by:**

Mr. Y. Neuman, test engineer



---

**Test report prepared by:**


Mr. A. Tsukerman, certification engineer



---

**Test report approved by:**

Mr. M. Nikishin, EMC group leader



---

Dr. E. Usoskin, C.E.O.



---



## 2 General information

### 2.1 Abbreviations and acronyms

The following abbreviations and acronyms are applicable to this test report:

AC	alternating current
AF	antenna factor
AvF	average factor
AG	amplifier gain
AVRG	average (detector)
BER	bit error rate
BSDU	base station distribution unit
BW	bandwidth
CE	conducted emissions
CL	cable loss
cm	centimeter
CW	sine wave
dB	decibel
dBm	decibel referred to one milliwatt
dB( $\mu$ A)	decibel referred to one microampere
dB( $\mu$ V)	decibel referred to one microvolt
dB( $\mu$ V/m)	decibel referred to one microvolt per meter
DC	direct current
EMC	electromagnetic compatibility
EUT	equipment under test
FSK	frequency shift keying
GHz	gigahertz
H	height
HL	Hermon Laboratories
Hz	hertz
IF	Intermediate frequency
kHz	kilohertz
L	length
LNA	low noise amplifier
LO	local oscillator
m	meter
Mbps	megabit per second
mm	millimeter
MHz	megahertz
msec	millisecond
NA	not applicable
NARTE	National Association of Radio and Telecommunications Engineers, Inc.
nF	nanofarad
$\Omega$	ohm
QP	quasi-peak (detector)
PC	personal computer
RBW	resolution bandwidth
RF	radio frequency
RE	radiated emission
sec	second
SPR	subscriber premises radio
TDMA	time division multiple access
V	volt
V/m	volt per meter
W	watt



## 2.2 Specification references

CFR 47 part 15:2001	Radio Frequency Devices.
ANSI C63.2:1996	American National Standard for Instrumentation-Electromagnetic Noise and Field Strength, 10 kHz to 40 GHz-Specifications.
ANSI C63.4:1992	American National Standard for Methods of Measurement of Radio-Noise Emissions from Low-Voltage Electrical and Electronic Equipment in the Range of 9 kHz to 40 GHz.

## 2.3 EUT description

A base station radio, BSR-2.4, is a part of a broadband fixed wireless cellular access system WipLL. The system provides a radio link between an end-user of the telecom network (a subscriber) and a network itself to give high-speed data access. The EUT is an outdoor unit comprising a frequency hopping transceiver that controls the WipLL sector and has several roles. The transceiver operates in 2403 MHz to 2477 MHz frequency range and is equipped with an 11 dBi gain flat plane internal antenna.

Each BSR is a controller of the PPMA (Pre-emptive Polling Multiple Access) protocol within its sector. It polls SPRs according to requirements that are determined by applications, availability of resources and pre-defined policy. Policy is based on defining allowed delays and maximum bandwidth according to packet types, determination of priorities between applications and mode of polling mechanism – preemptive or time bounded.

Each BSR is optionally physically connected to a base station distribution unit, which provides 48 V DC power, data connectivity and local switching functionality as well synchronization between the BSRs. A BSDU can serve up to six BSRs, each BSR capacity is up to 4 Mbps, therefore a 6-BSR base-station-site capacity is about 24 Mbps.



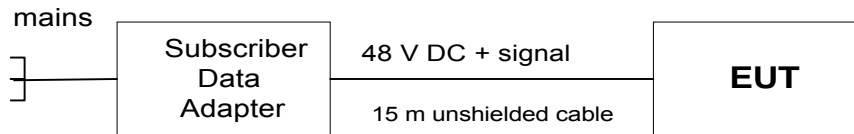
## 2.4 EUT test configuration

The EUT test configuration is given in Figure 2.4.1. Throughout the testing the EUT was powered via SDA. The device operating frequencies are given in table 2.4.1.

**Table 2.4.1**  
**EUT operating and other frequencies**

Frequency	Description	
	BSR/ SPR RF board	BSR/SPR Digital board
2403 MHz to 2477 MHz - operating frequency	■	
20 MHz - clock		■
2053 MHz to 2127 MHz - LO	■	
350 MHz - IF	■	
48 MHz - clock		■

**Figure 2.4.1**  
**EUT test configuration for emission measurements**





### 3 Test facility description

#### 3.1 General

Tests were performed at Hermon Laboratories Ltd., which is a fully independent, private EMC, Safety and Telecommunication testing facility. Hermon Laboratories is listed by the Federal Communications Commission (USA) for all parts of Code of Federal Regulations 47 (CFR 47) and by Industry Canada for electromagnetic emissions (file numbers IC 2186-1 for OATS and IC 2186-2 for anechoic chamber), certified by VCCI, Japan (the registration numbers are R-808 for OATS, R-1082 for anechoic chamber, C-845 for conducted emissions site), assessed by TNO Certification EP&S (Netherlands) for a number of EMC, Telecommunications, Safety standards, and by AMTAC (UK) for safety of Medical Devices. The laboratory is accredited by American Association for Laboratory Accreditation (USA) according to ISO/IEC 17025 for Electromagnetic Compatibility, Product Safety, Telecommunications Testing and Environmental Simulation (for exact scope please refer to Certificate No. 839.01).

Address: PO Box 23, Binyamina 30550, Israel.  
Telephone: +972 4628 8001  
Fax: +972 4628 8277  
e-mail mail@hermonlabs.com

Person for contact: Mr. Alex Usoskin, QA manager.

#### 3.2 Equipment calibration

The test equipment has been calibrated according to its recommended procedures and is within the manufacturer's published limit of error. The standards and instruments used in the calibration system conform to the present requirements of MIL-STD-45662A.

The laboratory standards are calibrated by the third party (traceable to NIST, USA) on a regular basis according to equipment manufacturer requirements.

##### 3.2.1 Expanded uncertainty at 95% confidence in Hermon Labs EMC measurements

Conducted emissions with LISN and HP 8542E/HP8546A receiver	<ul style="list-style-type: none"> <li>▪ 9 kHz to 150 kHz: +2.43 dB/-2.22 dB</li> <li>▪ 150 kHz to 30 MHz: + 2.22 dB/-2.05 dB</li> </ul>
Radiated emissions in the open field test site at 3 m measuring distance	<ul style="list-style-type: none"> <li>▪ Biconilog antenna: +5.83 dB/-5.67 dB</li> <li>▪ Standard gain horn antenna:</li> </ul>
Radiated emissions in the anechoic chamber at 3 m measuring distance	<ul style="list-style-type: none"> <li>▪ Biconilog antenna: +5.73 dB/-5.57 dB</li> <li>▪ Double ridged guide antenna: ± 2.36 dB</li> </ul>
Conducted power measurements	<ul style="list-style-type: none"> <li>▪ +0.36 dB /-0.38 dB</li> </ul>
Conducted frequency measurements	<ul style="list-style-type: none"> <li>▪ 0.18 ppm</li> </ul>
Conducted spurious emissions measurements	<ul style="list-style-type: none"> <li>▪ ±2.5 dB</li> </ul>






### 3.3 Statement of qualification

The test measurement data supplied in this test measurement report having been received by me, is hereby duly certified. The following is a statement of my qualifications:

I am an engineer, graduated from university in 1992 with an MScEE degree, have obtained 9 years experience in research and development of electronic devices.  
I have been with Hermon Laboratories since January 2000.

Name: Mr. Yuri Neuman  
Position: test engineer

Signature:  
Date:

  
November 4, 2001

I hereby certify that this test measurement report was prepared by me and is hereby duly certified. The following is a statement of my qualifications:

I am an engineer, graduated from university in 1972, with an MScEE degree, have obtained 25 years experience in electronic products design and development.  
I have been with Hermon Laboratories since September 2001.

Name: Mr. Anatoliy Tsukerman  
Position: certification engineer

Signature:  
Date:

  
November 4, 2001



## 4 Emission measurements

### 4.1 Frequency hopping channels separation and hopping frequency usage test according to §15.247(a)(1)(iii)

#### 4.1.1 General

This test was performed to prove that the EUT frequency hopping system uses at least 15 non-overlapping channels with 20 dB bandwidth greater than 1 MHz and has hopping channel carrier frequencies separated by a minimum of 25 kHz or the 20 dB bandwidth of the hopping channel, whichever is greater.

#### 4.1.2 Test procedure

The EUT RF output was connected to the spectrum analyzer as shown in Photograph 4.1.1. The spectrum analyzer settings are shown in the plots.

The test was performed in the EUT transmitting mode with hopping function enabled.

Plots 4.1.1 and 4.1.2 show 38 non-overlapping channels in the 2.400 to 2.483.5 MHz frequency band.

Plot 4.1.3 shows hopping channel carrier frequencies separated by 2.008 MHz which is greater than the 20 dB bandwidth of the hopping channel (see section 4.2).

The EUT successfully passed this test.

#### Reference numbers of test equipment used

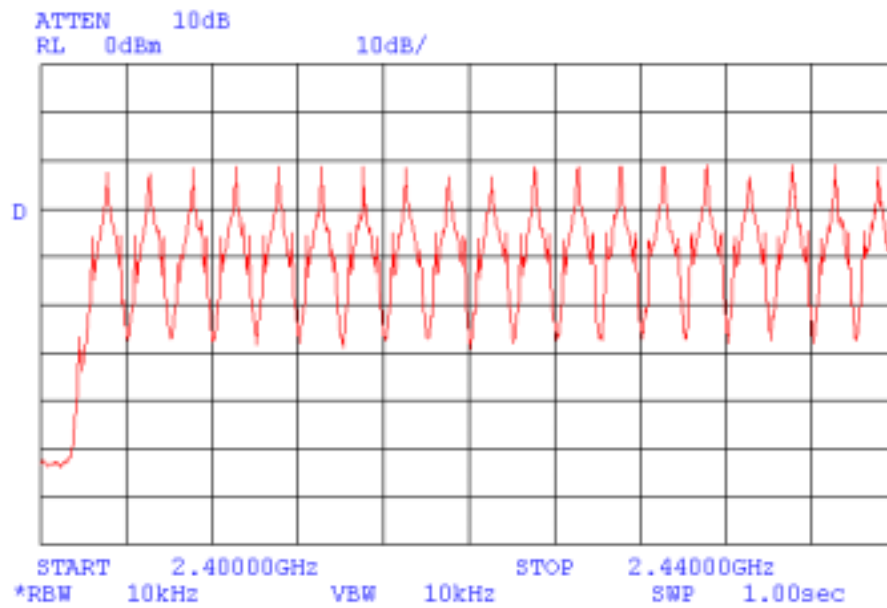
HL 1424	HL 1567	HL 1651
---------	---------	---------

Full description is given in Appendix A.



**Plot 4.1.1**

Test specification: §15.247(a)(1)(iii)  
Hopping channels number test results

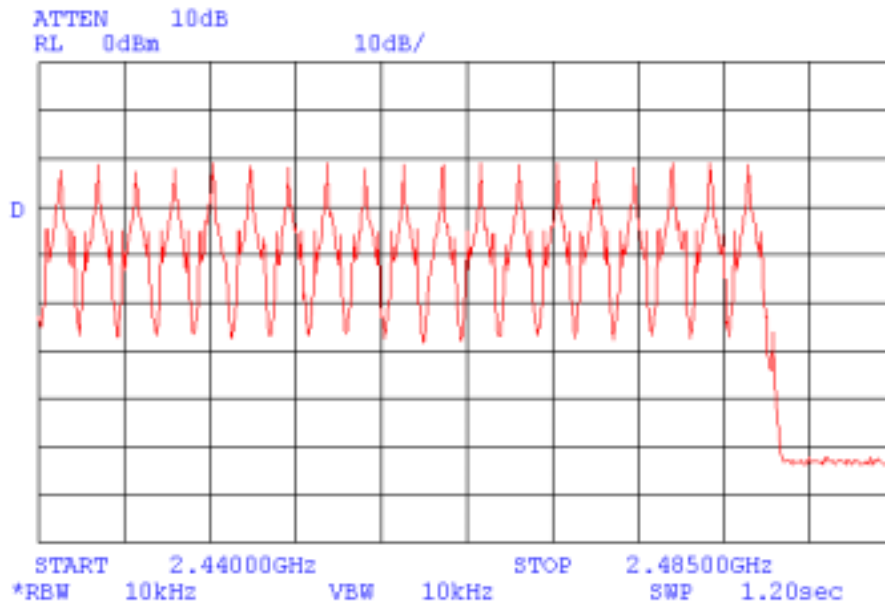


19 hopping frequencies



**Plot 4.1.2**

Test specification: §15.247(a)(1)(iii)  
Hopping channels number test results

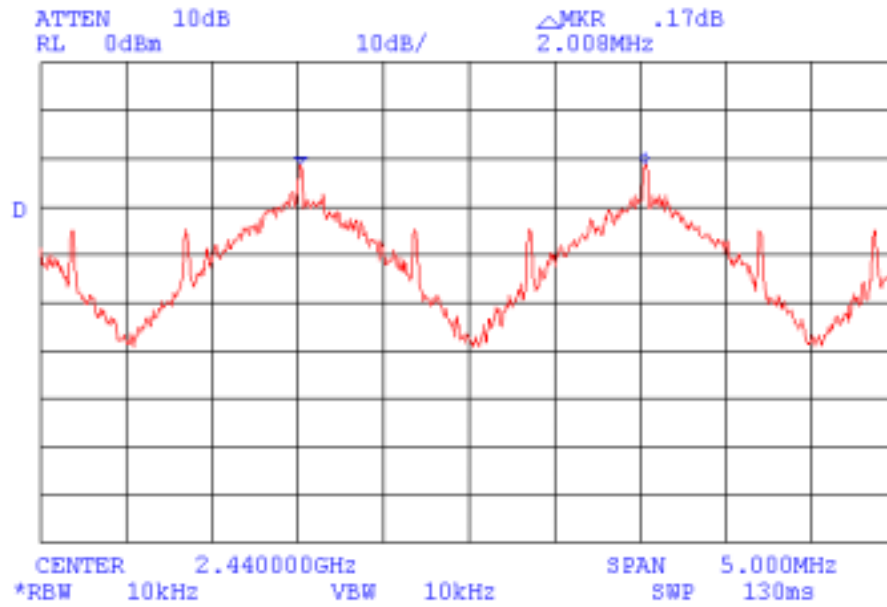


19 hopping frequencies  
38 hopping frequencies total



**Plot 4.1.3**

Test specification: §15.247(a)(1)  
Hopping channel carrier frequency separation test results



Channel separation=2.008 MHz



**Photograph 4.1.1**  
**Conducted emissions measurement test setup**





## 4.2 Occupied bandwidth test according to §15.247(a)(1)(iii)

### 4.2.1 General

This test was performed to prove that the 20 dB bandwidth of the hopping channel is greater than 1 MHz.

### 4.2.2 Test setup and procedure

The test setup was the same as in paragraph 4.1.

The test was performed in the EUT transmitting mode with hopping function disabled.

The occupied bandwidth measurement was performed for carrier channel frequency at low and high edges and at the middle of the frequency band. Table 4.2.1 and Plots 4.2.1 to 4.2.3 demonstrate the test results of the occupied bandwidth measurements. The spectrum analyzer settings are shown in Plots.

**Table 4.2.1 Occupied bandwidth test results**

Carrier frequency, MHz	Measured 20 dB BW, kHz	Limit, kHz	Result
2403	1050	1000	Pass
2441	1040	1000	Pass
2477	1045	1000	Pass

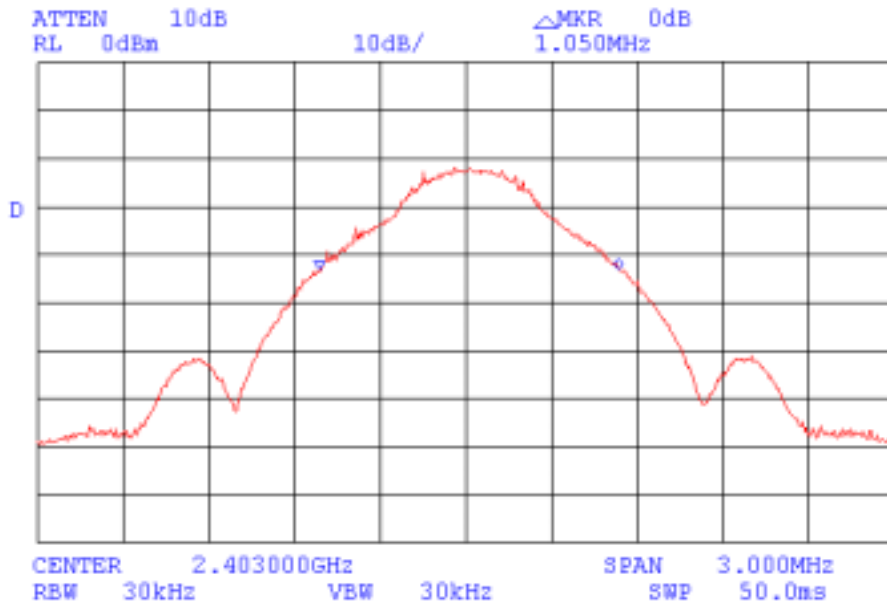
### Reference numbers of test equipment used

HL 1424	HL 1567	HL 1651
---------	---------	---------

Full description is given in Appendix A.



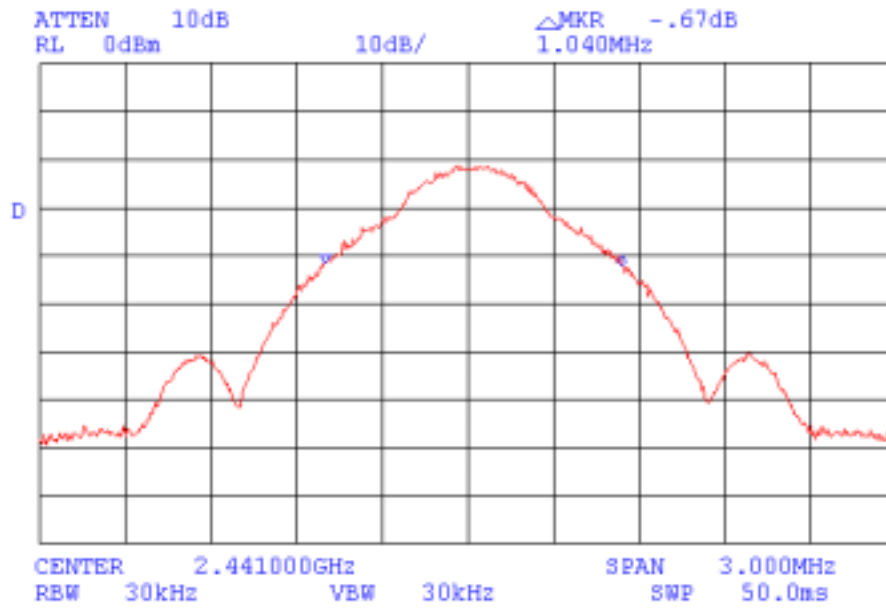
**Plot 4.2.1**  
Test specification: § 15.247(a)(1)(iii)  
Occupied bandwidth test results





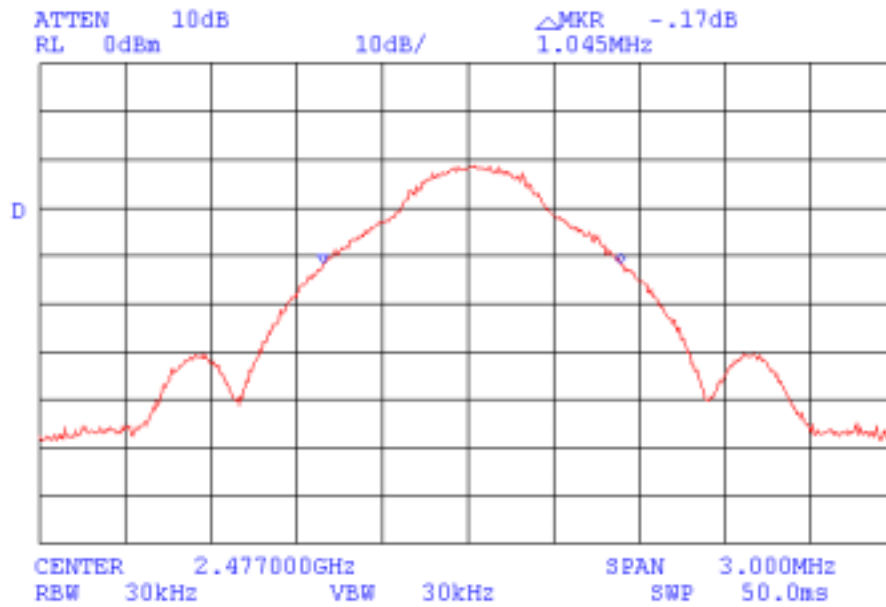


**Plot 4.2.2**  
Test specification: § 15.247(a)(1)(iii)  
Occupied bandwidth test results





**Plot 4.2.3**  
Test specification: § 15.247(a)(1)(iii)  
Occupied bandwidth test results





### **4.3 Time of occupancy, definition according to § 15.247(a)(1)(iii)**

#### **4.3.1 General**

The test was performed to prove that the time of occupancy at any frequency is not greater than 0.4 seconds within the time period required to hop through all channels.

#### **4.3.2 Test procedure**

The test setup was the same as in paragraph 4.1.

The test was performed in the EUT transmitting mode with hopping function enabled.

The time period required to hop through all channels is 1.900 s as shown in Plot 4.3.1 and the total Tx ON time is 50.00 ms at one frequency as shown in Plot 4.3.2. Thus the time of occupancy is less than 0.4 s at any frequency.

#### **Reference numbers of test equipment used**

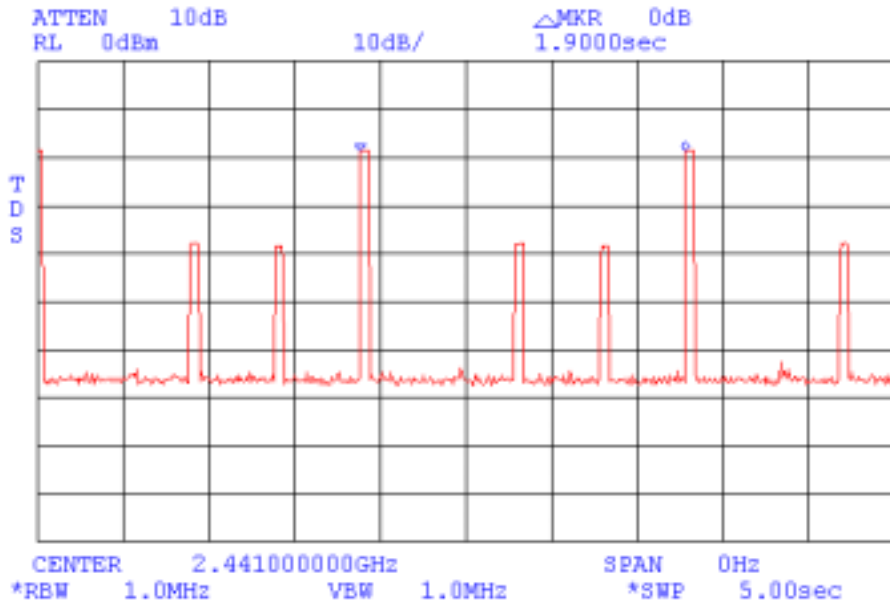
HL 1424	HL 1567	HL 1651
---------	---------	---------

Full description is given in Appendix A.



**Plot 4.3.1**

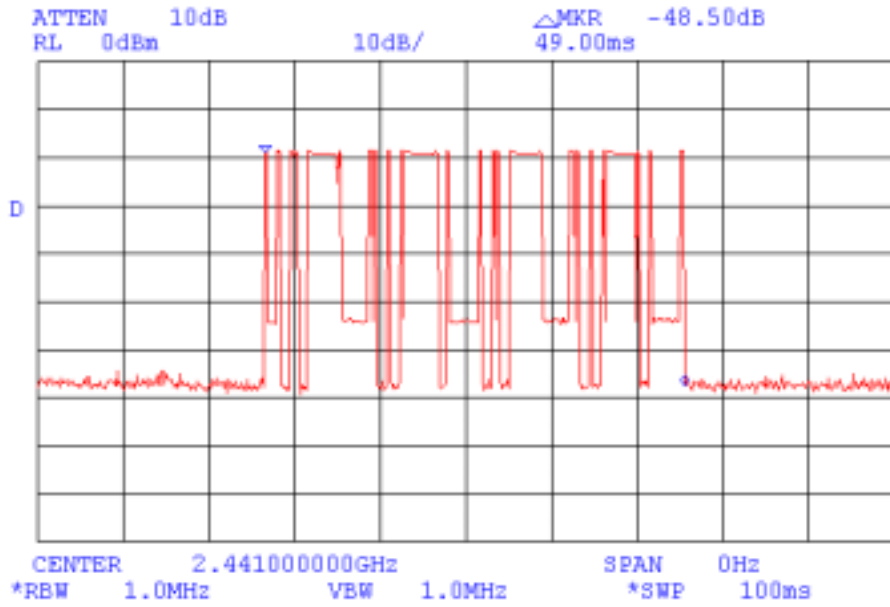
Test specification: §15.247(a)(1)(iii)  
Time of occupancy test results





**Plot 4.3.2**

Test specification: §15.247(a)(1)(iii)  
Time of occupancy test results





#### 4.4 Total span of hopping channels test according to § 15.247(a)(1)(iii)

##### 4.4.1 General

This test was performed to prove that the total span of hopping channels is at least 75 MHz.

##### 4.4.2 Test procedure

The test setup was the same as in paragraph 4.1.

The test was performed in the EUT transmitting mode with hopping function enabled.

The total span of hopping channels is 75.4 MHz as shown in Plots 4.4.1 and 4.4.2 and defined as difference between highest and lowest hopping frequencies. The lowest frequency is 2402.33 MHz (see Plot 4.4.1) and the highest frequency is 2477.73 MHz (see Plot 4.4.2). The total span of hopping channels is equal to:

$$2477.73 - 2402.33 = 75.4 \text{ MHz}$$

#### Reference numbers of test equipment used

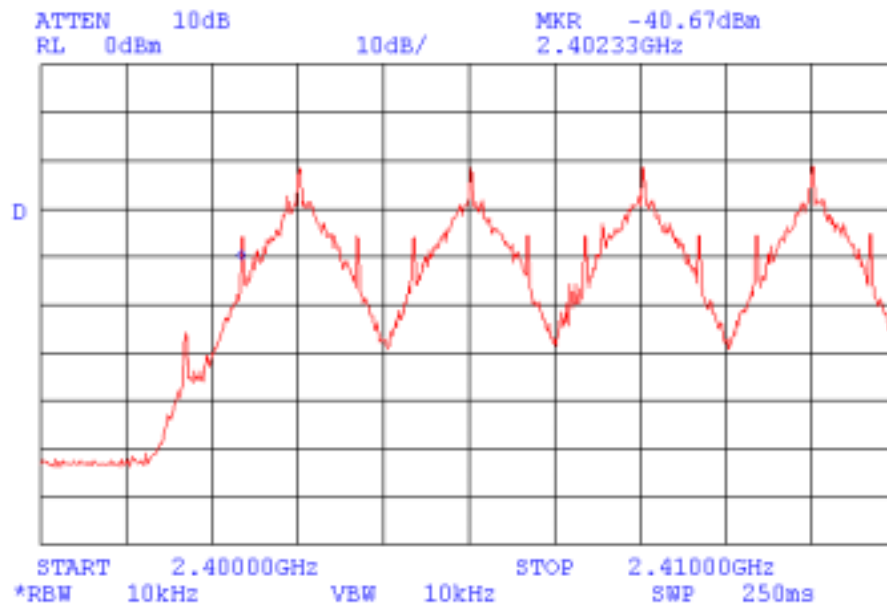
HL 1424	HL 1567	HL 1651
---------	---------	---------

Full description is given in Appendix A.



**Plot 4.4.1**

Test specification: §15.247(a)(1)(iii)  
Total span of hopping channels test results

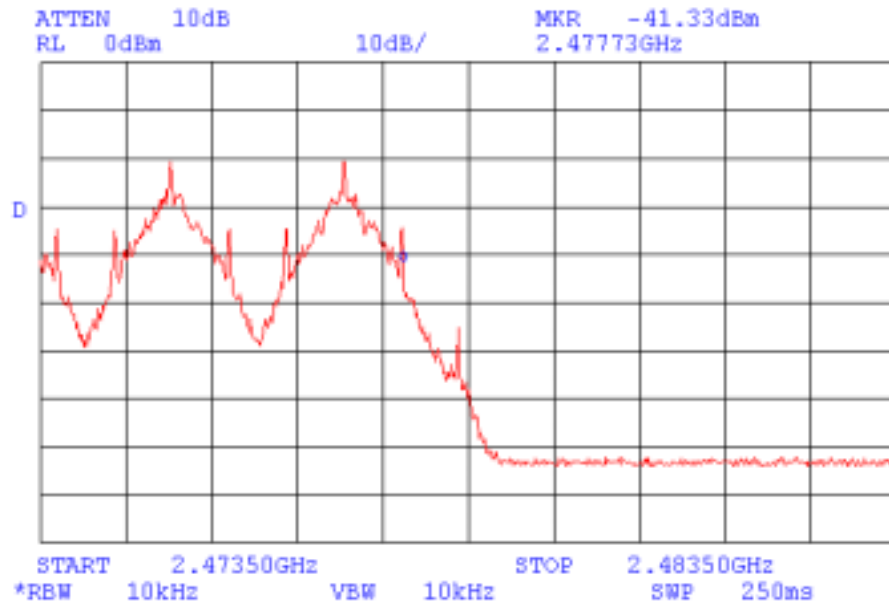


$F_{LOW}=2402.33$  MHz



**Plot 4.4.2**

Test specification: §15.247(a)(1)(iii)  
Total span of hopping channels test results



$F_{HIGH}=2477.73$  MHz





**4.5 Maximum peak output power test according to §15.247 (b)(1), (3)(i)**

**4.5.1 General**

This test was performed to demonstrate that the maximum RF peak output power of the transmitter does not exceed 0.125 W (21 dBm) (§15.247 (b)(1)).

If directional transmitting antenna gain is greater than 6 dBi, the maximum peak output power of an intentional radiator shall be reduced below the stated value by the amount in dB that a directional gain of an antenna exceeds 6 dBi (§15.247 (3)).

In our case antenna gain is 11 dBi, hence the maximum peak output power of the transmitter shall not exceed 21 – (11-6) = 16 dBm.

**4.5.2 Test procedure**

The test setup was the same as in paragraph 4.1.

The test was performed in the EUT transmitting mode with hopping function disabled.

The measured results are given in Plots 4.5.1 – 4.5.3 and in Table 4.5.1.

**Table 4.5.1  
Transmitter output RF power test results**

Frequency, MHz	Spectrum analyzer reading, dBm	Peak output power, dBm	Limit, dBm	Margin, dB	Result
2403	-20.33	15.17	16	0.83	Pass
2441	-19.5	16.0	16	0.0	Pass
2477	-19.5	16.0	16	0.0	Pass

**The “Pass” decision was made without Hermon Labs measurement uncertainty**

**Note:** measurements were performed with 35.5 dB external attenuation.

**Reference numbers of test equipment used**

HL 1424	HL 1567	HL1651
---------	---------	--------

Full description is given in Appendix A.



**4.5.3 Exposure limit according to part 1, §1.1310**

Limit for power density for general population/uncontrolled exposure is 1 mW/cm<sup>2</sup>.

A power density  $P$  (mW/cm<sup>2</sup>) =  $\frac{P_T}{4\pi r^2}$ , where

$P_T$  - transmitted power, which is equal to transmitter output power 16.0 dBm plus maximum antenna gain 11 dBi, the maximum equivalent isotropically radiated power (e.i.r.p.) is 27.0 dBm = 502 mW.

$$1(\text{mW/cm}^2) = 502 \text{ mW} / 4\pi r^2$$

The minimum safe distance "r", where RF exposure does not exceed FCC permissible limit, is 6.3 cm:

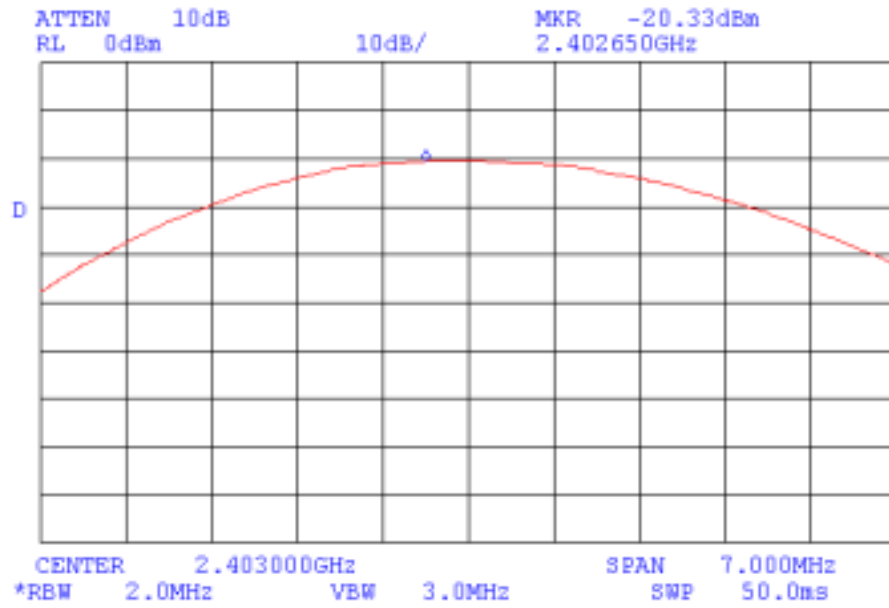
$$r = \sqrt{P_T / 4\pi} = \sqrt{502 / 4 \times 3.14} = 6.3 \text{ (cm)}.$$

Public cannot be exposed to dangerous RF level.



**Plot 4.5.1**

Transmitter output RF power test results  
External attenuation=35.5 dB

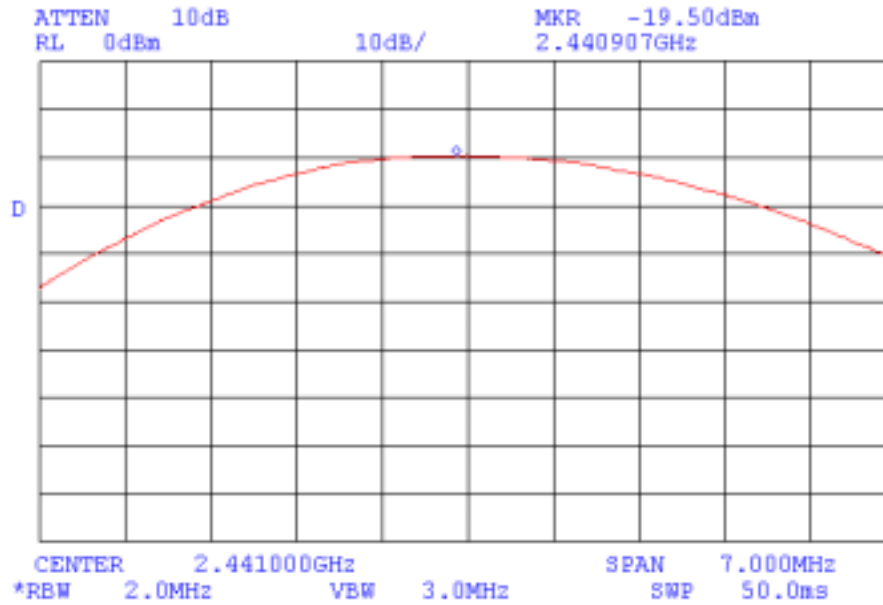


$$P_{out} = P_{meas} + Att_{ext} = -20.33 + 35.5 = 15.17 \text{ dBm}$$



**Plot 4.5.2**

Transmitter output RF power test results  
External attenuation=35.5 dB

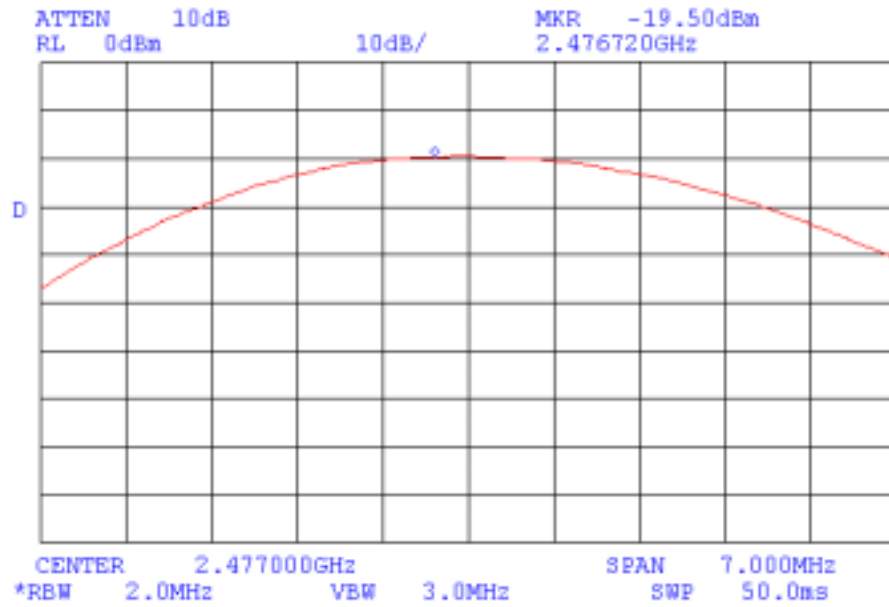


$$P_{out} = P_{meas} + Att_{ext} = -19.5 + 35.5 = 16.0 \text{ dBm}$$



**Plot 4.5.3**

Transmitter output RF power test results  
External attenuation=35.5 dB



$$P_{out} = P_{meas} + Att_{ext} = -19.5 + 35.5 = 16.0 \text{ dBm}$$



## 4.6 Band edge compliance of RF conducted emissions test according to §15.247(c)

### 4.6.1 General

This test was performed to prove that the EUT band edge RF conducted emissions in any 100 kHz bandwidth outside 2.400 to 2.4835 GHz are at least 20 dB below maximum power content as measured in any 100 kHz bandwidth within the band that contains the highest level of the desired power.

### 4.6.2 Test procedure

The test setup was the same as in paragraph 4.1.

The test was performed for the EUT in transmitting mode with modulation at the lowest 2403 MHz and highest 2477 MHz carrier (channels) frequencies. Plots 4.6.1, 4.6.3 show measurements with the EUT hopping function disabled and Plots 4.6.2, 4.6.4 show measurements with the EUT hopping function enabled. In both cases the out of bands measured signals were attenuated more than 20 dBc.

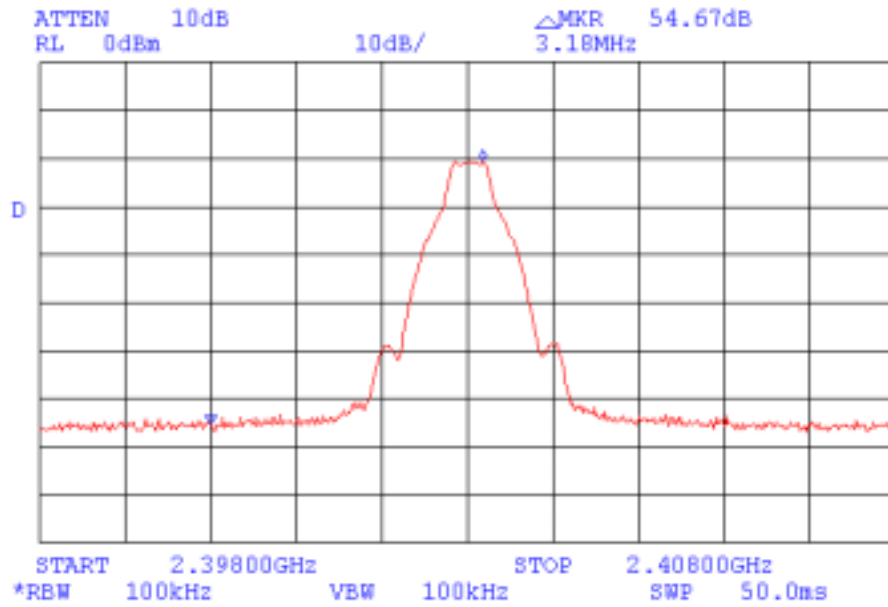
### Reference numbers of test equipment used

HL 1424	HL 1650	HL 1833
---------	---------	---------

Full description is given in Appendix A.

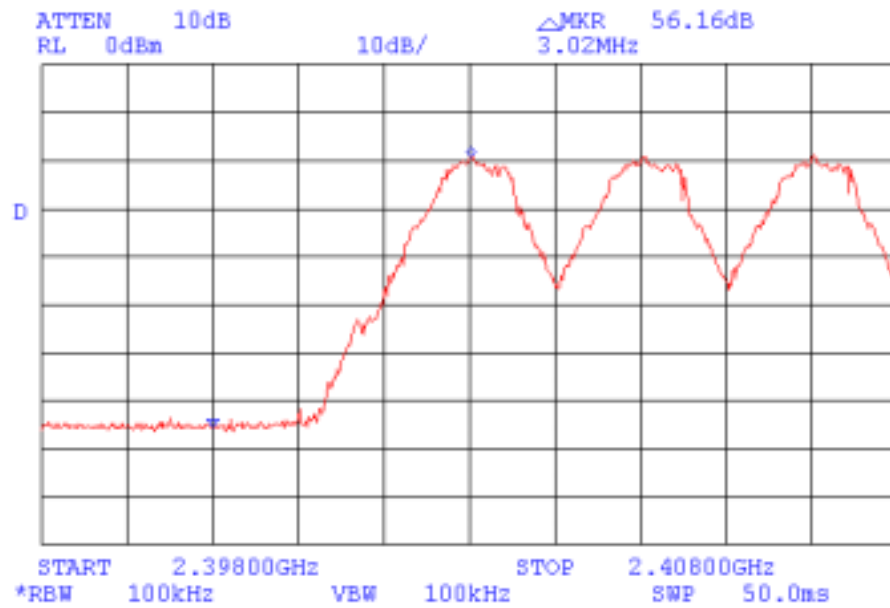


**Plot 4.6.1**  
Test specification: § 15.247 (c)  
Band edge compliance test results





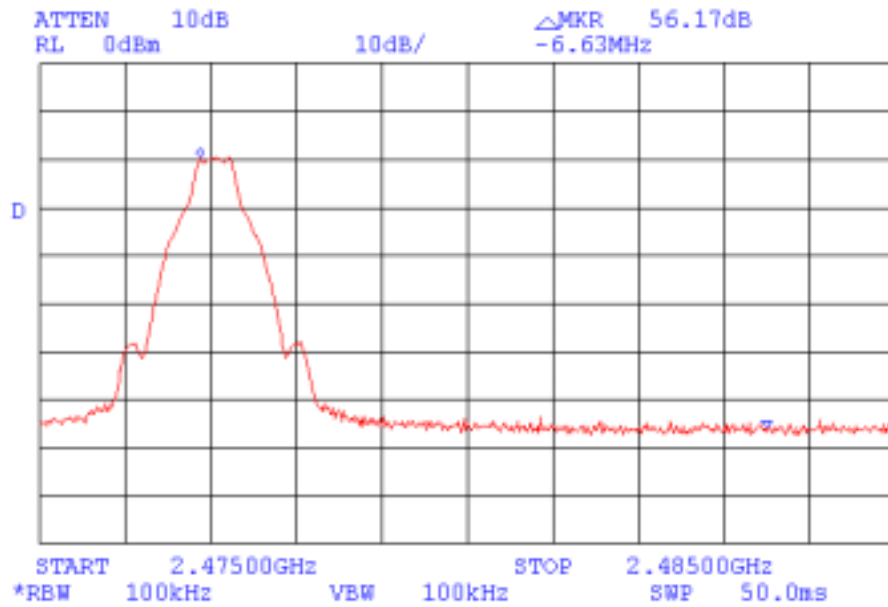
**Plot 4.6.2**  
Test specification: § 15.247 (c)  
Band edge compliance test results





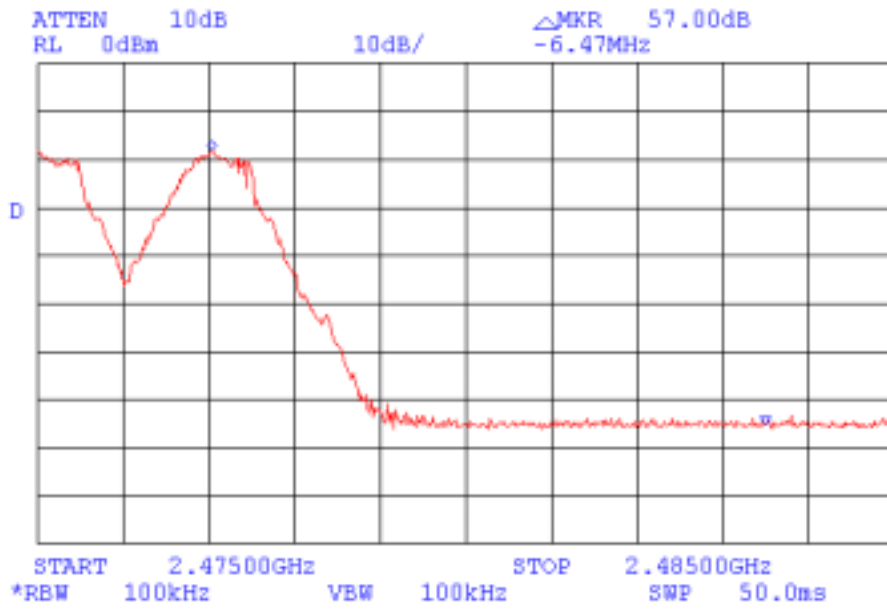


**Plot 4.6.3**  
Test specification: § 15.247 (c)  
Band edge compliance test results





**Plot 4.6.4**  
Test specification: § 15.247 (c)  
Band edge compliance test results





## 4.7 Out of band antenna conducted emissions test according to §15.247(c)

### 4.7.1 General

This test was performed to prove that the EUT out-of-band emissions in any 100 kHz bandwidth outside 2.400 to 2.4835 GHz are at least 20 dB below maximum power content as measured in any 100 kHz bandwidth within the band that contains the highest level of the desired power.

### 4.7.2 Test procedure

The test setup was the same as in paragraph 4.1.

The test was performed for the EUT in transmitting mode with modulation at 3 carrier (channels) frequencies 2403, 2441, 2477 MHz in the 9 kHz – 25 GHz frequency range. The EUT hopping function was disabled.

The display lines in the Plots 4.7.1 – 4.7.10, 4.7.15 – 4.7.24, 4.7.29 – 4.7.39 are traced 20 dB below the peaks of the in band emissions.

Plots 4.7.1 to 4.7.43 show that the out of bands measured signals were attenuated more than 20 dBc.

### Reference numbers of test equipment used

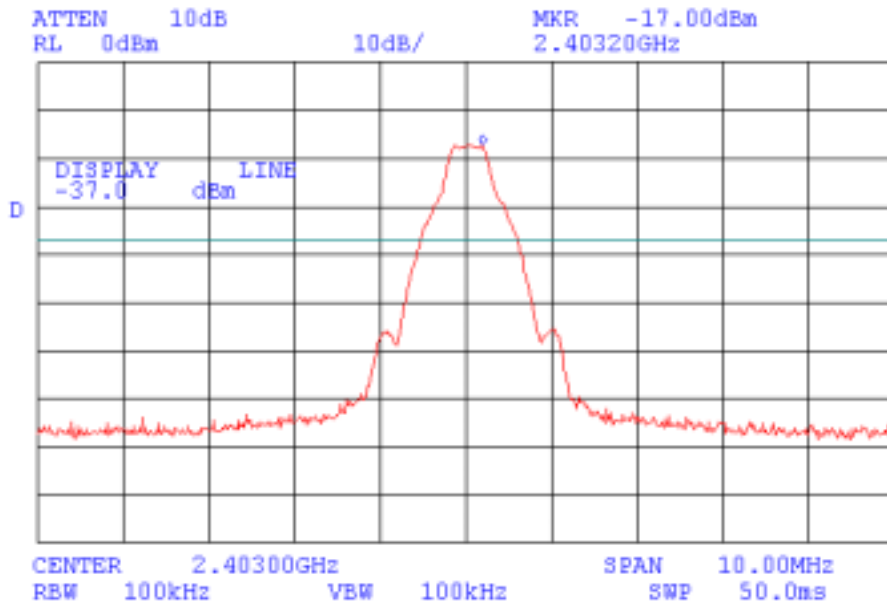
HL 1424	HL 1650	HL 1833
---------	---------	---------

Full description is given in Appendix A.



**Plot 4.7.1**

Test specification: § 15.247 (c)  
Out-of-band emissions at the antenna output terminal  
Carrier frequency 2403 MHz

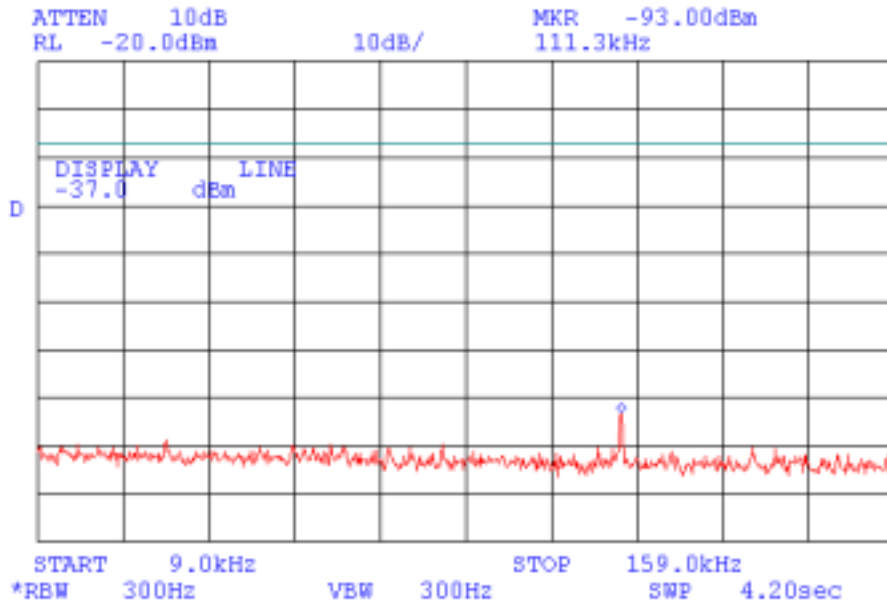


$P_{out} = P_{meas} + Att_{ext} + CL = -17 \text{ dBm} + 30 \text{ dB} + 1.2 \text{ dB} = 14.2 \text{ dBm}$   
Limit for conducted spurious emissions =  $14.2 \text{ dBm} - 20 \text{ dB} = -5.8 \text{ dBm}$



**Plot 4.7.2**

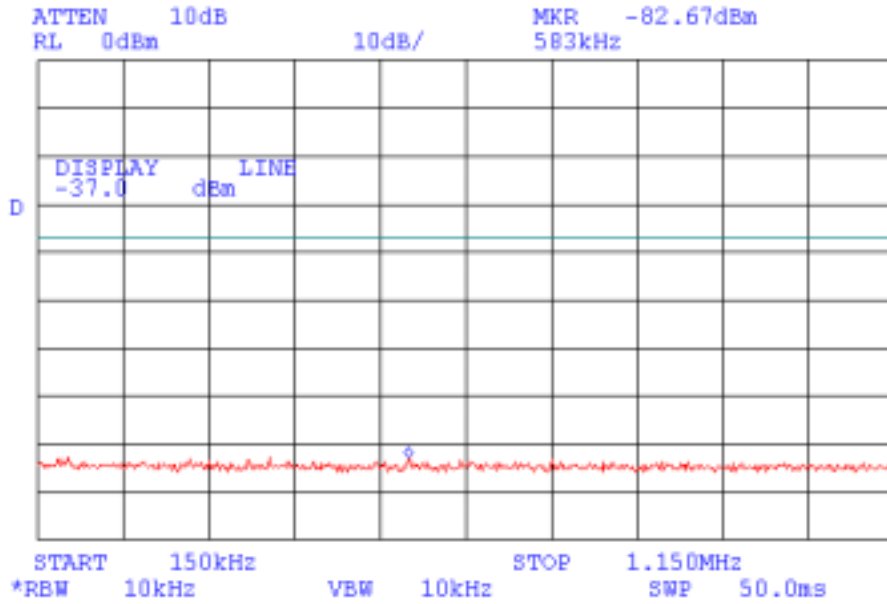
Test specification: § 15.247 (c)  
Out-of-band emissions at the antenna output terminal  
Carrier frequency 2403 MHz





**Plot 4.7.3**

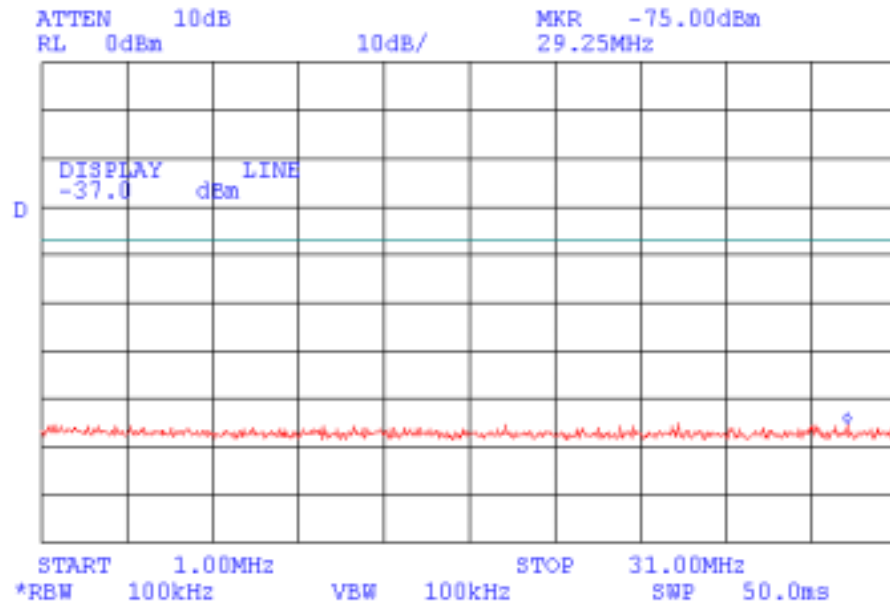
Test specification: § 15.247 (c)  
Out-of-band emissions at the antenna output terminal  
Carrier frequency 2403 MHz





**Plot 4.7.4**

Test specification: § 15.247 (c)  
Out-of-band emissions at the antenna output terminal  
Carrier frequency 2403 MHz





**Plot 4.7.5**

Test specification: § 15.247 (c)  
Out-of-band emissions at the antenna output terminal  
Carrier frequency 2403 MHz

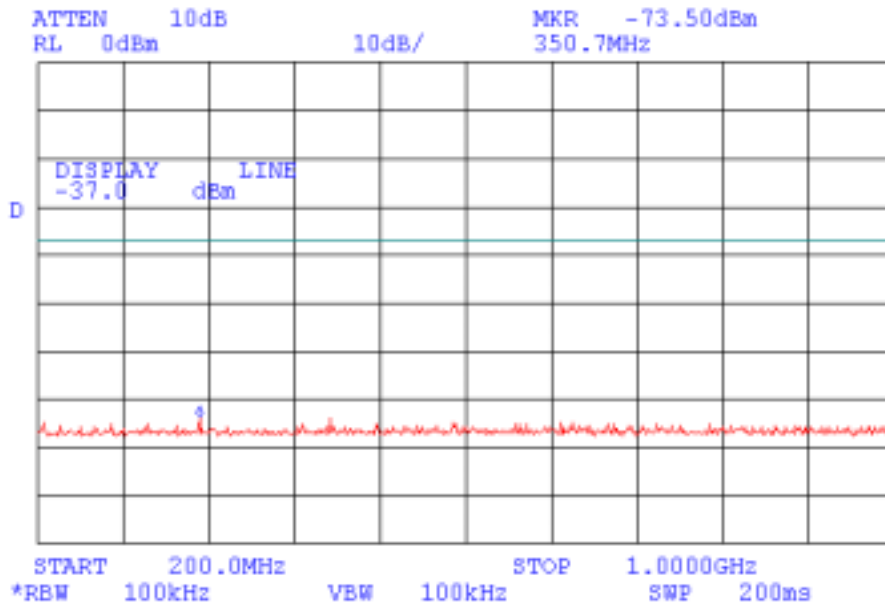






**Plot 4.7.6**

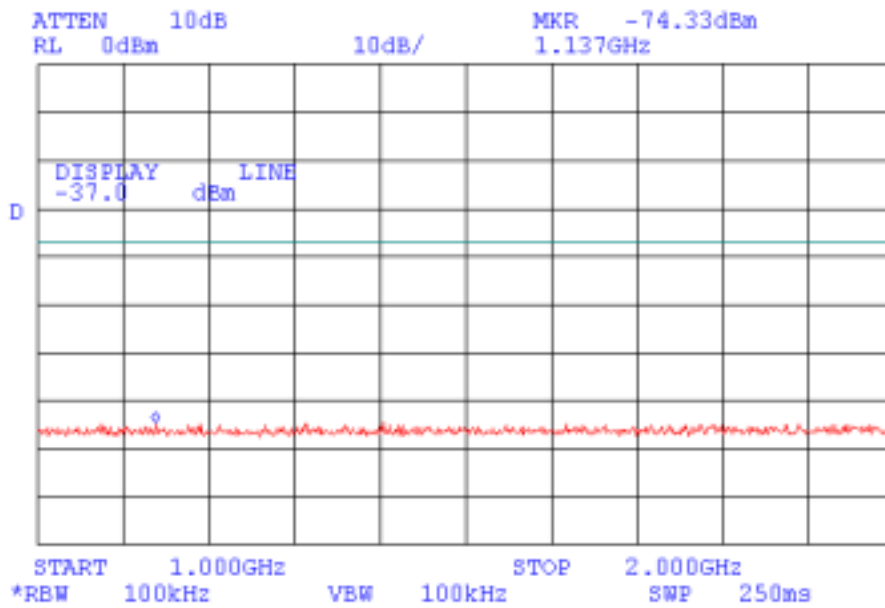
Test specification: § 15.247 (c)  
Out-of-band emissions at the antenna output terminal  
Carrier frequency 2403 MHz





**Plot 4.7.7**

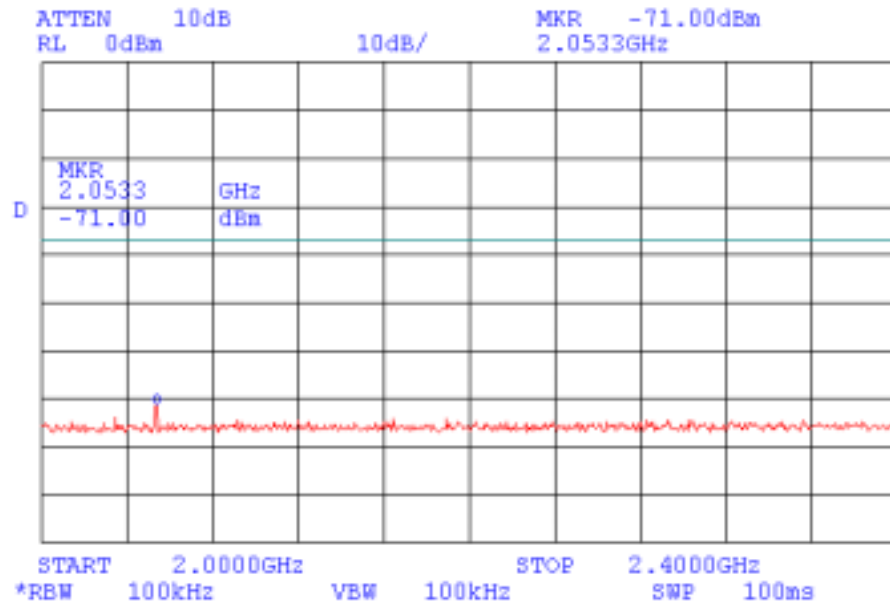
Test specification: § 15.247 (c)  
Out-of-band emissions at the antenna output terminal  
Carrier frequency 2403 MHz





**Plot 4.7.8**

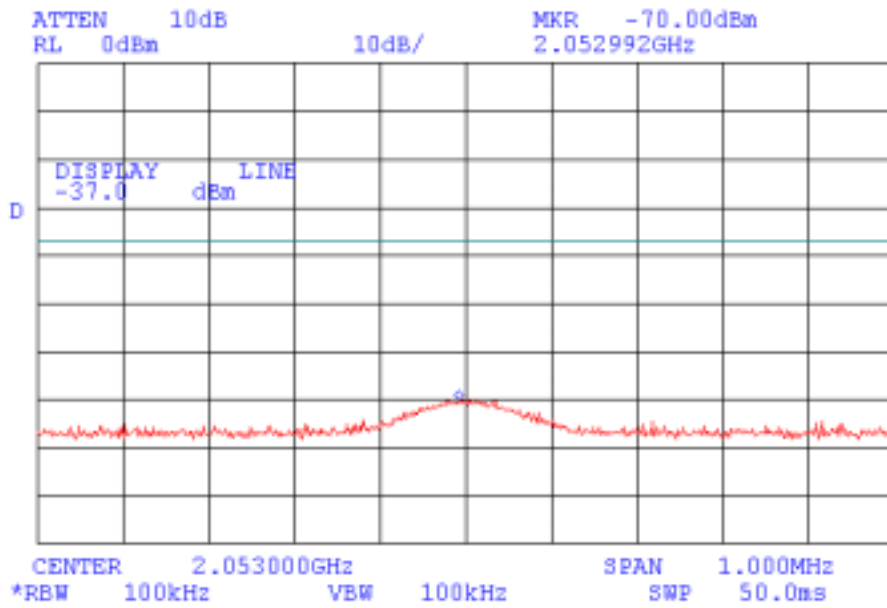
Test specification: § 15.247 (c)  
Out-of-band emissions at the antenna output terminal  
Carrier frequency 2403 MHz





**Plot 4.7.9**

Test specification: § 15.247 (c)  
Out-of-band emissions at the antenna output terminal  
Carrier frequency 2403 MHz



Local oscillator frequency



**Plot 4.7.10**

Test specification: § 15.247 (c)  
Out-of-band emissions at the antenna output terminal  
Carrier frequency 2403 MHz





**Plot 4.7.11**

Test specification: § 15.247 (c)  
Out-of-band emissions at the antenna output terminal  
Carrier frequency 2403 MHz

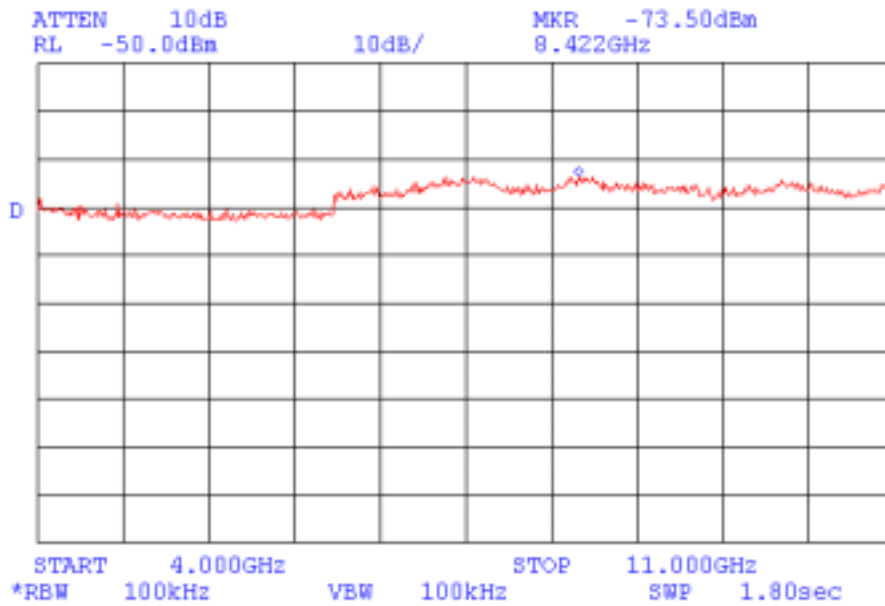


Noise level=-77.67 dBm+0.47 dB(CL)+30 dB(Att)=-47.2 dBm  
Limit=-5.8 dBm



**Plot 4.7.12**

Test specification: § 15.247 (c)  
Out-of-band emissions at the antenna output terminal  
Carrier frequency 2403 MHz

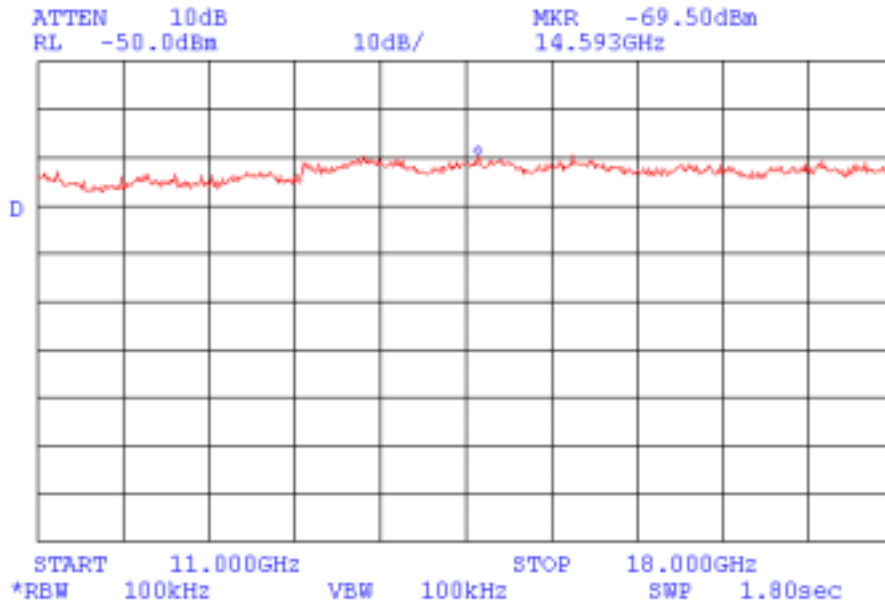


Noise level=-73.5 dBm+1 dB(CL)+30 dB(Att)=-42.5 dBm  
Limit=-5.8 dBm



**Plot 4.7.13**

Test specification: § 15.247 (c)  
Out-of-band emissions at the antenna output terminal  
Carrier frequency 2403 MHz



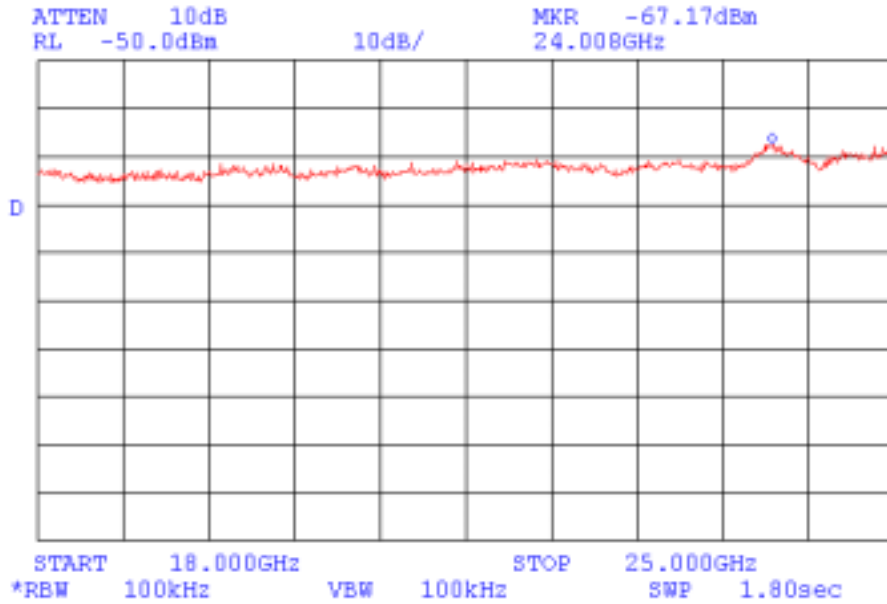
Noise level=-69.5 dBm+1.6 dB(CL)+30 dB(Att)=-37.9 dBm  
Limit=-5.8 dBm





**Plot 4.7.14**

Test specification: § 15.247 (c)  
Out-of-band emissions at the antenna output terminal  
Carrier frequency 2403 MHz

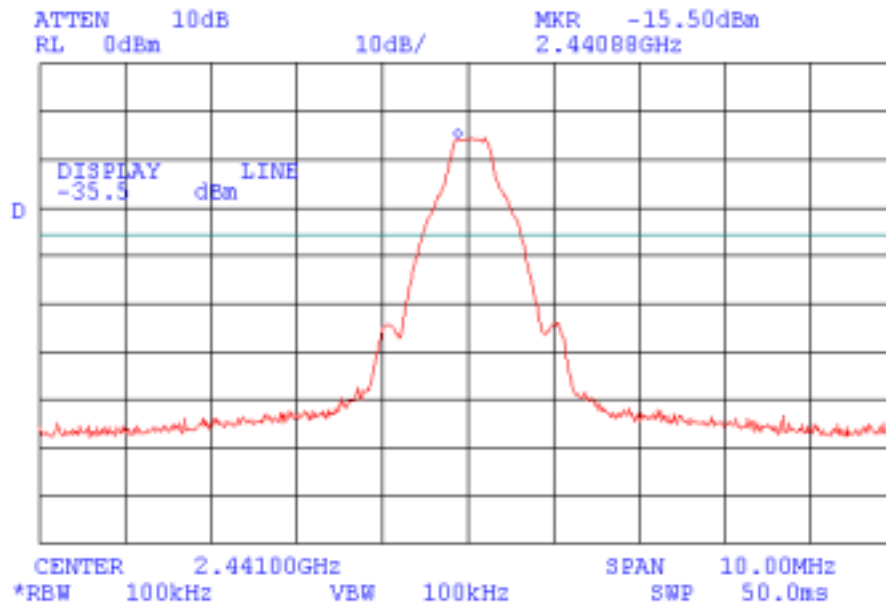


Noise level=-67.17 dBm+2.5 dB(CL)+30 dB(Att)=-34.67 dBm  
Limit=-5.8 dBm



**Plot 4.7.15**

Test specification: § 15.247 (c)  
Out-of-band emissions at the antenna output terminal  
Carrier frequency 2441 MHz

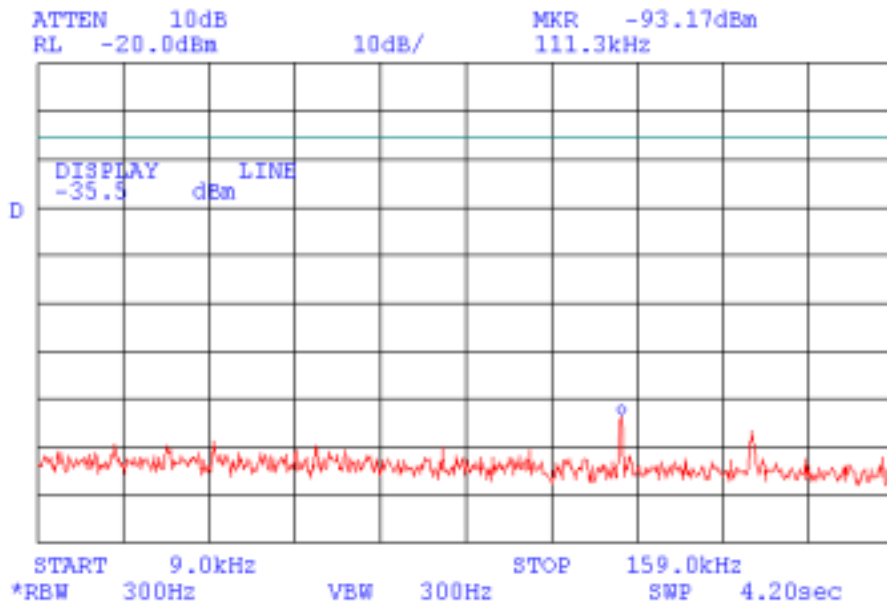


$P_{out} = P_{meas} + Att_{ext} + CL = -15.5 \text{ dBm} + 30 \text{ dB} + 0.4 \text{ dB} = 14.9 \text{ dBm}$   
Limit for conducted spurious emissions =  $14.9 \text{ dBm} - 20 \text{ dB} = -5.1 \text{ dBm}$



**Plot 4.7.16**

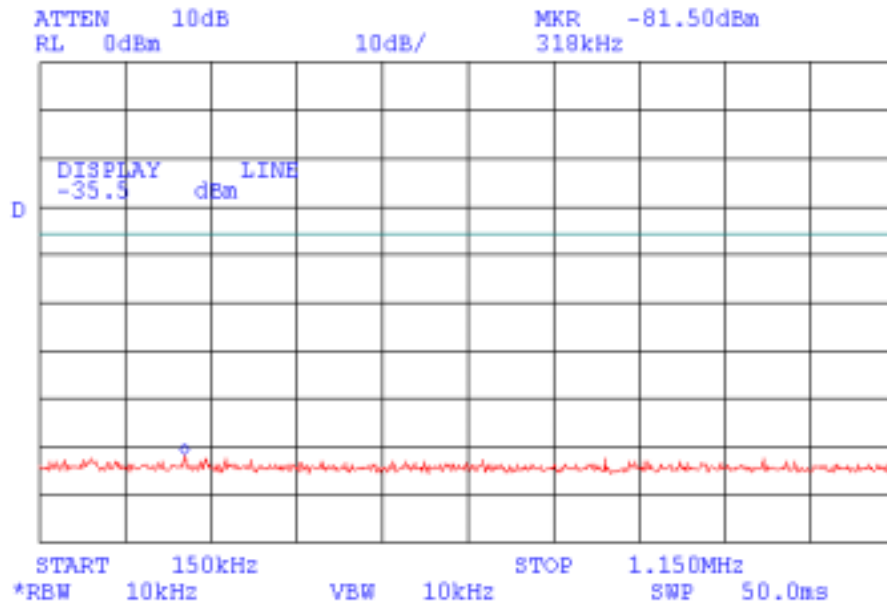
Test specification: § 15.247 (c)  
Out-of-band emissions at the antenna output terminal  
Carrier frequency 2441 MHz





**Plot 4.7.17**

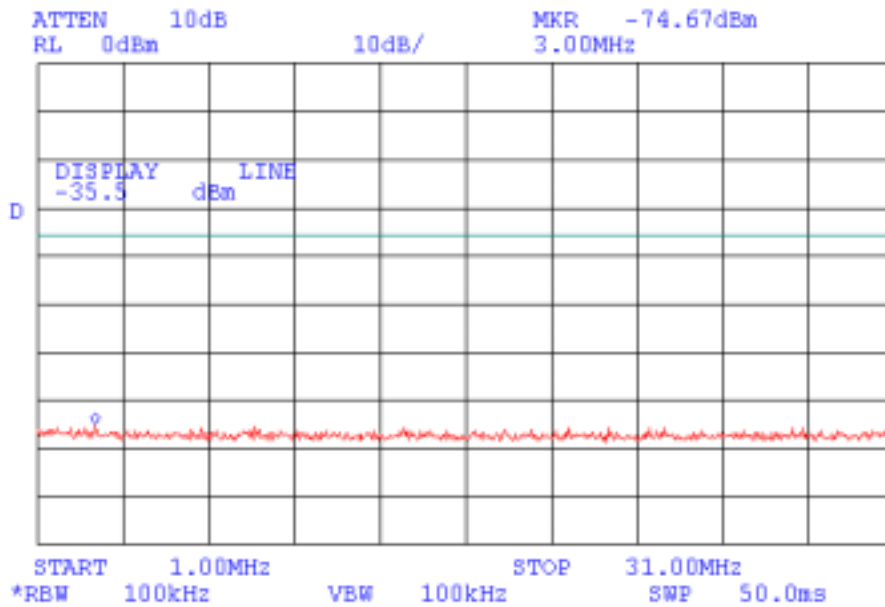
Test specification: § 15.247 (c)  
Out-of-band emissions at the antenna output terminal  
Carrier frequency 2441 MHz





**Plot 4.7.18**

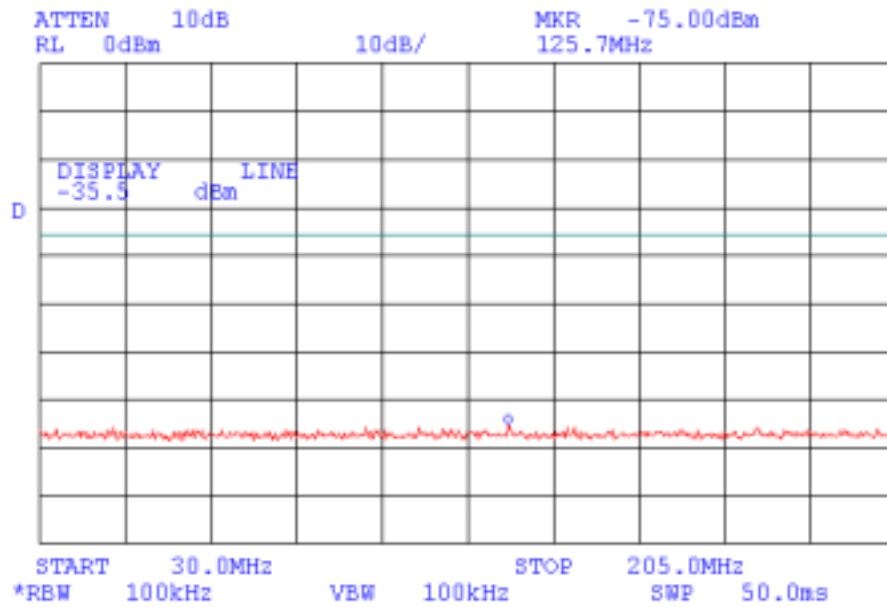
Test specification: § 15.247 (c)  
Out-of-band emissions at the antenna output terminal  
Carrier frequency 2441 MHz





**Plot 4.7.19**

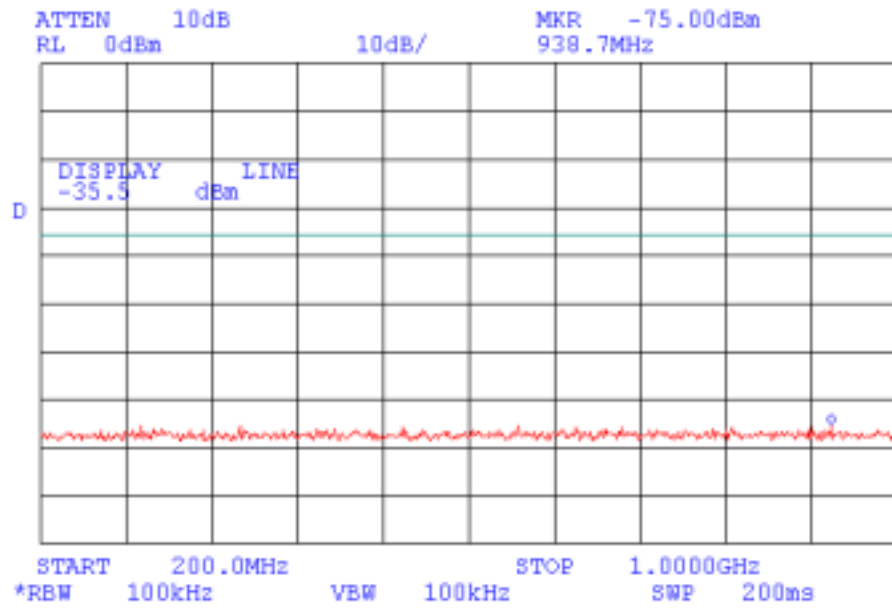
Test specification: § 15.247 (c)  
Out-of-band emissions at the antenna output terminal  
Carrier frequency 2441 MHz





**Plot 4.7.20**

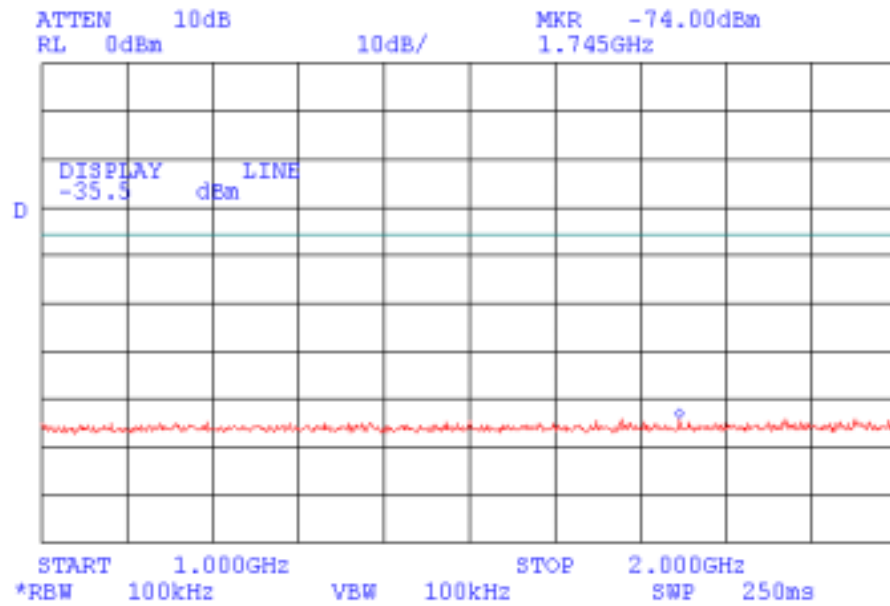
Test specification: § 15.247 (c)  
Out-of-band emissions at the antenna output terminal  
Carrier frequency 2441 MHz





**Plot 4.7.21**

Test specification: § 15.247 (c)  
Out-of-band emissions at the antenna output terminal  
Carrier frequency 2441 MHz

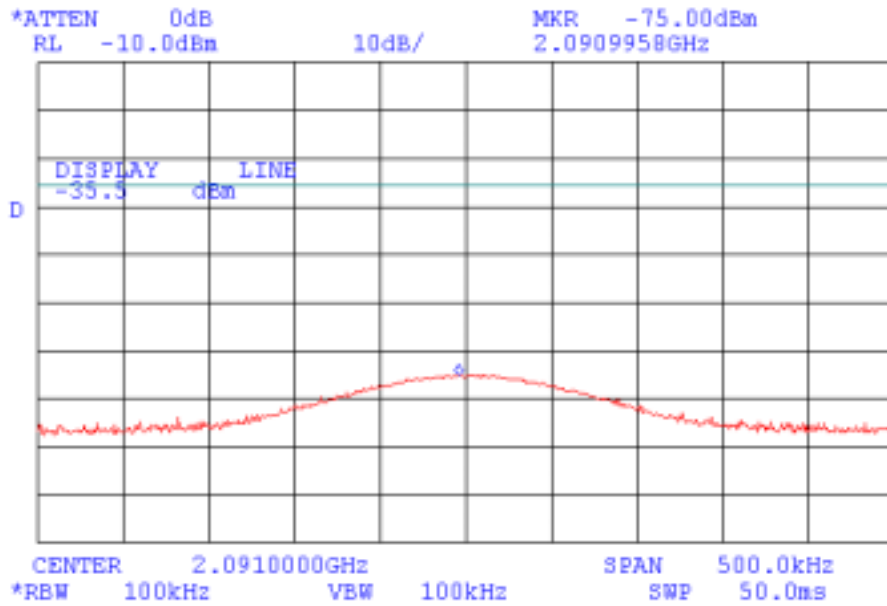






**Plot 4.7.22**

Test specification: § 15.247 (c)  
Out-of-band emissions at the antenna output terminal  
Carrier frequency 2441 MHz

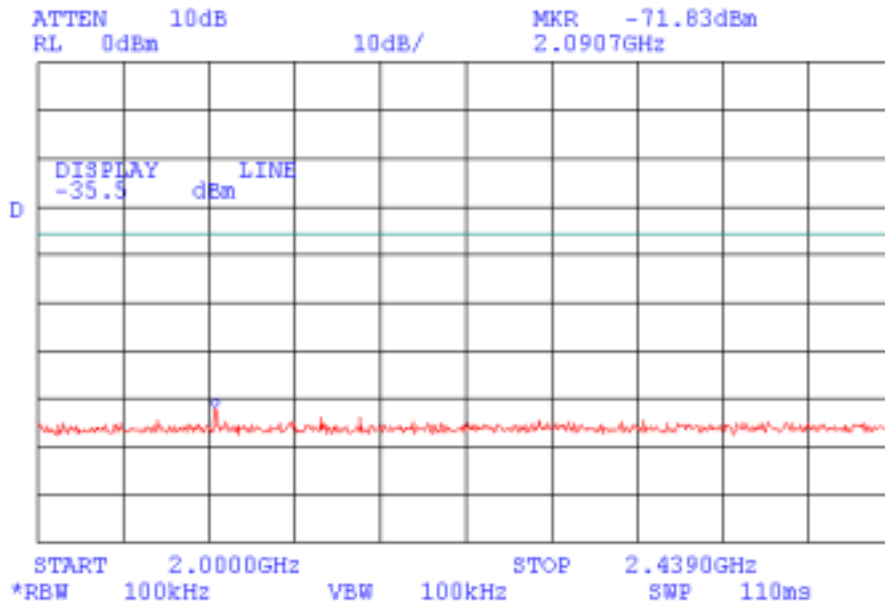


Local oscillator frequency



**Plot 4.7.23**

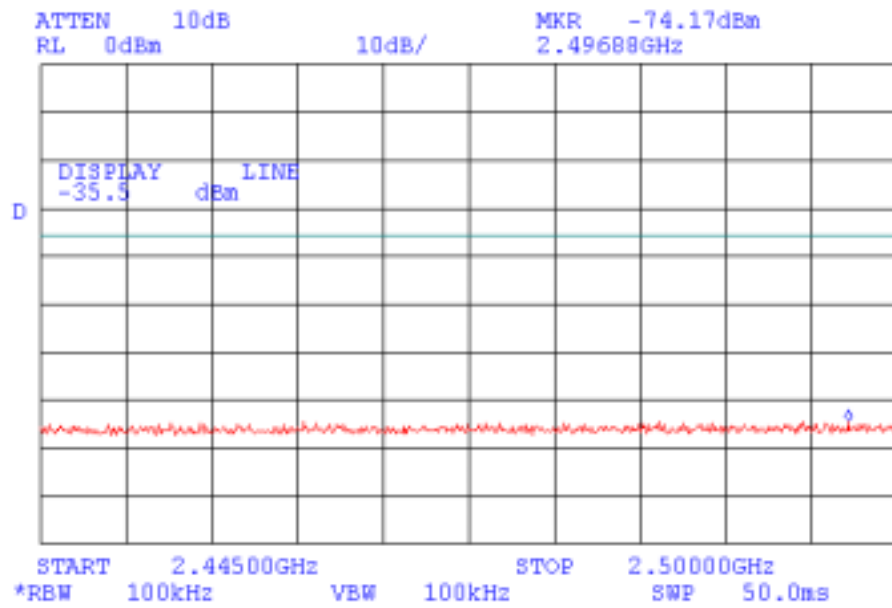
Test specification: § 15.247 (c)  
Out-of-band emissions at the antenna output terminal  
Carrier frequency 2441 MHz





**Plot 4.7.24**

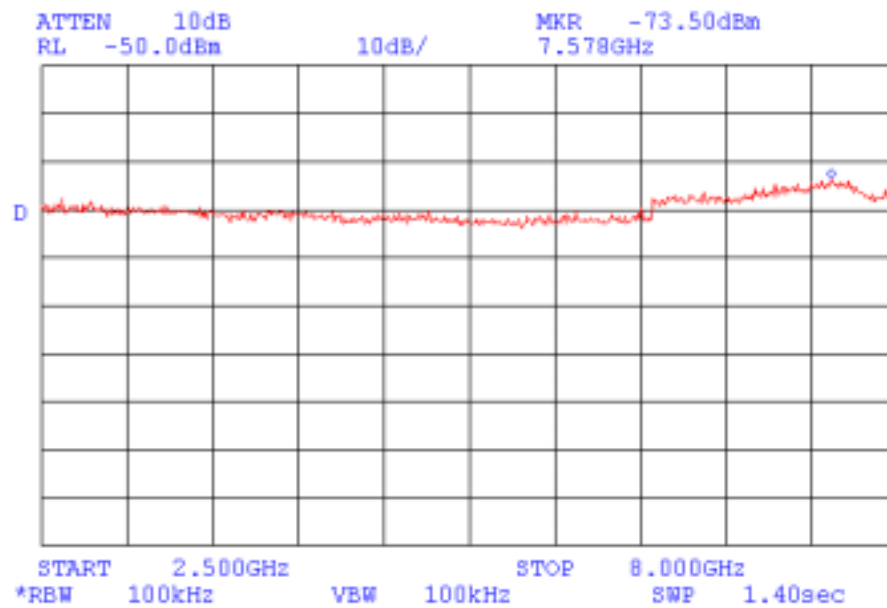
Test specification: § 15.247 (c)  
Out-of-band emissions at the antenna output terminal  
Carrier frequency 2441 MHz





**Plot 4.7.25**

Test specification: § 15.247 (c)  
Out-of-band emissions at the antenna output terminal  
Carrier frequency 2441 MHz

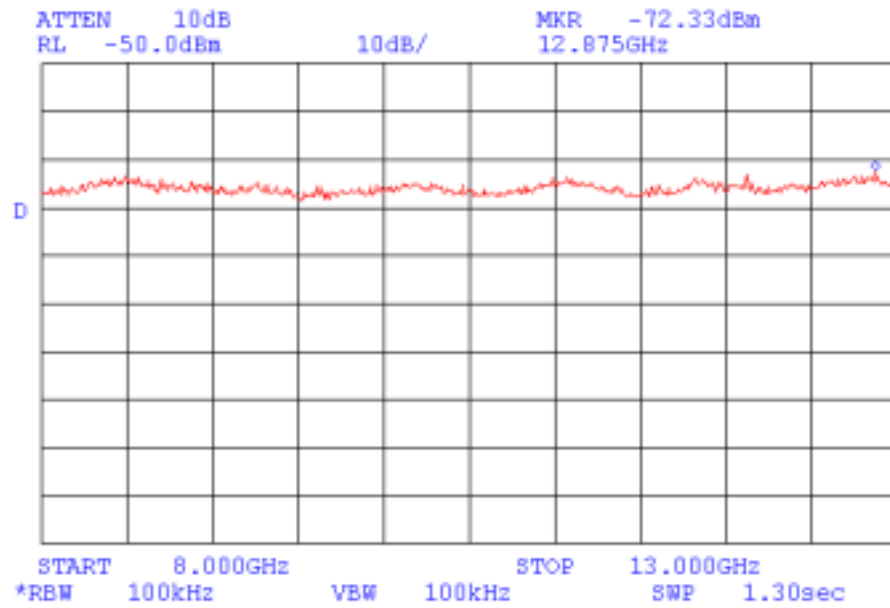


Noise level=-73.5 dBm+0.9 dB(CL)+30 dB(Att)=-42.6 dBm  
Limit=-5.1 dBm



**Plot 4.7.26**

Test specification: § 15.247 (c)  
Out-of-band emissions at the antenna output terminal  
Carrier frequency 2441 MHz

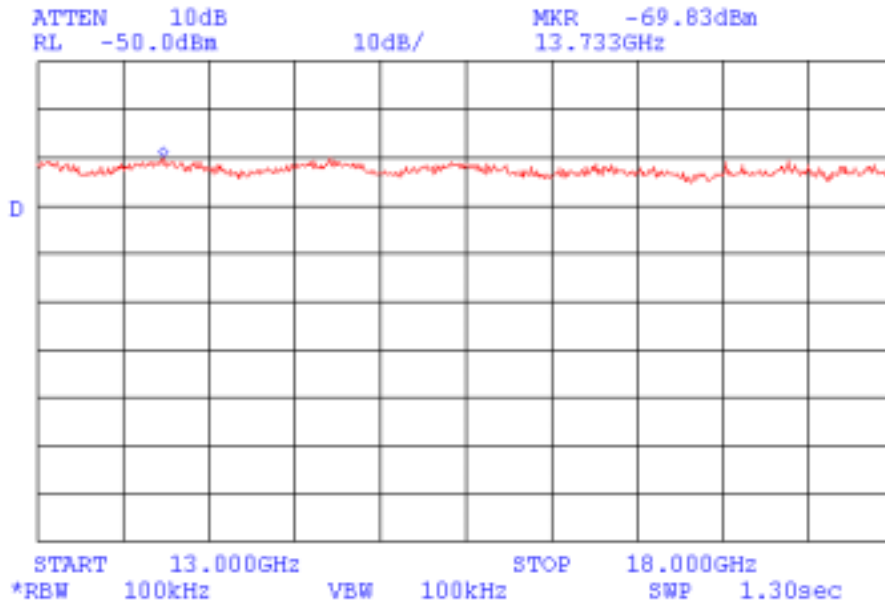


Noise level=-72.33 dBm+1.44 dB(CL)+30 dB(Att)=-40.89 dBm  
Limit=-5.1 dBm



**Plot 4.7.27**

Test specification: § 15.247 (c)  
Out-of-band emissions at the antenna output terminal  
Carrier frequency 2441 MHz

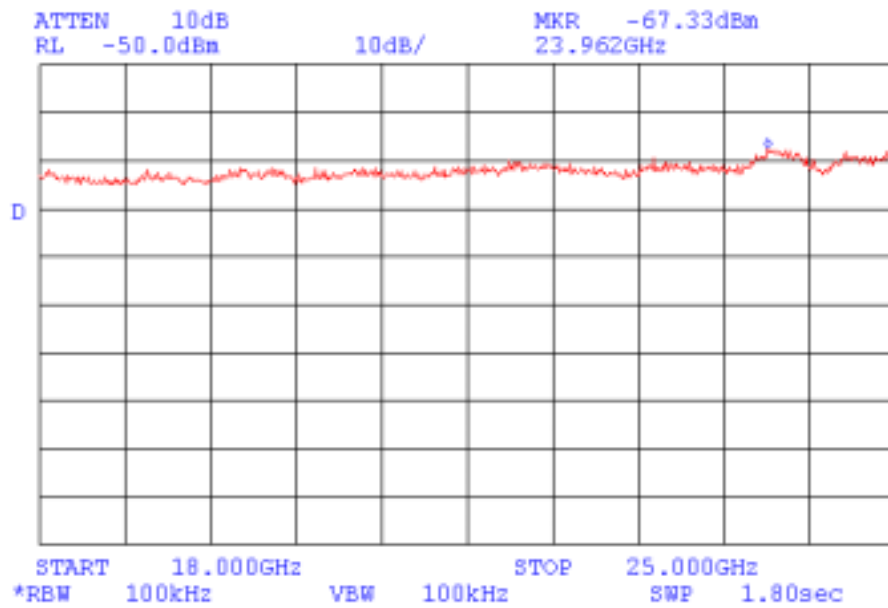


Noise level=-69.83 dBm+1.52 dB(CL)+30 dB(Att)=-38.31 dBm  
Limit=-5.1 dBm



**Plot 4.7.28**

Test specification: § 15.247 (c)  
Out-of-band emissions at the antenna output terminal  
Carrier frequency 2441 MHz

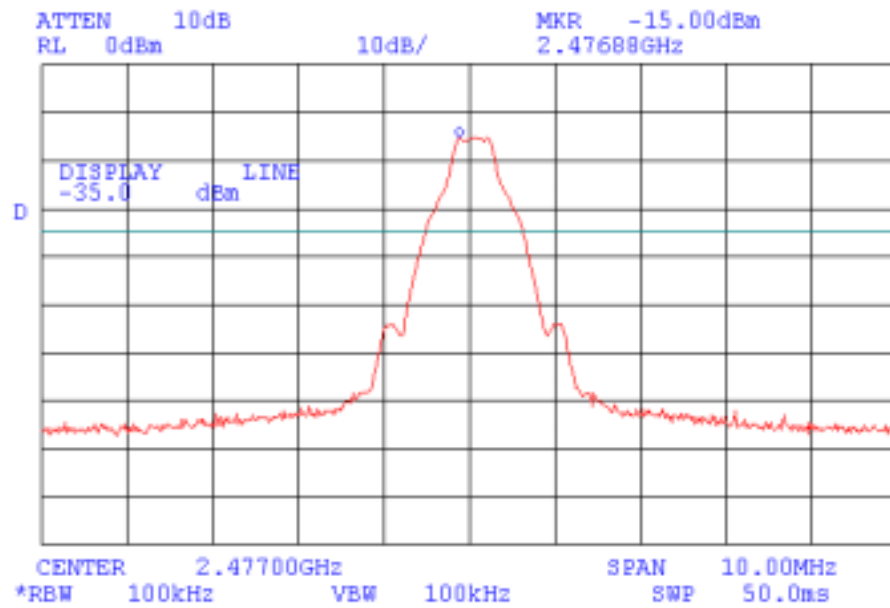


Noise level=-67.33 dBm+2.5 dB(CL)+30 dB(Att)=-34.83 dBm  
Limit=-5.1 dBm



**Plot 4.7.29**

Test specification: § 15.247 (c)  
Out-of-band emissions at the antenna output terminal  
Carrier frequency 2477 MHz



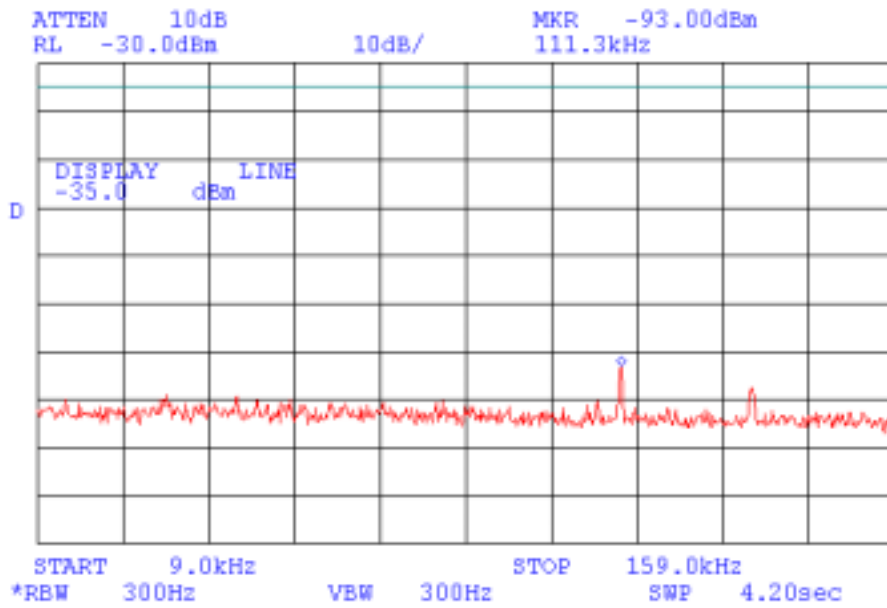
$P_{out} = P_{meas} + Att_{ext} + CL = -15 \text{ dBm} + 30 \text{ dB} + 0.4 \text{ dB} = 15.4 \text{ dBm}$   
Limit for conducted spurious emissions =  $15.4 \text{ dBm} - 20 \text{ dB} = -4.6 \text{ dBm}$





**Plot 4.7.30**

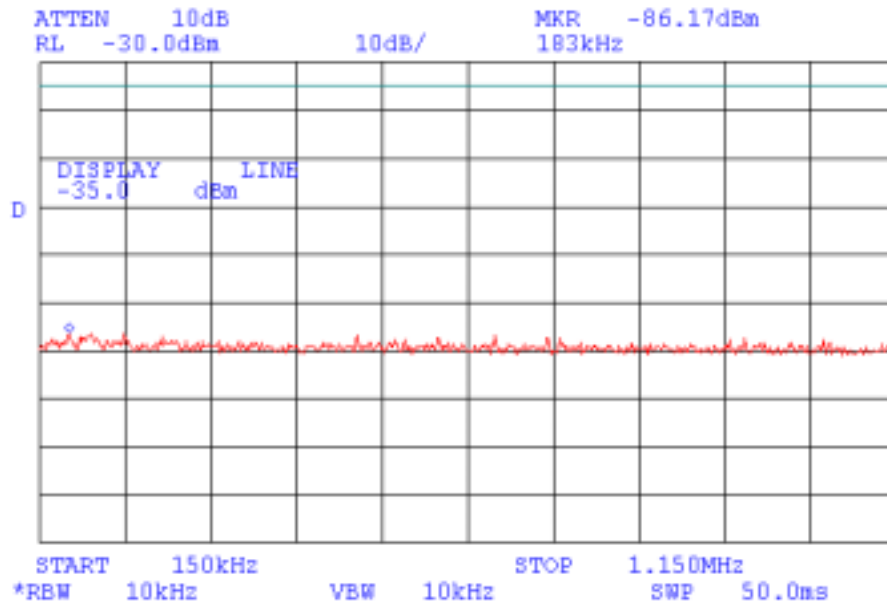
Test specification: § 15.247 (c)  
Out-of-band emissions at the antenna output terminal  
Carrier frequency 2477 MHz





**Plot 4.7.31**

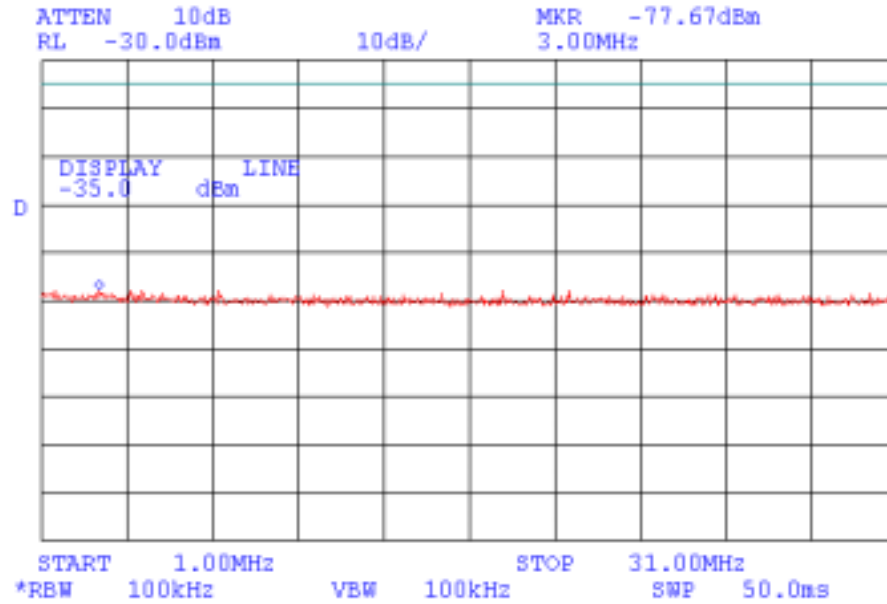
Test specification: § 15.247 (c)  
Out-of-band emissions at the antenna output terminal  
Carrier frequency 2477 MHz





**Plot 4.7.32**

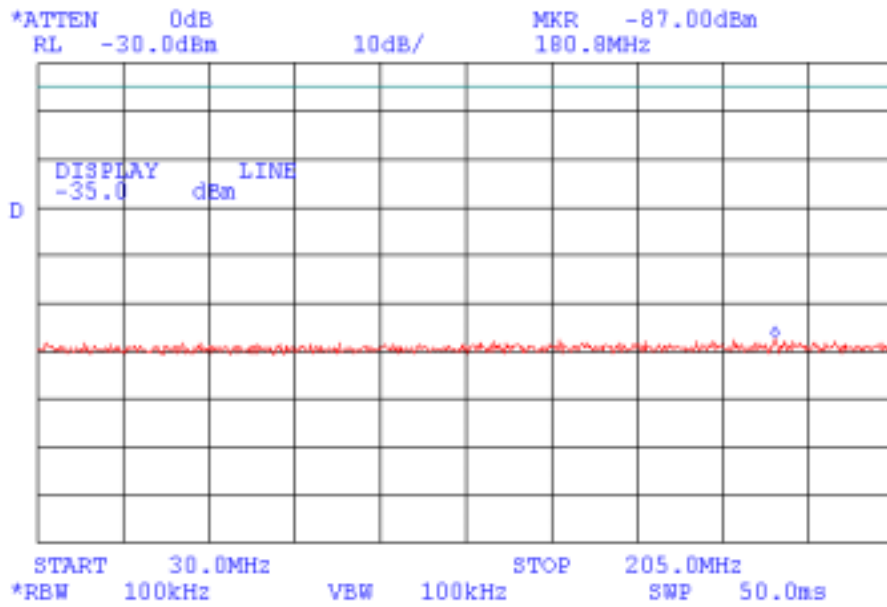
Test specification: § 15.247 (c)  
Out-of-band emissions at the antenna output terminal  
Carrier frequency 2477 MHz





**Plot 4.7.33**

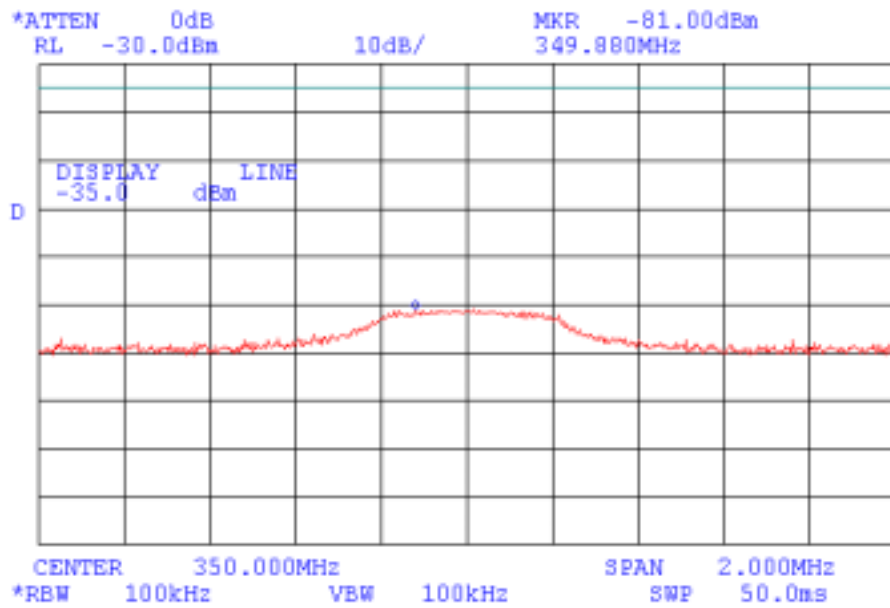
Test specification: § 15.247 (c)  
Out-of-band emissions at the antenna output terminal  
Carrier frequency 2477 MHz





**Plot 4.7.34**

Test specification: § 15.247 (c)  
Out-of-band emissions at the antenna output terminal  
Carrier frequency 2477 MHz

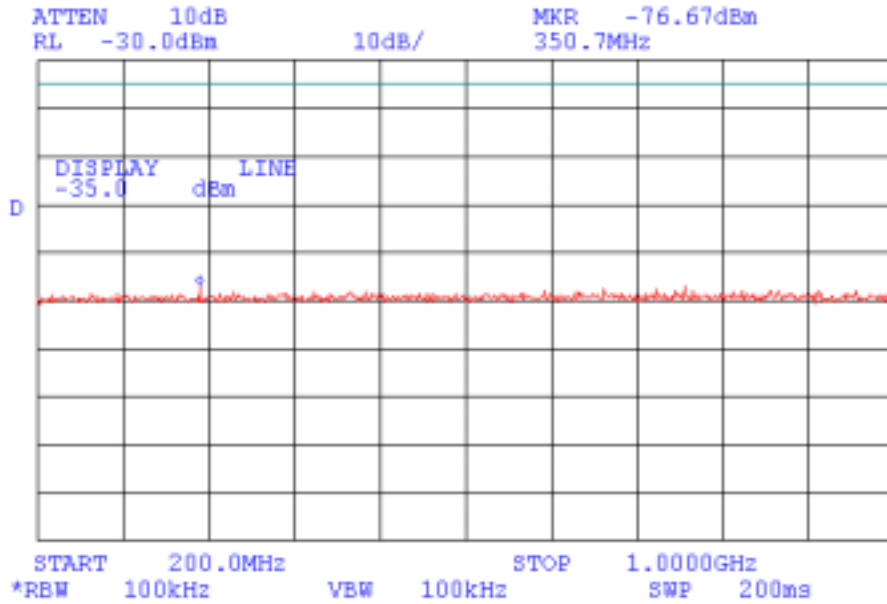


Intermediate frequency



**Plot 4.7.35**

Test specification: § 15.247 (c)  
Out-of-band emissions at the antenna output terminal  
Carrier frequency 2477 MHz





**Plot 4.7.36**

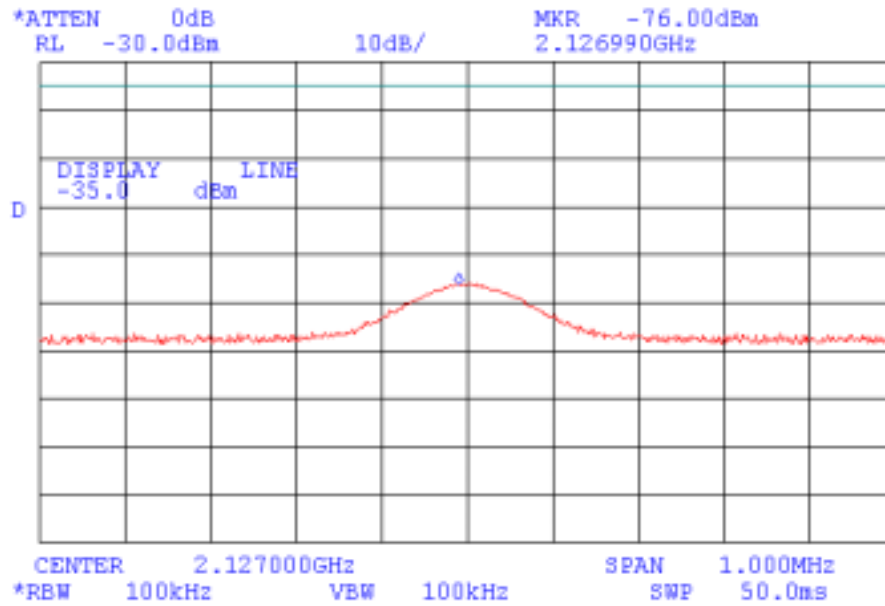
Test specification: § 15.247 (c)  
Out-of-band emissions at the antenna output terminal  
Carrier frequency 2477 MHz





**Plot 4.7.37**

Test specification: § 15.247 (c)  
Out-of-band emissions at the antenna output terminal  
Carrier frequency 2477 MHz



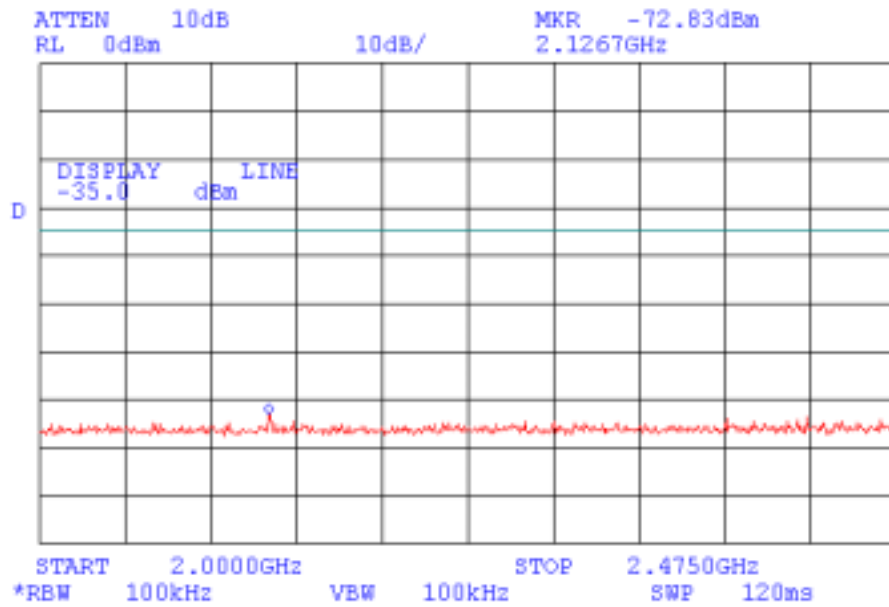
Local oscillator frequency





**Plot 4.7.38**

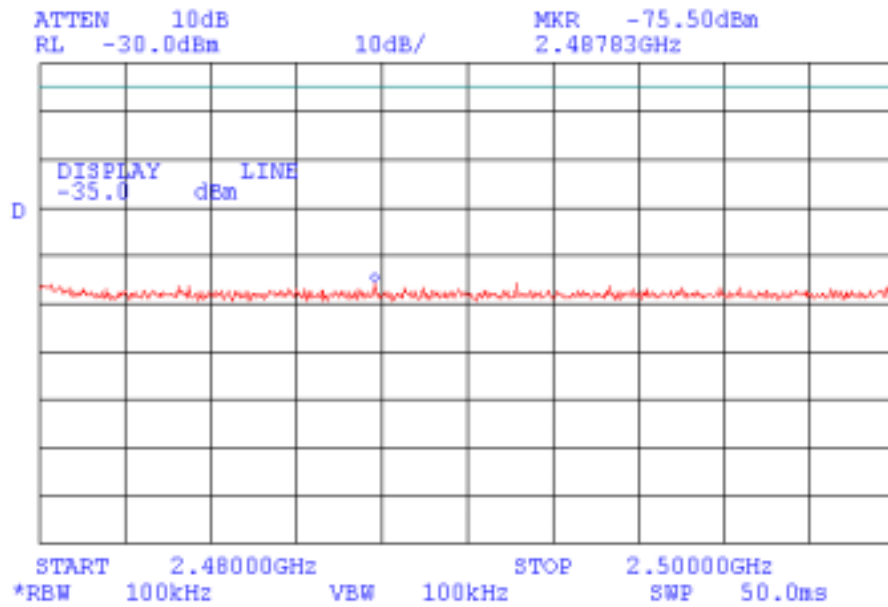
Test specification: § 15.247 (c)  
Out-of-band emissions at the antenna output terminal  
Carrier frequency 2477 MHz





**Plot 4.7.39**

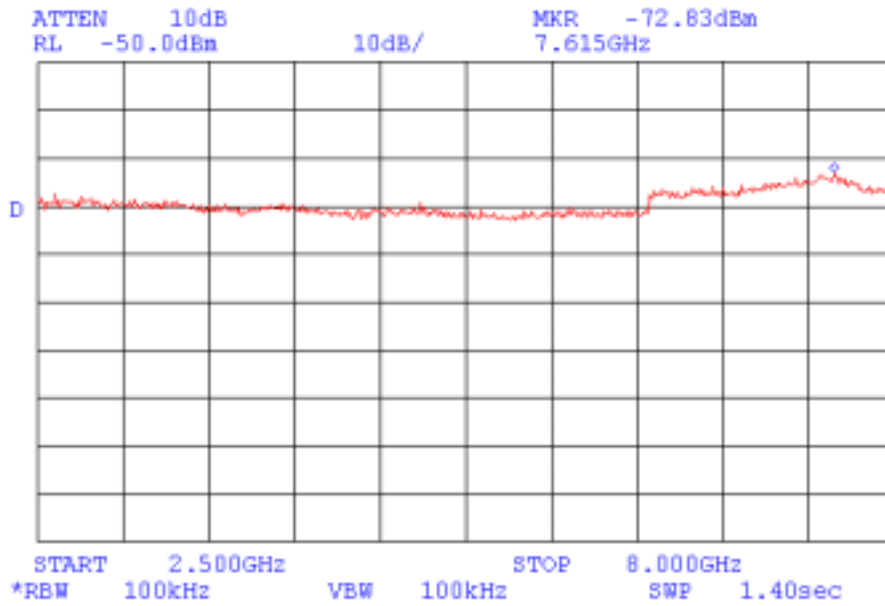
Test specification: § 15.247 (c)  
Out-of-band emissions at the antenna output terminal  
Carrier frequency 2477 MHz





**Plot 4.7.40**

Test specification: § 15.247 (c)  
Out-of-band emissions at the antenna output terminal  
Carrier frequency 2477 MHz

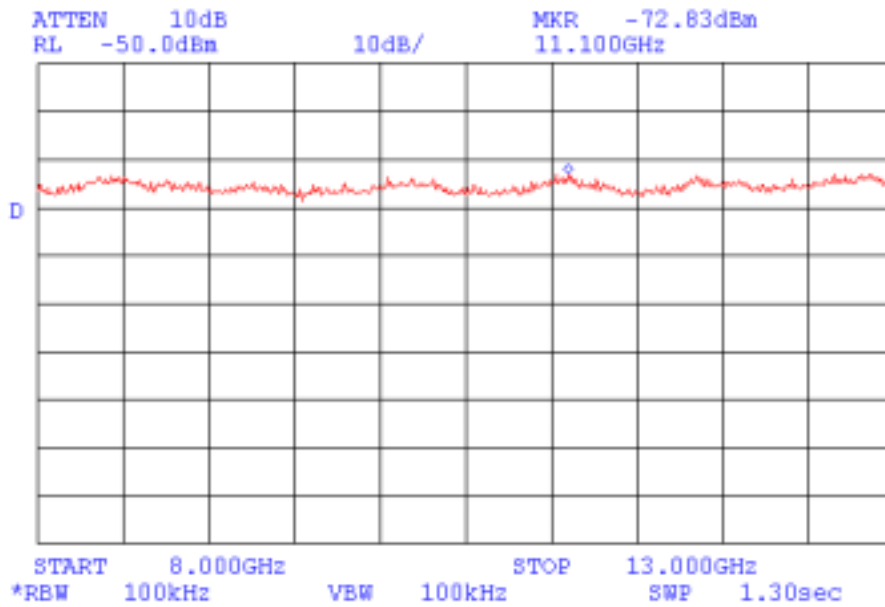


Noise level=-72.83 dBm+0.94 dB(CL)+30 dB(Att)=-41.89 dBm  
Limit=-4.6 dBm



**Plot 4.7.41**

Test specification: § 15.247 (c)  
Out-of-band emissions at the antenna output terminal  
Carrier frequency 2477 MHz

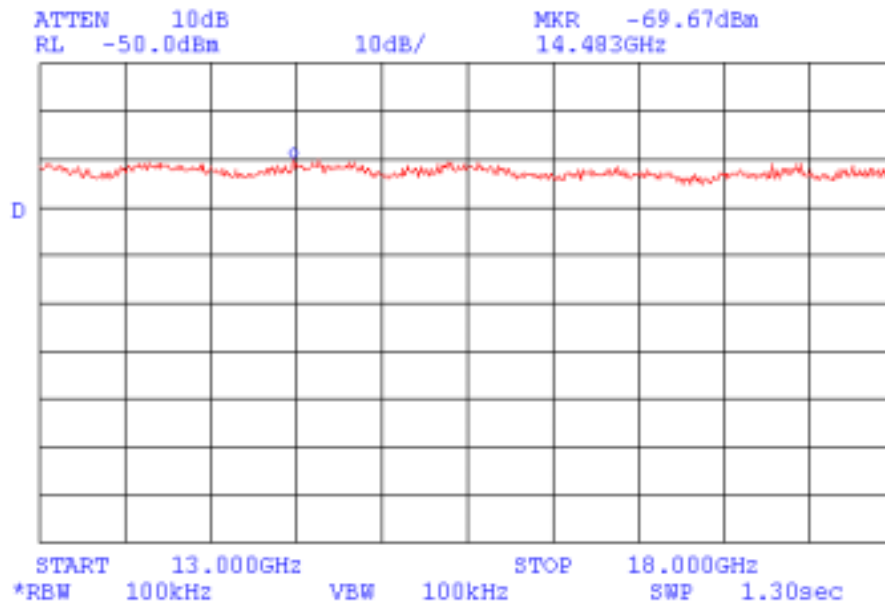


Noise level=-72.83 dBm+1.27 dB(CL)+30 dB(Att)=-41.56 dBm  
Limit=-4.6 dBm



**Plot 4.7.42**

Test specification: § 15.247 (c)  
Out-of-band emissions at the antenna output terminal  
Carrier frequency 2477 MHz

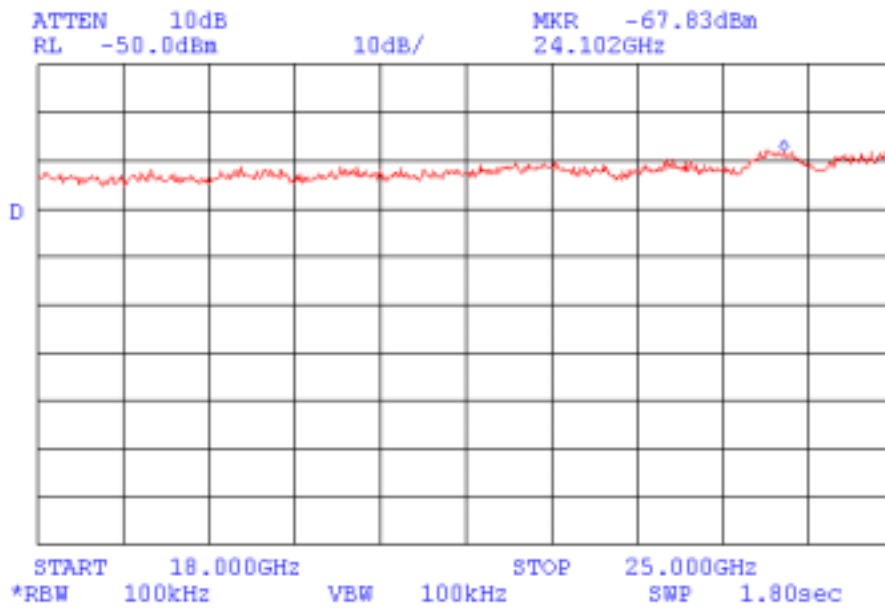


Noise level=-69.67 dBm+1.6 dB(CL)+30 dB(Att)=-38.07 dBm  
Limit=-4.6 dBm



**Plot 4.7.43**

Test specification: § 15.247 (c)  
Out-of-band emissions at the antenna output terminal  
Carrier frequency 2477 MHz



Noise level=-67.83 dBm+2.52 dB(CL)+30 dB(Att)=-35.31 dBm  
Limit=-4.6 dBm



## 4.8 Out of band radiated emissions test according to §15.247(c) and § 15.205, §15.209(a)

### 4.8.1 General

This test was performed to measure radiated emissions except carriers generated by the transmitter and to prove that radiated emissions which fall in the restricted bands comply with §15.209(a) limits.

### 4.8.2 Test procedure and results

Radiated emissions measurements were performed at 3 meter measuring distance in the anechoic chamber with active receiving loop antenna from 9 kHz to 30 MHz and with the biconilog antenna from 30 MHz to 2 GHz and at the open field test site with the double ridged guide antenna from 2 GHz to 18 GHz and with the standard gain horn antenna from 18 GHz to 24.8 GHz as shown in Photographs 4.8.1. to 4.8.3 and Figures 4.8.1 to 4.8.2.

The continuously operated EUT was set up on the 0.8 m high wooden table installed on the top of the metal turntable flush mounted with the ground plane. To find the maximum radiated emissions biconilog, double ridged and standard gain horn antennas height was changed from 1 to 4 m, the turntable was rotated 360° and the biconilog, double ridged guide and standard gain horn antennas polarization was changed from vertical to horizontal.

The test was performed for the EUT in transmitting mode with modulation at 3 carrier (channels) frequencies 2403, 2441, 2477 MHz. The EUT hopping function was disabled. Table 4.8.1 and Plots 4.8.1 to 4.8.49 show results of measurements.

The EUT successfully passed this test.

### Reference numbers of test equipment used

HL 0041	HL 0547	HL 0554	HL 0604	HL 0768	HL 1059	HL 1200
HL 1424	HL 1915					

Full description is given in Appendix A.



**Table 4.8.1 Out of band radiated emission measurements test results  
frequency range 30 MHz –1 GHz**

DATE: September 20, 2001  
RELATIVE HUMIDITY: 43%  
AMBIENT TEMPERATURE: 29°C  
DETECTOR TYPE QUASI-PEAK  
RBW 120 KHz  
ANTENNA TYPE BICONILOG  
ANTENNA HEIGHT 1 M

MEASUREMENTS PERFORMED AT 3 METER DISTANCE

Frequency, MHz	Carrier frequency, MHz,	Antenna pol.	TT pos., °	Radiated emissions, dB (µV/m)	Limit, dB (µV/m)	Margin, dB	Pass/ Fail
60.00	2403	V	38	27.19	40.0	12.81	Pass
85.937750	2403	V	320	34.59	40.0	5.41	Pass
90.00	2403	V	12	34.17	43.5	9.33	Pass
240.00	2403	V	114	37.23	46.0	3.29	Pass
260.00	2403	V	96	42.71	46.0	2.09	Pass
300.00	2477	H	103	41.24	46.0	4.76	Pass
520.00	2403	V	240	37.43	46.0	8.57	Pass

**The “Pass” decision was made without Hermon Labs measurement uncertainty**

**Notes to table calculations:**

RBW = resolution bandwidth

TT pos. = turntable position in degrees, (EUT front panel = 0°)

Margin = dB below (negative if above) specification limit.



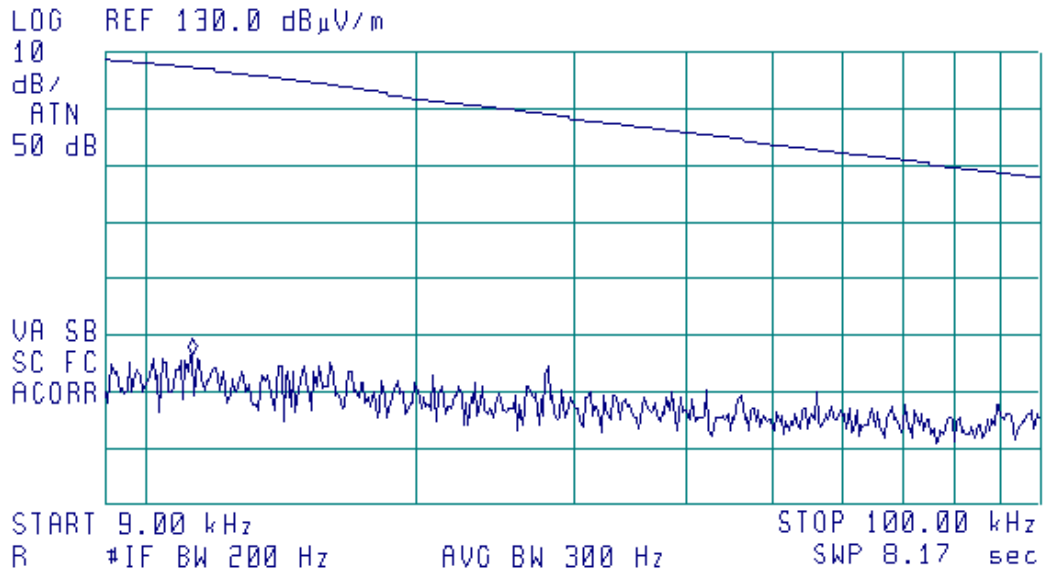


**Plot 4.8.1**

Test specification: §15.209(a)  
Radiated spurious emissions measurement in transmitting mode  
Carrier frequency 2403 MHz

14:40:35 SEP 20, 2001

ACTV DET: PEAK  
MEAS DET: PEAK QP AVG  
MKR 11.2B kHz  
76.53 dB $\mu$ V/m



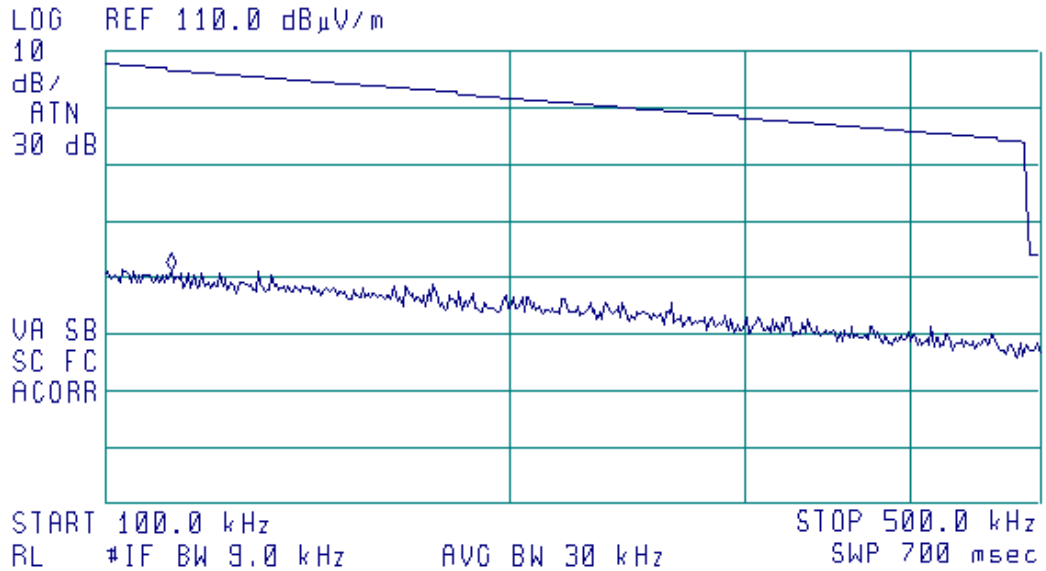


**Plot 4.8.2**

Test specification: §15.209(a)  
Radiated spurious emissions measurement in transmitting mode  
Carrier frequency 2403 MHz

14:36:50 SEP 20, 2001

ACTV DET: PEAK  
MEAS DET: PEAK OP AVG  
MKR 112.2 kHz  
71.25 dBμV/m



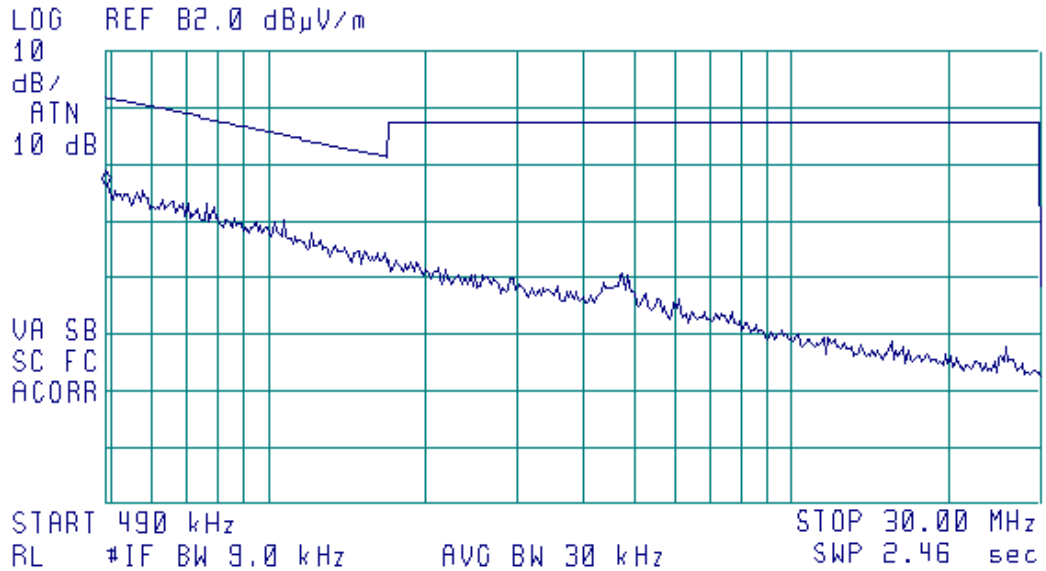


**Plot 4.8.3**

Test specification: §15.209(a)  
Radiated spurious emissions measurement in transmitting mode  
Carrier frequency 2403 MHz

14:33:58 SEP 20, 2001

ACTV DET: PEAK  
MEAS DET: PEAK OP AVG  
MKR 490 kHz  
58.09 dBµV/m



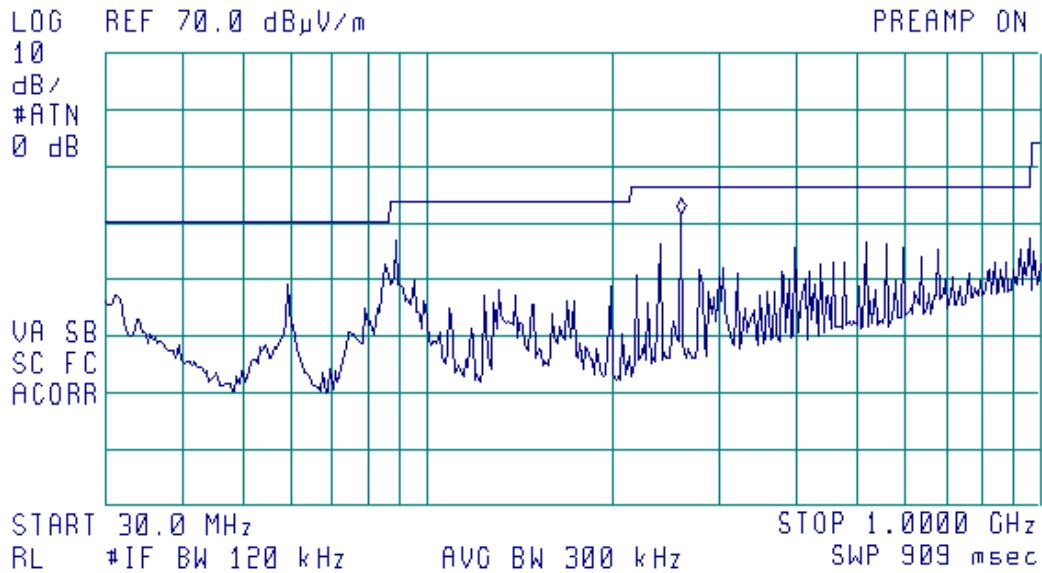


**Plot 4.8.4**

Test specification: §15.209(a)  
Radiated spurious emissions measurement in transmitting mode  
Carrier frequency 2403 MHz

14:17:14 SEP 20, 2001  
vertical polarization

ACTV DET: PEAK  
MEAS DET: PEAK OP AVG  
MKR 258.9 MHz  
41.57 dBµV/m



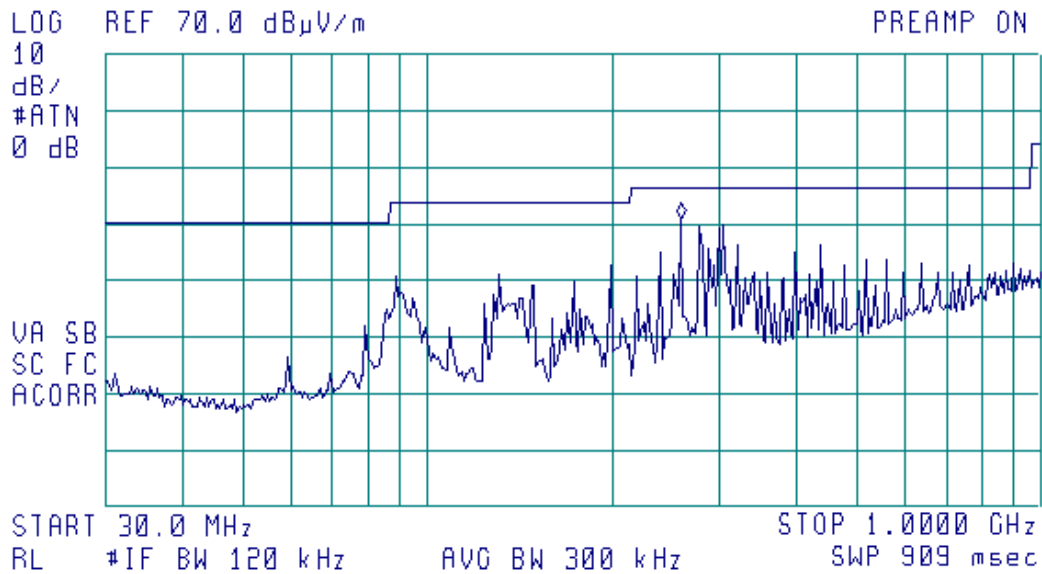


**Plot 4.8.5**

Test specification: §15.209(a)  
Radiated spurious emissions measurement in transmitting mode  
Carrier frequency 2403 MHz

14:13:01 SEP 20, 2001  
horizontal polarization

ACTV DET: PEAK  
MEAS DET: PEAK QP AVG  
MKR 258.9 MHz  
40.66 dBµV/m



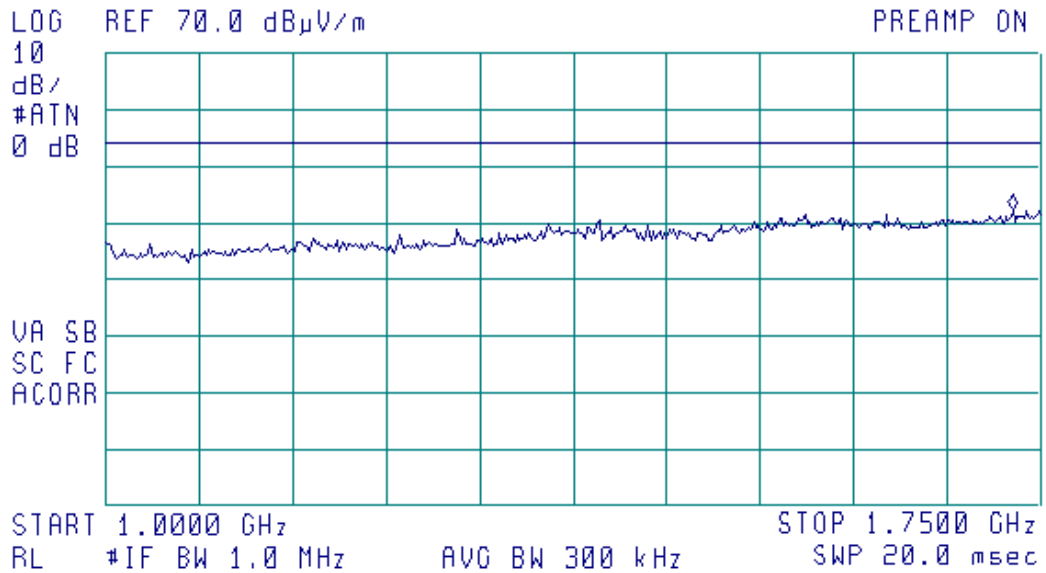


**Plot 4.8.6**

Test specification: §15.209(a)  
Radiated spurious emissions measurement in transmitting mode  
Carrier frequency 2403 MHz

14:25:02 SEP 20, 2001  
vertical+horizontal polarization

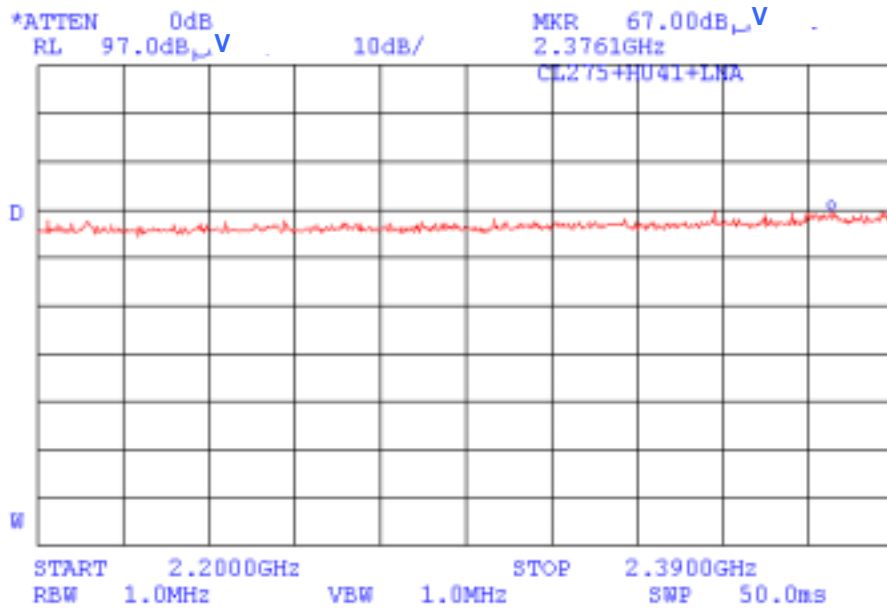
ACTV DET: PEAK  
MEAS DET: PEAK OP AVG  
MKR 1.7275 GHz  
42.32 dB $\mu$ V/m





**Plot 4.8.7**

Test specification: §15.209(a)  
Radiated spurious emissions measurement in transmitting mode  
Carrier frequency 2403 MHz

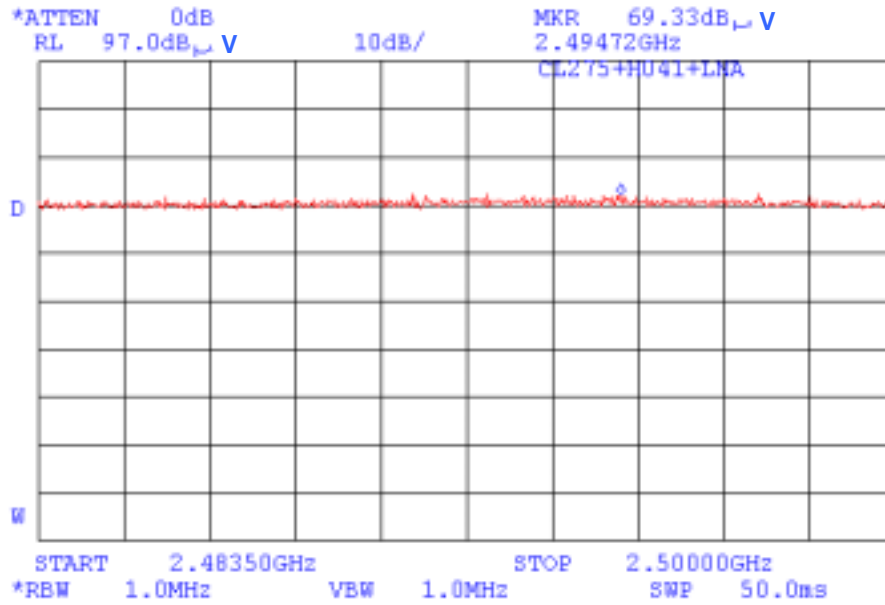


Maximum peak emissions level 67 dBuV/m-20 dB(AG)=47 dBuV/m  
Average limit =54 dBuV/m; peak limit=54 dBuV/m+20 dB=74 dBuV/m



**Plot 4.8.8**

Test specification: §15.209(a)  
Radiated spurious emissions measurement in transmitting mode  
Carrier frequency 2403 MHz



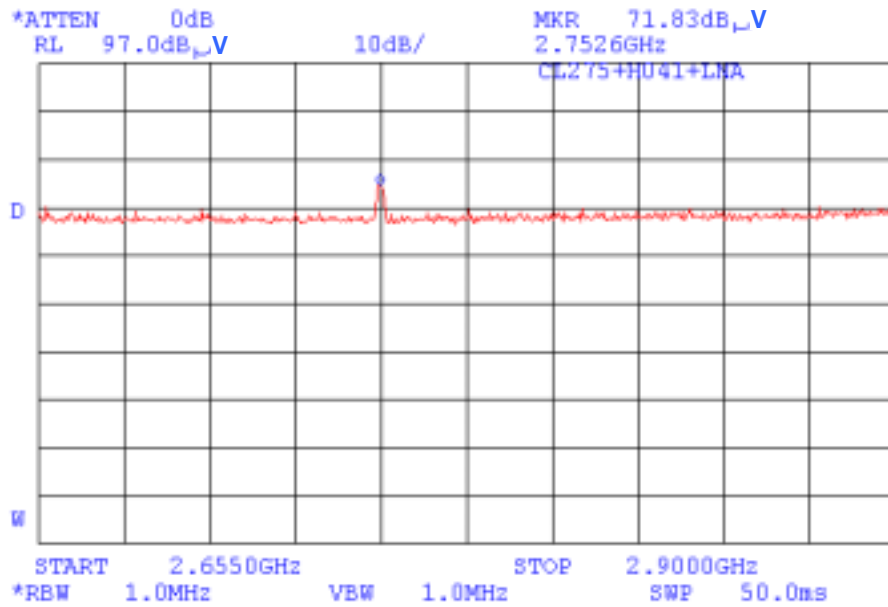
Maximum peak emissions level (noise)  $69.33 \text{ dBuV/m} - 20 \text{ dB(AG)} = 49.33 \text{ dBuV/m}$   
Average limit =  $54 \text{ dBuV/m}$ ; peak limit =  $54 \text{ dBuV/m} + 20 \text{ dB} = 74 \text{ dBuV/m}$





**Plot 4.8.9**

Test specification: §15.209(a)  
Radiated spurious emissions measurement in transmitting mode  
Carrier frequency 2403 MHz

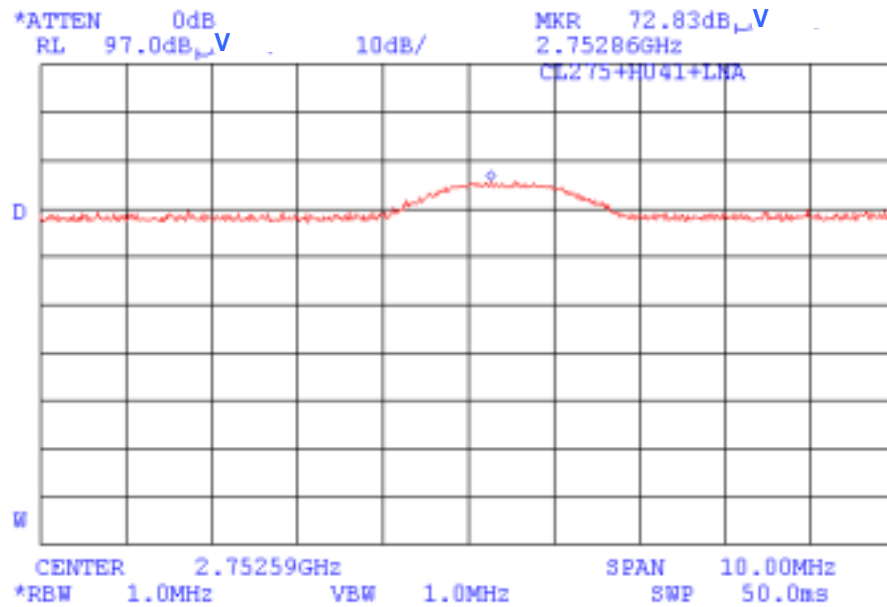


Maximum peak emissions level (noise)  $71.83 \text{ dBuV/m} - 20 \text{ dB(AG)} = 51.83 \text{ dBuV/m}$   
Average limit =  $54 \text{ dBuV/m}$ ; peak limit =  $54 \text{ dBuV/m} + 20 \text{ dB} = 74 \text{ dBuV/m}$



**Plot 4.8.10**

Test specification: §15.209(a)  
Radiated spurious emissions measurement in transmitting mode  
Carrier frequency 2403 MHz



f(Tx)+f(IF)

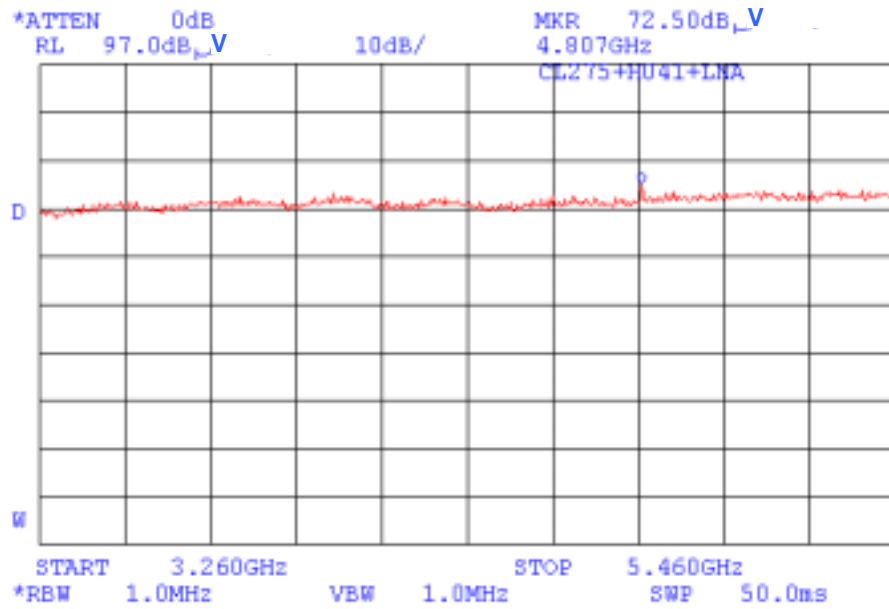
Maximum peak emissions level 72.83 dBuV/m-20 dB(AG)=52.83 dBuV/m

Average limit =54 dBuV/m; peak limit=54 dBuV/m+20 dB=74 dBuV/m



**Plot 4.8.11**

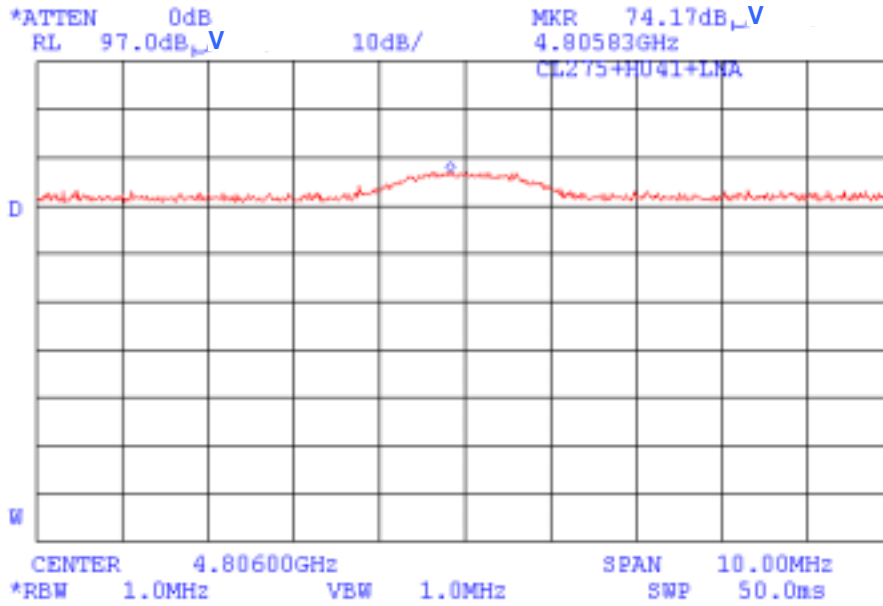
Test specification: §15.209(a)  
Radiated spurious emissions measurement in transmitting mode  
Carrier frequency 2403 MHz





**Plot 4.8.12**

Test specification: §15.209(a)  
Radiated spurious emissions measurement in transmitting mode  
Carrier frequency 2403 MHz



2<sup>nd</sup> harmonic of fundamental

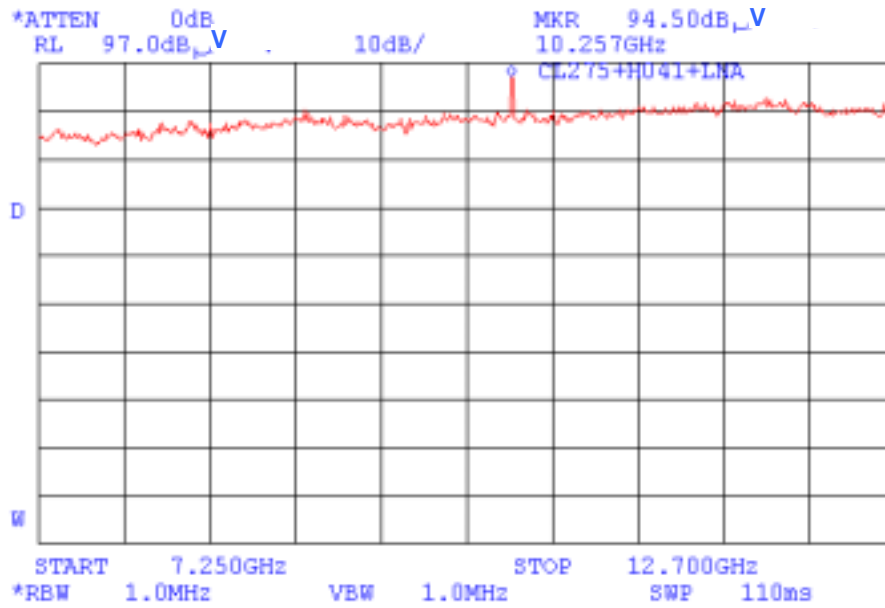
Maximum peak emissions level 74.17 dBuV/m-20 dB(AG)=54.17 dBuV/m

Average limit =54 dBuV/m; peak limit=54 dBuV/m+20 dB=74 dBuV/m



**Plot 4.8.13**

Test specification: §15.209(a)  
Radiated spurious emissions measurement in transmitting mode  
Carrier frequency 2403 MHz

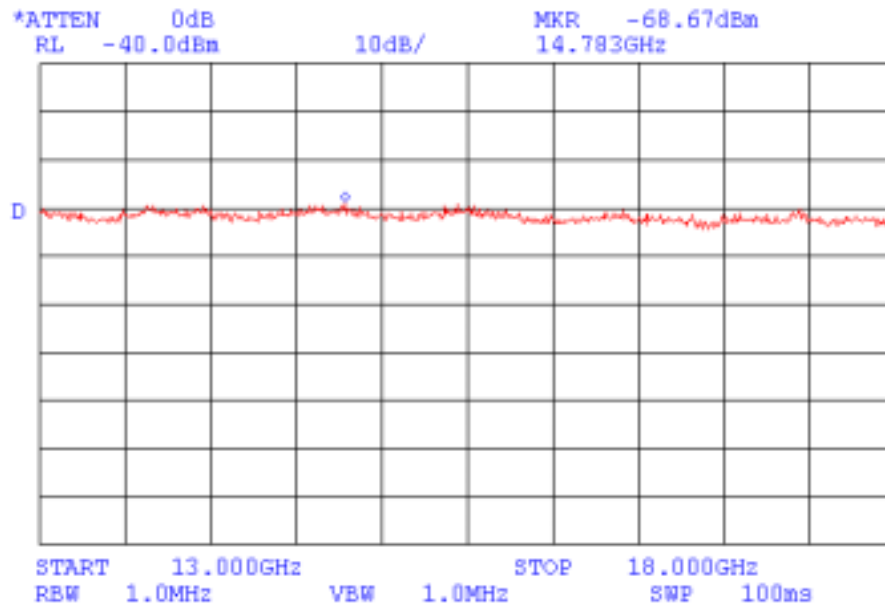


Fifth harmonics of LO-not restricted band



**Plot 4.8.14**

Test specification: §15.209(a)  
Radiated spurious emissions measurement in transmitting mode  
Carrier frequency 2403 MHz



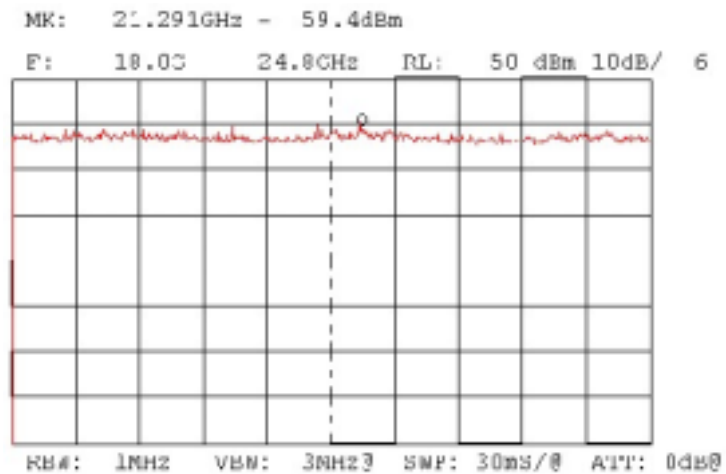
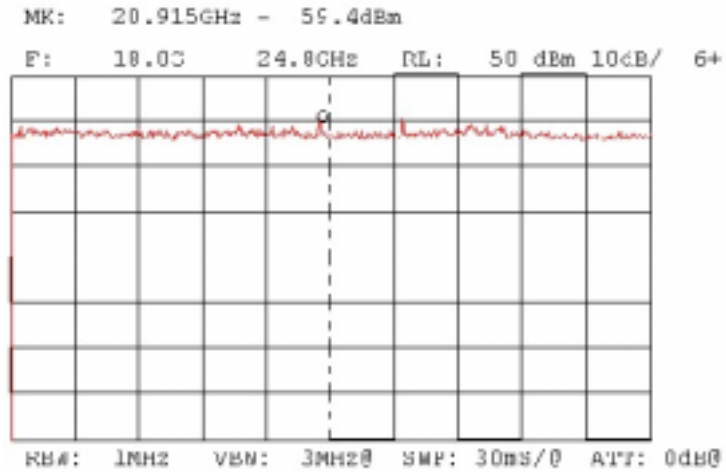
Test distance 1m.



**Plot 4.8.15**

Test specification: §15.209(a)  
Radiated spurious emissions measurement in transmitting mode  
Carrier frequency 2403 MHz

VERTICAL POLARIZATION

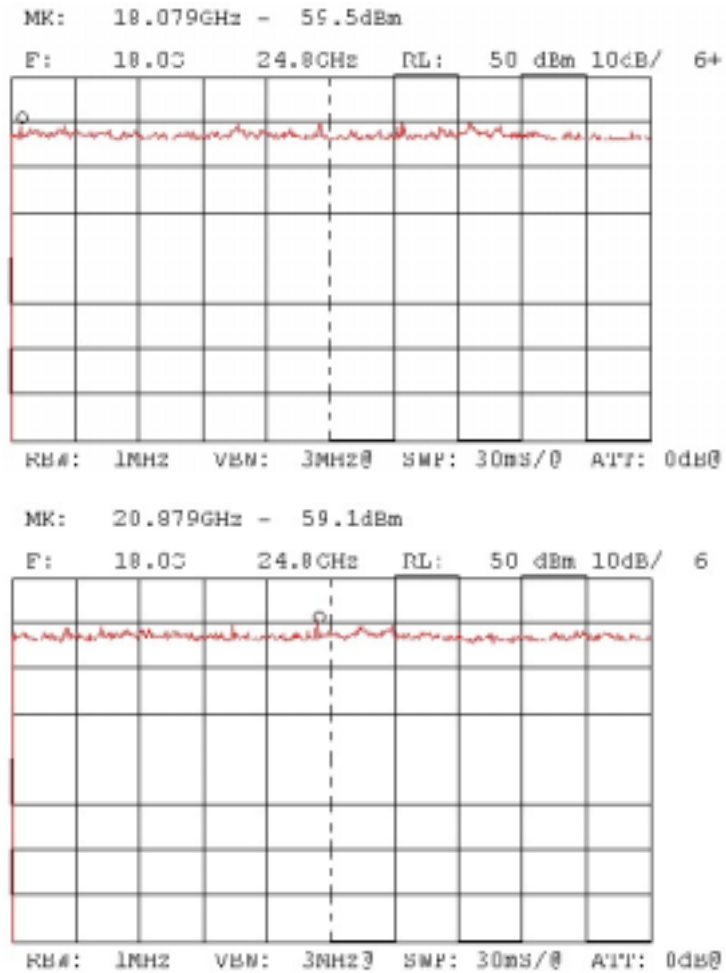




**Plot 4.8.16**

Test specification: §15.209(a)  
Radiated spurious emissions measurement in transmitting mode  
Carrier frequency 2403 MHz

**HORIZONTAL POLARIZATION**





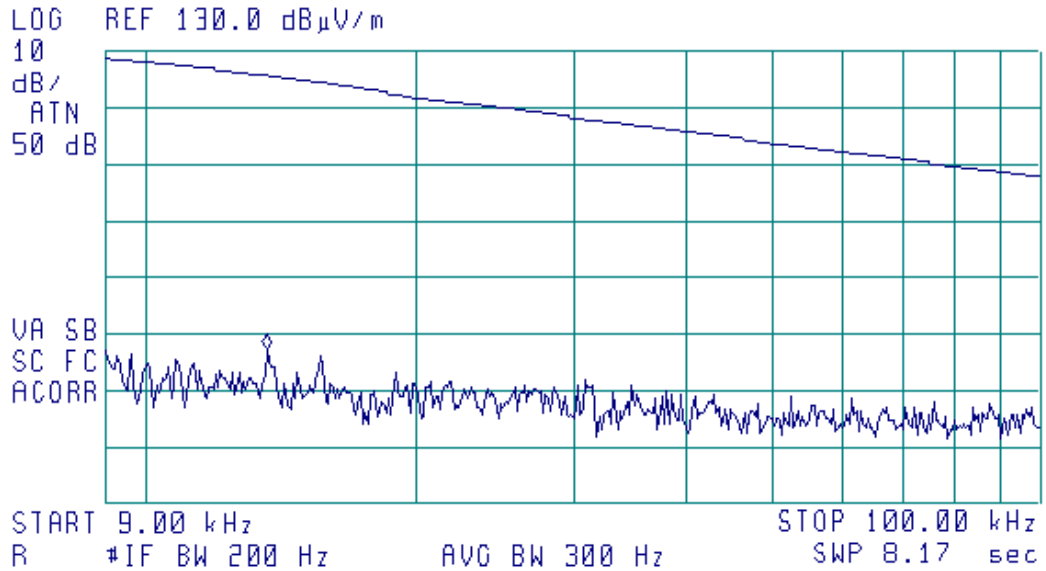


**Plot 4.8.17**

Test specification: §15.209  
Radiated spurious emissions measurement in transmitting mode  
Carrier frequency 2441 MHz

14:00:40 SEP 20, 2001

ACTV DET: PEAK  
MEAS DET: PEAK OP AVG  
MKR 13.60 kHz  
77.09 dBµV/m



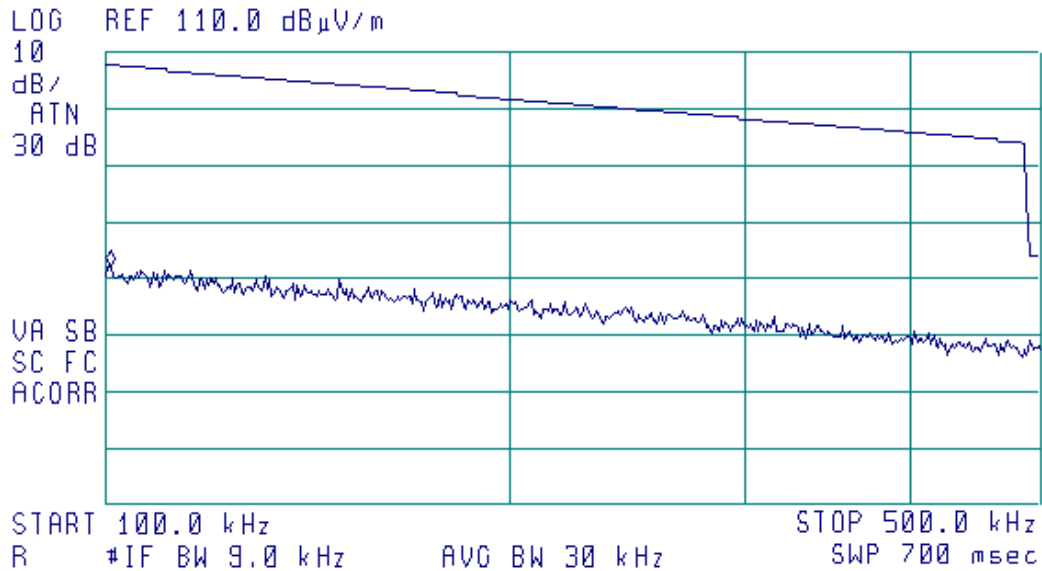


**Plot 4.8.18**

Test specification: §15.209  
Radiated spurious emissions measurement in transmitting mode  
Carrier frequency 2441 MHz

13:57:46 SEP 20, 2001

ACTV DET: PEAK  
MEAS DET: PEAK QP AVG  
MKR 100.9 kHz  
71.94 dBμV/m



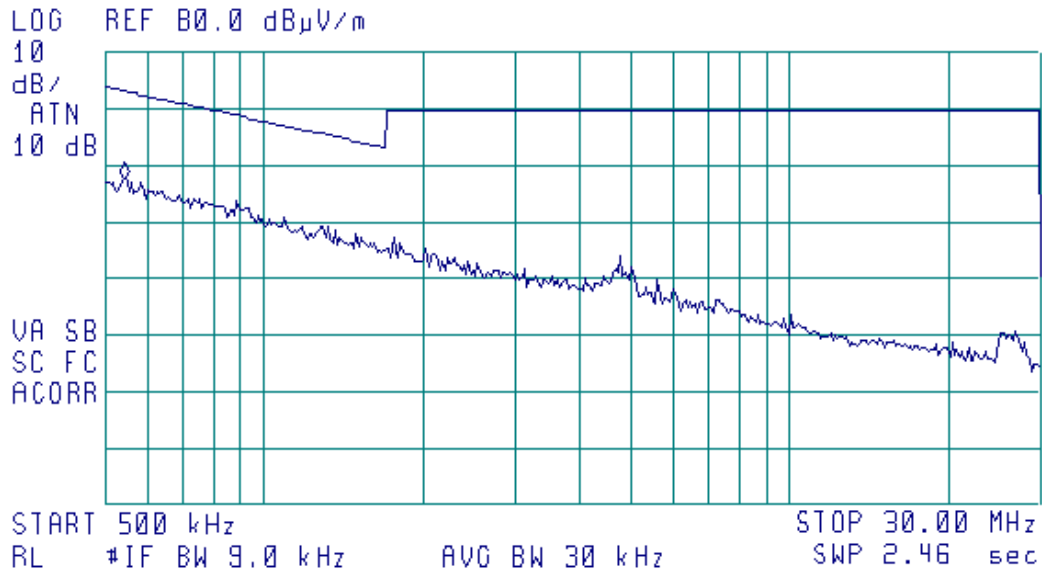


**Plot 4.8.19**

Test specification: §15.209  
Radiated spurious emissions measurement in transmitting mode  
Carrier frequency 2441 MHz

13:51:33 SEP 20, 2001

ACTV DET: PEAK  
MEAS DET: PEAK QP AVG  
MKR 550 kHz  
57.43 dB $\mu$ V/m



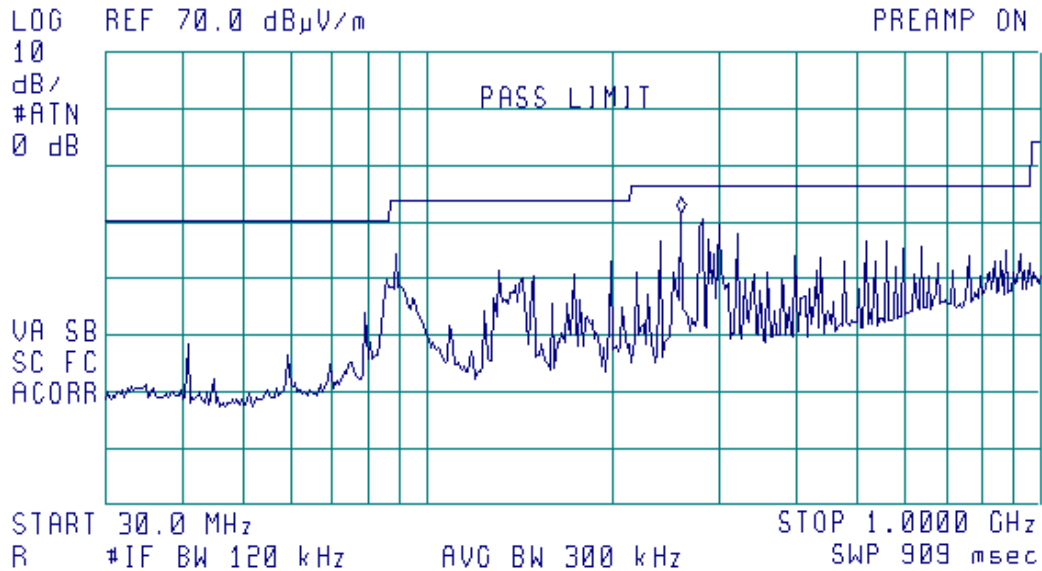


**Plot 4.8.20**

Test specification: §15.209  
Radiated spurious emissions measurement in transmitting mode  
Carrier frequency 2441 MHz

11:23:20 SEP 20, 2001  
horizontal polarization

ACTV DET: PEAK  
MEAS DET: PEAK QP AVG  
MKR 258.9 MHz  
41.45 dB $\mu$ V/m



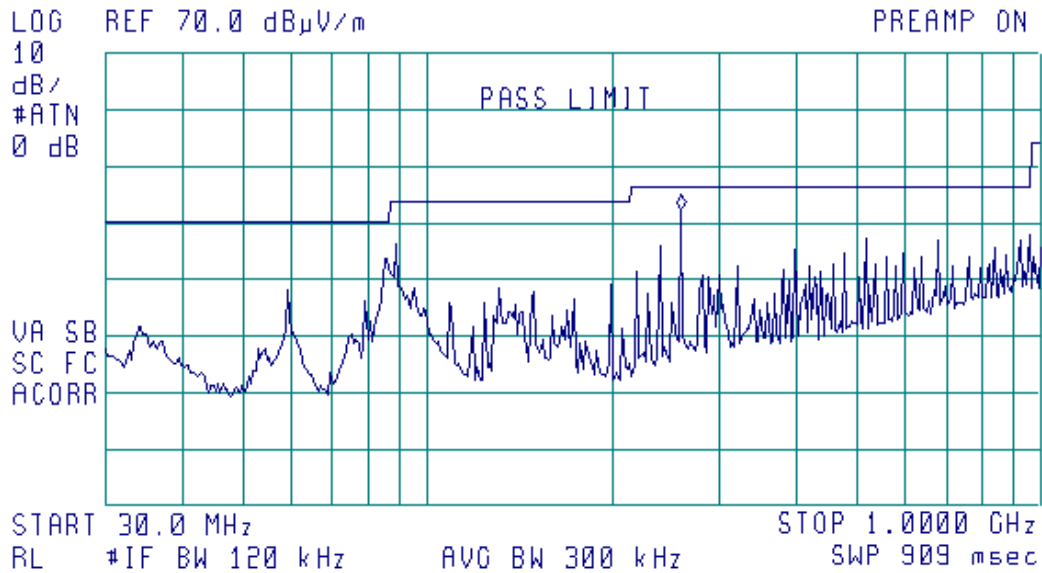


**Plot 4.8.21**

Test specification: §15.209  
Radiated spurious emissions measurement in transmitting mode  
Carrier frequency 2441 MHz

11:18:56 SEP 20, 2001  
vertical polarization

ACTV DET: PEAK  
MEAS DET: PEAK QP AVG  
MKR 258.9 MHz  
42.27 dB $\mu$ V/m





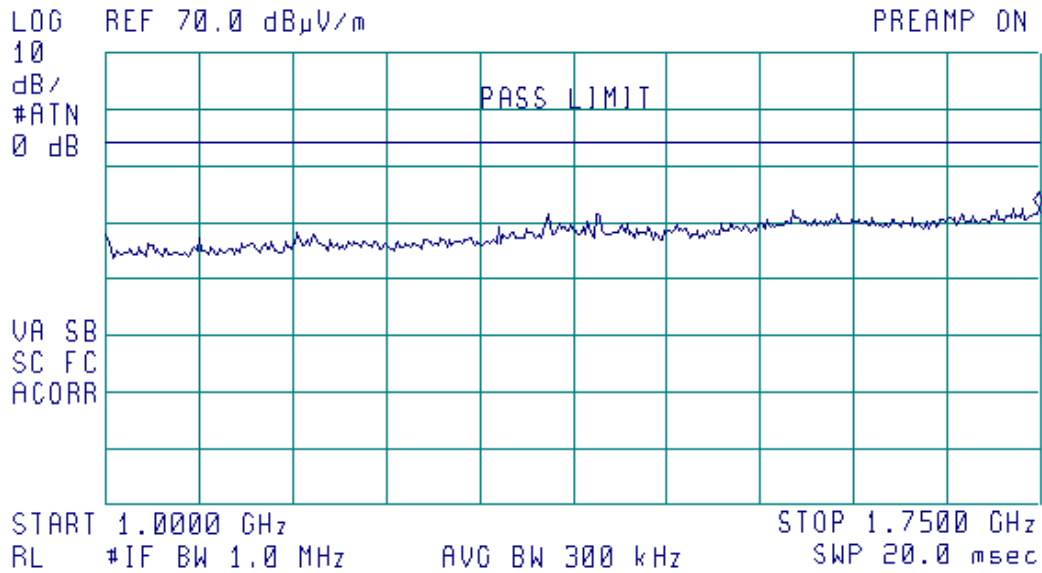
**Plot 4.8.22**

Test specification: §15.209  
Radiated spurious emissions measurement in transmitting mode  
Carrier frequency 2441 MHz

12:28:13 SEP 20, 2001

vertical+horizontal polarization

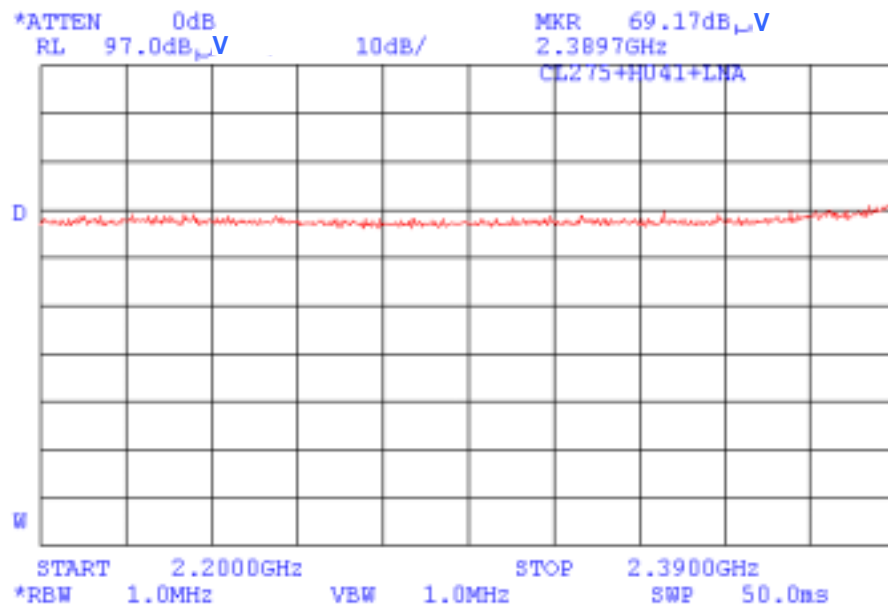
ACTV DET: PEAK  
MEAS DET: PEAK OP AVG  
MKR 1.7481 GHz  
42.53 dB $\mu$ V/m





**Plot 4.8.23**

Test specification: §15.209  
Radiated spurious emissions measurement in transmitting mode  
Carrier frequency 2441 MHz

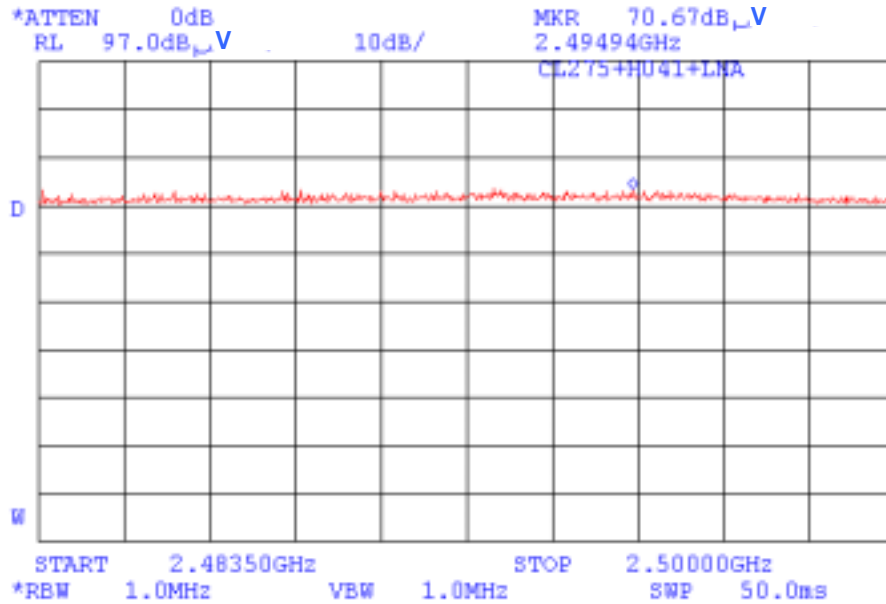


Maximum peak emissions level (noise) 69.17 dBuV/m-20 dB(AG)=49.17 dBuV/m  
Average limit =54 dBuV/m; peak limit=54 dBuV/m+20 dB=74 dBuV/m



**Plot 4.8.24**

Test specification: §15.209  
Radiated spurious emissions measurement in transmitting mode  
Carrier frequency 2441 MHz



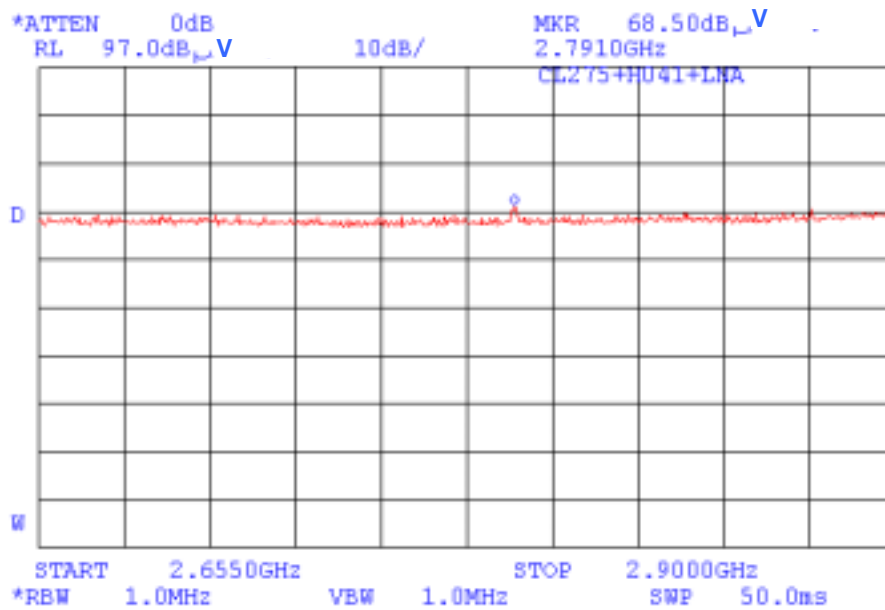
Maximum peak emissions level (noise) 70.67 dBuV/m-20 dB(AG)=50.67 dBuV/m  
Average limit =54 dBuV/m; peak limit=54 dBuV/m+20 dB=74 dBuV/m





**Plot 4.8.25**

Test specification: §15.209  
Radiated spurious emissions measurement in transmitting mode  
Carrier frequency 2441 MHz

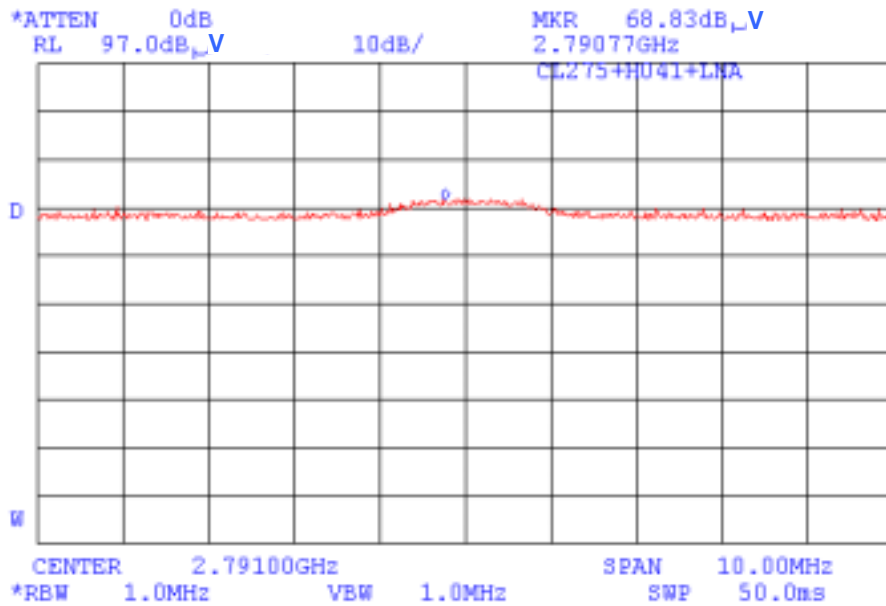


Maximum peak emissions level (noise) 68.5 dBuV/m-20 dB(AG)=48.5 dBuV/m  
Average limit =54 dBuV/m; peak limit=54 dBuV/m+20 dB=74 dBuV/m



**Plot 4.8.26**

Test specification: §15.209  
Radiated spurious emissions measurement in transmitting mode  
Carrier frequency 2441 MHz



f(Tx)+f(IF)

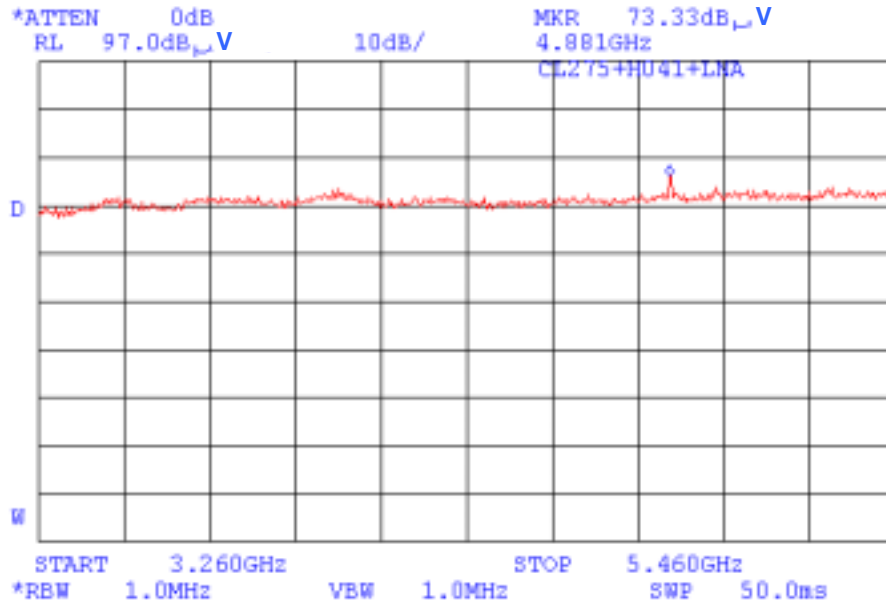
Maximum peak emissions level (noise) 68.83 dBuV/m-20 dB(AG)=48.83 dBuV/m

Average limit =54 dBuV/m; peak limit=54 dBuV/m+20 dB=74 dBuV/m



**Plot 4.8.27**

Test specification: §15.209  
Radiated spurious emissions measurement in transmitting mode  
Carrier frequency 2441 MHz

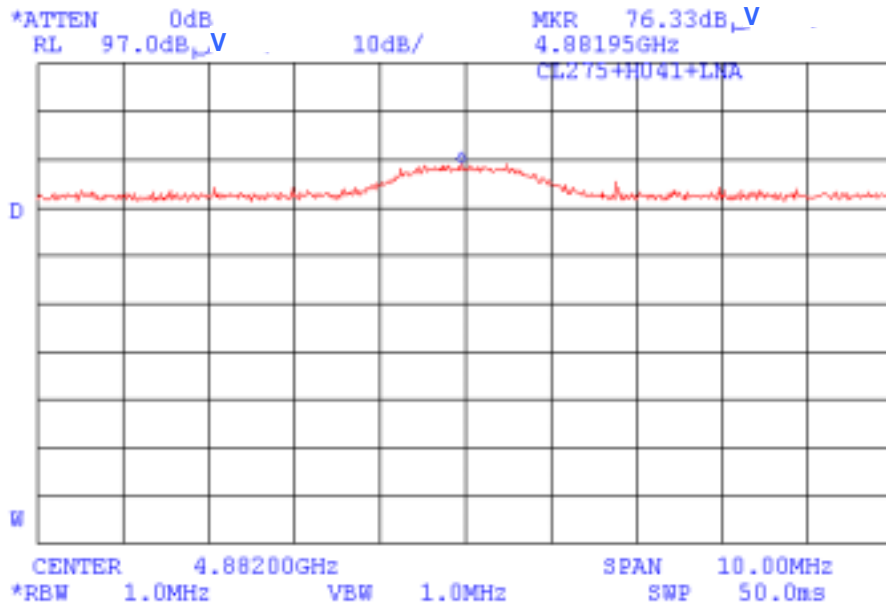


Maximum peak emissions level (noise)  $73.33 \text{ dB}\mu\text{V}/\text{m} - 20 \text{ dB(AG)} = 53.33 \text{ dB}\mu\text{V}/\text{m}$   
Average limit =  $54 \text{ dB}\mu\text{V}/\text{m}$ ; peak limit =  $54 \text{ dB}\mu\text{V}/\text{m} + 20 \text{ dB} = 74 \text{ dB}\mu\text{V}/\text{m}$



**Plot 4.8.28**

Test specification: §15.209  
Radiated spurious emissions measurement in transmitting mode  
Carrier frequency 2441 MHz

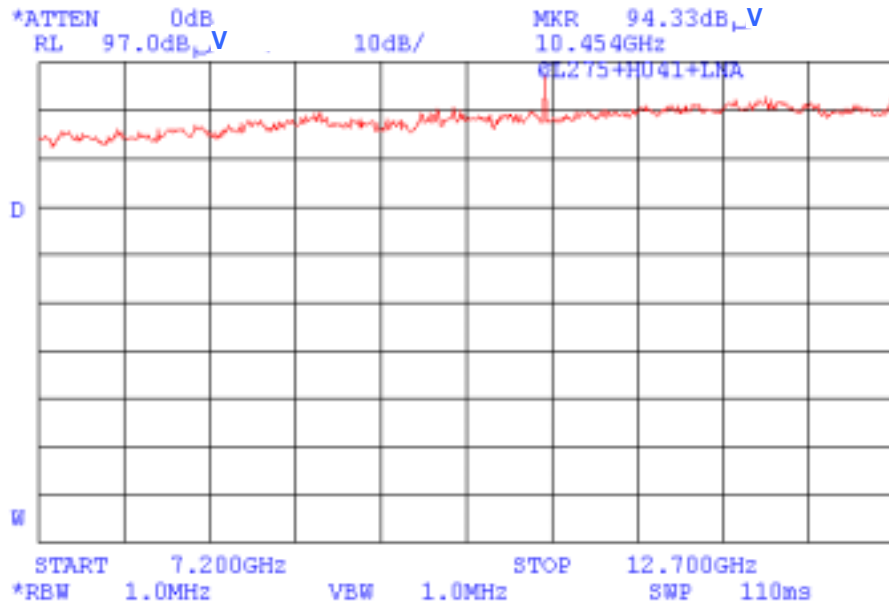


2<sup>nd</sup> harmonic of fundamental frequency  
Maximum peak emissions level 76.33 dB $\mu$ V/m-20 dB(AG)=56.33 dB $\mu$ V/m  
Average limit =54 dB $\mu$ V/m; peak limit=54 dB $\mu$ V/m+20 dB=74 dB $\mu$ V/m



**Plot 4.8.29**

Test specification: §15.209  
Radiated spurious emissions measurement in transmitting mode  
Carrier frequency 2441 MHz

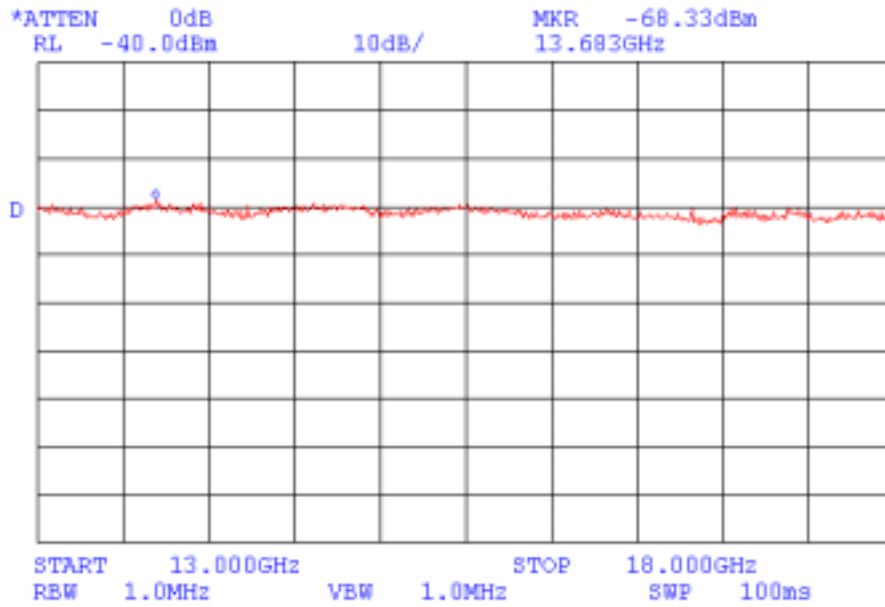


Fifth harmonics of LO-not restricted band



**Plot 4.8.30**

Test specification: §15.209  
Radiated spurious emissions measurement in transmitting mode  
Carrier frequency 2441 MHz



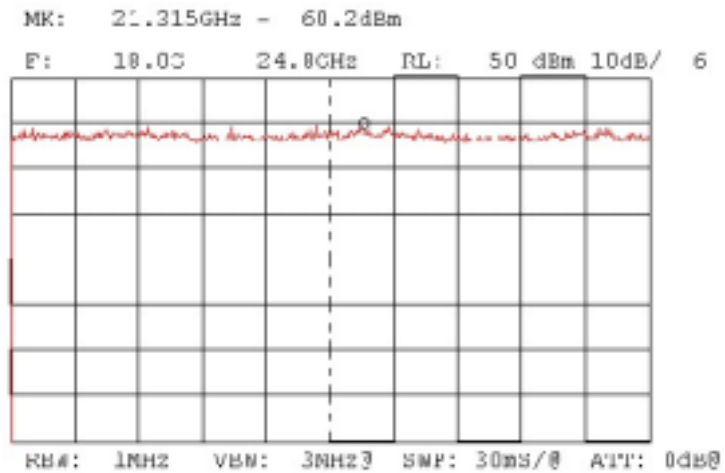
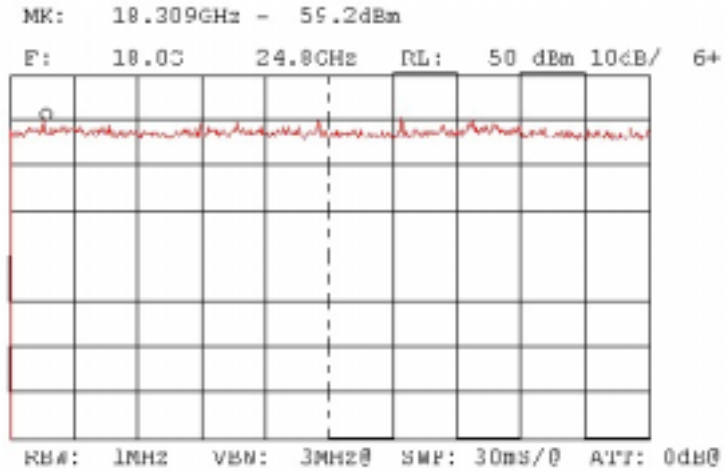
Test distance 1m



**Plot 4.8.31**

Test specification: §15.209  
Radiated spurious emissions measurement in transmitting mode  
Carrier frequency 2441 MHz

VERTICAL POLARIZATION

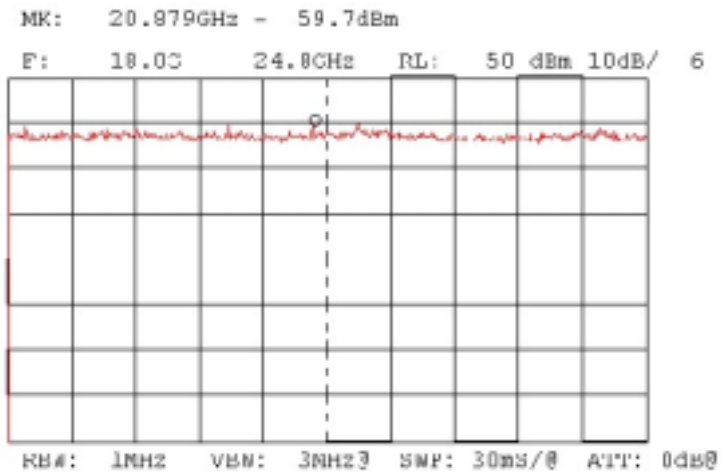
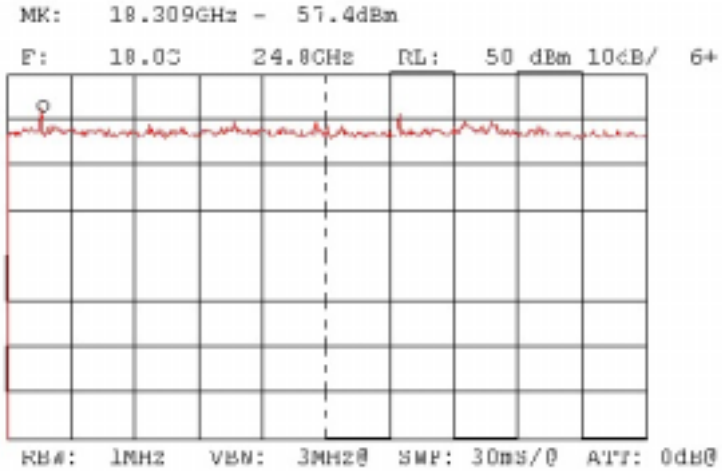




**Plot 4.8.32**

Test specification: §15.209  
Radiated spurious emissions measurement in transmitting mode  
Carrier frequency 2441 MHz

HORIZONTAL POLARIZATION





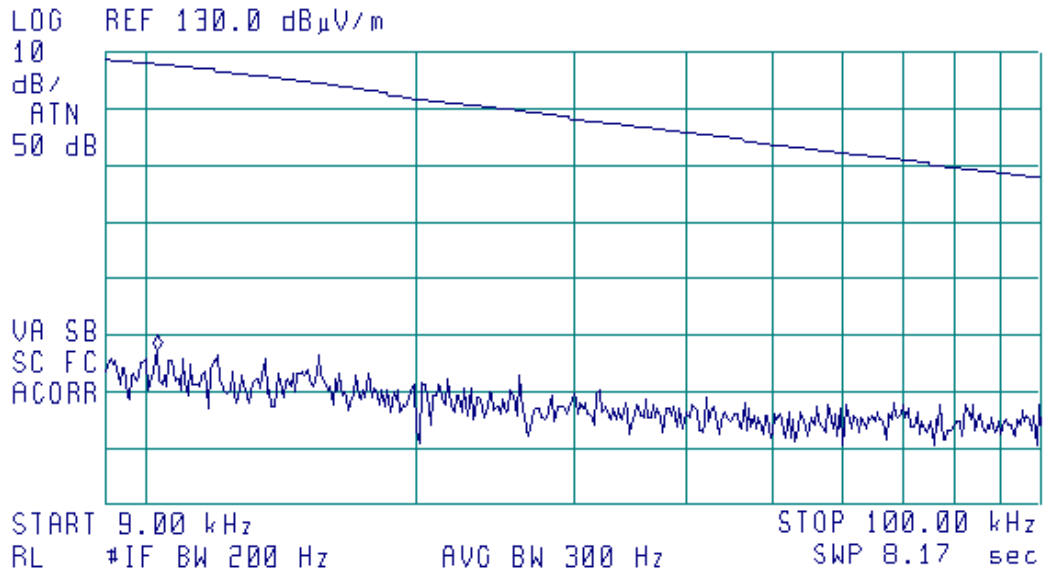


**Plot 4.8.33**

Test specification: §15.209  
Radiated spurious emissions measurement in transmitting mode  
Carrier frequency 2477 MHz

15:55:12 SEP 20, 2001

ACTV DET: PEAK  
MEAS DET: PEAK OP AVG  
MKR 10.33 kHz  
77.15 dBμV/m



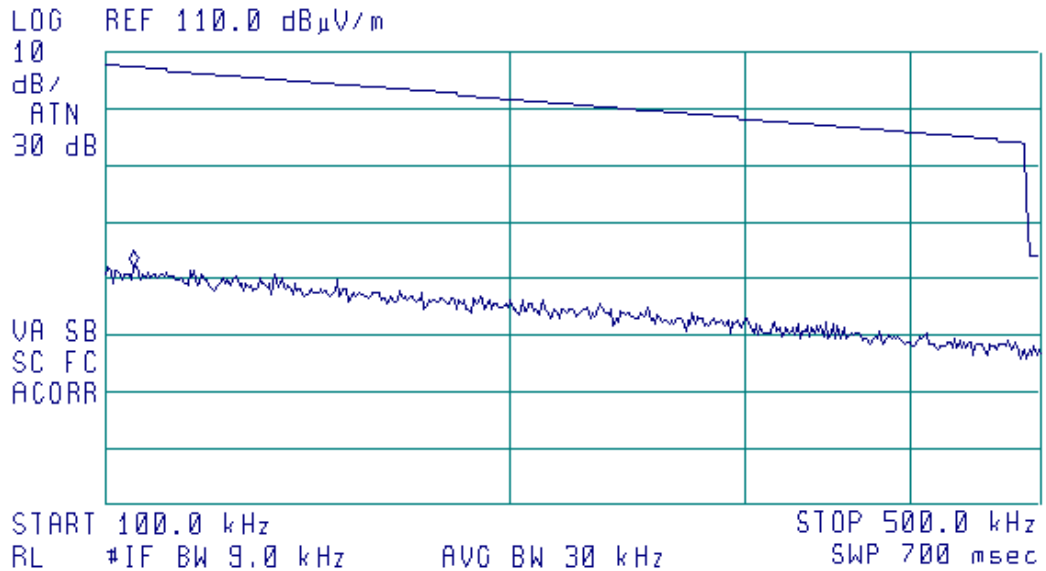


**Plot 4.8.34**

Test specification: §15.209  
Radiated spurious emissions measurement in transmitting mode  
Carrier frequency 2477 MHz

15:49:01 SEP 20, 2001

ACTV DET: PEAK  
MEAS DET: PEAK QP AVG  
MKR 105.2 kHz  
71.97 dBμV/m



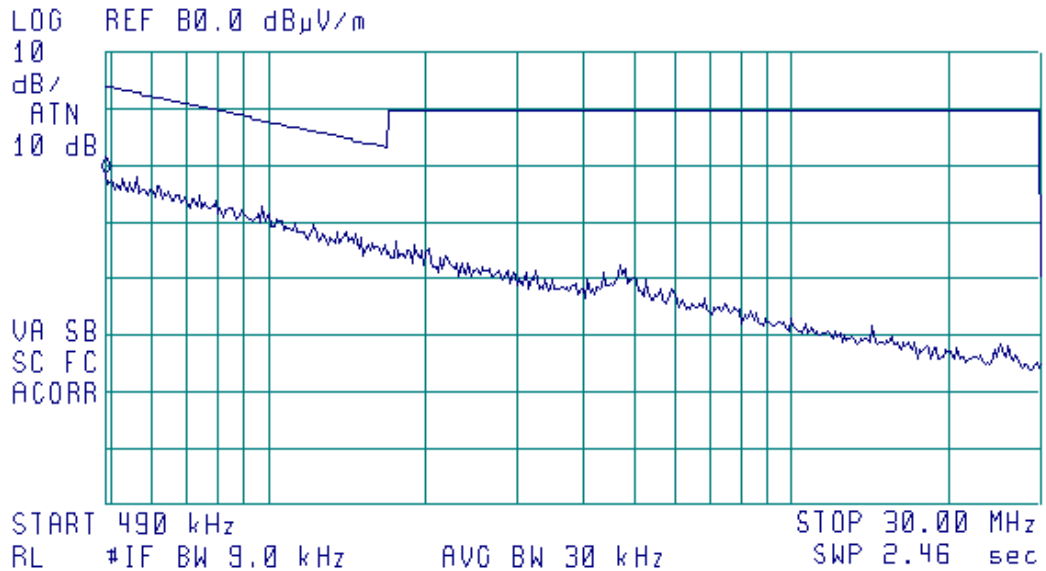


**Plot 4.8.35**

Test specification: §15.209  
Radiated spurious emissions measurement in transmitting mode  
Carrier frequency 2477 MHz

15:46:05 SEP 20, 2001

ACTV DET: PEAK  
MEAS DET: PEAK OP AVG  
MKR 490 kHz  
58.49 dB $\mu$ V/m



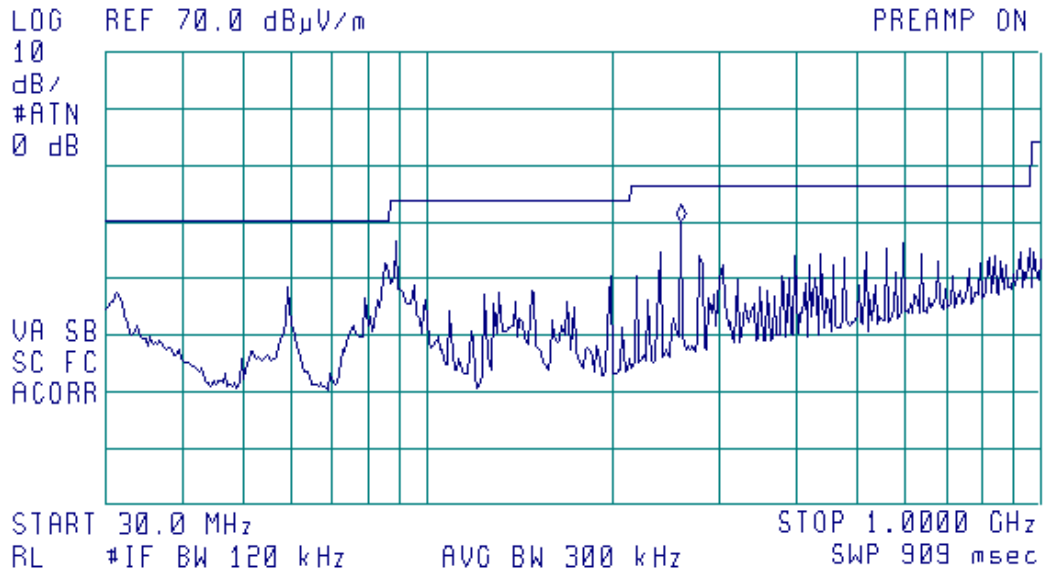


**Plot 4.8.36**

Test specification: §15.209  
Radiated spurious emissions measurement in transmitting mode  
Carrier frequency 2477 MHz

15:23:00 SEP 20, 2001  
vertical polarization

ACTV DET: PEAK  
MEAS DET: PEAK QP AVG  
MKR 258.9 MHz  
40.07 dBμV/m



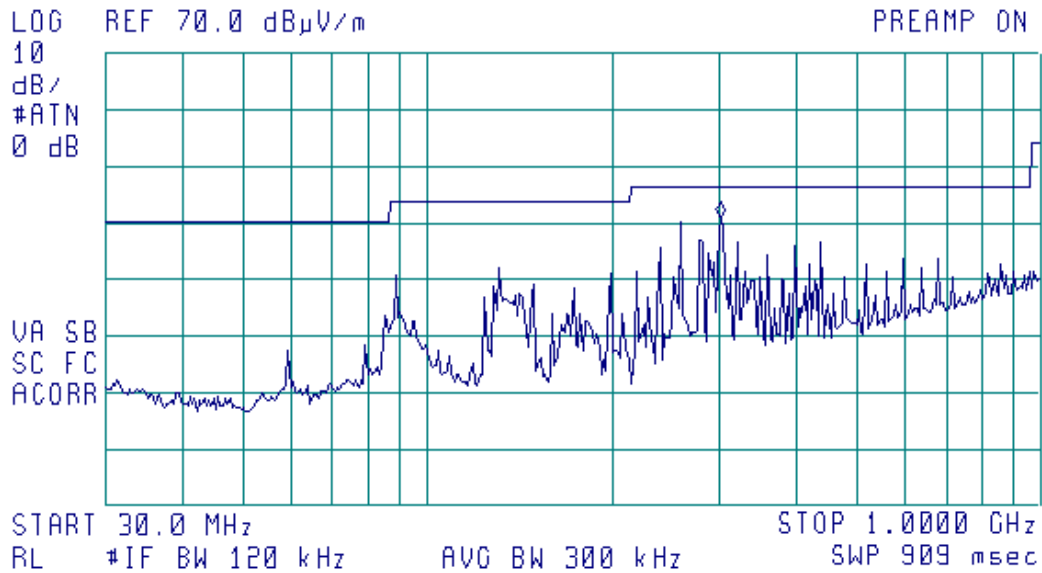


**Plot 4.8.37**

Test specification: §15.209  
Radiated spurious emissions measurement in transmitting mode  
Carrier frequency 2477 MHz

14:58:39 SEP 20, 2001  
horizontal polarization

ACTV DET: PEAK  
MEAS DET: PEAK QP AVG  
MKR 300.5 MHz  
40.83 dBµV/m



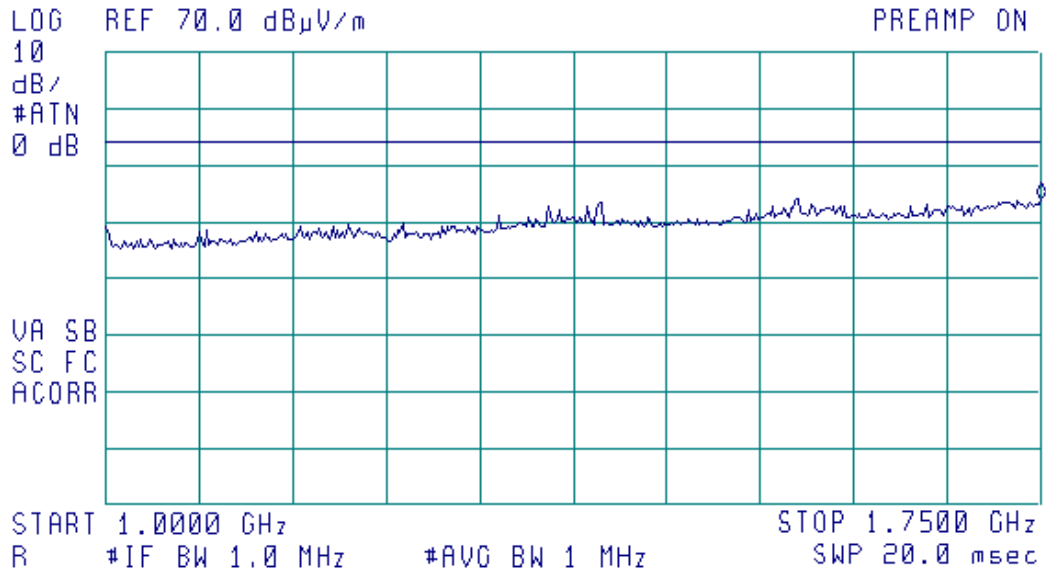


**Plot 4.8.38**

Test specification: §15.209  
Radiated spurious emissions measurement in transmitting mode  
Carrier frequency 2477 MHz

15:34:14 SEP 20, 2001  
vertical+horizontal polarization

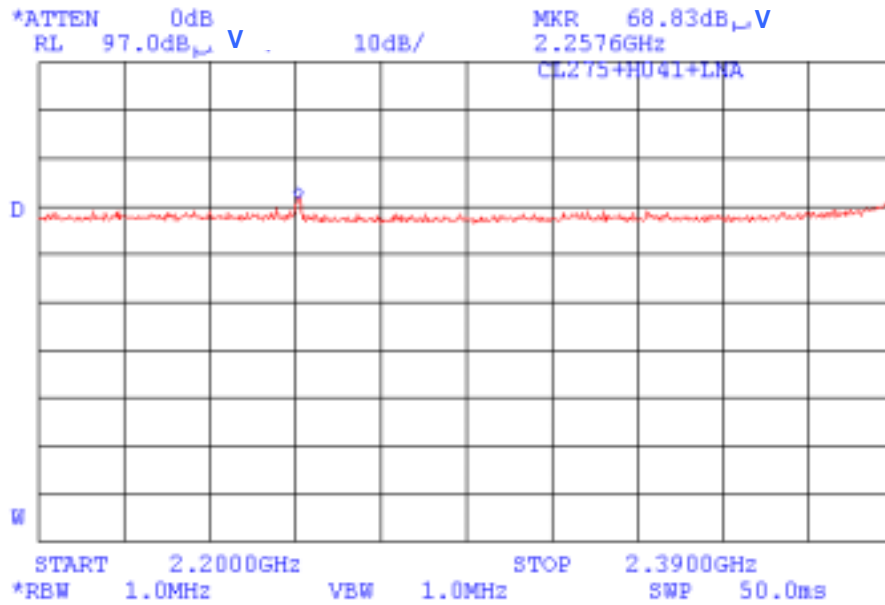
ACTV DET: PEAK  
MEAS DET: PEAK QP AVG  
MKR 1.7500 GHz  
43.99 dB $\mu$ V/m





**Plot 4.8.39**

Test specification: §15.209  
Radiated spurious emissions measurement in transmitting mode  
Carrier frequency 2477 MHz



Ambient noise

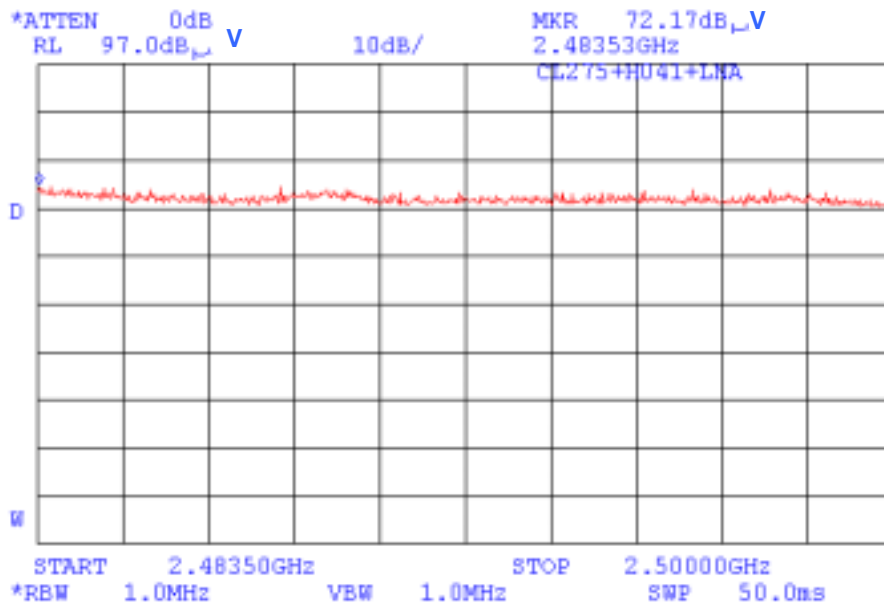
Maximum peak emissions level 68.83 dBuV/m-20 dB(AG)=48.83 dBuV/m

Average limit =54 dBuV/m; peak limit=54 dBuV/m+20 dB=74 dBuV/m



**Plot 4.8.40**

Test specification: §15.209  
Radiated spurious emissions measurement in transmitting mode  
Carrier frequency 2477 MHz



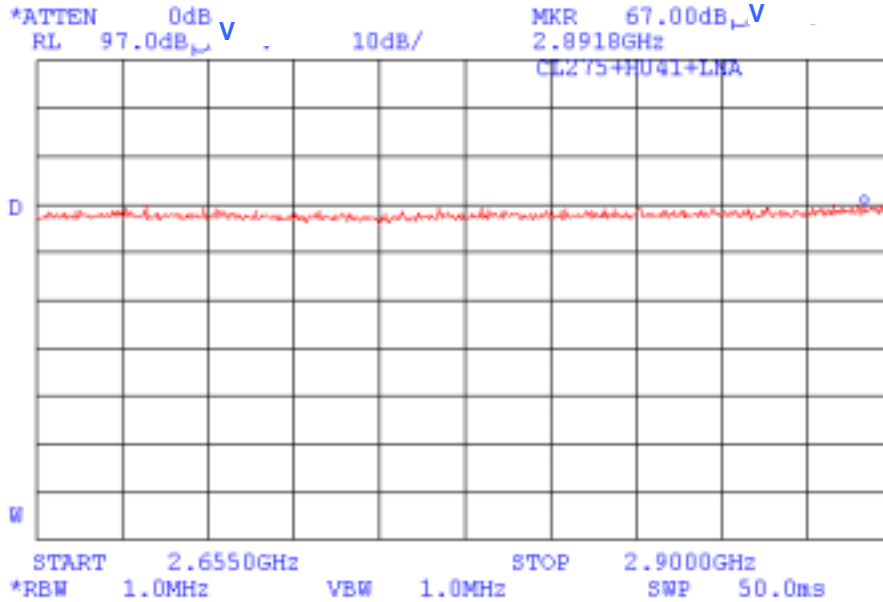
Maximum peak emissions level (noise)  $72.17 \text{ dBuV/m} - 20 \text{ dB(AG)} = 52.17 \text{ dBuV/m}$   
Average limit =  $54 \text{ dBuV/m}$ ; peak limit =  $54 \text{ dBuV/m} + 20 \text{ dB} = 74 \text{ dBuV/m}$





**Plot 4.8.41**

Test specification: §15.209  
Radiated spurious emissions measurement in transmitting mode  
Carrier frequency 2477 MHz

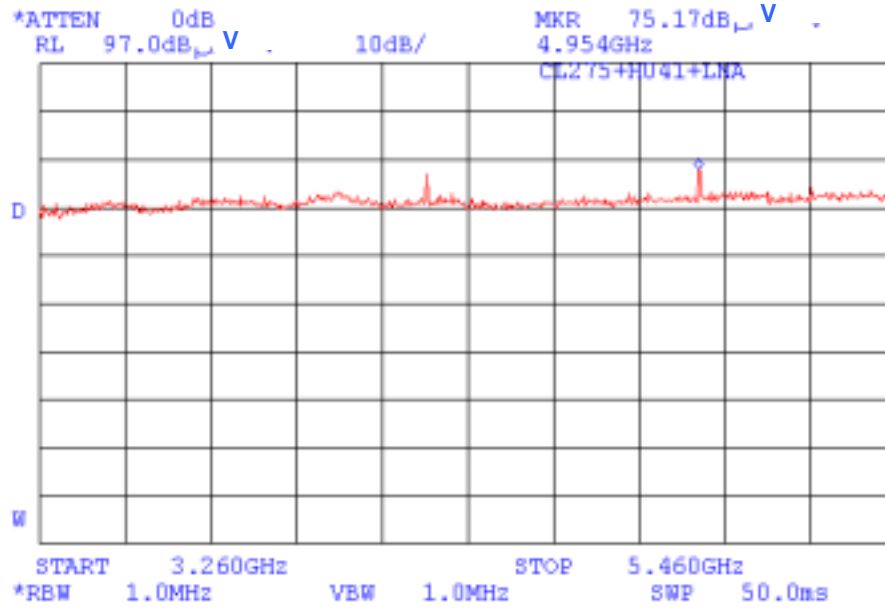


Maximum peak emissions level (noise)  $67 \text{ dBuV/m} - 20 \text{ dB(AG)} = 47 \text{ dBuV/m}$   
Average limit =  $54 \text{ dBuV/m}$ ; peak limit =  $54 \text{ dBuV/m} + 20 \text{ dB} = 74 \text{ dBuV/m}$



**Plot 4.8.42**

Test specification: §15.209  
Radiated spurious emissions measurement in transmitting mode  
Carrier frequency 2477 MHz

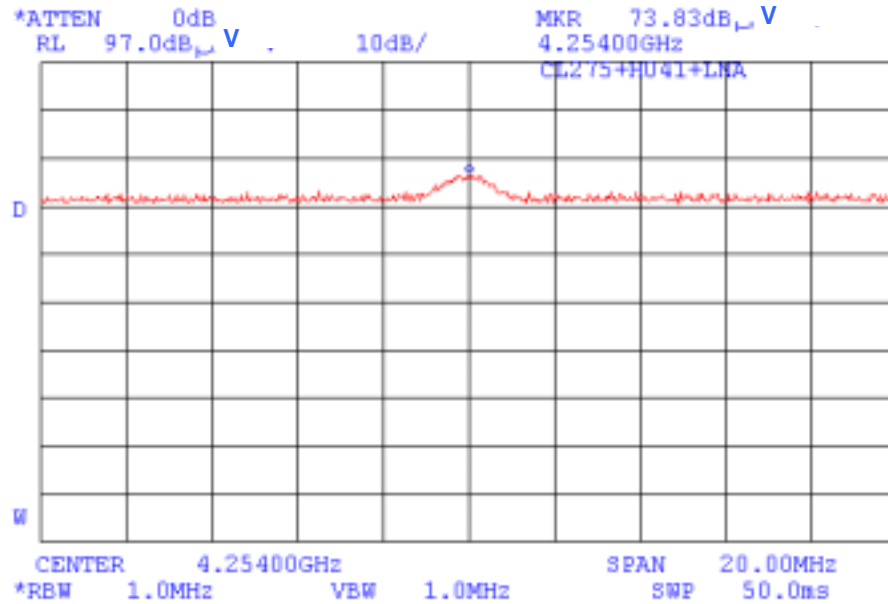


Maximum peak emissions level (noise) 75.17 dBuV/m-20 dB(AG)=55.17 dBuV/m  
Average limit =54 dBuV/m; peak limit=54 dBuV/m+20 dB=74 dBuV/m



**Plot 4.8.43**

Test specification: §15.209  
Radiated spurious emissions measurement in transmitting mode  
Carrier frequency 2477 MHz



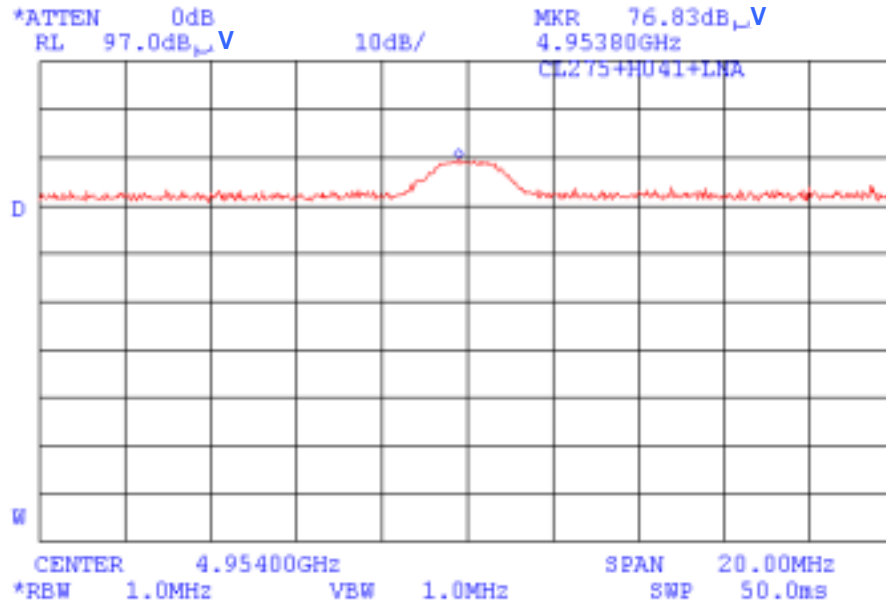
2<sup>nd</sup> harmonic of LO

Maximum peak emissions level (noise) 73.83 dBuV/m-20 dB(AG)=53.83 dBuV/m  
Average limit =54 dBuV/m; peak limit=54 dBuV/m+20 dB=74 dBuV/m



**Plot 4.8.44**

Test specification: §15.209  
Radiated spurious emissions measurement in transmitting mode  
Carrier frequency 2477 MHz

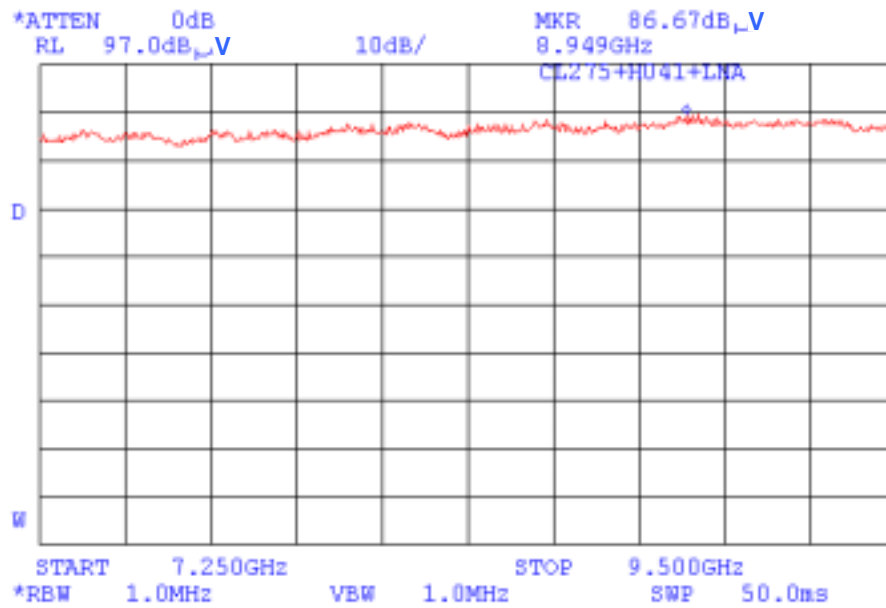


Second harmonic of fundamental  
Maximum peak emissions level 76.83 dBuV/m-20 dB(AG)=56.83 dBuV/m  
Average limit =54 dBuV/m; peak limit=54 dBuV/m+20 dB=74 dBuV/m



**Plot 4.8.45**

Test specification: §15.209  
Radiated spurious emissions measurement in transmitting mode  
Carrier frequency 2477 MHz

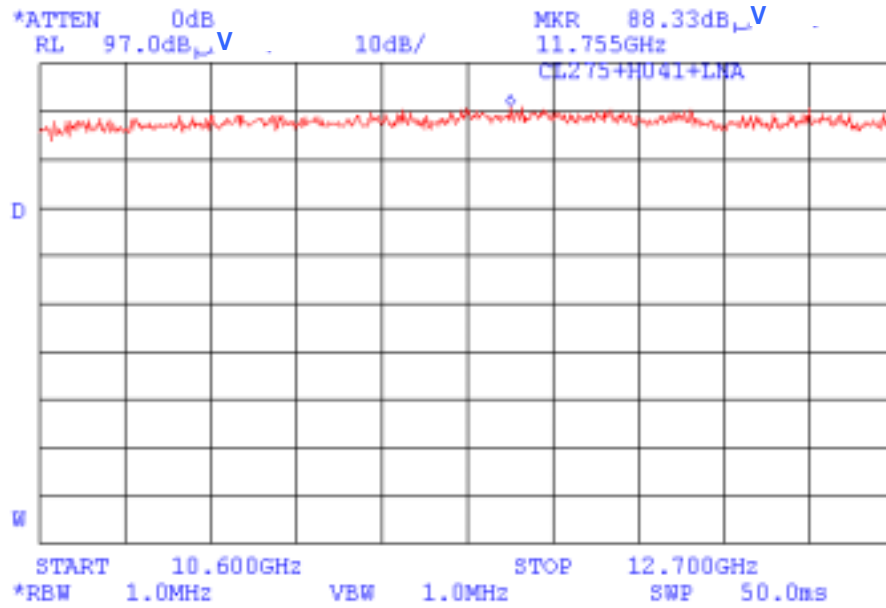


Maximum peak emissions level (noise) 86.67 dBuV/m-35 dB(AG)=51.67 dBuV/m  
Average limit =54 dBuV/m; peak limit=54 dBuV/m+20 dB=74 dBuV/m



**Plot 4.8.46**

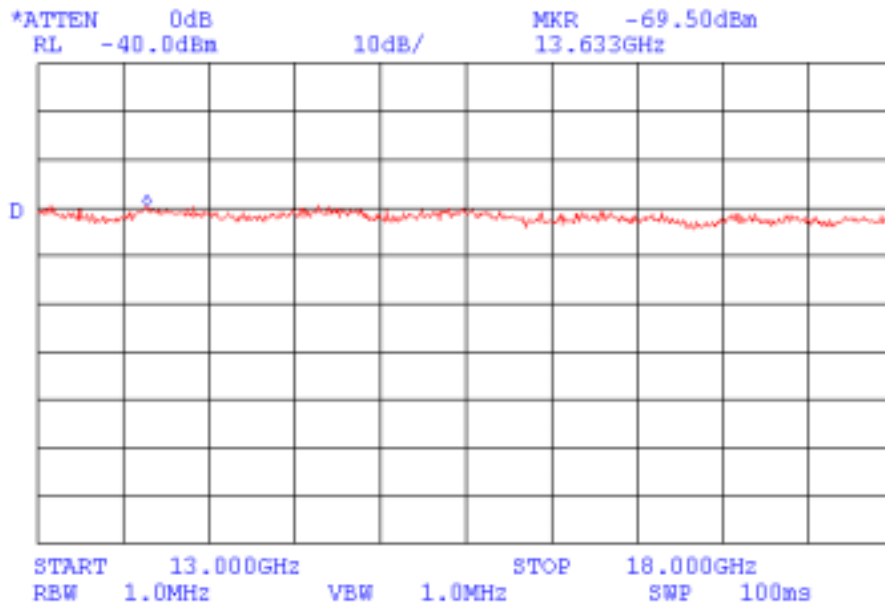
Test specification: §15.209  
Radiated spurious emissions measurement in transmitting mode  
Carrier frequency 2477 MHz





**Plot 4.8.47**

Test specification: §15.209  
Radiated spurious emissions measurement in transmitting mode  
Carrier frequency 2477 MHz



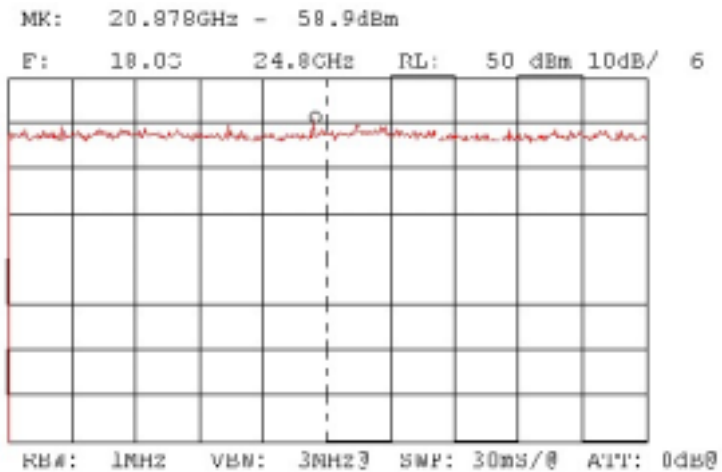
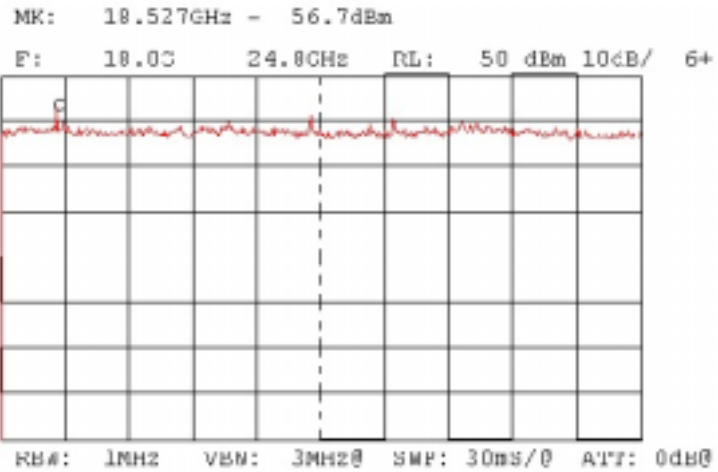
Test distance 1m



**Plot 4.8.48**

Test specification: §15.209  
Radiated spurious emissions measurement in transmitting mode  
Carrier frequency 2477 MHz

HORIZONTAL POLARIZATION



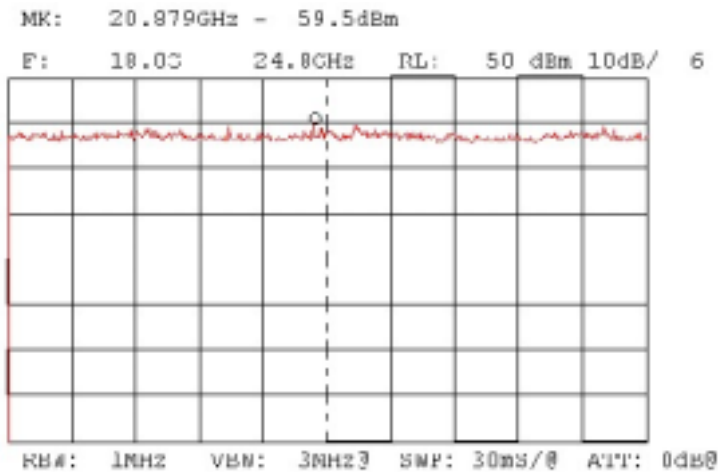
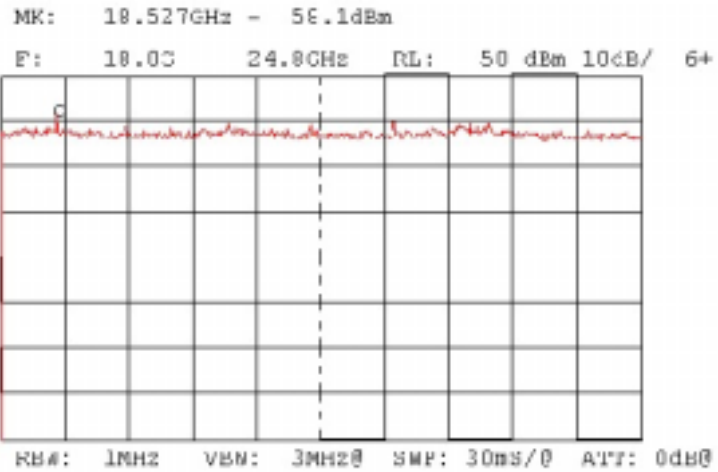




**Plot 4.8.49**

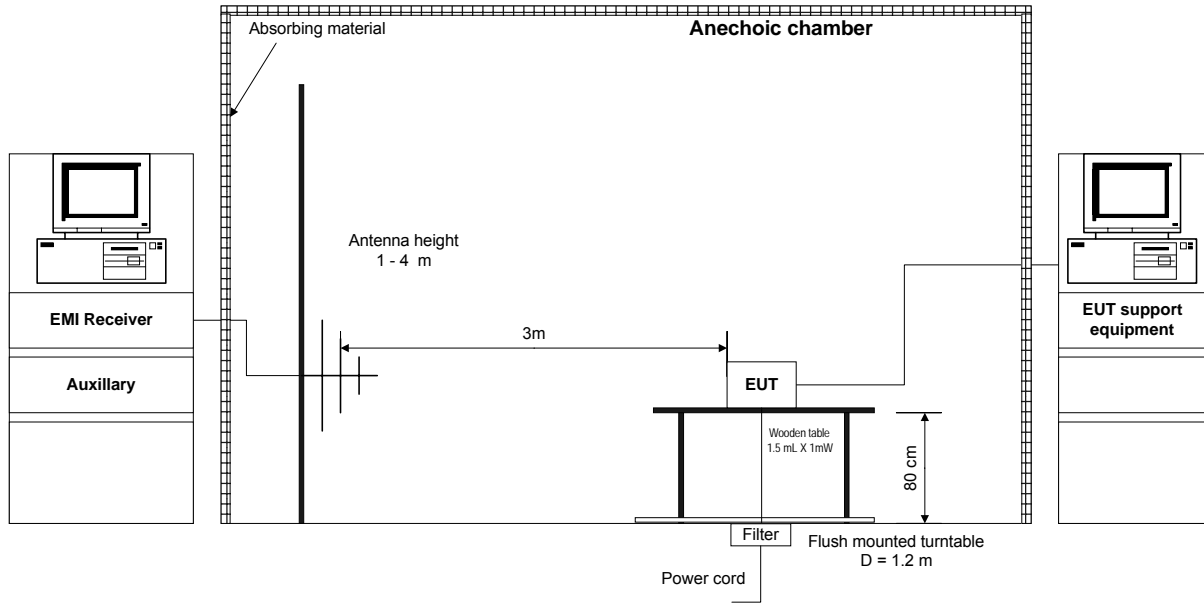
Test specification: §15.209  
Radiated spurious emissions measurement in transmitting mode  
Carrier frequency 2477 MHz

VERTICAL POLARIZATION



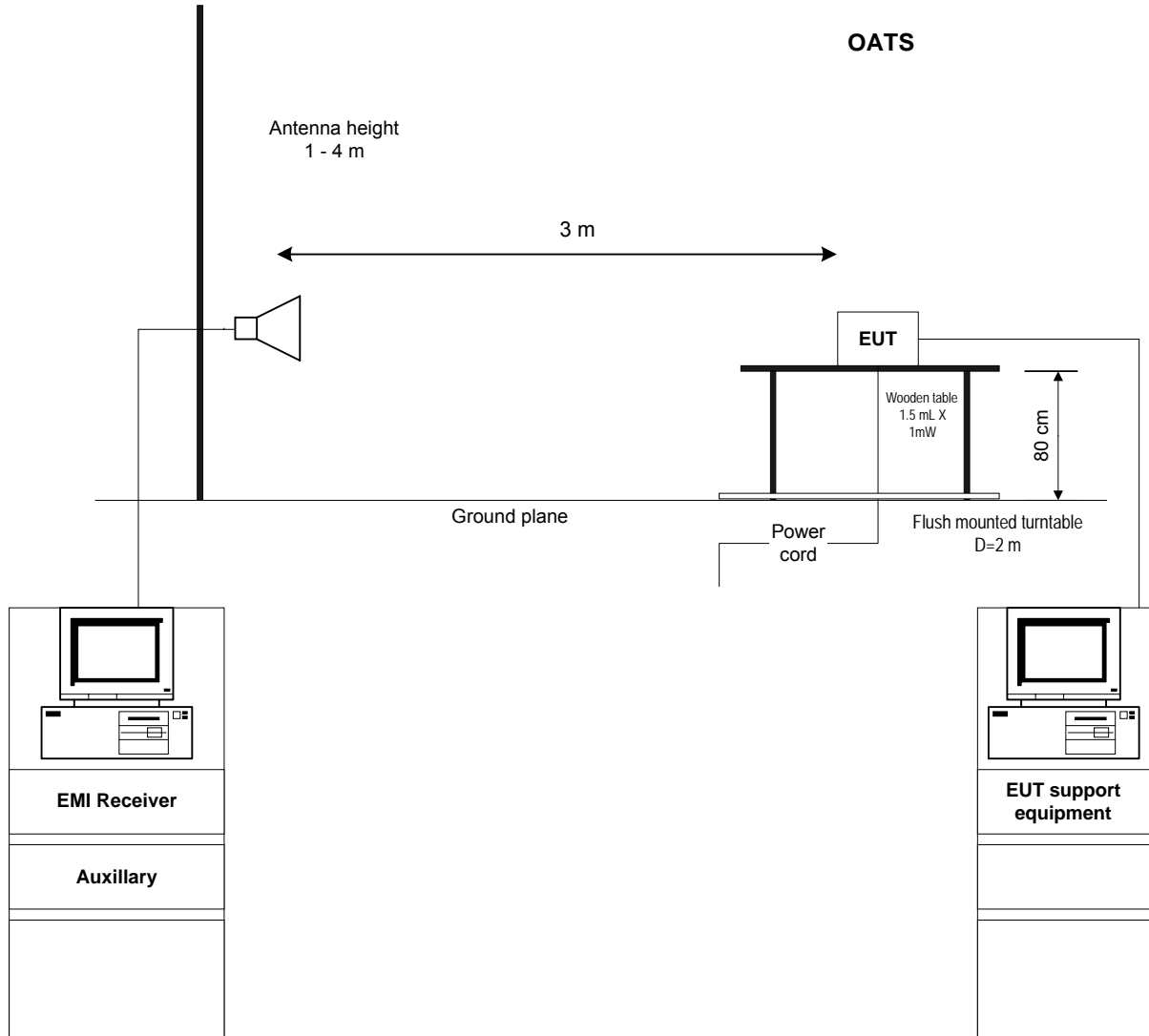


**Figure 4.8.1**  
**Radiated emission test setup**





**Figure 4.8.2**  
**Radiated emission test setup**



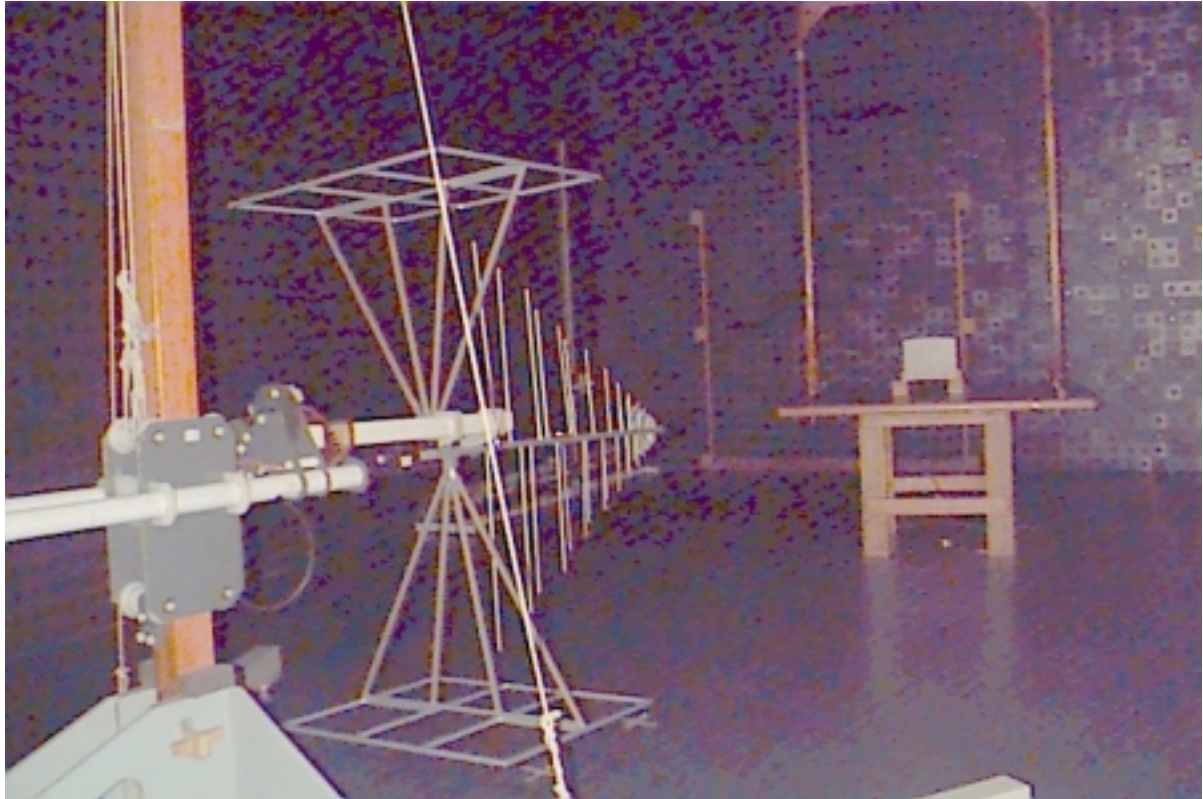


**Photograph No. 4.8.1**  
**Radiated emission measurement test setup**



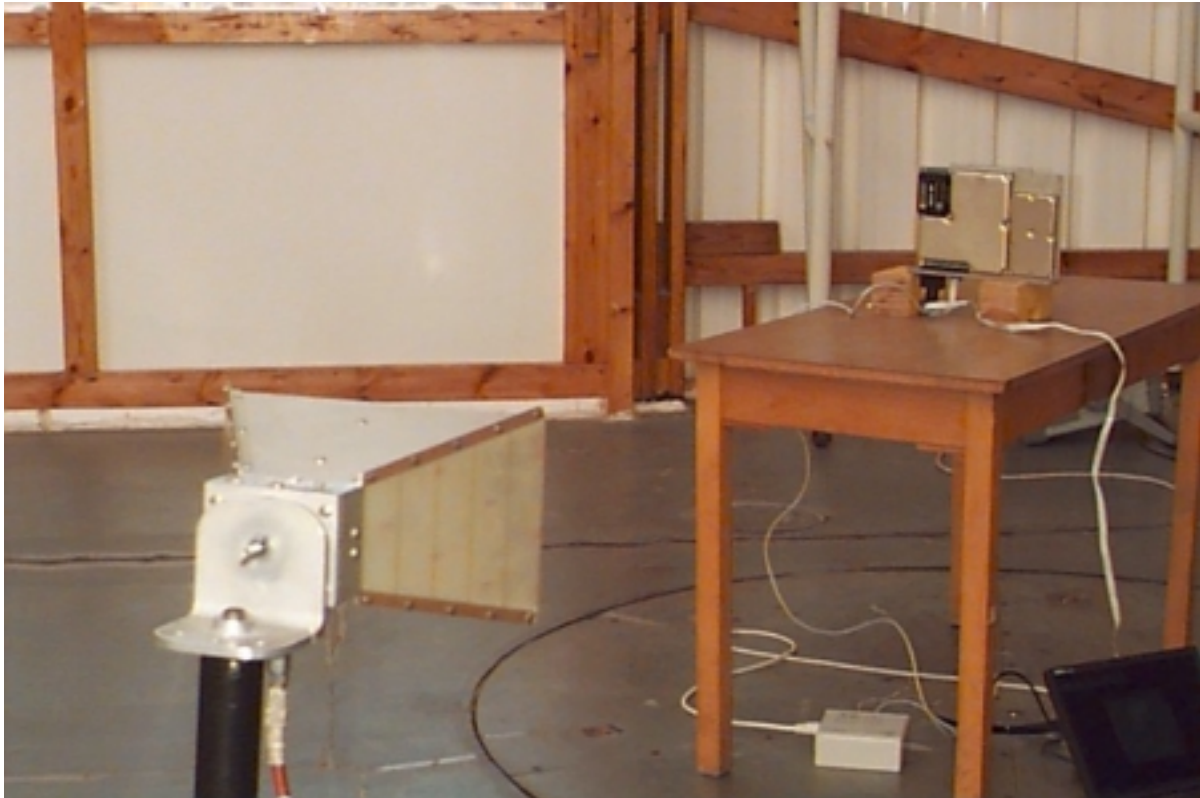


**Photograph No. 4.8.2**  
**Radiated emission measurement test setup**





**Photograph No. 4.8.3**  
**Radiated emission measurement test setup**





#### 4.9 Unintentional radiated emissions (class B digital device) test according to §15.109, §15.209

##### 4.9.1 General

This test was performed to measure radiated emissions from the receiver and incorporated digital device of the EUT and also to verify the EUT full compliance with §§15.109, 15.209.

Radiated emission measurements specification limits are given in Table 4.9.1 below:

**Table 4.9.1**  
**Limits for electric field strength, quasi-peak detector**

Frequency, MHz	Class B equipment @ 3 meter distance, dB(µV/m)
30 - 88	40
88 - 216	43.5
216 - 960	46
960 - 40000	54

##### 4.9.2 Test setup and procedure

The radiated emissions measurements of the EUT incorporated receiver and digital device were performed at 3 meter measuring distance in the anechoic chamber with the biconilog antenna from 30 MHz to 2 GHz and at the open area test site with the double ridged guide antenna from 2 GHz to 11 GHz ((5<sup>th</sup> harmonic of the receiver). The EUT was placed on the wooden table as shown in Figure 4.8.1 and Photographs 4.8.3. and 4.9.1.

To find maximum radiation the turntable was rotated 360°, the measuring antennas height was changed from 1 to 4 m, and antennas polarization was changed from vertical to horizontal.

This test was performed for the EUT in receiving mode.

The results are recorded in Tables 4.9.1 to 4.9.2 and shown in Plots 4.9.1 to 4.9.8.

##### Reference numbers of test equipment used

HL0041	HL0465	HL0521	HL0547	HL0589	HL 0594	HL 0604	HL1424
--------	--------	--------	--------	--------	---------	---------	--------

Full description is in Appendix A.



**Table 4.9.1 Radiated emission measurements test results,  
frequency range 30 MHz –1 GHz**

DATE: September 05, 2001  
RELATIVE HUMIDITY: 43%  
AMBIENT TEMPERATURE: 29°C  
DETECTOR TYPE QUASI-PEAK  
RBW 120 KHz  
ANTENNA TYPE BICONILOG

MEASUREMENTS PERFORMED AT 3 METER DISTANCE

Frequency, MHz	Frequency carrier, MHz	Ant. pol.	Antenna height, m	TT pos., °	Radiated emissions, dB (µV/m)	Limit, dB (µV/m)	Margin, dB	Pass/ Fail
85.91250	2403	H	2.2	247	25.21	43.5	14.79	Pass
125.00925	2477	V	1	211	30.20	43.5	13.30	Pass
132.60000	2477	V	1	0	32.69	43.5	9.99	Pass
288.01000	2403	H	1.8	17	31.76	43.5	14.24	Pass

**Notes to table calculations:**

RBW = resolution bandwidth  
Ant. pol.= Antenna polarization (V-vertical, H-horizontal)  
TT pos. = turntable position in degrees, (EUT front panel = 0°)  
Margin = dB below (negative if above) specification limit.





**Table 4.9.2 Radiated emission measurements test results,  
frequency range 2 GHz – 11 GHz**

DATE: February 26, 2001  
RELATIVE HUMIDITY: 54%  
AMBIENT TEMPERATURE: 23°C  
DETECTOR TYPE AVERAGE  
RBW 1 MHz  
ANTENNA TYPE DOUBLE RIDGED GIDE  
ANTENNA POLARIZATION VERTICAL

MEASUREMENTS PERFORMED AT 3 METER DISTANCE

Frequency, MHz	Ant. pol.	Antenna height, m	TT pos., °	Radiated emissions, dB (µV/m)	Limit, dB (µV/m)	Margin, dB	Pass/ Fail
2099.96	V	1.3	230	45.97	54.0	8.03	Pass
10260.00	V	1	0	50.30	54.0	3.7	Pass
10500.00	V	1	0	51.70	54.0	2.3	Pass
10650.00	H	1	0	52.40	54.0	1.6	Pass

**The “Pass” decision was made without Hermon Labs measurement uncertainty**

**Notes to table calculations:**

RBW = resolution bandwidth  
Ant. pol.= Antenna polarization (V-vertical, H-horizontal)  
TT pos. = turntable position in degrees, (EUT front panel = 0°)  
Margin = dB below (negative if above) specification limit.

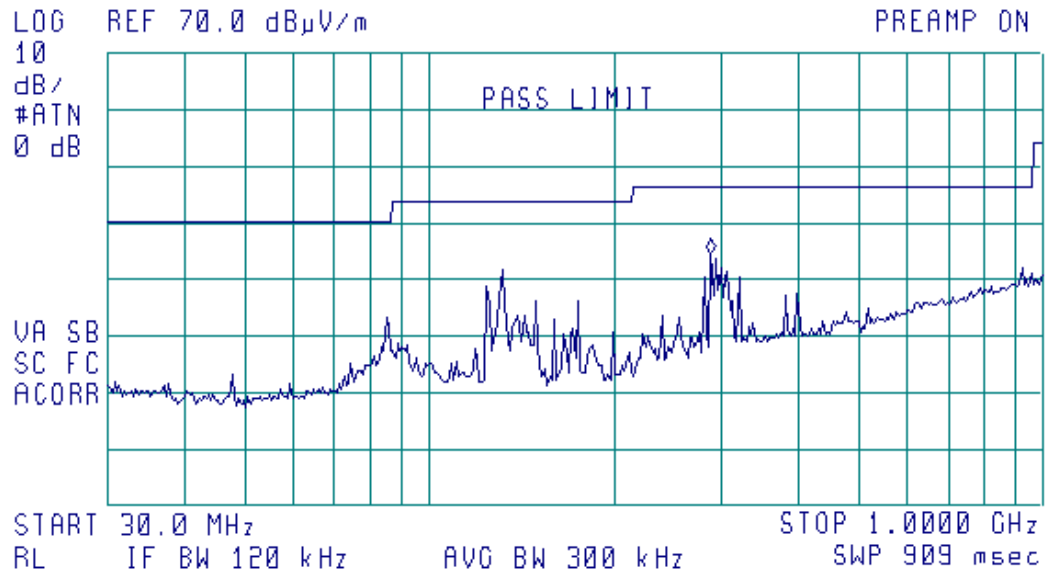


**Plot 4.9.1**

Test Specification: § 15.209  
Radiated emissions measurements test results  
Carrier frequency 2403 MHz

15:35:54 SEP 05 2001  
HORIZONTAL POLARIZATION

ACTV DET: PEAK  
MEAS DET: PEAK OP AVG  
MKR 287.5 MHz  
34.50 dBμV/m



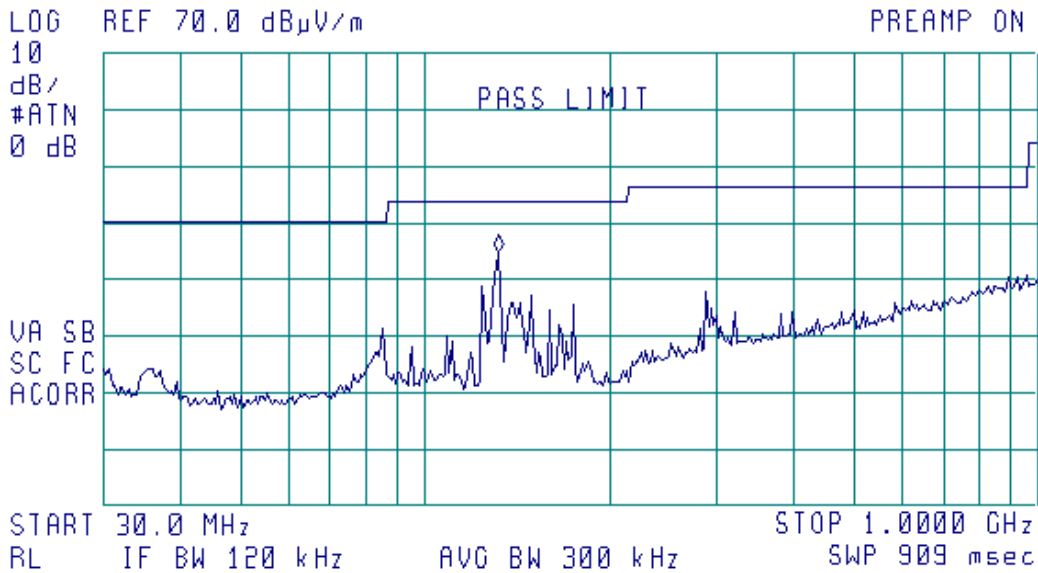


**Plot 4.9.2**

Test Specification: § 15.209  
Radiated emissions measurements test results  
Carrier frequency 2403 MHz

15:45:30 SEP 05, 2001  
VERTICAL POLARIZATION

ACTV DET: PEAK  
MEAS DET: PEAK QP AVG  
MKR 132.5 MHz  
34.93 dB $\mu$ V/m



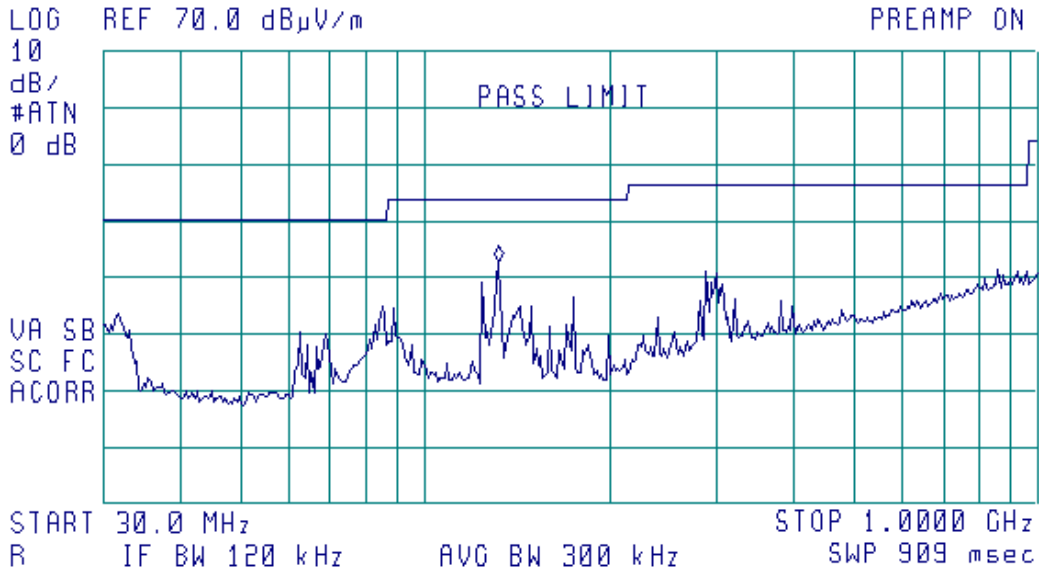


**Plot 4.9.3**

Test Specification: § 15.209  
Radiated emissions measurements test results  
Carrier frequency 2477 MHz

17:18:29 SEP 05, 2001  
HORIZONTAL POLARIZATION

ACTV DET: PEAK  
MEAS DET: PEAK QP AVG  
MKR 132.5 MHz  
32.56 dB $\mu$ V/m



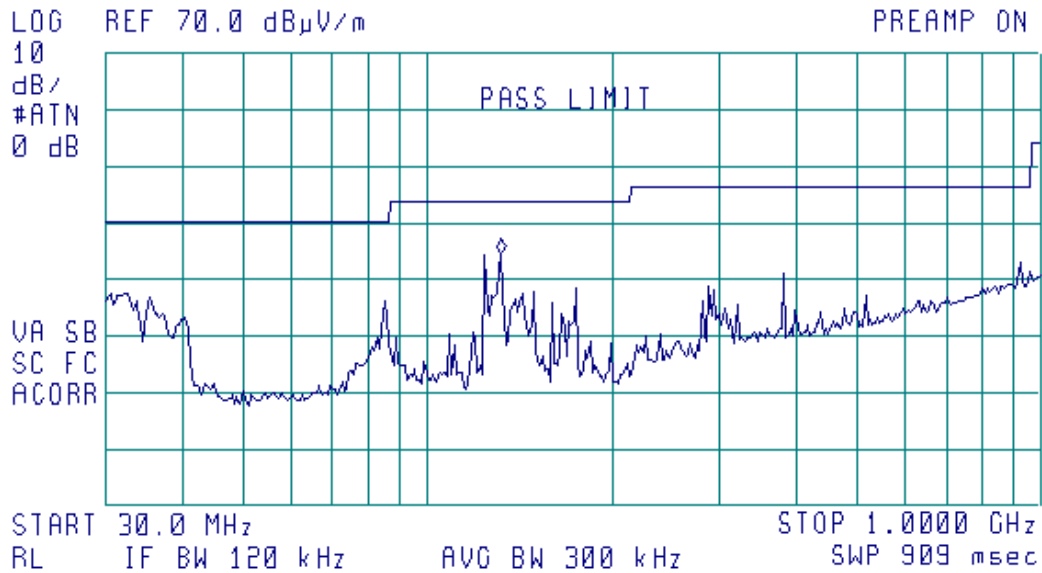


**Plot 4.9.4**

Test Specification: § 15.209  
Radiated emissions measurements test results  
Carrier frequency 2477 MHz

17:26:12 SEP 05, 2001  
VERTICAL POLARIZATION

ACTV DET: PEAK  
MEAS DET: PEAK OP AVG  
MKR 132.5 MHz  
34.26 dBµV/m





**Plot 4.9.5**

Test Specification: § 15.209  
Radiated emissions measurements test results  
Carrier frequency 2477 MHz

12:52:06 FEB 26, 2001

ACTV DET: PEAK  
MEAS DET: PEAK OP AVG  
MKR 2.096 GHz  
47.19 dB $\mu$ V/m

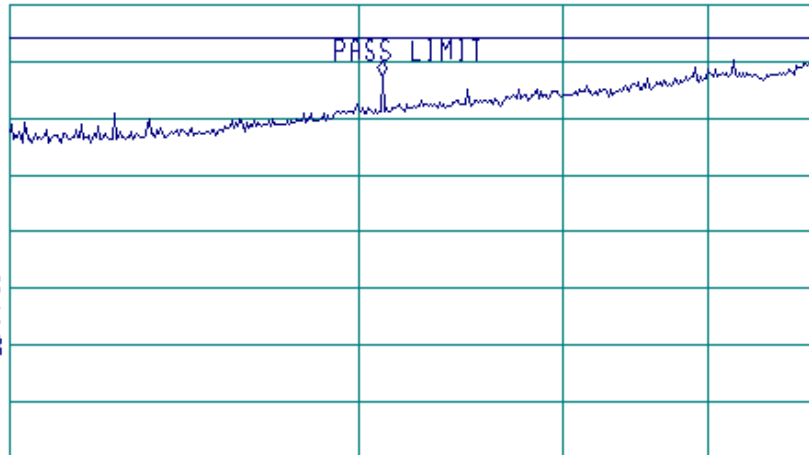
MEASURE  
AT MKR  
  
ADD TO  
LIST

LOC REF 60.0 dB $\mu$ V/m

PREAMP ON

CLEAR  
WRITE B

10  
dB/  
#ATN  
0 dB



MAX  
HOLD B

VIEW B

VA SB  
SC FC  
ACORR

BLANK B

Trace  
A B C

START 1.000 GHz

STOP 5.000 GHz

RL #JF BW 1.0 MHz

#AVG BW 1 MHz

SWP 700 msec

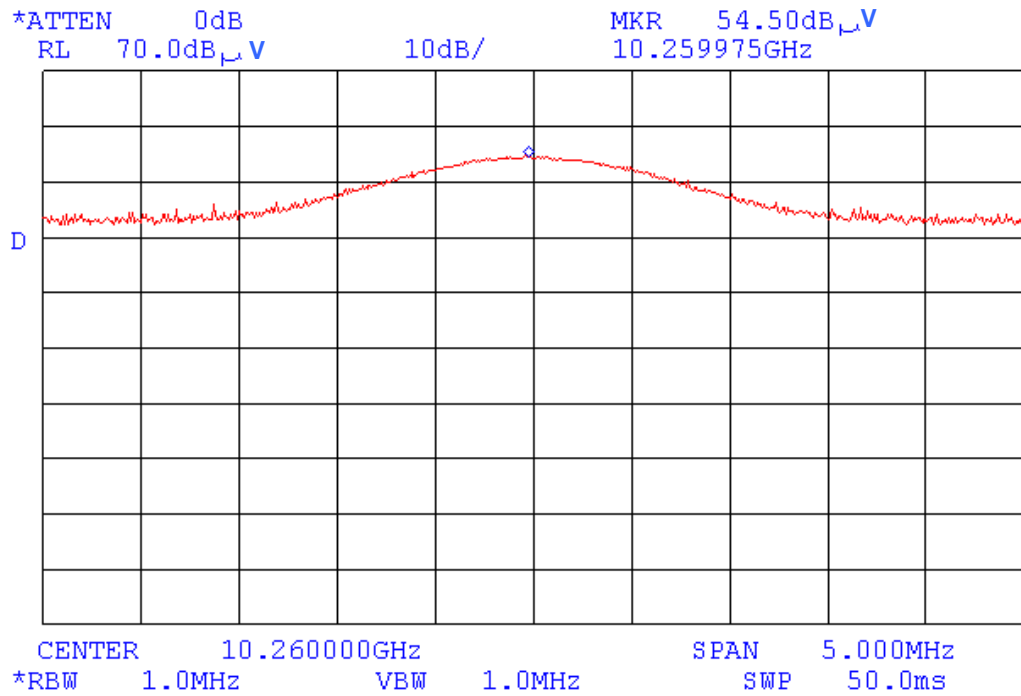
More  
1 of 3

Vertical + horizontal polarization



**Plot 4.9.6**

Test Specification: § 15.209  
Radiated emissions measurements test results

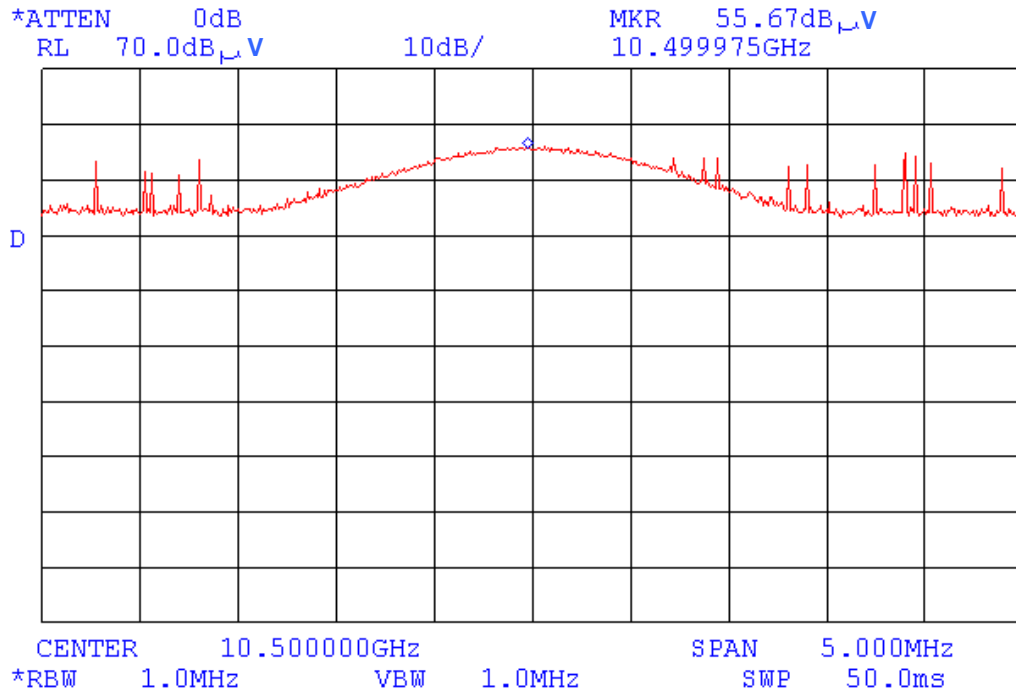


$E = U_{sa} + AF + CL - AG - AvF = 54.5 \text{ dB}\mu\text{V} + 38.3 \text{ dB}(1/\text{m}) + 4.4 \text{ dB} - 35 \text{ dB} - 11.9 \text{ dB}$   
 $E_{avr.} = 50.3 \text{ dB}(\mu\text{V}/\text{m})$   
 $E_{peak.} = 62.2 \text{ dB}(\mu\text{V}/\text{m})$



**Plot 4.9.7**

Test Specification: § 15.209  
Radiated emissions measurements test results



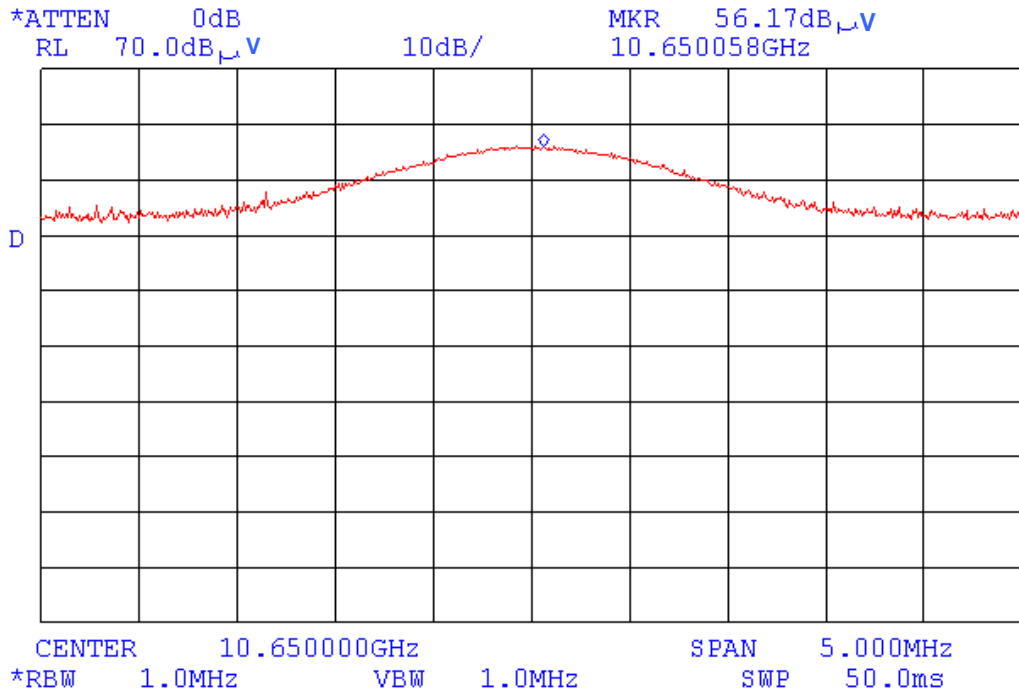
E= Usa+AF+CL-AG-AvF=55.7 dBuV+ 38.5 dB(1/m)+ 4.4 dB- 35 dB- 11.9 dB  
 E avr.= 51.7 dB(uV/m)  
 E peak.=63.6 dB(uV/m)





**Plot 4.9.8**

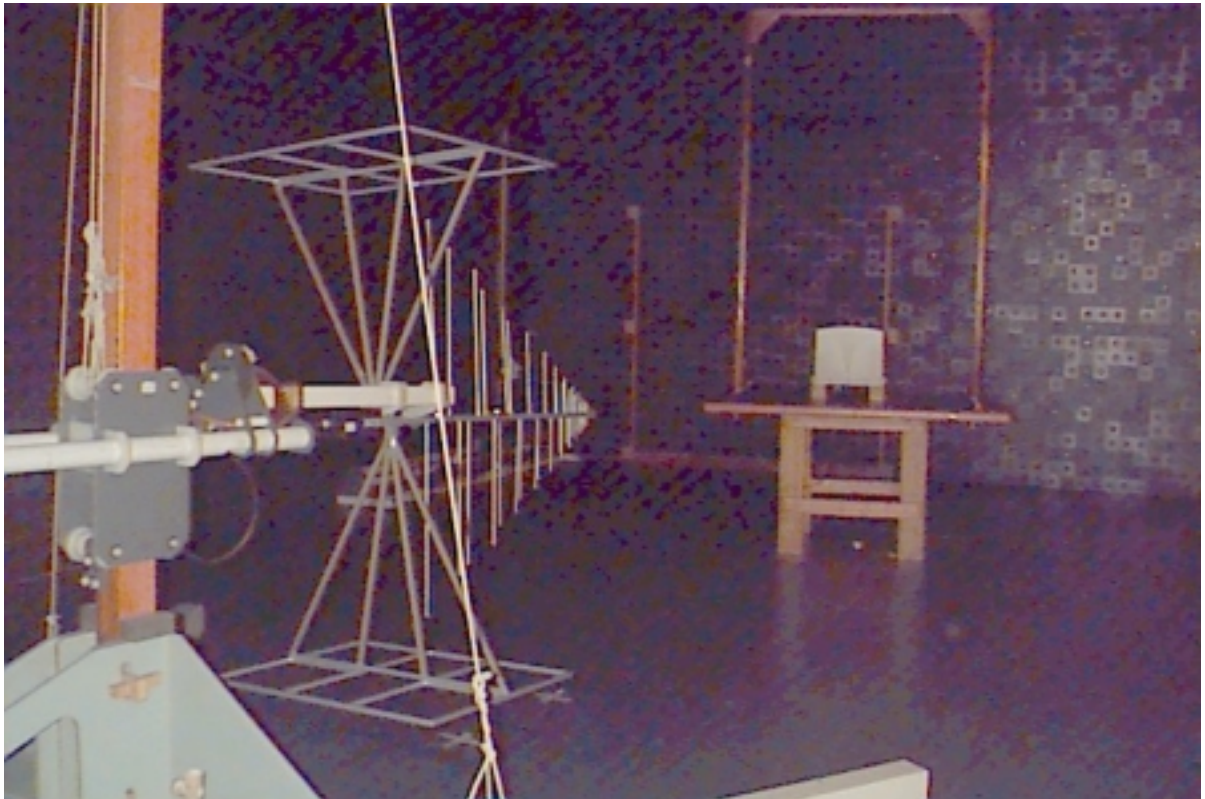
Test Specification: § 15.209  
Radiated emissions measurements test results



E=Usa+AF+CL-AG-AvF=56.2 dBuV+ 38.7 dB(1/m)+ 4.4 dB- 35 dB- 11.9 dB  
E avr.= 52.4 dB(uV/m)  
E peak.=64.3 dB(uV/m)



**Photograph No. 4.9.1**  
**Radiated emission measurement test setup**





#### 4.10 Unintentional conducted emissions (class B digital device) test according to §15.107

##### 4.10.1 General

Conducted emission measurements specification limit is given in Table 4.10.1 below.

**Table 4.10.1**  
**Limits for conducted emission on AC power lines**

Frequency, MHz	Class B equipment limit, dB(μV)
0.45 - 30	48

##### 4.10.2 Test procedure

The test was performed in the shielded room. The EUT was set up on the wooden table as shown in Figure 4.10.1 and Photograph 4.10.1. Frequency range from 450 kHz to 30 MHz was investigated.

The measurements were performed on the 120 V AC 60 Hz power lines (both neutral and phase) by means of the LISN, connected to the spectrum analyzer. The unused coaxial connector of the LISN was resistively terminated with 50 Ω. The position of the EUT cable was varied to determine maximum emission level. Peak and quasi peak detectors (resolution bandwidth = 9 kHz) were used.

This test was performed for the EUT in receiving mode.

The test results are recorded in Table 4.10.2 and shown in Plots 4.10.1 to 4.10.2.

##### Reference numbers of test equipment used

HL 0163	HL 0466	HL 0521	HL 0580	HL 0590	HL 1175
---------	---------	---------	---------	---------	---------

Full description is in Appendix A.



**Table 4.10.2 Conducted emissions measurement test results**

TEST SPECIFICATION: FCC, part 15, Class B  
DATE: FEBRUARY 28, 2001  
RELATIVE HUMIDITY: 52%  
AMBIENT TEMPERATURE: 23°C  
THE EUT WAS TESTED AS: TABLE-TOP EQUIPMENT  
DETECTORS USED: QUASI-PEAK  
FREQUENCY RANGE: 450 kHz – 30 MHz  
RESOLUTION BANDWIDTH: 9 kHz

Frequency, MHz	Line ID	Measured emissions, dB (uV)	Spec. limit, dB (uV)	Margin, dB	Pass/ Fail
6.489	N	35.33	48	12.67	Pass
7.072	Ph	36.45	48	11.55	Pass
7.631	N	38.25	48	9.75	Pass
7.824	N	41.36	48	6.64	Pass
7.837	Ph	40.56	48	7.44	Pass
15.436	Ph	36.29	48	11.71	Pass
23.656	N	37.42	48	10.58	Pass
24.264	Ph	36.16	48	11.84	Pass

- Line ID = Line Identification (Ph - phase, N - neutral).
- Measured conducted emissions = EMI meter reading (dBμV) + Cable Loss (dB) + LISN correction factor (dB).  
For LISN correction factor refer to Appendix B.
- Margin = dB below (negative if above) specification limit.



**Plot 4.10.1**

Test Specification: § 15.107, § 15.207  
Conducted emission measurements on power line  
Frequency range: 450 kHz-30 MHz  
Line: phase  
Detector: peak

08:46:54 FEB 28, 2001 PHASE

ACTV DET: PEAK  
MEAS DET: PEAK OP AVG  
MKR 15.62 MHz  
40.32 dBµV

MEASURE  
AT MKR  
ADD TO  
LIST

LOG REF 60.0 dBµV

PREAMP ON

MARKER  
↓ CF

10  
dB/  
ATN  
10 dB

PASS LIMIT

MARKER  
△

VA SB  
SC FC  
ACORR

NEXT  
PEAK

NEXT PK  
RIGHT

NEXT PK  
LEFT

START 450 kHz

STOP 30.00 MHz

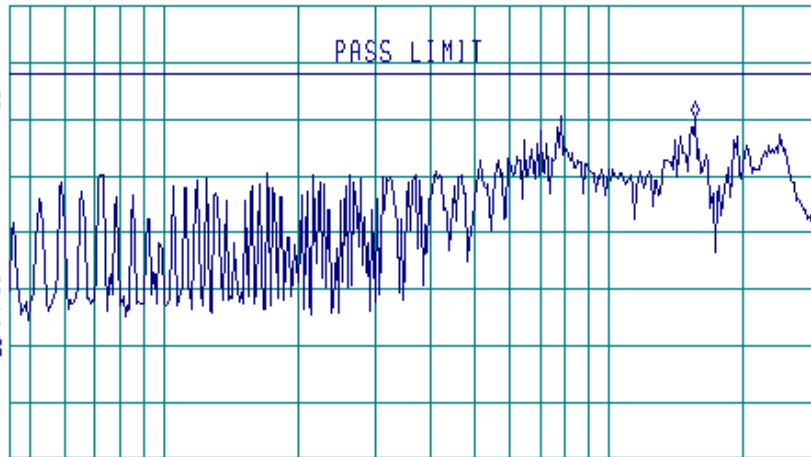
More

RL 1F BW 9.0 kHz

AVG BW 30 kHz

SWP 2.46 sec

1 of 2





**Plot 4.10.2**

Test Specification: § 15.107, § 15.207  
Conducted emission measurements on power line  
Frequency range: 450 kHz-30 MHz  
Line: neutral  
Detector: peak

08:54:36 FEB 28, 2001 NEUTRAL

ACTV DET: PEAK  
MEAS DET: PEAK OP AVG  
MKR 7.83 MHz  
40.74 dBµV

MEASURE  
AT MKR  
ADD TO  
LIST

LOG REF 60.0 dBµV

PREAMP ON

10  
dB/  
ATN  
10 dB

PASS LIMIT

MARKER  
↓ CF

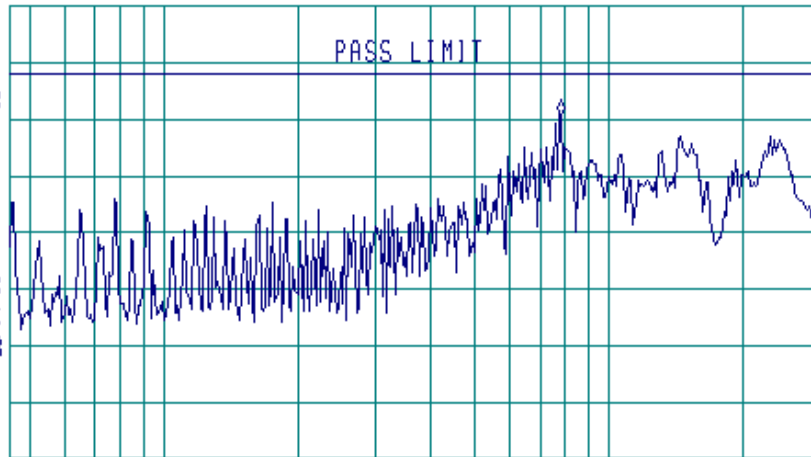
MARKER  
△

NEXT  
PEAK

NEXT PK  
RIGHT

NEXT PK  
LEFT

VA SB  
SC FC  
ACORR

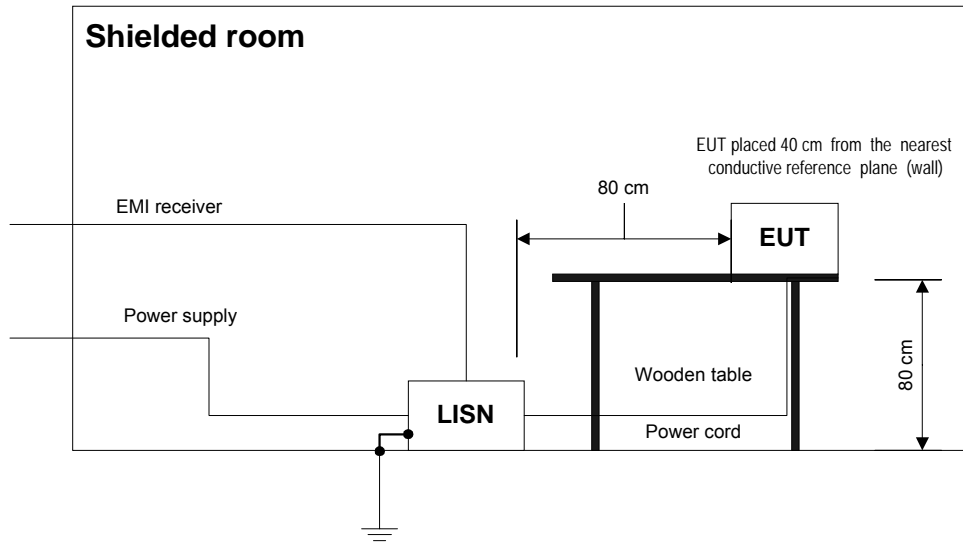


START 450 kHz STOP 30.00 MHz  
R JF BW 9.0 kHz AVG BW 30 kHz SWP 2.46 sec

More  
1 of 2

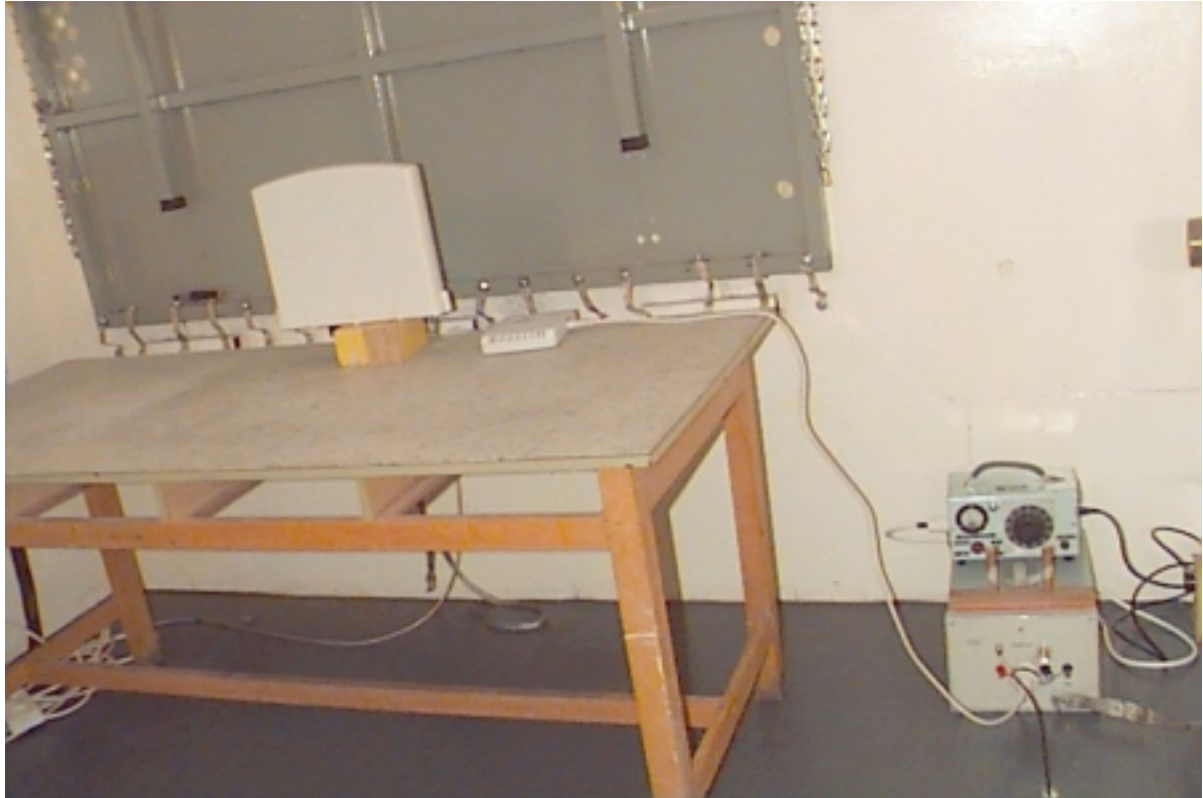


**Figure 4.10.1**  
**Conducted emissions test setup for table-top equipment**





**Photograph 4.10.1**  
**Conducted emission measurements test setup**







## APPENDIX A – Test equipment and ancillaries used for tests

HL serial No.	Description	Manufacturer information			Due calibr.
		Name	Model No.	Serial No.	
025	Analyzer, Spectrum, 10 kHz - 23 GHz / 140 GHz	Anritsu	MS-710C	5837	10/01
0038	Antenna Mast, 1-4 m	Hermon Labs	AM-1	028	02/02 Check
0041	Double ridged guide antenna, 1-18 GHz	Electro-Metrics	RGA 50/60	2811	03/02
0163	LISN FCC/VDE/MIL -STD	Electro-Metrics	ANS-25/2	1314	
0287	Turntable, motorized diameter, 2 m	Hermon Labs	TMD-2	042	11/01 Check
0411	Cable, Coax, Microwave, DC-18 GHz, N-N, 2 m	Gore	36Q01Q0107 8.8	9338768	02/02
0465	Anechoic Chamber 9 (L) x 6.5 (W) x 5.5 (H) m	Hermon Labs	AC-1	023	03/03
0466	Shielded Room 3 (L) x 3 (W) x 2.4 (H) m	Hermon Labs	SR-1	024	05/02 Check
0483	Oscilloscope, Digitizing, 100 MHz	Hewlett Packard	54501A	1325	11/01
0521	Spectrum Analyzer with RF filter section (EMI Receiver 9 kHz - 6.5 GHz)	Hewlett Packard	8546A	0319	09/02
0547	Amplifier, GaAs FET, RF, 6-18 GHz, 2 W, 35 dB, 12 V/1.2 A, N.F.4.5 dB	Avantek	AMT - 12407M	400	12/01
0554	Amplifier, 2-18 GHz RF	Miteq	AFD4	104300	12/01
0580	DC block adaptor 10 kHz-2.2 GHz	Anritsu	MA8601 A	580	12/01
0589	Cable Coaxial, GORE A2POL118.2, 3m	Hermon Labs	GORE-3	589	11/01
0590	Attenuator 10 dB, 50 Ohm, N-type, 2W	Elisra Electronic Systems	MW2100-N- Type	10	01/02
0593	Antenna Mast, 1-4 m/ 1-6 m Pneumatic	Hermon Labs	AM-F1	101	02/02 check
0594	Turntable for Anechoic Chamber, flush mounted, d=1.2 m, pneumatic	Hermon Labs	WDC1	102	11/01
0604	Antenna Biconilog Log-Periodic/T Bow-Tie, 26 - 2000 MHz	EMCO	3141	9611-1011	12/01
0750	Mixer General Purpose Waveguide 18.0-26.5 GHz	Tektronix	WM 490 K	B015125	06/02
0768	Antenna Standard Gain Horn, 18-26.5 GHz, WR-42, K-band, Gain - 25 dB	Quinstar Technology	QWH-4200- BA	110	07/04
0812	Cable, coax, RG-214, 11.5 m, N-type connectors	Hermon Labs	C214-11	148	05/02
0813	Cable, coax, RG-214, 12 m, N-type connectors	Hermon Labs	C214-12	149	05/02
1059	Cable Coaxial , Microwave DC-18 GHz , TNC-TNC , 6 m		GXCO1CO12 40		02/02
1175	Microwave 5 m cable	Gore	01C02245.2	NA	02/02
1200	Quadruplexer 1 - 12 GHz,	Electronica S.p.A. - Roma	UE 84	D/00240	04/02
1424	Spectrum analyzer	Agilent Technologies	8564EC	3946A00219	08/02
1567	Cable RF, 2 m	Huber-Suhner	Sucoflex	3095/4PE	12/01



HL serial No.	Description	Manufacturer information			Due calibr.
		Name	Model No.	Serial No.	
1650	Attenuators Set (2, 3, 5, 20 dB), DC-18 GHz	M/A-COM	2082	1650	03/02
1651	Attenuators Set (2, 3, 5, 20 dB), DC-18 GHz	M/A-COM	2082	1651	03/02
1833	Cable RF, 2 m	Huber-Suhner	Sucoflex	146602/2	04/02
1915	Active Receiving Loop Antenna, 1 kHz - 30MHz	EMC Test Systems	6507	1457	06/02



## APPENDIX B-Test equipment correction factors

**Correction Factor  
Line Impedance Stabilization Network  
Model LISN 16 - 1  
Hermon Laboratories**

Frequency, kHz	Correction Factor
10	4.9
15	2.86
20	1.83
25	1.25
30	0.91
35	0.69
40	0.53
50	0.35
60	0.25
70	0.18
80	0.14
90	0.11
100	0.09
125	0.06
150	0.04

The correction factor dB is to be added to the meter readings (dB/μV) of the interference analyzer or spectrum analyzer.

**Antenna factor  
Double ridged guide antenna  
Electro-Metrics, model RGA-50/60  
Ser.No.2811**

Frequency, MHz	Antenna Factor, dB(1/m)	Frequency, MHz	Antenna Factor, dB(1/m)
1000	24.3	10,000	38.2
1500	25.4	10,500	38.5
2000	28.4	11,000	39.0
2500	29.2	11,500	40.1
3000	30.5	12,000	40.2
3500	31.6	12,500	39.3
4000	33.7	13,000	39.9
4500	32.2	13,500	40.6
5000	34.5	14,000	41.1
5500	34.5	14,500	40.5
6000	34.6	15,000	39.9
6500	35.3	15,500	37.8
7000	35.5	16,000	39.1
7500	35.9	16,500	41.1
8000	36.6	17,000	41.7
8500	37.3	17,500	45.1
9000	37.7	18,000	44.3
9500	37.7		

Antenna factor dB(1/m) is to be added to receiver meter reading in dB(μV) to convert to field intensity in dB(μV/meter)



**Antenna factor at 3m calibration  
Biconilog antenna EMCO model 3141, Ser.No.1011**

Frequency, MHz	Antenna Factor, dB(1/m)	Frequency, MHz	Antenna Factor, dB(1/m)
30	7.8	980	24.5
40	7.2	1000	24.9
60	7.1	1020	25.0
70	8.5	1040	25.2
80	9.4	1060	25.4
90	9.8	1080	25.6
100	9.7	1100	25.7
110	9.3	1120	26.0
120	8.8	1140	26.4
130	8.7	1160	27.0
140	9.2	1180	27.0
150	9.8	1200	26.7
160	10.2	1220	26.5
170	10.4	1240	26.5
180	10.4	1260	26.5
190	10.3	1280	26.6
200	10.6	1300	27.0
220	11.6	1320	27.8
240	12.4	1340	28.3
260	12.8	1360	28.2
280	13.7	1380	27.9
300	14.7	1400	27.9
320	15.2	1420	27.9
340	15.4	1440	27.8
360	16.1	1460	27.8
380	16.4	1480	28.0
400	16.6	1500	28.5
420	16.7	1520	28.9
440	17.0	1540	29.6
460	17.7	1560	29.8
480	18.1	1580	29.6
500	18.5	1600	29.5
520	19.1	1620	29.3
540	19.5	1640	29.2
560	19.8	1660	29.4
580	20.6	1680	29.6
600	21.3	1700	29.8
620	21.5	1720	30.3
640	21.2	1740	30.8
660	21.4	1760	31.1
680	21.9	1780	31.0
700	22.2	1800	30.9
720	22.2	1820	30.7
740	22.1	1840	30.6
760	22.3	1860	30.6
780	22.6	1880	30.6
800	22.7	1900	30.6
820	22.9	1920	30.7
840	23.1	1940	30.9
860	23.4	1960	31.2
880	23.8	1980	31.6
900	24.1	2000	32.0
920	24.1		

Antenna factor is to be added to receiver meter reading in dB(μV) to convert to field intensity in dB(μV/meter).