



Hermon Laboratories Ltd.  
Harakevet Industrial Zone, Binyamina 30500,  
Israel  
Tel. +972-4-6288001  
Fax. +972-4-6288277  
E-mail: mail@hermonlabs.com

# TEST REPORT

ACCORDING TO: FCC 47CFR part 27

FOR:

**Airspan Networks Inc.**

**LTE Base Station**

**Model: AirHarmony 1000D 2.49-2.69 GHz (B38, B41)**

**FCC ID:PIDH1KD25F**

This report is in conformity with ISO/ IEC 17025. The "A2LA Accredited" symbol endorsement applies only to the tests and calibrations that are listed in the scope of Hermon Laboratories accreditation. The test results relate only to the items tested.  
This test report shall not be reproduced in any form except in full with the written approval of Hermon Laboratories Ltd.



## Table of contents

1	Applicant information.....	3
2	Equipment under test attributes .....	3
3	Manufacturer information .....	3
4	Test details.....	3
5	Tests summary.....	4
6	EUT description.....	5
6.1	General information.....	5
6.2	Ports and lines .....	5
6.3	Support and test equipment .....	5
6.4	Test configuration.....	6
6.5	Transmitter characteristics .....	7
7	Transmitter tests according to 47CFR part 27.....	8
7.1	Occupied bandwidth test.....	8
7.2	Peak output power test.....	13
7.3	Band edge emissions at RF connector test.....	25
8	APPENDIX A Test equipment and ancillaries used for tests.....	30
9	APPENDIX B Measurement uncertainties.....	31
10	APPENDIX C Test facility description .....	32
11	APPENDIX D Specification references .....	32
13	APPENDIX E Test equipment correction factors.....	33
14	APPENDIX F Abbreviations and acronyms.....	34

## 1 Applicant information

**Client name:** Airspan Networks Inc.  
**Address:** 777 Yamato, Road Suite 310 Boca Raton, FL 33431, USA  
**Telephone:** +1 561 893 8670  
**Fax:** +1 561 893 8671  
**E-mail:** zlevi@airspan.com  
**Contact name:** Mr. Zion Levi

## 2 Equipment under test attributes

**Product name:** LTE Base Station  
**Product type:** Transceiver  
**Model(s):** AirHarmony 1000D 2.49-2.69 GHz (B38, B41)  
**Serial number:** 0CEFFACCB208  
**Hardware version:** C0  
**Software release:** 14.14.50.116  
**Receipt date:** 08-May-16

## 3 Manufacturer information

**Manufacturer name:** Airspan Networks Inc.  
**Address:** 777 Yamato, Road Suite 310 Boca Raton, FL 33431, USA  
**Telephone:** +1 561 893 8670  
**Fax:** +1 561 893 8671  
**E-Mail:** zlevi@airspan.com  
**Contact name:** Mr. Zion Levi

## 4 Test details

**Project ID:** 28365  
**Location:** Hermon Laboratories Ltd. Harakevet Industrial Zone, Binyamina 30500, Israel  
**Test started:** 08-May-16  
**Test completed:** 10-May-16  
**Test specification(s):** FCC 47CFR part 27

## 5 Tests summary

Test	Status
<b>Transmitter characteristics</b>	
Section 27.50(h), Peak output power at RF antenna connector	Pass
Section 27.50(h)(4), Spectral power density	Pass
Section 27.53(m)(2), Band edge emissions at RF antenna connector	Pass
Section 2.1049, Occupied bandwidth	Pass

The product was approved under FCC ID:PIDH1KD25F for operation in 2496.0 – 2690.0 MHz band with 5 MHz, 10 MHz and 20 MHz channel bandwidth. The relevant tests to support 40 MHz channel bandwidth and submit Application for Class II permissive changes certification were done.



The bandwidth change is software controlled, no hardware change was made. The same units were used for the 40 MHz CBW testing. The RF circuitry remained exactly the same including the RF filter (no hardware change was done) therefore there is no any impact from the amplifier stages.

The output power of the device remained the same while the bandwidth is twice wider. That results in the reduction of power spectral density by approximately 3 dB [ $10\log(\text{BW's ratio})$ ]. Taking into account that the hardware is the same and the power spectral density is lower, the narrower bandwidth represents the worst case scenario for spurious emissions as it is measured within RBW narrower than the emission BW - the higher PSD yields higher results. Band edge emissions were retested for the wider BW.

Testing was completed against all relevant requirements of the test standard. The results obtained indicate that the product under test complies in full with the requirements tested.

The test results relate only to the items tested. Pass/ fail decision was based on nominal values.

This test report supersedes the previously issued test report identified by Doc ID:AIRRAD\_FCC.28365\_FB.

	Name and Title	Date	Signature
<b>Tested by:</b>	Mr. K. Zushchuk, test engineer	May 10, 2016	
<b>Reviewed by:</b>	Mrs. M. Cherniavsky, certification engineer	June 16, 2016	
<b>Approved by:</b>	Mr. M. Nikishin, EMC and radio group leader	June 16, 2016	



## 6 EUT description

### 6.1 General information

The EUT, Base station radio, AirHarmony 1000D 2.49-2.69 GHz (B38, B41), is part of a LTE broadband fixed cellular wireless access system. The system provides a radio link between an end-user (a subscriber) and a network to give high-speed data access. The AirHarmony's transceiver/receiver (Up to 64 QAM modulation, data rate up to 190 Mbps) uses OFDM and operating in TDD mode, equipped with a 18 dBi external antenna. The maximum total RF output power (not including antenna gain) is 40.31 dBm for 18 dBi antenna and it can be reduced by software.

The AirHarmony is installed outdoors and typically is mounted on a pole. The Subscriber transmits and receives traffic to and from the base station respectively. The transceiver provides subscribers with "always-on" Internet, high speed data only, or data and voice (VoIP) services and is configured with a unique base station reference number, preventing the LTE UE from relocating to another subscriber premises without authorization.

### 6.2 Ports and lines

Port type	Port description	Connected from	Connected to	Qty.	Cable type	Cable length, m
Power	AC power	AC mains	Power Box	1	Unshielded	3
Power	DC power	Power Box	EUT	1	Unshielded	3
Signal	GPS	EUT	GPS external antenna	1	Coax	3
Signal	Ethernet	EUT	Power Box	1	FTP	3
Signal	Ethernet	Power Box	Laptop	1	NA	NA
RF	RF Link (Tx/Rx)	EUT	Anntena	2	Coax	0.5
Signal*	Serial*	Not connected	Not connected	1	NA	NA

### 6.3 Support and test equipment

Description	Manufacturer	Model number	Serial number
Laptop	DELL	Latitude E7440	DWW5M12

## 6.4 Test configuration

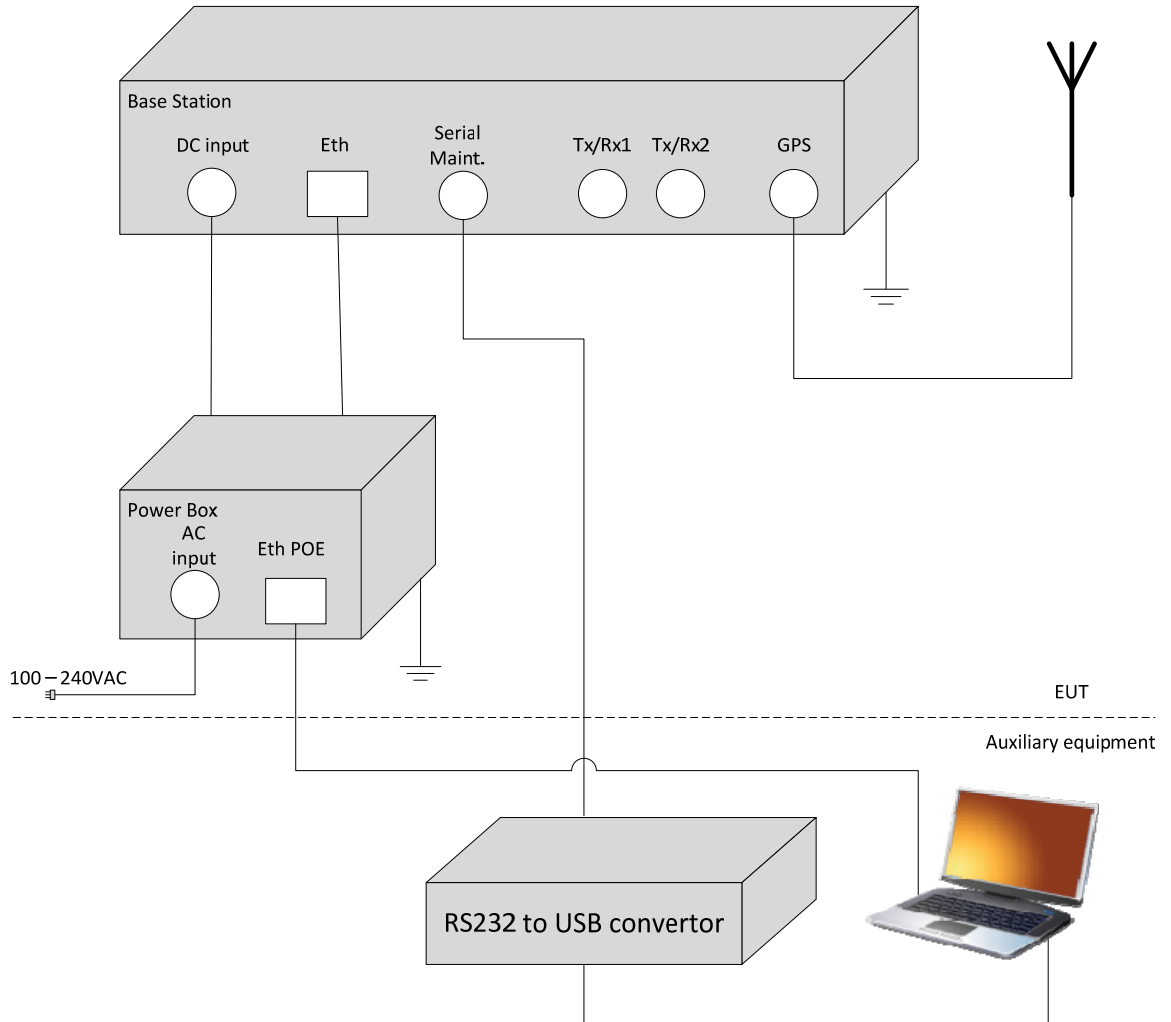



### 6.5 Transmitter characteristics

<b>Type of equipment</b>					
V	Stand-alone (Equipment with or without its own control provisions)				
	Combined equipment (Equipment where the radio part is fully integrated within another type of equipment)				
	Plug-in card (Equipment intended for a variety of host systems)				
<b>Intended use</b>		<b>Condition of use</b>			
V	fixed	Always at a distance more than 2 m from all people			
	mobile	Always at a distance more than 20 cm from all people			
	portable	May operate at a distance closer than 20 cm to human body			
<b>Assigned frequency range</b>		2496.0 – 2690.0 MHz			
<b>Operating frequency</b>		2516.0 – 2670.0 MHz for 40 MHz OBW			
<b>RF channel spacing</b>		40 MHz			
<b>Maximum rated output power</b>		At transmitter 50 Ω RF output connector (aggregate power of both RF chains)			
			40.31 dBm		
<b>Is transmitter output power variable?</b>		No			
		continuous variable			
		V	Yes	stepped variable with step size	0.25 dB
				minimum RF power	-30 dBm
			maximum RF power at antenna connector	37.00 dBm	
<b>Antenna connection</b>					
unique coupling	V	standard connector	Integral		
			V with temporary RF connector without temporary RF connector		
<b>Antenna/s technical characteristics</b>					
Type	Manufacturer	Model number	Gain		
External	ALPHA Wireless Ltd	AW3007	18 dBi		
External	ALPHA Wireless Ltd	AW3008	17 dBi		
External sector	Cobham Antenna Systems	SA12-2.5-DS/1915	11 dBi		
<b>Transmitter aggregate data rate/s, MBps</b>					
Transmitter 26dBc power bandwidth 40 MHz		Type of modulation			
		QPSK	16QAM		
	46.8 MBps	90.8 MBps	64QAM		
			190 MBps		
<b>Type of multiplexing</b>		TDD			
<b>Modulating test signal (baseband)</b>		PRBS			
<b>Maximum transmitter duty cycle in normal use</b>		75%			
<b>Transmitter power source</b>					
	DC	Nominal rated voltage	Battery type		
		Nominal rated voltage			
V	AC mains	Nominal rated voltage	120VAC		
		Frequency			
<b>Common power source for transmitter and receiver</b>		V	yes		
			no		



<b>Test specification:</b> Section 2.1049, Occupied bandwidth			
<b>Test procedure:</b> 47 CFR, Section 2.1049			
<b>Test mode:</b> Compliance	<b>Verdict:</b> PASS		
<b>Date(s):</b> 08-May-16			
<b>Temperature:</b> 23 °C	<b>Air Pressure:</b> 1015 hPa	<b>Relative Humidity:</b> 45 %	<b>Power Supply:</b> 120 VAC
<b>Remarks:</b>			

## 7 Transmitter tests according to 47CFR part 27

### 7.1 Occupied bandwidth test

#### 7.1.1 General

This test was performed to measure transmitter occupied bandwidth. Specification test limits are given in Table 7.1.1.

Table 7.1.1 Occupied bandwidth limits

Assigned frequency, MHz	Modulation envelope reference points*, dBc	Maximum allowed bandwidth, kHz
2496.0 – 2690.0 MHz	26	NA

\* - Modulation envelope reference points are provided in terms of attenuation below the unmodulated carrier.

#### 7.1.2 Test procedure

7.1.2.1 The EUT was set up as shown in Figure 7.1.1, energized and its proper operation was checked.

7.1.2.2 The EUT was set to transmit the normal modulated signal and actual channel width was measured at the 26 dBc modulation envelope reference points.

7.1.2.3 The transmitter occupied bandwidth was measured with spectrum analyzer as a frequency delta between the reference points on modulation envelope and provided in Table 7.1.2 and the associated plots.

Figure 7.1.1 Occupied bandwidth test setup

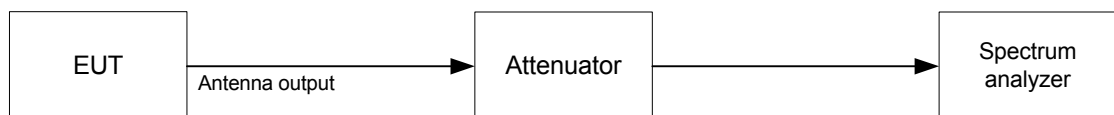





<b>Test specification:</b>		<b>Section 2.1049, Occupied bandwidth</b>	
<b>Test procedure:</b>		47 CFR, Section 2.1049	
<b>Test mode:</b>		Compliance	
<b>Date(s):</b>		08-May-16	
<b>Temperature:</b> 23 °C		<b>Air Pressure:</b> 1015 hPa	
		<b>Relative Humidity:</b> 45 %	
		<b>Power Supply:</b> 120 VAC	
<b>Remarks:</b>			

Table 7.1.2 Occupied bandwidth test results

DETECTOR USED: Peak  
 RESOLUTION BANDWIDTH: 430 kHz  
 MODULATION ENVELOPE REFERENCE POINTS: 26 dBc  
 EBW: 40 MHz

Carrier frequency, MHz	OBW 26 dBc, MHz	OBW 99%. MHz	Limit, kHz	Verdict
<b>QPSK</b>				
2516	38.343	36.850	NA	Pass
2594	38.792	36.806	NA	Pass
2670	38.794	36.797	NA	Pass
<b>64QAM</b>				
2516	38.859	36.912	NA	Pass
2594	38.831	36.860	NA	Pass
2670	38.815	36.819	NA	Pass

Reference numbers of test equipment used

HL 2214	HL 3301	HL 3302	HL 3818	HL 3903			
---------	---------	---------	---------	---------	--	--	--

Full description is given in Appendix A.



<b>Test specification:</b>		<b>Section 2.1049, Occupied bandwidth</b>	
<b>Test procedure:</b>		47 CFR, Section 2.1049	
<b>Test mode:</b>		Compliance	
<b>Date(s):</b>		08-May-16	
<b>Temperature: 23 °C</b>		<b>Air Pressure: 1015 hPa</b>	
		<b>Relative Humidity: 45 %</b>	
		<b>Power Supply: 120 VAC</b>	
<b>Remarks:</b>			
		<b>Verdict: PASS</b>	

Plot 7.1.1 Occupied bandwidth test results at low frequency, 40 MHz EBW, QPSK

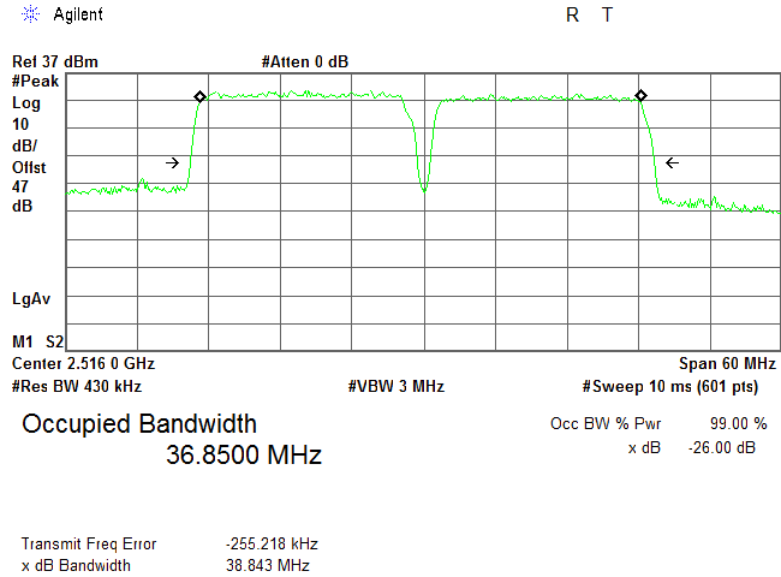

Plot 7.1.2 Occupied bandwidth test results at mid frequency, 40 MHz EBW, QPSK

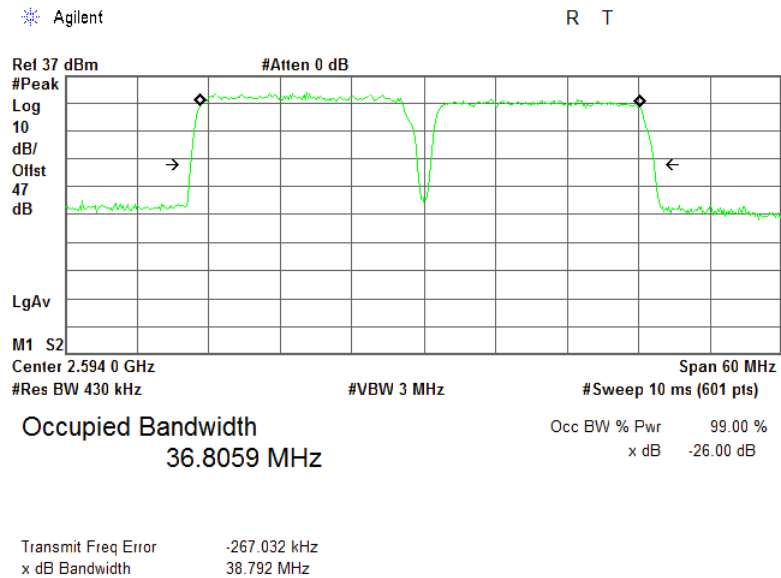



HERMON LABORATORIES

<b>Test specification:</b>		<b>Section 2.1049, Occupied bandwidth</b>	
<b>Test procedure:</b>		47 CFR, Section 2.1049	
<b>Test mode:</b>		Compliance	
<b>Date(s):</b>		08-May-16	
<b>Temperature: 23 °C</b>		<b>Air Pressure: 1015 hPa</b>	
		<b>Relative Humidity: 45 %</b>	
		<b>Power Supply: 120 VAC</b>	
<b>Remarks:</b>			
		<b>Verdict: PASS</b>	

Plot 7.1.3 Occupied bandwidth test results at high frequency, 40 MHz EBW, QPSK

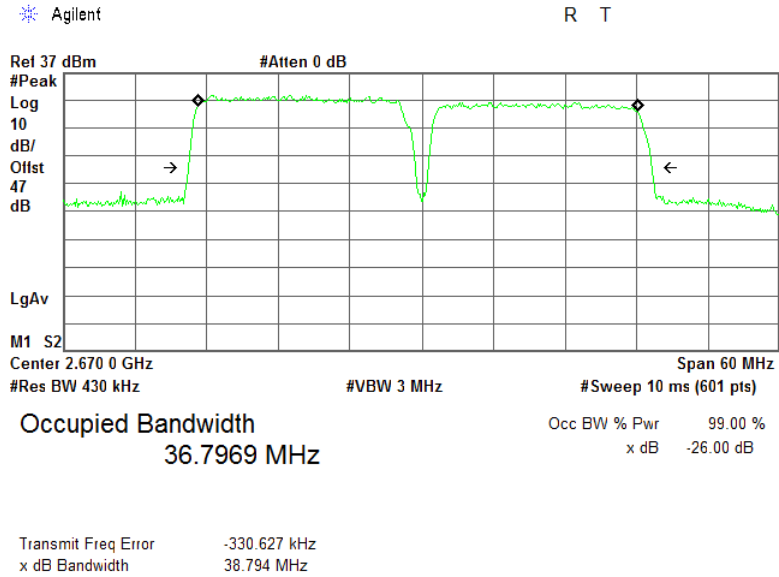

Plot 7.1.4 Occupied bandwidth test results at low frequency, 40 MHz EBW, 64QAM

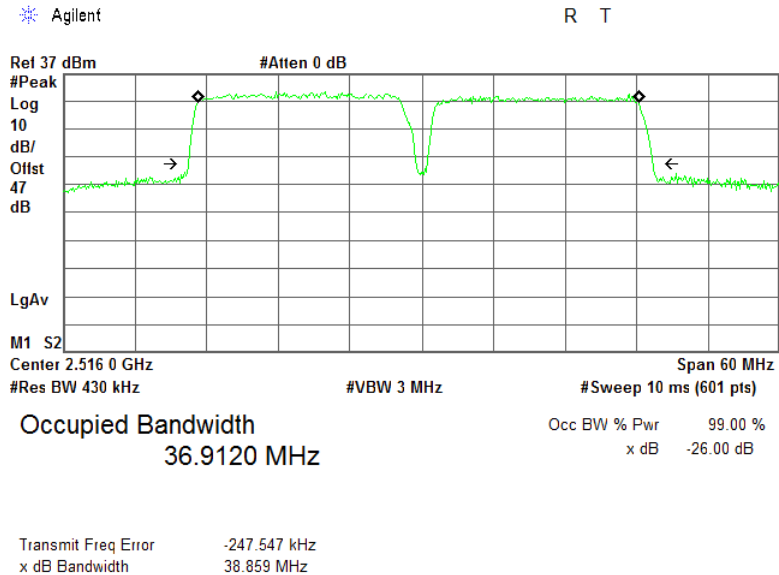



<b>Test specification:</b>		<b>Section 2.1049, Occupied bandwidth</b>	
<b>Test procedure:</b>		47 CFR, Section 2.1049	
<b>Test mode:</b>		Compliance	
<b>Date(s):</b>		08-May-16	
<b>Temperature: 23 °C</b>		<b>Air Pressure: 1015 hPa</b>	
		<b>Relative Humidity: 45 %</b>	
		<b>Power Supply: 120 VAC</b>	
<b>Remarks:</b>			
		<b>Verdict: PASS</b>	

Plot 7.1.5 Occupied bandwidth test results at mid frequency, 40 MHz EBW, 64QAM

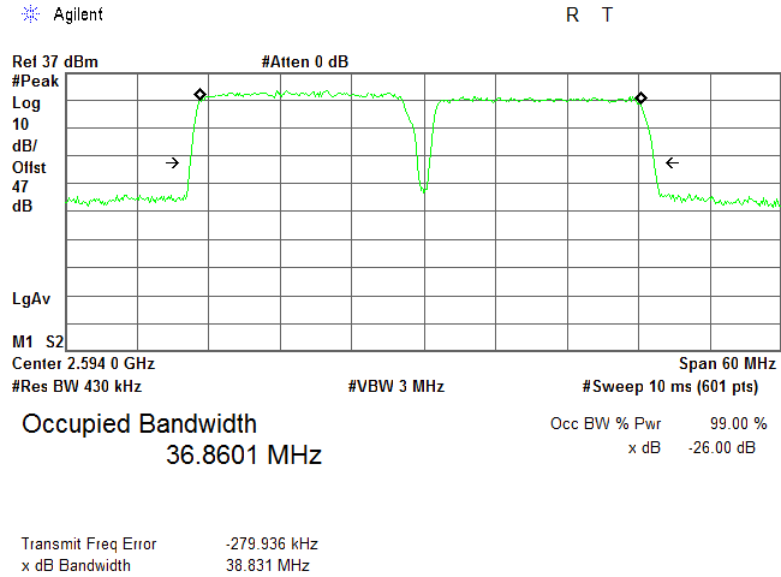

Plot 7.1.6 Occupied bandwidth test results at high frequency, 40 MHz EBW, 64QAM

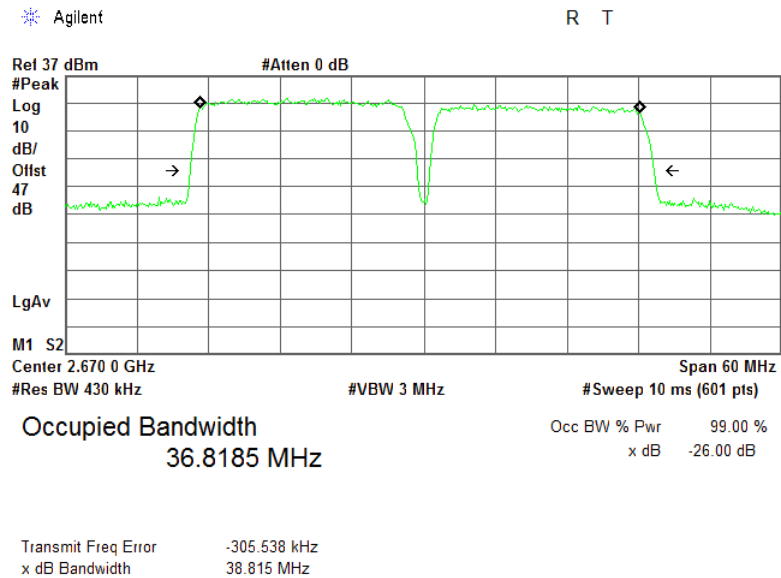



<b>Test specification:</b> Section 27.50, Peak output power			
<b>Test procedure:</b> 47 CFR, Section 2.1046; TIA/EIA-603-D, Section 2.2.1			
<b>Test mode:</b> Compliance		<b>Verdict:</b> PASS	
<b>Date(s):</b> 09-May-16			
<b>Temperature:</b> 24 °C	<b>Air Pressure:</b> 1014 hPa	<b>Relative Humidity:</b> 50 %	<b>Power Supply:</b> 120 VAC
<b>Remarks:</b>			

## 7.2 Peak output power test

### 7.2.1 General

This test was performed to measure the peak output power at RF antenna connector. Specification test limits are given in Table 7.2.1.

Table 7.2.1 Peak output power limits

Transmitter type	Assigned frequency range, MHz	Maximum peak output power dBm
Main, booster and base stations	2496 – 2690	$63+10\log(X/Y)+10\log(360/\text{beamwidth})$
		Maximum peak power density dBm/100 kHz
		$\text{EIRP}+10\log(0.1/Y)$

X is the actual channel width in MHz (occupied bandwidth)

Y is either Frequency assignment for the BRS/EBS band

Beamwidth is the total horizontal plane beam width of the individual transmitting antenna for the station or any sector measured at the half-power points.

### 7.2.2 Test procedure

7.2.2.1 The EUT was set up as shown in Figure 7.2.1, energized and its proper operation was checked.

7.2.2.2 The EUT was adjusted to produce maximum available to the end user RF output power.

7.2.2.3 The average output power was measured with power meter as provided in Table 7.2.2.

7.2.2.4 The power spectral density was measured with spectrum analyzer as provided in Table 7.2.3 and the associated plots.

7.2.2.5 The test results are provided in the tables below and associated plots.

Figure 7.2.1 Peak output power test setup

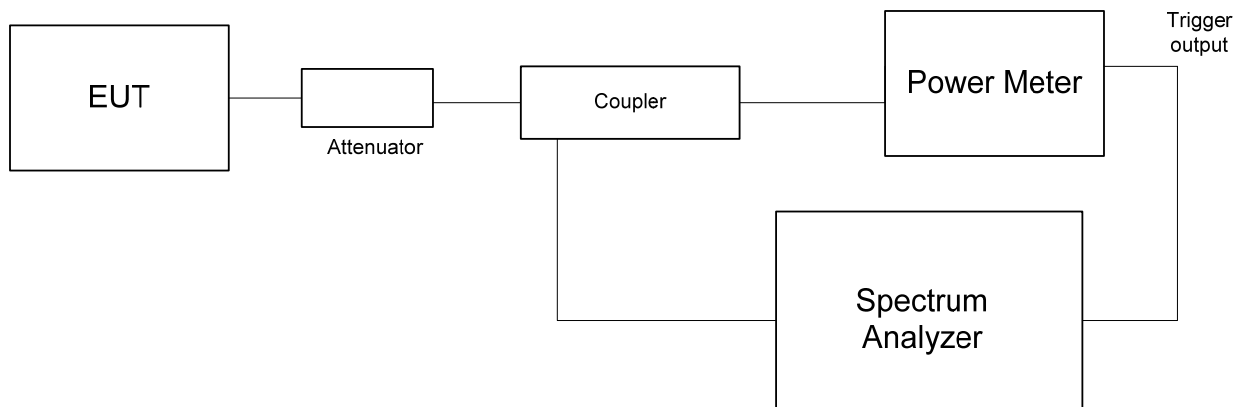



HERMON LABORATORIES

<b>Test specification:</b>		<b>Section 27.50, Peak output power</b>	
<b>Test procedure:</b>		47 CFR, Section 2.1046; TIA/EIA-603-D, Section 2.2.1	
<b>Test mode:</b>		Compliance	
<b>Date(s):</b>		09-May-16	
<b>Temperature:</b> 24 °C		<b>Air Pressure:</b> 1014 hPa	
		<b>Relative Humidity:</b> 50 %	
		<b>Power Supply:</b> 120 VAC	
<b>Remarks:</b>			

Table 7.2.2 Peak output power test results

DETECTOR USED: Average within Tx burst  
DUTY CYCLE: 75%  
EBW: 40 MHz

Carrier frequency, MHz	Power Meter reading RF#1, dBm	Power Meter reading RF#2, dBm	Total RF power**, dBm	Antenna gain, dBi	Total EIRP*, dBm	Limit***, dBm	Margin, dB	Verdict
<b>QPSK</b>								
2516	37.05	37.05	40.05	18.00	58.05	69.79	-11.74	Pass
2594	37.05	37.10	40.10	18.00	58.10	69.89	-11.79	Pass
2670	37.15	37.01	40.15	18.00	58.15	69.89	-11.74	Pass
<b>64QAM</b>								
2516	37.00	37.07	40.07	18.00	58.07	69.85	-11.78	Pass
2594	37.05	37.10	40.10	18.00	58.10	69.89	-11.79	Pass
2670	37.10	37.00	40.10	18.00	58.10	69.89	-11.79	Pass
<b>QPSK</b>								
2516	37.05	37.05	40.05	17.00	57.05	68.37	-11.32	Pass
2594	37.05	37.10	40.10	17.00	57.10	68.47	-11.37	Pass
2670	37.15	37.01	40.15	17.00	57.15	68.47	-11.32	Pass
<b>64QAM</b>								
2516	37.00	37.07	40.07	17.00	57.07	68.43	-11.36	Pass
2594	37.05	37.10	40.10	17.00	57.10	68.48	-11.38	Pass
2670	37.10	37.00	40.10	17.00	57.10	68.48	-11.38	Pass

\* - EIRP total, dBm = Total RF power\*\*, dBm + Antenna Gain, dBi

\*\* - Total RF power , dBm =P(dBm, RFmax of #1 or #2) + 3 dB

\*\*\* - See Table 7.2.5

**Reference numbers of test equipment used**

HL 2214	HL 3301	HL 3302	HL 3818	HL 3903	HL 4756		
---------	---------	---------	---------	---------	---------	--	--

Full description is given in Appendix A.



<b>Test specification:</b>		<b>Section 27.50, Peak output power</b>	
<b>Test procedure:</b>		47 CFR, Section 2.1046; TIA/EIA-603-D, Section 2.2.1	
<b>Test mode:</b>		Compliance	
<b>Date(s):</b>		09-May-16	
<b>Temperature:</b> 24 °C		<b>Air Pressure:</b> 1014 hPa	
		<b>Relative Humidity:</b> 50 %	
		<b>Power Supply:</b> 120 VAC	
<b>Remarks:</b>			

Table 7.2.3 Power spectral density test results

DETECTOR USED: Average (gated)  
 RESOLUTION BANDWIDTH: 100 kHz  
 VIDEO BANDWIDTH: 300 kHz  
 CHANNEL BANDWIDTH: 40 MHz  
 DUTY CYCLE: 75%

Carrier frequency, MHz	SA reading, RF #1 dBm/100kHz	SA reading, RF #2 dBm/100kHz	Antenna gain, dBi	Total PSD*, dBm/100kHz	Limit**, dBm	Margin, dB	Verdict
<b>QPSK</b>							
2516	15.24	16.50	18.00	37.50	43.30	-5.80	Pass
2594	15.47	16.61	18.00	37.61	43.45	-5.84	Pass
2670	14.30	14.59	18.00	35.59	43.45	-7.86	Pass
<b>64QAM</b>							
2516	16.48	16.51	18.00	37.51	43.36	-5.85	Pass
2594	16.49	16.38	18.00	37.49	43.46	-5.97	Pass
2670	15.71	16.32	18.00	37.32	43.45	-6.13	Pass
<b>QPSK</b>							
2516	15.24	16.50	17.00	36.50	41.89	-5.39	Pass
2594	15.47	16.61	17.00	36.61	42.04	-5.43	Pass
2670	14.30	14.59	17.00	34.59	42.04	-7.45	Pass
<b>64QAM</b>							
2516	16.48	16.51	17.00	36.51	41.95	-5.44	Pass
2594	16.49	16.38	17.00	36.49	42.04	-5.55	Pass
2670	15.71	16.32	17.00	36.32	42.04	-5.72	Pass

\* Total PSD, dBm/100kHz = PSD(dBm/100kHz,RFmax of #1 or #2)+ 3 dB + Antenna Gain, dBi

\*\* - See Table 7.2.6



HERMON LABORATORIES

<b>Test specification:</b>		<b>Section 27.50, Peak output power</b>	
<b>Test procedure:</b>		47 CFR, Section 2.1046; TIA/EIA-603-D, Section 2.2.1	
<b>Test mode:</b>		Compliance	
<b>Date(s):</b>		09-May-16	
<b>Temperature:</b> 24 °C		<b>Air Pressure:</b> 1014 hPa	
<b>Remarks:</b>		<b>Verdict:</b> PASS	
		<b>Relative Humidity:</b> 50 %	
		<b>Power Supply:</b> 120 VAC	

Table 7.2.4 Pre- transition frequency channels assignment

Channel	OBW, MHz	Peak power limit, dBm	Power density limit, dBm/100kHz
<b>40 MHz 4 Channels QPSK 46.8 Mbps</b>			
<b>2516.0 MHz</b> Ch.1 ,2 ,2A ,A1, B1, A2, B2, A1, B3	38.343	$63+10\log(\text{OBW}/44.5)+10\log(360/\text{beamwidth})$	$\text{EIRP}+10\log(0.1/44.5)$
<b>2594.0 MHz</b> C3 ,D3 ,C4 ,D4 ,E1 ,F1 ,E2	38.792	$63+10\log(\text{OBW}/42.0)+10\log(360/\text{beamwidth})$	$\text{EIRP}+10\log(0.1/42.0)$
<b>2670.0 MHz</b> H1 ,G2 ,H2 ,G3 ,H3 ,G4 ,1Ch	38.794	$63+10\log(\text{OBW}/44.0)+10\log(360/\text{beamwidth})$	$\text{EIRP}+10\log(0.1/44.0)$
<b>40 MHz 4 Channels 64QAM 190 Mbps</b>			
<b>2516.0 MHz</b> Ch.1 ,2 ,2A ,A1, B1, A2, B2, A1, B3	38.859	$63+10\log(\text{OBW}/44.5)+10\log(360/\text{beamwidth})$	$\text{EIRP}+10\log(0.1/44.5)$
<b>2594.0 MHz</b> C3 ,D3 ,C4 ,D4 ,E1 ,F1 ,E2	38.831	$63+10\log(\text{OBW}/42.0)+10\log(360/\text{beamwidth})$	$\text{EIRP}+10\log(0.1/42.0)$
<b>2670.0 MHz</b> H1 ,G2 ,H2 ,G3 ,H3 ,G4 ,1Ch	38.815	$63+10\log(\text{OBW}/44.0)+10\log(360/\text{beamwidth})$	$\text{EIRP}+10\log(0.1/44.0)$





HERMON LABORATORIES

<b>Test specification:</b>		<b>Section 27.50, Peak output power</b>	
<b>Test procedure:</b>		47 CFR, Section 2.1046; TIA/EIA-603-D, Section 2.2.1	
<b>Test mode:</b>		Compliance	
<b>Date(s):</b>		09-May-16	
<b>Temperature:</b> 24 °C		<b>Air Pressure:</b> 1014 hPa	
		<b>Relative Humidity:</b> 50 %	
		<b>Power Supply:</b> 120 VAC	
<b>Remarks:</b>			

Table 7.2.5 EIRP limits

Channel	Channel BW, MHz	Peak power limit, dBm	
		17 dBi, 90° beamwidth	18 dBi, 65° beamwidth
<b>40 MHz Dual Channel QPSK</b>			
<b>2516.0 MHz</b> Ch.1 ,2 ,2A ,A1, B1, A2, B2, A1, B3	44.5	68.37	69.79
<b>2594.0 MHz</b> C3 ,D3 ,C4 ,D4 ,E1 ,F1 ,E2	44.0	68.47	69.89
<b>2670.0 MHz</b> H1 ,G2 ,H2 ,G3 ,H3 ,G4 ,1Ch	44.0	68.47	69.89
<b>40 MHz Dual Channel 64 QAM</b>			
<b>2516.0 MHz</b> Ch.1 ,2 ,2A ,A1, B1, A2, B2, A1, B3	44.5	68.43	69.85
<b>2594.0 MHz</b> C3 ,D3 ,C4 ,D4 ,E1 ,F1 ,E2	44.0	68.48	69.89
<b>2670.0 MHz</b> H1 ,G2 ,H2 ,G3 ,H3 ,G4 ,1Ch	44.0	68.48	69.89



HERMON LABORATORIES

<b>Test specification:</b>		<b>Section 27.50, Peak output power</b>	
<b>Test procedure:</b>		47 CFR, Section 2.1046; TIA/EIA-603-D, Section 2.2.1	
<b>Test mode:</b>		Compliance	
<b>Date(s):</b>		09-May-16	
<b>Temperature:</b> 24 °C		<b>Air Pressure:</b> 1014 hPa	
		<b>Relative Humidity:</b> 50 %	
		<b>Power Supply:</b> 120 VAC	
<b>Remarks:</b>			

Table 7.2.6 Peak power density limits

Channel	Channel BW, MHz	Peak power density, dBm/100kHz	
		17 dBi, 90° beamwidth	18 dBi, 65° beamwidth
<b>40 MHz Dual Channel QPSK</b>			
<b>2516.0 MHz</b> Ch.1 ,2 ,2A ,A1, B1, A2, B2, A1, B3	44.50	41.89	43.30
<b>2594.0 MHz</b> C3 ,D3 ,C4 ,D4 ,E1 ,F1 ,E2	44.00	42.04	43.45
<b>2670.0 MHz</b> H1 ,G2 ,H2 ,G3 ,H3 ,G4 ,1Ch	44.00	42.04	43.45
<b>40 MHz Dual Channel 64 QAM</b>			
<b>2516.0 MHz</b> Ch.1 ,2 ,2A ,A1, B1, A2, B2, A1, B3	44.50	41.95	43.36
<b>2594.0 MHz</b> C3 ,D3 ,C4 ,D4 ,E1 ,F1 ,E2	44.00	42.04	43.46
<b>2670.0 MHz</b> H1 ,G2 ,H2 ,G3 ,H3 ,G4 ,1Ch	44.00	42.04	43.45



HERMON LABORATORIES

<b>Test specification:</b>		<b>Section 27.50, Peak output power</b>	
<b>Test procedure:</b>		47 CFR, Section 2.1046; TIA/EIA-603-D, Section 2.2.1	
<b>Test mode:</b>		<b>Verdict:</b> PASS	
<b>Date(s):</b> 09-May-16			
<b>Temperature:</b> 24 °C	<b>Air Pressure:</b> 1014 hPa	<b>Relative Humidity:</b> 50 %	<b>Power Supply:</b> 120 VAC
<b>Remarks:</b>			

Plot 7.2.1 Power spectral density test results at low frequency, QPSK, 40 MHz EBW RF # 1

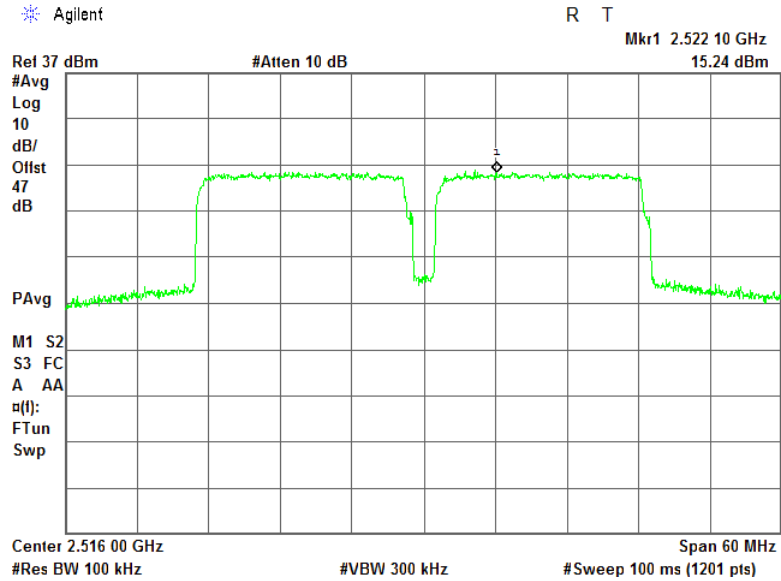

Plot 7.2.2 Power spectral density test results at mid frequency, QPSK, 40 MHz EBW RF # 1

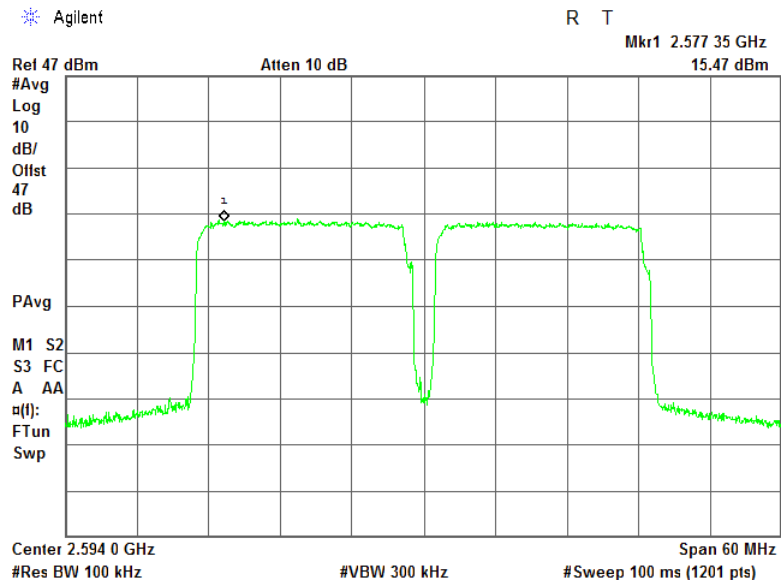



<b>Test specification:</b>		<b>Section 27.50, Peak output power</b>	
<b>Test procedure:</b>		47 CFR, Section 2.1046; TIA/EIA-603-D, Section 2.2.1	
<b>Test mode:</b>		Compliance	
<b>Date(s):</b>		09-May-16	
<b>Temperature:</b> 24 °C		<b>Air Pressure:</b> 1014 hPa	
		<b>Relative Humidity:</b> 50 %	
		<b>Power Supply:</b> 120 VAC	
<b>Remarks:</b>			
		<b>Verdict: PASS</b>	

Plot 7.2.3 Power spectral density test results at high frequency, QPSK, 40 MHz EBW RF # 1

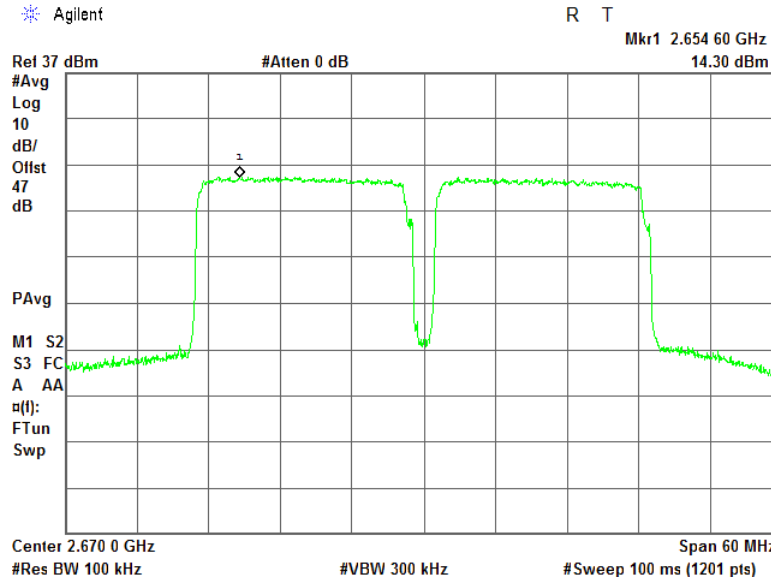

Plot 7.2.4 Power spectral density test results at low frequency, 64QAM, 40 MHz EBW RF # 1

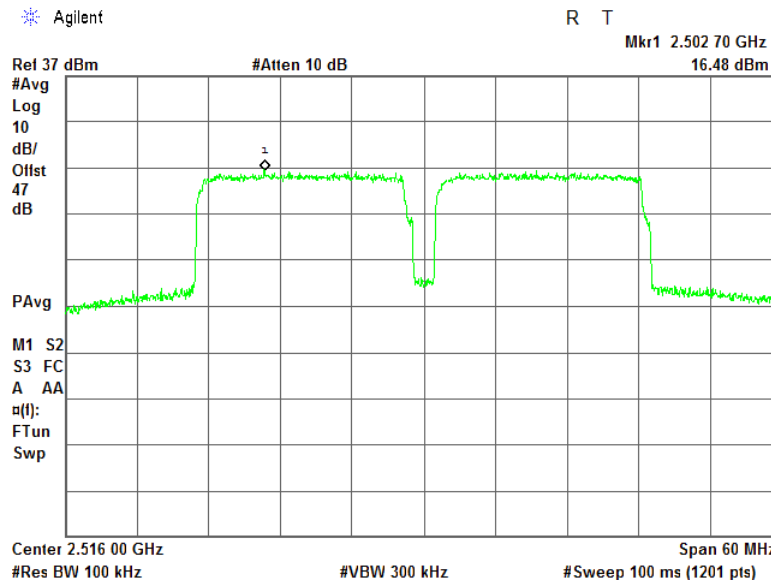



HERMON LABORATORIES

<b>Test specification:</b>		<b>Section 27.50, Peak output power</b>	
<b>Test procedure:</b>		47 CFR, Section 2.1046; TIA/EIA-603-D, Section 2.2.1	
<b>Test mode:</b>		Compliance	
<b>Date(s):</b>		09-May-16	
<b>Temperature:</b> 24 °C		<b>Air Pressure:</b> 1014 hPa	
		<b>Relative Humidity:</b> 50 %	
		<b>Power Supply:</b> 120 VAC	
<b>Remarks:</b>			
		<b>Verdict: PASS</b>	

Plot 7.2.5 Power spectral density test results at mid frequency, 64QAM, 40 MHz EBW RF # 1

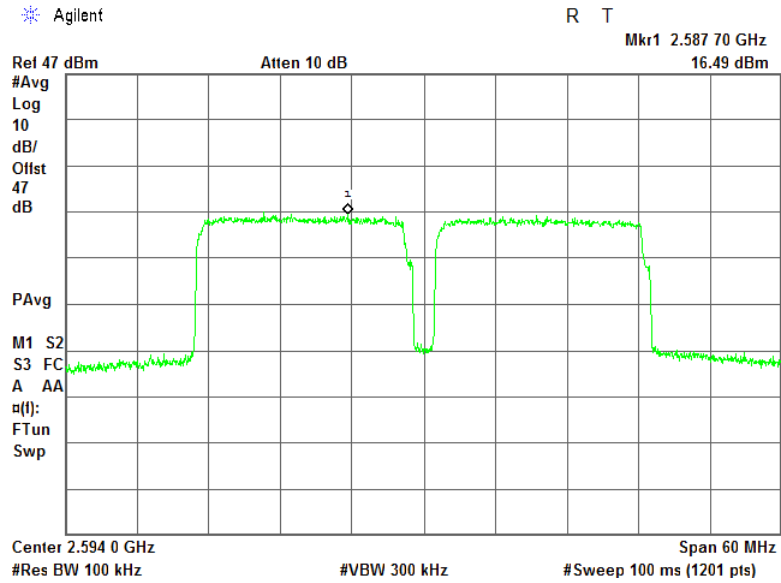

Plot 7.2.6 Power spectral density test results at high frequency, 64QAM, 40 MHz EBW RF # 1

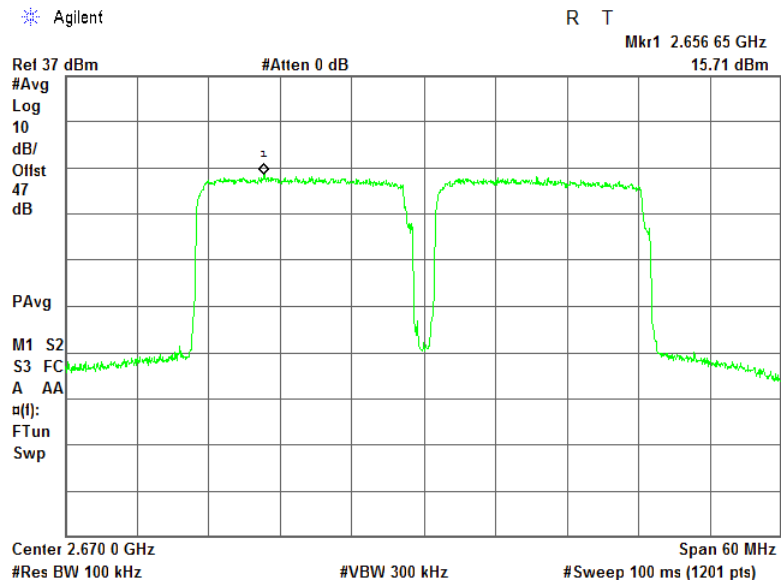



<b>Test specification:</b>	<b>Section 27.50, Peak output power</b>		
<b>Test procedure:</b>	47 CFR, Section 2.1046; TIA/EIA-603-D, Section 2.2.1		
<b>Test mode:</b>	Compliance	<b>Verdict:</b>	<b>PASS</b>
<b>Date(s):</b>	09-May-16		
<b>Temperature:</b> 24 °C	<b>Air Pressure:</b> 1014 hPa	<b>Relative Humidity:</b> 50 %	<b>Power Supply:</b> 120 VAC
<b>Remarks:</b>			

Plot 7.2.7 Power spectral density test results at low frequency, QPSK, 40 MHz EBW RF # 2

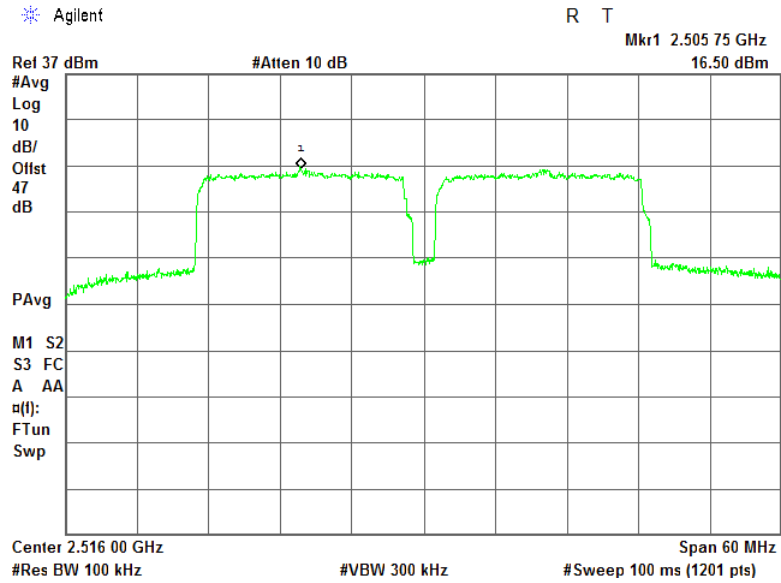

Plot 7.2.8 Power spectral density test results at mid frequency, QPSK, 40 MHz EBW RF # 2

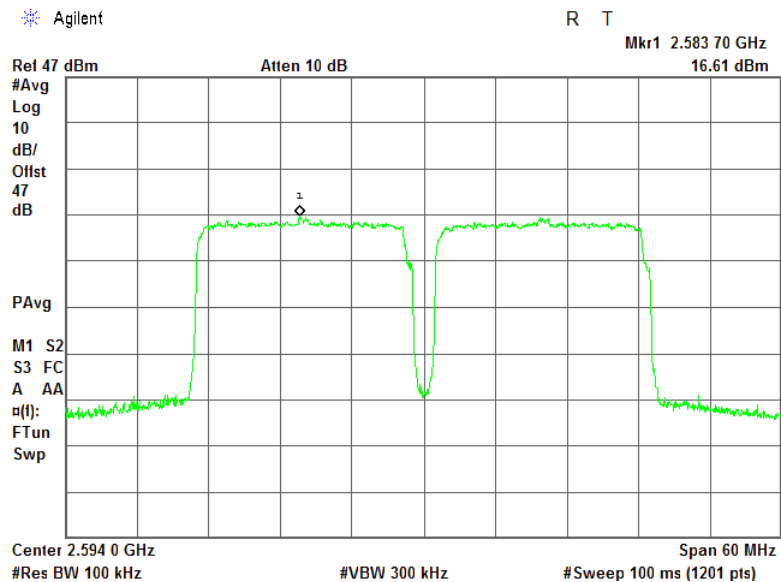



HERMON LABORATORIES

<b>Test specification:</b>		<b>Section 27.50, Peak output power</b>	
<b>Test procedure:</b>		47 CFR, Section 2.1046; TIA/EIA-603-D, Section 2.2.1	
<b>Test mode:</b>		Compliance	
<b>Date(s):</b>		09-May-16	
<b>Temperature:</b> 24 °C		<b>Air Pressure:</b> 1014 hPa	
		<b>Relative Humidity:</b> 50 %	
		<b>Power Supply:</b> 120 VAC	
<b>Remarks:</b>			
		<b>Verdict: PASS</b>	

Plot 7.2.9 Power spectral density test results at high frequency, QPSK, 40 MHz EBW RF # 2

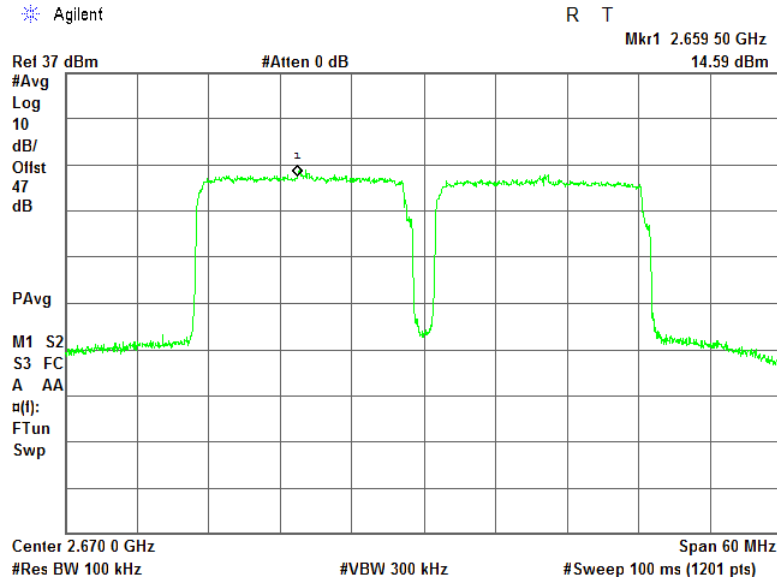

Plot 7.2.10 Power spectral density test results at low frequency, 64QAM, 40 MHz EBW RF # 2

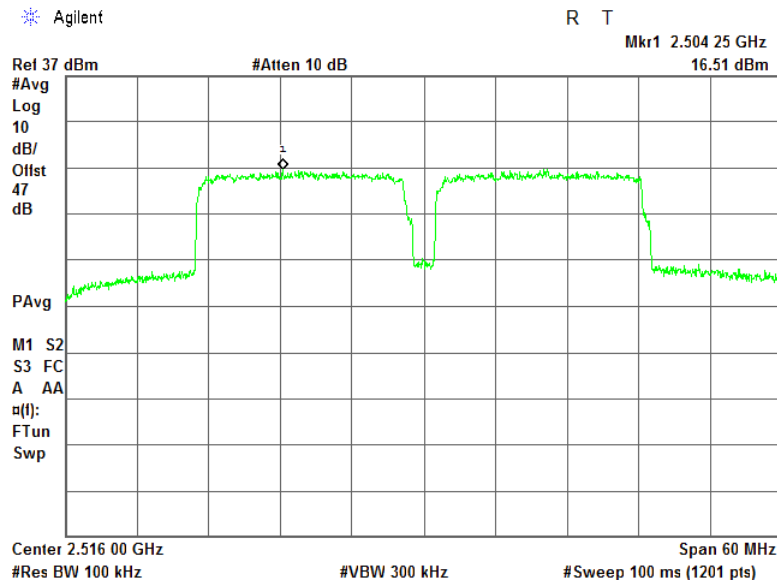



HERMON LABORATORIES

<b>Test specification:</b>		<b>Section 27.50, Peak output power</b>	
<b>Test procedure:</b>		47 CFR, Section 2.1046; TIA/EIA-603-D, Section 2.2.1	
<b>Test mode:</b>		Compliance	
<b>Date(s):</b>		09-May-16	
<b>Temperature:</b> 24 °C		<b>Air Pressure:</b> 1014 hPa	
		<b>Relative Humidity:</b> 50 %	
		<b>Power Supply:</b> 120 VAC	
<b>Remarks:</b>			
		<b>Verdict:</b> PASS	

Plot 7.2.11 Power spectral density test results at mid frequency, 64QAM, 40 MHz EBW RF # 2

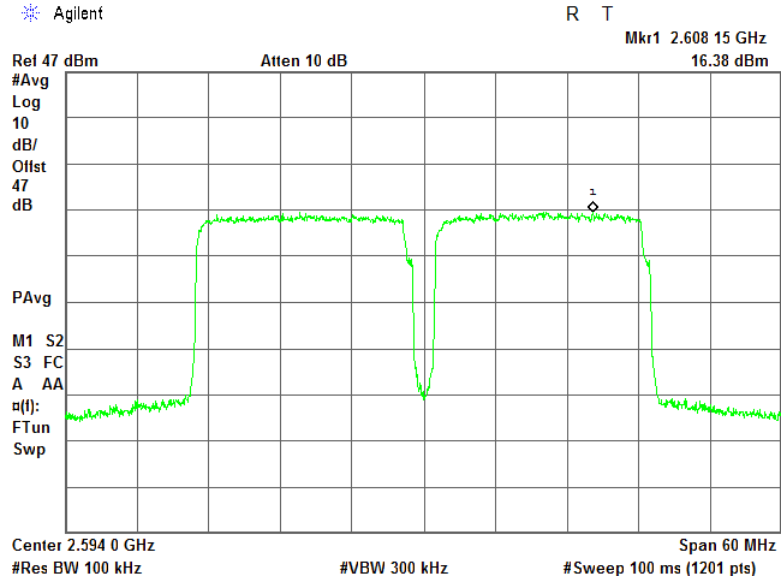

Plot 7.2.12 Power spectral density test results at high frequency, 64QAM, 40 MHz EBW RF # 2

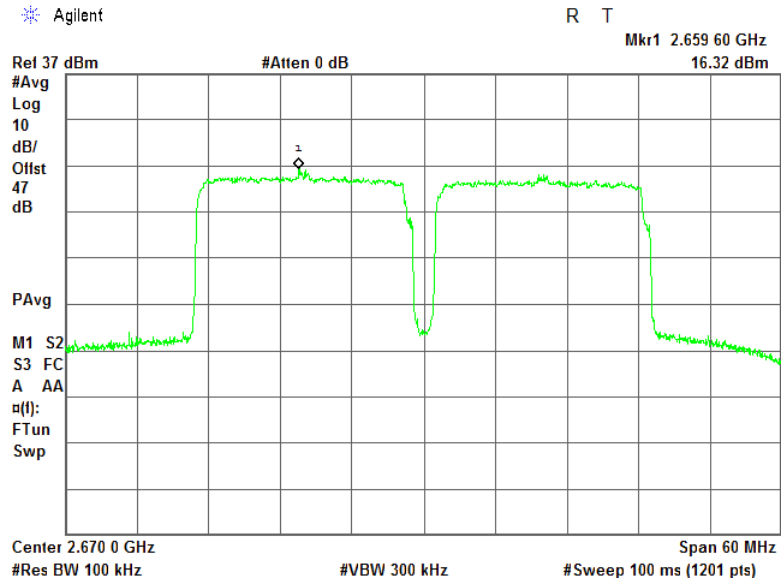





<b>Test specification:</b> Section 27.53, Band edge emissions			
<b>Test procedure:</b> 47 CFR, Sections 2.1051, 27.53; TIA/EIA-603-D, Section 2.2.13			
<b>Test mode:</b> Compliance		<b>Verdict:</b> PASS	
<b>Date(s):</b> 10-May-16			
<b>Temperature:</b> 25 °C	<b>Air Pressure:</b> 1011 hPa	<b>Relative Humidity:</b> 45 %	<b>Power Supply:</b> 120 VAC
<b>Remarks:</b>			

### 7.3 Band edge emissions at RF connector test

#### 7.3.1 General

This test was performed to measure spurious emissions at the channel edge at the RF antenna connector. Specification test limits are given in Table 7.3.1.

Table 7.3.1 Spurious emission limits at band edges

Channel	Frequency range	Attenuation below carrier, dBc	Limit, dBm
Channel bandwidth 40 MHz			
2516	2496.0 - 2502.0	43+ 10*Log (P*)	-13.0
	2502.0 - 2507.5		
	2507.5 - 2513.0		
	2513.0 - 2518.5		
	2518.5 - 2524.0		
	2524.0 - 2529.5		
	2529.5 - 2535.0		
2594	2572.0 - 2578.0	43+ 10*Log (P*)	-13.0
	2578.0 - 2584.0		
	2584.0 - 2590.0		
	2590.0 - 2596.0		
	2596.0 - 2602.0		
	2602.0 - 2608.0		
	2608.0 - 2614.0		
2670	2646.0 - 2651.5	43+ 10*Log (P*)	-13.0
	2651.5 - 2657.0		
	2657.0 - 2662.5		
	2662.5 - 2668.0		
	2668.0 - 2673.5		
	2673.5 - 2679.0		
	2679.0 - 2684.5		
2684.5 - 2690.0			

\* - P is transmitter output power in Watts

#### 7.3.2 Test procedure

7.3.2.1 The EUT was set up as shown in Figure 7.3.1, energized and its proper operation was checked.

7.3.2.2 The spurious emission was measured with spectrum analyzer as provided in Table 7.3.2, Table 7.3.3 and the associated plots.

Figure 7.3.1 Spurious emission test setup for single output

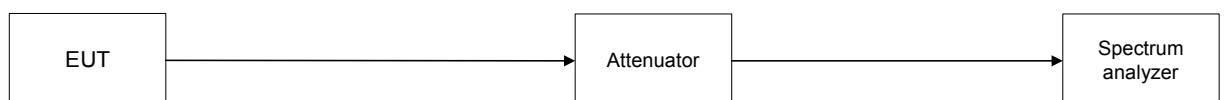



<b>Test specification:</b>		<b>Section 27.53, Band edge emissions</b>			
<b>Test procedure:</b>		47 CFR, Sections 2.1051, 27.53; TIA/EIA-603-D, Section 2.2.13			
<b>Test mode:</b>		Compliance		<b>Verdict:</b> PASS	
<b>Date(s):</b>		10-May-16			
<b>Temperature:</b> 25 °C		<b>Air Pressure:</b> 1011 hPa		<b>Relative Humidity:</b> 45 %	<b>Power Supply:</b> 120 VAC
<b>Remarks:</b>					

Table 7.3.2 Spurious emission at the low band edge test results

ASSIGNED FREQUENCY RANGE: 2496.0 – 2690.0 MHz  
DETECTOR USED: Average  
VIDEO BANDWIDTH: ≥ Resolution bandwidth  
EBW: 40 MHz

Frequency, MHz	Frequency offset, ± MHz	Low band edge, dBm	RBW, kHz	Integration BW, kHz	Limit, dBm	Margin, dBm	Verdict
<b>QPSK</b>							
2516.0	20.5	-22.55	1000	1000	-13.0	-9.55	Pass
	21.5	-23.01	1000	1000	-13.0	-10.01	
2594.0	20.5	-18.19	1000	1000	-13.0	-5.19	Pass
	21.5	-18.09	1000	1000	-13.0	-5.09	
2670.0	20.5	-17.34	1000	1000	-13.0	-4.34	Pass
	21.5	-18.13	1000	1000	-13.0	-5.13	
<b>64QAM</b>							
2516.0	20.5	-21.04	1000	1000	-13.0	-8.04	Pass
	22.5	-21.42	1000	1000	-13.0	-8.42	
2594.0	20.5	-19.38	1000	1000	-13.0	-6.38	Pass
	21.5	-19.31	1000	1000	-13.0	-6.31	
2670.0	20.5	-17.72	1000	1000	-13.0	-4.72	Pass
	21.5	-18.79	1000	1000	-13.0	-5.79	

Table 7.3.3 Spurious emission at the high band edge test results

ASSIGNED FREQUENCY RANGE: 2496.0 – 2690.0 MHz  
DETECTOR USED: Average  
VIDEO BANDWIDTH: ≥ Resolution bandwidth  
EBW: 40 MHz

Frequency MHz	Frequency offset, ± MHz	High band edge, dBm	RBW, kHz	Integration BW, kHz	Limit, dBm	Margin, dBm	Verdict
<b>QPSK</b>							
2516.0	20.5	-21.05	1000	1000	-13.0	-8.05	Pass
	21.5	-21.45	1000	1000	-13.0	-8.45	
2594.0	20.5	-17.08	1000	1000	-13.0	-4.08	Pass
	21.5	-17.51	1000	1000	-13.0	-4.51	
2670.0	20.5	-18.10	1000	1000	-13.0	-5.10	Pass
	21.5	-18.28	1000	1000	-13.0	-5.28	
<b>64QAM</b>							
2516.0	20.5	-19.24	1000	1000	-13.0	-6.24	Pass
	21.5	-19.72	1000	1000	-13.0	-6.72	
2594.0	20.5	-19.08	1000	1000	-13.0	-6.08	Pass
	21.5	-19.49	1000	1000	-13.0	-6.49	
2670.0	20.5	-17.77	1000	1000	-13.0	-4.77	Pass
	21.5	-18.04	1000	1000	-13.0	-5.04	

## Reference numbers of test equipment used

HL 2214	HL 3301	HL 3302	HL 3818	HL 3903		
---------	---------	---------	---------	---------	--	--

Full description is given in Appendix A.



HERMON LABORATORIES

<b>Test specification:</b>		<b>Section 27.53, Band edge emissions</b>	
<b>Test procedure:</b>		47 CFR, Sections 2.1051, 27.53; TIA/EIA-603-D, Section 2.2.13	
<b>Test mode:</b>		Compliance	
<b>Date(s):</b>		10-May-16	
<b>Temperature: 25 °C</b>		<b>Air Pressure: 1011 hPa</b>	
<b>Relative Humidity: 45 %</b>		<b>Power Supply: 120 VAC</b>	
<b>Remarks:</b>			
		<b>Verdict: PASS</b>	

**Plot 7.3.1 Spurious emission at band edges test results at low carrier frequency, 40 MHz EBW**

DETECTOR USED: Average  
 MODULATION: QPSK  
 MODULATING SIGNAL: PRBS  
 BIT RATE: 46.8 Mbps

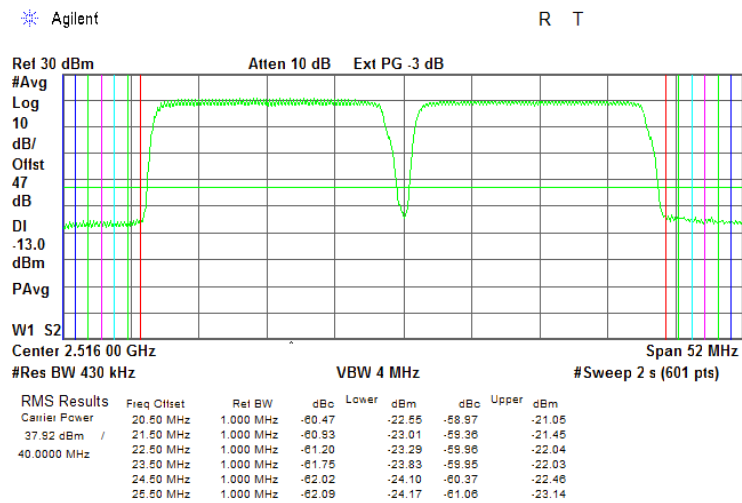

**Plot 7.3.2 Spurious emission at band edges test results at mid carrier frequency, 40 MHz EBW**

DETECTOR USED: Average  
 MODULATION: QPSK  
 MODULATING SIGNAL: PRBS  
 BIT RATE: 46.8 Mbps

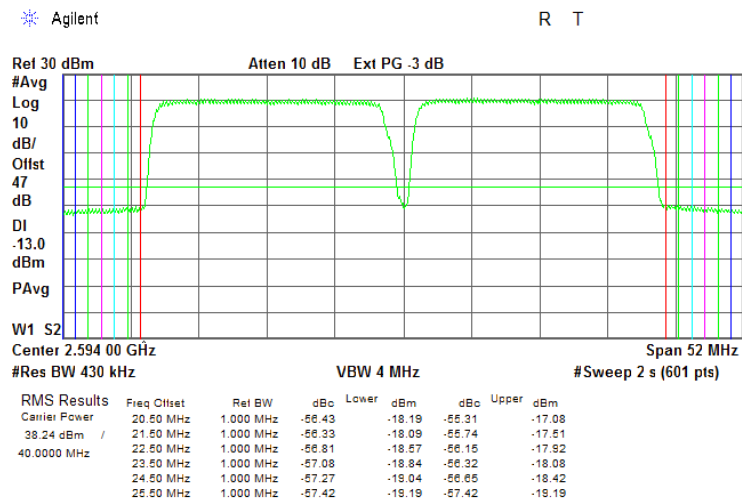



HERMON LABORATORIES

<b>Test specification:</b>		<b>Section 27.53, Band edge emissions</b>	
<b>Test procedure:</b>		47 CFR, Sections 2.1051, 27.53; TIA/EIA-603-D, Section 2.2.13	
<b>Test mode:</b>		Compliance	
<b>Date(s):</b>		10-May-16	
<b>Temperature: 25 °C</b>		<b>Air Pressure: 1011 hPa</b>	
<b>Relative Humidity: 45 %</b>		<b>Power Supply: 120 VAC</b>	
<b>Remarks:</b>			
		<b>Verdict: PASS</b>	

Plot 7.3.3 Spurious emission at band edges test results at high carrier frequency, 40 MHz EBW

DETECTOR USED: Average  
 MODULATION: QPSK  
 MODULATING SIGNAL: PRBS  
 BIT RATE: 46.8 Mbps

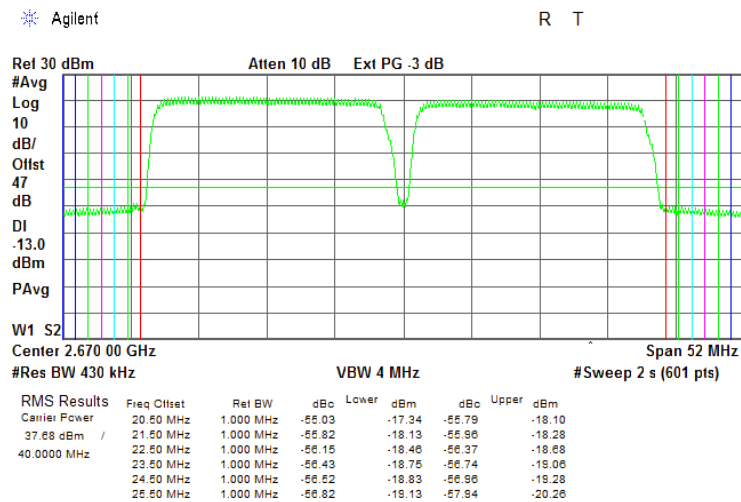

Plot 7.3.4 Spurious emission at band edges test results at low carrier frequency, 40 MHz EBW

DETECTOR USED: Average  
 MODULATION: 64QAM  
 MODULATING SIGNAL: PRBS  
 BIT RATE: 190 Mbps

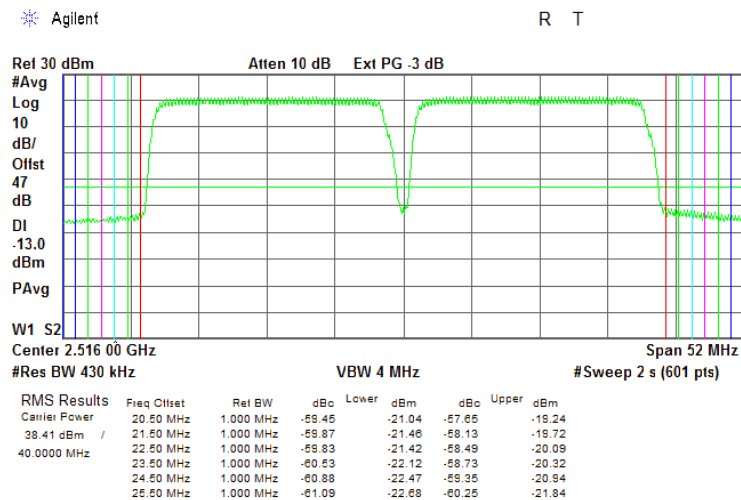



HERMON LABORATORIES

<b>Test specification:</b>		<b>Section 27.53, Band edge emissions</b>	
<b>Test procedure:</b>		47 CFR, Sections 2.1051, 27.53; TIA/EIA-603-D, Section 2.2.13	
<b>Test mode:</b>		Compliance	
<b>Date(s):</b>		10-May-16	
<b>Temperature: 25 °C</b>		<b>Air Pressure: 1011 hPa</b>	
<b>Relative Humidity: 45 %</b>		<b>Power Supply: 120 VAC</b>	
<b>Remarks:</b>			
		<b>Verdict: PASS</b>	

Plot 7.3.5 Spurious emission at band edges test results at mid carrier frequency, 40 MHz EBW

DETECTOR USED: Average  
 MODULATION: 64QAM  
 MODULATING SIGNAL: PRBS  
 BIT RATE: 190 Mbps

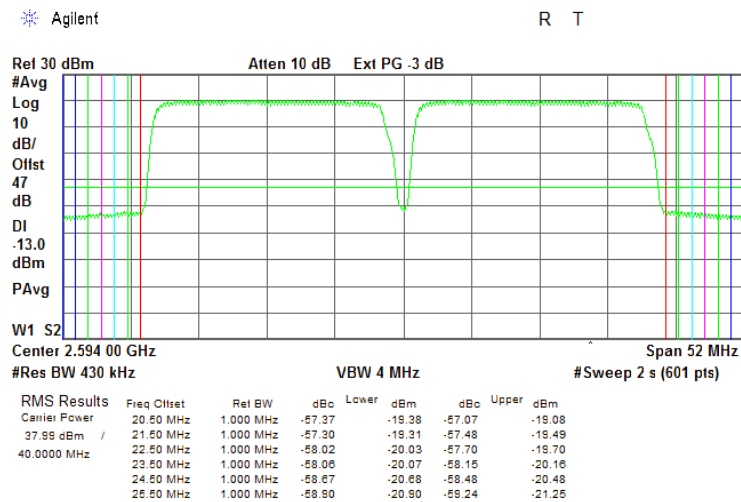

Plot 7.3.6 Spurious emission at band edges test results at high carrier frequency, 40 MHz EBW

DETECTOR USED: Average  
 MODULATION: 64QAM  
 MODULATING SIGNAL: PRBS  
 BIT RATE: 190 Mbps

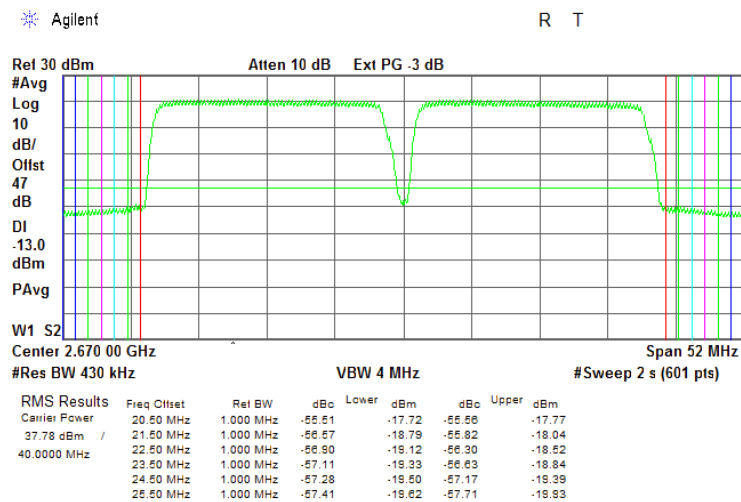



### 8 APPENDIX A Test equipment and ancillaries used for tests

HL No	Description	Manufacturer	Model	Ser. No.	Last Cal./ Check	Due Cal./ Check
2214	Directional Coupler 1.7-26.5 GHz	Krytar	2616	31354	16-Sep-15	16-Sep-17
3301	Power Meter, P-series, 50 MHz to 40 GHz	Agilent Technologies	N1911A	MY45101057	26-Apr-16	26-Jul-17
3302	Power sensor, P-Series, 50 MHz to 40 GHz, -35/30 to 20 dBm	Agilent Technologies	N1922A	MY45240586	30-Jan-15	30-Apr-16
3818	PSA Series Spectrum Analyzer, 3 Hz- 44 GHz	Agilent Technologies	E4446A	MY48250288	03-May-16	03-May-17
3903	Microwave Cable Assembly, 40.0 GHz, 1.5 m, SMA/SMA	Huber-Suhner	SUCOFLEX 102A	1226/2A	15-Feb-16	15-Feb-17

**9 APPENDIX B Measurement uncertainties****Expanded uncertainty at 95% confidence in Hermon Labs EMC measurements**

Test description	Expanded uncertainty
<b>Transmitter tests</b>	
Carrier power conducted at antenna connector	± 1.7 dB
Carrier power radiated (substitution method)	± 4.5 dB
Occupied bandwidth	±8%
Conducted emissions at RF antenna connector	9 kHz to 2.9 GHz: ± 2.6 dB 2.9 GHz to 6.46 GHz: ± 3.5 dB 6.46 GHz to 13.2 GHz: ± 4.3 dB 13.2 GHz to 22.0 GHz: ± 5.0 dB 22.0 GHz to 26.8 GHz: ± 5.5 dB 26.8 GHz to 40.0 GHz: ± 4.8 dB
Spurious emissions radiated 30 MHz – 40 GHz (substitution method)	± 4.5 dB
Frequency error	30 – 300 MHz: ± 50.5 Hz (1.68 ppm) 300 – 1000 MHz: ± 168 Hz (0.56 ppm)
Transient frequency behaviour	187 Hz ± 13.9 %
Duty cycle, timing (Tx ON / OFF) and average factor measurements	± 1.0 %

Hermon Laboratories is accredited by A2LA for calibration according to present requirements of ISO/IEC 17025 and NCSL Z540-1. The accreditation is granted to perform calibration of parameters that are listed in the Scope of Hermon Laboratories Accreditation.

Hermon Laboratories calibrates its reference and transfer standards by calibration laboratories accredited to ISO/IEC 17025 by a mutually recognized Accreditation Body or by a recognized national metrology institute. All reference and transfer standards used in the calibration system are traceable to national or international standards.

In-house calibration of all test and measurement equipment is performed on a regular basis according to Hermon Laboratories calibration procedures, manufacturer calibration/verification procedures or procedures defined in the relevant standards. The Hermon Laboratories test and measurement equipment is calibrated within the tolerances specified by the manufacturers and/or by the relevant standards.

## 10 APPENDIX C Test facility description

Tests were performed at Hermon Laboratories Ltd., which is a fully independent, private, EMC, safety, environmental and telecommunication testing facility.

Hermon Laboratories is listed by the Federal Communications Commission (USA) for all parts of Code of Federal Regulations 47 (CFR 47), Registration Numbers 90624 for OATS and 90623 for the anechoic chamber; by Industry Canada for electromagnetic emissions (file number IC 2186A-1 for OATS), certified by VCCI, Japan (the registration numbers are R-808 for OATS, R-1082 for anechoic chamber, G-27 for full-anechoic chamber for RE measurements above 1 GHz, C-845 for conducted emissions site, T-1606 for conducted emissions at telecommunication ports), has a status of a Telefication - Listed Testing Laboratory, Certificate No. L138/00. The laboratory is accredited by American Association for Laboratory Accreditation (USA) according to ISO/IEC 17025 for electromagnetic compatibility, product safety, telecommunications testing and environmental simulation (for exact scope please refer to Certificate No. 839.01). The FCC Designation Number is IL1001

Address: P.O. Box 23, Binyamina 30500, Israel.  
Telephone: +972 4628 8001  
Fax: +972 4628 8277  
e-mail: mail@hermonlabs.com  
website: www.hermonlabs.com

Person for contact: Mr. Alex Usoskin, CEO.

## 11 APPENDIX D Specification references

47CFR part 27: 2015	Private land mobile radio services
47CFR part 1: 2015	Practice and procedure
47CFR part 2: 2015	Frequency allocations and radio treaty matters; general rules and regulations
ANSI C63.2: 1996	American National Standard for Instrumentation-Electromagnetic Noise and Field Strength, 10 kHz to 40 GHz-Specifications.
ANSI C63.4: 2009	American National Standard for Methods of Measurement of Radio-Noise Emissions from Low-Voltage Electrical and Electronic Equipment in the Range of 9 kHz to 40 GHz.
ANSI/TIA/EIA-603-D:2010	Land Mobile FM or PM Communications Equipment Measurement and Performance Standards





13 APPENDIX E Test equipment correction factors

Cable loss  
Microwave Cable Assembly, Huber-Suhner, 40 GHz, 1.5 m, SMA-SMA, S/N 1226/2A  
HL 3903

Frequency, MHz	Cable loss, dB	Frequency, MHz	Cable loss, dB	Frequency, MHz	Cable loss, dB
10	-0.02	9500	1.84	21000	2.98
100	0.15	10000	1.86	22000	3.07
500	0.38	10500	1.93	23000	3.13
1000	0.56	11000	1.99	24000	3.21
1500	0.69	11500	2.04	25000	3.26
2000	0.82	12000	2.10	26000	3.48
2500	0.90	12500	2.15	27000	3.44
3000	0.98	13000	2.21	28000	3.53
3500	1.06	13500	2.25	29000	3.59
4000	1.11	14000	2.29	30000	3.66
4500	1.17	14500	2.34	31000	3.70
5000	1.24	15000	2.36	32000	3.79
5500	1.32	15500	2.40	33000	3.88
6000	1.40	16000	2.45	34000	3.94
6500	1.50	16500	2.48	35000	3.91
7000	1.56	17000	2.56	36000	4.05
7500	1.62	17500	2.58	37000	4.22
8000	1.68	18000	2.60	38000	4.25
8500	1.74	19000	2.84	39000	4.27
9000	1.78	20000	2.88	40000	4.33



## 14 APPENDIX F Abbreviations and acronyms

A	ampere
AC	alternating current
A/m	ampere per meter
AM	amplitude modulation
AVRG	average (detector)
BB	broad band
cm	centimeter
dB	decibel
dBm	decibel referred to one milliwatt
dB( $\mu$ V)	decibel referred to one microvolt
dB( $\mu$ V/m)	decibel referred to one microvolt per meter
dB( $\mu$ A)	decibel referred to one microampere
dB $\Omega$	decibel referred to one Ohm
DC	direct current
EIRP	equivalent isotropically radiated power
ERP	effective radiated power
EUT	equipment under test
F	frequency
GHz	gigahertz
GND	ground
H	height
HL	Hermon laboratories
Hz	hertz
ITE	information technology equipment
k	kilo
kHz	kilohertz
LISN	line impedance stabilization network
LO	local oscillator
m	meter
MHz	megahertz
min	minute
mm	millimeter
ms	millisecond
$\mu$ s	microsecond
NA	not applicable
NB	narrow band
NT	not tested
OATS	open area test site
$\Omega$	Ohm
QP	quasi-peak
PM	pulse modulation
PS	power supply
RE	radiated emission
RF	radio frequency
rms	root mean square
Rx	receive
s	second
T	temperature
Tx	transmit
V	volt
VA	volt-ampere

END OF DOCUMENT