

# TEST REPORT

ACCORDING TO: FCC CFR 47 PART 90 subpart Z and part 15 subpart B

FOR:

**Airspan Networks (Israel) Ltd.**

**Terminal station**

**Model: ProST 3.7 GHz TDD**

This report is in conformity with ISO/ IEC 17025. The "A2LA Accredited" symbol endorsement applies only to the tests and calibrations that are listed in the scope of Hermon Laboratories accreditation. The test results relate only to the items tested. This test report shall not be reproduced in any form except in full with the written approval of Hermon Laboratories Ltd.

## Table of contents

1	Applicant information.....	3
2	Equipment under test attributes .....	3
3	Manufacturer information .....	3
4	Test details.....	3
5	Tests summary.....	4
6	EUT description.....	5
6.1	General information.....	5
6.2	Ports and lines .....	5
6.3	Support and test equipment .....	5
6.4	Operating frequencies .....	5
6.5	Changes made in the EUT .....	5
6.6	Transmitter characteristics .....	6
6.7	Test configuration.....	7
7	Transmitter tests according to 47CFR part 90 requirements.....	8
7.1	Peak output power and power spectral density tests .....	8
7.2	Occupied bandwidth test.....	25
7.3	Emission mask test .....	36
7.4	Spurious emissions at RF antenna connector test.....	49
7.5	Radiated spurious emission measurements.....	62
7.6	Frequency stability test.....	80
8	Unintentional radiation tests according to 47CFR part 15 subpart B requirements .....	82
8.1	Conducted emissions.....	82
8.2	Radiated emission measurements .....	87
9	APPENDIX A Test equipment and ancillaries used for tests.....	90
10	APPENDIX B Measurement uncertainties.....	92
11	APPENDIX C Test facility description .....	93
12	APPENDIX D Specification references .....	93
13	APPENDIX E Test equipment correction factors.....	94
14	APPENDIX F Abbreviations and acronyms.....	105

## 1 Applicant information

**Client name:** Airspan Networks (Israel) Ltd.  
**Address:** 1, Harava street, "Unitronics" building, POB 199, Airport City, 70100, Israel  
**Telephone:** +972 3977 7444  
**Fax:** +972 3977 7400  
**E-mail:** zlevi@Airspan.com  
**Contact name:** Mr. Zion Levi

## 2 Equipment under test attributes

**Product name:** Terminal station  
**Product type:** Transceiver  
**Model(s):** ProST 3.7 GHz TDD  
**Receipt date:** 12/26/2007

## 3 Manufacturer information

**Manufacturer name:** Airspan Networks (Israel) Ltd.  
**Address:** 1, Harava street, "Unitronics" building, POB 199, Airport City, 70100, Israel  
**Telephone:** +972 3977 7444  
**Fax:** +972 3977 7400  
**E-Mail:** zlevi@Airspan.com  
**Contact name:** Mr. Zion Levi

## 4 Test details



**Project ID:** 18413  
**Location:** Hermon Laboratories Ltd. P.O.Box 23, Binyamina 30500, Israel  
**Test started:** 12/26/2007  
**Test completed:** 4/02/2008  
**Test specification(s):** 47CFR part 90 subpart Z; part 15 subpart B, class B

## 5 Tests summary

Test	Status
<b>Transmitter characteristics</b>	
Section 90.205, 90.1321 Maximum output power and peak power spectral density	Pass
Section 90.209, Occupied bandwidth	Pass
Section 90.210 (b), Emission mask	Pass
Section 90.1323, Conducted spurious emissions	Pass
Section 90.1323, Radiated spurious emissions	Pass
Section 90.213, Frequency stability	Pass
Section 2.1091, 90.1335, RF radiation exposure evaluation	Pass, exhibit attached to the Application for certification
<b>Unintentional emissions</b>	
Section 15.107, Conducted emission at AC power port	Pass
Section 15.109, Radiated emission	Pass

The results obtained indicate that the product under test complies in full with the requirements tested. The test results relate only to the items tested. Pass/ fail decision was based on nominal values.

This test report replaces the previously issued test report identified by Doc ID: AIRRAD\_FCC.18413\_rev1

	Name and Title	Date	Signature
<b>Tested by:</b>	Mr. S. Samokha, test engineer	April 2, 2008	
<b>Reviewed by:</b>	Mrs. M. Cherniavsky, certification engineer	April 3, 2008	
<b>Approved by:</b>	Mr. M. Nikishin, EMC and Radio group leader	April 3, 2008	

## 6 EUT description

### 6.1 General information

The EUT, subscriber premises radio, ProST 3.7GHz TDD Int., is part of a WiMAX broadband fixed cellular wireless access system. The system provides a radio link between an end-user (a subscriber) and a network to give high-speed data access. The ProST's transceiver/receiver (up to 64QAM modulation, data rate up to 37 Mbps) uses OFDM and operating in TDD duplexing mode.

### 6.2 Ports and lines

Port type	Port description	Connected		Connector type	Qty.	Cable type	Cable length
		From	To				
Signal	48 V DC & Ethernet	EUT	SDA	D-type 15 pin	1	unshielded	10 m
Signal	RS232	EUT	Laptop	D-type 9 pin	1	unshielded	0.2 m
RF	Antenna	EUT	50 Ohm termination	N-type	1	NA	NA

### 6.3 Support and test equipment

Description	Manufacturer	Model number	Serial number
Laptop	Dell	PPx	4898T
Adapter to laptop	Dell	AA20031	93640
SDA-4S/VL type 2	Airspan	09200026B1	753D6A008G

### 6.4 Operating frequencies

Source	Frequency, MHz
Transmitter	3650 – 3700

### 6.5 Changes made in the EUT

No changes were implemented.

## 6.6 Transmitter characteristics

<b>Type of equipment</b>						
<input checked="" type="checkbox"/>	Stand-alone (Equipment with or without its own control provisions)					
	Combined equipment (Equipment where the radio part is fully integrated within another type of equipment)					
	Plug-in card (Equipment intended for a variety of host systems)					
<b>Intended use</b>		<b>Condition of use</b>				
<input checked="" type="checkbox"/>	fixed	Always at a distance more than 2 m from all people				
	mobile	Always at a distance more than 20 cm from all people				
	portable	May operate at a distance closer than 20 cm to human body				
<b>Assigned frequency range</b>		3650 – 3700 MHz				
<b>Operating frequency range</b>		3655 – 3695 MHz				
<b>RF channel spacing</b>		5 MHz				
<b>Maximum rated output power</b>		At transmitter 50 $\Omega$ RF output connector		23.8 dBm		
<b>Is transmitter output power variable?</b>		No				
		continuous variable				
		<input checked="" type="checkbox"/>	Yes	stepped variable with stepsize		1 dB
		minimum RF power		-30 dBm		
		maximum RF power		23.8 dBm		
<b>Antenna connection</b>						
unique coupling		standard connector		<input checked="" type="checkbox"/>	Integral	
				<input checked="" type="checkbox"/>	with temporary RF connector without temporary RF connector	
<b>Antenna/s technical characteristics</b>						
Type	Manufacturer	Model number		Gain		
Internal	MARS	MA-WA36-AS16		16 dBi		
<b>Transmitter 99% power bandwidth</b>		5 MHz, 10 MHz				
<b>Transmitter aggregate data rate/s</b>		5 MHz BW: BPSK – 2.095 MBps, QPSK - 4.19 MBps, 16QAM – 12.565 MBps, 64QAM – 18.85 MBps				
		10 MHz BW: BPSK - 4.19 MBps, QPSK-8.38 MBps, 16QAM - 25.13 MBps, 64QAM - 37.7 MBps				
<b>Type of modulation</b>		BPSK, QPSK, 16QAM, 64QAM				
<b>Type of multiplexing</b>		OFDM				
<b>Modulating test signal (baseband)</b>		PRBS				
<b>Maximum transmitter duty cycle in normal use</b>		90%				
<b>Transmitter power source</b>						
		<b>Nominal rated voltage</b>		Battery type		
	DC	<b>Nominal rated voltage</b>				
<input checked="" type="checkbox"/>	AC mains	<b>Nominal rated voltage</b>		120 V	Frequency 60 Hz	
<b>Common power source for transmitter and receiver</b>				<input checked="" type="checkbox"/>	yes	
					no	

## 6.7 Test configuration

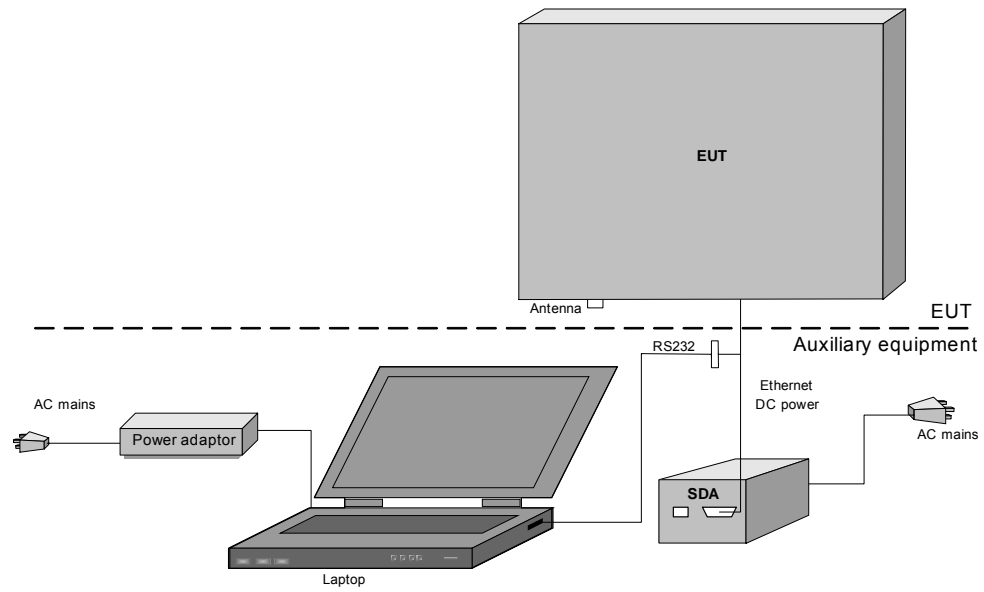

<b>Test specification:</b>		<b>Section 90.1321, Maximum output power</b>	
<b>Test procedure:</b>		47 CFR, Section 2.1046; TIA/EIA-603-C, Section 2.2.1	
<b>Test mode:</b>	Compliance	<b>Verdict:</b>	PASS
<b>Date:</b>	12/30/2007		
<b>Temperature:</b> 24°C	<b>Air Pressure:</b> 1018 hPa	<b>Relative Humidity:</b> 36%	<b>Power Supply:</b> 120 V AC
<b>Remarks:</b>			

## 7 Transmitter tests according to 47CFR part 90 requirements

### 7.1 Peak output power and power spectral density tests

#### 7.1.1 General

This test was performed to measure the peak output power and power spectral density at RF antenna connector. Specification test limits are given in Table 7.1.1.

**Table 7.1.1 Peak output power and spectral density limits**

Assigned frequency range, MHz	Channel bandwidth, MHz	Maximum peak output power		Power spectral density, dBm/MHz
		W	dBm	
3650.0 – 3700.0	5	5	37.0	30.0
	10	10	40.0	

#### 7.1.2 Test procedure

**7.1.2.1** The EUT was set up as shown in Figure 7.1.1, energized and its proper operation was checked.

**7.1.2.2** The EUT was adjusted to produce maximum available to the end user RF output power.

**7.1.2.3** The peak output power was measured with power meter as provided in Table 7.1.2, Table 7.1.4, and associated plots. The power spectral density was measured with power meter as provided in Table 7.1.3, Table 7.1.5 and associated plots.

**Figure 7.1.1 Peak output power test setup**

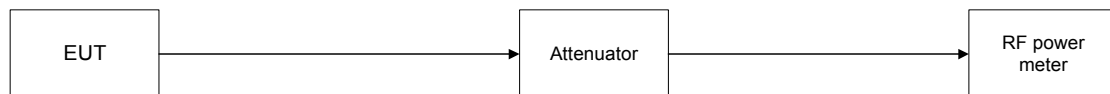



<b>Test specification:</b>		<b>Section 90.1321, Maximum output power</b>	
<b>Test procedure:</b>		47 CFR, Section 2.1046; TIA/EIA-603-C, Section 2.2.1	
<b>Test mode:</b>	Compliance	<b>Verdict: PASS</b>	
<b>Date:</b>	4/02/2008		
<b>Temperature:</b> 24°C	<b>Air Pressure:</b> 1012 hPa	<b>Relative Humidity:</b> 42%	<b>Power Supply:</b> 120 V AC
<b>Remarks:</b> 5 MHz CBW			

Table 7.1.2 Peak output power test results for 5 MHz channel bandwidth

ASSIGNED FREQUENCY RANGE: 3650.0 – 3700.0 MHz  
 DETECTOR USED: Power meter  
 MODULATION: BPSK, QPSK, 16QAM, 64QAM  
 MODULATING SIGNAL: PRBS  
 TRANSMITTER OUTPUT POWER SETTINGS: Maximum

Carrier frequency, MHz	Power meter reading, dBm	External attenuation, dB	Cable loss dB	RF output power*, dBm	Limit, dBm	Margin, dB	Verdict
<b>64QAM, Bit Rate: 18.85 Mbps</b>							
3655.0	19.14	included	included	35.14	37.00	-1.86	Pass
3675.0	19.00	included	included	35.00	37.00	-2.00	Pass
3695.0	18.79	included	included	34.79	37.00	-2.21	Pass
<b>16QAM, Bit Rate :12.565Mbps</b>							
3655.0	19.16	included	included	35.16	37.00	-1.84	Pass
3675.0	18.73	included	included	34.73	37.00	-2.27	Pass
3695.0	18.41	included	included	34.41	37.00	-2.59	Pass
<b>QPSK, Bit Rate: 4.19 Mbps</b>							
3655.0	18.94	included	included	34.94	37.00	-2.06	Pass
3675.0	18.60	included	included	34.60	37.00	-2.40	Pass
3695.0	18.30	included	included	34.30	37.00	-2.70	Pass
<b>BPSK, Bit Rate: 2.095Mbps</b>							
3655.0	18.92	included	included	34.92	37.00	-2.08	Pass
3675.0	18.60	included	included	34.60	37.00	-2.40	Pass
3695.0	18.25	included	included	34.25	37.00	-2.75	Pass

\* - RF Output Power = Power Meter Reading + Antenna Gain (16 dBi)

Reference numbers of test equipment used

HL 2909	HL 2951	HL 3301	HL 3439				
---------	---------	---------	---------	--	--	--	--

Full description is given in Appendix A.

<b>Test specification:</b>		<b>Section 90.1321, Maximum output power</b>	
<b>Test procedure:</b>		47 CFR, Section 2.1046; TIA/EIA-603-C, Section 2.2.1	
<b>Test mode:</b>	Compliance	<b>Verdict:</b>	<b>PASS</b>
<b>Date:</b>	4/02/2008		
<b>Temperature:</b> 24°C	<b>Air Pressure:</b> 1012 hPa	<b>Relative Humidity:</b> 42%	<b>Power Supply:</b> 120 V AC
<b>Remarks:</b> 5 MHz CBW			

**Table 7.1.3 Power spectral density test results for 5 MHz channel bandwidth**

ASSIGNED FREQUENCY RANGE: 3650.0 – 3700.0 MHz  
DETECTOR USED: Peak  
RESOLUTION BANDWIDTH: 1000 kHz  
VIDEO BANDWIDTH: 3000 kHz  
MODULATION: BPSK, 4QAM, 16QAM, 64QAM  
MODULATING SIGNAL: PRBS  
TRANSMITTER OUTPUT POWER SETTINGS: Maximum

Carrier frequency, MHz	Spectrum analyzer reading, dBm/Hz	Attenuation, dB	Cable loss dB	Power density*, dBm/MHz	Limit, dBm/MHz	Margin, dB	Verdict
<b>64QAM, Bit Rate: 18.85 Mbps</b>							
3655.0	13.73	included	included	29.73	30.0	-0.27	Pass
3675.0	13.77	included	included	29.77	30.0	-0.23	Pass
3695.0	13.10	included	included	29.10	30.0	-0.90	Pass
<b>16QAM, Bit Rate: 12.565 Mbps</b>							
3655.0	13.96	included	included	29.96	30.0	-0.04	Pass
3675.0	13.40	included	included	29.40	30.0	-0.60	Pass
3695.0	13.20	included	included	29.20	30.0	-0.80	Pass
<b>QPSK, Bit Rate: 4.19 Mbps</b>							
3655.0	13.62	included	included	29.62	30.0	-0.38	Pass
3675.0	13.41	included	included	29.41	30.0	-0.59	Pass
3695.0	13.05	included	included	29.05	30.0	-0.95	Pass
<b>BPSK, Bit Rate: 2.095 Mbps</b>							
3655.0	13.62	included	included	29.62	30.0	-0.38	Pass
3675.0	13.36	included	included	29.36	30.0	-0.64	Pass
3695.0	13.00	included	included	29.00	30.0	-1.00	Pass

\* - Power density = Spectrum analyzer reading + Antenna Gain (16 dBi)

Note: Additional alternative measurement settings used for peak power spectral density at low and high carrier frequencies at minimum and maximum data rates

**Reference numbers of test equipment used**

HL 2909	HL 2951	HL 3301	HL 3439				
---------	---------	---------	---------	--	--	--	--

Full description is given in Appendix A.

<b>Test specification:</b>	<b>Section 90.1321, Maximum output power</b>		
<b>Test procedure:</b>	47 CFR, Section 2.1046; TIA/EIA-603-C, Section 2.2.1		
<b>Test mode:</b>	Compliance	<b>Verdict:</b>	<b>PASS</b>
<b>Date:</b>	4/02/2008		
<b>Temperature:</b> 24°C	<b>Air Pressure:</b> 1012 hPa	<b>Relative Humidity:</b> 42%	<b>Power Supply:</b> 120 V AC
<b>Remarks:</b> 5 MHz CBW			

Plot 7.1.1 Peak output power density test results at low frequency, 64QAM, Bit Rate: 18.85 Mbps

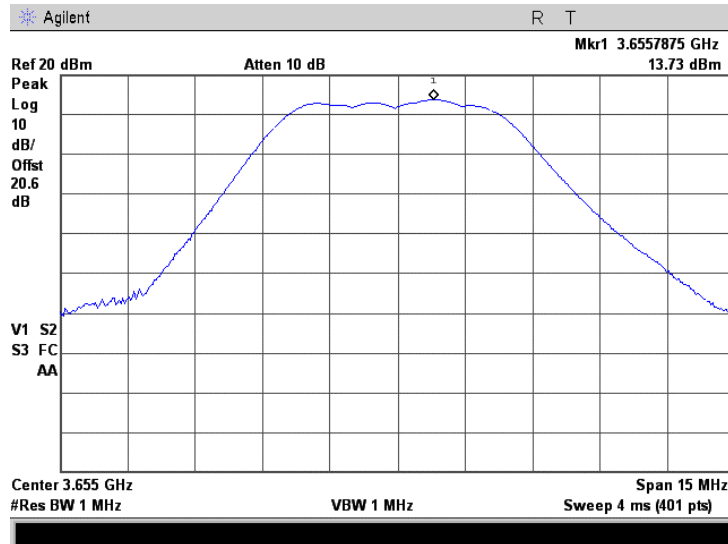

Plot 7.1.2 Peak output power density test results at mid frequency, 64QAM, Bit Rate: 18.85 Mbps

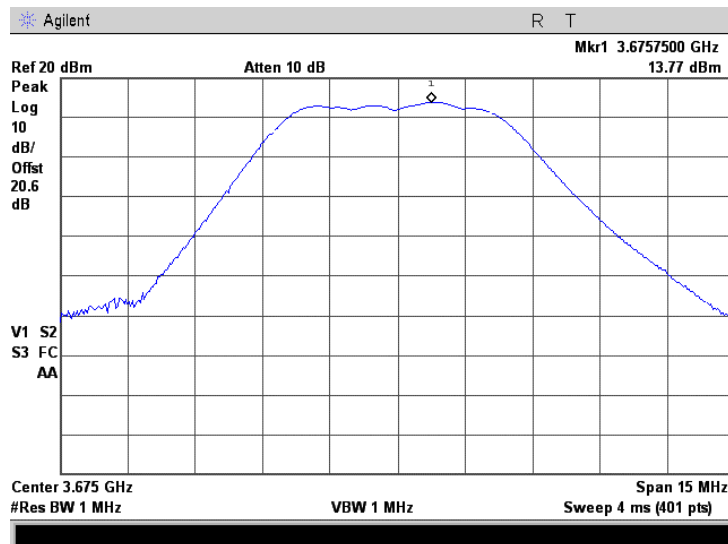

<b>Test specification:</b>		<b>Section 90.1321, Maximum output power</b>	
<b>Test procedure:</b>		47 CFR, Section 2.1046; TIA/EIA-603-C, Section 2.2.1	
<b>Test mode:</b>	Compliance	<b>Verdict:</b>	PASS
<b>Date:</b>	4/02/2008		
<b>Temperature:</b> 24°C	<b>Air Pressure:</b> 1012 hPa	<b>Relative Humidity:</b> 42%	<b>Power Supply:</b> 120 V AC
<b>Remarks:</b> 5 MHz CBW			

Plot 7.1.3 Peak output power density test results at high frequency, 64QAM Bit Rate: 18.85 Mbps

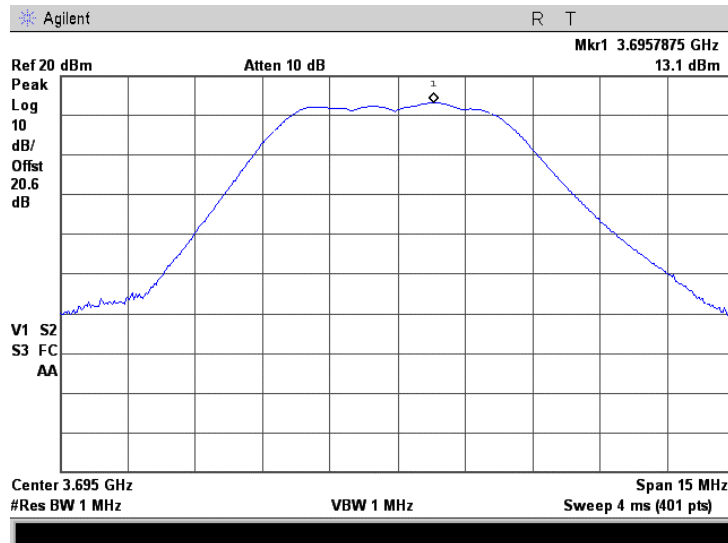

Plot 7.1.4 Peak output power density test results at low frequency, 16QAM Bit Rate: 2.565 Mbps

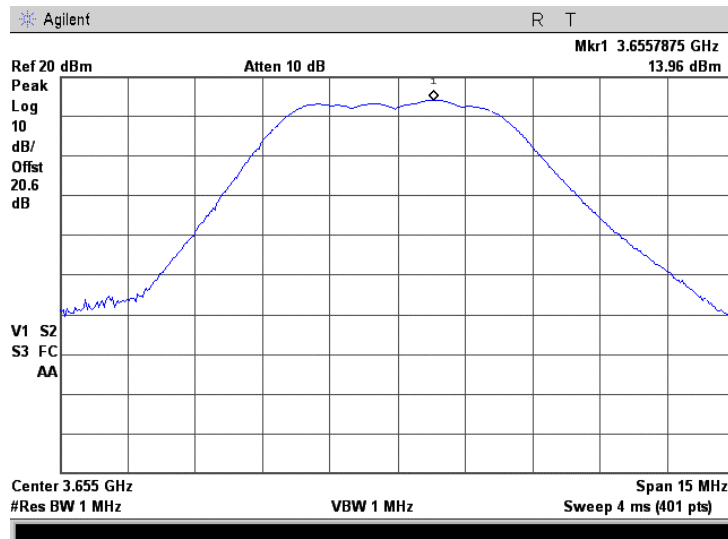

<b>Test specification:</b>	<b>Section 90.1321, Maximum output power</b>		
<b>Test procedure:</b>	47 CFR, Section 2.1046; TIA/EIA-603-C, Section 2.2.1		
<b>Test mode:</b>	Compliance	<b>Verdict:</b>	<b>PASS</b>
<b>Date:</b>	4/02/2008		
<b>Temperature:</b> 24°C	<b>Air Pressure:</b> 1012 hPa	<b>Relative Humidity:</b> 42%	<b>Power Supply:</b> 120 V AC
<b>Remarks:</b> 5 MHz CBW			

Plot 7.1.5 Peak output power density test results at mid frequency, 16QAM Bit Rate: 12.565 Mbps

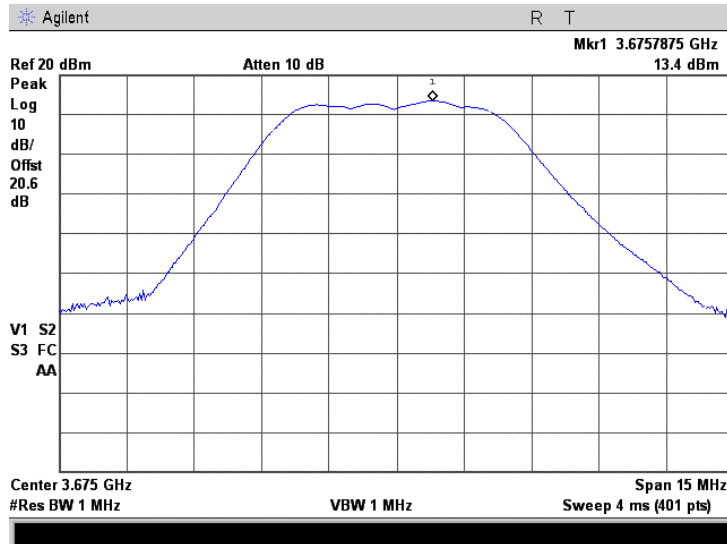

Plot 7.1.6 Peak output power density test results at high frequency, 16QAM Bit Rate: 12.565 Mbps

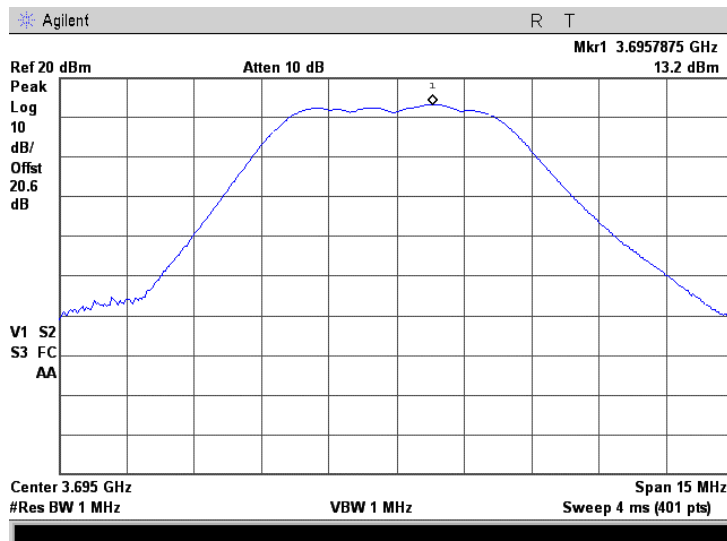

<b>Test specification:</b>		<b>Section 90.1321, Maximum output power</b>	
<b>Test procedure:</b>		47 CFR, Section 2.1046; TIA/EIA-603-C, Section 2.2.1	
<b>Test mode:</b>	Compliance	<b>Verdict:</b>	PASS
<b>Date:</b>	4/02/2008		
<b>Temperature:</b> 24°C	<b>Air Pressure:</b> 1012 hPa	<b>Relative Humidity:</b> 42%	<b>Power Supply:</b> 120 V AC
<b>Remarks:</b> 5 MHz CBW			

Plot 7.1.7 Peak output power density test results at low frequency, QPSK Bit Rate: 4.19 Mbps

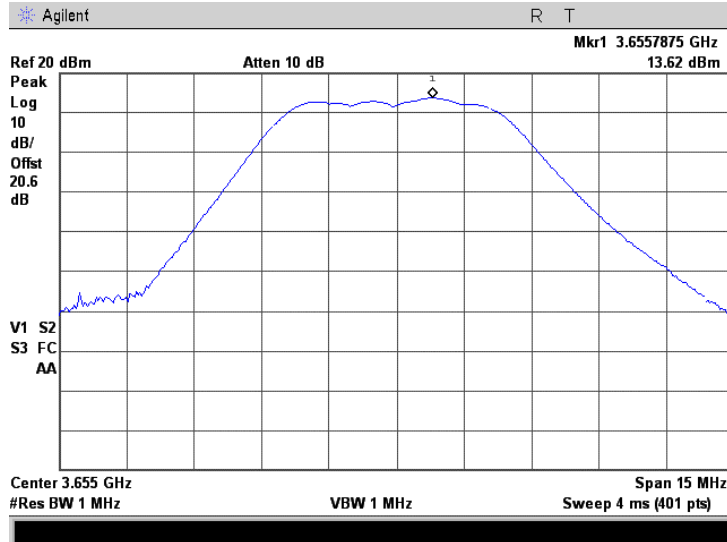

Plot 7.1.8 Peak output power density test results at mid frequency, QPSK Bit Rate: 4.19 Mbps

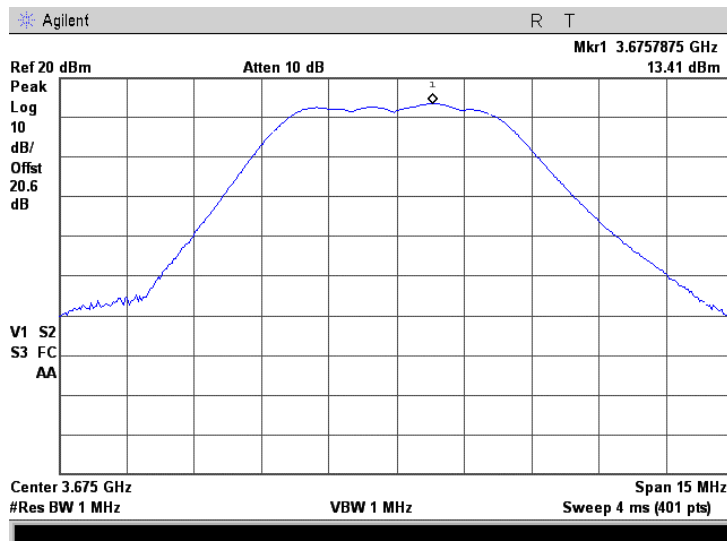

<b>Test specification:</b>		<b>Section 90.1321, Maximum output power</b>	
<b>Test procedure:</b>		47 CFR, Section 2.1046; TIA/EIA-603-C, Section 2.2.1	
<b>Test mode:</b>	Compliance	<b>Verdict:</b>	PASS
<b>Date:</b>	4/02/2008		
<b>Temperature:</b> 24°C	<b>Air Pressure:</b> 1012 hPa	<b>Relative Humidity:</b> 42%	<b>Power Supply:</b> 120 V AC
<b>Remarks:</b> 5 MHz CBW			

Plot 7.1.9 Peak output power density test results at high frequency, QPSK Bit Rate: 4.19 Mbps

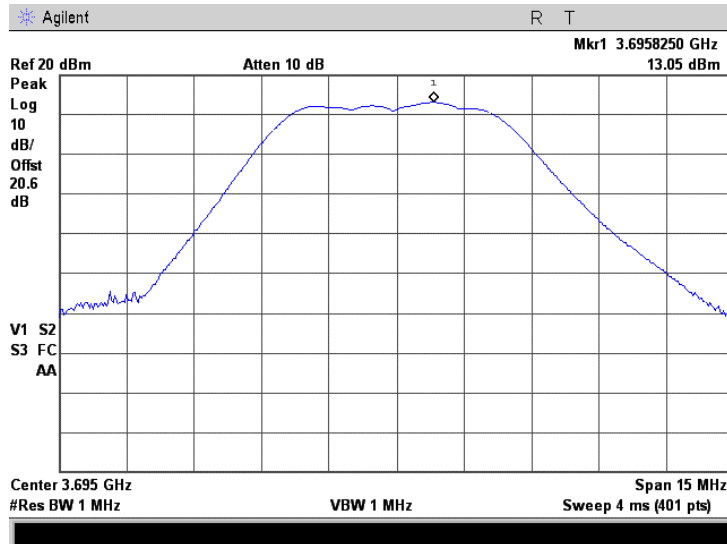

Plot 7.1.10 Peak output power density test results at low frequency, BPSK, Bit Rate: 2.095 Mbps

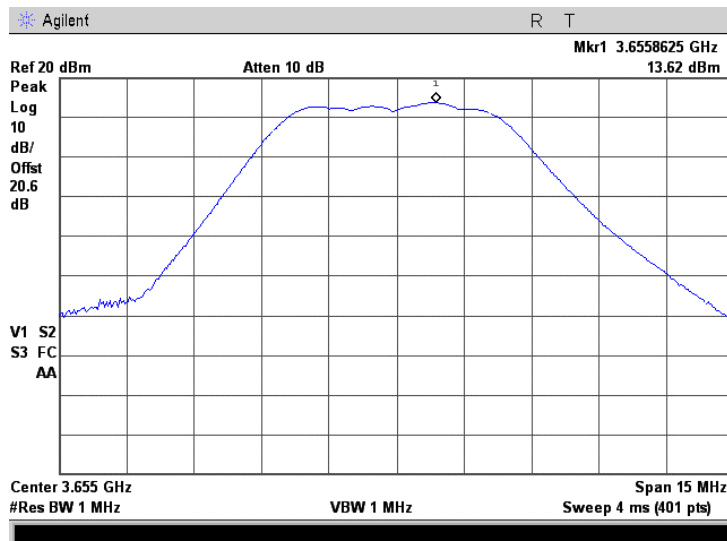

<b>Test specification:</b>	<b>Section 90.1321, Maximum output power</b>		
<b>Test procedure:</b>	47 CFR, Section 2.1046; TIA/EIA-603-C, Section 2.2.1		
<b>Test mode:</b>	Compliance	<b>Verdict:</b>	<b>PASS</b>
<b>Date:</b>	4/02/2008		
<b>Temperature:</b> 24°C	<b>Air Pressure:</b> 1012 hPa	<b>Relative Humidity:</b> 42%	<b>Power Supply:</b> 120 V AC
<b>Remarks:</b> 5 MHz CBW			

Plot 7.1.11 Peak output power density test results at mid frequency, BPSK Bit Rate: 2.095 Mbps

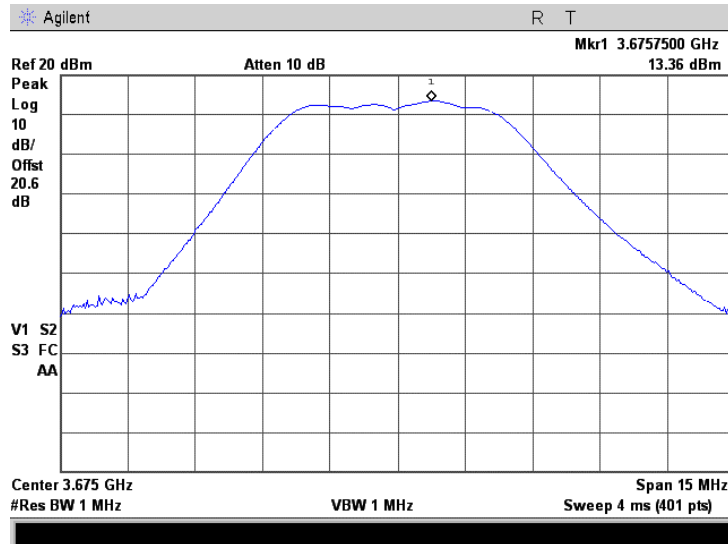

Plot 7.1.12 Peak output power density test results at high frequency, BPSK Bit Rate: 2.095 Mbps

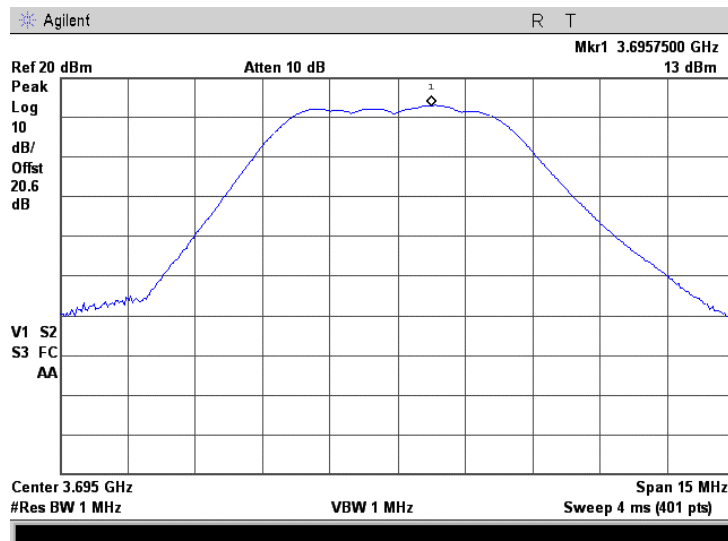



<b>Test specification:</b>		<b>Section 90.1321, Maximum output power</b>	
<b>Test procedure:</b>		47 CFR, Section 2.1046; TIA/EIA-603-C, Section 2.2.1	
<b>Test mode:</b>	Compliance	<b>Verdict:</b>	<b>PASS</b>
<b>Date:</b>	4/02/2008		
<b>Temperature:</b> 24°C	<b>Air Pressure:</b> 1012 hPa	<b>Relative Humidity:</b> 42%	<b>Power Supply:</b> 120 V AC
<b>Remarks:</b> 10 MHz CBW			

Table 7.1.4 Peak output power test results for 10 MHz channel bandwidth

ASSIGNED FREQUENCY RANGE: 3650.0 – 3700.0 MHz  
DETECTOR USED: Power meter  
MODULATION: BPSK, QPSK, 16QAM, 64QAM  
MODULATING SIGNAL: PRBS  
TRANSMITTER OUTPUT POWER SETTINGS: Maximum

Carrier frequency, MHz	Power meter reading, dBm	External attenuation, dB	Cable loss dB	RF output power*, dBm	Limit, dBm	Margin, dB	Verdict
<b>64QAM, Bit Rate: 37.7 Mbps</b>							
3655.0	23.80	included	included	39.80	40.00	-0.20	Pass
3675.0	23.50	included	included	39.50	40.00	-0.50	Pass
3695.0	23.10	included	included	39.10	40.00	-0.90	Pass
<b>16QAM, Bit Rate: 25.13Mbps</b>							
3655.0	23.84	included	included	39.84	40.00	-0.16	Pass
3675.0	23.44	included	included	39.44	40.00	-0.56	Pass
3695.0	23.02	included	included	39.02	40.00	-0.98	Pass
<b>QPSK, Bit Rate: 8.38 Mbps</b>							
3655.0	23.74	included	included	39.74	40.00	-0.26	Pass
3675.0	23.48	included	included	39.48	40.00	-0.52	Pass
3695.0	23.04	included	included	39.04	40.00	-0.96	Pass
<b>BPSK, Bit Rate: 4.19 Mbps</b>							
3655.0	23.80	included	included	39.80	40.00	-0.20	Pass
3675.0	23.48	included	included	39.48	40.00	-0.52	Pass
3695.0	23.06	included	included	39.06	40.00	-0.94	Pass

\* - Output Power = Power Meter Reading + Antenna Gain

Reference numbers of test equipment used

HL 2780	HL 2951	HL 3301	HL 3439				
---------	---------	---------	---------	--	--	--	--

Full description is given in Appendix A.

<b>Test specification:</b> Section 90.1321, Maximum output power	
<b>Test procedure:</b> 47 CFR, Section 2.1046; TIA/EIA-603-C, Section 2.2.1	
<b>Test mode:</b> Compliance	<b>Verdict:</b> PASS
<b>Date:</b> 4/02/2008	
<b>Temperature:</b> 24°C	<b>Air Pressure:</b> 1012 hPa
<b>Relative Humidity:</b> 42%	
<b>Power Supply:</b> 120 V AC	
<b>Remarks:</b> 10 MHz CBW	

**Table 7.1.5 Power spectral density test results for 10 MHz channel bandwidth**

ASSIGNED FREQUENCY RANGE: 3650.0 – 3700.0 MHz  
DETECTOR USED: Peak  
RESOLUTION BANDWIDTH: 1000 kHz  
VIDEO BANDWIDTH: 3000 kHz  
MODULATION: BPSK, 4QAM, 16QAM, 64QAM  
MODULATING SIGNAL: PRBS  
TRANSMITTER OUTPUT POWER SETTINGS: Maximum

Carrier frequency, MHz	Spectrum analyzer reading, dBm/Hz	Attenuation, dB	Cable loss, dB	Power density*, dBm/MHz	Limit, dBm/MHz	Margin, dB	Verdict
<b>64QAM, Bit Rate: 37.7 Mbps</b>							
3655.0	11.32	included	included	27.32	30.0	-2.68	Pass
3675.0	10.99	included	included	26.99	30.0	-3.01	Pass
3695.0	10.87	included	included	26.87	30.0	-3.13	Pass
<b>16QAM, Bit Rate: 25.13 Mbps</b>							
3655.0	11.44	included	included	27.44	30.0	-2.56	Pass
3675.0	11.12	included	included	27.12	30.0	-2.88	Pass
3695.0	10.82	included	included	26.82	30.0	-3.18	Pass
<b>QPSK, Bit Rate: 8.38 Mbps</b>							
3655.0	11.46	included	included	27.46	30.0	-2.54	Pass
3675.0	11.22	included	included	27.22	30.0	-2.78	Pass
3695.0	10.81	included	included	26.81	30.0	-3.19	Pass
<b>BPSK, Bit Rate: 4.19 Mbps</b>							
3655.0	11.48	included	included	27.48	30.0	-2.52	Pass
3675.0	11.23	included	included	27.23	30.0	-2.77	Pass
3695.0	10.87	included	included	26.87	30.0	-3.13	Pass

\* - Power density = Spectrum analyzer reading + Antenna Gain

Note: Additional alternative measurement settings used for peak power spectral density at low and high carrier frequencies at minimum and maximum data rates

**Reference numbers of test equipment used**

HL 2780	HL 2951	HL 3301	HL 3439				
---------	---------	---------	---------	--	--	--	--

Full description is given in Appendix A.

<b>Test specification:</b>		<b>Section 90.1321, Maximum output power</b>	
<b>Test procedure:</b>		47 CFR, Section 2.1046; TIA/EIA-603-C, Section 2.2.1	
<b>Test mode:</b>	Compliance	<b>Verdict:</b>	PASS
<b>Date:</b>	4/02/2008		
<b>Temperature:</b> 24°C	<b>Air Pressure:</b> 1012 hPa	<b>Relative Humidity:</b> 42%	<b>Power Supply:</b> 120 V AC
<b>Remarks:</b> 10 MHz CBW			

Plot 7.1.13 Peak output power density test results at low frequency, 64QAM, Bit Rate: 37.7 Mbps

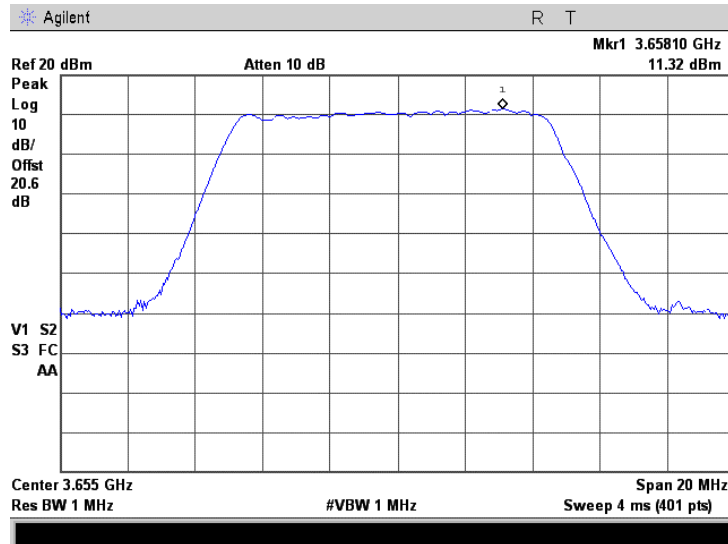

Plot 7.1.14 Peak output power density test results at mid frequency, 64QAM, Bit Rate: 37.7 Mbps

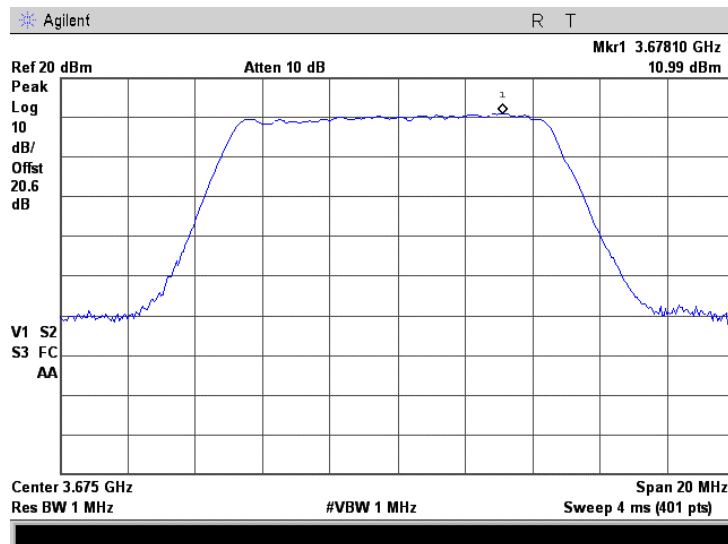

<b>Test specification:</b>	<b>Section 90.1321, Maximum output power</b>		
<b>Test procedure:</b>	47 CFR, Section 2.1046; TIA/EIA-603-C, Section 2.2.1		
<b>Test mode:</b>	Compliance	<b>Verdict:</b>	<b>PASS</b>
<b>Date:</b>	4/02/2008		
<b>Temperature:</b> 24°C	<b>Air Pressure:</b> 1012 hPa	<b>Relative Humidity:</b> 42%	<b>Power Supply:</b> 120 V AC
<b>Remarks:</b> 10 MHz CBW			

Plot 7.1.15 Peak output power density test results at high frequency, 64QAM Bit Rate: 37.7 Mbps

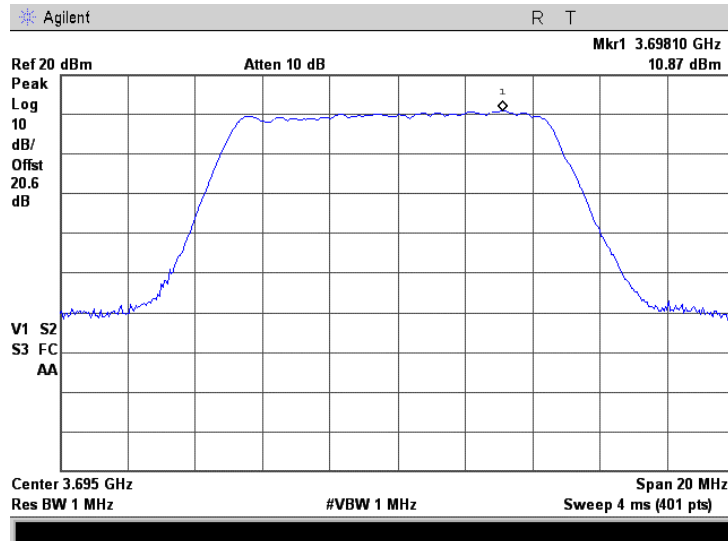

Plot 7.1.16 Peak output power density test results at low frequency, 16QAM Bit Rate: 25.13 Mbps

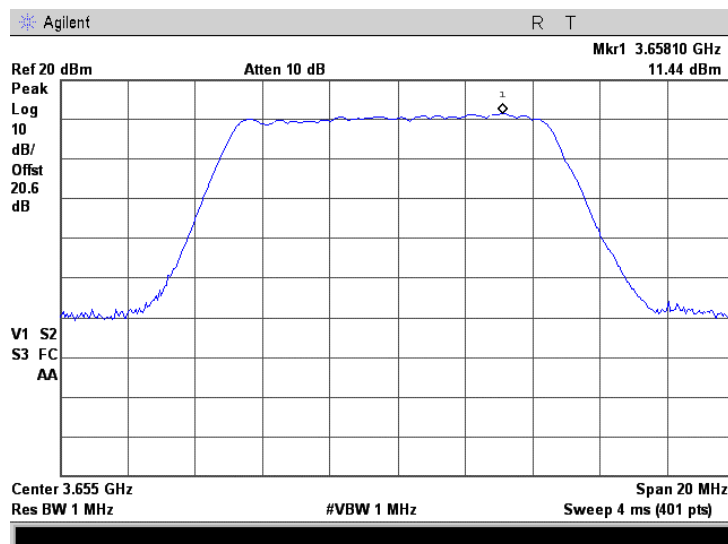

<b>Test specification:</b>	<b>Section 90.1321, Maximum output power</b>		
<b>Test procedure:</b>	47 CFR, Section 2.1046; TIA/EIA-603-C, Section 2.2.1		
<b>Test mode:</b>	Compliance	<b>Verdict:</b>	<b>PASS</b>
<b>Date:</b>	4/02/2008		
<b>Temperature:</b> 24°C	<b>Air Pressure:</b> 1012 hPa	<b>Relative Humidity:</b> 42%	<b>Power Supply:</b> 120 V AC
<b>Remarks:</b> 10 MHz CBW			

Plot 7.1.17 Peak output power density test results at mid frequency, 16QAM Bit Rate: 25.13 Mbps

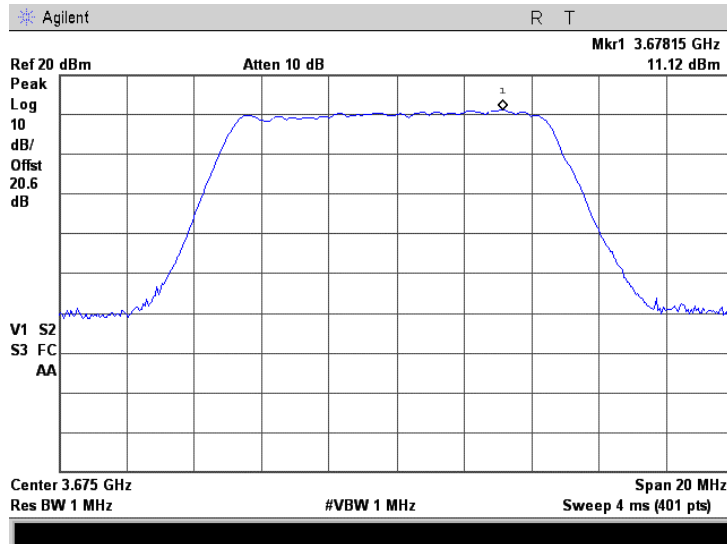

Plot 7.1.18 Peak output power density test results at high frequency, 16QAM Bit Rate: 25.13 Mbps

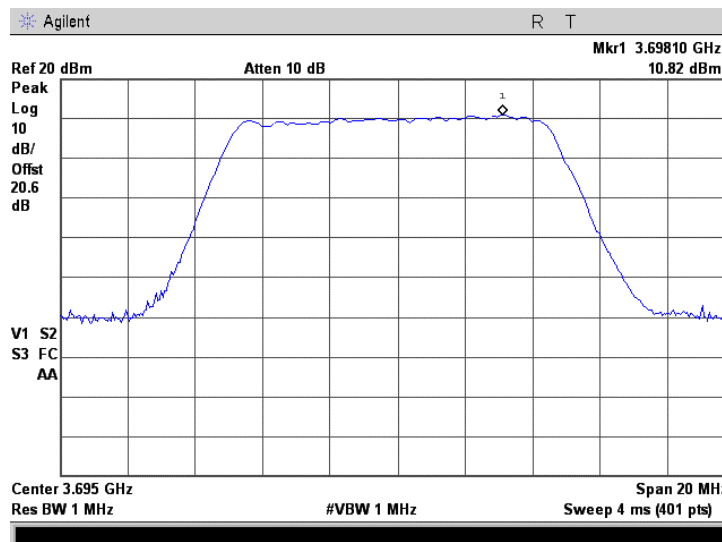

<b>Test specification:</b>		<b>Section 90.1321, Maximum output power</b>	
<b>Test procedure:</b>		47 CFR, Section 2.1046; TIA/EIA-603-C, Section 2.2.1	
<b>Test mode:</b>	Compliance	<b>Verdict:</b>	PASS
<b>Date:</b>	4/02/2008		
<b>Temperature:</b> 24°C	<b>Air Pressure:</b> 1012 hPa	<b>Relative Humidity:</b> 42%	<b>Power Supply:</b> 120 V AC
<b>Remarks:</b> 10 MHz CBW			

Plot 7.1.19 Peak output power density test results at low frequency, QPSK Bit Rate: 8.38 Mbps

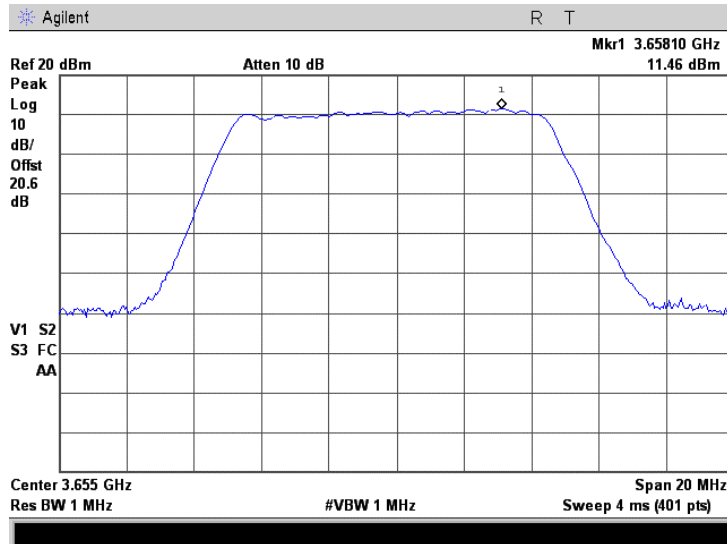

Plot 7.1.20 Peak output power density test results at mid frequency, QPSK Bit Rate: 8.38 Mbps

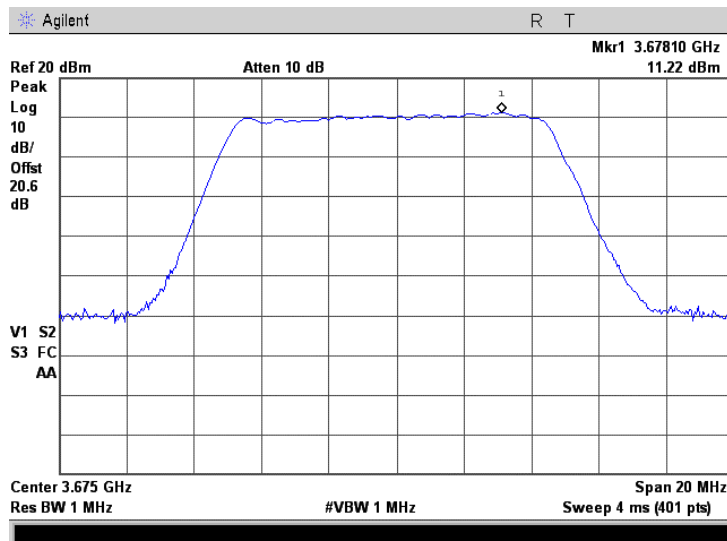

<b>Test specification:</b>		<b>Section 90.1321, Maximum output power</b>	
<b>Test procedure:</b>		47 CFR, Section 2.1046; TIA/EIA-603-C, Section 2.2.1	
<b>Test mode:</b>	Compliance	<b>Verdict:</b>	PASS
<b>Date:</b>	4/02/2008		
<b>Temperature:</b> 24°C	<b>Air Pressure:</b> 1012 hPa	<b>Relative Humidity:</b> 42%	<b>Power Supply:</b> 120 V AC
<b>Remarks:</b> 10 MHz CBW			

Plot 7.1.21 Peak output power density test results at high frequency, QPSK Bit Rate: 8.38 Mbps

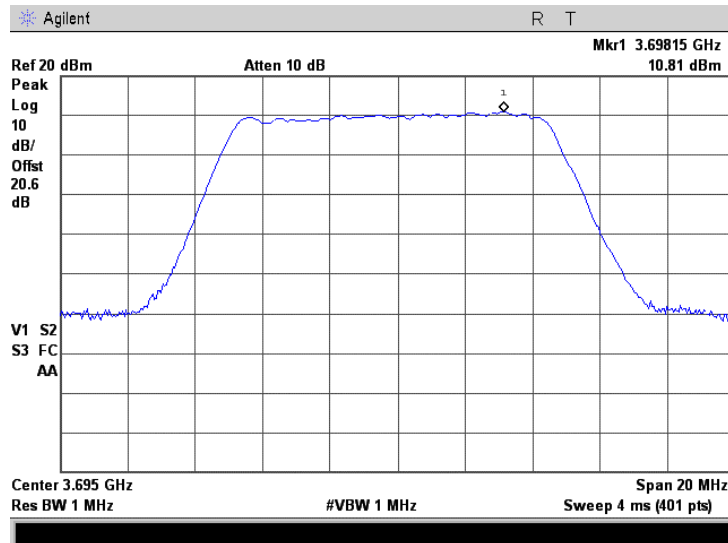

Plot 7.1.22 Peak output power density test results at low frequency, BPSK, Bit Rate: 4.19 Mbps

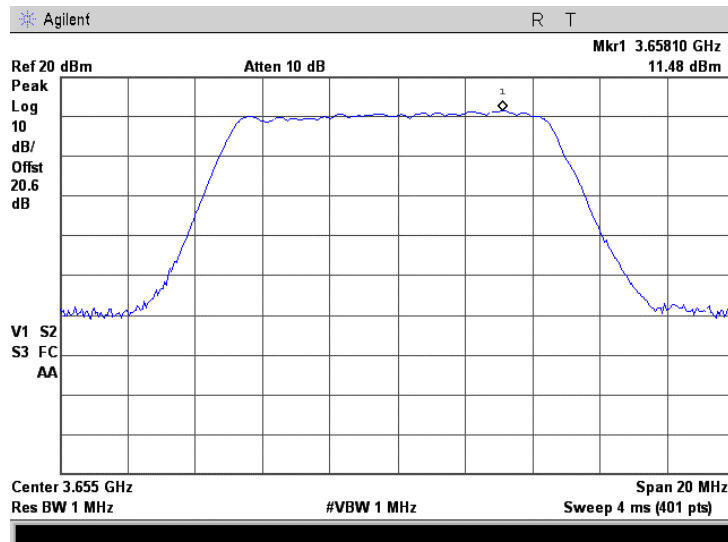

<b>Test specification:</b>		<b>Section 90.1321, Maximum output power</b>	
<b>Test procedure:</b>		47 CFR, Section 2.1046; TIA/EIA-603-C, Section 2.2.1	
<b>Test mode:</b>	Compliance	<b>Verdict:</b>	PASS
<b>Date:</b>	4/02/2008		
<b>Temperature:</b> 24°C	<b>Air Pressure:</b> 1012 hPa	<b>Relative Humidity:</b> 42%	<b>Power Supply:</b> 120 V AC
<b>Remarks:</b> 10 MHz CBW			

Plot 7.1.23 Peak output power density test results at mid frequency, BPSK Bit Rate: 4.19 Mbps

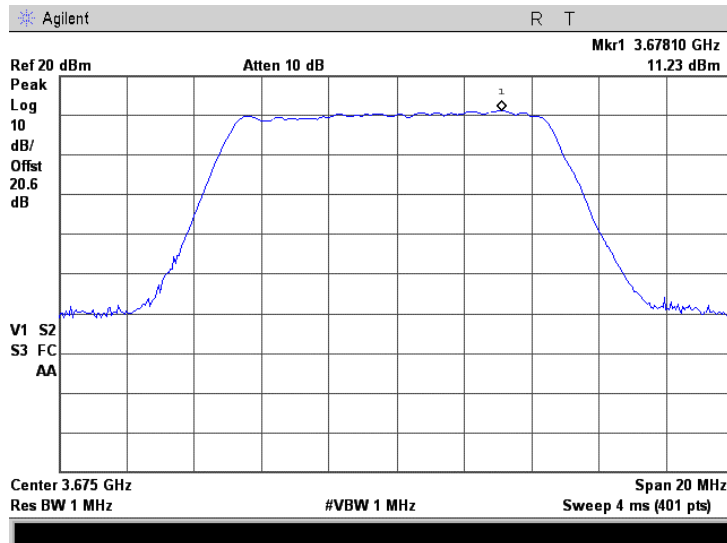

Plot 7.1.24 Peak output power density test results at high frequency, BPSK Bit Rate: 4.19 Mbps

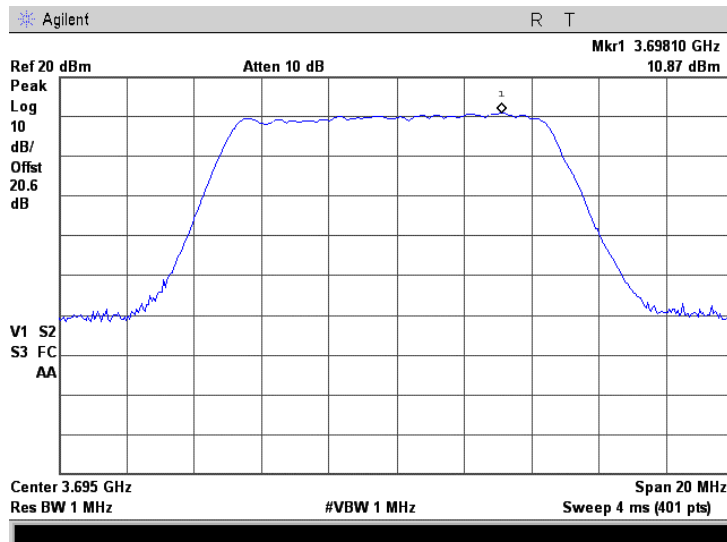



<b>Test specification:</b>		<b>Section 90.209, Occupied bandwidth</b>	
<b>Test procedure:</b>		47 CFR, Section 2.1049	
<b>Test mode:</b>	Compliance	<b>Verdict:</b>	PASS
<b>Date:</b>	12/30/2007		
<b>Temperature:</b> 24°C	<b>Air Pressure:</b> 1018 hPa	<b>Relative Humidity:</b> 36%	<b>Power Supply:</b> 120 V AC
<b>Remarks:</b>			

## 7.2 Occupied bandwidth test

### 7.2.1 General

This test was performed to measure transmitter occupied bandwidth. Specification test limits are given in Table 7.2.1.

Table 7.2.1 Occupied bandwidth limits

Assigned frequency, MHz	Modulation envelope reference points*, dBc	Channel bandwidth, MHz	Maximum allowed bandwidth, MHz
3650.0-3700.0	26	5	5
		10	10

\* - Modulation envelope reference points are provided in terms of attenuation below the maximum peak output power of carrier.

### 7.2.2 Test procedure

7.2.2.1 The EUT was set up as shown in Figure 7.2.1, energized and its proper operation was checked.

7.2.2.2 Maximum peak output power of carrier was taken as the reference level.

7.2.2.3 The transmitter occupied bandwidth was measured with spectrum analyzer as a frequency delta between the reference points on modulation envelope and provided in Table 7.2.2, Table 7.2.3 and the associated plots.

Figure 7.2.1 Occupied bandwidth test setup

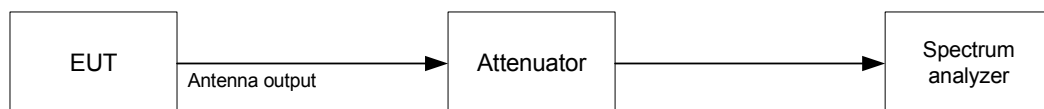

<b>Test specification:</b>		<b>Section 90.209, Occupied bandwidth</b>	
<b>Test procedure:</b>		47 CFR, Section 2.1049	
<b>Test mode:</b>	Compliance	<b>Verdict:</b>	<b>PASS</b>
<b>Date:</b>	12/30/2007		
<b>Temperature:</b> 24°C	<b>Air Pressure:</b> 1018 hPa	<b>Relative Humidity:</b> 36%	<b>Power Supply:</b> 120 V AC
<b>Remarks:</b> 5 MHz CBW			

**Table 7.2.2 Occupied bandwidth test results for 5 MHz channel bandwidth**

RESOLUTION BANDWIDTH: 100 kHz\*  
 VIDEO BANDWIDTH: 300 kHz  
 MODULATION ENVELOPE REFERENCE POINTS: 26 dBc  
 MODULATING SIGNAL: PRBS

Carrier frequency, MHz	Occupied bandwidth, MHz	Limit, MHz	Margin, MHz	Verdict
<b>64QAM, Bit Rate 18.85Mbps</b>				
3655.0	4.760	5	-0.240	Pass
3675.0	4.795	5	-0.205	Pass
3695.0	4.760	5	-0.240	Pass
<b>BPSK , Bit Rate 2.095Mbps</b>				
3655.0	4.760	5	-0.240	Pass
3675.0	4.760	5	-0.240	Pass
3695.0	4.743	5	-0.257	Pass

\* - RBW ≥ 1% of OBW; 1 % of 5 MHz is 50 kHz, hence, RBW=100 kHz was chosen for the measurements.

**Reference numbers of test equipment used**

HL 2909	HL 2912	HL 3173	HL 3179				
---------	---------	---------	---------	--	--	--	--

Full description is given in Appendix A.

<b>Test specification:</b>	<b>Section 90.209, Occupied bandwidth</b>		
<b>Test procedure:</b>	47 CFR, Section 2.1049		
<b>Test mode:</b>	Compliance	<b>Verdict: PASS</b>	
<b>Date:</b>	12/30/2007		
<b>Temperature:</b> 24°C	<b>Air Pressure:</b> 1018 hPa	<b>Relative Humidity:</b> 36%	<b>Power Supply:</b> 120 V AC
<b>Remarks:</b> 5 MHz CBW			

Plot 7.2.1 Unmodulated signal for reference level

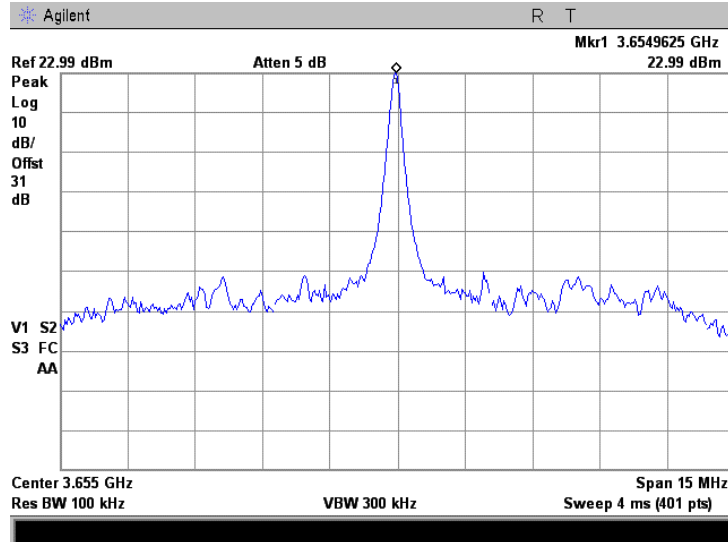

<b>Test specification:</b> Section 90.209, Occupied bandwidth			
<b>Test procedure:</b> 47 CFR, Section 2.1049			
<b>Test mode:</b> Compliance	<b>Verdict:</b> PASS		
<b>Date:</b> 12/30/2007			
<b>Temperature:</b> 24°C	<b>Air Pressure:</b> 1018 hPa	<b>Relative Humidity:</b> 36%	<b>Power Supply:</b> 120 V AC
<b>Remarks:</b> 5 MHz CBW			

Plot 7.2.2 Occupied bandwidth test result at low frequency, 64QAM, rate 18.85 Mbps

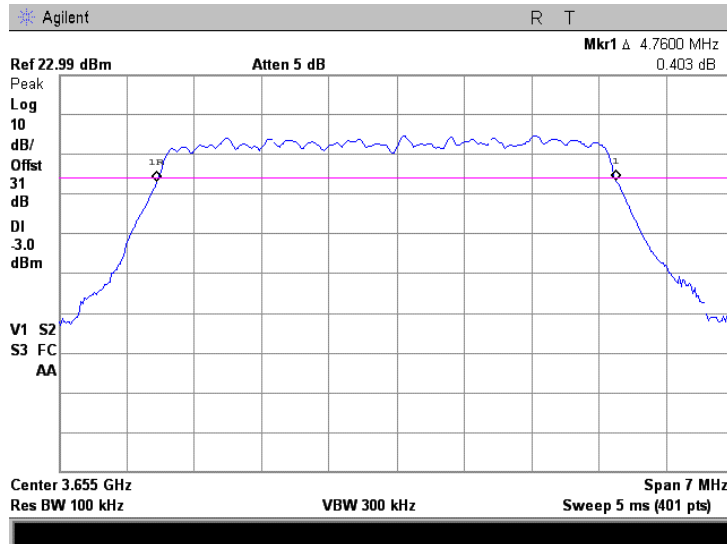

Plot 7.2.3 Occupied bandwidth test result at mid frequency, 64QAM, rate 18.85 Mbps

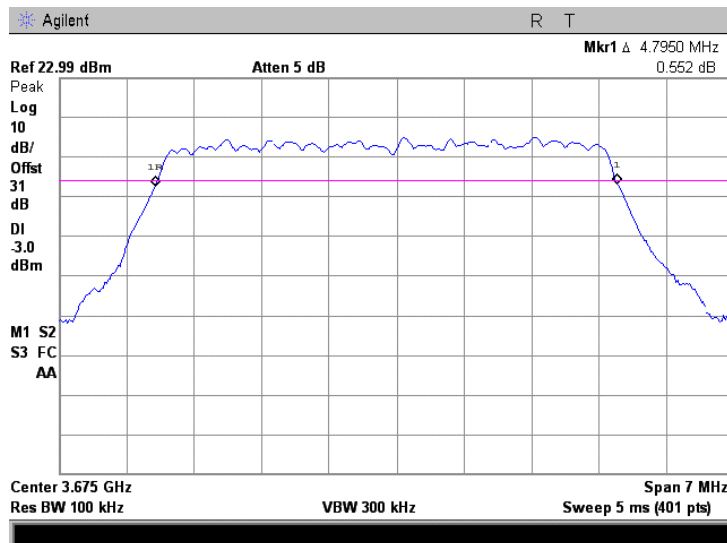

<b>Test specification:</b>	<b>Section 90.209, Occupied bandwidth</b>		
<b>Test procedure:</b>	47 CFR, Section 2.1049		
<b>Test mode:</b>	Compliance	<b>Verdict:</b>	<b>PASS</b>
<b>Date:</b>	12/30/2007		
<b>Temperature:</b> 24°C	<b>Air Pressure:</b> 1018 hPa	<b>Relative Humidity:</b> 36%	<b>Power Supply:</b> 120 V AC
<b>Remarks:</b> 5 MHz CBW			

Plot 7.2.4 Occupied bandwidth test result at high frequency, 64QAM, rate 18.85 Mbps



Plot 7.2.5 Occupied bandwidth test result at low frequency, BPSK, rate 2.095 Mbps

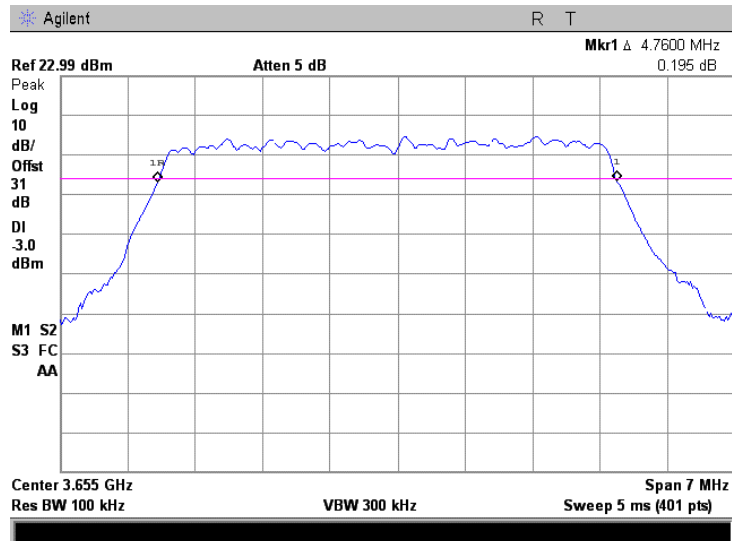

<b>Test specification:</b> Section 90.209, Occupied bandwidth			
<b>Test procedure:</b> 47 CFR, Section 2.1049			
<b>Test mode:</b> Compliance	<b>Verdict:</b> PASS		
<b>Date:</b> 12/30/2007			
<b>Temperature:</b> 24°C	<b>Air Pressure:</b> 1018 hPa	<b>Relative Humidity:</b> 36%	<b>Power Supply:</b> 120 V AC
<b>Remarks:</b> 5 MHz CBW			

Plot 7.2.6 Occupied bandwidth test result at mid frequency, BPSK, rate 2.095 Mbps

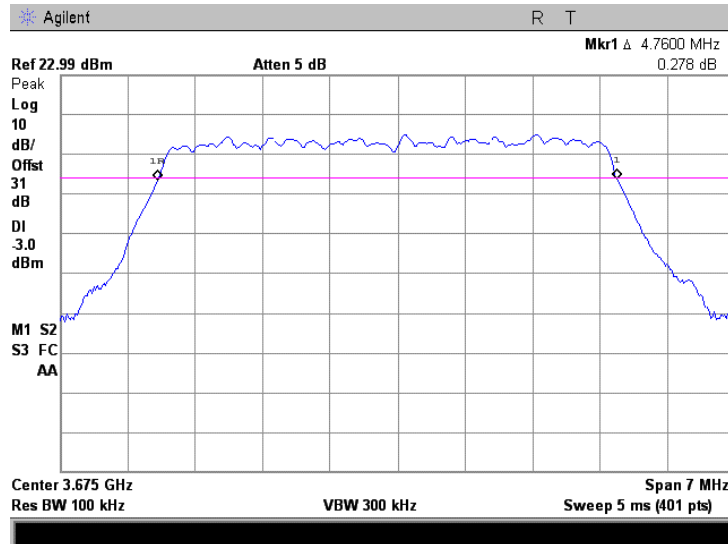

Plot 7.2.7 Occupied bandwidth test result at high frequency, BPSK, rate 2.095 Mbps

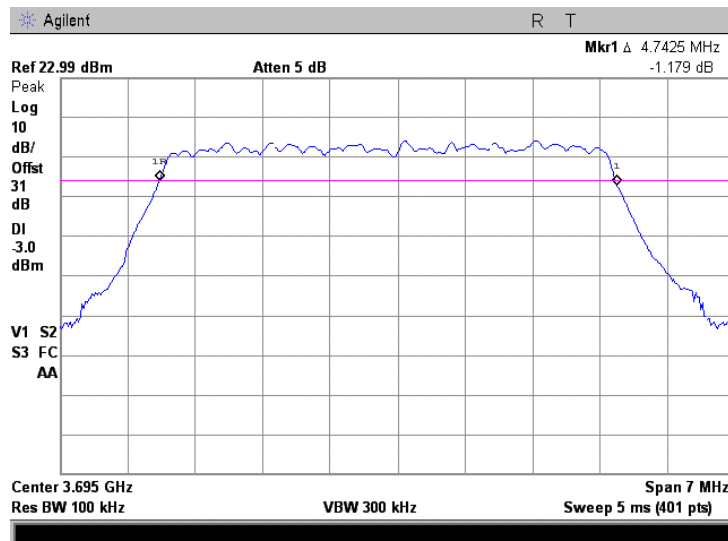

<b>Test specification:</b>	<b>Section 90.209, Occupied bandwidth</b>			
<b>Test procedure:</b>	47 CFR, Section 2.1049			
<b>Test mode:</b>	Compliance	<b>Verdict:</b>		<b>PASS</b>
<b>Date:</b>	12/30/2007			
<b>Temperature:</b> 24°C	<b>Air Pressure:</b> 1018 hPa	<b>Relative Humidity:</b> 36%	<b>Power Supply:</b> 120 V AC	
<b>Remarks:</b> 10 MHz CBW				

**Table 7.2.3 Occupied bandwidth test results 10 MHz channel bandwidth**

RESOLUTION BANDWIDTH: 100 kHz\*  
 VIDEO BANDWIDTH: 300 kHz  
 MODULATION ENVELOPE REFERENCE POINTS: 26 dBc  
 MODULATING SIGNAL: PRBS

Carrier frequency, MHz	Occupied bandwidth, MHz	Limit, MHz	Margin, MHz	Verdict
<b>64QAM, Bit Rate 37.7Mbps</b>				
3655.0	9.2625	10	-0.7375	Pass
3675.0	9.2625	10	-0.7375	Pass
3695.0	9.2625	10	-0.7375	Pass
<b>BPSK, Bit Rate 4.19Mbps</b>				
3655.0	9.2250	10	-0.7750	Pass
3675.0	9.2250	10	-0.7750	Pass
3695.0	9.2625	10	-0.7375	Pass

\* - RBW ≥ 1% of OBW; 1 % of 10 MHz is 100 kHz, hence, RBW=100 kHz was chosen for measurements

**Reference numbers of test equipment used**

HL 2909	HL 2912	HL 3173	HL 3179				
---------	---------	---------	---------	--	--	--	--

Full description is given in Appendix A.

<b>Test specification:</b>	<b>Section 90.209, Occupied bandwidth</b>		
<b>Test procedure:</b>	47 CFR, Section 2.1049		
<b>Test mode:</b>	Compliance	<b>Verdict:</b>	<b>PASS</b>
<b>Date:</b>	12/30/2007		
<b>Temperature:</b> 24°C	<b>Air Pressure:</b> 1018 hPa	<b>Relative Humidity:</b> 36%	<b>Power Supply:</b> 120 V AC
<b>Remarks:</b> 10 MHz CBW			

Plot 7.2.8 Unmodulated signal for reference level

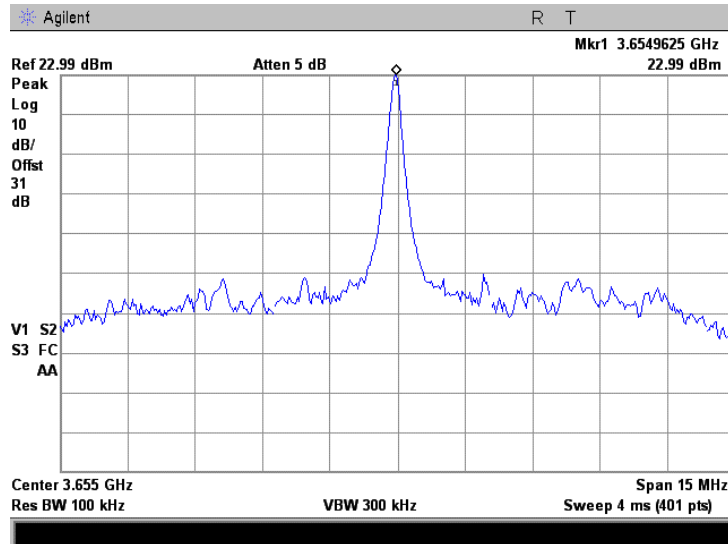



<b>Test specification:</b> Section 90.209, Occupied bandwidth			
<b>Test procedure:</b> 47 CFR, Section 2.1049			
<b>Test mode:</b> Compliance	<b>Verdict:</b> PASS		
<b>Date:</b> 12/30/2007			
<b>Temperature:</b> 24°C	<b>Air Pressure:</b> 1018 hPa	<b>Relative Humidity:</b> 36%	<b>Power Supply:</b> 120 V AC
<b>Remarks:</b> 10 MHz CBW			

Plot 7.2.9 Occupied bandwidth test result at low frequency, 64QAM, rate 37.7 Mbps

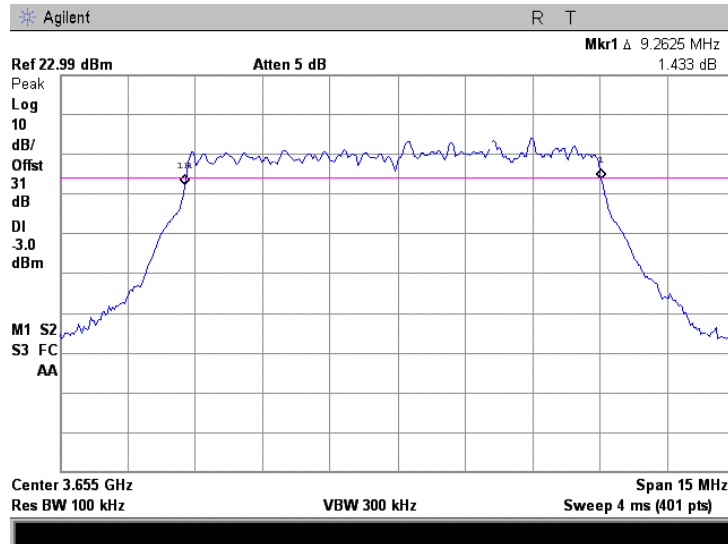

Plot 7.2.10 Occupied bandwidth test result at mid frequency, 64QAM, rate 37.7 Mbps

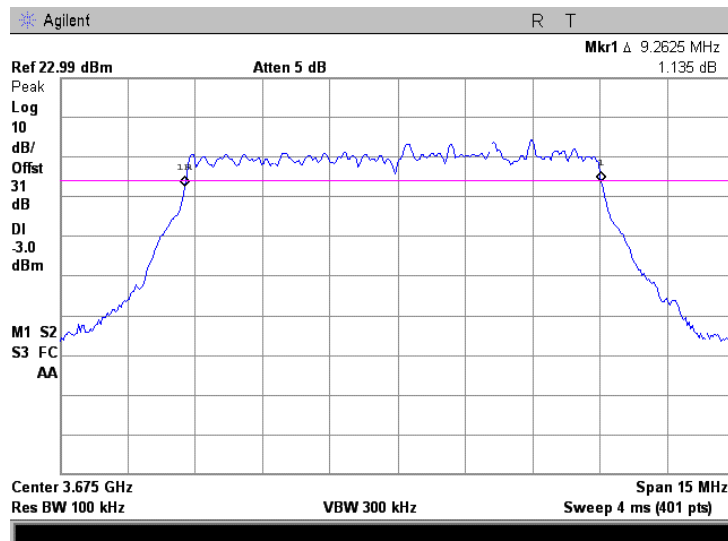

<b>Test specification:</b>	<b>Section 90.209, Occupied bandwidth</b>		
<b>Test procedure:</b>	47 CFR, Section 2.1049		
<b>Test mode:</b>	Compliance	<b>Verdict:</b>	<b>PASS</b>
<b>Date:</b>	12/30/2007		
<b>Temperature:</b> 24°C	<b>Air Pressure:</b> 1018 hPa	<b>Relative Humidity:</b> 36%	<b>Power Supply:</b> 120 V AC
<b>Remarks:</b> 10 MHz CBW			

Plot 7.2.11 Occupied bandwidth test result at high frequency, 64QAM, rate 37.7 Mbps

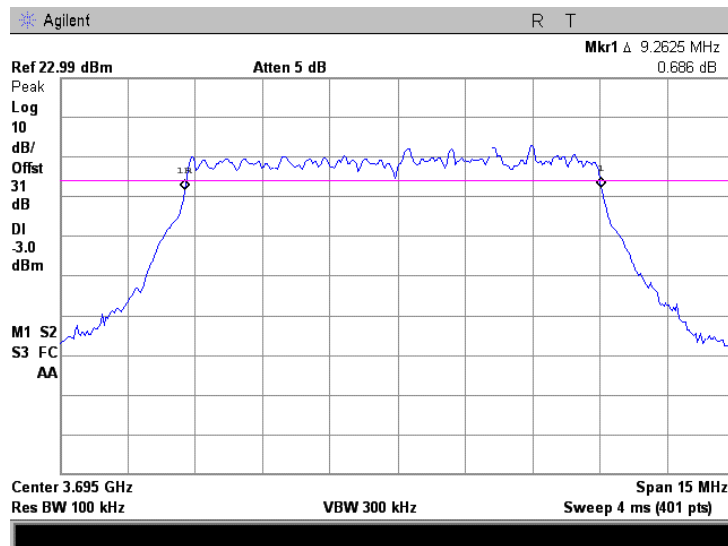

Plot 7.2.12 Occupied bandwidth test result at low frequency, BPSK, rate 4.19 Mbps

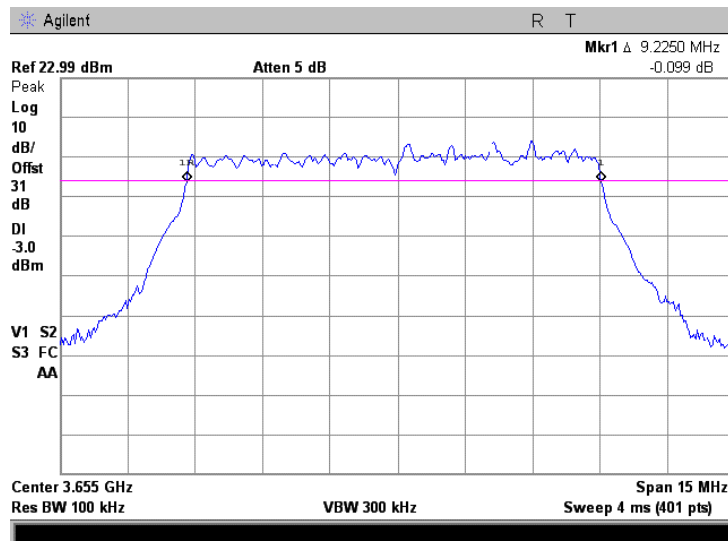

<b>Test specification:</b>	<b>Section 90.209, Occupied bandwidth</b>		
<b>Test procedure:</b>	47 CFR, Section 2.1049		
<b>Test mode:</b>	Compliance	<b>Verdict:</b>	<b>PASS</b>
<b>Date:</b>	12/30/2007		
<b>Temperature:</b> 24°C	<b>Air Pressure:</b> 1018 hPa	<b>Relative Humidity:</b> 36%	<b>Power Supply:</b> 120 V AC
<b>Remarks:</b> 10 MHz CBW			

Plot 7.2.13 Occupied bandwidth test result at mid frequency, BPSK, rate 4.19 Mbps

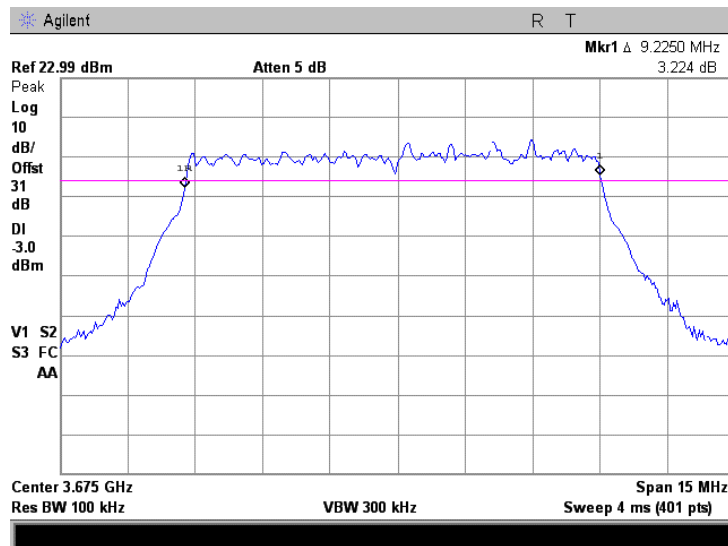

Plot 7.2.14 Occupied bandwidth test result at high frequency, BPSK, rate 4.19 Mbps

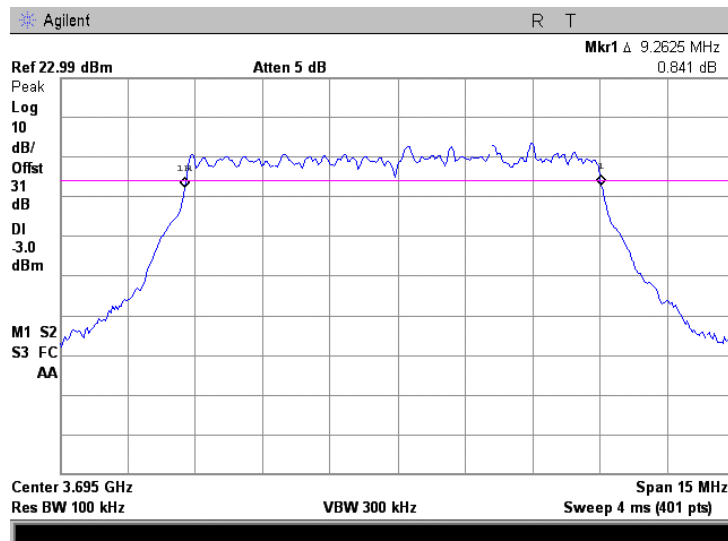

<b>Test specification:</b>		<b>Section 90.210 (b), Emission mask</b>	
<b>Test procedure:</b>		47 CFR, Sections 2.1051, 2.1047 and 90.210(b); TIA/EIA-603-C, Section 2.2.13	
<b>Test mode:</b>	Compliance	<b>Verdict:</b>	<b>PASS</b>
<b>Date:</b>	12/30/2007		
<b>Temperature:</b> 24°C	<b>Air Pressure:</b> 1018 hPa	<b>Relative Humidity:</b> 36%	<b>Power Supply:</b> 120 V AC
<b>Remarks:</b>			

### 7.3 Emission mask test

#### 7.3.1 General

This test was performed to measure emission mask at RF antenna connector. Specification test limits are given in Table 7.3.1, Table 7.3.3.

#### 7.3.2 Test procedure

**7.3.2.1** The EUT was set up as shown in Figure 7.3.1, energized and its proper operation was checked.

**7.3.2.2** The emission mask was measured with spectrum analyzer as provided in the associated plots. The test results are provided in Table 7.3.2, Table 7.3.4.

**Figure 7.3.1 Emission mask test setup**

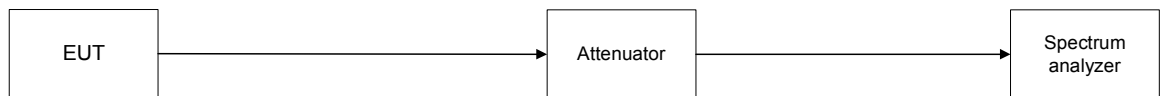

<b>Test specification:</b>	<b>Section 90.210, Emission mask</b>		
<b>Test procedure:</b>	47 CFR, Sections 2.1051, 2.1047 and 90.210(b); TIA/EIA-603-C, Section 2.2.13		
<b>Test mode:</b>	Compliance	<b>Verdict:</b>	<b>PASS</b>
<b>Date:</b>	12/30/2007		
<b>Temperature:</b> 24°C	<b>Air Pressure:</b> 1018 hPa	<b>Relative Humidity:</b> 36%	<b>Power Supply:</b> 120 V AC
<b>Remarks:</b> 5 MHz CBW			

**Table 7.3.1 Emission mask limits for 5 MHz channel bandwidth**

Frequency displacement from carrier	Attenuation below carrier, dBc
<b>Emission mask B (Channel bandwidth 5 MHz)</b>	
0 – 2.5 MHz	0
2.5 – 5.0 MHz	25
5.0 – 12.5 MHz	35
More than** 12.5 MHz	43 + 10 log(P)

\* - F – frequency in MHz removed from center

\*\* - emission mask includes carrier modulation envelope within ± 150 % of the authorized bandwidth; the frequency range removed beyond ± 150 % of the authorized bandwidth from carrier was investigated as spurious emission

**Table 7.3.2 Emission mask test results for 5 MHz channel bandwidth**

Carrier frequency, MHz	Limit	Verdict
3655.0	Emission mask B	Pass
3675.0		
3695.0		

The zero dB reference is measured relative to the highest average power of the fundamental emission measured across the designated channel bandwidth

**Reference numbers of test equipment used**

HL 2909	HL 2912	HL 3173	HL 3179				
---------	---------	---------	---------	--	--	--	--

Full description is given in Appendix A.

<b>Test specification:</b>	<b>Section 90.210, Emission mask</b>		
<b>Test procedure:</b>	47 CFR, Sections 2.1051, 2.1047 and 90.210(b); TIA/EIA-603-C, Section 2.2.13		
<b>Test mode:</b>	Compliance	<b>Verdict:</b>	<b>PASS</b>
<b>Date:</b>	12/30/2007		
<b>Temperature:</b> 24°C	<b>Air Pressure:</b> 1018 hPa	<b>Relative Humidity:</b> 36%	<b>Power Supply:</b> 120 V AC
<b>Remarks:</b> 5 MHz CBW			

Plot 7.3.1 Emission mask for 5 MHz channel bandwidth

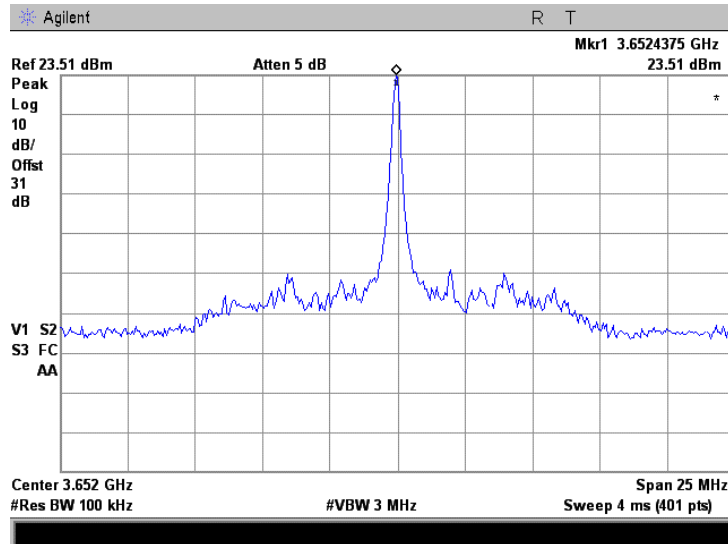

Plot 7.3.2 Emission mask test results at low carrier frequency, 64QAM rate 18.85 Mbps

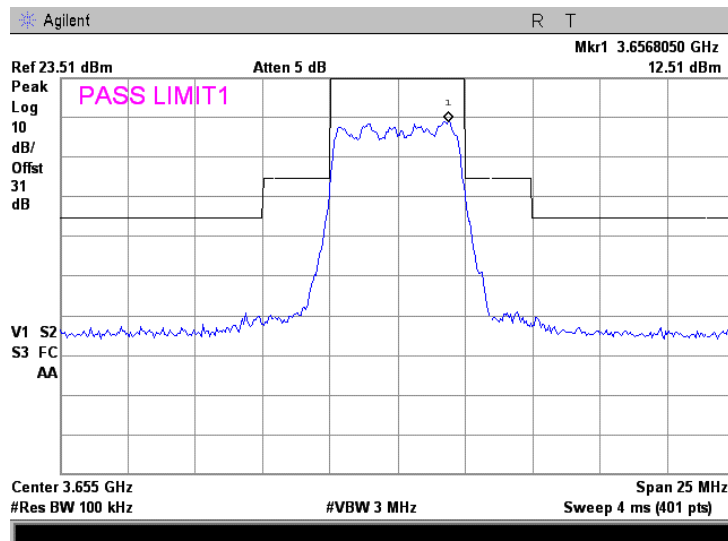

<b>Test specification:</b>	<b>Section 90.210, Emission mask</b>		
<b>Test procedure:</b>	47 CFR, Sections 2.1051, 2.1047 and 90.210(b); TIA/EIA-603-C, Section 2.2.13		
<b>Test mode:</b>	Compliance	<b>Verdict:</b>	<b>PASS</b>
<b>Date:</b>	12/30/2007		
<b>Temperature:</b> 24°C	<b>Air Pressure:</b> 1018 hPa	<b>Relative Humidity:</b> 36%	<b>Power Supply:</b> 120 V AC
<b>Remarks:</b> 5 MHz CBW			

Plot 7.3.3 Emission mask test results at mid carrier frequency, 64QAM rate 18.85 Mbps

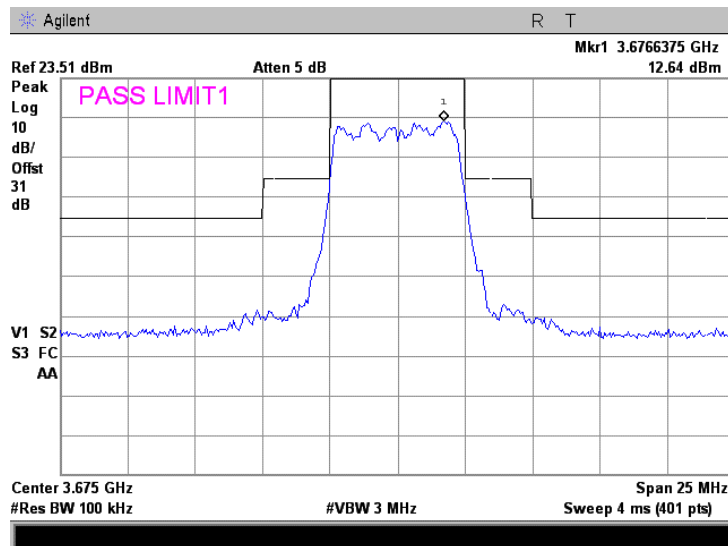

Plot 7.3.4 Emission mask test results at high carrier frequency, 64QAM rate 18.85 Mbps

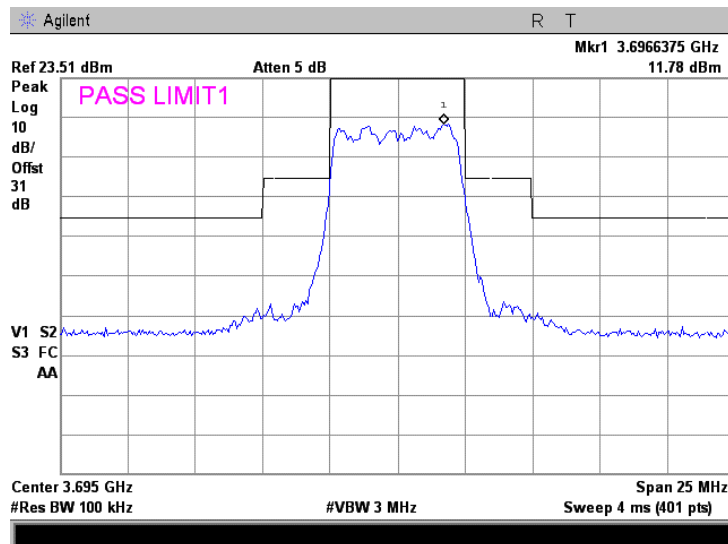

<b>Test specification:</b>	<b>Section 90.210, Emission mask</b>		
<b>Test procedure:</b>	47 CFR, Sections 2.1051, 2.1047 and 90.210(b); TIA/EIA-603-C, Section 2.2.13		
<b>Test mode:</b>	Compliance	<b>Verdict:</b>	<b>PASS</b>
<b>Date:</b>	12/30/2007		
<b>Temperature:</b> 24°C	<b>Air Pressure:</b> 1018 hPa	<b>Relative Humidity:</b> 36%	<b>Power Supply:</b> 120 V AC
<b>Remarks:</b> 5 MHz CBW			

Plot 7.3.5 Emission mask test results at mid carrier frequency, 16QAM rate 12.565 Mbps

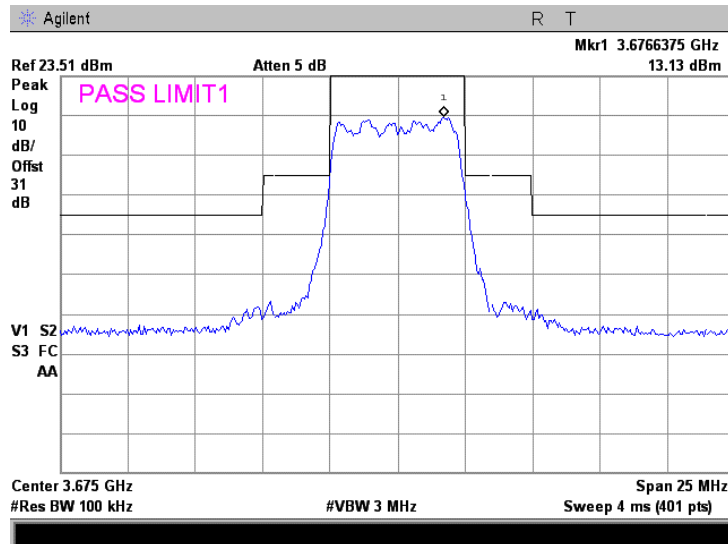

Plot 7.3.6 Emission mask test results at mid carrier frequency, QPSK rate 4.19 Mbps

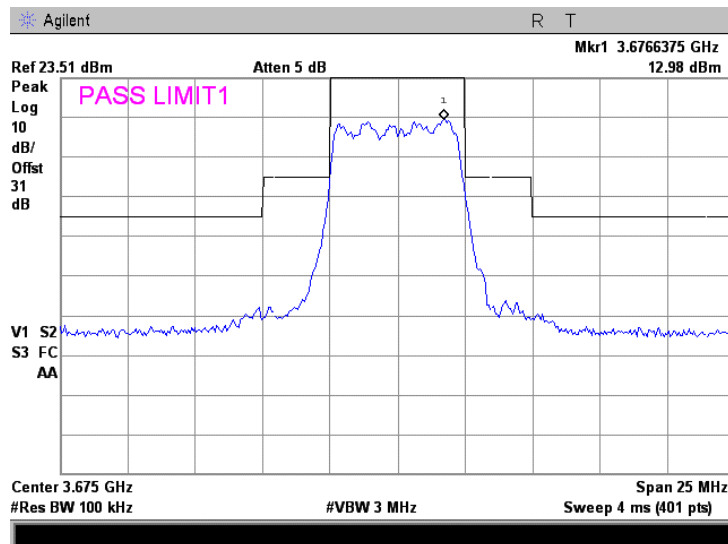



<b>Test specification:</b>	<b>Section 90.210, Emission mask</b>		
<b>Test procedure:</b>	47 CFR, Sections 2.1051, 2.1047 and 90.210(b); TIA/EIA-603-C, Section 2.2.13		
<b>Test mode:</b>	Compliance	<b>Verdict:</b>	<b>PASS</b>
<b>Date:</b>	12/30/2007		
<b>Temperature:</b> 24°C	<b>Air Pressure:</b> 1018 hPa	<b>Relative Humidity:</b> 36%	<b>Power Supply:</b> 120 V AC
<b>Remarks:</b> 5 MHz CBW			

Plot 7.3.7 Emission mask test results at low carrier frequency, BPSK rate 2.095 Mbps

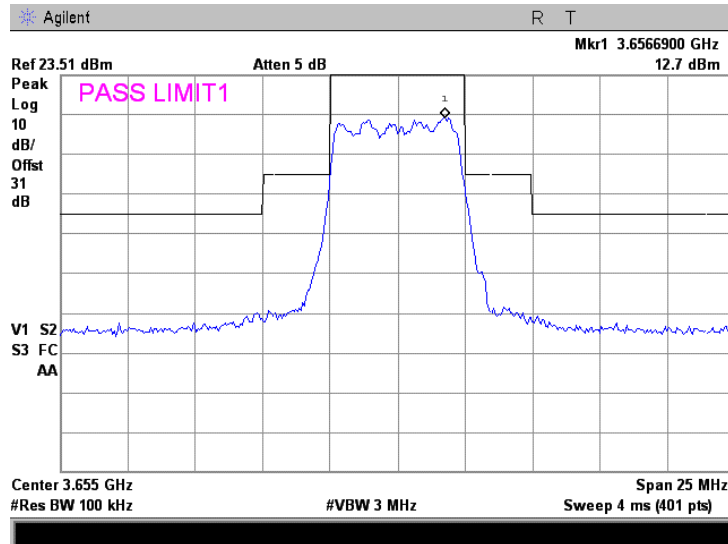

Plot 7.3.8 Emission mask test results at mid carrier frequency, BPSK rate 2.095 Mbps

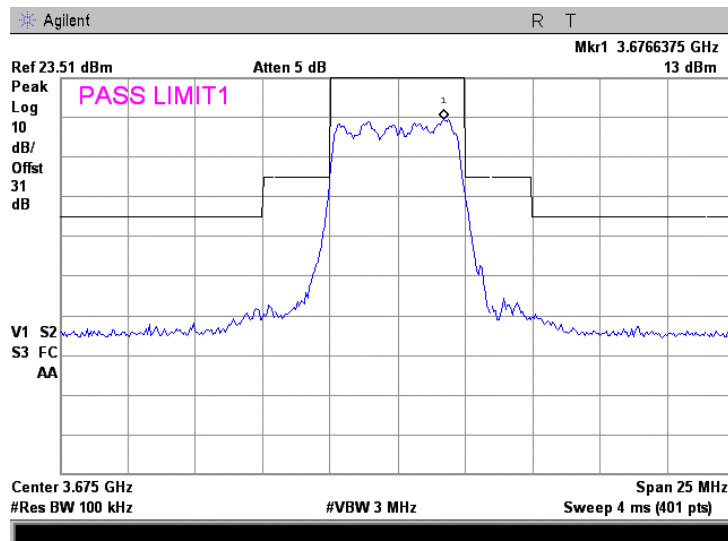

<b>Test specification:</b>	<b>Section 90.210, Emission mask</b>		
<b>Test procedure:</b>	47 CFR, Sections 2.1051, 2.1047 and 90.210(b); TIA/EIA-603-C, Section 2.2.13		
<b>Test mode:</b>	Compliance	<b>Verdict:</b>	<b>PASS</b>
<b>Date:</b>	12/30/2007		
<b>Temperature:</b> 24°C	<b>Air Pressure:</b> 1018 hPa	<b>Relative Humidity:</b> 36%	<b>Power Supply:</b> 120 V AC
<b>Remarks:</b> 5 MHz CBW			

Plot 7.3.9 Emission mask test results at high carrier frequency, BPSK rate 2.095 Mbps

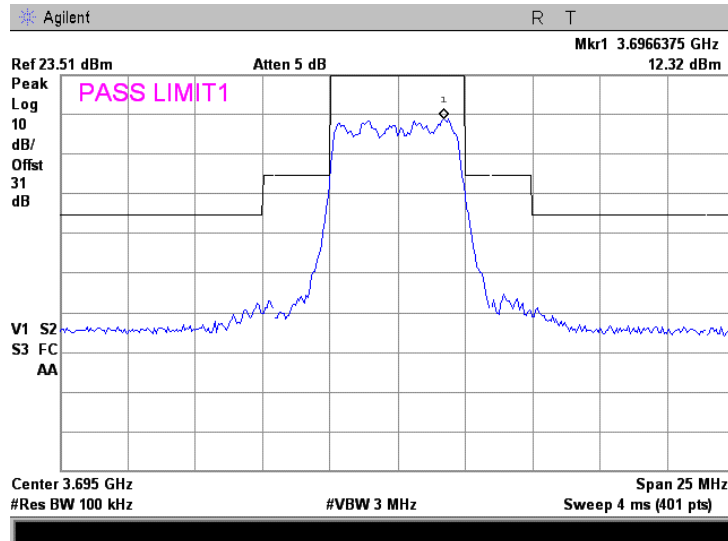

<b>Test specification:</b>		<b>Section 90.210, Emission mask</b>	
<b>Test procedure:</b>		47 CFR, Sections 2.1051, 2.1047 and 90.210(b); TIA/EIA-603-C, Section 2.2.13	
<b>Test mode:</b>	Compliance	<b>Verdict:</b>	<b>PASS</b>
<b>Date:</b>	12/30/2007		
<b>Temperature:</b> 24°C	<b>Air Pressure:</b> 1018 hPa	<b>Relative Humidity:</b> 36%	<b>Power Supply:</b> 120 V AC
<b>Remarks:</b> 10 MHz CBW			

**Table 7.3.3 Emission mask limits for 10 MHz channel bandwidth**

Frequency displacement from carrier	Attenuation below carrier, dBc
<b>Emission mask B(Channel bandwidth 10 MHz)</b>	
0 – 5 MHz	0
5 – 10 MHz	25
10.0 – 25 MHz	35
More than** 25 MHz	43 + 10 log(P)

\* - F – frequency in MHz removed from center

\*\* - emission mask includes carrier modulation envelope within ± 150 % of the authorized bandwidth; the frequency range removed beyond ± 150 % of the authorized bandwidth from carrier was investigated as spurious emission

**Table 7.3.4 Emission mask test results for 10 MHz channel bandwidth**

Carrier frequency, MHz	Limit	Verdict
3655.0	Emission mask B	Pass
3675.0		
3695.0		

The zero dB reference is measured relative to the highest average power of the fundamental emission measured across the designated channel bandwidth.

**Reference numbers of test equipment used**

HL 2909	HL 2912	HL 3173	HL 3179				
---------	---------	---------	---------	--	--	--	--

Full description is given in Appendix A.

<b>Test specification:</b>	<b>Section 90.210, Emission mask</b>		
<b>Test procedure:</b>	47 CFR, Sections 2.1051, 2.1047 and 90.210(b); TIA/EIA-603-C, Section 2.2.13		
<b>Test mode:</b>	Compliance	<b>Verdict:</b>	<b>PASS</b>
<b>Date:</b>	12/30/2007		
<b>Temperature:</b> 24°C	<b>Air Pressure:</b> 1018 hPa	<b>Relative Humidity:</b> 36%	<b>Power Supply:</b> 120 V AC
<b>Remarks:</b> 10 MHz CBW			

Plot 7.3.10 Emission mask for 10 MHz channel bandwidth

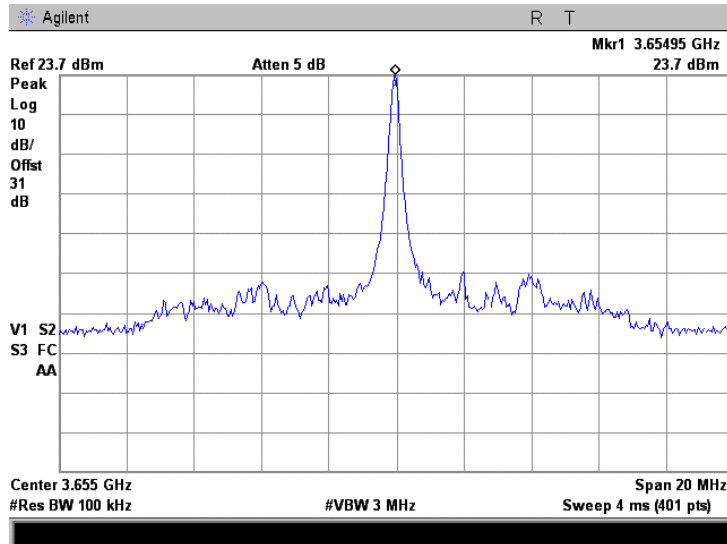

Plot 7.3.11 Emission mask test results at low carrier frequency, 64QAM rate 37.7 Mbps

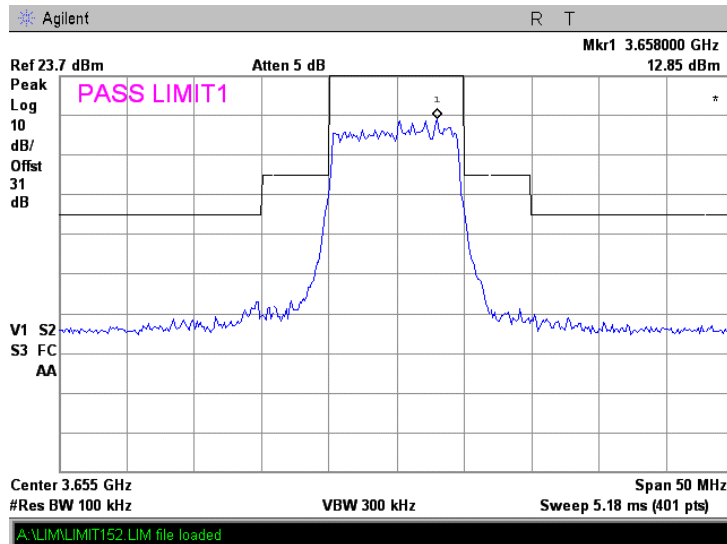

<b>Test specification:</b>	<b>Section 90.210, Emission mask</b>		
<b>Test procedure:</b>	47 CFR, Sections 2.1051, 2.1047 and 90.210(b); TIA/EIA-603-C, Section 2.2.13		
<b>Test mode:</b>	Compliance	<b>Verdict:</b>	<b>PASS</b>
<b>Date:</b>	12/30/2007		
<b>Temperature:</b> 24°C	<b>Air Pressure:</b> 1018 hPa	<b>Relative Humidity:</b> 36%	<b>Power Supply:</b> 120 V AC
<b>Remarks:</b> 10 MHz CBW			

Plot 7.3.12 Emission mask test results at mid carrier frequency, 64QAM, rate 37.7 Mbps

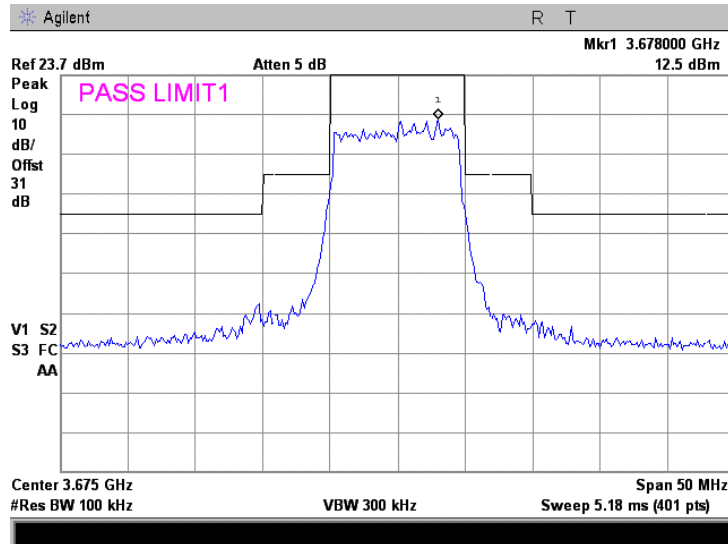

Plot 7.3.13 Emission mask test results at high carrier frequency, 64QAM, rate 37.7 Mbps

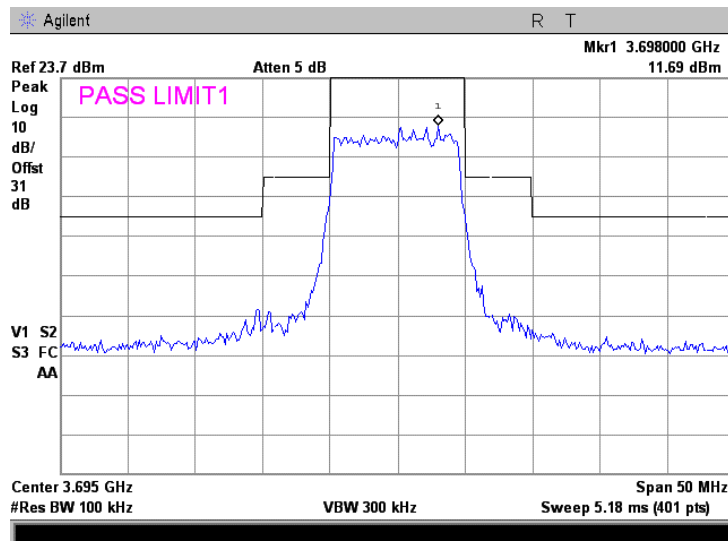

<b>Test specification:</b>	<b>Section 90.210, Emission mask</b>		
<b>Test procedure:</b>	47 CFR, Sections 2.1051, 2.1047 and 90.210(b); TIA/EIA-603-C, Section 2.2.13		
<b>Test mode:</b>	Compliance	<b>Verdict:</b>	<b>PASS</b>
<b>Date:</b>	12/30/2007		
<b>Temperature:</b> 24°C	<b>Air Pressure:</b> 1018 hPa	<b>Relative Humidity:</b> 36%	<b>Power Supply:</b> 120 V AC
<b>Remarks:</b> 10 MHz CBW			

Plot 7.3.14 Emission mask test results at mid carrier frequency, 16QAM rate 25.13 Mbps

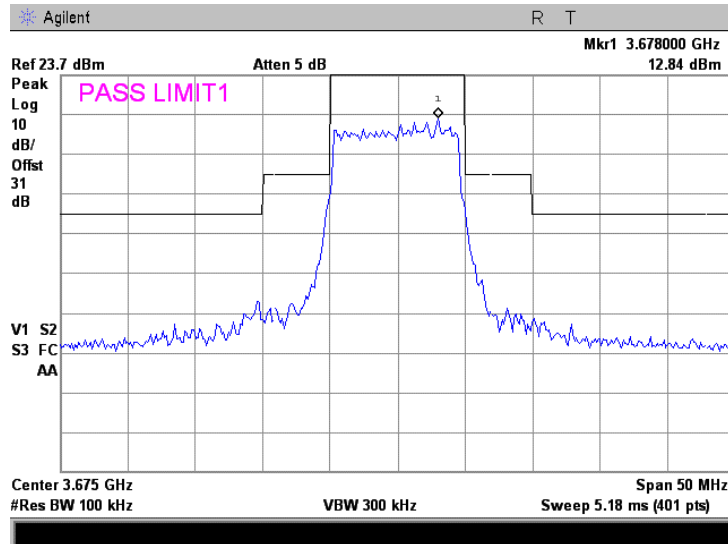

Plot 7.3.15 Emission mask test results at mid carrier frequency, QPSK rate 8.38 Mbps

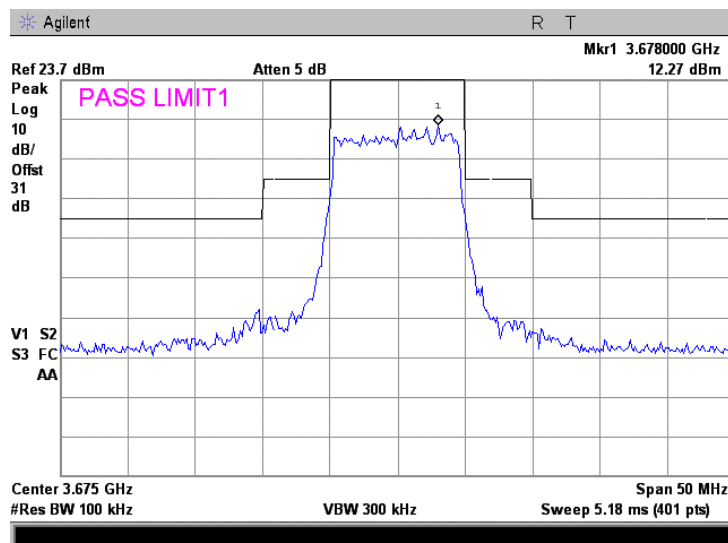

<b>Test specification:</b>	<b>Section 90.210, Emission mask</b>		
<b>Test procedure:</b>	47 CFR, Sections 2.1051, 2.1047 and 90.210(b); TIA/EIA-603-C, Section 2.2.13		
<b>Test mode:</b>	Compliance	<b>Verdict:</b>	<b>PASS</b>
<b>Date:</b>	12/30/2007		
<b>Temperature:</b> 24°C	<b>Air Pressure:</b> 1018 hPa	<b>Relative Humidity:</b> 36%	<b>Power Supply:</b> 120 V AC
<b>Remarks:</b> 10 MHz CBW			

Plot 7.3.16 Emission mask test results at low carrier frequency, BPSK rate 4.19 Mbps

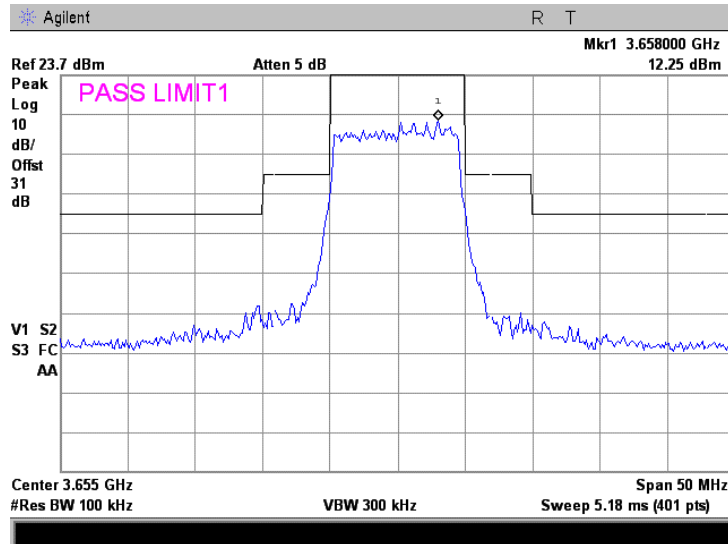

Plot 7.3.17 Emission mask test results at mid carrier frequency, BPSK rate 4.19 Mbps

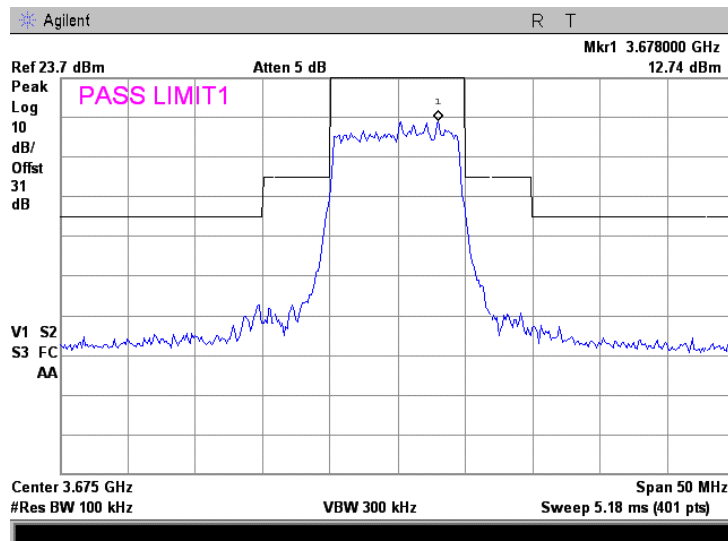

<b>Test specification:</b>	<b>Section 90.210, Emission mask</b>		
<b>Test procedure:</b>	47 CFR, Sections 2.1051, 2.1047 and 90.210(b); TIA/EIA-603-C, Section 2.2.13		
<b>Test mode:</b>	Compliance	<b>Verdict:</b>	<b>PASS</b>
<b>Date:</b>	12/30/2007		
<b>Temperature:</b> 24°C	<b>Air Pressure:</b> 1018 hPa	<b>Relative Humidity:</b> 36%	<b>Power Supply:</b> 120 V AC
<b>Remarks:</b> 10 MHz CBW			

Plot 7.3.18 Emission mask test results at high carrier frequency, BPSK rate 4.19 Mbps

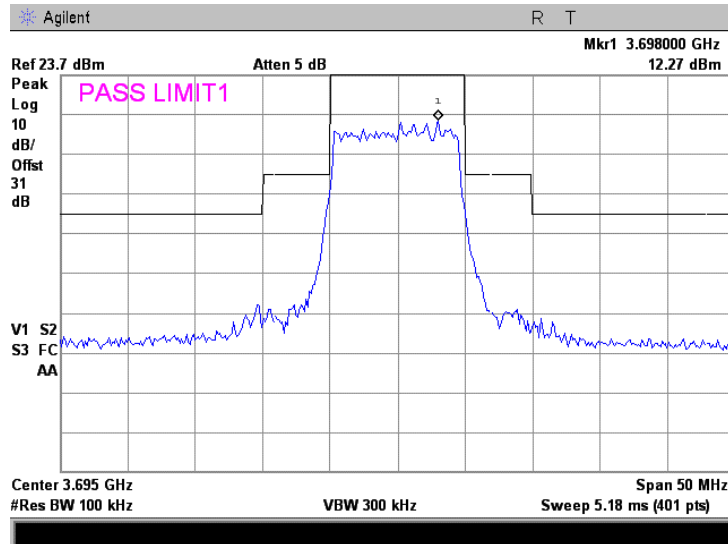



<b>Test specification:</b>		<b>Section 90.1323, Conducted spurious emissions</b>	
<b>Test procedure:</b>		47 CFR, Sections 2.1051 and 90.1323	
<b>Test mode:</b>	Compliance	<b>Verdict:</b>	PASS
<b>Date:</b>	12/26/2007		
<b>Temperature:</b> 21°C	<b>Air Pressure:</b> 1010 hPa	<b>Relative Humidity:</b> 45%	<b>Power Supply:</b> 120 V AC
<b>Remarks:</b>			

## 7.4 Spurious emissions at RF antenna connector test

### 7.4.1 General

This test was performed to measure spurious emissions at RF antenna connector. Specification test limits are given in Table 7.4.1.

**Table 7.4.1 Spurious emission limits**

Frequency, MHz	ERP of spurious, dBm	
0.009 – 10 <sup>th</sup> harmonic*	Low carrier frequency	-13
	Mid carrier frequency	-13
	High carrier frequency	-13

\* - spurious emission limits do not apply to the in band emission within  $\pm 150\%$  of the authorized bandwidth from the carrier; investigated in course of emission mask testing

### 7.4.2 Test procedure

**7.4.2.1** The EUT was set up as shown in Figure 7.4.1, energized and its proper operation was checked.

**7.4.2.2** The EUT was adjusted to produce maximum available for end user RF output power.

**7.4.2.3** The spurious emission was measured with spectrum analyzer as provided in Table 7.4.2 and associated plots.

**Figure 7.4.1 Spurious emission test setup**

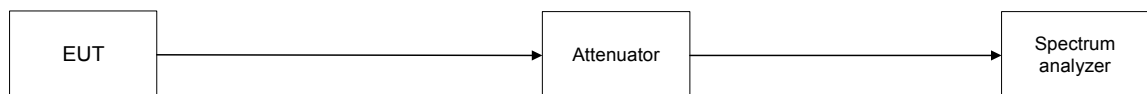

<b>Test specification:</b>		<b>Section 90.1323, Conducted spurious emissions</b>	
<b>Test procedure:</b>		47 CFR, Sections 2.1051 and 90.1323	
<b>Test mode:</b>	Compliance	<b>Verdict:</b>	PASS
<b>Date:</b>	12/26/2007		
<b>Temperature:</b> 21°C	<b>Air Pressure:</b> 1010 hPa	<b>Relative Humidity:</b> 45%	<b>Power Supply:</b> 120 V AC
<b>Remarks:</b>			

**Table 7.4.2 Spurious emission test results**

OPERATING FREQUENCY RANGE: 3655.0 – 3695.0 MHz  
 INVESTIGATED FREQUENCY RANGE: 0.009 – 40000 MHz  
 DETECTOR USED: Peak  
 VIDEO BANDWIDTH: 30 kHz  
 MODULATION: BPSK  
 BIT RATE: 2.095 Mbps  
 CHANNEL BANDWIDTH: 5 MHz  
 TRANSMITTER OUTPUT POWER SETTINGS: Maximum

Frequency, MHz	SA reading, dBm	Attenuator, dB	Cable loss, dB	RBW, kHz	Spurious emission, dBm	Attenuation below carrier, dBc	Limit, dBc	Margin, dB*	Verdict
<b>Low carrier frequency 3655.0 MHz</b>									
No spurious were found									Pass
<b>Mid carrier frequency 3675.0 MHz</b>									
No spurious were found									Pass
<b>High carrier frequency 3695.0 MHz</b>									
No spurious were found									Pass

\*- Margin = Spurious emission – specification limit.

**Reference numbers of test equipment used**

HL 2399	HL 2780						
---------	---------	--	--	--	--	--	--

Full description is given in Appendix A.

<b>Test specification:</b>	<b>Section 90.1323, Conducted spurious emissions</b>		
<b>Test procedure:</b>	47 CFR, Sections 2.1051 and 90.1323		
<b>Test mode:</b>	Compliance	<b>Verdict:</b>	<b>PASS</b>
<b>Date:</b>	12/26/2007		
<b>Temperature:</b> 21°C	<b>Air Pressure:</b> 1010 hPa	<b>Relative Humidity:</b> 45%	<b>Power Supply:</b> 120 V AC
<b>Remarks:</b>			

Plot 7.4.1 Spurious emission measurements in 9 - 150 kHz range at low carrier frequency

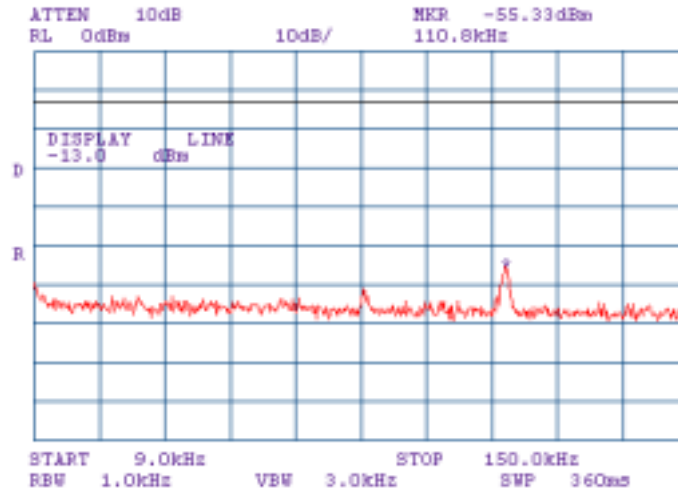

Plot 7.4.2 Spurious emission measurements in 9 - 150 kHz range at mid carrier frequency

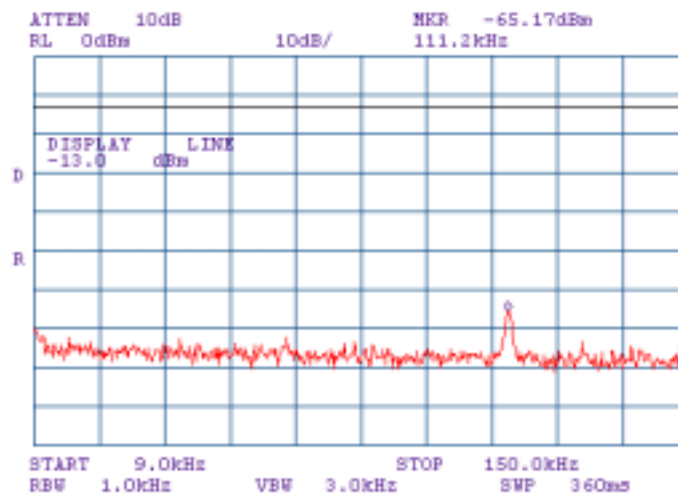

<b>Test specification:</b>		<b>Section 90.1323, Conducted spurious emissions</b>	
<b>Test procedure:</b>		47 CFR, Sections 2.1051 and 90.1323	
<b>Test mode:</b>	Compliance	<b>Verdict:</b>	PASS
<b>Date:</b>	12/26/2007		
<b>Temperature:</b> 21°C	<b>Air Pressure:</b> 1010 hPa	<b>Relative Humidity:</b> 45%	<b>Power Supply:</b> 120 V AC
<b>Remarks:</b>			

Plot 7.4.3 Spurious emission measurements in 9 - 150 kHz range at high carrier frequency

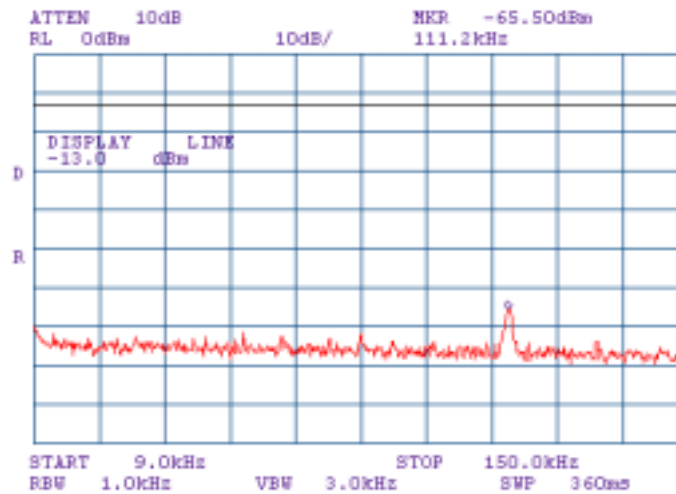

Plot 7.4.4 Spurious emission measurements in 0.15 - 30.0 MHz range at low carrier frequency

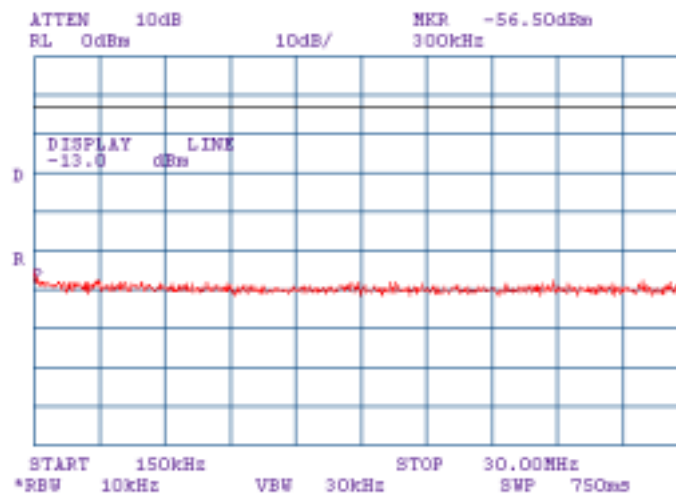

<b>Test specification:</b>	<b>Section 90.1323, Conducted spurious emissions</b>		
<b>Test procedure:</b>	47 CFR, Sections 2.1051 and 90.1323		
<b>Test mode:</b>	Compliance	<b>Verdict:</b>	<b>PASS</b>
<b>Date:</b>	12/26/2007		
<b>Temperature:</b> 21°C	<b>Air Pressure:</b> 1010 hPa	<b>Relative Humidity:</b> 45%	<b>Power Supply:</b> 120 V AC
<b>Remarks:</b>			

Plot 7.4.5 Spurious emission measurements in 0.15 - 30.0 MHz range at mid carrier frequency

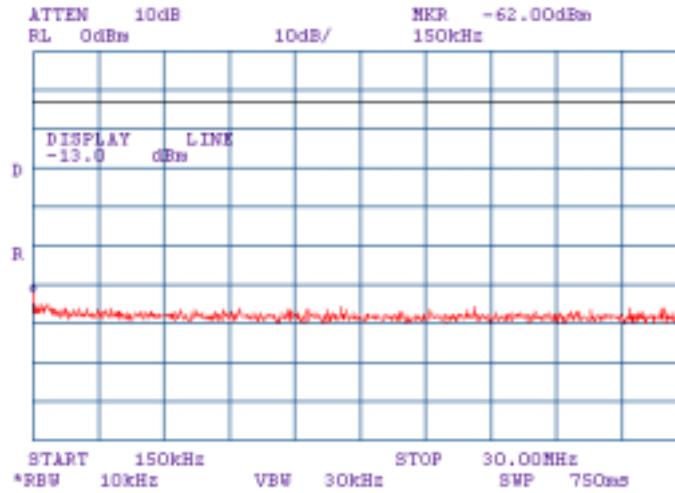

Plot 7.4.6 Spurious emission measurements in 0.15 - 30.0 MHz range at high carrier frequency

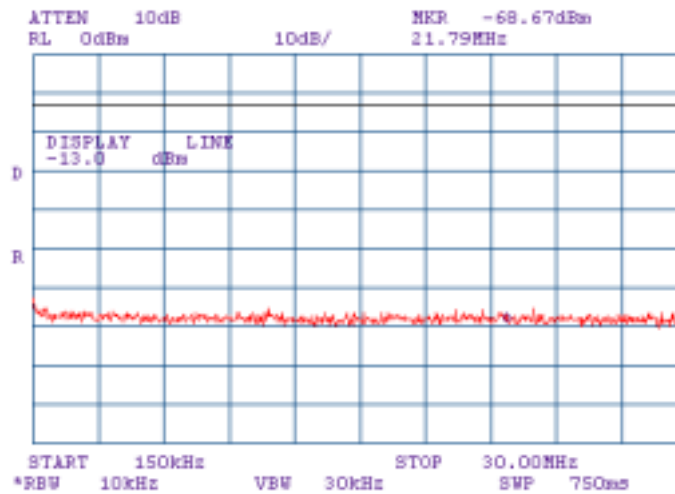

<b>Test specification:</b>	<b>Section 90.1323, Conducted spurious emissions</b>		
<b>Test procedure:</b>	47 CFR, Sections 2.1051 and 90.1323		
<b>Test mode:</b>	Compliance	<b>Verdict:</b>	<b>PASS</b>
<b>Date:</b>	12/26/2007		
<b>Temperature:</b> 21°C	<b>Air Pressure:</b> 1010 hPa	<b>Relative Humidity:</b> 45%	<b>Power Supply:</b> 120 V AC
<b>Remarks:</b>			

Plot 7.4.7 Spurious emission measurements in 30.0 - 1000 MHz range at low carrier frequency

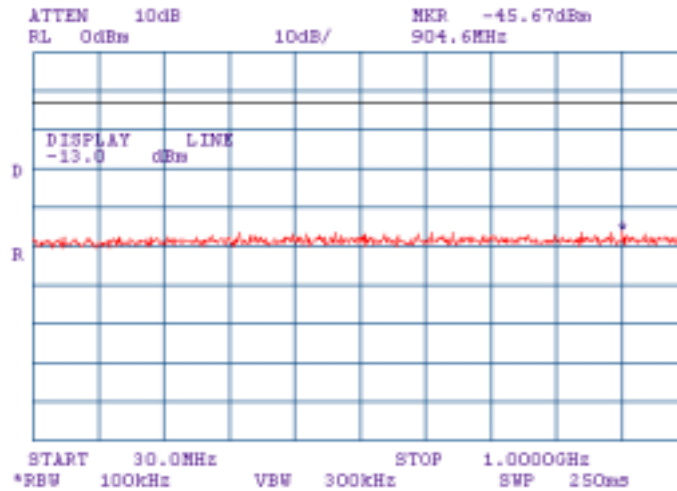

Plot 7.4.8 Spurious emission measurements in 30.0 - 1000 MHz range at mid carrier frequency

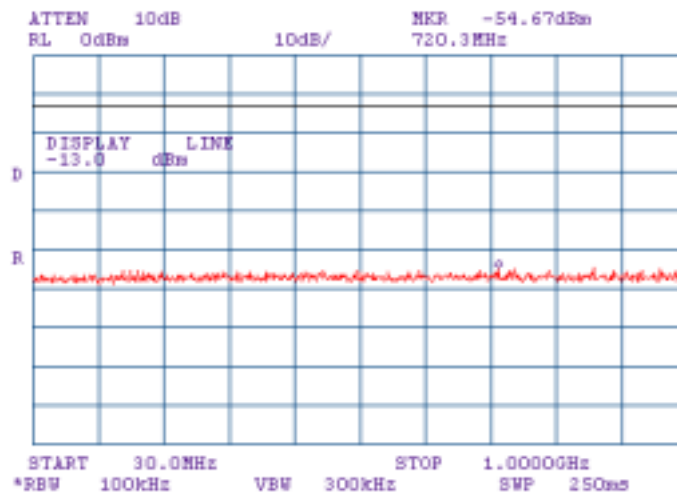

<b>Test specification:</b>		<b>Section 90.1323, Conducted spurious emissions</b>	
<b>Test procedure:</b>		47 CFR, Sections 2.1051 and 90.1323	
<b>Test mode:</b>	Compliance	<b>Verdict:</b>	PASS
<b>Date:</b>	12/26/2007		
<b>Temperature:</b> 21°C	<b>Air Pressure:</b> 1010 hPa	<b>Relative Humidity:</b> 45%	<b>Power Supply:</b> 120 V AC
<b>Remarks:</b>			

Plot 7.4.9 Spurious emission measurements in 30.0 - 1000 MHz range at high carrier frequency

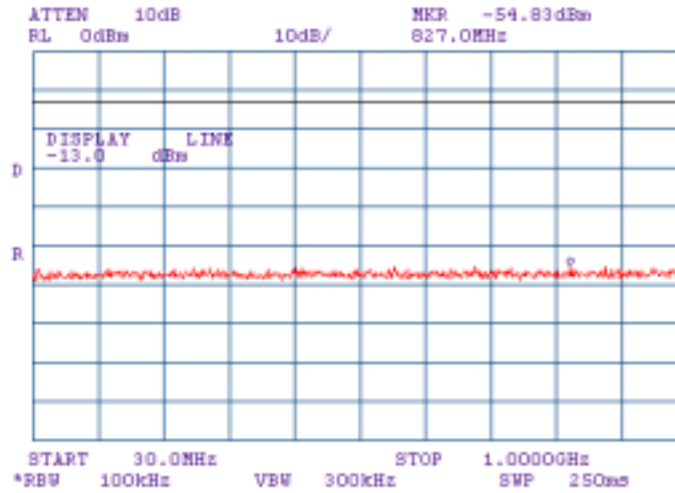

<b>Test specification:</b>	<b>Section 90.1323, Conducted spurious emissions</b>		
<b>Test procedure:</b>	47 CFR, Sections 2.1051 and 90.1323		
<b>Test mode:</b>	Compliance	<b>Verdict:</b>	<b>PASS</b>
<b>Date:</b>	12/26/2007		
<b>Temperature:</b> 21°C	<b>Air Pressure:</b> 1010 hPa	<b>Relative Humidity:</b> 45%	<b>Power Supply:</b> 120 V AC
<b>Remarks:</b>			

Plot 7.4.10 Spurious emission measurements in 1000 - 8000 MHz range at low carrier frequency

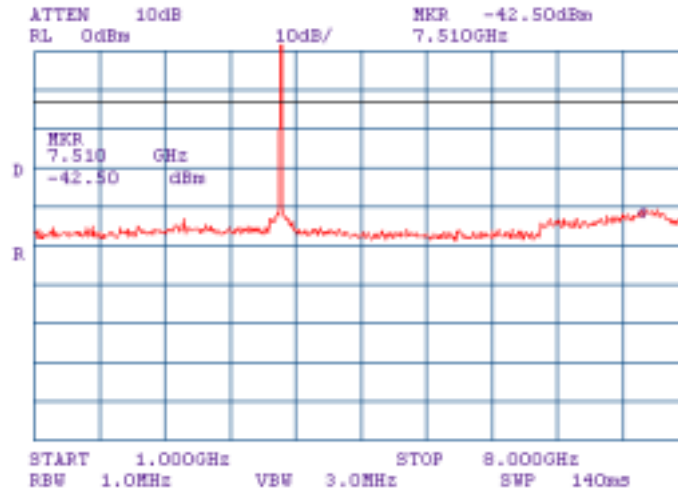

Plot 7.4.11 Spurious emission measurements in 1000 - 8000 MHz range at mid carrier frequency

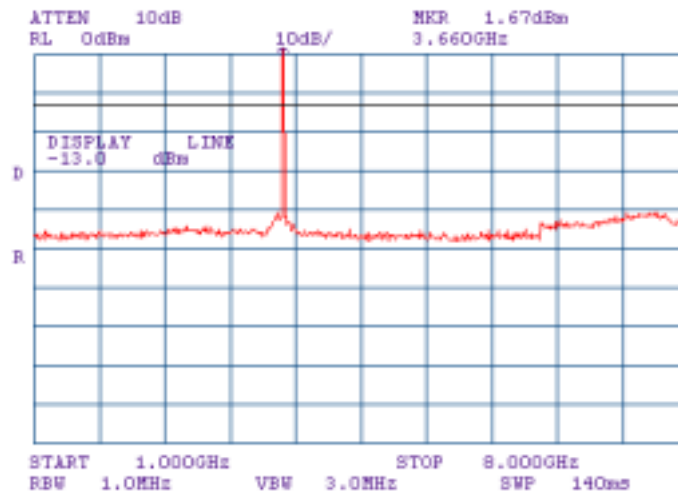



<b>Test specification:</b>	<b>Section 90.1323, Conducted spurious emissions</b>		
<b>Test procedure:</b>	47 CFR, Sections 2.1051 and 90.1323		
<b>Test mode:</b>	Compliance	<b>Verdict:</b>	<b>PASS</b>
<b>Date:</b>	12/26/2007		
<b>Temperature:</b> 21°C	<b>Air Pressure:</b> 1010 hPa	<b>Relative Humidity:</b> 45%	<b>Power Supply:</b> 120 V AC
<b>Remarks:</b>			

Plot 7.4.12 Spurious emission measurements in 1000 - 8000 MHz range at high carrier frequency

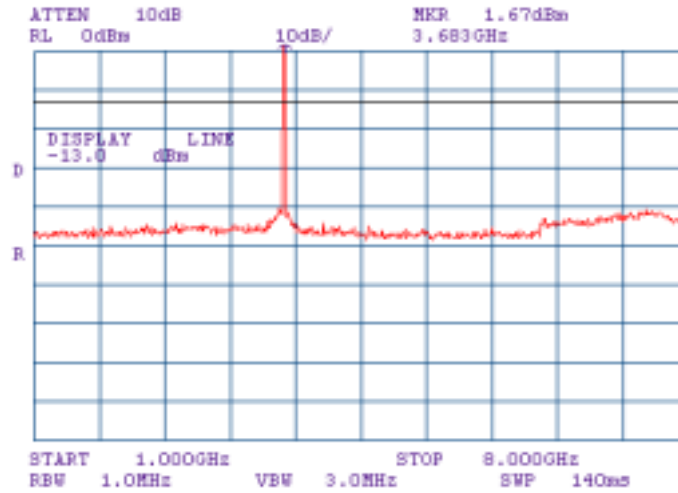

Plot 7.4.13 Spurious emission measurements in 8000 - 18000 MHz range at low carrier frequency

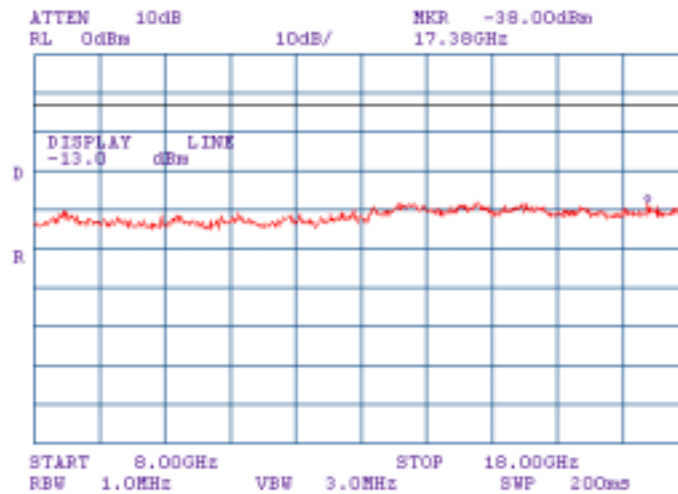

<b>Test specification:</b>	<b>Section 90.1323, Conducted spurious emissions</b>		
<b>Test procedure:</b>	47 CFR, Sections 2.1051 and 90.1323		
<b>Test mode:</b>	Compliance	<b>Verdict:</b>	<b>PASS</b>
<b>Date:</b>	12/26/2007		
<b>Temperature:</b> 21°C	<b>Air Pressure:</b> 1010 hPa	<b>Relative Humidity:</b> 45%	<b>Power Supply:</b> 120 V AC
<b>Remarks:</b>			

Plot 7.4.14 Spurious emission measurements in 8000 - 18000 MHz range at mid carrier frequency

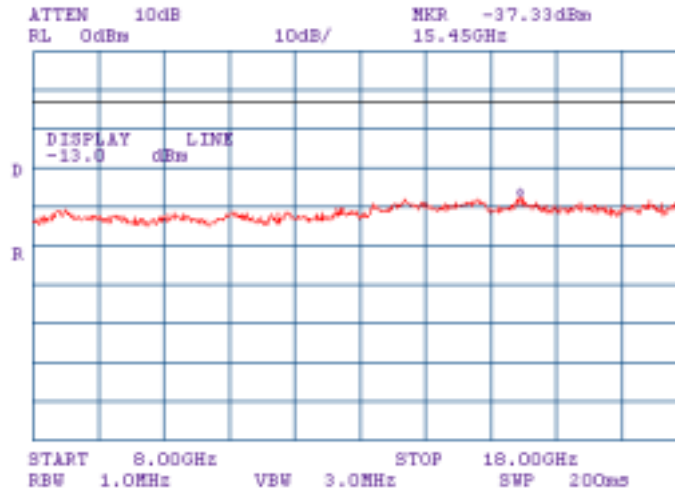

Plot 7.4.15 Spurious emission measurements in 8000 - 18000 MHz range at high carrier frequency

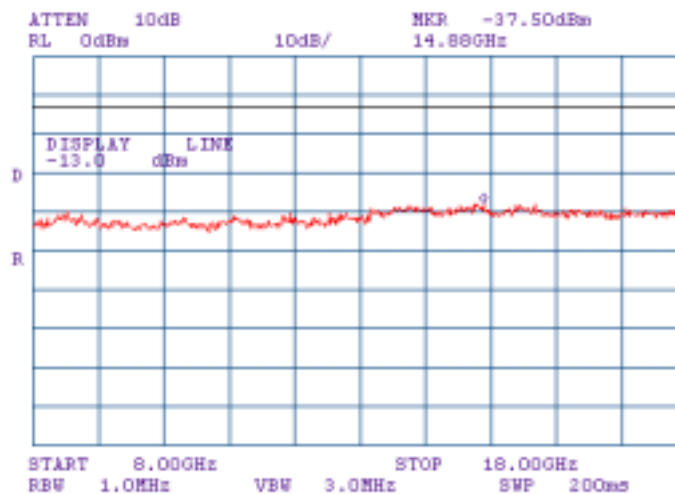

<b>Test specification:</b>	<b>Section 90.1323, Conducted spurious emissions</b>		
<b>Test procedure:</b>	47 CFR, Sections 2.1051 and 90.1323		
<b>Test mode:</b>	Compliance	<b>Verdict:</b>	<b>PASS</b>
<b>Date:</b>	12/26/2007		
<b>Temperature:</b> 21°C	<b>Air Pressure:</b> 1010 hPa	<b>Relative Humidity:</b> 45%	<b>Power Supply:</b> 120 V AC
<b>Remarks:</b>			

Plot 7.4.16 Spurious emission measurements in 18000 - 33000 MHz range at low carrier frequency

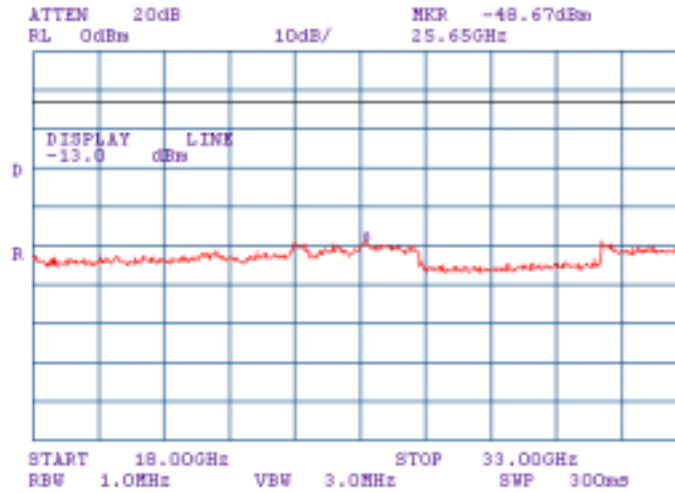

Plot 7.4.17 Spurious emission measurements in 18000 - 33000 MHz range at mid carrier frequency

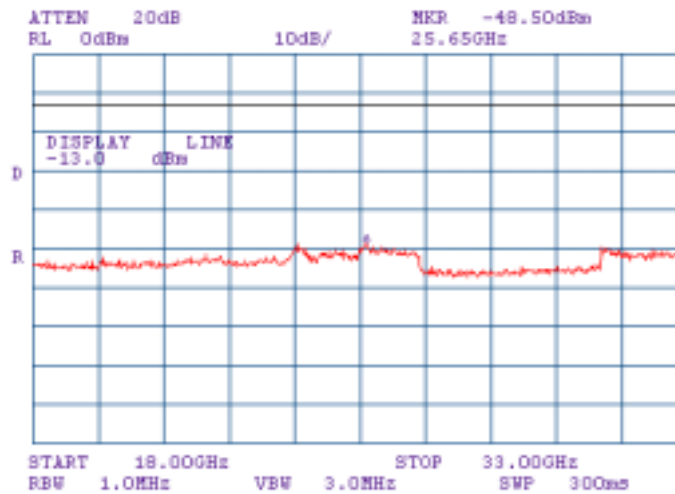

<b>Test specification:</b>		<b>Section 90.1323, Conducted spurious emissions</b>	
<b>Test procedure:</b>		47 CFR, Sections 2.1051 and 90.1323	
<b>Test mode:</b>	Compliance	<b>Verdict:</b>	PASS
<b>Date:</b>	12/26/2007		
<b>Temperature:</b> 21°C	<b>Air Pressure:</b> 1010 hPa	<b>Relative Humidity:</b> 45%	<b>Power Supply:</b> 120 V AC
<b>Remarks:</b>			

Plot 7.4.18 Spurious emission measurements in 18000 - 33000 MHz range at high carrier frequency

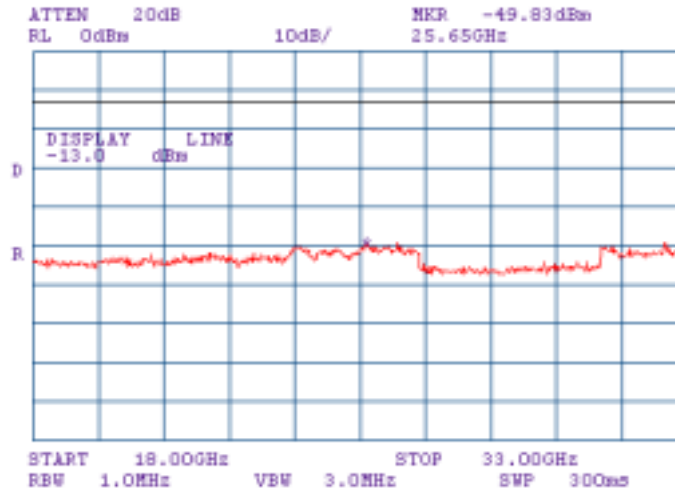

Plot 7.4.19 Spurious emission measurements in 33000 - 40000 MHz range at low carrier frequency

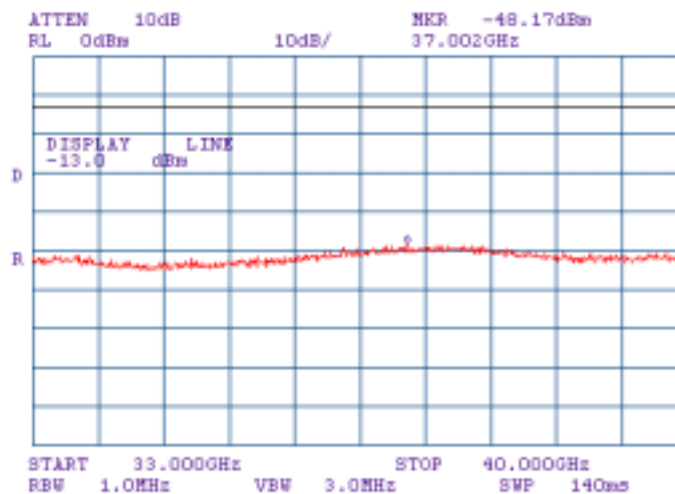

<b>Test specification:</b>		<b>Section 90.1323, Conducted spurious emissions</b>	
<b>Test procedure:</b>		47 CFR, Sections 2.1051 and 90.1323	
<b>Test mode:</b>	Compliance	<b>Verdict:</b>	PASS
<b>Date:</b>	12/26/2007		
<b>Temperature:</b> 21°C	<b>Air Pressure:</b> 1010 hPa	<b>Relative Humidity:</b> 45%	<b>Power Supply:</b> 120 V AC
<b>Remarks:</b>			

Plot 7.4.20 Spurious emission measurements in 33000 - 40000 MHz range at mid carrier frequency

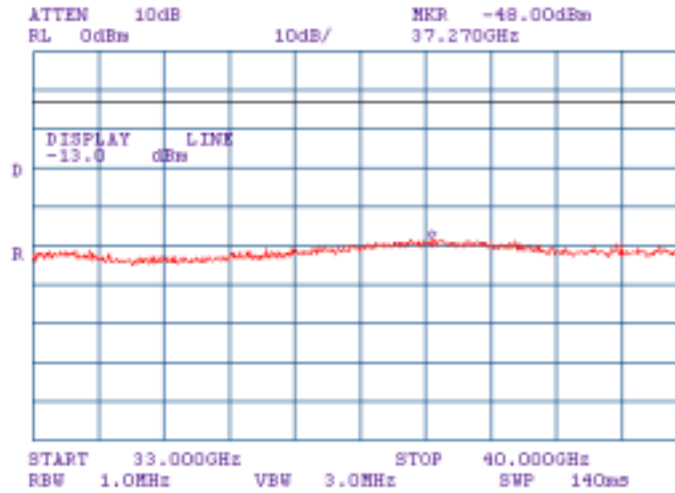

Plot 7.4.21 Spurious emission measurements in 33000 - 40000 MHz range at high carrier frequency

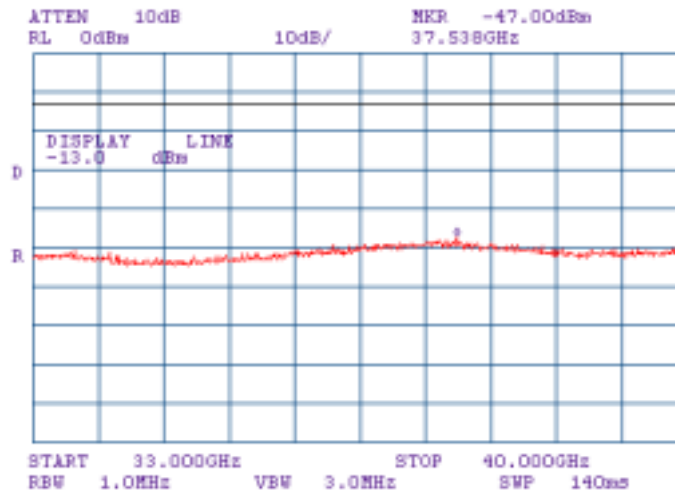

<b>Test specification:</b>		<b>Section 90.1323, Radiated spurious emissions</b>	
<b>Test procedure:</b>		47 CFR, Sections 2.1053 and 90.1323	
<b>Test mode:</b>	Compliance	<b>Verdict:</b>	PASS
<b>Date:</b>	1/2/2008		
<b>Temperature:</b> 21°C	<b>Air Pressure:</b> 1003 hPa	<b>Relative Humidity:</b> 54%	<b>Power Supply:</b> 120 V AC
<b>Remarks:</b>			

## 7.5 Radiated spurious emission measurements

### 7.5.1 General

This test was performed to measure radiated spurious emissions from the EUT. Specification test limits are given in Table 7.5.1.

Table 7.5.1 Radiated spurious emission test limits

Frequency, MHz	Attenuation below carrier dBc	ERP of spurious, dBm	Equivalent field strength limit @ 3m, dB(μV/m)***
0.009 – 10 <sup>th</sup> harmonic*	43+10logP**	-13	84.4

\* - Excluding the in band emission within ± 250 % of the authorized bandwidth from the carrier

\*\* - P is transmitter output power in Watts

\*\*\* - Equivalent field strength limit was calculated from maximum allowed ERP of spurious as follows:  $E = \sqrt{(30 \times P \times 1.64) / r}$ , where P is ERP in Watts, 1.64 is numeric gain of ideal dipole and r is antenna to EUT distance in meters

### 7.5.2 Test procedure for spurious emission field strength measurements in 9 kHz to 30 MHz band

7.5.2.1 The EUT was set up as shown in Figure 7.5.1, energized and the performance check was conducted.

7.5.2.2 The specified frequency range was investigated with antenna connected to spectrum analyzer. To find maximum radiation the turntable was rotated 360° and the measuring antenna was rotated around its vertical axis.

7.5.2.3 The worst test results (the lowest margins) were recorded in Table 7.5.2 and shown in the associated plots.

### 7.5.3 Test procedure for spurious emission field strength measurements above 30 MHz

7.5.3.1 The EUT was set up as shown in Figure 7.5.2, energized and the performance check was conducted.

7.5.3.2 The specified frequency range was investigated with antenna connected to spectrum analyzer. To find maximum radiation the turntable was rotated 360° and the measuring antenna height was swept from 1 to 4 m in both, vertical and horizontal, polarizations.

7.5.3.3 The worst test results (the lowest margins) were recorded in Table 7.5.2 and shown in the associated plots.

<b>Test specification:</b> Section 90.1323, Radiated spurious emissions			
<b>Test procedure:</b> 47 CFR, Sections 2.1053 and 90.1323			
<b>Test mode:</b> Compliance	<b>Verdict:</b> PASS		
<b>Date:</b> 1/2/2008			
<b>Temperature:</b> 21°C	<b>Air Pressure:</b> 1003 hPa	<b>Relative Humidity:</b> 54%	<b>Power Supply:</b> 120 V AC
<b>Remarks:</b>			

Figure 7.5.1 Setup for spurious emission field strength measurements in 9 kHz to 30 MHz band

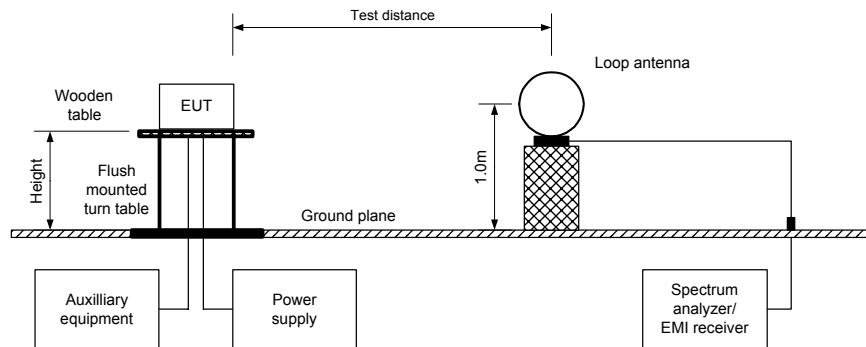
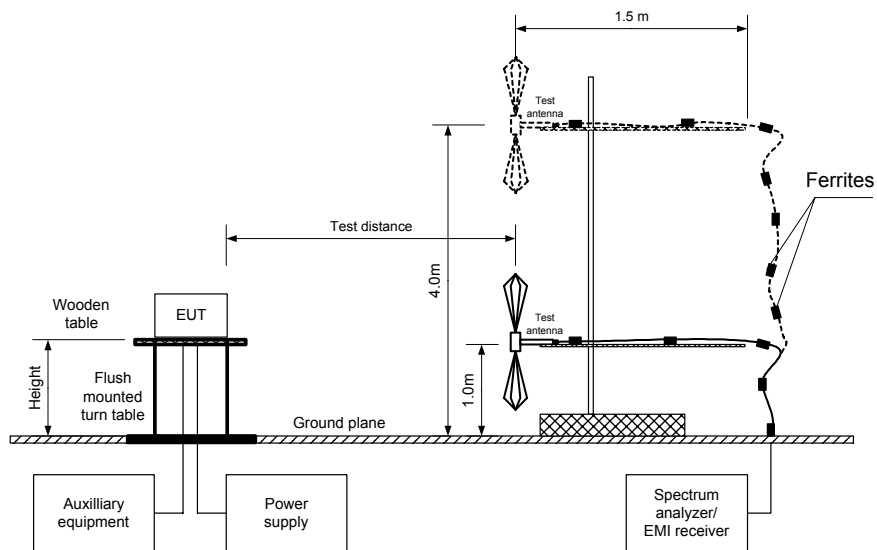

Figure 7.5.2 Setup for spurious emission field strength measurements above 30 MHz



<b>Test specification:</b>		<b>Section 90.1323, Radiated spurious emissions</b>	
<b>Test procedure:</b>		47 CFR, Sections 2.1053 and 90.1323	
<b>Test mode:</b>	Compliance	<b>Verdict:</b>	PASS
<b>Date:</b>	1/2/2008		
<b>Temperature:</b> 21°C	<b>Air Pressure:</b> 1003 hPa	<b>Relative Humidity:</b> 54%	<b>Power Supply:</b> 120 V AC
<b>Remarks:</b>			

**Table 7.5.2 Spurious emission field strength test results**

OPERATING FREQUENCY RANGE: 3655.0 – 3695.0 MHz  
TEST DISTANCE: 3 m  
TEST SITE: Semi anechoic chamber / OATS  
EUT HEIGHT: 0.8 m  
INVESTIGATED FREQUENCY RANGE: 0.009 – 40000 MHz  
DETECTOR USED: Peak  
VIDEO BANDWIDTH: > Resolution bandwidth  
TEST ANTENNA TYPE: Active loop (9 kHz – 30 MHz)  
Biconilog (30 MHz – 1000 MHz)  
Double ridged guide (above 1000 MHz)  
MODULATION: BPSK  
BIT RATE: 2.095 Mbps  
CHANNEL BANDWIDTH: 5 MHz  
TRANSMITTER OUTPUT POWER SETTINGS: Maximum

Frequency, MHz	Field strength, dB(μV/m)	Limit, dB(μV/m)	Margin, dB*	RBW, kHz	Antenna polarization	Antenna height, m	Turn-table position**, degrees
<b>Low carrier frequency 3655.0 MHz</b>							
No spurious emissions were found							
<b>Mid carrier frequency 3675.0 MHz</b>							
No spurious emissions were found							
<b>High carrier frequency 3695.0 MHz</b>							
No spurious emissions were found							

\*- Margin = Field strength of spurious – calculated field strength limit.

\*\* - EUT front panel refers to 0 degrees position of turntable.

**Reference numbers of test equipment used**

HL 0446	HL 0521	HL 0589	HL 0604	HL 1947	HL 2432		
---------	---------	---------	---------	---------	---------	--	--

Full description is given in Appendix A.



<b>Test specification:</b>	<b>Section 90.1323, Radiated spurious emissions</b>		
<b>Test procedure:</b>	47 CFR, Sections 2.1053 and 90.1323		
<b>Test mode:</b>	Compliance	<b>Verdict:</b>	<b>PASS</b>
<b>Date:</b>	1/2/2008		
<b>Temperature:</b> 21°C	<b>Air Pressure:</b> 1003 hPa	<b>Relative Humidity:</b> 54%	<b>Power Supply:</b> 120 V AC
<b>Remarks:</b>			

**Plot 7.5.1 Radiated emission measurements in 9 - 150 kHz range**

TEST SITE: Semi anechoic chamber  
 CARRIER FREQUENCY: Low  
 ANTENNA POLARIZATION: Vertical and Horizontal  
 TEST DISTANCE: 3 m

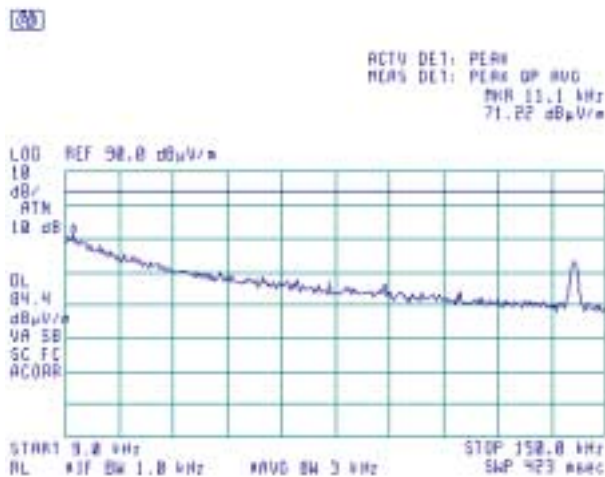

**Plot 7.5.2 Radiated emission measurements in 9 - 150 kHz range**

TEST SITE: Semi anechoic chamber  
 CARRIER FREQUENCY: Mid  
 ANTENNA POLARIZATION: Vertical and Horizontal  
 TEST DISTANCE: 3 m

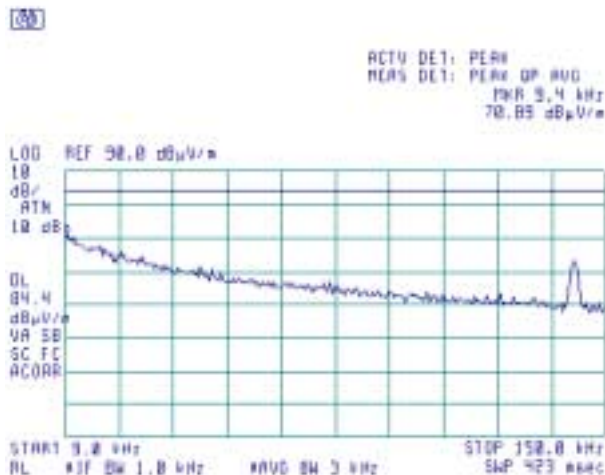

<b>Test specification:</b>	<b>Section 90.1323, Radiated spurious emissions</b>		
<b>Test procedure:</b>	47 CFR, Sections 2.1053 and 90.1323		
<b>Test mode:</b>	Compliance	<b>Verdict:</b>	<b>PASS</b>
<b>Date:</b>	1/2/2008		
<b>Temperature:</b> 21°C	<b>Air Pressure:</b> 1003 hPa	<b>Relative Humidity:</b> 54%	<b>Power Supply:</b> 120 V AC
<b>Remarks:</b>			

**Plot 7.5.3 Radiated emission measurements in 9 - 150 kHz range**

TEST SITE: Semi anechoic chamber  
 CARRIER FREQUENCY: High  
 ANTENNA POLARIZATION: Vertical and Horizontal  
 TEST DISTANCE: 3 m

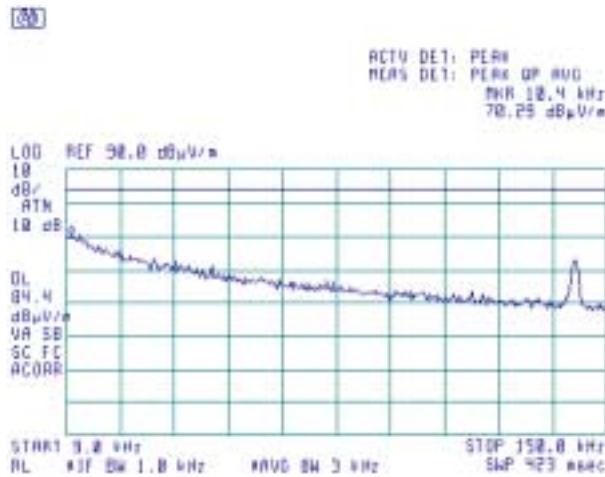

**Plot 7.5.4 Radiated emission measurements in 0.15 - 30 MHz range**

TEST SITE: Semi anechoic chamber  
 CARRIER FREQUENCY: Low  
 ANTENNA POLARIZATION: Vertical and Horizontal  
 TEST DISTANCE: 3 m

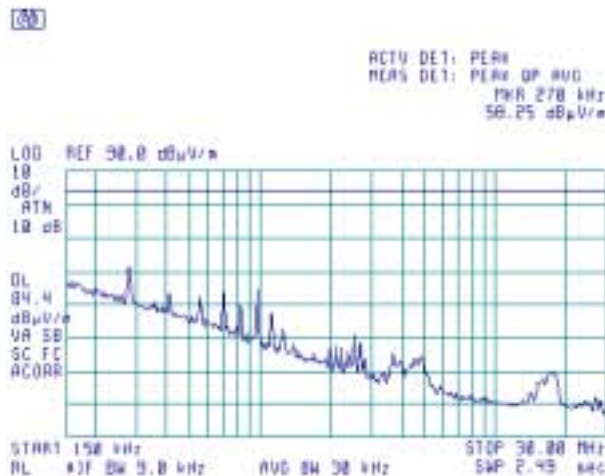

<b>Test specification:</b>		<b>Section 90.1323, Radiated spurious emissions</b>	
<b>Test procedure:</b>		47 CFR, Sections 2.1053 and 90.1323	
<b>Test mode:</b>	Compliance	<b>Verdict:</b>	PASS
<b>Date:</b>	1/2/2008		
<b>Temperature:</b> 21°C	<b>Air Pressure:</b> 1003 hPa	<b>Relative Humidity:</b> 54%	<b>Power Supply:</b> 120 V AC
<b>Remarks:</b>			

**Plot 7.5.5 Radiated emission measurements in 0.15 - 30 MHz range**

TEST SITE: Semi anechoic chamber  
 CARRIER FREQUENCY: Mid  
 ANTENNA POLARIZATION: Vertical and Horizontal  
 TEST DISTANCE: 3 m

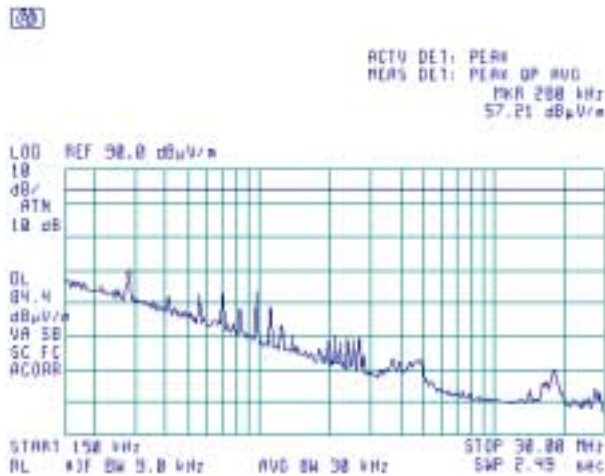

**Plot 7.5.6 Radiated emission measurements in 0.15 - 30 MHz range**

TEST SITE: Semi anechoic chamber  
 CARRIER FREQUENCY: High  
 ANTENNA POLARIZATION: Vertical and Horizontal  
 TEST DISTANCE: 3 m

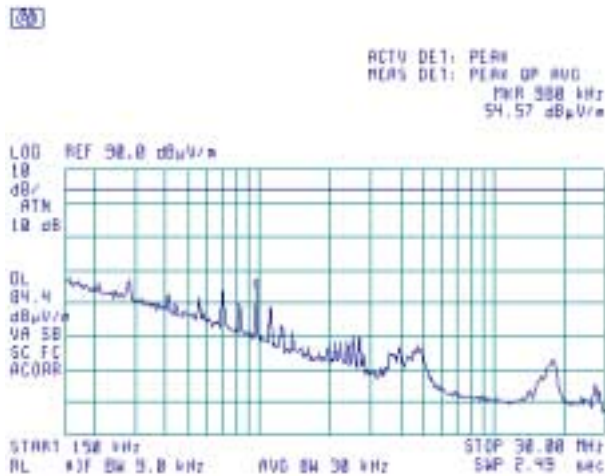

<b>Test specification:</b>		<b>Section 90.1323, Radiated spurious emissions</b>	
<b>Test procedure:</b>		47 CFR, Sections 2.1053 and 90.1323	
<b>Test mode:</b>	Compliance	<b>Verdict:</b>	PASS
<b>Date:</b>	1/2/2008		
<b>Temperature:</b> 21°C	<b>Air Pressure:</b> 1003 hPa	<b>Relative Humidity:</b> 54%	<b>Power Supply:</b> 120 V AC
<b>Remarks:</b>			

**Plot 7.5.7 Radiated emission measurements in 30 - 1000 MHz range**

TEST SITE: Semi anechoic chamber  
 CARRIER FREQUENCY: Low  
 ANTENNA POLARIZATION: Vertical and Horizontal  
 TEST DISTANCE: 3 m

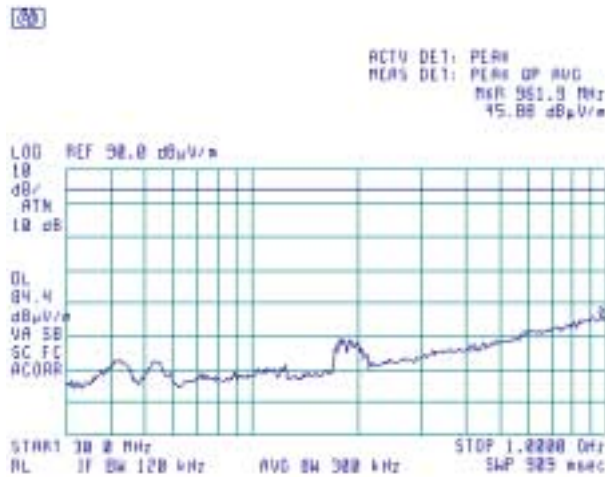

**Plot 7.5.8 Radiated emission measurements in 30 - 1000 MHz range**

TEST SITE: Semi anechoic chamber  
 CARRIER FREQUENCY: Mid  
 ANTENNA POLARIZATION: Vertical and Horizontal  
 TEST DISTANCE: 3 m

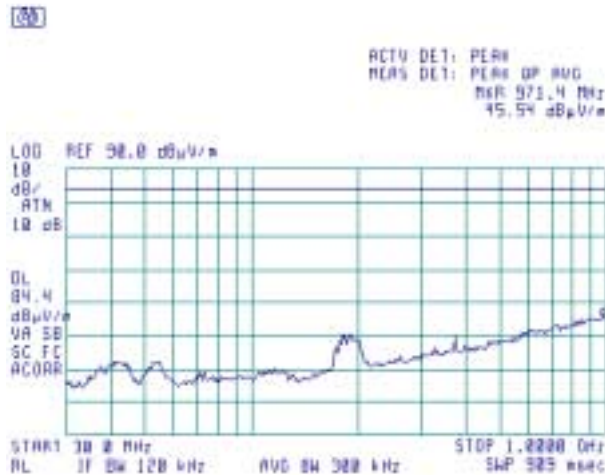

<b>Test specification:</b>	<b>Section 90.1323, Radiated spurious emissions</b>		
<b>Test procedure:</b>	47 CFR, Sections 2.1053 and 90.1323		
<b>Test mode:</b>	Compliance	<b>Verdict:</b>	<b>PASS</b>
<b>Date:</b>	1/2/2008		
<b>Temperature:</b> 21°C	<b>Air Pressure:</b> 1003 hPa	<b>Relative Humidity:</b> 54%	<b>Power Supply:</b> 120 V AC
<b>Remarks:</b>			

**Plot 7.5.9 Radiated emission measurements in 30 - 1000 MHz range**

TEST SITE: Semi anechoic chamber  
 CARRIER FREQUENCY: High  
 ANTENNA POLARIZATION: Vertical and Horizontal  
 TEST DISTANCE: 3 m

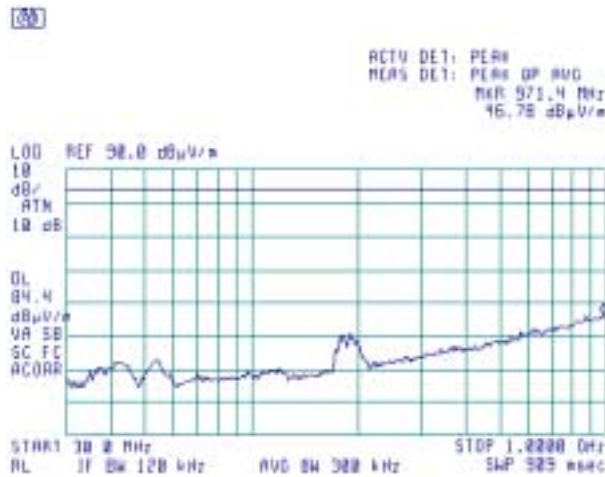

**Plot 7.5.10 Radiated emission measurements in 1000 – 2900 MHz range**

TEST SITE: Semi anechoic chamber  
 CARRIER FREQUENCY: Low  
 ANTENNA POLARIZATION: Vertical and Horizontal  
 TEST DISTANCE: 3 m

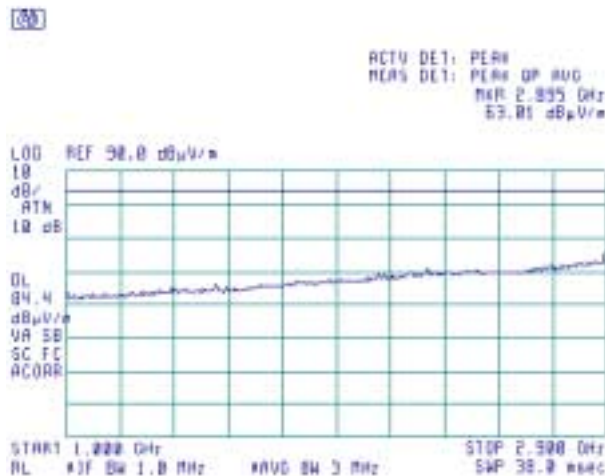

<b>Test specification:</b>		<b>Section 90.1323, Radiated spurious emissions</b>	
<b>Test procedure:</b>		47 CFR, Sections 2.1053 and 90.1323	
<b>Test mode:</b>	Compliance	<b>Verdict:</b>	PASS
<b>Date:</b>	1/2/2008		
<b>Temperature:</b> 21°C	<b>Air Pressure:</b> 1003 hPa	<b>Relative Humidity:</b> 54%	<b>Power Supply:</b> 120 V AC
<b>Remarks:</b>			

Plot 7.5.11 Radiated emission measurements in 1000 – 2900 MHz range

TEST SITE: Semi anechoic chamber  
 CARRIER FREQUENCY: Mid  
 ANTENNA POLARIZATION: Vertical and Horizontal  
 TEST DISTANCE: 3 m

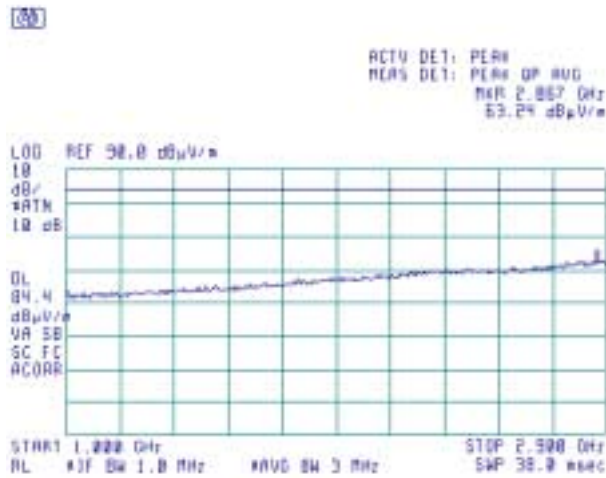

Plot 7.5.12 Radiated emission measurements in 1000 – 2900 MHz range

TEST SITE: Semi anechoic chamber  
 CARRIER FREQUENCY: High  
 ANTENNA POLARIZATION: Vertical and Horizontal  
 TEST DISTANCE: 3 m

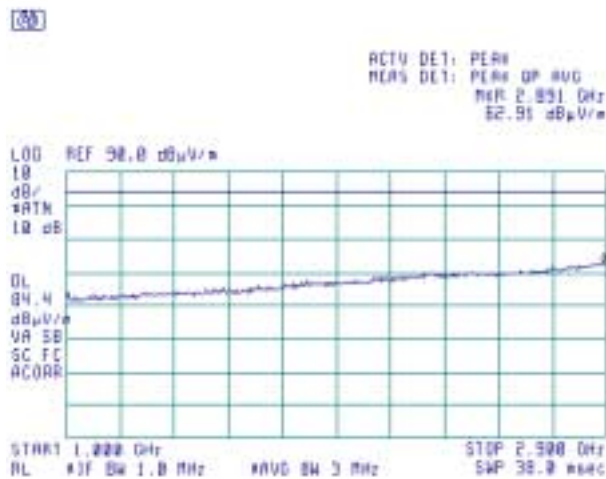

<b>Test specification:</b>	<b>Section 90.1323, Radiated spurious emissions</b>		
<b>Test procedure:</b>	47 CFR, Sections 2.1053 and 90.1323		
<b>Test mode:</b>	Compliance	<b>Verdict:</b>	<b>PASS</b>
<b>Date:</b>	1/2/2008		
<b>Temperature:</b> 21°C	<b>Air Pressure:</b> 1003 hPa	<b>Relative Humidity:</b> 54%	<b>Power Supply:</b> 120 V AC
<b>Remarks:</b>			

Plot 7.5.13 Radiated emission measurements in 2900 – 4000 MHz range

TEST SITE: Semi anechoic chamber  
 CARRIER FREQUENCY: Low  
 ANTENNA POLARIZATION: Vertical and Horizontal  
 TEST DISTANCE: 3 m

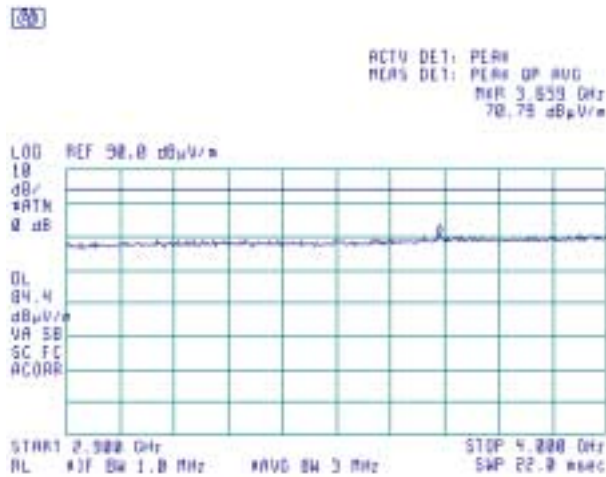

Plot 7.5.14 Radiated emission measurements in 2900 – 4000 MHz range

TEST SITE: Semi anechoic chamber  
 CARRIER FREQUENCY: Mid  
 ANTENNA POLARIZATION: Vertical and Horizontal  
 TEST DISTANCE: 3 m

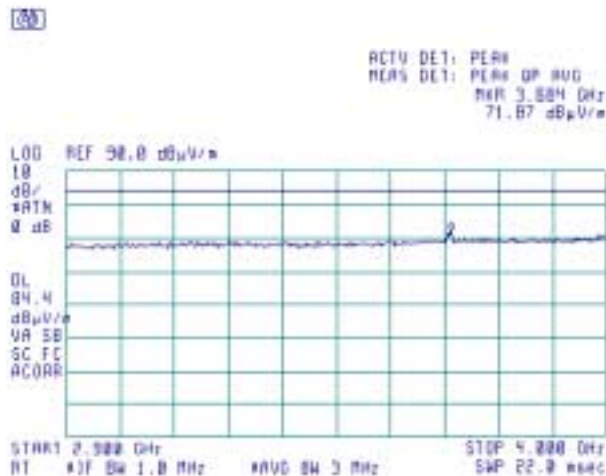

<b>Test specification:</b>		<b>Section 90.1323, Radiated spurious emissions</b>	
<b>Test procedure:</b>		47 CFR, Sections 2.1053 and 90.1323	
<b>Test mode:</b>	Compliance	<b>Verdict:</b>	PASS
<b>Date:</b>	1/2/2008		
<b>Temperature:</b> 21°C	<b>Air Pressure:</b> 1003 hPa	<b>Relative Humidity:</b> 54%	<b>Power Supply:</b> 120 V AC
<b>Remarks:</b>			

Plot 7.5.15 Radiated emission measurements in 2900 – 4000 MHz range

TEST SITE:	Semi anechoic chamber
CARRIER FREQUENCY:	High
ANTENNA POLARIZATION:	Vertical and Horizontal
TEST DISTANCE:	3 m

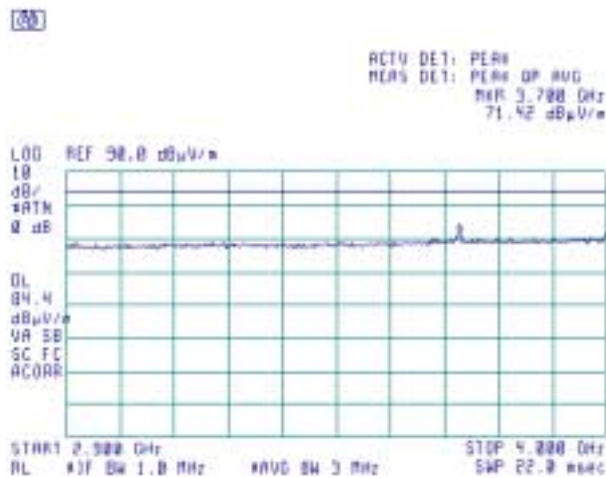

Plot 7.5.16 Radiated emission measurements in 4000 – 6500 MHz range

TEST SITE:	Semi anechoic chamber
CARRIER FREQUENCY:	Low
ANTENNA POLARIZATION:	Vertical and Horizontal
TEST DISTANCE:	3 m

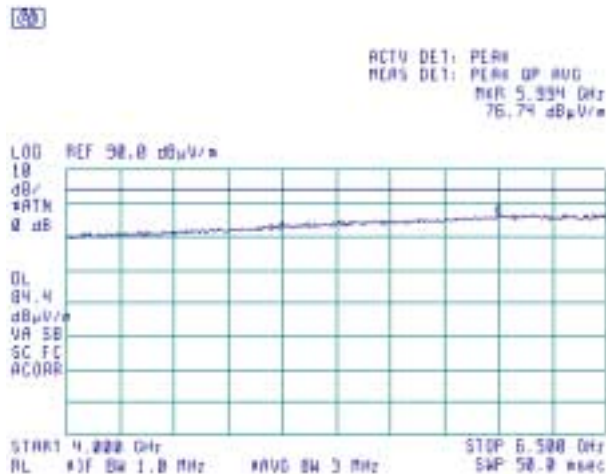



<b>Test specification:</b>	<b>Section 90.1323, Radiated spurious emissions</b>		
<b>Test procedure:</b>	47 CFR, Sections 2.1053 and 90.1323		
<b>Test mode:</b>	Compliance	<b>Verdict:</b>	<b>PASS</b>
<b>Date:</b>	1/2/2008		
<b>Temperature:</b> 21°C	<b>Air Pressure:</b> 1003 hPa	<b>Relative Humidity:</b> 54%	<b>Power Supply:</b> 120 V AC
<b>Remarks:</b>			

Plot 7.5.17 Radiated emission measurements in 4000 – 6500 MHz range

TEST SITE: Semi anechoic chamber  
 CARRIER FREQUENCY: Mid  
 ANTENNA POLARIZATION: Vertical and Horizontal  
 TEST DISTANCE: 3 m

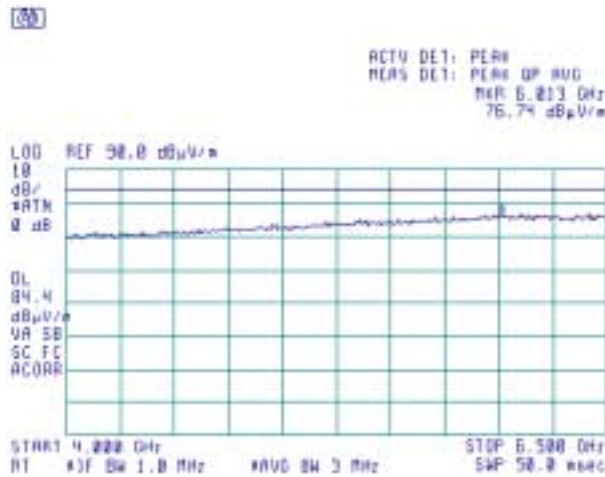

Plot 7.5.18 Radiated emission measurements in 4000 – 6500 MHz range

TEST SITE: Semi anechoic chamber  
 CARRIER FREQUENCY: High  
 ANTENNA POLARIZATION: Vertical and Horizontal  
 TEST DISTANCE: 3 m

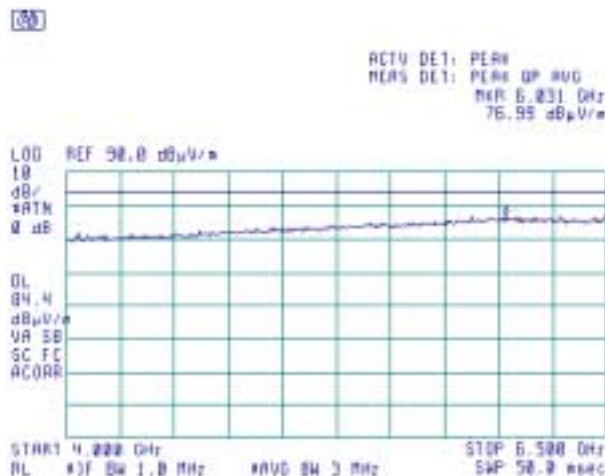

<b>Test specification:</b> Section 90.1323, Radiated spurious emissions			
<b>Test procedure:</b> 47 CFR, Sections 2.1053 and 90.1323			
<b>Test mode:</b> Compliance	<b>Verdict:</b> PASS		
<b>Date:</b> 1/2/2008			
<b>Temperature:</b> 21°C	<b>Air Pressure:</b> 1003 hPa	<b>Relative Humidity:</b> 54%	<b>Power Supply:</b> 120 V AC
<b>Remarks:</b>			

Plot 7.5.19 Radiated emission measurements in 6500 – 18000 MHz range

TEST SITE: Semi anechoic chamber  
 CARRIER FREQUENCY: Low  
 ANTENNA POLARIZATION: Vertical and Horizontal  
 TEST DISTANCE: 3 m

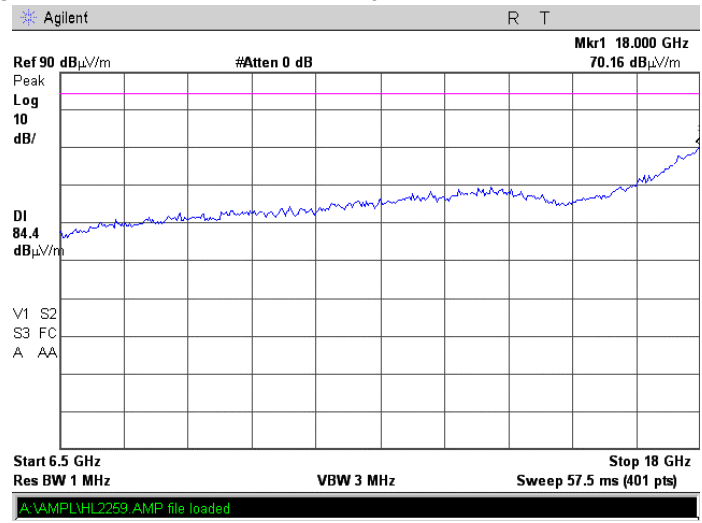

Plot 7.5.20 Radiated emission measurements in 6500 – 18000 MHz range

TEST SITE: Semi anechoic chamber  
 CARRIER FREQUENCY: Mid  
 ANTENNA POLARIZATION: Vertical and Horizontal  
 TEST DISTANCE: 3 m

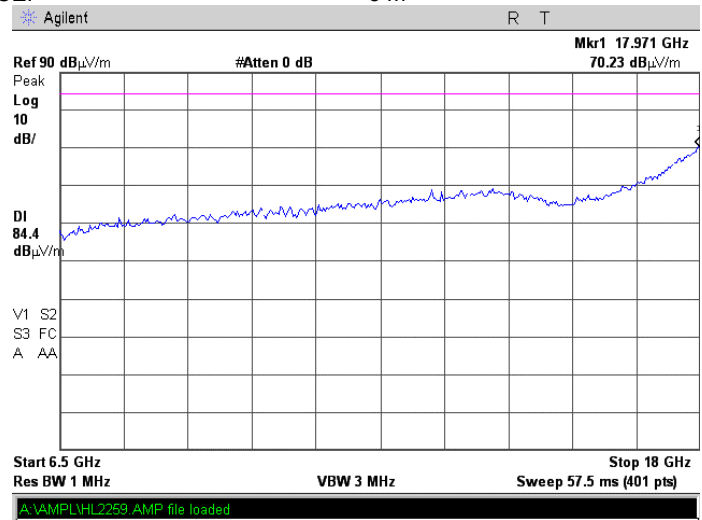

<b>Test specification:</b>	<b>Section 90.1323, Radiated spurious emissions</b>		
<b>Test procedure:</b>	47 CFR, Sections 2.1053 and 90.1323		
<b>Test mode:</b>	Compliance	<b>Verdict:</b>	<b>PASS</b>
<b>Date:</b>	1/2/2008		
<b>Temperature:</b> 21°C	<b>Air Pressure:</b> 1003 hPa	<b>Relative Humidity:</b> 54%	<b>Power Supply:</b> 120 V AC
<b>Remarks:</b>			

**Plot 7.5.21 Radiated emission measurements in 6500 – 18000 MHz range**

TEST SITE: Semi anechoic chamber  
 CARRIER FREQUENCY: High  
 ANTENNA POLARIZATION: Vertical and Horizontal  
 TEST DISTANCE: 3 m

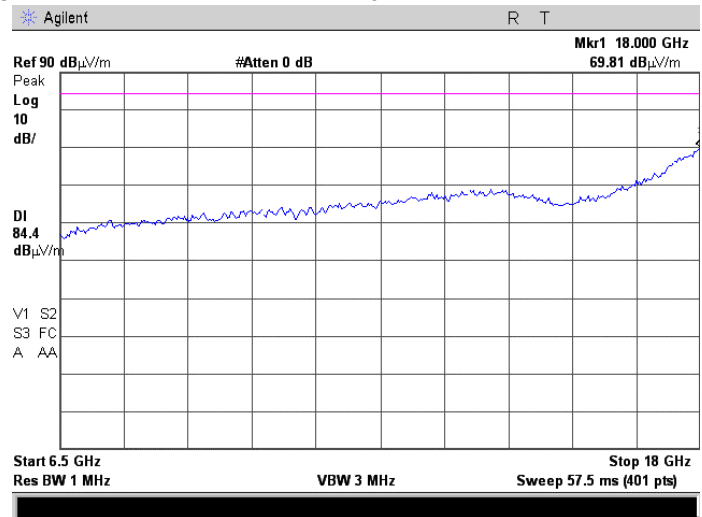

**Plot 7.5.22 Radiated emission measurements in 18000 – 26500 MHz range**

TEST SITE: OATS  
 CARRIER FREQUENCY: Low  
 ANTENNA POLARIZATION: Vertical and Horizontal  
 TEST DISTANCE: 3 m

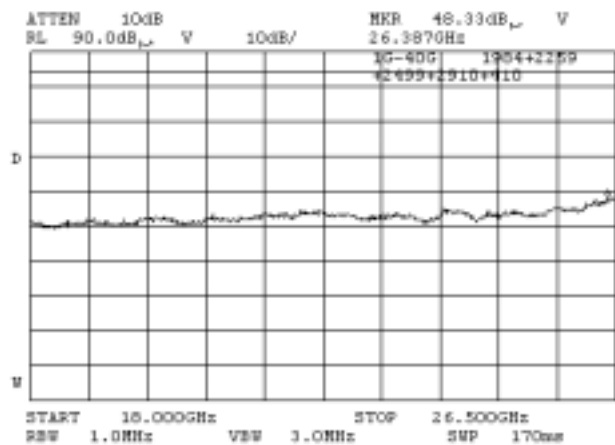

<b>Test specification:</b> Section 90.1323, Radiated spurious emissions			
<b>Test procedure:</b> 47 CFR, Sections 2.1053 and 90.1323			
<b>Test mode:</b> Compliance			<b>Verdict:</b> PASS
<b>Date:</b> 1/2/2008			
<b>Temperature:</b> 21°C	<b>Air Pressure:</b> 1003 hPa	<b>Relative Humidity:</b> 54%	<b>Power Supply:</b> 120 V AC
<b>Remarks:</b>			

Plot 7.5.23 Radiated emission measurements in 18000 – 26500 MHz range

TEST SITE: OATS  
 CARRIER FREQUENCY: Mid  
 ANTENNA POLARIZATION: Vertical and Horizontal  
 TEST DISTANCE: 3 m

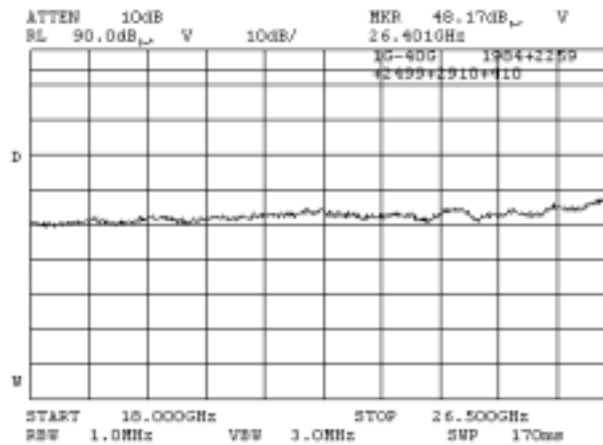

Plot 7.5.24 Radiated emission measurements in 18000 – 26500 MHz range

TEST SITE: OATS  
 CARRIER FREQUENCY: High  
 ANTENNA POLARIZATION: Vertical and Horizontal  
 TEST DISTANCE: 3 m

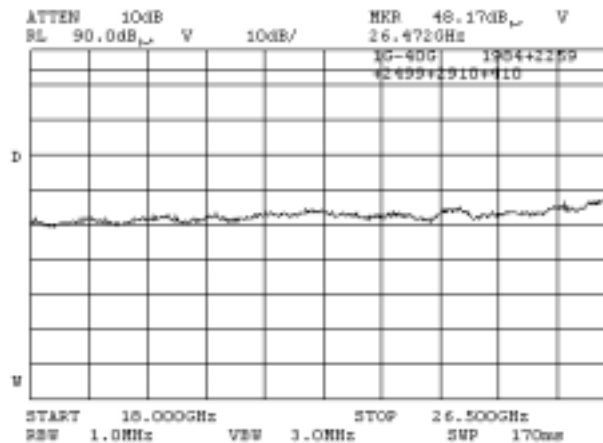

<b>Test specification:</b> Section 90.1323, Radiated spurious emissions			
<b>Test procedure:</b> 47 CFR, Sections 2.1053 and 90.1323			
<b>Test mode:</b> Compliance		<b>Verdict:</b> PASS	
<b>Date:</b> 1/2/2008			
<b>Temperature:</b> 21°C	<b>Air Pressure:</b> 1003 hPa	<b>Relative Humidity:</b> 54%	<b>Power Supply:</b> 120 V AC
<b>Remarks:</b>			

Plot 7.5.25 Radiated emission measurements in 26500-33000 MHz range

TEST SITE: OATS  
 CARRIER FREQUENCY: Low  
 ANTENNA POLARIZATION: Vertical and Horizontal  
 TEST DISTANCE: 3 m

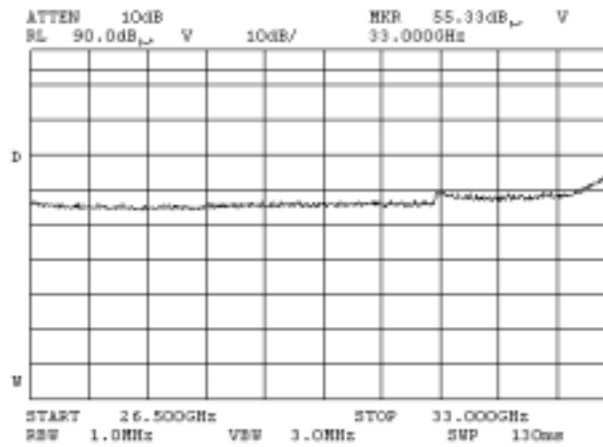

Plot 7.5.26 Radiated emission measurements in 26500-33000 MHz range

TEST SITE: OATS  
 CARRIER FREQUENCY: Mid  
 ANTENNA POLARIZATION: Vertical and Horizontal  
 TEST DISTANCE: 3 m

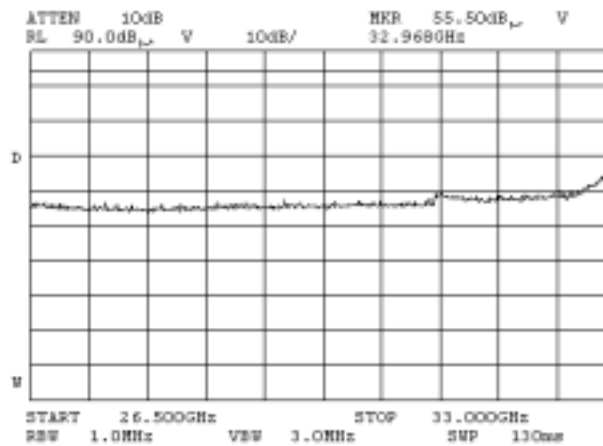

<b>Test specification:</b>		<b>Section 90.1323, Radiated spurious emissions</b>	
<b>Test procedure:</b>		47 CFR, Sections 2.1053 and 90.1323	
<b>Test mode:</b>	Compliance	<b>Verdict:</b>	PASS
<b>Date:</b>	1/2/2008		
<b>Temperature:</b> 21°C	<b>Air Pressure:</b> 1003 hPa	<b>Relative Humidity:</b> 54%	<b>Power Supply:</b> 120 V AC
<b>Remarks:</b>			

**Plot 7.5.27 Radiated emission measurements in 26500-33000 MHz range**

TEST SITE: OATS  
 CARRIER FREQUENCY: High  
 ANTENNA POLARIZATION: Vertical and Horizontal  
 TEST DISTANCE: 3 m

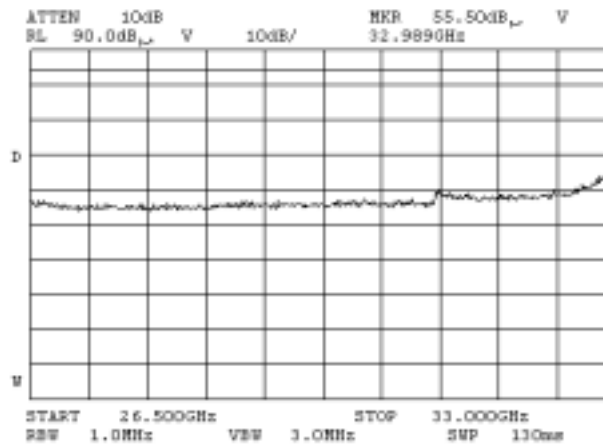

**Plot 7.5.28 Radiated emission measurements in 33000-40000 MHz range**

TEST SITE: OATS  
 CARRIER FREQUENCY: Low  
 ANTENNA POLARIZATION: Vertical and Horizontal  
 TEST DISTANCE: 3 m

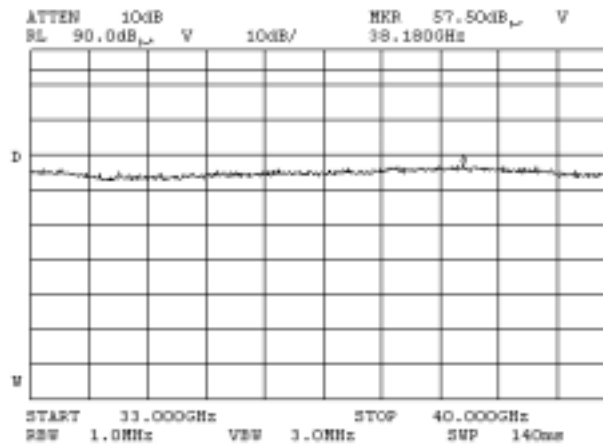

<b>Test specification:</b>	<b>Section 90.1323, Radiated spurious emissions</b>		
<b>Test procedure:</b>	47 CFR, Sections 2.1053 and 90.1323		
<b>Test mode:</b>	Compliance	<b>Verdict:</b>	<b>PASS</b>
<b>Date:</b>	1/2/2008		
<b>Temperature:</b> 21°C	<b>Air Pressure:</b> 1003 hPa	<b>Relative Humidity:</b> 54%	<b>Power Supply:</b> 120 V AC
<b>Remarks:</b>			

**Plot 7.5.29 Radiated emission measurements in 33000-40000 MHz range**

TEST SITE: OATS  
 CARRIER FREQUENCY: Mid  
 ANTENNA POLARIZATION: Vertical and Horizontal  
 TEST DISTANCE: 3 m

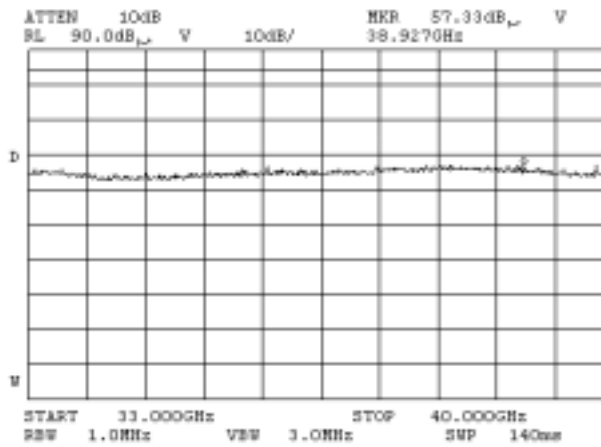

**Plot 7.5.30 Radiated emission measurements in 33000-40000 MHz range**

TEST SITE: OATS  
 CARRIER FREQUENCY: High  
 ANTENNA POLARIZATION: Vertical and Horizontal  
 TEST DISTANCE: 3 m

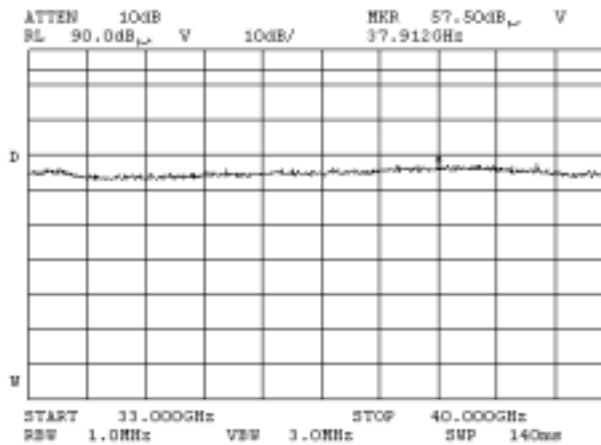

<b>Test specification:</b>	<b>Section 90.213, Frequency stability</b>		
<b>Test procedure:</b>	47 CFR, Section 2.1055; TIA/EIA-603-C Section 2.2.2		
<b>Test mode:</b>	Compliance	<b>Verdict:</b>	<b>PASS</b>
<b>Date:</b>	12/30/2007		
<b>Temperature:</b> 24°C	<b>Air Pressure:</b> 1018 hPa	<b>Relative Humidity:</b> 36%	<b>Power Supply:</b> 120 VAC
<b>Remarks:</b>			

## 7.6 Frequency stability test

### 7.6.1 General

This test was performed to measure frequency stability of transmitter RF carrier. Specification test limits are given in Table 7.6.1.

Table 7.6.1 Frequency stability limits

Operating frequency, MHz	Maximum allowed frequency displacement	
	ppm	Hz
3655.000	20	73100
3675.000		73500
3695.000		73900

### 7.6.2 Test procedure

- 7.6.2.1 The EUT was set up as shown in Figure 7.6.1, energized and its proper operation was checked.
- 7.6.2.2 The EUT power was turned off. Temperature within test chamber was set to +30°C and a period of time sufficient to stabilize all of the oscillator circuit components was allowed.
- 7.6.2.3 The EUT was powered on and carrier frequency was measured at start up moment and then every minute until frequency had been stabilized or 10 minutes elapsed whichever reached the last. The EUT was powered off.
- 7.6.2.4 The above procedure was repeated at 0°C and at the lowest test temperature.
- 7.6.2.5 The EUT was powered on and carrier frequency was measured at start up moment and at the end of stabilization period at the rest of test temperatures and voltages. The EUT was powered off.
- 7.6.2.6 Frequency displacement was calculated and compared with the limit as provided in Table 7.6.2.

Figure 7.6.1 Frequency stability test setup

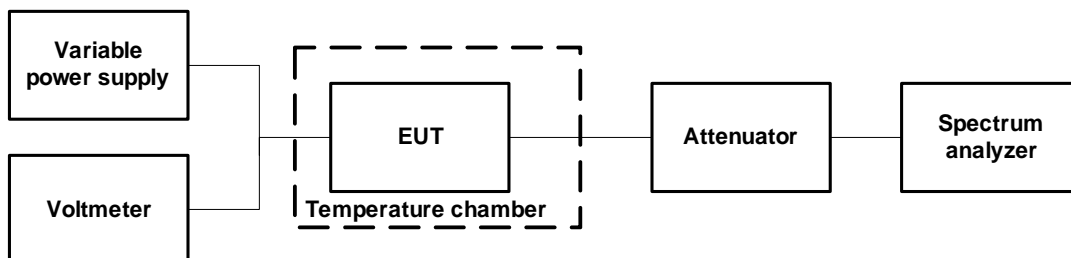



<b>Test specification:</b>		<b>Section 90.213, Frequency stability</b>			
<b>Test procedure:</b>		47 CFR, Section 2.1055; TIA/EIA-603-C Section 2.2.2			
<b>Test mode:</b>	Compliance	<b>Verdict:</b>		<b>PASS</b>	
<b>Date:</b>	12/30/2007				
<b>Temperature:</b> 24°C	<b>Air Pressure:</b> 1018 hPa	<b>Relative Humidity:</b> 36%	<b>Power Supply:</b> 120 VAC		
<b>Remarks:</b>					

Table 7.6.2 Frequency stability test results

OPERATING FREQUENCY RANGE: 3655.0 – 3695.0 MHz  
 NOMINAL POWER VOLTAGE: 120 VAC  
 TEMPERATURE STABILIZATION PERIOD: 20 min  
 POWER DURING TEMPERATURE TRANSITION: Off  
 SPECTRUM ANALYZER MODE: peak  
 RESOLUTION BANDWIDTH: 1000 Hz  
 VIDEO BANDWIDTH: 3000 Hz  
 MODULATION: Unmodulated

f, α	Voltage V	Frequency, MHz							Max frequency drift, Hz		Limit, Hz	Margin, Hz	Verdict
		Start up	1 <sup>st</sup> min	2 <sup>nd</sup> min	3 <sup>rd</sup> min	4 <sup>th</sup> min	5 <sup>th</sup> min	10 <sup>th</sup> min	positiv	negativ			
<b>Low frequency 3655.0 MHz</b>													
-30	nominal	3654.937427	3654.937787	3654.938312	3654.93872	3654.93903	3654.93942	3654.940130	0	-7723	73100	-65377	Pass
-20	nominal	3654.940276	NA	NA	NA	NA	NA	3654.942127	0	-4874		-68226	Pass
-10	nominal	3654.941591	NA	NA	NA	NA	NA	3654.943585	0	-3559		-69541	Pass
0	nominal	3654.943151	3654.943665	3654.943913	3654.94411	3654.94330	3654.94343	3654.944676	0	-1999		-71101	Pass
10	nominal	3654.945176	NA	NA	NA	NA	NA	3654.945144	26	-6		-73074	Pass
20	15%	3654.950000	NA	NA	NA	NA	NA	3654.945162	4850	0		-68250	Pass
20	nominal	3654.940000	NA	NA	NA	NA	NA	3654.945150*	0	-5150		-67950	Pass
20	-15%	3654.962500	NA	NA	NA	NA	NA	3654.945150	17350	0		-55750	Pass
30	nominal	3654.944613	3654.944664	3654.944692	3654.94473	3654.94475	3654.94479	3654.944844	0	-537		-72563	Pass
40	nominal	3654.944743	NA	NA	NA	NA	NA	3654.945864	714	-407		-72386	Pass
50	nominal	3654.945602	NA	NA	NA	NA	NA	3654.948699	3549	0		-69551	Pass
<b>Mid frequency 3675.0 MHz</b>													
-30	nominal	3674.938639	3674.939103	3674.939336	3674.93950	3674.93968	3674.93973	3674.939991	0	-6136	73500	-67364	Pass
-20	nominal	3674.941421	NA	NA	NA	NA	NA	3674.941919	0	-3354		-70146	Pass
-10	nominal	3674.942501	NA	NA	NA	NA	NA	3674.943332	0	-2274		-71226	Pass
0	nominal	3674.943873	3674.944205	3674.944245	3674.94431	3674.94434	3674.94435	3674.944381	0	-902		-72598	Pass
10	nominal	3674.944665	NA	NA	NA	NA	NA	3674.944618	0	-157		-73343	Pass
20	15%	3674.962512	NA	NA	NA	NA	NA	3674.944787	17737	0		-55763	Pass
20	nominal	3674.962532	NA	NA	NA	NA	NA	3674.944775*	17757	0		-55743	Pass
20	-15%	3674.957412	NA	NA	NA	NA	NA	3674.944800	12637	0		-60863	Pass
30	nominal	3674.944357	3674.944266	3674.944235	3674.94421	3674.94422	3674.94424	3674.944406	0	-556		-72944	Pass
40	nominal	3674.944908	NA	NA	NA	NA	NA	3674.945230	455	0		-73045	Pass
50	nominal	3674.947495	NA	NA	NA	NA	NA	3674.948903	4128	0		-69372	Pass
<b>High frequency 3695.0 MHz</b>													
-30	nominal	3694.937968	3694.938542	3694.938799	3694.93912	3694.93915	3694.93931	3694.939538	0	-6447	73900	-67453	Pass
-20	nominal	3694.940761	NA	NA	NA	NA	NA	3694.941270	0	-3654		-70246	Pass
-10	nominal	3694.942485	NA	NA	NA	NA	NA	3694.940939	0	-3476		-70424	Pass
0	nominal	3694.942698	3694.942988	3694.943281	3694.94350	3694.94365	3694.94378	3694.943352	0	-1717		-72183	Pass
10	nominal	3694.944158	NA	NA	NA	NA	NA	3694.944199	0	-257		-73643	Pass
20	15%	3694.944317	NA	NA	NA	NA	NA	3694.944439	24	-98		-73802	Pass
20	nominal	3694.944325	NA	NA	NA	NA	NA	3694.944415	0	-90		-73810	Pass
20	-15%	3694.944375	NA	NA	NA	NA	NA	3694.944388	0	-40		-73860	Pass
30	nominal	3694.943873	3694.943828	3694.943819	3694.94382	3694.94384	3694.94386	3694.944006	0	-596		-73304	Pass
40	nominal	3694.945003	NA	NA	NA	NA	NA	3694.945440	1025	0		-72875	Pass
50	nominal	3694.946713	NA	NA	NA	NA	NA	3694.948479	4064	0		-69836	Pass

\* - Reference frequency

Reference numbers of test equipment used

HL 0025	HL 0493	HL 0495							
---------	---------	---------	--	--	--	--	--	--	--

Full description is given in Appendix A.

<b>Test specification:</b>		<b>Section 15.107 class B, Conducted emission</b>	
<b>Test procedure:</b>		ANSI C63.4, Section 13.1.3; Sections 11.5 and 12.1.3	
<b>Test mode:</b>	Compliance	<b>Verdict:</b>	PASS
<b>Date:</b>	12/31/2007		
<b>Temperature:</b> 22°C	<b>Air Pressure:</b> 1011 hPa	<b>Relative Humidity:</b> 48%	<b>Power Supply:</b> 120 V AC
<b>Remarks:</b>			

## 8 Unintentional radiation tests according to 47CFR part 15 subpart B requirements

### 8.1 Conducted emissions

#### 8.1.1 General

This test was performed to measure common mode conducted emissions at the power port. Specification test limits are given in Table 8.1.1.

Table 8.1.1 Limits for conducted emissions

Frequency, MHz	Class B limit, dB(μV)	
	QP	AVRG
0.15 - 0.5	66 - 56*	56 - 46*
0.5 - 5.0	56	46
5.0 - 30	60	50

\* The limit decreases linearly with the logarithm of frequency.

#### 8.1.2 Test procedure

8.1.2.1 The EUT was set up as shown in Figure 8.1.1, energized and the performance check was conducted.

8.1.2.2 The measurements were performed at power terminals with the LISN, connected to a spectrum analyzer in the frequency range referred to in Table 8.1.2, Table 8.1.3, Table 8.1.4. Unused coaxial connector of the LISN was terminated with 50 Ohm. Quasi-peak and average detectors were used throughout the testing.

8.1.2.3 The position of the device cables was varied to determine maximum emission level.

8.1.2.4 The worst test results (the lowest margins) were recorded in Table 8.1.2 and shown in the associated plots.

Figure 8.1.1 Setup for conducted emission measurements, table-top equipment

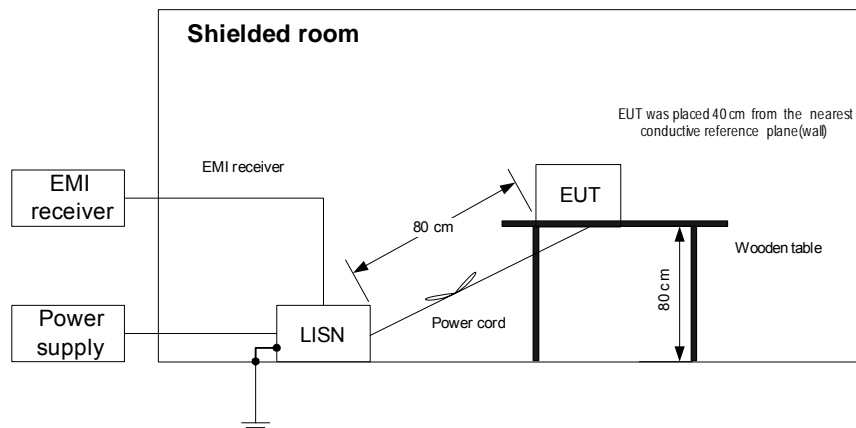

<b>Test specification:</b>		<b>Section 15.107 class B, Conducted emission</b>	
<b>Test procedure:</b>		ANSI C63.4, Section 13.1.3; Sections 11.5 and 12.1.3	
<b>Test mode:</b>	Compliance	<b>Verdict:</b>	PASS
<b>Date:</b>	12/31/2007		
<b>Temperature:</b> 22°C	<b>Air Pressure:</b> 1011 hPa	<b>Relative Humidity:</b> 48%	<b>Power Supply:</b> 120 V AC
<b>Remarks:</b>			

**Table 8.1.2 Conducted emission test results on the EUT power lines**

LINE: AC mains  
LIMIT: Class B  
EUT SET UP: TABLE-TOP  
TEST SITE: SHIELDED ROOM  
DETECTORS USED: PEAK / QUASI-PEAK / AVERAGE  
FREQUENCY RANGE: 150 kHz - 30 MHz  
RESOLUTION BANDWIDTH: 9 kHz

Frequency, MHz	Peak emission, dB(μV)	Quasi-peak			Average			Line ID	Verdict
		Measured emission, dB(μV)	Limit, dB(μV)	Margin, dB*	Measured emission, dB(μV)	Limit, dB(μV)	Margin, dB*		
0.156525	49.53	48.85	65.68	-16.83	48.23	55.68	-7.45	L1	Pass
0.261500	43.20	42.62	61.44	-18.82	42.56	51.44	-8.88		
0.840425	40.59	39.31	56.00	-16.69	37.86	46.00	-8.14		
0.156763	48.74	48.23	65.67	-17.44	47.96	55.67	-7.71	L2	Pass
0.261913	45.71	44.84	61.43	-16.59	44.82	51.43	-6.61		
0.840625	43.30	42.05	56.00	-13.95	40.27	46.00	-5.73		

\*- Margin = Measured emission - specification limit.

**Reference numbers of test equipment used**

HL 0447	HL 0521	HL 0787	HL 1503	HL 1510	HL 2888		
---------	---------	---------	---------	---------	---------	--	--

Full description is given in Appendix A.

<b>Test specification:</b>		<b>Section 15.107 class B, Conducted emission</b>	
<b>Test procedure:</b>		ANSI C63.4, Section 13.1.3; Sections 11.5 and 12.1.3	
<b>Test mode:</b>	Compliance	<b>Verdict: PASS</b>	
<b>Date:</b>	12/31/2007		
<b>Temperature:</b> 22°C	<b>Air Pressure:</b> 1011 hPa	<b>Relative Humidity:</b> 48%	<b>Power Supply:</b> 120 V AC
<b>Remarks:</b>			

Table 8.1.3 Conducted emission test results on the laptop power lines

LINE: AC mains  
LIMIT: Class B  
EUT SET UP: TABLE-TOP  
TEST SITE: SHIELDED ROOM  
DETECTORS USED: PEAK / QUASI-PEAK / AVERAGE  
FREQUENCY RANGE: 150 kHz - 30 MHz  
RESOLUTION BANDWIDTH: 9 kHz

Frequency, MHz	Peak emission, dB(μV)	Quasi-peak			Average			Line ID	Verdict
		Measured emission, dB(μV)	Limit, dB(μV)	Margin, dB*	Measured emission, dB(μV)	Limit, dB(μV)	Margin, dB*		
0.15 - 30	All emissions were found at least 20 dB below the specified limit						L1	Pass	
0.15 - 30	All emissions were found at least 20 dB below the specified limit						L2	Pass	

Reference numbers of test equipment used

HL 0447	HL 0521	HL 0787	HL 1503	HL 1510	HL 2888		
---------	---------	---------	---------	---------	---------	--	--

Full description is given in Appendix A.

<b>Test specification:</b>		<b>Section 15.107 class B, Conducted emission</b>	
<b>Test procedure:</b>		ANSI C63.4, Section 13.1.3; Sections 11.5 and 12.1.3	
<b>Test mode:</b>	Compliance	<b>Verdict:</b>	PASS
<b>Date:</b>	12/31/2007		
<b>Temperature:</b> 22°C	<b>Air Pressure:</b> 1011 hPa	<b>Relative Humidity:</b> 48%	<b>Power Supply:</b> 120 V AC
<b>Remarks:</b>			

**Plot 8.1.1 Conducted emission measurements on the EUT power lines**

LINE: L1  
LIMIT: Class B - QUASI-PEAK, AVERAGE  
EUT OPERATING MODE: Receive / Stand-by  
DETECTOR: PEAK

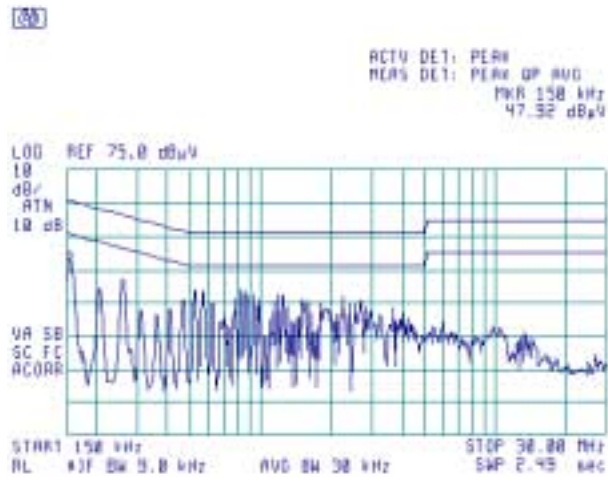

**Plot 8.1.2 Conducted emission measurements on the EUT power lines**

LINE: L2  
LIMIT: Class B - QUASI-PEAK, AVERAGE  
EUT OPERATING MODE: Receive / Stand-by  
DETECTOR: PEAK

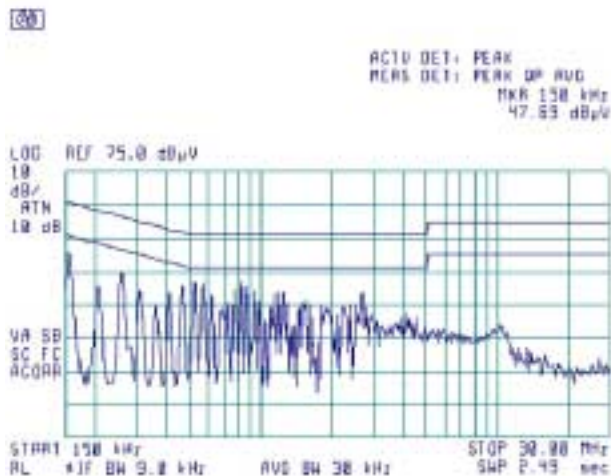

<b>Test specification:</b>		<b>Section 15.107 class B, Conducted emission</b>	
<b>Test procedure:</b>		ANSI C63.4, Section 13.1.3; Sections 11.5 and 12.1.3	
<b>Test mode:</b>	Compliance	<b>Verdict:</b>	PASS
<b>Date:</b>	12/31/2007		
<b>Temperature:</b> 22°C	<b>Air Pressure:</b> 1011 hPa	<b>Relative Humidity:</b> 48%	<b>Power Supply:</b> 120 V AC
<b>Remarks:</b>			

**Plot 8.1.3 Conducted emission measurements on the laptop power lines**

LINE: L1  
LIMIT: Class B - QUASI-PEAK, AVERAGE  
EUT OPERATING MODE: Receive / Stand-by  
DETECTOR: PEAK

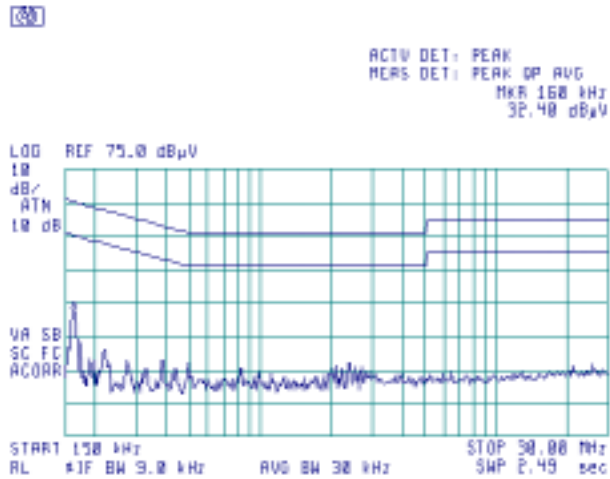

**Plot 8.1.4 Conducted emission measurements on the laptop power lines**

LINE: L2  
LIMIT: Class B - QUASI-PEAK, AVERAGE  
EUT OPERATING MODE: Receive / Stand-by  
DETECTOR: PEAK

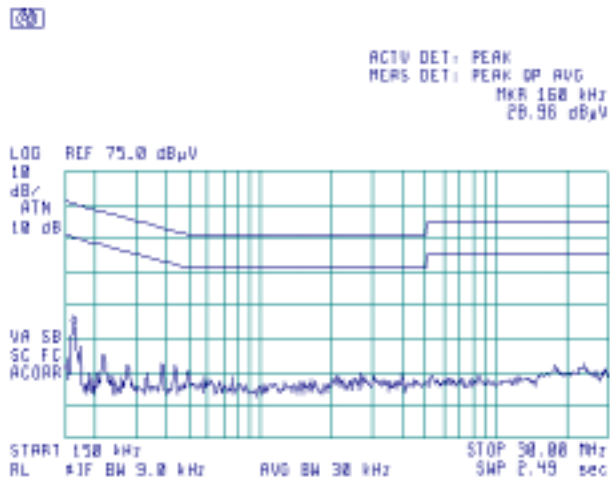

<b>Test specification:</b> Section 15.109, class B, Radiated emission			
<b>Test procedure:</b> ANSI C63.4, Sections 11.6 and 12.1.4			
<b>Test mode:</b> Compliance			<b>Verdict:</b> PASS
<b>Date:</b> 12/31/2007			
<b>Temperature:</b> 22°C	<b>Air Pressure:</b> 1011 hPa	<b>Relative Humidity:</b> 48%	<b>Power Supply:</b> 120 V AC
<b>Remarks:</b>			

## 8.2 Radiated emission measurements

### 8.2.1 General

This test was performed to measure radiated emissions from the EUT enclosure. Specification test limits are given in Table 8.2.1.

Table 8.2.1 Radiated emission test limits

Frequency, MHz	Class B limit, dB(μV/m)		Class A limit, dB(μV/m)	
	10 m distance	3 m distance	10 m distance	3 m distance
30 - 88	29.5*	40.0	39.0	49.5*
88 - 216	33.0*	43.5	43.5	54.0*
216 - 960	35.5*	46.0	46.4	56.9*
Above 960	43.5*	54.0	49.5	60.0*

\* The limit for test distance other than specified was calculated using the inverse linear distance extrapolation factor as follows:  $Lim_{S_2} = Lim_{S_1} + 20 \log(S_1/S_2)$ , where  $S_1$  and  $S_2$  – standard defined and test distance respectively in meters.

### 8.2.2 Test procedure for measurements in semi-anechoic chamber

8.2.2.1 The EUT was set up as shown in Figure 8.2.1, energized and the performance check was conducted.

8.2.2.2 The specified frequency range was investigated with biconilog antenna connected to EMI receiver. To find maximum radiation the turntable was rotated 360°, the measuring antenna height was changed from 1 to 4 m, its polarization was switched from vertical to horizontal and the EUT cables position was varied.

8.2.2.3 The worst test results (the lowest margins) were recorded in Table 8.2.2, Table 8.2.3 and shown in the associated plots.

Figure 8.2.1 Setup for radiated emission measurements in anechoic chamber, table-top equipment

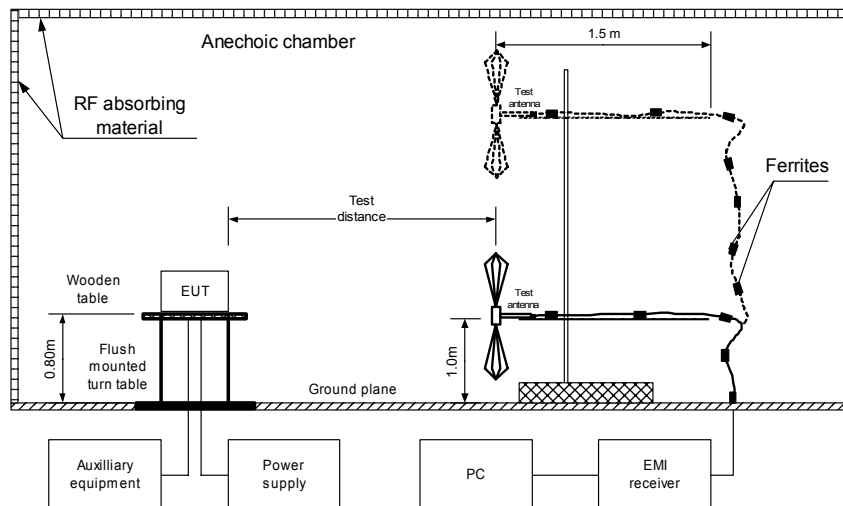

<b>Test specification:</b> Section 15.109, Radiated emission	
<b>Test procedure:</b> ANSI C63.4, Sections 11.6 and 12.1.4	
<b>Test mode:</b> Compliance	<b>Verdict:</b> PASS
<b>Date:</b> 4/3/2006	
<b>Temperature:</b> 22°C	<b>Air Pressure:</b> 1009 hPa
<b>Relative Humidity:</b> 42%	
<b>Power Supply:</b> 120 V AC	
<b>Remarks:</b>	

Table 8.2.2 Radiated emission test results

EUT SET UP: TABLE-TOP  
TEST SITE: SEMI ANECHOIC CHAMBER  
TEST DISTANCE: 3 m  
LIMIT: Class B  
DETECTORS USED: PEAK / QUASI-PEAK  
FREQUENCY RANGE: 30 MHz – 1000 MHz  
RESOLUTION BANDWIDTH: 120 kHz

Frequency, MHz	Peak emission, dB(μV/m)	Quasi-peak			Antenna polarization	Antenna height, m	Turn-table position**, degrees	Verdict
		Measured emission, dB(μV/m)	Limit, dB(μV/m)	Margin, dB*				
36.787500	32.05	26.75	40.00	-13.25	V	1.0	210	Pass
177.237500	40.96	39.02	43.50	-4.48	V	1.1	170	
955.798250	39.91	34.68	46.00	-11.32	H	1.5	330	

\*- Margin = Measured emission - specification limit.

\*\*- EUT front panel refers to 0 degrees position of turntable.

Reference numbers of test equipment used

HL 0521	HL 0604	HL 0589	HL 1947				
---------	---------	---------	---------	--	--	--	--

Full description is given in Appendix A.



<b>Test specification:</b>		<b>Section 15.109, Radiated emission</b>	
<b>Test procedure:</b>		ANSI C63.4, Sections 11.6 and 12.1.4	
<b>Test mode:</b>	Compliance	<b>Verdict:</b>	PASS
<b>Date:</b>	4/3/2006		
<b>Temperature:</b> 22°C	<b>Air Pressure:</b> 1009 hPa	<b>Relative Humidity:</b> 42%	<b>Power Supply:</b> 120 V AC
<b>Remarks:</b>			

Plot 8.2.1 Radiated emission measurements in 30 - 1000 MHz range, vertical antenna polarization

TEST SITE: Semi anechoic chamber  
TEST DISTANCE: 3 m

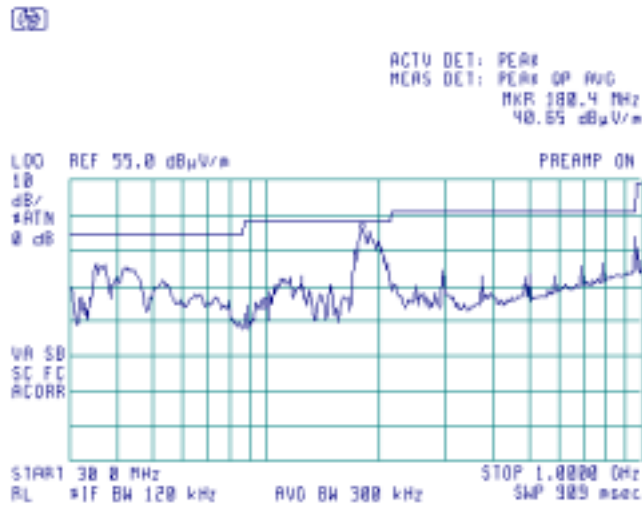

Plot 8.2.2 Radiated emission measurements in 30 - 1000 MHz range, horizontal antenna polarization

TEST SITE: Semi anechoic chamber  
TEST DISTANCE: 3 m

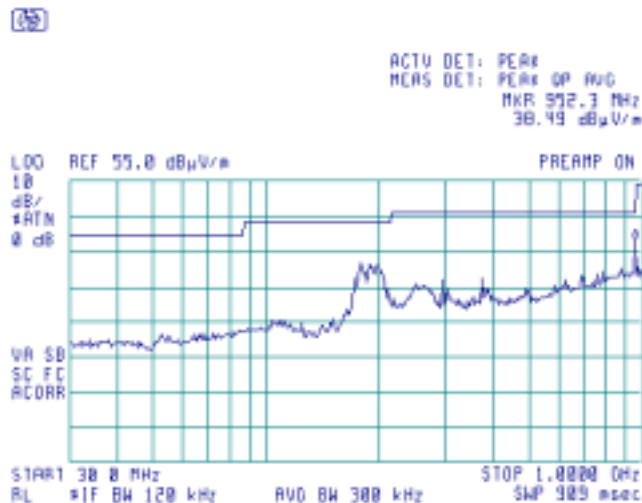

## 9 APPENDIX A Test equipment and ancillaries used for tests

HL No	Description	Manufacturer	Model	Ser. No.	Last Cal.	Due Cal.
0025	Analyzer, Spectrum, 10 kHz - 23 GHz / 140 GHz	Anritsu	MS-710C	5837	01-Jan-08	01-Jan-09
0446	Antenna, Loop, Active, 10 kHz - 30 MHz	EMCO	6502	2857	28-Jun-07	28-Jun-08
0447	LISN, 16/2, 300V RMS, 50 Ohm/50 uH + 5 Ohm, STD CISPR 16-1	HL	LISN 16 - 1	066	03-Nov-07	03-Nov-08
0493	Temperature Chamber -45...175 deg C	Thermotron	S-1.2 Mini-Max	14016	08-Mar-07	08-Mar-08
0495	Autotransformer 0-255V, 10A	Variac	EMPL01	495	15-Aug-07	15-Aug-08
0521	EMI Receiver (Spectrum Analyzer) with RF filter section 9 kHz-6.5 GHz	Hewlett Packard Co	8546A	3617A 00319, 3448A002 53	28-Aug-07	28-Aug-08
0589	Cable Coaxial, GORE A2P01POL118, 2.3 m	HL	GORE-3	176	02-Dec-07	02-Dec-08
0604	Antenna BiconiLog Log-Periodic/T Bow-TIE, 26 - 2000 MHz	EMCO	3141	9611-1011	10-Jan-08	10-Jan-09
0768	Antenna Standard Gain Horn, 18-26.5GHz, WR-42, K-band, Gain - 25 dB	Quinstar Technology	QWH-4200-BA	110	21-Jul-07	21-Jul-08
0769	Antenna Standard Gain Horn, 26.5-40 GHz, WR28, Ka band, Gain 25 dB	Quinstar Technology	QWH-2800-BA	112	21-Jul-07	21-Jul-08
0787	Transient Limiter 9 kHz-200 MHz	Hewlett Packard Co	11947A	3107A018 77	21-Nov-07	21-Nov-08
1424	Spectrum Analyzer, 30 Hz- 40 GHz	Agilent Technologies	8564EC	3946A002 19	30-Aug-07	30-Aug-08
1503	Cable RF, 6 m, BNC/BNC	Belden	M17/167 MIL-C-17	1503	11-Sep-07	11-Sep-08
1510	Cable RF, 8 m, BNC/BNC	Belden	M17/167 MIL-C-17	1510	01-Jan-08	01-Jan-09
1629	Isotropic Field Monitor	Amplifier Research	FM2000	23308	07-Dec-07	07-Dec-08
1947	Cable 18GHz, 6.5 m, blue	Rhophase Microwave Limited	NPS-1803A-6500-NPS	T4974	05-Oct-07	05-Oct-08
2078	Isotropic Field Probe 80 MHz - 40 GHz	Amplifier Research	FP2080	302541	01-Jan-08	01-Jan-09
2254	Cable 40GHz, 0.8 m, blue	Rhophase Microwave Limited	KPS-1503A-800-KPS	W4907	17-Jun-07	17-Jun-08
2260	Amplifier Low Noise 14-33 GHz	Sophia Wireless	LNA28-B	0233	05-Nov-07	05-Nov-08
2261	Amplifier Low Noise 33-40 GHz	Sophia Wireless	LNA38-B	0234	05-Nov-07	05-Nov-08
2399	Cable 40GHz, 1.5 m, blue	Rhophase Microwave Limited	KPS-1503A-1500-KPS	X2945	01-Jan-08	01-Jan-09
2432	Antenna, Double-Ridged Waveguide Horn 1-18 GHz	EMC Test Systems	3115	00027177	03-Mar-07	03-Mar-08
2780	EMC analyzer, 100 Hz to 26.5 GHz	Agilent Technologies	E7405A	MY451024 6	11-Jun-07	11-Jun-08
2888	LISN Two-line V-Network 50 Ohm / 50 uH + 5 Ohm, 16A, MIL STD 461E, CISPR 16-1	Rolf Heine	NNB-2/16Z	02/10018	29-Mar-07	29-Mar-08

HL No	Description	Manufacturer	Model	Ser. No.	Last Cal.	Due Cal.
2909	Spectrum analyzer, ESA-E, 100 Hz to 26.5 GHz	Agilent Technologies	E4407B	MY41444762	07-May-07	07-May-08
2912	Cable 18 GHz, 1.5 m, SMA-SMA	Gore	NA	91P72067	11-Feb-07	11-Feb-08
2951	Cable, RF, 18 GHz, 0.9 m, SMA-SMA	Gore	0020014	2951	5-Oct-07	5-Oct-08
3173	Attenuator, N-type, 10 dB, DC to 18 GHz, 5 W	Mini-Circuits	BW-N10W5+	0708	07-May-07	07-May-08
3179	Attenuator, N-type, 20 dB, DC to 18 GHz, 5 W	Mini-Circuits	BW-N20W5+	0651	07-May-07	07-May-08
3301	Power Meter, P-series, 50 MHz to 40 GHz	Agilent Technologies	N1911A	MY45101057	27-Jul-07	27-Jul-08
3302	Power sensor, P-Series, 50 MHz to 40 GHz, -35/30 to 20 dBm	Agilent Technologies	N1922A	MY45240586	25-Jul-07	25-Jul-08
3303	Software for Agilent N1911 power meter	Agilent Technologies	N1918A	NA	NA	NA
3439	Precision Fixed Attenuator, 50 Ohm, 5 W, 20 dB, DC to 18 GHz	Mini-Circuits	BW-S20W5+	3439	09-Mar-08	09-Mar-09

## 10 APPENDIX B Measurement uncertainties

### Expanded uncertainty at 95% confidence in Hermon Labs EMC measurements

Test description	Expanded uncertainty
<b>Transmitter tests</b>	
Carrier power conducted at antenna connector	± 1.7 dB
Carrier power radiated (substitution method)	± 4.5 dB
Occupied bandwidth	±8%
Conducted emissions at RF antenna connector	9 kHz to 2.9 GHz: ± 2.6 dB 2.9 GHz to 6.46 GHz: ± 3.5 dB 6.46 GHz to 13.2 GHz: ± 4.3 dB 13.2 GHz to 22.0 GHz: ± 5.0 dB 22.0 GHz to 26.8 GHz: ± 5.5 dB 26.8 GHz to 40.0 GHz: ± 4.8 dB
Spurious emissions radiated 30 MHz – 40 GHz (substitution method)	± 4.5 dB
Frequency error	30 – 300 MHz: ± 50.5 Hz (1.68 ppm) 300 – 1000 MHz: ± 168 Hz (0.56 ppm)
Transient frequency behaviour	187 Hz ± 13.9 %
Duty cycle, timing (Tx ON / OFF) and average factor measurements	± 1.0 %
<b>Unintentional radiator tests</b>	
Conducted emissions with LISN	9 kHz to 150 kHz: ± 3.9 dB 150 kHz to 30 MHz: ± 3.8 dB
Radiated emissions at 3 m measuring distance Horizontal polarization  Vertical polarization	Biconilog antenna: ± 5.3 dB Biconical antenna: ± 5.0 dB Log periodic antenna: ± 5.3 dB Double ridged horn antenna: ± 5.3 dB Biconilog antenna: ± 6.0 dB Biconical antenna: ± 5.7 dB Log periodic antenna: ± 6.0 dB Double ridged horn antenna: ± 6.0 dB

Hermon Laboratories is accredited by A2LA for calibration according to present requirements of ISO/IEC 17025 and NCSL Z540-1. The accreditation is granted to perform calibration of parameters that are listed in the Scope of Hermon Laboratories Accreditation.

Hermon Laboratories calibrates its reference and transfer standards by calibration laboratories accredited to ISO/IEC 17025 by a mutually recognized Accreditation Body or by a recognized national metrology institute. All reference and transfer standards used in the calibration system are traceable to national or international standards.

In-house calibration of all test and measurement equipment is performed on a regular basis according to Hermon Laboratories calibration procedures, manufacturer calibration/verification procedures or procedures defined in the relevant standards. The Hermon Laboratories test and measurement equipment is calibrated within the tolerances specified by the manufacturers and/or by the relevant standards.

## 11 APPENDIX C Test facility description

Tests were performed at Hermon Laboratories Ltd., which is a fully independent, private, EMC, safety, environmental and telecommunication testing facility. Hermon Laboratories is listed by the Federal Communications Commission (USA) for all parts of Code of Federal Regulations 47 (CFR 47) and by Industry Canada for electromagnetic emissions (file numbers IC 2186-1 for OATS and IC 2186-2 for anechoic chamber), certified by VCCI, Japan (the registration numbers are R-808 for OATS, R-1082 for anechoic chamber, C-845 for conducted emissions site), assessed by TNO Certification EP&S (Netherlands) for a number of EMC, telecommunications, environmental, safety standards, and by AMTAC (UK) for safety of medical devices. The laboratory is accredited by American Association for Laboratory Accreditation (USA) according to ISO/IEC 17025 for electromagnetic compatibility, product safety, telecommunications testing and environmental simulation (for exact scope please refer to Certificate No. 839.01).

Address: P.O. Box 23, Binyamina 30500, Israel.  
Telephone: +972 4628 8001  
Fax: +972 4628 8277  
e-mail: mail@hermonlabs.com  
website: www.hermonlabs.com

Person for contact: Mr. Alex Usoskin, CEO.

## 12 APPENDIX D Specification references

47CFR part 90: 2006	Private land mobile radio services
47CFR part 1: 2006	Practice and procedure
47CFR part 2: 2006	Frequency allocations and radio treaty matters; general rules and regulations
ANSI C63.2: 1996	American National Standard for Instrumentation-Electromagnetic Noise and Field Strength, 10 kHz to 40 GHz-Specifications.
ANSI C63.4: 2003	American National Standard for Methods of Measurement of Radio-Noise Emissions from Low-Voltage Electrical and Electronic Equipment in the Range of 9 kHz to 40 GHz.
ANSI/TIA/EIA-603-C:2004	Land Mobile FM or PM Communications Equipment Measurement and Performance Standards

**13 APPENDIX E Test equipment correction factors**

**Correction factor  
Line impedance stabilization network  
Model LISN 16 - 1  
Hermon Laboratories**

<b>Frequency, kHz</b>	<b>Correction factor, dB</b>
10	4.9
15	2.86
20	1.83
25	1.25
30	0.91
35	0.69
40	0.53
50	0.35
60	0.25
70	0.18
80	0.14
90	0.11
100	0.09
125	0.06
150	0.04

The correction factor in dB is to be added to meter readings of an interference analyzer or a spectrum analyzer.

**Correction factor  
Line impedance stabilization network  
Model NNB-2/16Z, Rolf Heine, HL 2888**

Frequency, kHz	Insertion loss, dB		Measurement Uncertainty, dB
	L1	N	
10	0.48	0.79	±0.6
20	0.52	0.63	
30	0.31	0.35	
40	0.20	0.22	
50	0.16	0.17	
100	0.10	0.08	
300	0.08	0.06	
500	0.10	0.06	
600	0.09	0.07	
800	0.10	0.07	
1000	0.10	0.08	
2000	0.12	0.11	
3000	0.16	0.14	
4000	0.17	0.18	
6000	0.26	0.23	
10000	0.49	0.41	
14000	0.66	0.54	
16000	0.79	0.69	
18000	0.86	0.76	
20000	0.96	0.85	
25000	1.22	1.08	
28000	1.35	1.21	
30000	1.43	1.29	

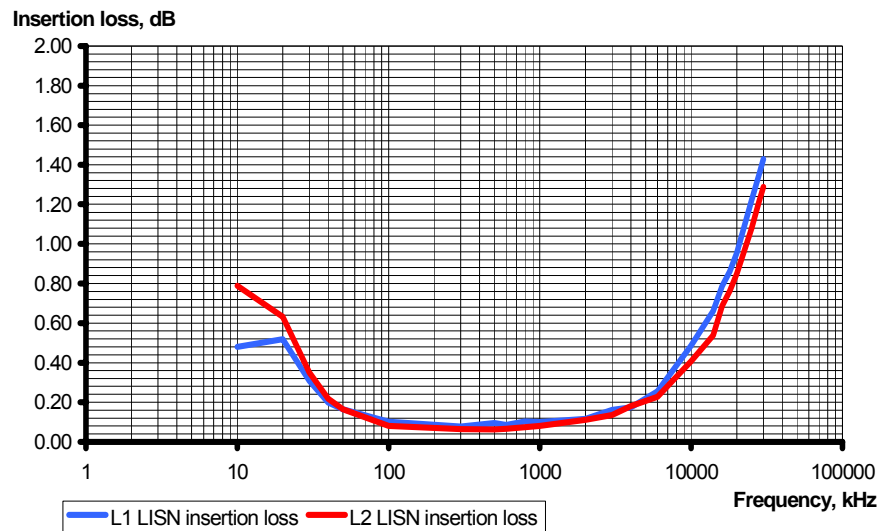

**Antenna Factor**  
**Active Loop Antenna**  
**EMC Test Systems, model 6502, S/N 2857, HL 0446**

Frequency, MHz	Magnetic Antenna Factor, dB(S/m)	Electric Antenna Factor, dB(1/m)
0.009	-32.8	18.7
0.010	-33.8	17.7
0.020	-38.3	13.2
0.050	-41.1	10.4
0.075	-41.3	10.2
0.100	-41.6	9.9
0.150	-41.7	9.8
0.250	-41.6	9.9
0.500	-41.8	9.7
0.750	-41.9	9.6
1.000	-41.4	10.1
2.000	-41.5	10.0
3.000	-41.4	10.1
4.000	-41.4	10.1
5.000	-41.5	10.0
10.000	-41.9	9.6
15.000	-41.9	9.6
20.000	-42.2	9.3
25.000	-42.8	8.7
30.000	-44.0	7.5

Antenna factor in dB(S/m) is to be added to receiver meter reading in dB( $\mu$ V) to convert it into field intensity in dB( $\mu$ A/m).  
Antenna factor in dB(1/m) is to be added to receiver meter reading in dB( $\mu$ V) to convert it into field intensity in dB( $\mu$ V/m).

**Antenna factor**  
**Standard gain horn antenna**  
**Quinstar Technology**  
**Model QWH, Ser.No.112, HL 0768, 0769**

Frequency min, GHz	Frequency max, GHz	Antenna factor, dB(1/m)
18.000	26.500	32.01
26.500	40.000	35.48
40.000	60.000	39.03
60.000	90.000	42.55
90.000	140.000	46.23
140.000	220.000	50.11

Antenna factor in dB(1/m) is to be added to receiver meter reading in dB( $\mu$ V) to convert it into field intensity in dB( $\mu$ V/m).



**Antenna factor**  
**Biconilog antenna EMCO, model 3141, serial number 1011, HL 0604**

Frequency, MHz	Antenna factor, dB(1/m)	Frequency, MHz	Antenna factor, dB(1/m)	Frequency, MHz	Antenna factor, dB(1/m)
26	7.8	560	19.8	1300	27.0
28	7.8	580	20.6	1320	27.8
30	7.8	600	21.3	1340	28.3
40	7.2	620	21.5	1360	28.2
60	7.1	640	21.2	1380	27.9
70	8.5	660	21.4	1400	27.9
80	9.4	680	21.9	1420	27.9
90	9.8	700	22.2	1440	27.8
100	9.7	720	22.2	1460	27.8
110	9.3	740	22.1	1480	28.0
120	8.8	760	22.3	1500	28.5
130	8.7	780	22.6	1520	28.9
140	9.2	800	22.7	1540	29.6
150	9.8	820	22.9	1560	29.8
160	10.2	840	23.1	1580	29.6
170	10.4	860	23.4	1600	29.5
180	10.4	880	23.8	1620	29.3
190	10.3	900	24.1	1640	29.2
200	10.6	920	24.1	1660	29.4
220	11.6	940	24.0	1680	29.6
240	12.4	960	24.1	1700	29.8
260	12.8	980	24.5	1720	30.3
280	13.7	1000	24.9	1740	30.8
300	14.7	1020	25.0	1760	31.1
320	15.2	1040	25.2	1780	31.0
340	15.4	1060	25.4	1800	30.9
360	16.1	1080	25.6	1820	30.7
380	16.4	1100	25.7	1840	30.6
400	16.6	1120	26.0	1860	30.6
420	16.7	1140	26.4	1880	30.6
440	17.0	1160	27.0	1900	30.6
460	17.7	1180	27.0	1920	30.7
480	18.1	1200	26.7	1940	30.9
500	18.5	1220	26.5	1960	31.2
520	19.1	1240	26.5	1980	31.6
540	19.5	1260	26.5	2000	32.0
		1280	26.6		

Antenna factor in dB(1/m) is to be added to receiver meter reading in dB( $\mu$ V) to convert it into field intensity in dB( $\mu$ V/m).

**Antenna factor  
Double-ridged guide horn antenna  
Model 3115, serial number: 00027177, HL2432**

Frequency, MHz	Antenna factor. dB(1/m)
1000.0	24.7
1500.0	25.7
2000.0	27.8
2500.0	28.9
3000.0	30.7
3500.0	31.8
4000.0	33.0
4500.0	32.8
5000.0	34.2
5500.0	34.9
6000.0	35.2
6500.0	35.4
7000.0	36.3
7500.0	37.3
8000.0	37.5
8500.0	38.0
9000.0	38.3
9500.0	38.3
10000.0	38.7
10500.0	38.7
11000.0	38.9
11500.0	39.5
12000.0	39.5
12500.0	39.4
13000.0	40.5
13500.0	40.8
14000.0	41.5
14500.0	41.3
15000.0	40.2
15500.0	38.7
16000.0	38.5
16500.0	39.8
17000.0	41.9
17500.0	45.8
18000.0	49.1

Antenna factor in dB(1/m) is to be added to receiver meter reading in dB( $\mu$ V) to convert it into field intensity in dB( $\mu$ V/m).

**Cable loss**  
**Cable Coaxial, GORE A2P01POL118, 2.3 m, model:GORE-3, HL 0589**  
**+ Cable Coaxial, ANDREW PSWJ4, 6m, model: ANDREW-6, HL 1004**

No.	Frequency, MHz	Cable loss, dB	Tolerance (Specification), dB	Measurement uncertainty, dB	
1	30	0.33	≤ 6.5	±0.12	
2	50	0.40			
3	100	0.57			
4	300	0.97			
5	500	1.25			
6	800	1.59			
7	1000	1.81			
8	1200	1.97			
9	1400	2.15			
10	1600	2.28			
11	1800	2.43			
12	2000	2.61			
13	2200	2.75			
14	2400	2.89			
15	2600	2.97			
16	2800	3.21	≤ 6.5	±0.12	
17	3000	3.32			
18	3300	3.47			
19	3600	3.62			
20	3900	3.84			
21	4200	3.92			±0.17
22	4500	4.07			
23	4800	4.36			
24	5100	4.62			
25	5400	4.78			
26	5700	5.16			
27	6000	5.67			
28	6500	5.99			

**Cable loss**  
**Cable coaxial, 6 m, model: M17/167 MIL-C-17, HL 1503**

Frequency, MHz	Cable loss, dB
0.15	0.043
1	0.077
3	0.139
5	0.169
10	0.248
30	0.430
50	0.561
75	0.697
100	0.822
300	1.446
500	1.901
800	2.663
1000	2.829
1500	3.569
2000	4.179

**Cable loss**  
**Cable M17/167 MIL-C-17, HL 1510**

No.	Frequency, MHz	Cable loss, dB
1	0.1	0.05
2	1	0.09
3	3	0.16
4	5	0.18
5	10	0.27
6	30	0.44
7	50	0.58
8	80	0.69
9	100	0.82
10	300	1.48
11	500	2.01
12	800	2.65
13	1000	3.12

**Cable loss**  
**Cable 18 GHz, 6.5 m, blue, model: NPS-1803A-6500-NPS, S/N T4974, HL 1947**

Frequency, GHz	Cable loss, dB
0.03	0.30
0.05	0.38
0.10	0.53
0.20	0.74
0.30	0.91
0.40	1.05
0.50	1.18
0.60	1.29
0.70	1.40
0.80	1.50
0.90	1.59
1.00	1.68
1.10	1.77
1.20	1.86
1.30	1.94
1.40	2.01
1.50	2.08
1.60	2.16
1.70	2.22
1.80	2.29
1.90	2.36
2.00	2.42
2.10	2.48
2.20	2.54
2.30	2.60
2.40	2.66
2.50	2.71
2.60	2.77
2.70	2.83
2.80	2.89
2.90	2.95
3.10	3.06
3.30	3.17
3.50	3.28
3.70	3.39
3.90	3.51
4.10	3.62
4.30	3.76
4.50	3.87
4.70	4.01
4.90	4.10
5.10	4.21
5.30	4.31
5.50	4.43
5.70	4.56
5.90	4.71

Frequency, GHz	Cable loss, dB
6.10	4.87
6.30	4.95
6.50	4.94
6.70	4.88
6.90	4.87
7.10	4.83
7.30	4.85
7.50	4.86
7.70	4.91
7.90	4.96
8.10	5.03
8.30	5.08
8.50	5.13
8.70	5.21
8.90	5.22
9.10	5.34
9.30	5.35
9.50	5.52
9.70	5.51
9.90	5.66
10.10	5.70
10.30	5.78
10.50	5.79
10.70	5.82
10.90	5.86
11.10	5.94
11.30	6.06
11.50	6.21
11.70	6.44
11.90	6.61
12.10	6.76
12.40	6.68
13.00	6.66
13.50	6.81
14.00	6.90
14.50	6.90
15.00	6.97
15.50	7.17
16.00	7.28
16.50	7.27
17.00	7.38
17.50	7.68
18.00	7.92

**Cable loss**  
**Cable 40 GHz, 0.8 m, blue, model: KPS-1503A-800-KPS, S/N W4907, HL 2254**

Frequency, GHz	Cable loss, dB	Frequency, GHz	Cable loss, dB	Frequency, GHz	Cable loss, dB
0.03	0.04	5.10	0.80	15.00	1.49
0.05	0.07	5.30	0.83	15.50	1.49
0.10	0.09	5.50	0.83	16.00	1.46
0.20	0.15	5.70	0.84	16.50	1.47
0.30	0.19	5.90	0.87	17.00	1.50
0.40	0.25	6.10	0.86	17.50	1.57
0.50	0.29	6.30	0.89	18.00	1.63
0.60	0.33	6.50	0.90	18.50	1.57
0.70	0.37	6.70	0.89	19.00	1.63
0.80	0.41	6.90	0.93	19.50	1.65
0.90	0.44	7.10	0.92	20.00	1.64
1.00	0.45	7.30	0.95	20.50	1.75
1.10	0.48	7.50	0.96	21.00	1.72
1.20	0.51	7.70	0.97	21.50	1.78
1.30	0.53	7.90	1.01	22.00	1.76
1.40	0.54	8.10	1.00	22.50	1.72
1.50	0.57	8.30	1.05	23.00	1.83
1.60	0.59	8.50	1.04	23.50	1.80
1.70	0.04	8.70	1.07	24.00	1.90
1.80	0.07	8.90	1.11	24.50	1.81
1.90	0.09	9.10	1.09	25.00	1.98
2.00	0.15	9.30	1.14	25.50	1.91
2.10	0.19	9.50	1.12	26.00	2.02
2.20	0.25	9.70	1.15	26.50	1.92
2.30	0.29	9.90	1.16	27.00	1.97
2.40	0.33	10.10	1.16	28.00	2.02
2.50	0.37	10.30	1.19	29.00	1.95
2.60	0.41	10.50	1.14	30.00	1.94
2.70	0.44	10.70	1.19	31.00	2.11
2.80	0.45	10.90	1.17	32.00	2.17
2.90	0.48	11.10	1.13	33.00	2.27
3.10	0.61	11.30	1.20	34.00	2.27
3.30	0.64	11.50	1.13	35.00	2.29
3.50	0.65	11.70	1.20	36.00	2.35
3.70	0.68	11.90	1.18	37.00	2.37
3.90	0.69	12.10	1.14	38.00	2.40
4.10	0.71	12.40	1.19	39.00	2.57
4.30	0.73	13.00	1.34	40.00	2.36
4.50	0.75	13.50	1.33		
4.70	0.77	14.00	1.48		
4.90	0.79	14.50	1.45		

**Cable loss**  
Cable coaxial, 40GHz, 1.5 m, Blue, Rhopase Microwave Limited, model: KPS-1503A-1500-KPS,  
HL 2399

Frequency, GHz	Cable loss, dB	Frequency, GHz	Cable loss, dB	Frequency, GHz	Cable loss, dB
0.03	0.07	6.5	1.57	15.50	2.50
0.05	0.10	6.7	1.60	16.00	2.51
0.1	0.16	6.9	1.55	16.50	2.58
0.2	0.26	7.1	1.65	17.00	2.65
0.3	0.33	7.3	1.65	17.50	2.73
0.5	0.38	7.5	1.70	18.00	2.74
0.7	0.41	7.7	1.71	18.50	2.67
0.9	0.58	7.9	1.73	19.00	2.67
1.1	0.64	8.1	1.79	19.50	2.74
1.3	0.70	8.3	1.81	20.00	2.69
1.5	0.75	8.5	1.84	20.50	2.80
1.7	0.79	8.7	1.85	21.00	2.82
1.9	0.83	8.9	1.90	21.50	2.87
2.1	0.88	9.1	1.95	22.00	2.87
2.3	0.93	9.3	1.93	22.50	2.92
2.5	0.97	9.5	1.98	23.50	3.04
2.7	1.01	9.7	1.96	24.00	3.05
2.9	1.04	9.9	2.03	24.50	3.03
3.1	1.08	10.1	1.99	25.00	3.11
3.3	1.14	10.30	2.02	25.50	3.10
3.5	1.17	10.50	2.02	26.00	3.17
3.7	1.21	10.70	2.02	26.50	3.11
3.9	1.24	10.90	2.08	27.00	3.16
4.1	1.26	11.10	2.02	28.00	3.19
4.3	1.26	11.30	2.09	29.00	3.19
4.5	1.29	11.50	2.05	30.00	3.30
4.7	1.34	11.70	2.11	31.00	3.31
4.9	1.34	11.90	2.11	32.00	3.35
5.1	1.40	12.10	2.12	33.00	3.46
5.3	1.43	12.40	2.17	34.00	3.45
5.5	1.45	13.00	2.29	35.00	3.49
5.7	1.47	13.50	2.31	36.00	3.54
5.9	1.40	14.00	2.43	37.00	3.62
6.1	1.53	14.50	2.43	39.00	3.69
6.3	1.55	15.00	2.46	40.00	3.75

**Cable loss**  
**Cable coaxial, Gore, 18 GHz, 1.5 m, SMA-SMA, S/N 91P72067**  
**HL 2912**

Frequency, MHz	Cable loss, dB	Frequency, MHz	Cable loss, dB	Frequency, MHz	Cable loss, dB
10	0.07	5750	1.56	12000	2.23
30	0.10	6000	1.48	12250	2.14
100	0.17	6250	1.55	12500	2.19
250	0.28	6500	1.52	12750	2.14
500	0.43	6750	1.57	13000	2.24
750	0.52	7000	1.59	13250	2.19
1000	0.59	7250	1.64	13500	2.24
1250	0.66	7500	1.66	13750	2.14
1500	0.72	7750	1.78	14000	2.29
1750	0.81	8000	1.87	14250	2.41
2000	0.82	8250	1.78	14500	2.48
2250	0.94	8500	1.79	14750	2.31
2500	0.94	8750	1.88	15000	2.45
2750	0.99	9000	2.01	15250	2.55
3000	1.03	9250	1.90	15500	2.75
3250	1.15	9500	1.90	15750	2.75
3500	1.13	9750	1.90	16000	2.68
3750	1.17	10000	2.03	16250	2.73
4000	1.19	10250	2.04	16500	2.82
4250	1.31	10500	2.26	16750	2.79
4500	1.24	10750	2.09	17000	2.87
4750	1.30	11000	2.05	17250	2.80
5000	1.31	11250	2.15	17500	2.90
5250	1.41	11500	2.34	17750	2.82
5500	1.41	11750	2.34	18000	2.90



## 14 APPENDIX F Abbreviations and acronyms

A	ampere
AC	alternating current
A/m	ampere per meter
AM	amplitude modulation
AVRG	average (detector)
BB	broad band
cm	centimeter
dB	decibel
dBm	decibel referred to one milliwatt
dB( $\mu$ V)	decibel referred to one microvolt
dB( $\mu$ V/m)	decibel referred to one microvolt per meter
dB( $\mu$ A)	decibel referred to one microampere
dB $\Omega$	decibel referred to one Ohm
DC	direct current
EIRP	equivalent isotropically radiated power
ERP	effective radiated power
EUT	equipment under test
F	frequency
GHz	gigahertz
GND	ground
H	height
HL	Hermon laboratories
Hz	hertz
ITE	information technology equipment
k	kilo
kHz	kilohertz
LISN	line impedance stabilization network
LO	local oscillator
m	meter
MHz	megahertz
min	minute
mm	millimeter
ms	millisecond
$\mu$ s	microsecond
NA	not applicable
NB	narrow band
NT	not tested
OATS	open area test site
$\Omega$	Ohm
QP	quasi-peak
PCB	printed circuit board
PM	pulse modulation
PS	power supply
RE	radiated emission
RF	radio frequency
rms	root mean square
Rx	receive
s	second
T	temperature
Tx	transmit
V	volt
VA	volt-ampere