



UWB-D00128 Rev K

EasyST
Hardware Installation
User Guide

Software Release 7.7





Acknowledgements

Airspan Networks Inc acknowledges the following trademarks used within this document:

 © Intel Corporation <http://www.intel.com/>

 © SEQUANS COMMUNICATIONS <http://www.sequans.com>

 © Microsoft Corporation <http://www.microsoft.com>

Copyright

© Copyright by **Airspan Networks Inc.**, 2009. All rights reserved worldwide.

The information contained within this document is proprietary and is subject to all relevant copyright, patent and other laws protecting intellectual property, as well as any specific agreements protecting Airspan Networks Inc. rights in the aforesaid information. Neither this document nor the information contained herein may be published, reproduced or disclosed to third parties, in whole or in part, without the express, prior, written permission of Airspan Networks Inc. In addition, any use of this document or the information contained herein for the purposes other than those for which it is disclosed is strictly forbidden.

Airspan Networks Inc. reserves the right, without prior notice or liability, to make changes in equipment design or specifications.

Information supplied by Airspan Networks Inc. is believed to be accurate and reliable. However, no responsibility is assumed by Airspan Networks Inc. for the use thereof nor for the rights of third parties which may be effected in any way by the use of thereof.

Any representation(s) in this document concerning performance of Airspan Networks Inc. product(s) are for informational purposes only and are not warranties of future performance, either expressed or implied. Airspan Networks Inc. standard limited warranty, stated in its sales contract or order confirmation form, is the only warranty offered by Airspan Networks Inc. in relation thereto.

This document may contain flaws, omissions or typesetting errors; no warranty is granted nor liability assumed in relation thereto unless specifically undertaken in Airspan Networks Inc. sales contract or order confirmation. Information contained herein is periodically updated and changes will be incorporated into subsequent editions. If you have encountered an error, please notify Airspan Networks Inc. All specifications are subject to change without prior notice.

Product performance figures quoted within this document are indicative and for information purposes only.



Table of Contents

Acknowledgements	2
Copyright	2
Table of Contents	3
Summary of Figures	5
Summary of Tables	6
Warnings and Cautions	7
Human Exposure to Radio Frequencies.....	7
Radio Interference	7
Avoiding Radio Interference	7
Modifications	7
Manufacturer's Disclaimer Statement.....	7
Declaration of Conformity	8
FCC Notice	9
Federal Communication Commission Notice	9
Maximum Output TX Power	10
700MHz External Antennas.....	10
1 About this Guide.....	11
1.1 Purpose	11
1.2 Intended Audience	11
1.3 Conventions	11
1.4 Referenced Documentation	12
2 System Overview	13
2.1 EasyST Frequency Ranges	14
2.2 Main Features	15
2.3 EasyST-2 Frequency Ranges.....	15
2.4 Main Features	16
2.5 Architecture	17
2.5.1 EasyST Models	18
2.5.2 EasyST Block Diagram	18
2.6 EasyST Protocol Stack	19
2.7 Theory of Operation	20
3 Installation Prerequisites	21
3.1 Package Contents	21
3.2 Minimum PC Requirements	21
3.3 Required Tools	21
4 Physical Description	22
4.1 Physical Dimensions	22



4.2 Ports	22
4.3 LEDs.....	23
4.4 LED Button	25
5 Cabling	27
5.1 Connecting EasyST to a Computer.....	27
5.2 Connecting EasyST to Power	28
5.2.1 Changing the AC/DC Power Adapter's Prongs.....	28
5.2.2 Connecting the Power	29
5.3 Verifying Correct Cabling	30
6 Mounting	31
6.1 Desktop Mounting	31
6.2 Wall Mounting.....	31
7 Optimizing RF Reception	34
8 Connecting the External Antenna	36
8.1 Attaching the Antenna RF Cable.....	36
8.2 Mounting the External Antenna.....	38
9 Replacing the Clip-On Antenna	41
10 EasyST Smart Card	44
11 Resetting EasyST to Default Settings.....	45
12 Troubleshooting.....	46
13 Appendix	47
13.1 Glossary of Terms	47
13.2 Revision History	48
13.3 Contact Information.....	49



Summary of Figures

Figure 1 - EasyST Maximum Output TX Power	10
Figure 2 - EasyST architecture.....	18
Figure 3 - EasyST Block Diagram	19
Figure 4 - EasyST protocol stack	20
Figure 5 - EasyST top panel ports.....	23
Figure 6 - EasyST side and bottom panel ports.....	23
Figure 7 - EasyST LEDs.....	24
Figure 8 - cable connection	27
Figure 9 - EasyST to PC port	28
Figure 10 - change prongs	29
Figure 11 - cord connection.....	29
Figure 12 - Desktop	31
Figure 13 - Wall mounting	32
Figure 14 - Mounting hooks.....	33
Figure 15 - Signal strength LED	34
Figure 16 - Positioning EasyST	35
Figure 17 - lift clip-on antenna	36
Figure 18 - remove plastic cover	37
Figure 19 - connecting antenna.....	37
Figure 20 - install plastic cap	38
Figure 21 - external antenna window-mount.....	39
Figure 22 - Mounting antenna on its front panel.....	39
Figure 23 - Mounting antenna on its side panel	40
Figure 24 - mounted antenna	40
Figure 25 - Remove cover	41
Figure 26 - Unplug MCX connector.....	41
Figure 27 - clip-on antenna.....	42
Figure 28 - antenna attached	42
Figure 29 - insert screw	43
Figure 30 - tighten screw	43
Figure 31 - Resetting EasyST	45



Summary of Tables

Table 1 - 700MHz External Antenna Types	10
Table 2 - EasyST Frequency Ranges	14
Table 3 - EasyST-2 Frequency Ranges	15
Table 4 - EasyST physical dimensions	22
Table 5 - EasyST ports	22
Table 6 - EasyST LEDs	24
Table 7 - Professional Mode # 1	25
Table 8 - Professional Mode # 2 - RSSI	25
Table 9 – pinouts	27
Table 10 -verify cabling	30
Table 11 - SNR values	35
Table 12 – Troubleshooting	46



Warnings and Cautions

Human Exposure to Radio Frequencies

The EasyST (or the external antenna, if implemented) should be installed and operated from a minimum distance of 20 cm except for 700MHz antenna which must have a minimum distance of 45 cm to your body.

Radio Interference

This equipment generates, uses, and can radiate radio frequency energy and, if not installed and used in accordance with the instructions, may cause harmful interference to radio communications. However, there is no guarantee that interference will not occur in a particular installation. If this equipment does cause harmful interference to radio or television reception, which can be determined by turning the equipment on and off, the user is encouraged to try correcting the interference by performing one or more of the following measures:

- Re-orientate or relocate the receiving antenna
- Increase separation between the equipment and receiver
- Connect the equipment to an outlet on a circuit different from that to which the receiver is connected
- Consult the dealer or an experienced radio/TV technician for help

Avoiding Radio Interference

- This transmitter must not be co-located or operating in conjunction with any antenna or transmitter.
- Ensure a minimum of 1-meter separation between co-located EasySTs.
- When using an external antenna, the external antenna must not be co-located or operating in conjunction with any other antenna or transmitter.

Modifications

Any changes and modifications to this device that are not expressly approved by Airspan Networks may void the user's authority to operate the equipment.

Manufacturer's Disclaimer Statement

The information in this document is subject to change without notice and does not represent a commitment on the part of the vendor. No warranty or representation, either expressed or implied, is made with respect to the quality, accuracy or fitness for any particular purpose of this document. The manufacturer reserves the right to make changes to the content of this document and/or the products associated with it at any time without obligation to notify any person or organization of such changes. In no event will the manufacturer be liable for direct, indirect, special, incidental or consequential damages arising out of the use or inability to use this product or documentation, even if advised of the possibility of such damages. This document contains materials protected by copyright. All rights are reserved. No part of this manual may be reproduced or transmitted in any form, by any means or for any purpose without expressed written consent of its authors. Product names appearing in this document are mentioned for identification purchases only. All trademarks, product names or brand names appearing in this document are registered property of their respective owners.

Declaration of Conformity

European Community, Switzerland, Norway, Iceland, and Liechtenstein Declaration of Conformity with Regard to the R&TTE Directive 1999/5/EC

English:

This equipment is in compliance with the essential requirements and other relevant provisions of Directive 1999/5/EC.

Deutsch:

Dieses Gerät entspricht den grundlegenden Anforderungen und den weiteren entsprechenden Vorgaben der Richtlinie 1999/5/EU.

Dansk:

Denne udstyr er i overensstemmelse med de væsentlige krav og andre relevante bestemmelser i Direktiv 1999/5/EF.

Español:

Este equipo cumple con los requisitos esenciales así como con otras disposiciones de la Directiva 1999/5/EC.

Greek:

ΜΕ ΤΗΝ ΠΑΡΟΥΣΑ Airspan ΔΗΛΩΝΕΙ ΟΤΙ Ο ΕΞΟΠΛΙΣΜΟΣ ΣΥΜΜΟΡΦΩΝΕΤΑΙ ΠΡΟΣ ΤΙΣ ΟΥΣΙΩΔΕΙΣ ΑΠΑΙΤΗΣΕΙΣ ΚΑΙ ΤΙΣ ΛΟΙΠΕΣ ΣΧΕΤΙΚΕΣ ΔΙΑΤΑΞΕΙΣ ΤΗΣ ΟΔΗΓΙΑΣ 1999/5/ΕΚ.

Français:

Cet appareil est conforme aux exigences essentielles et aux autres dispositions pertinentes de la Directive 1999/5/EC.

Íslenska:

Þessi búnaður samrýmist lögboðnum kröfum og öðrum ákvæðum tilskipunar 1999/5/ESB.

Italiano:

Questo apparato é conforme ai requisiti essenziali ed agli altri principi sanciti dalla Direttiva 1999/5/EC.

Nederlands:

Deze apparatuur voldoet aan de belangrijkste eisen en andere voorzieningen van richtlijn 1999/5/EC.

Norsk:

Denne utstyret er i samsvar med de grunnleggende krav og andre relevante bestemmelser i EU-direktiv 1999/5/EC.

Português:

Este equipamento satisfaz os requisitos essenciais e outras provisões da Directiva 1999/5/EC.

Suomalainen:

Tämä laite täyttää direktiivin 1999/5/EY oleelliset vaatimukset ja on siinä asetettujen muidenkin ehtojen mukainen.

Svenska:

Denna utrustning är i överensstämmelse med de väsentliga kraven och andra relevanta bestämmelser i Direktiv 1999/5/EC.

The Declaration of Conformity related to this product can be obtained from product_management@Airspan.com



FCC Notice

Federal Communication Commission Notice

This equipment has been tested and found to comply with the limits for a Class B digital device, pursuant to Part 15 of the FCC Rules. These limits are designed to provide reasonable protection against harmful interference in a residential installation. This equipment generates, uses and can radiate radio frequency energy and, if not installed and used in accordance with the instructions, may cause harmful interference to radio communications. However, there is no guarantee that interference will not occur in a particular installation. If this equipment does cause harmful interference to radio or television reception, which can be determined by turning the equipment off and on, the user is encouraged to try to correct the interference by one of the following measures:

- Reorient or relocate the receiving antenna.
- Increase the separation between the equipment and receiver.
- Connect the equipment into an outlet on a circuit different from that to which the receiver is connected.
- Consult the dealer or an experienced radio/TV technician for help.

Fixed and base stations transmitting a signal with an emission bandwidth greater than 1 MHz must not exceed an ERP of 1000 watts/MHz and an antenna height of 305 m HAAT, except that antenna heights greater than 305 m HAAT are permitted if power levels are reduced below 1000 watts/MHz ERP.

This device complies with Part 15 of the FCC Rules. Operation is subject to the following two conditions: (1) This device may not cause harmful interference, and (2) this device must accept any interference received, including interference that may cause undesired operation.

FCC Caution: Any changes or modifications not expressly approved by the party responsible for compliance could void the user's authority to operate this equipment.

IMPORTANT NOTE:

FCC Radiation Exposure Statement:

This equipment complies with FCC radiation exposure limits set forth for an uncontrolled environment. This equipment should be installed and operated with minimum distance of 20 cm except for 700MHz antenna which must have a minimum distance of 45 cm between the radiator & your body.

This transmitter must not be co-located or operating in conjunction with any other antenna or transmitter.

Maximum Output TX Power

Frequency Band	ETSI		FCC		Rest of the World		Antenna Gain
	TX	EIRP	TX	EIRP	TX	EIRP	
698-746 MHz TDD			25.9dBm	41.2dBm	25.9dBm	41.2dBm	15.3 dBi
1.4GHz TDD			25.15dBm	31.15dBm	25.15dBm	31.15dBm	6dBi
2.5-2.69 GHz TDD (NPI)					24dBm	33dBm	9 dBi
2.7-2.9 GHz TDD (NPI)					24dBm	33dBm	9 dBi
3.3-3.5 GHz TDD	24dBm	33dBm	N/A	N/A	24dBm	33dBm	9 dBi
3.4-3.6 GHz FDD	24dBm	33dBm	N/A	N/A	24dBm	33dBm	9 dBi
3.6-3.8 GHz FDD	24dBm	33dBm	N/A	N/A	24dBm	33dBm	9 dBi
3.7GHz TDD	24dBm	31.5dBm	18.3	25.8dBm	24dBm	31.5dBm	7.5 dBi
5.15-5.35 GHz TDD	14dBm	23dBm			27dBm	36dBm	9 dBi
5.15-5.25 GHz TDD			8dBm	17dBm	27dBm	36dBm	9 dBi
5.25-5.35 GHz TDD			15dBm	24dBm	27dBm	36dBm	9 dBi
5.47-5.725 GHz TDD	12.5dBm	30dBm	17.6dBm	26.6dBm	27dBm	36dBm	9 dBi
5.725-5.850 GHz TDD	15.5dBm	33dBm	18.5dBm	36dBm	27dBm	36dBm	9 dBi

Figure 1 - EasyST Maximum Output TX Power



Caution: Do not set maximum output TX power higher than local regulations.

700MHz External Antennas

Table 1 - 700MHz External Antenna Types

Type	Frequency range	Gain	Manufacturer	Model number
V-Pol MCX	698-746 MHz	7.5 dBi	Mars Antennas	MA-WA70-AS8
Flat panel	698-746 MHz	10.5 dBi	Mti Wireless Edge Ltd.	MT-223003/N
Sector	698-746 MHz	12 ± 0.5 dBi	Mti Wireless Edge Ltd.	MT-223002/NV
Sector	698-746 MHz	13.5 dBi	Mti Wireless Edge Ltd.	MT-223006/NV
Yagi directional	698 - 746 MHz	15.3 dBi	Trival antene	AD-40/722-14

1 About this Guide

This section discusses the purpose, intended audience, conventions, referenced documentation and organization for this document.

1.1 Purpose

This guide provides step-by-step instructions for setting up and installing the EasyST customer premise equipment (CPE) is part of Airspan's WiMAX family of WiMAX-based products. EasyST also has a multimode model (EasyST-2) based on the Rosedale chipset which supports both TDD and FDD.



Note: EasyST-2 is presently available for frequencies, 3.4-3.6 and 3.6-3.8 only.



Note: For more information on the EasyST-2 contact your supplier.





The purpose of this User Guide is to provide step-by-step instructions for setting up and installing the EasyST. These procedures include:

- System Overview
- Installation Prerequisites
- Physical description
- Cabling
- Mounting
- Connecting

1.2 Intended Audience

This guide is intended for the technician who is qualified and authorized to install the EasyST.

1.3 Conventions

Icon	Description
	Checkpoint: Marks a point in the workflow where there may be an exit or branch to some other procedure. At each Checkpoint the reason for an exit or branch is given along with specific directions to locate the entry point in the other procedure.
	Reference: Gives a resource in the workflow that may be needed to complete a procedure along with specific directions to use the resource.
	Caution: Describes a possible risk and how to lessen or avoid the risk.
	Advice: Provides a recommendation based on best practice.
	Note: Provides useful information.



1.4 Referenced Documentation

For a detailed description of the Web-based configuration tool, refer to the *WiMAX Web-based Management for Subscriber Stations User Guide*.

2 System Overview

EasyST is a revolutionary, self-install, indoor WiMAX customer premises equipment (CPE). The EasyST is designed to work with WiMAX compliant base stations including the base station products in the AS.MAX family. The EasyST, which uses Intel Corporation's Pro/Wireless 5116 broadband interface, connects IP-enabled devices directly to WiMAX networks and can be installed indoors by end users within minutes without the need for costly professional installations by an operator. EasyST is designed for the residential and small enterprise markets, providing high-speed broadband Internet access and a Fast Ethernet connection to the subscriber's local area network (LAN).

EasyST models support IP services at speeds of up to 37 Mbit/s over-the-air gross rates over channel bandwidths of up to 10 MHz in both uplink and downlink. EasyST is available in numerous ETSI frequency bands, operating in FDD and TDD modes in numerous channels, see: [EasyST Frequency Ranges](#) and [EasyST-2 Frequency Ranges](#).

EasyST is also available in a multi-mode model (EasyST-2) based on the Rosedale chipset which supports both TDD and FDD.



Note: EasyST-2 is presently available for frequencies, 3.4–3.6 and 3.6–3.8 only.

EasyST uses the OFDM signaling format, providing non line-of-sight (NLOS) performance. EasyST utilizes QAM, QPSK, and BPSK modulation technologies by modulating transmitted signals and demodulating the received signals where the original digital message can be recovered. The use of adaptive modulation allows EasyST to optimize throughput, yielding higher throughputs while also covering long distances.

EasyST is typically deployed with a clip-on antenna, which is attached directly to the EasyST's top panel. However, for deployments in rigorous terrains, the EasyST can be attached using an RF cable to an external window-mount antenna to provide strong radio coverage.

The EasyST's compact design allows it to be deployed alongside the end-user's PC by simply placing it on a desktop (or mounting it to a wall when using an external antenna. Easy-to-read radio signal strength LED indicators on the EasyST's top panel enable the end user to position the device in the optimum location, ensuring service availability and reliability, while increasing service speed and reducing network load.

EasyST provides 10/100BaseT interface with the subscriber's LAN. In addition, the EasyST provides an interface for adding plug-in expansion modules to provide support for features such as:

- WiFi and LAN Switch (EasyWiFi module)
- VoIP and battery backup (EasyVoice module)

EasyST is powered by an AC/DC power adapter that is plugged into any standard electrical wall outlet. The power adapter provides interchangeable plug prongs to suit country-specific electrical wall sockets.

EasyST can be managed by Airspan's AS.MAX Web-based management system using standard Web browsers, or alternatively, by an SNMP-based network management system (Netspan) through BS intervention using standard and proprietary MIBs. In addition, external third-party management systems such as HP OpenView can also manage the EasyST using these MIBs.



2.1 EasyST Frequency Ranges

The table below lists the frequency range of EasyST models currently available. This table will grow as more models become available.

Table 2 - EasyST Frequency Ranges

Frequency Band	Channel Bandwidth
698 – 748 in MHz TDD mode	<ul style="list-style-type: none">➤ 2.5 MHz➤ 5 MHz➤ 10 MHz
1.39 – 1.524 in GHz TDD mode	<ul style="list-style-type: none">➤ 1.5 MHz➤ 1.75 MHz➤ 2.5 MHz➤ 5 MHz
2.5 – 2.69 GHz in TDD mode NPI	<ul style="list-style-type: none">➤ 2.5 MHz➤ 5 MHz➤ 10 MHz
2.7 – 2.9 GHz in TDD mode NPI	<ul style="list-style-type: none">➤ 3 MHz➤ 6 MHz➤ 10 MHz
3.3 – 3.5 GHz in TDD mode	<ul style="list-style-type: none">➤ 1.75 MHz➤ 2.75 MHz➤ 3.5 MHz➤ 5 MHz
3.4 – 3.6 GHz in FDD mode	<ul style="list-style-type: none">➤ 1.75 MHz➤ 3.5 MHz
3.6 – 3.8 GHz in TDD mode	<ul style="list-style-type: none">➤ 1.75 MHz➤ 3.5 MHz➤ 5 MHz
4.9 – 5.0 GHz in TDD mode	<ul style="list-style-type: none">➤ 2.5 MHz➤ 5 MHz➤ 10 MHz
5.47 – 5.725 GHz in TDD mode	<ul style="list-style-type: none">➤ 2.5 MHz➤ 5 MHz➤ 10 MHz
5.725 – 5.875 GHz in TDD mode	<ul style="list-style-type: none">➤ 2.5 MHz➤ 5 MHz➤ 10 MHz

5.850 – 5.950 GHz in TDD mode	<ul style="list-style-type: none"> ➤ 2.5 MHz ➤ 5 MHz ➤ 10 MHz
-------------------------------	--

2.2 Main Features

- World's First "Self-Install" WiMAX Subscriber Station - fast, easy and simple installation
- Full Indoor Non-LOS Deployment -- 256 FFT
- No professional installation, simply Plug and Play -- user unpacks, plugs in and surfs
- Based on the latest wireless technology WiMAX IEEE 802.16 standard
- Based on 802.16 ProWireless 5116 Rosedale chip
- Compact unit occupying little space
- Designed to sit next to a computer on a desktop (or mounted on a wall when external antenna used)
- Clip-on antenna containing four 90-degree, high-gain directional antennas providing 360 degree coverage (EasyST selects antenna with best RF reception) -- self pointing for easy setup by untrained subscriber
- Provides signal strength LEDs for quick and simple alignment with provider's base station
- High throughput providing fast access at burst data rates of up to 37 Mbps over channel bandwidths of up to 10 MHz
- Supports transparent bridging
- Supports multiple UL bursts per SS frame
- Signal information can be obtained via Web Management Performance tool
- Supports QoS (based on IP addresses, protocols, applications, DiffServ/TOS, 802.1p)
- Smart Card (SIM) option
- Configuration for Operator Network via integrated Smart Card (SIM) socket
- Stackable Style Design for adding plug-in expansion modules for the following interfaces:
 - Integrated IEEE 802.11b/g WiFi access point and 4 Port LAN Switch (EasyWiFi) allowing you to add WiFi functionality to your EasyST.
 - Integrated VoIP allowing connection of 2 conventional telephones (POTS) one Ethernet and battery backup (EasyVoice) allowing you to add VoIP functionality to your EasyST.
- Low cost



Note: Contact your Airspan representative for more information on the EasyVoice extension module or the EasyWiFi extension module.



Note: Check product specifications for latest feature content.

2.3 EasyST-2 Frequency Ranges

The table below lists the frequency range of EasyST-2, TDD/FDD Multimode models currently available. This table will grow as more models become available.

Table 3 - EasyST-2 Frequency Ranges



Frequency Band	Channel Bandwidth
3.4 – 3.6 GHz in TDD/FDD 50/100 mode	<ul style="list-style-type: none">➤ 1.75 MHz➤ 2.75 MHz➤ 3.5 MHz➤ 5 MHz➤ 7 MHz➤ 10 MHz
3.6 – 3.8 GHz in TDD/FDD 50/100 mode	<ul style="list-style-type: none">➤ 1.75 MHz➤ 2.75 MHz➤ 3.5 MHz➤ 5 MHz➤ 7 MHz➤ 10 MHz

2.4 Main Features

- New CPE variants are equipped with Rosedale chipset enabling FDD/TDD multimode operation, supporting 5 MHz and 7 MHz in both TDD and HFDD modes.
- Mobile WiMAX upgrade-able
- World's First "Self-Install" WiMAX Subscriber Station - fast, easy and simple installation
- Full Indoor Non-LOS Deployment -- 256 FFT
- No professional installation, simply Plug and Play -- user unpacks, plugs in and surfs
- Based on the latest wireless technology WiMAX IEEE 802.16 standard
- Based on 802.16 ProWireless 5116 Rosedale chip
- Compact unit occupying little space
- Designed to sit next to a computer on a desktop (or mounted on a wall when external antenna used)
- Clip-on antenna containing four 90-degree, high-gain directional antennas providing 360 degree coverage (EasyST selects antenna with best RF reception) -- self pointing for easy setup by untrained subscriber
- Provides signal strength LEDs for quick and simple alignment with provider's base station
- High throughput providing fast access at burst data rates of up to 37 Mbps over channel bandwidths of up to 10 MHz
- Supports transparent bridging
- Supports multiple UL bursts per SS frame
- Signal information can be obtained via Web Management Performance tool
- Supports QoS (based on IP addresses, protocols, applications, DiffServ/TOS, 802.1p)
- Smart Card (SIM) option
- Configuration for Operator Network via integrated Smart Card (SIM) socket
- Stackable Style Design for adding plug-in expansion modules for the following interfaces:

-
- Integrated IEEE 802.11b/g WiFi access point and 4 Port LAN Switch (EasyWiFi) which allows you to add WiFi functionality to your EasyST.
 - Integrated VoIP allowing connection of 2 conventional telephones (POTS) one Ethernet and battery backup (EasyVoice) allowing you to add VoIP functionality to your EasyST.
- Low cost



Note: Contact your Airspan representative for more information on the EasyVoice extension module or the EasyWiFi extension module.



Note: Check product specifications for latest feature content.

2.5 Architecture

The EasyST is a self-install indoor unit requiring no professional installation. The EasyST architecture includes the following components:

- EasyST module with clip-on antenna
- AC/DC power adapter with interchangeable plug prongs: plugged into a standard electrical wall outlet (110/240 VAC, 50/60 Hz), supplying the EasyST with 6 VDC power

The EasyST provides a fast and easy mounting method by allowing you to simply place it on a desktop/table. However, if an external antenna is used, the EasyST can alternatively be mounted on a wall.

The figure below displays the EasyST architecture:

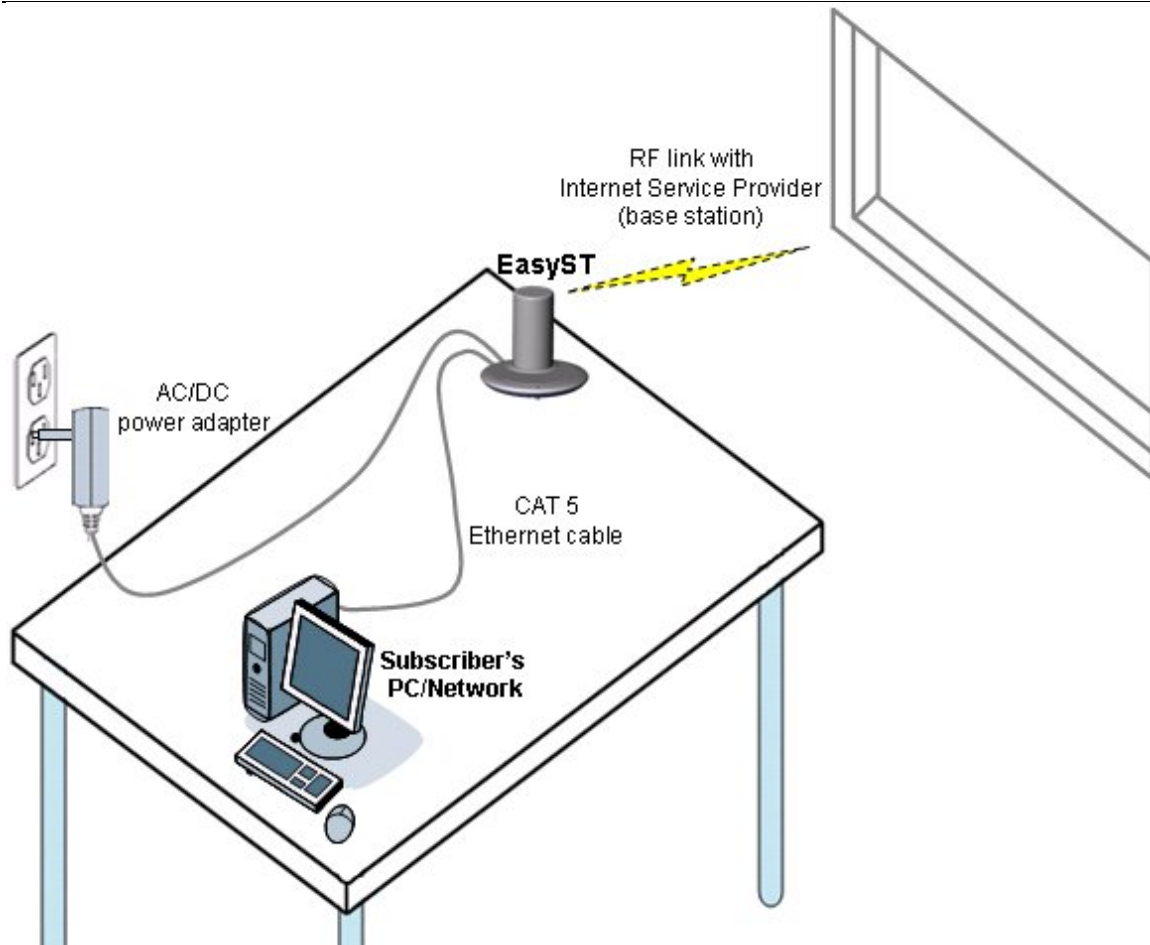

Figure 2 - EasyST architecture

2.5.1 EasyST Models

The EasyST is available in three optional deployment models:

- EasyST with clip-on antenna containing four high-gain, integrated flat panel, 90-degree directional antennas, providing 360 degree coverage. EasyST selects the antenna with best RF reception with the BS by using the 6-pin Antenna Controller.
- EasyST with external antenna connected by RF cable for easy window mounting.
- EasyST (clip on or external antenna) providing plug-in expansion modules supporting the following interfaces:
 - WiFi (EasyWiFi)
 - VoIP and battery backup (EasyVoice)
 - LAN switch

2.5.2 EasyST Block Diagram

The figure below displays the EasyST block diagram:

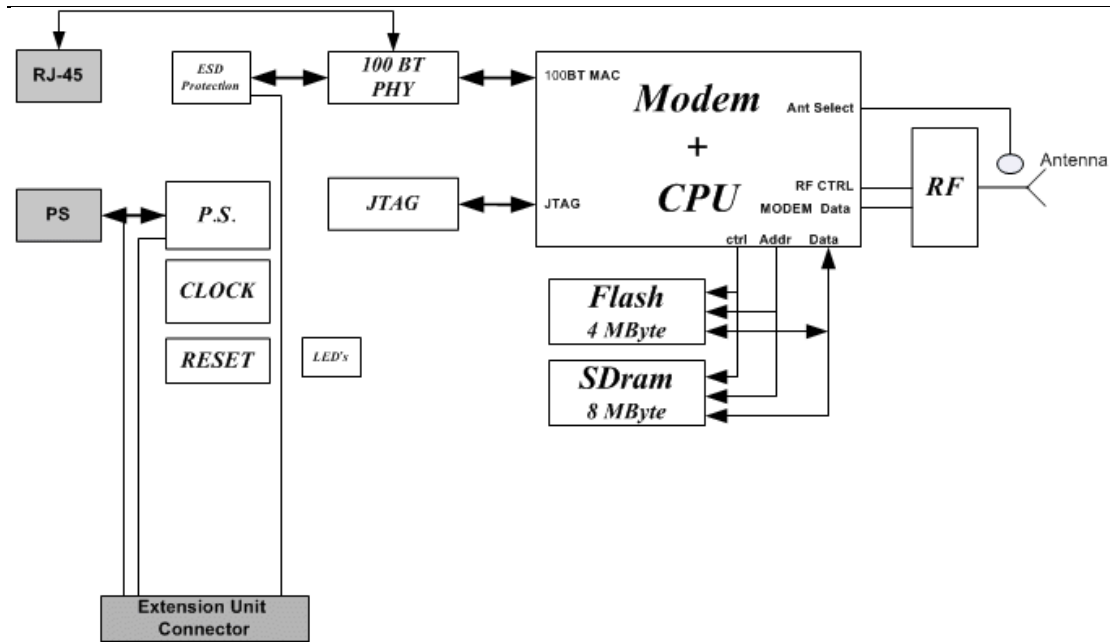

Figure 3 - EasyST Block Diagram



Note: EasyST uses the antenna switch to select one of the four 90-degree antennas of the clip-on antenna. The antenna switch is not used in deployments in which the external window-mount antenna is implemented.

2.6 EasyST Protocol Stack

The figure below displays a block diagram of the EasyST's network architecture, designed as a hierarchy of protocols (i.e. protocol stack) implemented in the communication network.

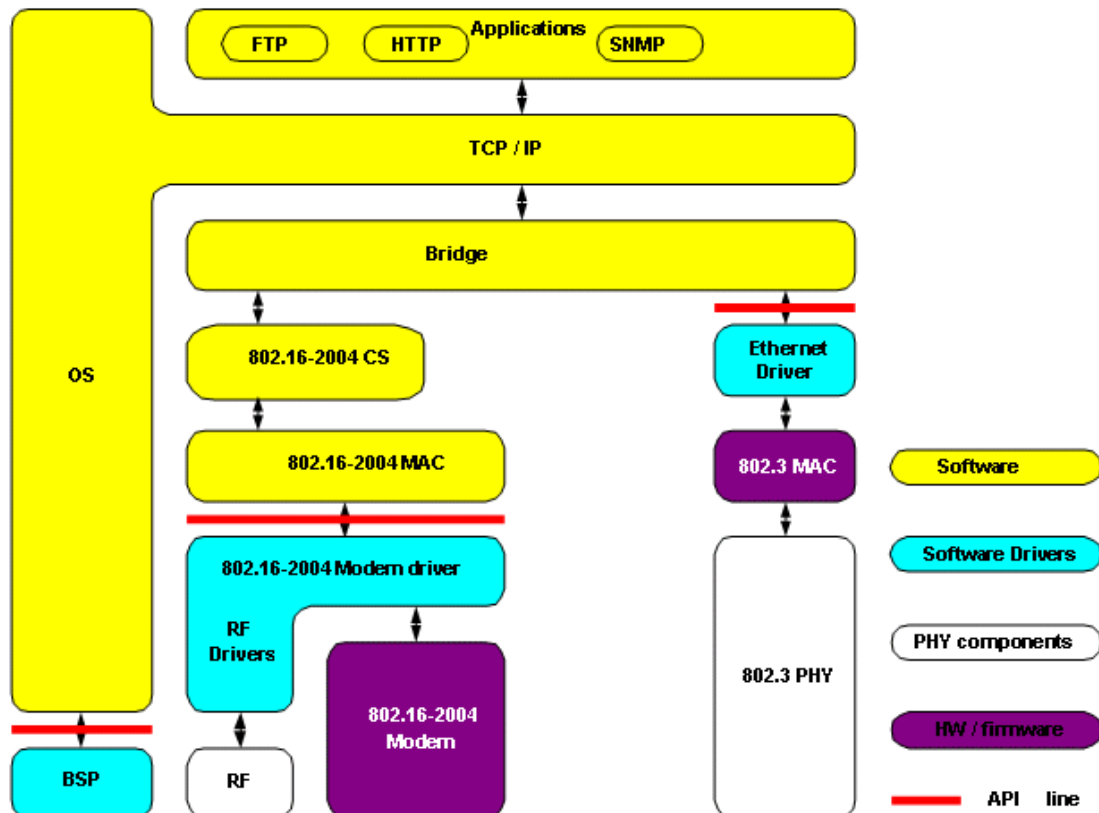

Figure 4 - EasyST protocol stack

2.7 Theory of Operation

For basic operation, the EasyST requires no initial configuration—simply plug and play. Configuration is automatically performed over the air by the BS. The EasyST is preconfigured by the operator at the BS (using Netspan) with service flow parameters such as the maximum information rate, the committed information rate, the maximum latency, and maximum jitter. These configuration parameters are stored in Netspan's database corresponding to the EasyST's MAC address.

Before any communication between EasyST and BS can occur, the EasyST must be positioned in a location that provides sufficient RF reception.

To join a network, the EasyST needs to perform a few tasks. First, the "Network Entry" process (defined in IEEE 802.16-2004) begins with the EasyST scanning for a downlink (DL) signal from the base station, and then synchronizing to the DL channel. Thereafter the EasyST can start the process of initial ranging, which alerts the BS to the presence of the EasyST and establishment of management connections to obtain basic, primary and secondary management connection IDs (CID) from the BS. After the CIDs have been obtained, the EasyST commences authorization and key exchange. In the final stage, the EasyST registers at the base station and thereafter obtains the IP address, time of day and the configuration file from the BS.

During Network entry, the EasyST sends the BS its MAC address. The BS via SNMP notifies Netspan of a new CPE connection and Netspan checks the database to it contains the CPE MAC address. The BS then accesses Netspan's database (via SNMP) and checks whether the EasyST's MAC address appears in the database. If it locates the MAC address, the Netspan feeds all the EasyST's configuration parameters (service flows) from the database and the BS downloads them to the EasyST device.

3 Installation Prerequisites

Before installing your EasyST, read the following sections to ensure that no EasyST items are missing, minimum computer requirements are fulfilled, and you have the required installation tools.

3.1 Package Contents

The EasyST kit includes the following items:

- EasyST module with clip-on antenna
- AC/DC power supply adapter
- CAT-5 Ethernet LAN cable (1.5 meters)
- Mounting kit with 2 x screws and 2 x wall anchors (implemented only when using external antenna)
- Protective plastic cap cover to replace clip-on antenna (implemented only when using external antenna)
- *Quick Installation Guide*



Note: Examine the EasyST shipping container. If you notice any damage, or missing items as listed in the Packing List, immediately notify the carrier that delivered the unit and contact an Airspan representative.

3.2 Minimum PC Requirements

Ensure that your computer provides an Ethernet interface such as a Network Interface Card (that provides an RJ-45 port).

3.3 Required Tools

Typically, the EasyST requires no tools for installation, except when you want to wall mount the unit. For wall-mounting, ensure that you have the following tools:

- Drill with a no. 6 twist drill bit
- Hammer for tapping the wall anchors into the drilled holes
- Pencil for marking the hole positions on the wall
- Philips screwdriver

4 Physical Description

The EasyST's physical description is described in the following topics:

- [Physical dimensions](#)
- [Ports](#)
- [LEDs](#)
- [LED Button](#)

4.1 Physical Dimensions

The physical dimensions of the EasyST are listed in the table below:

Table 4 - EasyST physical dimensions

Parameter	Value
Dimensions (H x W x D):	<ul style="list-style-type: none"> ➤ With clip-on antenna: 130 x 145 x 145 mm (5.12 x 5.7 x 5.7 inches) ➤ Without clip-on antenna: 30 x 145 x 145 mm (1.18 x 5.7 x 5.7 inches)
Weight:	<ul style="list-style-type: none"> ➤ With clip-on antenna: 0.43 kg (approximate) ➤ Without clip-on antenna: 0.3 kg (approximate)

4.2 Ports

The EasyST provides various ports on its top, bottom, and side panels, as described in the table below:

Table 5 - EasyST ports

Panel	Port	Interface
Side	8-pin RJ-45	10/100BaseT Ethernet LAN
	DC power jack	6 VDC power (supplied by AC/DC power adapter)
Top (cover exposed)	6-pin header	Integrated Antenna Controller for attaching clip-on antenna (determines active antenna--1 out of 4)
	MCX jack	Clip-on antenna or window-mount external antenna (connected by RF cable)
Bottom	30-pin IDC socket	Plug-in extension module for the following interfaces: <ul style="list-style-type: none"> ➤ 802.11 WiFi and LAN Switch ➤ VoIP and Battery Backup (EasyVoice)
	SIM	Operator's defined parameters

The EasyST ports located on the top panel (with the clip-on antenna removed) are shown in the figure below:

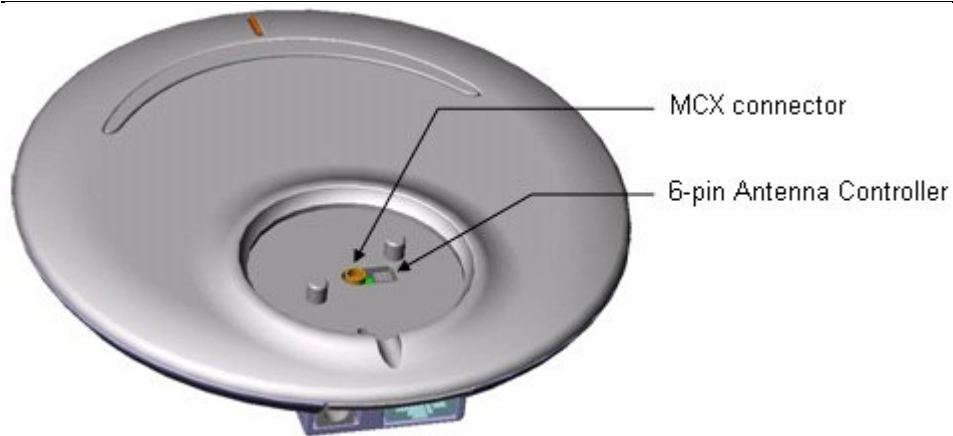

Figure 5 - EasyST top panel ports

The EasyST ports located on the side and bottom panels are shown in the figure below:

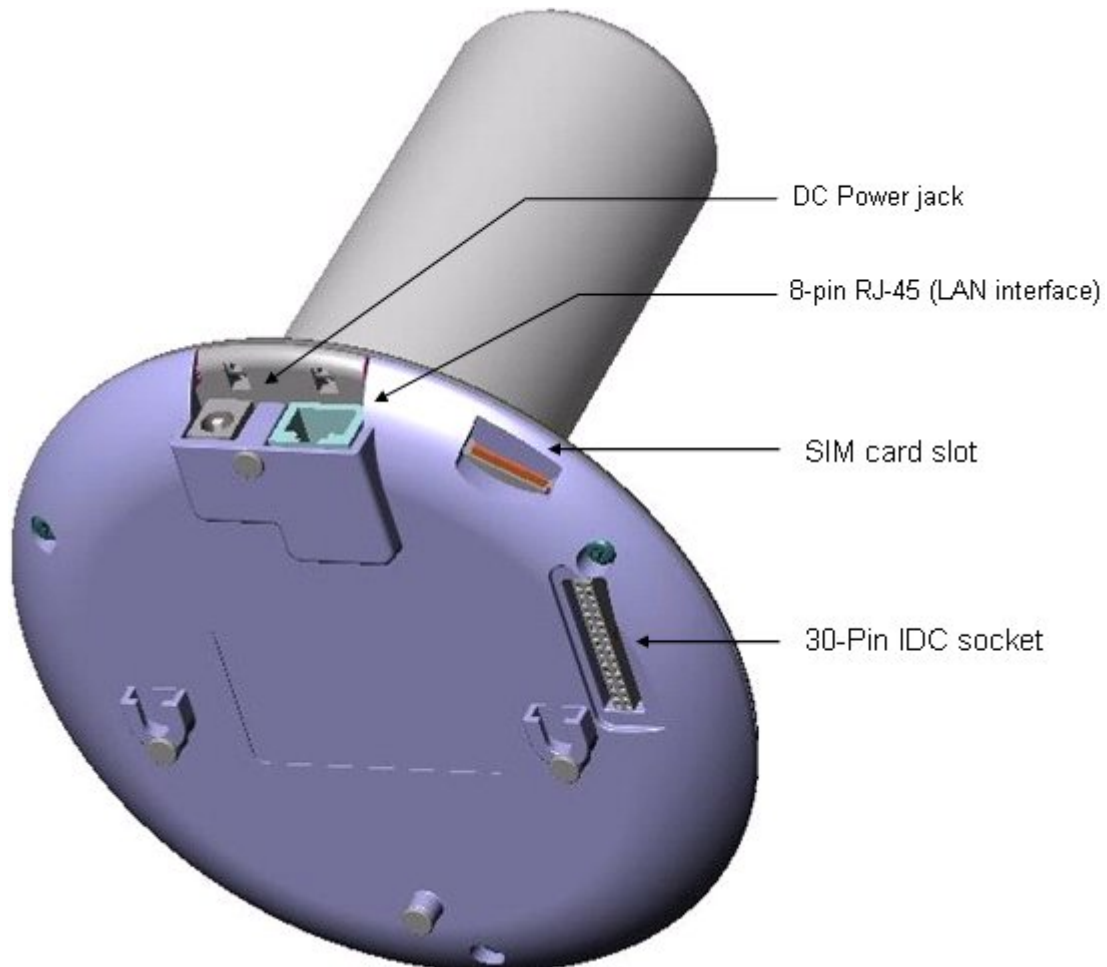

Figure 6 - EasyST side and bottom panel ports

4.3 LEDs

The EasyST provides LEDs for indicating the status of various operations. These LEDs are located on the EasyST's top panel for easy viewing, as shown in the figure below:

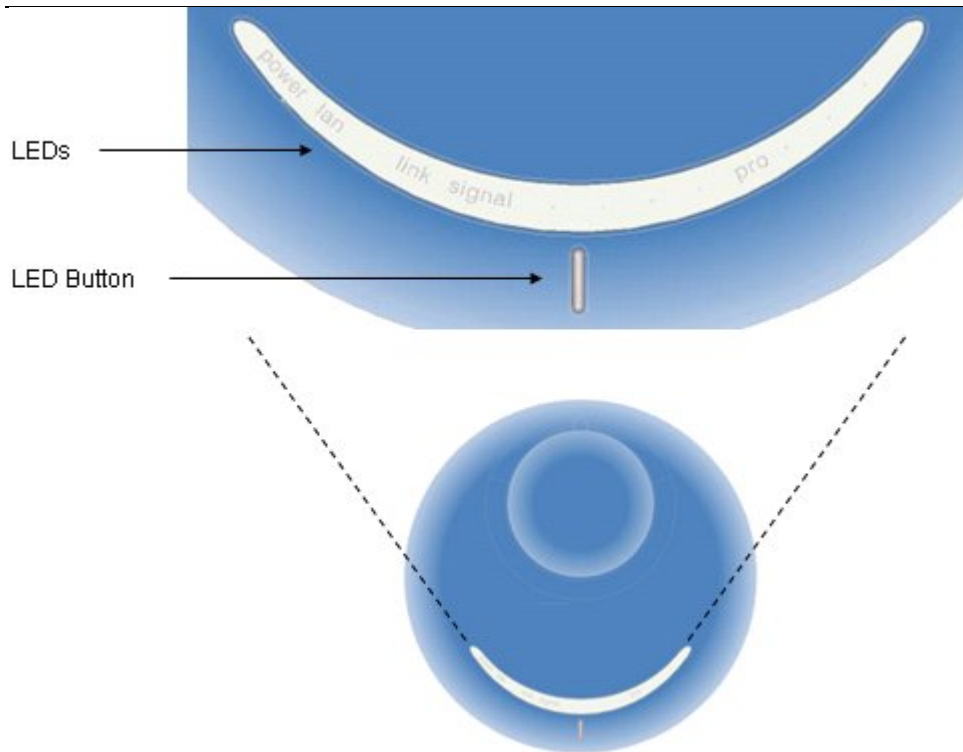

Figure 7 - EasyST LEDs

The EasyST LEDs are described in the table below:

Table 6 - EasyST LEDs

LED	Color	Mode	Status	Description
power	Red		On	EasyST receiving power
			Off	No power received by EasyST
lan	Green		On	10/100BaseT network device (e.g. PC) correctly connected to EasyST
			Flashing	Active LAN link (i.e. traffic flow)
			Off	No 10/100BaseT interface connected to EasyST
link	Green		On	Active WiMAX link
		Flashing	Undergoing Network Entry	
		Off	No WiMAX link	
signal	Customer mode			
	Average Signal to Noise Ratio (SNR)			
	Green	All LEDs are off	SNR < 5	
		First left-most LED is on	5 <= SNR < 9	
		Two left-most LEDs are on	9 <= SNR < 12	

LED	Color	Mode	Status	Description
			Three left-most LEDs are on	12 <= SNR < 16
			Four left-most LEDs are on	16 <= SNR < 22
			Five LEDs are on	22 <= SNR
signal	PRO mode			
	Customer mode		Off	
	Red	Professional Mode #1	On	Modulation (See table below)
	Green	Professional Mode #2	On	RSSI (See table below)
	N/A	Professional Mode #3	N/A	N/A

Table 7 - Professional Mode # 1

Modulation	LED #1	LED #2	LED #3	LED #4	LED #5
BPSK_1/2	OFF	ON	OFF	OFF	OFF
QPSK_1/2	OFF	OFF	ON	OFF	OFF
QPSK_3/4	ON	OFF	ON	OFF	OFF
16QAM-1/2	OFF	OFF	OFF	ON	OFF
16QAM_3/4	ON	OFF	OFF	ON	OFF
64QAM_2/3	OFF	OFF	OFF	OFF	ON
64QAM_3/4	ON	OFF	OFF	OFF	ON

Table 8 - Professional Mode # 2 - RSSI

Average RSSI Values (dBm)	5 Signal LEDs
RSSI < (-95)	All LEDs are OFF
(-95) <= RSSI < (-90)	First (left) LED is ON
(-90) <= RSSI < (-85)	Two first (left) LEDs are ON
(-85) <= RSSI < (-80)	Three left LEDs are ON
(-80) <= RSSI < (-75)	Four left LEDs are ON
(-75) <= RSSI	Five LEDs are ON

4.4 LED Button

The **LED** button (full support pending) located below the LED lights provides the following functionality:

- **Toggles between LED modes:** Each time you press the button, the LED mode changes:

-
- **Customer** (standard mode): **Signal** LEDs display SNR value as described in the table above
 - **Professional #1**: provides technician with an indication of the modulation and FEC used in the uplink
 - **Professional #2**: provides technician with indication of RSSI
 - **Professional #3**: provides technician with indication of downlink throughput (planned for future)
- **Resets EasyST to factory default settings**: To reset to default settings, hold down the button for 10 seconds.



Note: When any of the Professional modes are active for 30 seconds, the mode returns automatically to the Customer mode.

5 Cabling

Cabling your EasyST is fast and simple, and consists of the following:

- [Connecting EasyST to a computer](#)
- [Connecting EasyST to power](#)
- [Verifying correct cabling](#)

5.1 Connecting EasyST to a Computer

EasyST provides 10/100BaseT (Fast Ethernet) interface with the subscriber's network. The connectivity is performed through the supplied Category 5 Ethernet cable consisting of 8-pin RJ-45 connectors on either end.

The EasyST-to-computer cable setup is as follows:

- **Cable:** straight-through CAT 5 Ethernet cable
- **Connector:** 8-pin RJ-45
- **Connector pinouts:**

Table 9 – pinouts

Pin	Function
1	Rx+
2	Rx-
3	Tx+
6	Tx-

To connect EasyST to the subscriber's network:

1. Plug the supplied Category 5 Ethernet cable into the EasyST's 8-pin RJ-45 port.
2. Plug the other end of the Category 5 Ethernet cable into your computer's LAN port located at the back of your computer.

The figure below illustrates the CAT 5 cable connection to the EasyST's RJ-45 port:



Figure 8 - cable connection

The figure below illustrates the CAT 5 cable connection to the computer's LAN port:

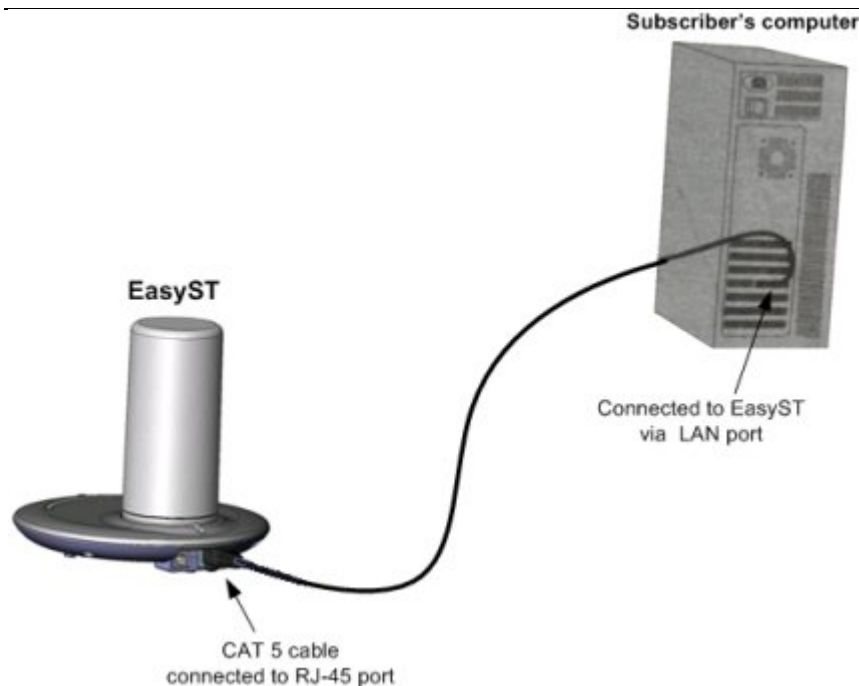

Figure 9 - EasyST to PC port

5.2 Connecting EasyST to Power

EasyST is powered by an AC/DC power supply adapter which supplies the EasyST with 6 VDC (7 Watts). The AC/DC adapter is simply plugged into a standard electrical wall outlet (110/240 VAC; 50/60 Hz). The power adapter provides [interchangeable prongs](#) (e.g. American vs. European) that can be replaced to suit country electrical standards in which the EasyST is being installed.



Note: Any AC/DC power adapter which is Class 2, LPS, and safety approved according to national rules and that provides rated input of 100-240 V, 50/60 Hz, 0.4 A and output of 6 V, 2 A DC, may be used for powering the EasyST.

5.2.1 Changing the AC/DC Power Adapter's Prongs

The AC/DC power adapter provides interchangeable prongs to suit electrical wall outlet sockets in the country in which the EasyST is being installed.

To change the plug prongs:

1. Remove the prongs by forcibly sliding the prongs upwards, away from the power cord.
2. Align the desired prongs with the adapter's prong groove, and then slide the prongs onto the adapter in the orientation as shown in the figure below. Ensure that the prongs reach the end of the prong groove.



Figure 10 - change prongs

5.2.2 Connecting the Power

Once you have attached the correct plug prong to the power adapter, you can connect the power cables.

To connect the EasyST to the power supply:

1. Before plugging the power cord into the electrical wall outlet, plug the AC/DC power adapter's power cable (i.e. DC power jack) into the EasyST's DC power socket.
2. Plug the prongs of the AC/DC power adapter into the electrical wall outlet.

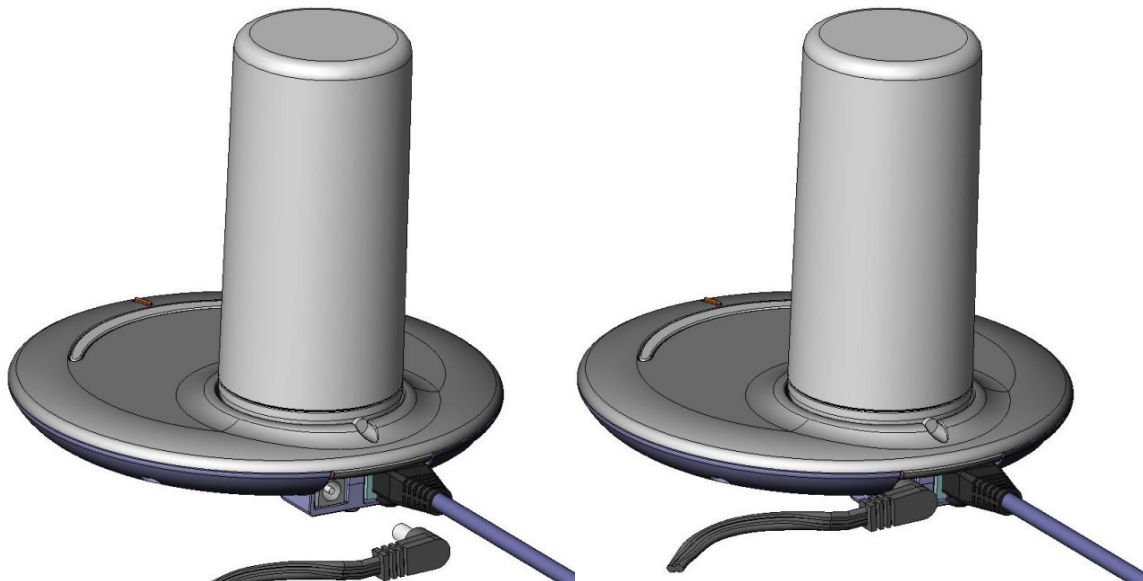

Figure 11 - cord connection



5.3 Verifying Correct Cabling

Once you have connected the EasyST to the subscriber's LAN and to the power supply, you can verify that you have cabled the EasyST correctly by checking the following EasyST LEDs:

Table 10 -verify cabling

Connection	LED	Color	Correct Status	Troubleshooting
Power	power	Red	On	If the power LED is off, recheck the power cabling and that power exists at the wall socket.
LAN	lan	Green	On	If the lan LED is off, recheck the LAN cabling; ensure that you have connected it to the correct LAN port on your PC and that your network connection on your PC is enabled.

6 Mounting



Caution: EasyST is an indoor unit and therefore, must be mounted only indoors.

EasyST is a self-install indoor unit, requiring no professional technician. EasyST must be mounted indoors in a location that provides:

- High quality RF reception with the Internet service provider (i.e. base station)
- Accessibility to power supply and LAN network with regards to cable lengths

The mounting options of the EasyST depend on the antenna configuration:

- **EasyST with clip-on antenna:** [mounted horizontally on a desktop](#)
- **EasyST with window-mount external antenna:**
 - Horizontally on a desktop
 - Vertically on a wall

6.1 Desktop Mounting

The EasyST can be simply placed horizontally on a desk/table (as shown in the figure below). The EasyST radio provides integrated rubber feet (pads) on the bottom panel. These rubber feet provide cushioning as well as insulation from static electricity.



Caution: To prevent a fire hazard caused by overheating, do not place the EasyST on a carpeted surface where airflow is restricted.

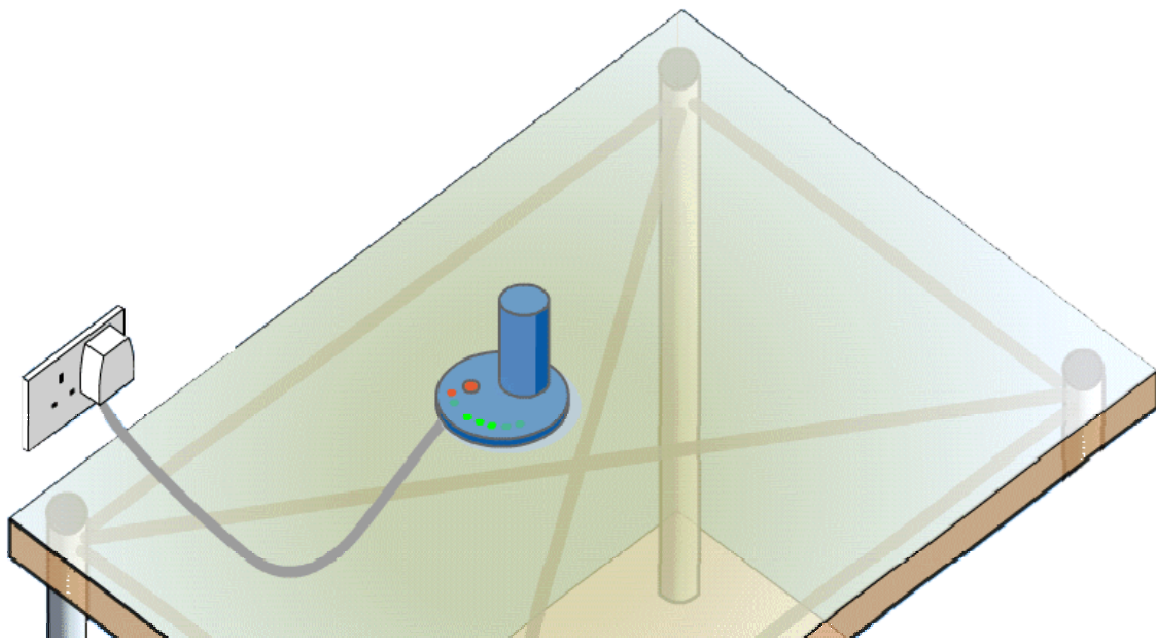

Figure 12 - Desktop

6.2 Wall Mounting

When EasyST implements the window-mount external antenna (i.e. no clip-on antenna), the EasyST can be mounted either on a desk (i.e. desktop mounting) or a wall. For mounting to a

wall, the EasyST provides two mounting hooks molded into EasyST's bottom panel, as shown below:

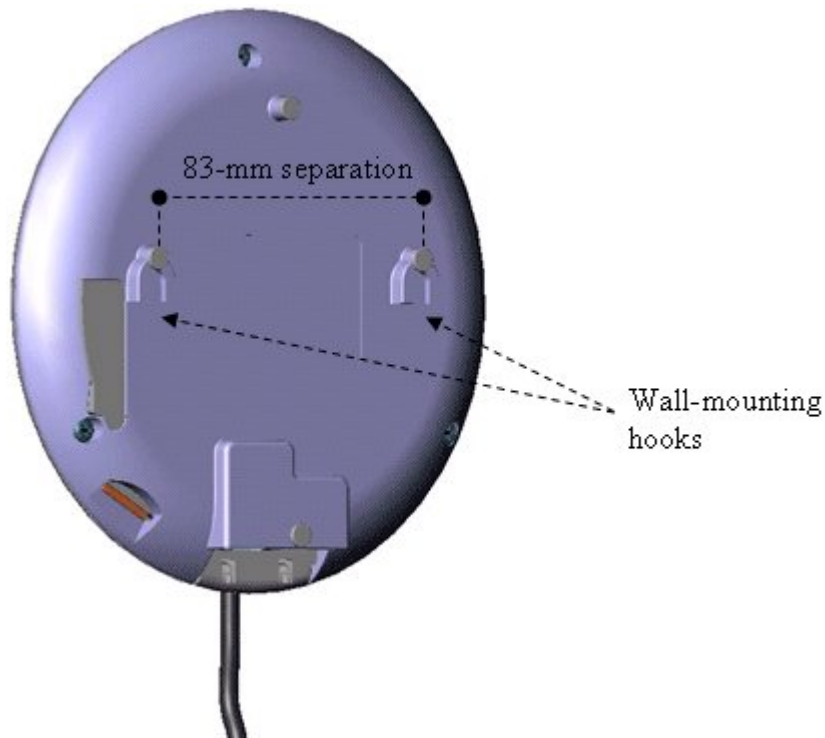

Figure 13 - Wall mounting



Note: Before mounting the unit, ensure that the RF cable of the window-mount external antenna is plugged into the EasyST's MCX connector and that the cover cap is fitted onto the EasyST, protecting the MCX connector.

To wall mount the EasyST:

1. On the wall, mark the position where you want to drill the two holes for the screws on to which the two mounting hooks will later be guided. The distance between the two wall-mounting hooks (from their centers) is 83 mm (3.27 inches). Ensure that the holes are aligned and level using a spirit level.
2. Drill holes for each hole that you marked in the step above, using a no. 6 twist drill bit.
3. Insert the 6-mm wall anchors (supplied) into each of the drilled holes.
4. Drive the two 0.75-inch screws (supplied) into the wall anchors. Ensure that at least 0.08-inch gap is exposed between the screw head and the wall anchor to allow insertion into the EasyST mounting hooks.
5. Align the entrance to the two EasyST mounting hooks with the screws, and then pull down the EasyST to lock the screws into the mounting hooks.

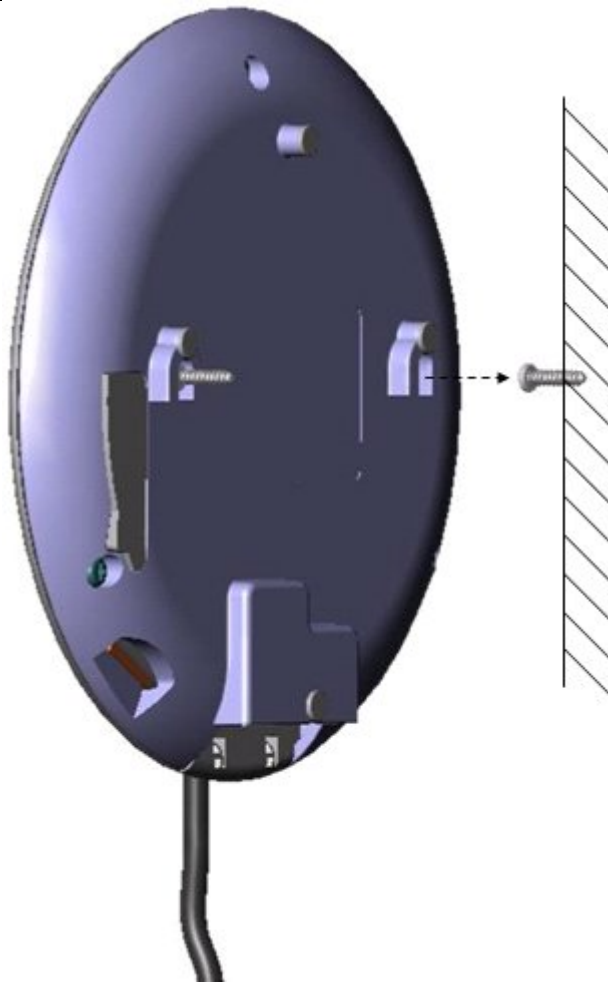

Figure 14 - Mounting hooks

7 Optimizing RF Reception

To ensure a reliable, secure, and fast connection with your Internet Service Provider (ISP), you need to place your EasyST in a position that provides the best RF reception with the ISP (i.e. base station). To help you locate the best position, EasyST provides you with a LED indicator that indicates the strength of the RF signal with your ISP. This LED is labeled **signal** and is located on the EasyST's top panel.

As the signal strength increases, so the **signal** LED line progresses to the right, as illustrated below:

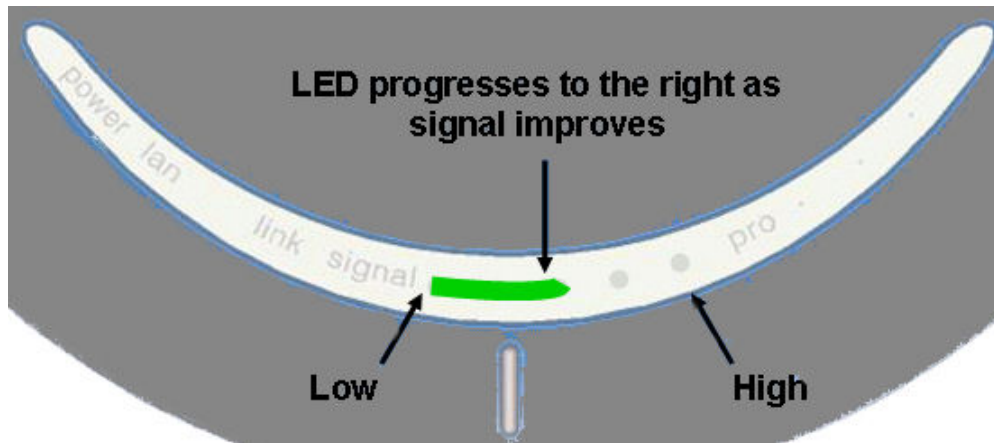

Figure 15 - Signal strength LED

Therefore, for optimal reception, simply move the EasyST to the position that lights up a longer **signal** LED line.

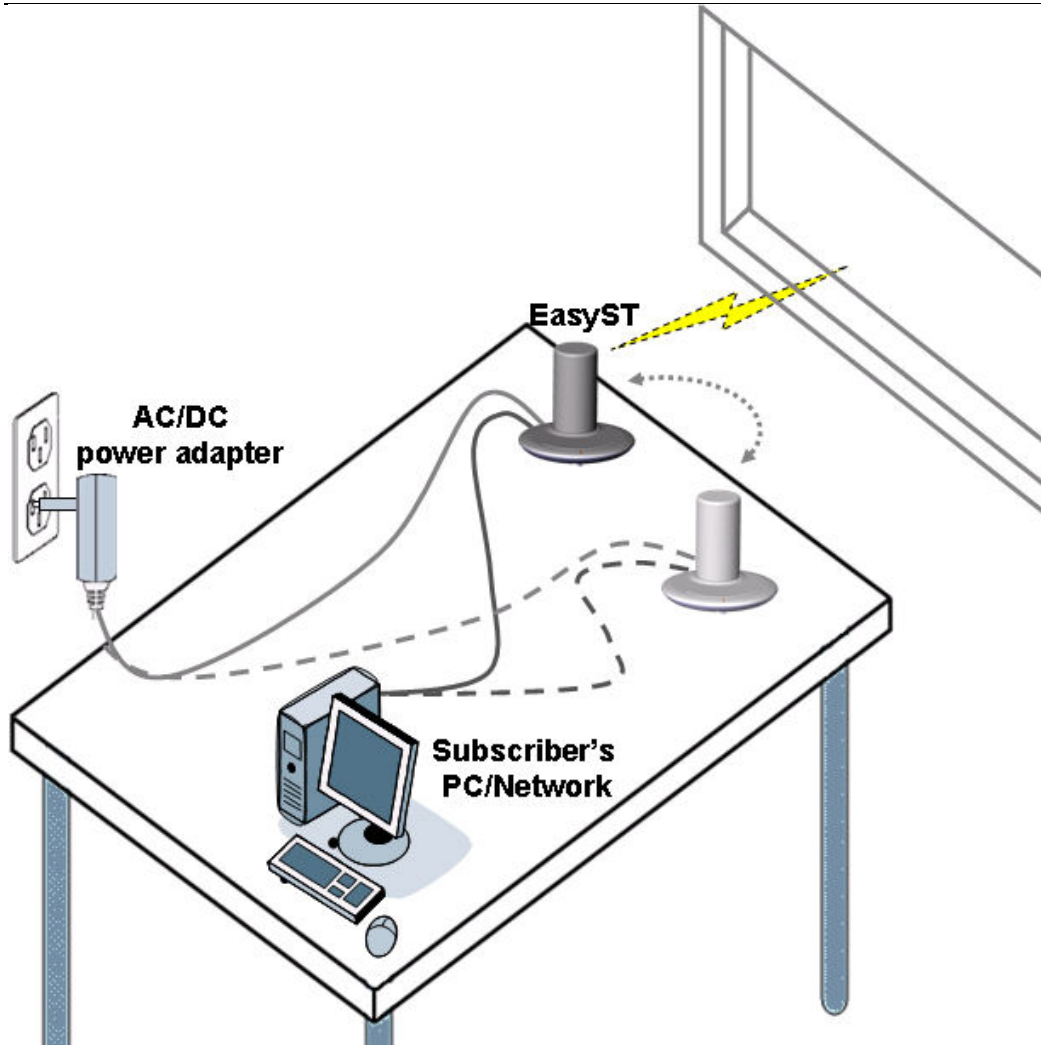

Figure 16 - Positioning EasyST

The **signal** LED indicates the strength of the signal by measuring the signal-to-noise ratio (SNR). SNR indicates received signal strength relative to background noise. The ratio is usually measured in decibels (dB). Thus, the higher the SNR ratio, the better the communication.

The table below describes the EasyST **signal** LEDs with regards to SNR values.

Table 11 - SNR values

LED	Color	Status	Average SNR (dBm)
signal	Green	All LEDs are off	SNR < 5
		First left-most LED is on	5 <= Avg. SNR < 9
		Two left-most LEDs are on	9 <= Avg. SNR < 12
		Three left-most LEDs are on	12 <= Avg. SNR < 16
		Four left-most LEDs are on	16 <= Avg. SNR < 22
		Five LEDs are on	22 <= Avg. SNR

8 Connecting the External Antenna

You can improve RF reception on EasyST by implementing a window-mount external antenna. This may be necessary in the following scenarios:

- Subscriber's premises is located far from the base station, resulting in insufficient signal strength for viable communication link to occur when using the clip-on antenna.
- Location of mounted EasyST provides insufficient signal strength due to obstacles between the EasyST and ISP (i.e. Airspan WiMAX base station) when using the clip-on antenna.

EasyST provides an MCX connector for attaching the window-mount, external antenna's RF cable (approximately 1.5 meters). The external antenna can then be easily mounted in a vertical position on a window using adhesive pads.

The connection of the external antenna to the EasyST is performed in two main steps:

- [Attaching the antenna's RF cable to the EasyST](#)
- [Mounting the external antenna to a window](#)

For a detailed list of the specifications of the external antenna, see Window-Mount Antenna Specifications.

8.1 Attaching the Antenna RF Cable



Caution: Before connecting the external antenna, ensure that the EasyST is NOT connected to the power source. Do not connect and disconnect antennas while the power is on. This can cause irreversible damage to the device.

To attach the external antenna's RF cable to the EasyST:

1. If you had originally ordered the EasyST with a clip-on antenna, then you need to remove it; otherwise, skip to Step 2.
Remove the clip-on antenna by holding down on the EasyST with one hand, and then with the other hand, lifting the clip-on antenna up and away from the EasyST.

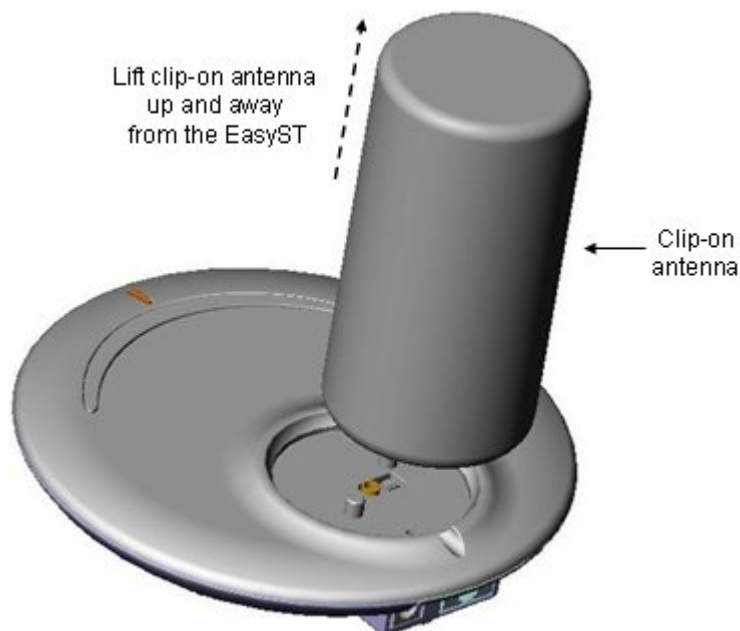

Figure 17 - lift clip-on antenna



Caution: Do not rotate the clip-on antenna until it has detached entirely from the EasyST.

2. Remove the plastic protector cap to expose the MCX female connector. Insert a flat-head screw driver (or any tool with a blunt, pointed edge), into the cable groove created by the cap and the EasyST, and then gently leverage the cap's guides out of the EasyST's cover pins.

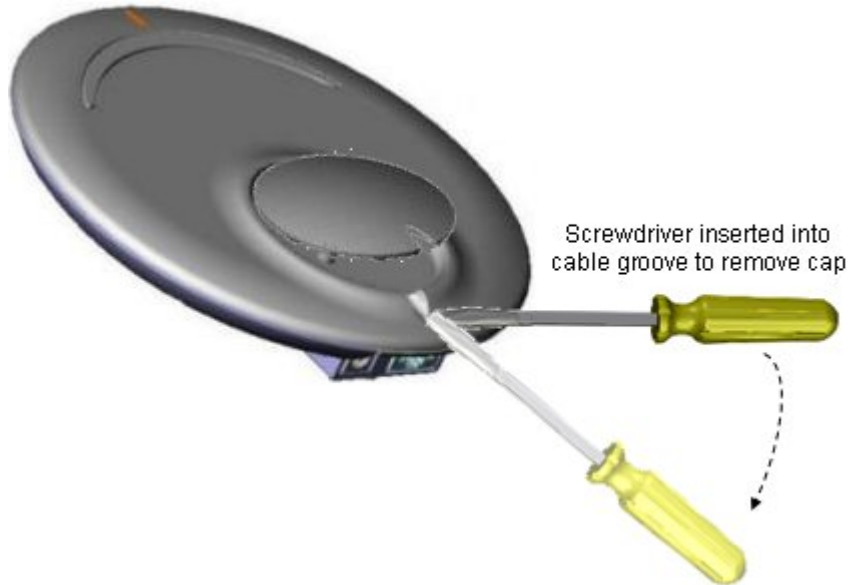

Figure 18 - remove plastic cover

3. Plug the external antenna's MCX connector into the EasyST's MCX female connector, as shown below.



Figure 19 - connecting antenna

4. Feed the RF cable into the EasyST's RF cable groove, ensuring that the RF cable exits the EasyST through the EasyST's RF cable groove, as shown above.
5. Protect the connectors by covering the area exposed by the removal of the clip-on antenna, with the plastic protector cap (supplied). Attach the plastic protector cap to the exposed area, by aligning the cap's two position cups with the EasyST's two position pins. Ensure that the cap's RF cable groove is aligned and flush with the RF cable and EasyST's RF cable groove.

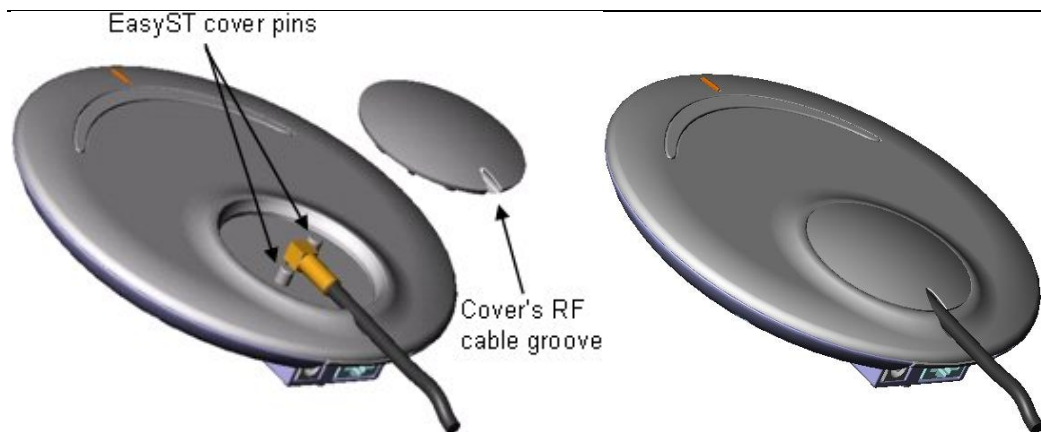

Figure 20 - install plastic cap



Note: If you later decide to disconnect the external antenna and reconnect the clip-on antenna, see [Replacing the Clip-On Antenna](#).

8.2 Mounting the External Antenna

The external antenna can be easily mounted in a vertical position on a window using the adhesive pads located on the side and front panels of the antenna. The antenna can be mounted in one of two orientations:

- Antenna's front panel (narrow edge) is mounted flat against the window (typical orientation)
- Antenna's side panel is mounted flat against the window



Note: The external antenna must be mounted on a flat, smooth, dry, and clean surface (i.e. window).

To window-mount the external antenna:

1. Locate the desired position on the inside of a window to where you want to mount the antenna.
2. Remove the white tape from the adhesive pads. Do not touch the adhesive surfaces.
3. Align the antenna vertically just above the window surface to where you want to mount the antenna, in the desired orientation (as described above).
4. Press the antenna down firmly onto the window surface so that all adhesive pads touch at the same time. Put pressure on all the areas under which are located adhesive pads.

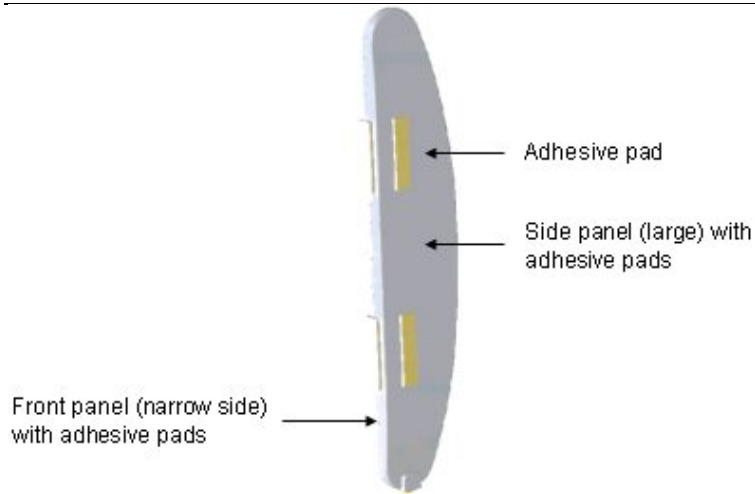

Figure 21 - external antenna window-mount

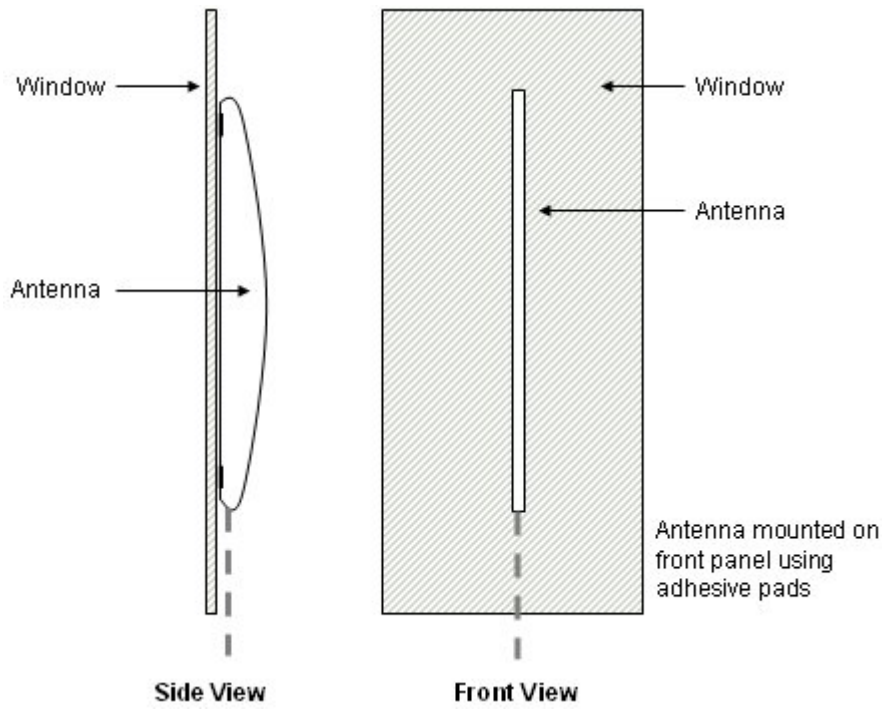

Figure 22 - Mounting antenna on its front panel

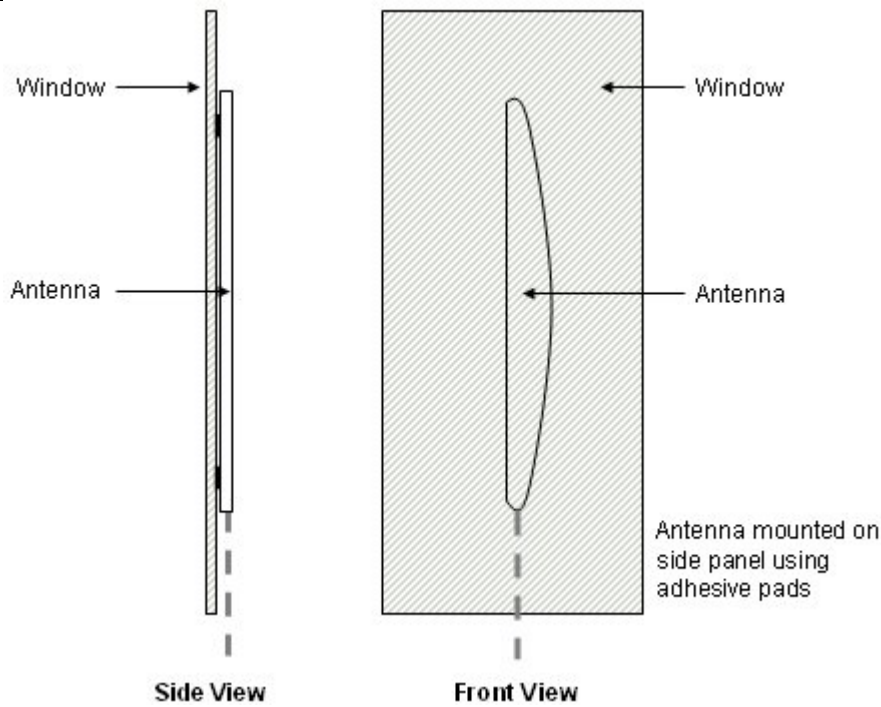

Figure 23 - Mounting antenna on its side panel



Note: When mounted on its side panel, some loss in gain may be incurred.

The figure below displays the antenna mounted on a window using the antenna's side panel.

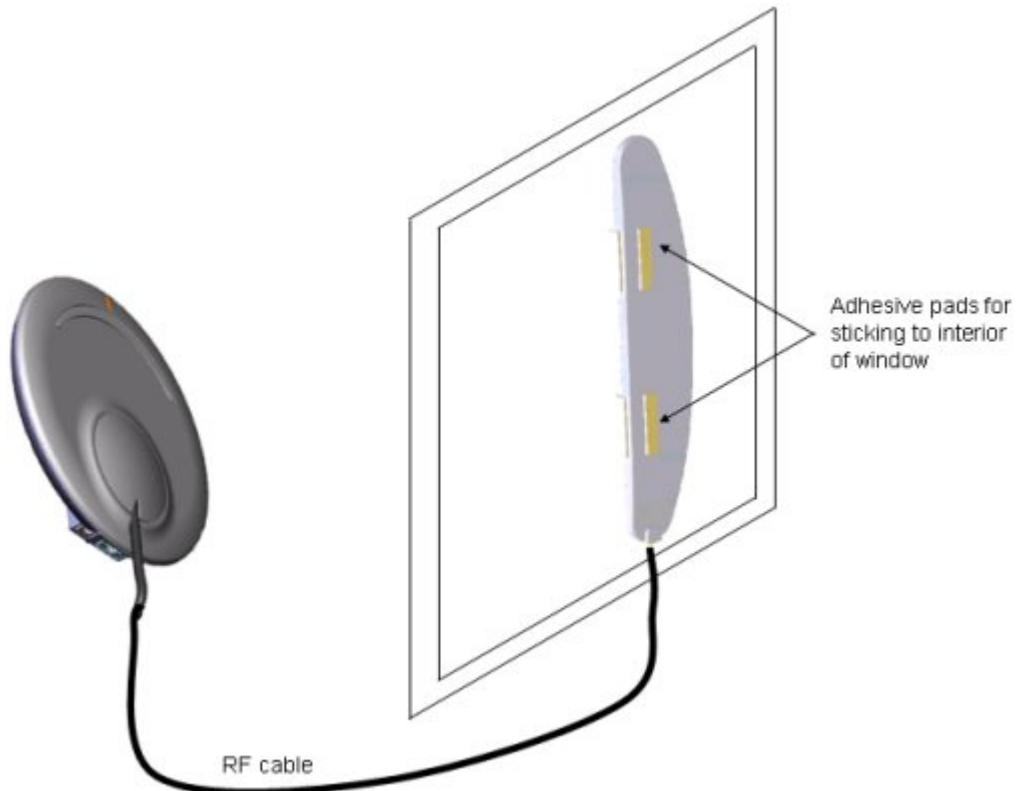

Figure 24 - mounted antenna

9 Replacing the Clip-On Antenna

The EasyST is supplied with the clip-on antenna already attached to the EasyST. However, in cases where you may have previously removed it to connect EasyST to an [external window-mount antenna](#), you may want to discontinue using the external antenna and replace it with the clip-on antenna.



Caution: Before disconnecting the external antenna and replacing the clip-on antenna, ensure that the EasyST is **not** connected to the power source. Do not connect and disconnect antennas while the power is on. This can cause irreversible damage to the EasyST.



Note: Later EasyST models provide a screw for securing the clip-on antenna to the EasyST.

To replace the clip-on antenna:

1. Remove the plastic protection cap protecting the antenna connectors, by inserting a flat-head screw driver between the cap and the EasyST, and then gently leveraging the cap's guides out of the EasyST's cover pins.



Figure 25 - Remove cover

2. Unplug the external antenna's MCX connector from the EasyST's MCX jack.



Figure 26 - Unplug MCX connector

3. Align the clip-on antenna's knob with the EasyST's notch, as shown in the figure below.

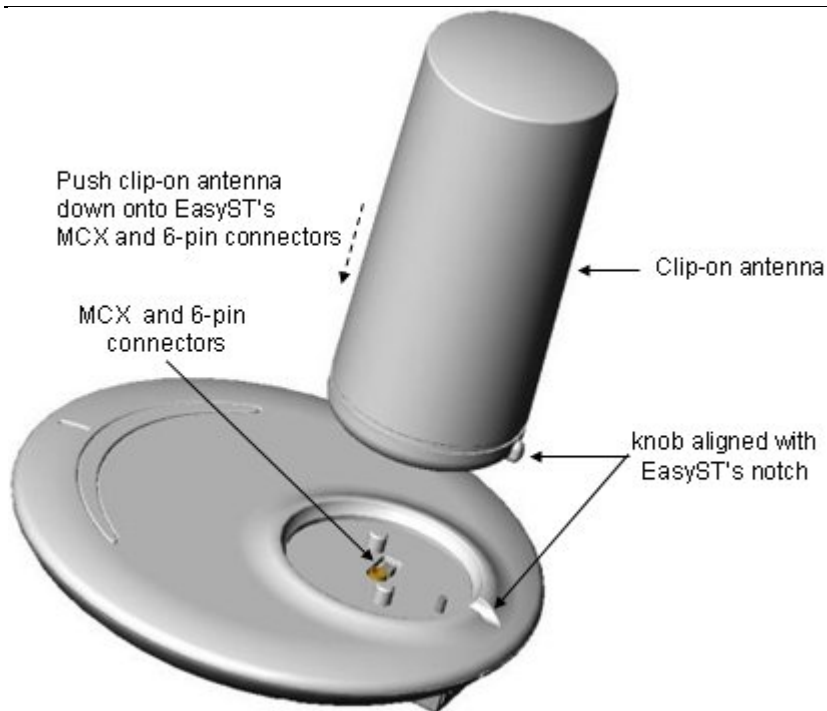

Figure 27 - clip-on antenna

4. Gently push the antenna down onto the EasyST so that the MCX and 6-pin connectors plug into their respective receptacles, and that the antenna's knob sits firmly into the EasyST's notch.



Figure 28 - antenna attached

5. For customers possessing EasyST models that implement a screw mechanism for securing the antenna to the EasyST, continue with the following steps:
 - a. Flip the EasyST over so that its rear panel is visible. Insert the M3 25-mm flat-head Philips screw (supplied) into the hole that's located on the rear panel, behind the RJ-45 and DC power connectors, as shown in the figure below.

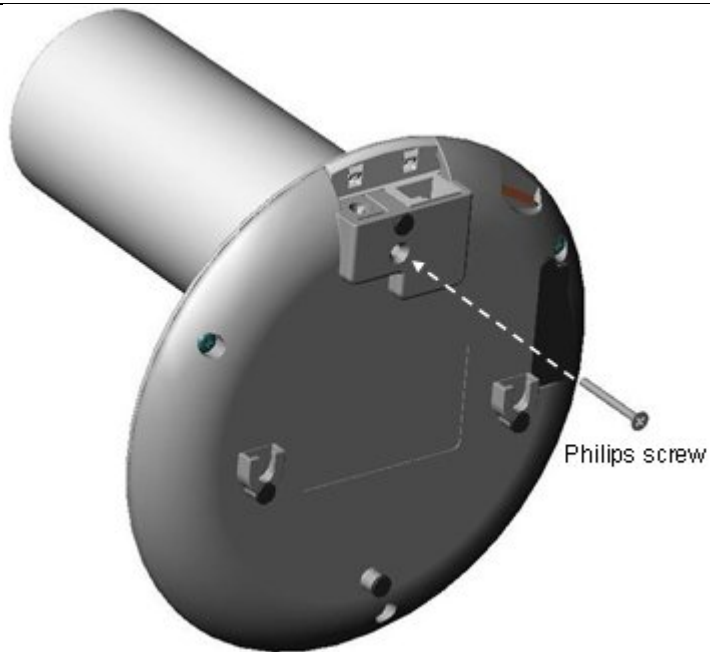

Figure 29 - insert screw

- b. Using a Philips screwdriver, tighten the screw so that the antenna is firmly attached to the EasyST.

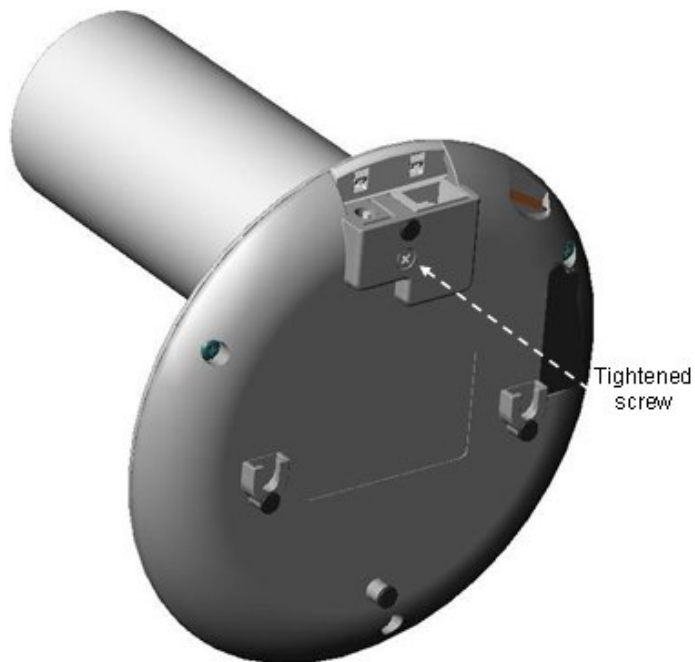

Figure 30 - tighten screw

10 EasyST Smart Card

The EasyST has an integrated Smart Card (SIM) terminal, which can utilize the optional EasyST Smart Card (sold separately). Contact your Airspan supplier for more information.

The EasyST is fully functional with or without the EasyST Smart Card.

When the EasyST Smart Card is inserted the EasyST uses the parameters set in the card (overriding the NVRAM parameter settings). Otherwise it uses the parameters set in the EasyST's NVRAM. Currently the Smart Cards are available from Airspan and are configured to your specific requirements.



Note: In the event the Smart Card is removed the EasyST continues to function using SIM parameters, until the next reset when it utilizes the default stored NVRAM settings.

The following defines the EasyST Smart Card stored parameters:

- **Operator ID** - defines the Operator ID by means of the BS ID and Mask in order to enforce the CPE to be associated to a specific BS or to a group of BSs. This prevents the CPE from connecting to other BS(s) that do not belong to this specific operator
- **RF Channel Scanning Table** - determines the channel scanning range, when there are RF channel shifts in the table. This is performed during network entry, to find the best RF channel with the best reception level
- **Maximum Tx Power** - defines the maximum Tx power, to meet the regulations of the region

11 Resetting EasyST to Default Settings

The EasyST allows you to apply factory default configuration settings to the EasyST. This is performed by pressing the **LED** button (located below the LED lights on the top panel) continuously for at least 10 seconds.

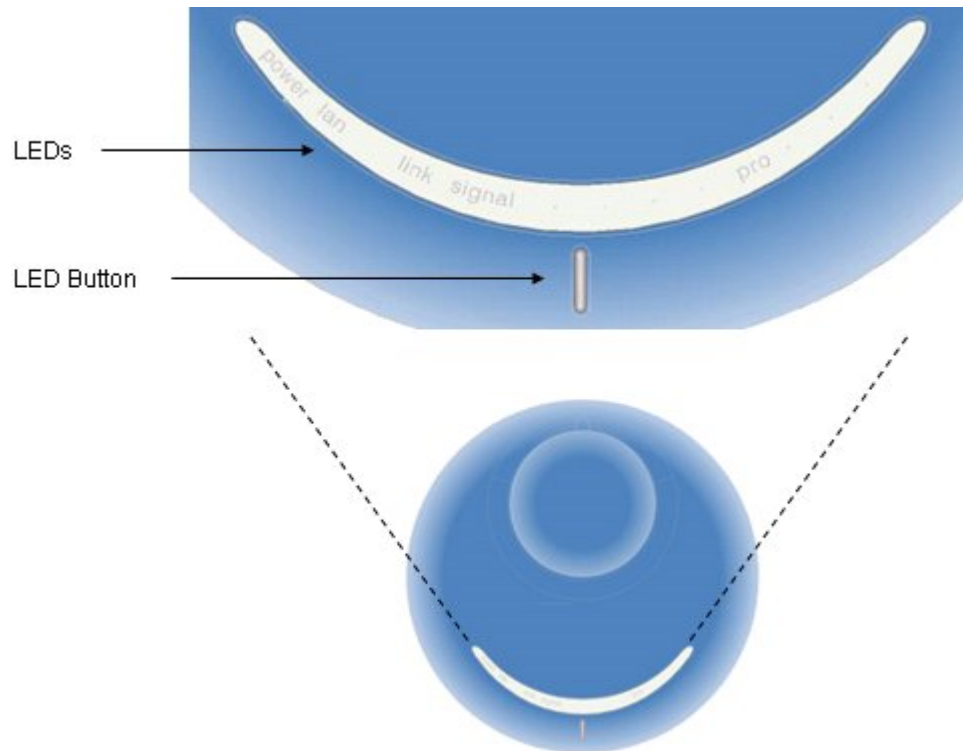

Figure 31 - Resetting EasyST



12 Troubleshooting

Once you have connected the EasyST to the subscriber's LAN and to the power supply, you can verify whether you have cabled the EasyST correctly by checking the EasyST LED status:

Table 12 – Troubleshooting

Connection	LED	Color	Correct Status	Troubleshooting
Power	power	Red	On	If the power LED is off, recheck the power cabling and that power exists at the wall socket.
LAN	lan	Green	On	If the lan LED is off, recheck the LAN cabling; ensure that you have connected it to the correct LAN port on your PC and that your network connection on your PC is enabled.



13 Appendix

13.1 Glossary of Terms

BS	Base Station
BWA	Broadband Wireless Access
CID	Connection IDs
CPE	Customer Premises Equipment (interchangeable with ST)
dB	Decibel
dBm	Power ratio in dB (decibel) of the measured power referenced to one milliwatt
DL	Downlink
FDD	Frequency Division Duplex
FEC	Forward Error Correction
GHz	Gigahertz
H-FDD	Half-Duplex FDD
IAD	Integrated Access Device
IP	Internet Protocol
ISP	Internet Service Provider
LAN	Local-Area Network
MAC	Media Access Controller. The next layer up from the PHY.
Mbit/s:	Megabits per second
MHz	Megahertz (one million cycles per second)
MIB	Management Information Base
NLOS	Non line-of-sight radio propagation path
NPI	New Product Introduction
ODU	Outdoor unit associated with an ST
OFDM	Orthogonal Frequency Division Multiplexing
PHY	The physical layer associated with the WiMAX interconnection stack
POTS	Plain Old Telephone Service
QAM	Quadrature Amplitude Modulation
QoS	Quality of Service, which is used to specify level of data throughput
QPSK	Quadrature Phase Shift Keying
RF	Radio Frequency
Rx	Receive
SF	Service Flow



SIM	Subscriber Identity Module
SNMP	Simple Network Management Protocol
SNR	Signal-to-Noise Ratio
ST	Subscriber Terminal (interchangeable with CPE or SS)
TDMA	Time Division Multiple Access. Technology for delivering digital wireless service using time-division multiplexing (TDM)
Tx	Transmit
UGS	Unsolicited Grant Service used to provide fixed bandwidth slots on the uplink for an ST to transmit data at regular intervals. The bandwidth should be used by the UGS SF, however the final decision of which SF (if any) uses the bandwidth slot is made by the ST.
VoIP	Voice over Internet Protocol
Wi-Fi	Wireless Fidelity
WiMAX	WiMAX is a wireless industry coalition whose members are organized to advance IEEE 802.16 standards for broadband wireless access (BWA) networks.

13.2 Revision History

Revision	Originator	Date	Description
01	M. Dubb	9-2005	Initial document
A	M. Falik	2-2006	Warning changed to 20 cm
B	M. Falik	3-006	Warning Removed
C	M. Falik	4-2006	FCC Statement & warning replaced
D	M. Falik	6-2006	Added SIM, additional information
E	M. Falik	7-2006	Standardize document
F	M. Falik	10-2006	Added tables
G	M. Falik	12-2006	Frequency additions
H	M. Falik	8-2007	Frequency additions + Max TX table
I	M. Falik	12-2007	Additions
J	M. Falik	12-2008	Template change & Frequency additions
K	M. Falik	2-2009	Frequency additions + corrections



13.3 Contact Information

Customer Service Help-Desk for customer service emergency

Airspan Networks have introduced the [Airspan Tracker](#) application to enable prompt and efficient Customer Support services.

If you do not have an Airspan Tracker account, please obtain login credentials by filling-in the form in the main page "[Register New Account](#)".

Worldwide Headquarters:

Airspan Networks Inc.
777, Yamato Road, Suite 310,
Boca Raton, FL 33431, USA
Tel: +1 561 893 8670

www.airspan.com

Feedback:

To provide feedback on this document, please send comments to the following email address:
www.airspan.com