



RF TEST REPORT

Applicant Airspan Networks Inc
FCC ID PIDAS61225
Product 999-03-723
Brand AirSpot 612
Model AirSpot 612 B41
Marketing My-Pro-ZM-B38-B41-C12
Report No. R1902A0054-R1V1
Issue Date April 2, 2019

TA Technology (Shanghai) Co., Ltd. tested the above equipment in accordance with the requirements in **FCC CFR47 Part 2 (2018)/ FCC CFR47 Part 27C (2018)**. The test results show that the equipment tested is capable of demonstrating compliance with the requirements as documented in this report.

Performed by: Peng Tao

Approved by: Kai Xu

TA Technology (Shanghai) Co., Ltd.

No.145, Jintang Rd, Tangzhen Industry Park, Pudong Shanghai, China

TEL: +86-021-50791141/2/3

FAX: +86-021-50791141/2/3-8000

Table of Contents

1	Test Laboratory	4
1.1	Notes of the Test Report	4
1.2	Test facility	4
1.3	Testing Location	5
2	General Description of Equipment under Test	6
3	Applied Standards	7
4	Test Configuration	8
5	Test Case Results	9
5.1	RF Power Output	9
5.2	Effective Isotropic Radiated Power	12
5.3	Occupied Bandwidth	16
5.4	Band Edge Compliance	22
5.5	Peak-to-Average Power Ratio (PAPR)	30
5.6	Frequency Stability.....	32
5.7	Spurious Emissions at Antenna Terminals	34
5.8	Radiates Spurious Emission	41
6	Main Test Instruments	46
ANNEX A: EUT Appearance and Test Setup		47
A.1	EUT Appearance	47
A.2	Test Setup	49

Summary of Measurement Results

Number	Test Case	Clause in FCC rules	Verdict
1	RF power output	2.1046	PASS
2	Effective Isotropic Radiated power	27.50(h)(2)	PASS
3	Occupied Bandwidth	2.1049	PASS
4	Band Edge Compliance	27.53(m)	PASS
5	Peak-to-Average Power Ratio	27.50(d)/KDB971168 D01(5.7)	PASS
6	Frequency Stability	2.1055 / 27.54	PASS
7	Spurious Emissions at Antenna Terminals	2.1051 /27.53(m)	PASS
8	Radiates Spurious Emission	27.53(m)	PASS
Date of Testing: February 26, 2019 ~ March 13, 2019			
Note: PASS: The EUT complies with the essential requirements in the standard. FAIL: The EUT does not comply with the essential requirements in the standard.			

1 Test Laboratory

1.1 Notes of the Test Report

This report shall not be reproduced in full or partial, without the written approval of **TA technology (shanghai) co., Ltd.** The results documented in this report apply only to the tested sample, under the conditions and modes of operation as described herein .Measurement Uncertainties were not taken into account and are published for informational purposes only. This report is written to support regulatory compliance of the applicable standards stated above.

1.2 Test facility

CNAS (accreditation number: L2264)

TA Technology (Shanghai) Co., Ltd. has obtained the accreditation of China National Accreditation Service for Conformity Assessment (CNAS).

FCC (Designation number: CN1179, Test Firm Registration Number: 446626)

TA Technology (Shanghai) Co., Ltd. has been listed on the US Federal Communications Commission list of test facilities recognized to perform electromagnetic emissions measurements.

IC (recognition number is 8510A)

TA Technology (Shanghai) Co., Ltd. has been listed by industry Canada to perform electromagnetic emission measurement.

VCCI (recognition number is C-4595, T-2154, R-4113, G-10766)

TA Technology (Shanghai) Co., Ltd. has been listed by industry Japan to perform electromagnetic emission measurement.

A2LA (Certificate Number: 3857.01)

TA Technology (Shanghai) Co., Ltd. has been listed by American Association for Laboratory Accreditation to perform electromagnetic emission measurement.

1.3 Testing Location

Company: TA Technology (Shanghai) Co., Ltd.
Address: No.145, Jintang Rd, Tangzhen Industry Park, Pudong Shanghai, China
City: Shanghai
Post code: 201201
Country: P. R. China
Contact: Xu Kai
Telephone: +86-021-50791141/2/3
Fax: +86-021-50791141/2/3-8000
Website: <http://www.ta-shanghai.com>
E-mail: xukai@ta-shanghai.com

2 General Description of Equipment under Test

Client Information

Applicant	Airspan Networks Inc
Applicant address	777 Yamato Rd Suite 310, Florida ,United States
Manufacturer	Airspan Networks Inc
Manufacturer address	777 Yamato Rd Suite 310, Florida ,United States

General information

EUT Description			
Model	AirSpot 612 B41		
IMEI	860524031813619		
Hardware Version	V2.0		
Software Version	MG12_0.3.2.20_V1.1-STD		
Power Supply	AC adapter		
Antenna Type	Fixed Internal Antenna		
Antenna Gain	11dBi		
Test Mode(s)	LTE Band 41		
Test Modulation	(LTE)QPSK 16QAM;		
LTE Category	13		
Maximum E.I.R.P.	LTE Band 41:	32.43dBm	
Rated Power Supply Voltage:	24V		
Extreme Voltage	Minimum: 20V Maximum: 28V		
Extreme Temperature	Lowest: -30°C Highest: +55°C		
Operating Frequency Range(s)	Mode	Tx (MHz)	Rx (MHz)
	LTE Band 41	2496 ~ 2690	2496 ~ 2690
EUT Accessory			
Adapter	Manufacturer: Aquilstar Precision Industry (Shenzhen) Co., Ltd. Model: ASSA107E-240050		
Note: 1. The information of the EUT is declared by the manufacturer.			

3 Applied Standards

According to the specifications of the manufacturer, it must comply with the requirements of the following standards:

Test standards

FCC CFR47 Part 2 (2018)

FCC CFR47 Part 27C (2018)

ANSI C63.26 (2015)

KDB 971168 D01 Power Meas License Digital Systems v03r01

4 Test Configuration

Radiated measurements are performed by rotating the EUT in three different orthogonal test planes. EUT stand-up position (Z axis), lie-down position (X, Y axis). Receiver antenna polarization (horizontal and vertical), the worst emission was found in position (X axis, vertical polarization) and the worst case was recorded.

All mode and data rates and positions and RB size and modulations were investigated.

Subsequently, only the worst case emissions are reported.

The following testing in LTE is set based on the maximum RF Output Power.

The following testing in different Bandwidth is set to detail in the following table:

Test modes are chosen to be reported as the worst case configuration below for LTE Band 41:

Test items	Modes	Bandwidth (MHz)						Modulation		RB			Test Channel			
		1.4	3	5	10	15	20	QPSK	16QAM	1	50%	100%	L	M	H	
RF power output	LTE 41	-	-	0	0	0	0	0	0	0	0	0	0	0	0	0
Effective Isotropic Radiated power	LTE 41	-	-	0	0	0	0	0	0	0	0	0	0	0	0	0
Occupied Bandwidth	LTE 41	-	-	0	0	0	0	0	0	-	-	0	0	0	0	0
Band Edge Compliance	LTE 41	-	-	0	0	0	0	0	0	0	-	0	0	-	0	0
Peak-to-Average Power Ratio	LTE 41	-	-	0	0	0	0	0	0	-	-	0	0	0	0	0
Frequency Stability	LTE 41	-	-	0	0	0	0	0	0	0	0	0	0	0	0	0
Spurious Emissions at Antenna Terminals	LTE 41	-	-	0	0	0	0	0	-	0	-	-	0	0	0	0
Radiates Spurious Emission	LTE 41	-	-	-	-	-	0	0	-	0	-	-	0	0	0	0

Note: 1. The mark "O" means that this configuration is chosen for testing.

2. The mark "-" means that this configuration is not testing.

5 Test Case Results

5.1 RF Power Output

Ambient condition

Temperature	Relative humidity	Pressure
23°C ~25°C	45%~50%	101.5kPa

Methods of Measurement

During the process of the testing, The EUT is controlled by the Base Station Simulator to ensure max power transmission and proper modulation.

Test Setup

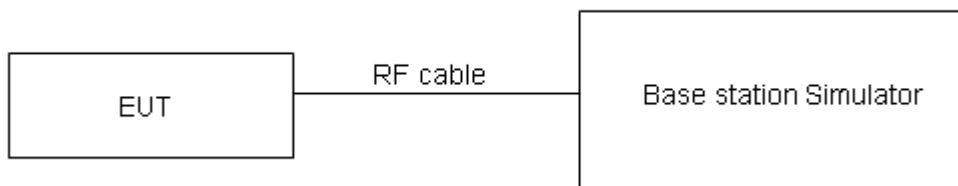

The loss between RF output port of the EUT and the input port of the tester has been taken into consideration.

Limits

No specific RF power output requirements in part 2.1046.

Measurement Uncertainty

The assessed measurement uncertainty to ensure 95% confidence level for the normal distribution is with the coverage factor $k = 2$, $U=0.4$ dB.

Test Results

LTE Band 41				AV Conducted Power(dBm)		
Bandwidth	Modulation	RB size	RB offset	Channel/Frequency (MHz)		
				39675/2498.5	40620/2593	41565/2687.5
5MHz	QPSK	1	0	21.87	23.18	22.47
		1	13	21.81	22.72	22.59
		1	24	23.28	23.21	23.51
		12	0	20.59	21.57	21.09
		12	6	21.24	21.61	21.49
		12	13	21.32	21.59	21.62
		25	0	20.89	21.66	21.30
	16QAM	1	0	20.96	21.99	21.68
		1	13	20.84	21.62	21.72
		1	24	22.40	22.09	22.62
		12	0	19.47	20.45	20.14
		12	6	20.12	20.42	20.50
		12	13	20.15	20.49	20.52
		25	0	19.78	20.18	20.24
Bandwidth	Modulation	RB size	RB offset	Channel/Frequency (MHz)		
				39700/2501	40620/2593	41540/2685
10MHz	QPSK	1	0	21.89	23.19	22.50
		1	25	21.84	22.77	22.63
		1	49	23.30	23.25	23.54
		25	0	20.62	21.62	21.13
		25	13	21.27	21.66	21.53
		25	25	21.34	21.63	21.67
		50	0	20.97	21.68	21.34
	16QAM	1	0	20.98	22.02	21.70
		1	25	20.87	21.66	21.75
		1	49	22.43	22.11	22.65
		25	0	19.50	20.50	20.18
		25	13	20.14	20.46	20.53
		25	25	20.16	20.54	20.56
		50	0	19.81	20.23	20.28
Bandwidth	Modulation	RB size	RB offset	Channel/Frequency (MHz)		
				39725/2503.5	40620/2593	41515/2682.5
15MHz	QPSK	1	0	21.88	23.15	22.48
		1	38	21.82	22.76	22.60
		1	74	23.27	23.20	23.50



		36	0	20.60	21.58	21.10
		36	18	21.24	21.61	21.49
		36	39	21.31	21.60	21.63
		75	0	20.95	21.64	21.29
	16QAM	1	0	20.93	22.00	21.68
		1	38	20.85	21.63	21.73
		1	74	22.40	22.07	22.62
		36	0	19.47	20.48	20.15
		36	18	20.11	20.41	20.49
		36	39	20.16	20.50	20.53
		75	0	19.78	20.18	20.24
	Bandwidth	Modulation	RB size	RB offset	Channel/Frequency (MHz)	
39750/2506					40620/2593	41490/2680
20MHz	QPSK	1	0	21.85	23.11	22.45
		1	50	21.81	22.72	22.58
		1	99	23.25	23.19	23.47
		50	0	20.57	21.53	21.06
		50	25	21.22	21.57	21.46
		50	50	21.28	21.55	21.59
		100	0	20.92	21.59	21.25
	16QAM	1	0	20.91	21.96	21.63
		1	50	20.81	21.61	21.69
		1	99	22.38	22.04	22.60
		50	0	19.44	20.44	20.12
		50	25	20.08	20.39	20.46
		50	50	20.13	20.45	20.49
		100	0	19.76	20.14	20.21

5.2 Effective Isotropic Radiated Power

Ambient condition

Temperature	Relative humidity	Pressure
23°C ~25°C	45%~50%	101.5kPa

Methods of Measurement

1. The testing follows FCC KDB 971168 D01 v03r01 Section 5.8 and ANSI C63.26 (2015).

- a) Connect the equipment as illustrated. Mount the equipment with the manufacturer specified antenna in a vertical orientation on a manufacturer specified mounting surface located on a non-conducting rotating platform of a RF anechoic chamber (preferred) or a standard radiation site.
- b) Key the transmitter, then rotate the EUT 360° azimuthally and record spectrum analyzer power level (LVL) measurements at angular increments that are sufficiently small to permit resolution of all peaks. If a standard radiation test site is used, raise and lower the test antenna to obtain a maximum reading at each angular increment. (Note: several batteries may be needed to offset the effect of battery voltage droop, which should not exceed 5% of the manufactured specified battery voltage during transmission).
- c) Replace the transmitter under test with a vertically polarized half-wave dipole (or an antenna whose gain is known relative to an ideal half-wave dipole). The center of the antenna should be at the same location as the center of the antenna under test.
- d) Connect the antenna to a signal generator with a known output power and record the path loss (in dB) as LOSS. If a standard radiation test site is used, raise and lower the test antenna to obtain a maximum reading. $LOSS = \text{Generator Output Power (dBm)} - \text{Analyzer reading (dBm)}$
- e) Determine the effective radiated output power at each angular position from the readings in steps b) and d) using the following equation: $ERP \text{ (dBm)} = LVL \text{ (dBm)} + LOSS \text{ (dB)}$
- f) The maximum ERP is the maximum value determined in the preceding step.
- g) When calculating ERP, in addition to knowing the antenna radiation and matching characteristics, it is necessary to know the loss values of all elements (e.g. transmission line attenuation, mismatches, filters, combiners) interposed between the point where transmitter output power is measured, and the point where power is applied to the antenna. ERP can then be calculated as follows:
 $EIRP \text{ (dBm)} = \text{Output Power (dBm)} - \text{Losses (dB)} + \text{Antenna Gain (dBi)}$
 where: dBd refers to gain relative to an ideal dipole.
 $EIRP \text{ (dBm)} = ERP \text{ (dBm)} + 2.15 \text{ (dB.)}$

The RB allocation refers to section 5.1, using the maximum output power configuration.

Test setup

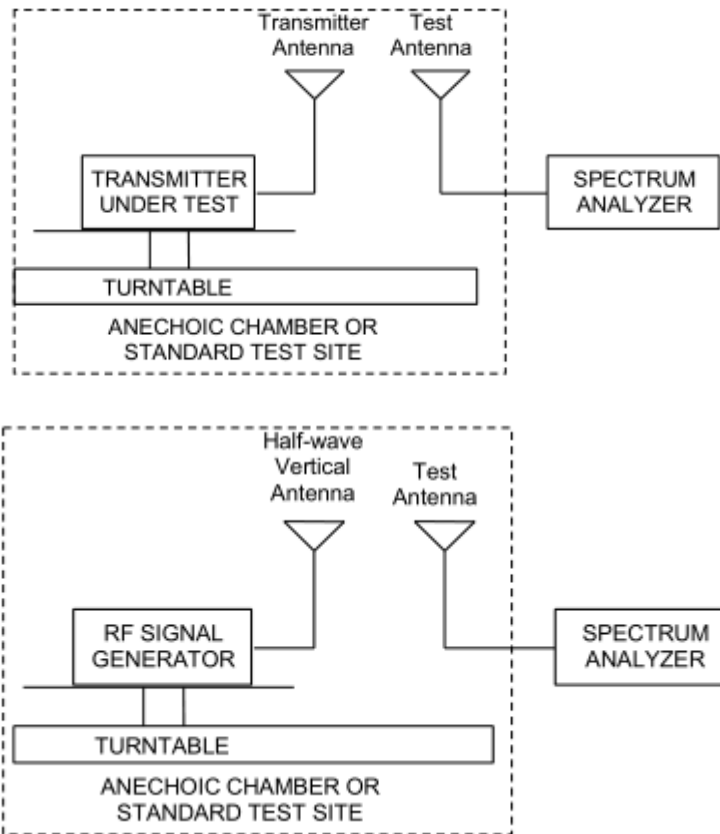

Note: Area side:2.4mX3.6m

The radiated emission was measured in the following position: EUT stand-up position (Z axis), lie-down position (X, Y axis). The worst emission was found in stand-up position (Z axis) and the worst case was recorded.

**Limits**

Rule Part 27.50(h) (2) specifies that “Mobile and other user stations. Mobile stations are limited to 2.0 watts EIRP. All user stations are limited to 2.0 watts transmitter output power.”

Part 27.50(h)(2) Limit	$\leq 2 \text{ W}$ (33 dBm)
------------------------	-----------------------------

Measurement Uncertainty

The assessed measurement uncertainty to ensure 95% confidence level for the normal distribution is with the coverage factor $k = 2$, $U = 1.19 \text{ dB}$

Test Results

The measurement is performed for both of horizontal and vertical antenna Polarization, and only the data of worst mode is recorded in this report.

LTE Band 41						
Band width	Channel	Frequency (MHz)	Polarization	EIRP (dBm)	Limit (dBm)	Conclusion
5 MHz (QPSK)	Low	2498.5	Vertical	31.46	33	Pass
	Mid	2593	Vertical	32.00	33	Pass
	High	2687.5	Vertical	31.87	33	Pass
10 MHz (QPSK)	Low	2501	Vertical	31.99	33	Pass
	Mid	2593	Vertical	32.12	33	Pass
	High	2685	Vertical	31.67	33	Pass
15 MHz (QPSK)	Low	2503.5	Vertical	32.01	33	Pass
	Mid	2593	Vertical	32.25	33	Pass
	High	2682.5	Vertical	31.98	33	Pass
20 MHz (QPSK)	Low	2506	Vertical	32.11	33	Pass
	Mid	2593	Vertical	32.43	33	Pass
	High	2680	Vertical	31.77	33	Pass
5 MHz (16QAM)	Low	2498.5	Vertical	31.03	33	Pass
	Mid	2593	Vertical	31.48	33	Pass
	High	2687.5	Vertical	31.44	33	Pass
10 MHz (16QAM)	Low	2501	Vertical	31.56	33	Pass
	Mid	2593	Vertical	31.69	33	Pass
	High	2685	Vertical	31.13	33	Pass
15 MHz (16QAM)	Low	2503.5	Vertical	31.68	33	Pass
	Mid	2593	Vertical	31.76	33	Pass
	High	2682.5	Vertical	31.63	33	Pass
20 MHz (16QAM)	Low	2506	Vertical	31.58	33	Pass
	Mid	2593	Vertical	31.95	33	Pass
	High	2680	Vertical	31.23	33	Pass

5.3 Occupied Bandwidth

Ambient condition

Temperature	Relative humidity	Pressure
23°C ~25°C	45%~50%	101.5kPa

Method of Measurement

The EUT was connected to Spectrum Analyzer and Base Station Simulator via power Splitter. The occupied bandwidth is measured using spectrum analyzer.

RBW is set to 100 kHz, VBW is set to 300 kHz for LTE Band 41 (5MHz).

RBW is set to 300 kHz, VBW is set to 1MHz for LTE Band 41 (10MHz/15MHz/20MHz).

99% power and -26dBc occupied bandwidths are recorded. Spectrum analyzer plots are included on the following pages.

Test Setup

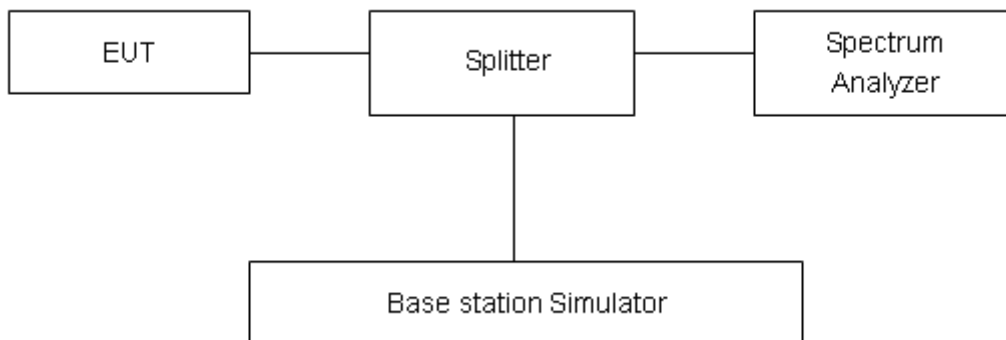

Limits

No specific occupied bandwidth requirements in part 2.1049.

Measurement Uncertainty

The assessed measurement uncertainty to ensure 95% confidence level for the normal distribution is with the coverage factor $k = 2$, $U=624\text{Hz}$.

Test Result

LTE Band 41						
RB	Modulation	Bandwidth (MHz)	Channel	Frequency (MHz)	99% Power Bandwidth(MHz)	-26dBc Bandwidth(MHz)
100%	QPSK	5	39675	2498.5	4.5460	5.414
			40620	2593	4.5423	5.342
			41565	2687.5	4.5390	5.295
		10	39700	2501	9.0578	10.150
			40620	2593	9.0677	10.180
			41540	2685	9.0606	10.310
		15	39725	2503.5	13.4630	14.580
			40620	2593	13.5070	14.680
			41515	2682.5	13.5110	14.580
		20	39750	2506	17.9070	19.180
			40620	2593	17.9300	19.070
			41490	2680	17.8850	19.130
	16QAM	5	39675	2498.5	4.5341	5.315
			40620	2593	4.5166	5.308
			41565	2687.5	4.5102	5.268
		10	39700	2501	9.0485	10.090
			40620	2593	9.0275	10.090
			41540	2685	9.0681	10.210
		15	39725	2503.5	13.4560	14.630
			40620	2593	13.5090	14.630
			41515	2682.5	13.5080	14.760
		20	39750	2506	17.8780	19.060
			40620	2593	17.9150	19.030
			41490	2680	17.9450	19.090

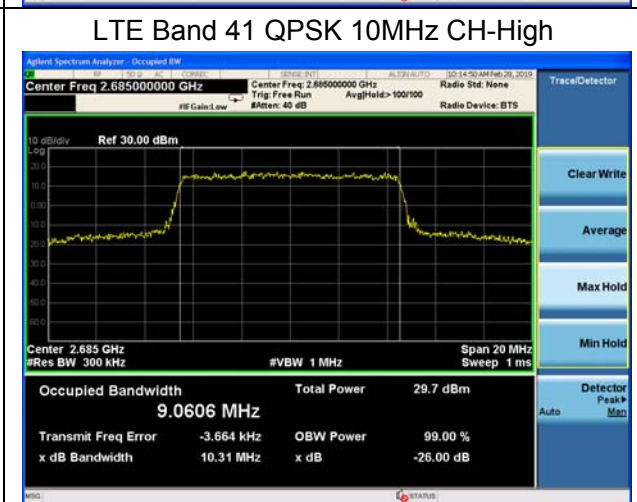
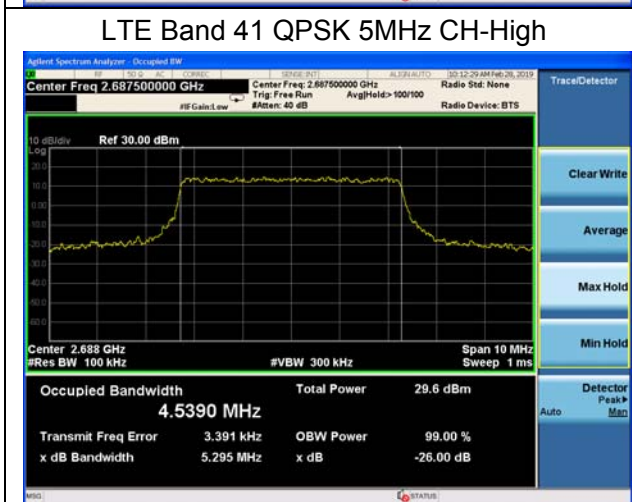
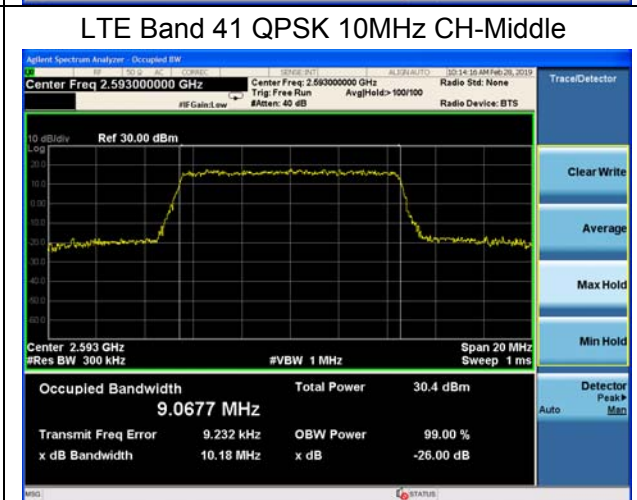
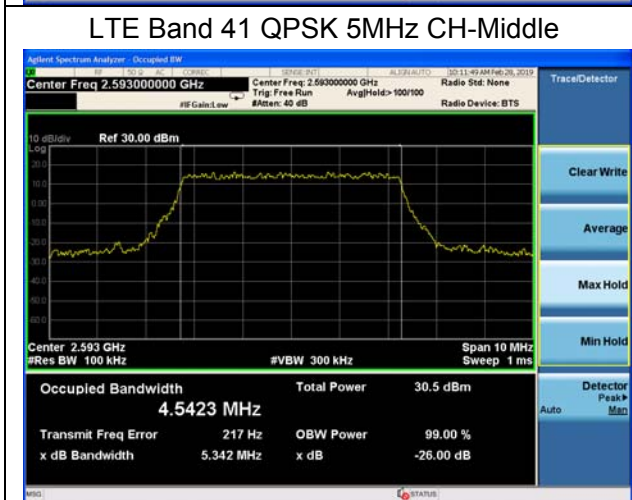
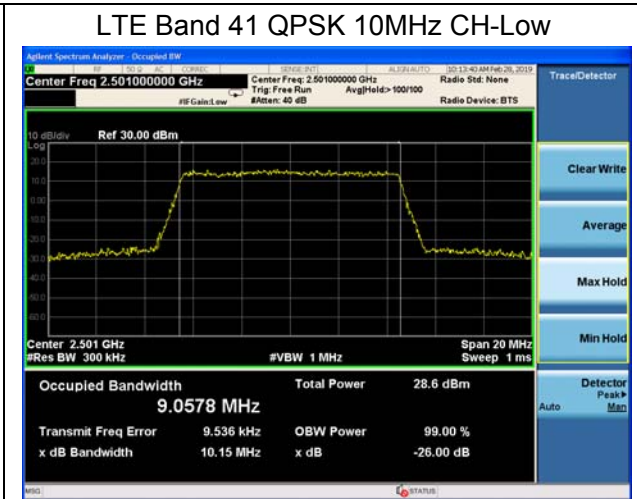
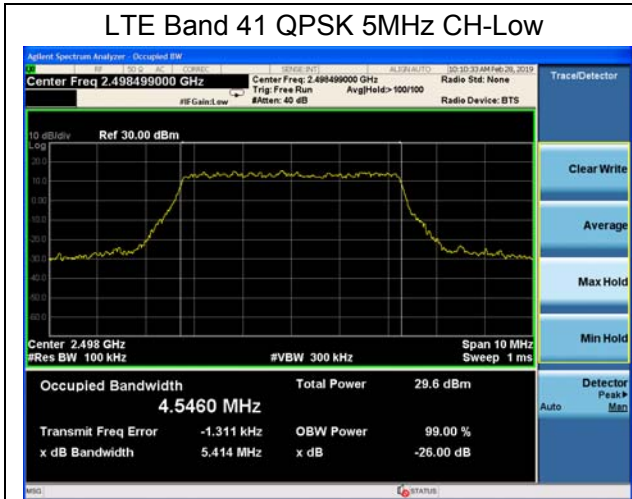

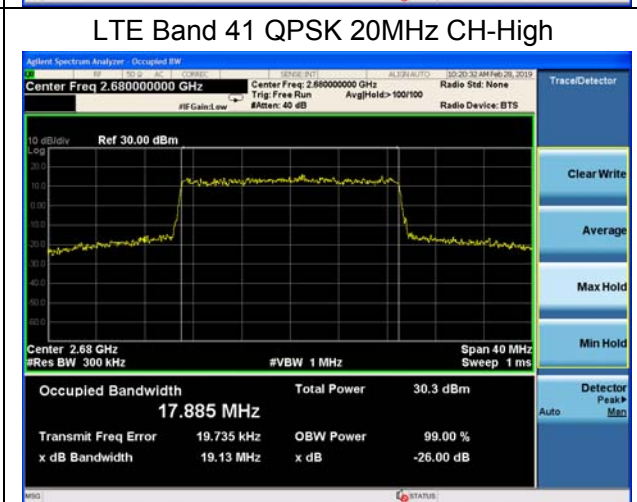
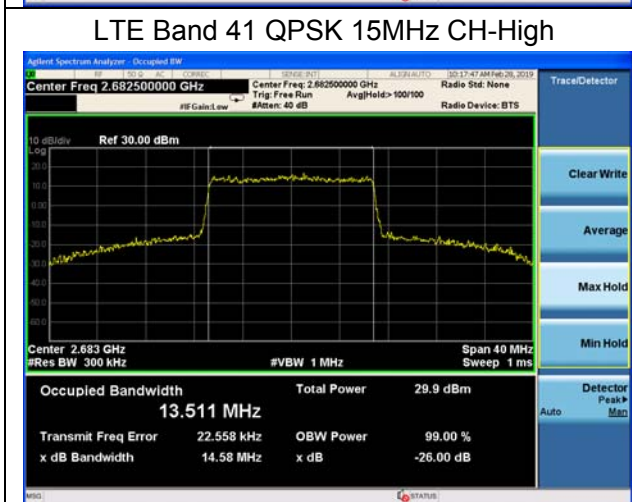
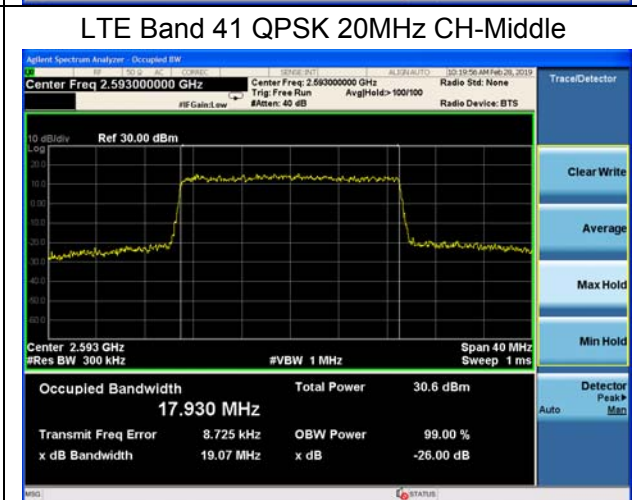
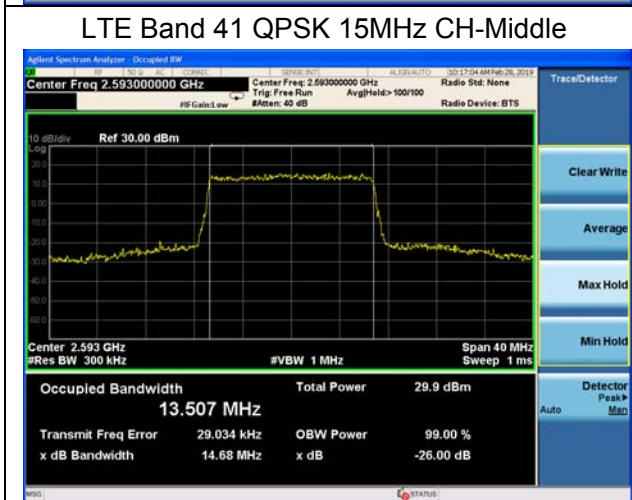
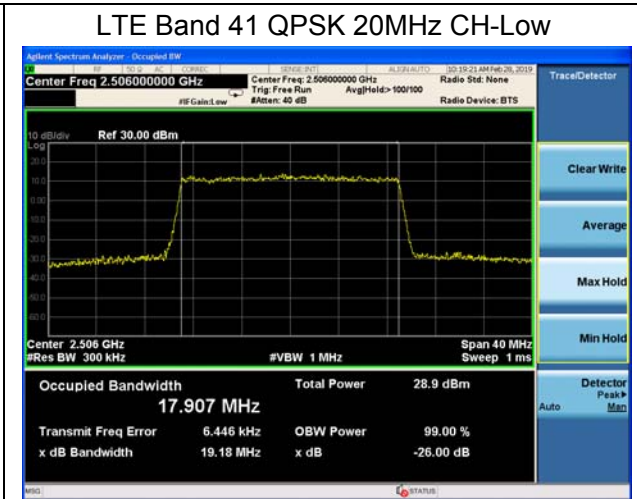
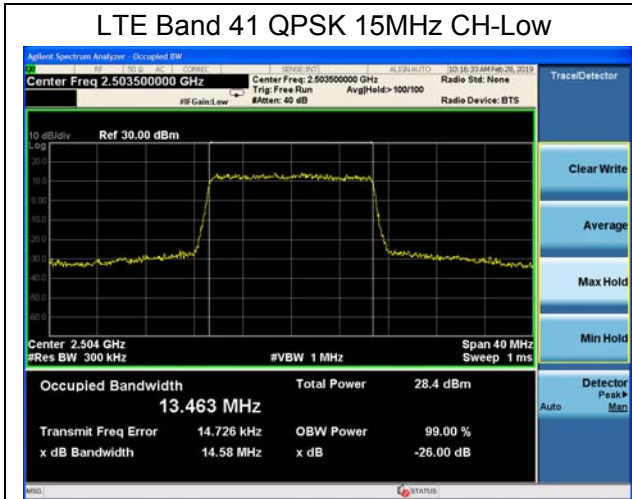

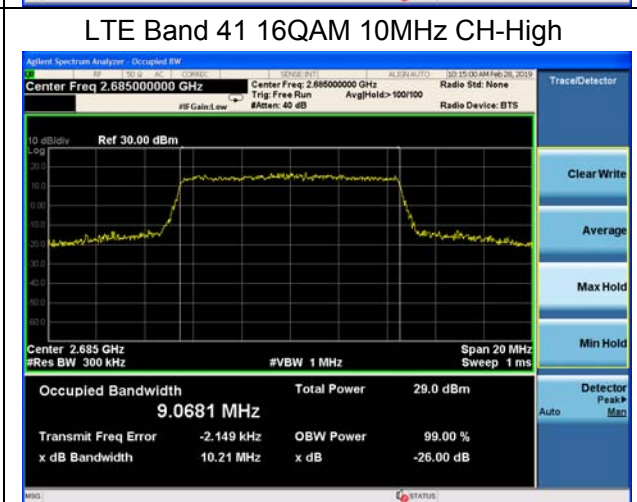
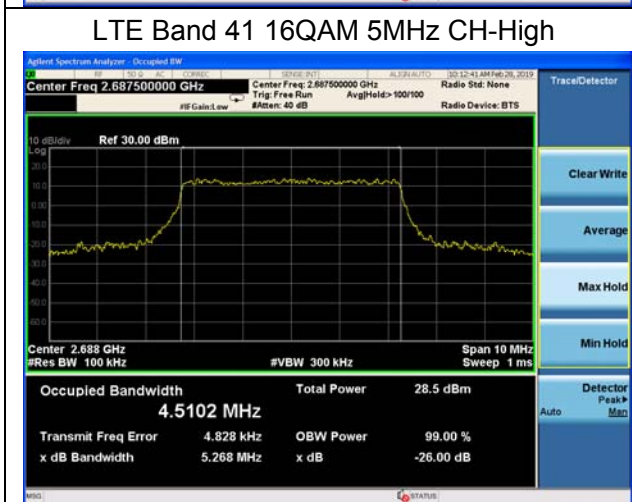
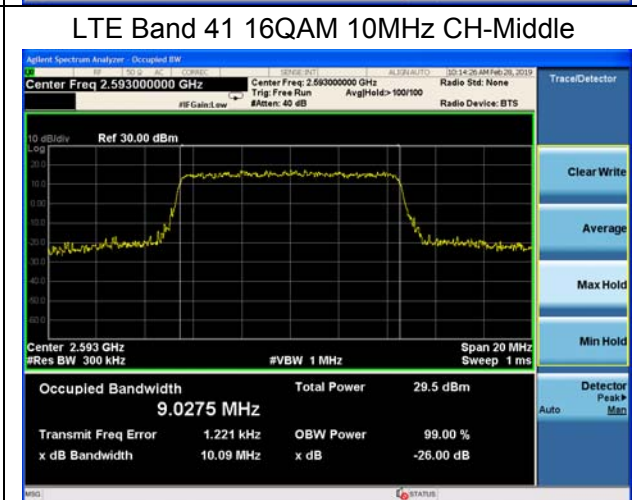
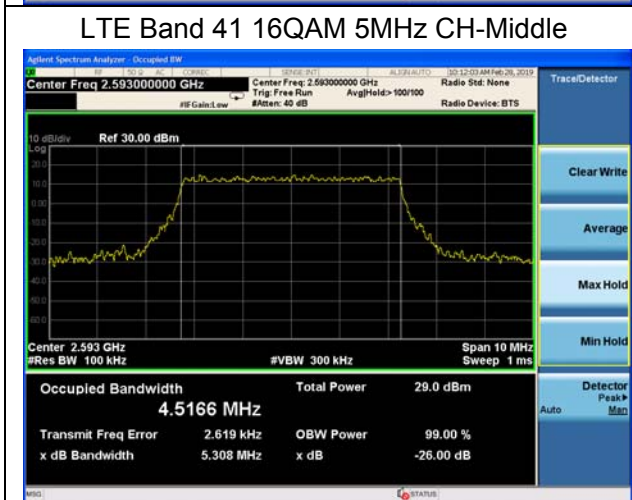
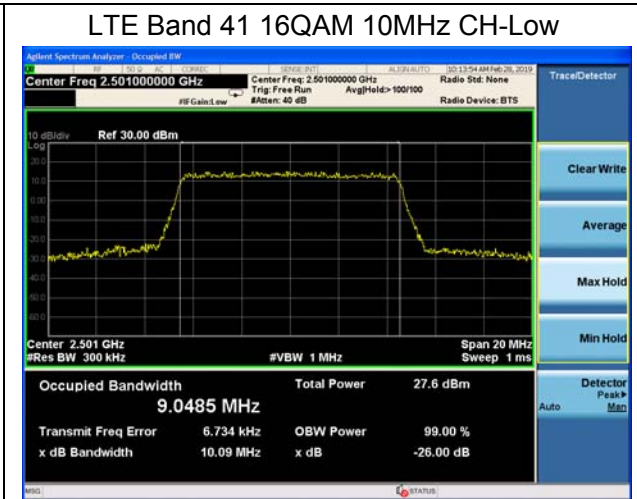
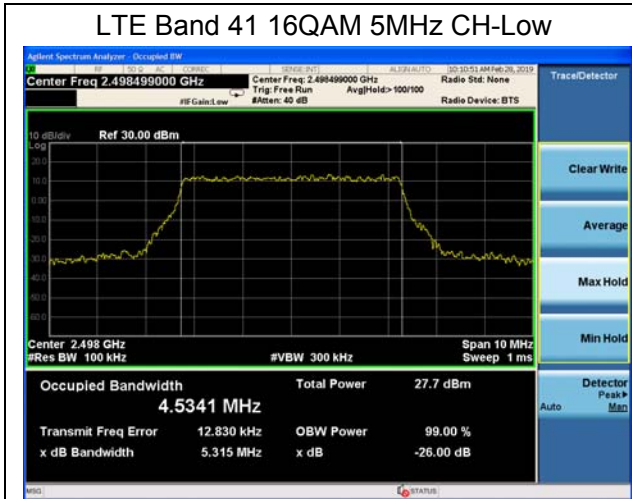

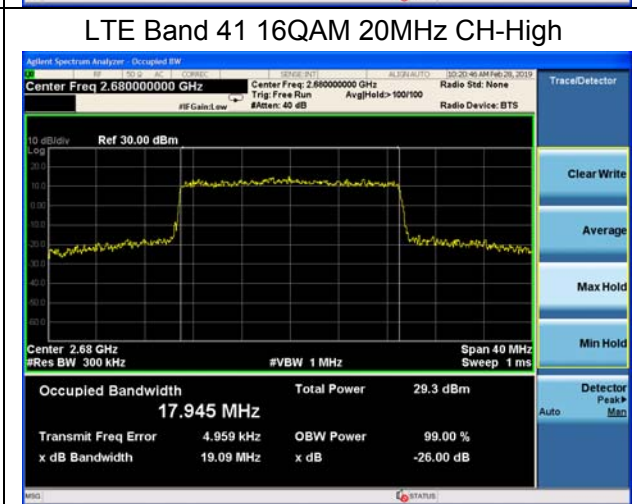
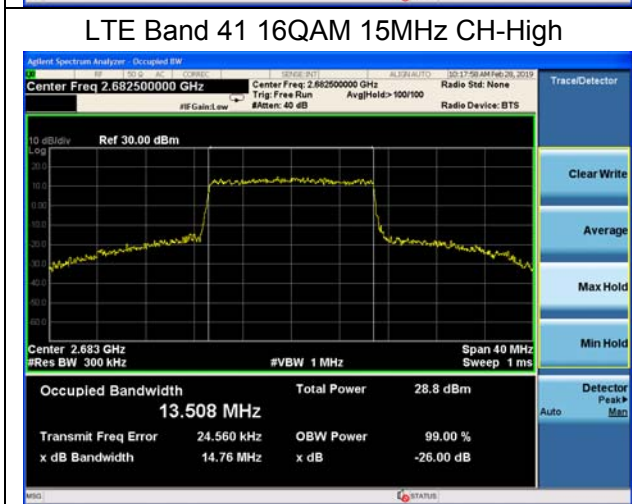
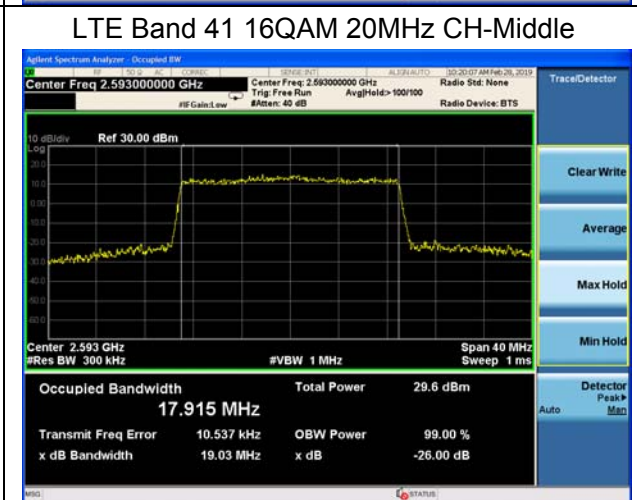
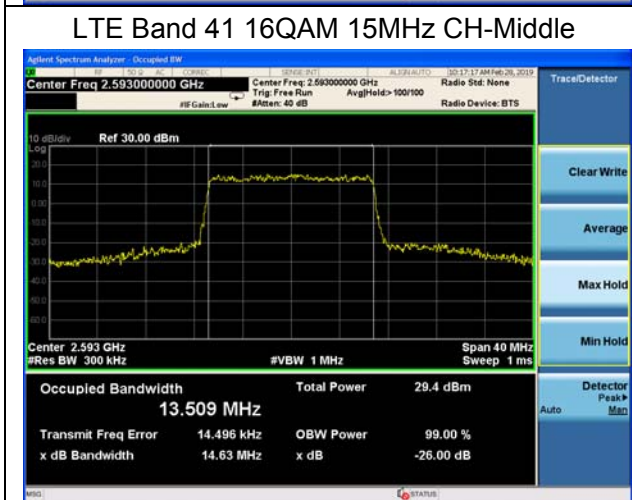
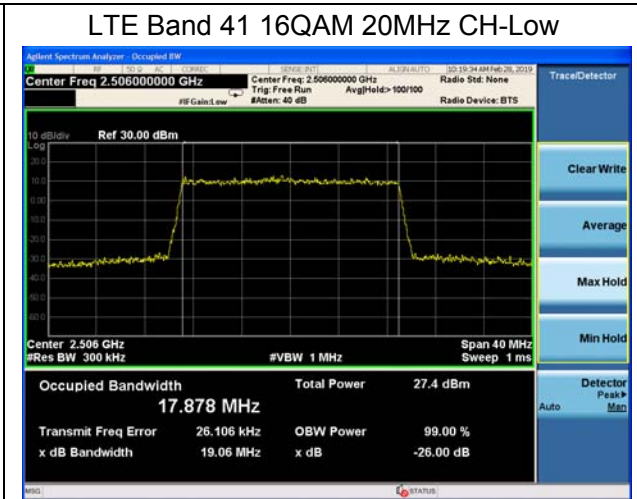
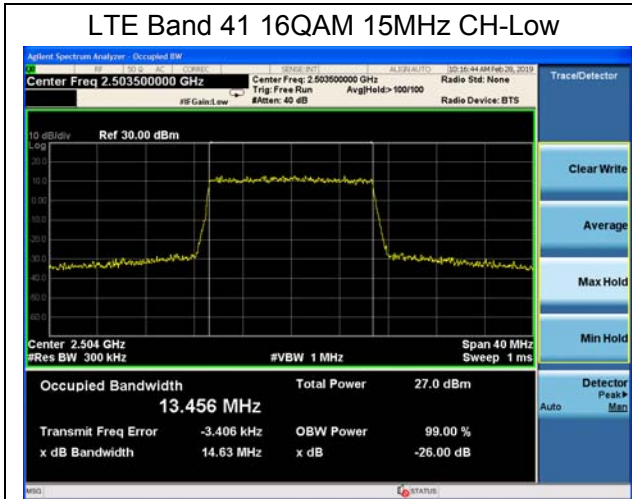

5.4 Band Edge Compliance

Ambient condition

Temperature	Relative humidity	Pressure
23°C ~25°C	45%~50%	101.5kPa

Method of Measurement

The EUT was connected to Spectrum Analyzer and Base Station Simulator via power Splitter. The band edge of the lowest and highest channels were measured.

The testing follows KDB 971168 D01 v03r01 Section 6.0

1. The EUT was connected to spectrum analyzer and system simulator via a power divider.
2. The band edges of low and high channels for the highest RF powers were measured.
3. For LTE Band 41 Set RBW \geq 1% EBW in the 1MHz band immediately outside and adjacent to the band edge. Beyond the 1 MHz band from the band edge, RBW=1MHz was used. on spectrum analyzer.
4. Set spectrum analyzer with RMS detector.
5. The RF fundamental frequency should be excluded against the limit line in the operating frequency band.
6. Checked that all the results comply with the emission limit line.

Test Setup

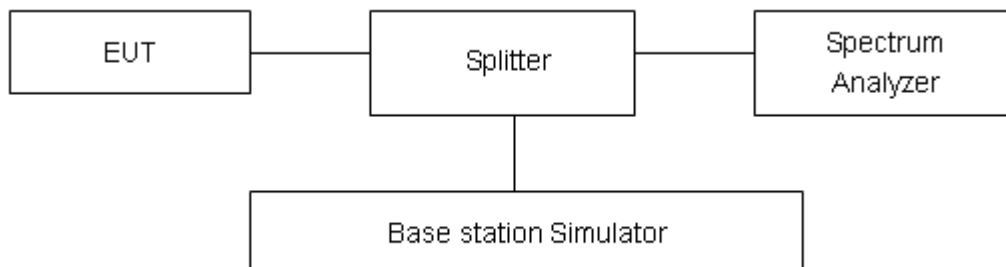

Limits

Rule Part 27.53(m) (4) specifies that “for BRS and EBS stations. For mobile digital stations, the attenuation factor shall be not less than $40 + 10 \log (P)$ dB on all frequencies between the channel edge and 5 megahertz from the channel edge, $43 + 10 \log (P)$ dB on all frequencies between 5 megahertz and X megahertz from the channel edge, and $55 + 10 \log (P)$ dB on all frequencies more than X megahertz from the channel edge, where X is the greater of 6 megahertz or the actual emission bandwidth as defined in paragraph (m)(4) of this section. In addition, the attenuation factor shall not be less that $43 + 10 \log (P)$ dB on all frequencies between 2490.5 MHz and 2496 MHz and $55 + 10 \log (P)$ dB at or below 2490.5 MHz. Mobile Satellite Service licensees operating on



frequencies below 2495 MHz may also submit a documented interference complaint against BRS licensees operating on channel BRS Channel 1 on the same terms and conditions as adjacent channel BRS or EBS licensees.

Example:

The limit line is derived from $43 + 10\log(P)$ dB below the transmitter power P (Watts)

= $P(W) - [43 + 10\log(P)]$ (dB)

= $[30 + 10\log(P)]$ (dBm) - $[43 + 10\log(P)]$ (dB) = -13dBm.

Measurement Uncertainty

The assessed measurement uncertainty to ensure 95% confidence level for the normal distribution is with the coverage factor $k = 1.96$, $U=0.684$ dB.



Test Result

All the test traces in the plots shows the test results clearly.

LTE Band 41 QPSK 5MHz CH-Low, 1 RB

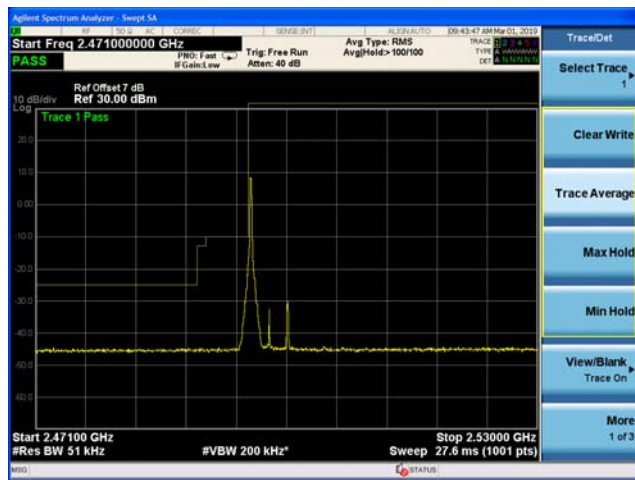

LTE Band 41 QPSK 5MHz CH-High, 1 RB

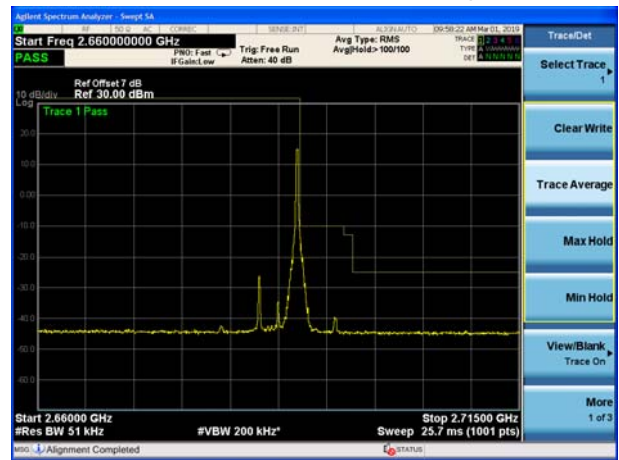

LTE Band 41 QPSK 5MHz CH-Low, 100%RB

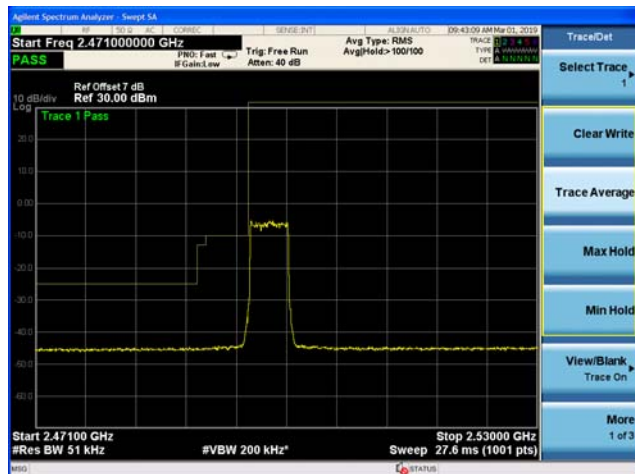

LTE Band 41 QPSK 5MHz CH-High, 100%RB

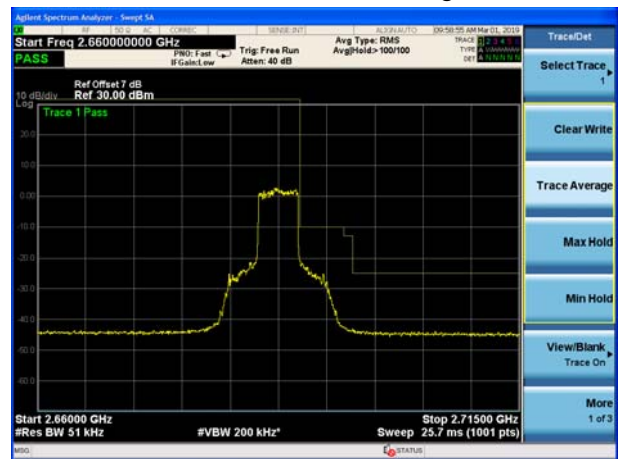

LTE Band 41 QPSK 10MHz CH-Low, 1 RB

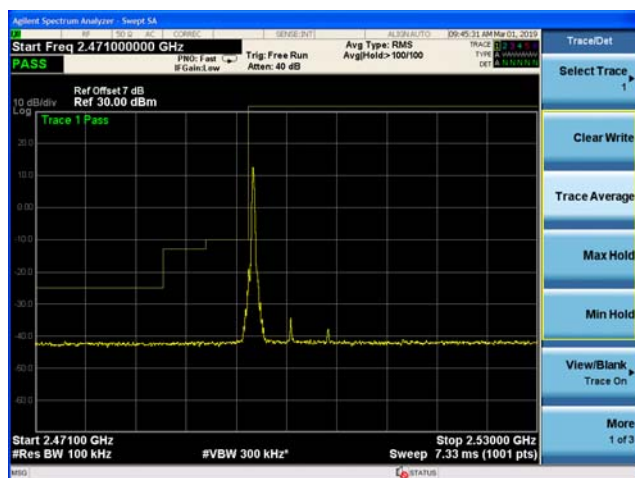

LTE Band 41 QPSK 10MHz CH-High, 1 RB

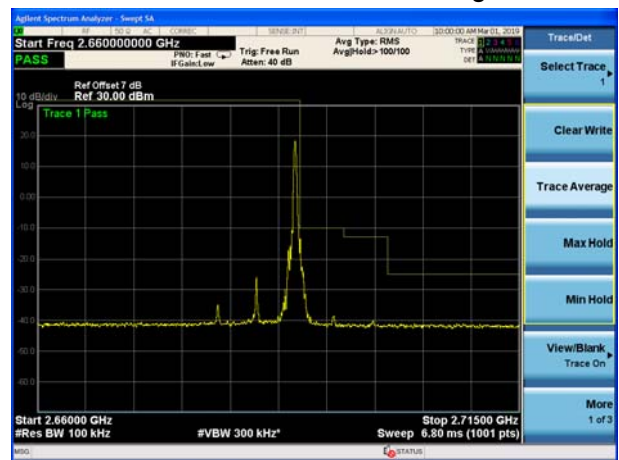



LTE Band 41 QPSK 10MHz CH-Low, 100%RB



LTE Band 41 QPSK 10MHz CH-High, 100%RB



LTE Band 41 QPSK 15MHz CH-Low, 1 RB

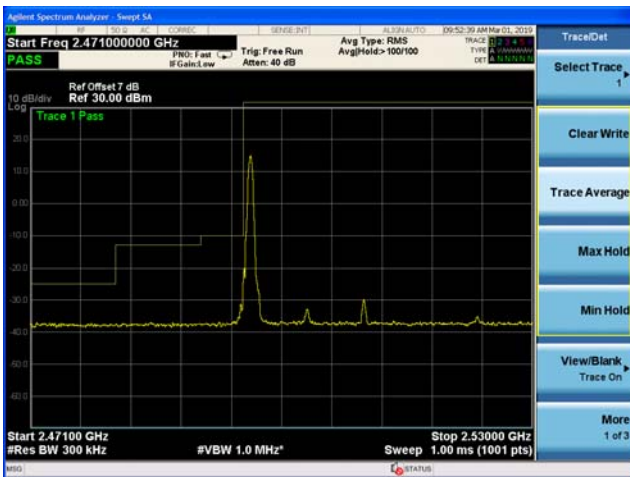

LTE Band 41 QPSK 15MHz CH-High, 1 RB

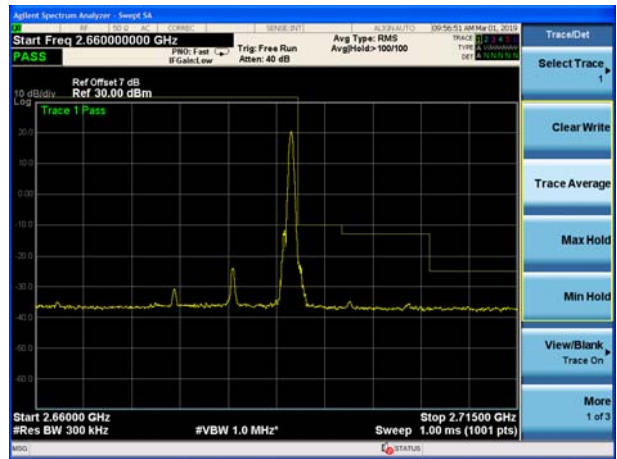

LTE Band 41 QPSK 15MHz CH-Low, 100%RB



LTE Band 41 QPSK 15MHz CH-High, 100%RB



LTE Band 41 QPSK 20MHz CH-Low, 1 RB

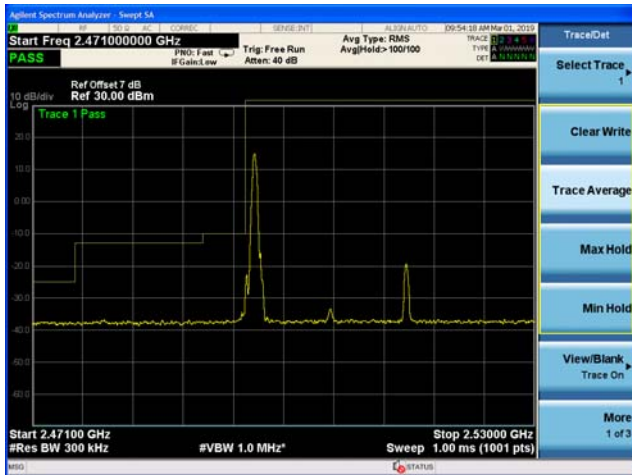

LTE Band 41 QPSK 20MHz CH-High, 1 RB

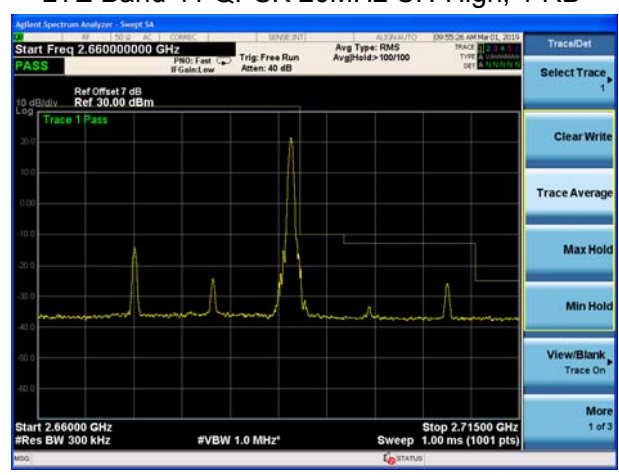

LTE Band 41 QPSK 20MHz CH-Low, 100%RB

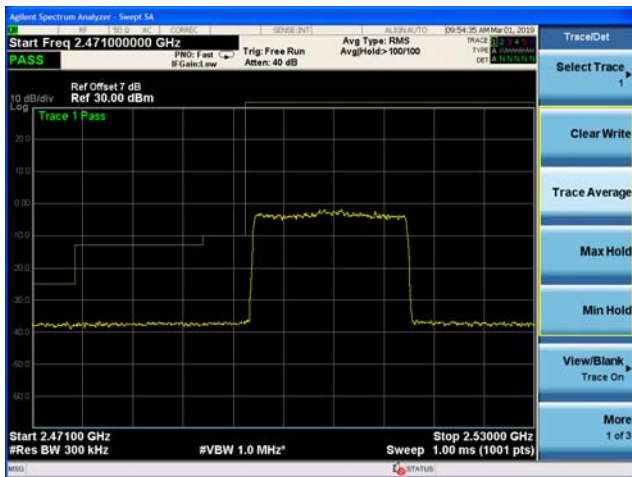

LTE Band 41 QPSK 20MHz CH-High, 100%RB



LTE Band 41 16QAM 5MHz CH-Low, 1 RB

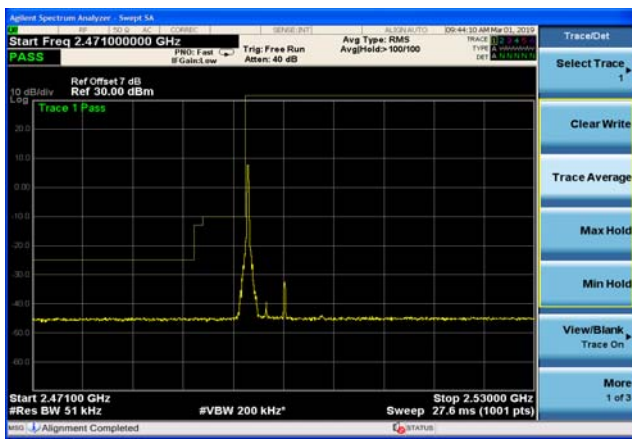

LTE Band 41 16QAM 5MHz CH-High, 1 RB

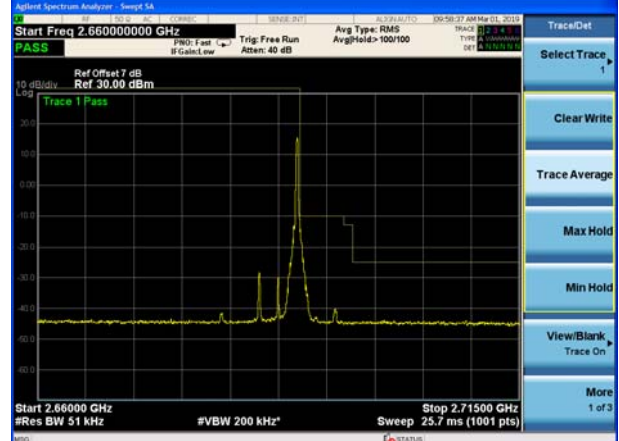

LTE Band 41 16QAM 5MHz CH-Low, 100%RB

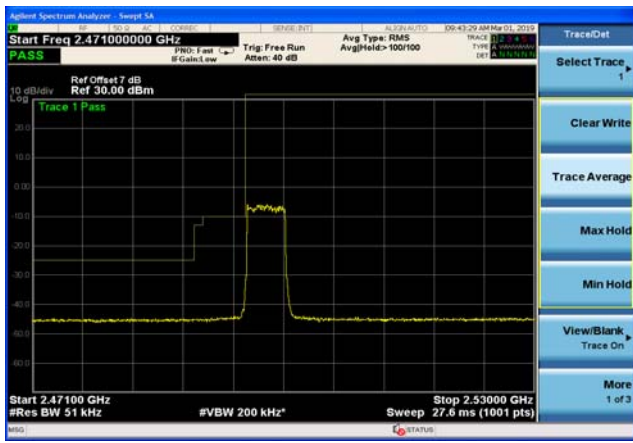

LTE Band 41 16QAM 5MHz CH-High, 100%RB

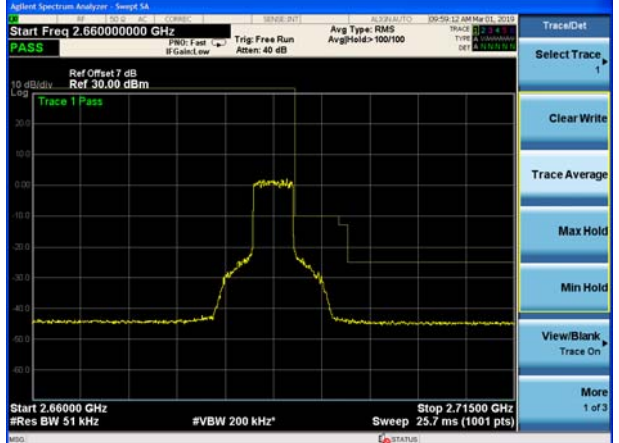

LTE Band 41 16QAM 10MHz CH-Low, 1 RB

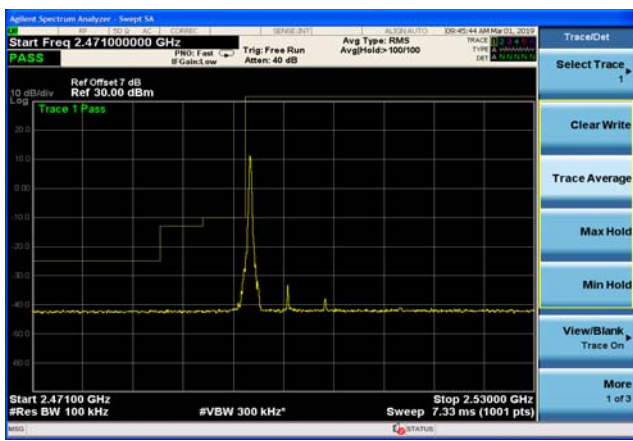

LTE Band 41 16QAM 10MHz CH-High, 1 RB

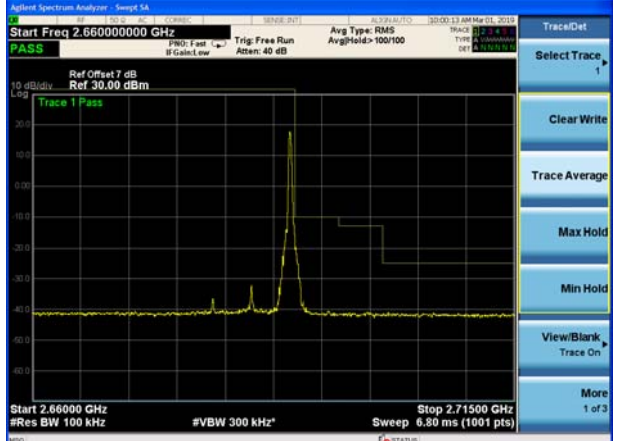

LTE Band 41 16QAM 10MHz CH-Low, 100%RB



LTE Band 41 16QAM 10MHz CH-High, 100%RB



LTE Band 41 16QAM 15MHz CH-Low, 1 RB

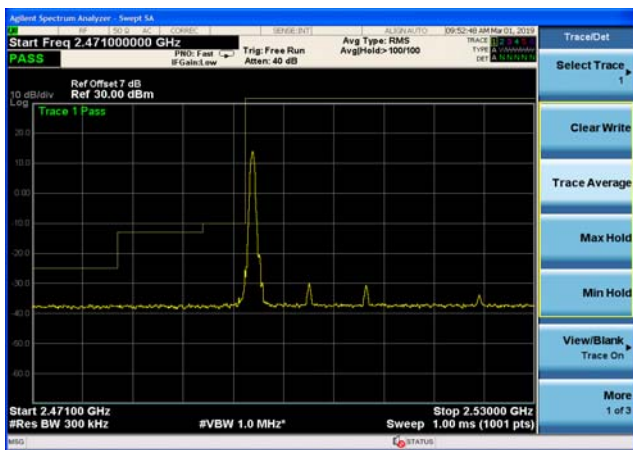

LTE Band 41 16QAM 15MHz CH-High, 1 RB

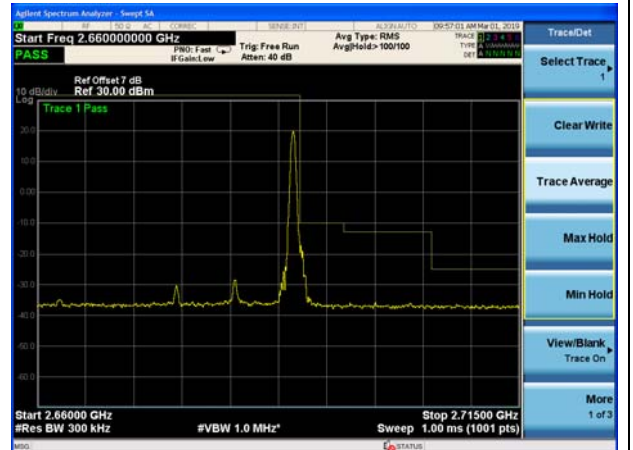

LTE Band 41 16QAM 15MHz CH-Low, 100%RB

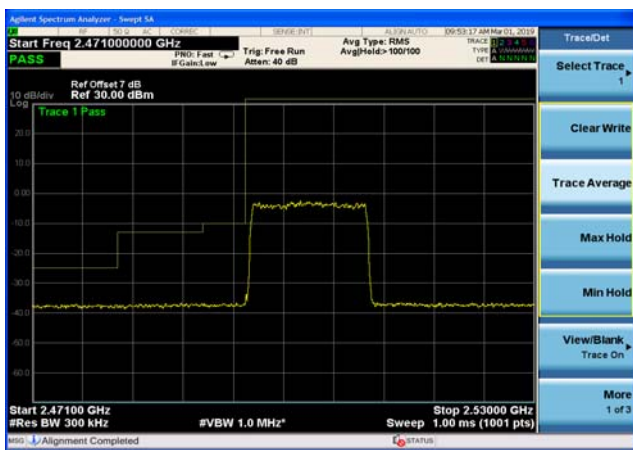

LTE Band 41 16QAM 15MHz CH-High, 100%RB



LTE Band 41 16QAM 20MHz CH-Low, RB 1

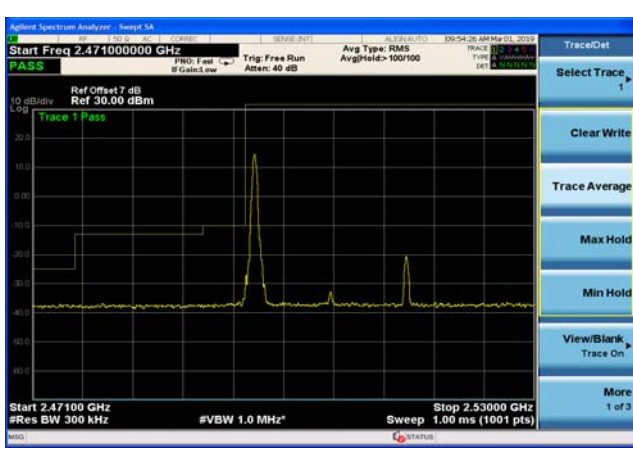

LTE Band 41 16QAM 20MHz CH-High, RB 1

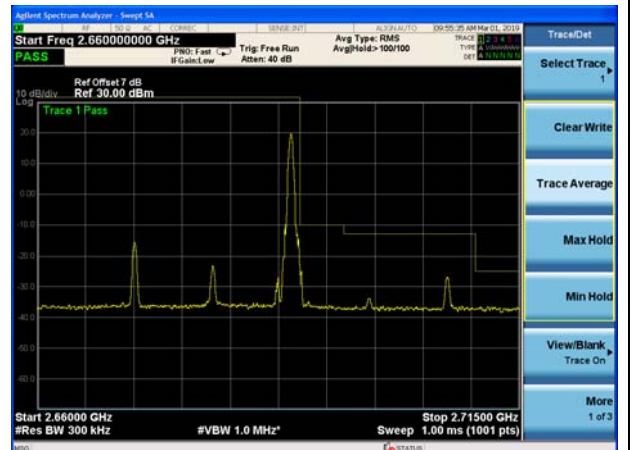



LTE Band 41 16QAM 20MHz CH-Low, 100%RB



LTE Band 41 16QAM 20MHz CH-High, 100%RB



5.5 Peak-to-Average Power Ratio (PAPR)

Ambient condition

Temperature	Relative humidity	Pressure
23°C ~25°C	45%~50%	101.5kPa

Methods of Measurement

Measure the total peak power and record as Ppk. And measure the total average power and record as PAvg. Both the peak and average power levels must be expressed in the same logarithmic units (e.g., dBm). Determine the PAPR from:

$$PAPR (dB) = Ppk (dBm) - PAvg (dBm).$$

Test Setup

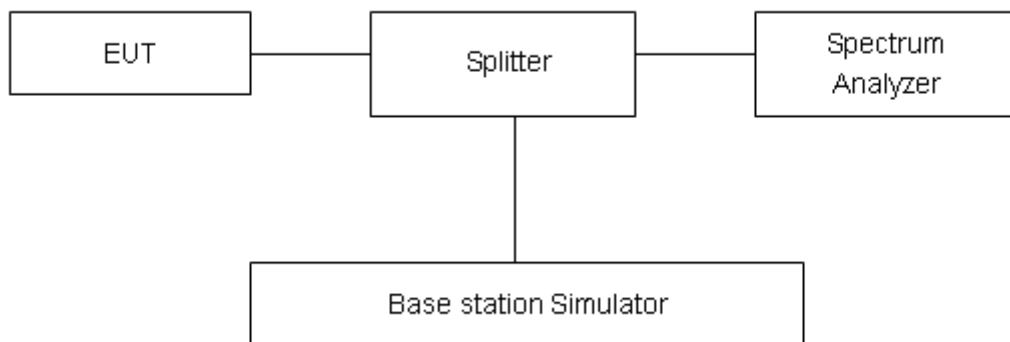

Limits

Rule Part 27.50(d)(5) Equipment employed must be authorized in accordance with the provisions of 24.51. Power measurements for transmissions by stations authorized under this section may be made either in accordance with a Commission-approved average power technique or in compliance with paragraph (d)(6) of this section. In measuring transmissions in this band using an average power technique, the peak-to-average ratio (PAR) of the transmission may not exceed 13 dB.

Measurement Uncertainty

The assessed measurement uncertainty to ensure 95% confidence level for the normal distribution is with the coverage factor k = 2, U= 0.4 dB.

Test Results

LTE Band 41								
Modulation	Bandwidth ((MHz))	Channel	Frequency (MHz)	Peak (dBm)	Avg (dBm)	PAPR (dB)	Limit (dB)	Conclusion
QPSK	5	39675	2498.5	26.10	17.27	8.83	≤13	PASS
		40620	2593	28.20	19.41	8.79	≤13	PASS
		41565	2687.5	26.62	18.61	8.01	≤13	PASS
	10	39700	2501	26.98	18.05	8.93	≤13	PASS
		40620	2593	28.42	20.26	8.16	≤13	PASS
		41540	2685	26.77	19.26	7.51	≤13	PASS
	15	39725	2503.5	26.73	18.14	8.59	≤13	PASS
		40620	2593	28.09	18.79	9.30	≤13	PASS
		41515	2682.5	27.13	19.41	7.72	≤13	PASS
	20	39750	2506	26.71	18.36	8.35	≤13	PASS
		40620	2593	28.77	20.03	8.74	≤13	PASS
		41490	2680	27.02	19.23	7.79	≤13	PASS
16QAM	5	39675	2498.5	25.50	16.48	9.02	≤13	PASS
		40620	2593	27.64	18.46	9.18	≤13	PASS
		41565	2687.5	26.27	17.65	8.62	≤13	PASS
	10	39700	2501	26.98	17.48	9.50	≤13	PASS
		40620	2593	27.77	18.85	8.92	≤13	PASS
		41540	2685	26.77	18.27	8.50	≤13	PASS
	15	39725	2503.5	26.84	17.54	9.30	≤13	PASS
		40620	2593	27.95	18.38	9.57	≤13	PASS
		41515	2682.5	27.15	18.26	8.89	≤13	PASS
	20	39750	2506	26.58	18.00	8.58	≤13	PASS
		40620	2593	27.91	18.69	9.22	≤13	PASS
		41490	2680	27.01	18.59	8.42	≤13	PASS

5.6 Frequency Stability

Ambient condition

Temperature	Relative humidity	Pressure
23°C ~25°C	45%~50%	101.5kPa

Method of Measurement

Frequency Stability (Temperature Variation)

The temperature inside the climate chamber is varied from -30°C to +55°C in 10°C step size.

(1) With all power removed, the temperature was decreased to -10°C and permitted to stabilize for three hours.

(2) Measure the carrier frequency with the test equipment in a “call mode”. These measurements should be made within 1 minute of powering up the mobile station, to prevent significant self warming.

(3) Repeat the above measurements at 10°C increments from -30°C to +55°C. Allow at least 1.5 hours at each temperature, un-powered, before making measurements.

Frequency Stability (Voltage Variation)

The frequency stability shall be measured with variation of primary supply voltage as follows:

(1) Vary primary supply voltage from 85 to 115 percent of the nominal value for other than hand carried battery equipment.

(2) For hand carried, battery powered equipment, reduce primary supply voltage to the battery-operating end point which shall be specified by the manufacturer.

This transceiver is specified to operate with an input voltage of between 20 V and 28V, with a nominal voltage of 24V.

Test setup

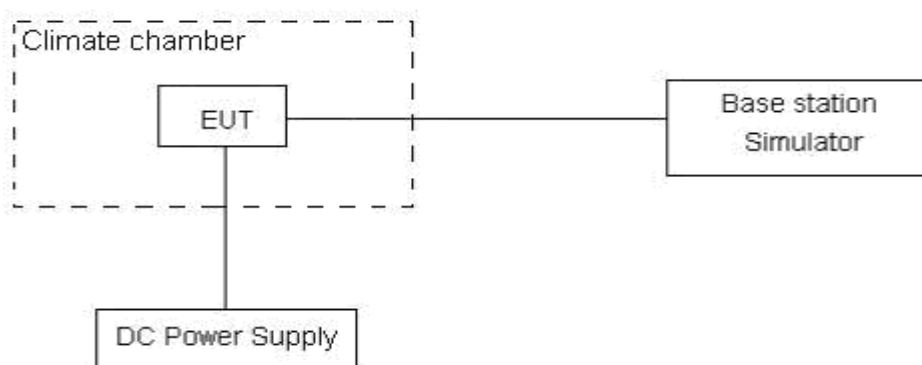

Limits

The frequency stability shall be sufficient to ensure that the fundamental emissions stay within the authorized bands of operation.

Measurement Uncertainty

The assessed measurement uncertainty to ensure 99.75% confidence level for the normal distribution is with the coverage factor $k = 3, U=0.01\text{ppm}$.

Test Result

LTE Band 41						
Condition		Freq.Error (Hz)	Freq.Error (Hz)	Frequency Stability (ppm)	Frequency Stability (ppm)	Verdict
BANDWIDTH	20MHz	16QAM	QPSK	16QAM	QPSK	
Temperature	Voltage	16QAM	QPSK	16QAM	QPSK	
Normal (25°C)	Normal	16.44	3.35	0.00875	0.00178	PASS
Extreme (55°C)	Normal	16.85	1.51	0.00897	0.00080	PASS
Extreme (50°C)		14.47	13.94	0.00769	0.00742	PASS
Extreme (40°C)		5.32	15.53	0.00283	0.00826	PASS
Extreme (30°C)		6.73	17.80	0.00358	0.00947	PASS
Extreme (20°C)		15.80	7.21	0.00840	0.00383	PASS
Extreme (10°C)		15.89	7.13	0.00845	0.00379	PASS
Extreme (0°C)		7.49	15.28	0.00398	0.00813	PASS
Extreme (-10°C)		16.64	17.12	0.00885	0.00911	PASS
Extreme (-20°C)		3.44	9.56	0.00183	0.00509	PASS
Extreme (-30°C)		1.28	2.67	0.00068	0.00142	PASS
25°C		LV	16.49	9.21	0.00877	0.00490
	HV	6.77	7.06	0.00360	0.00376	PASS

5.7 Spurious Emissions at Antenna Terminals

Ambient condition

Temperature	Relative humidity	Pressure
23°C ~25°C	45%~50%	101.5kPa

Method of Measurement

The EUT was connected to Spectrum Analyzer and Base Station Simulator via power Splitter. The measurement is carried out using a spectrum analyzer. The spectrum analyzer scans from 9kHz to the 10th harmonic of the carrier. The peak detector is used.

RBW is set to 100kHz, VBW is set to 300kHz for 30MHz~1GHz

RBW is set to 1MHz, VBW is set to 3MHz for above 1GHz, Sweep is set to ATUO.

Of those disturbances below (limit – 20 dB), the mark is not required for the EUT.

The modulation mode and RB allocation refer to section 5.1, using the maximum output power configuration.

Test setup

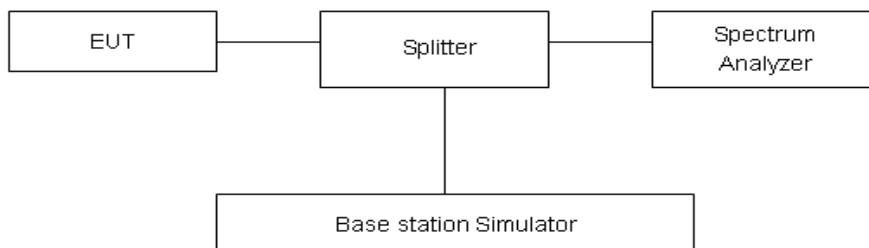

Limits

Rule Part 27.53(m) 55 + 10 log (P) dB on all frequencies more than X megahertz from the channel edge, where X is the greater of 6 megahertz or the actual emission bandwidth as defined in paragraph (m)(4) of this section.

Part 27.53(m) Limit	-25 dBm
---------------------	---------

Measurement Uncertainty

The assessed measurement uncertainty to ensure 99.75% confidence level for the normal distribution is with the coverage factor $k = 1.96$.

Frequency	Uncertainty
9kHz-1GHz	0.684 dB
1GHz-27GHz	1.407 dB

Test Result

Sweep the whole frequency band through the range from 9kHz to the 10th harmonic of the carrier, the emissions more than 20 dB below the limit are not reported.

The signal beyond the limit is carrier.

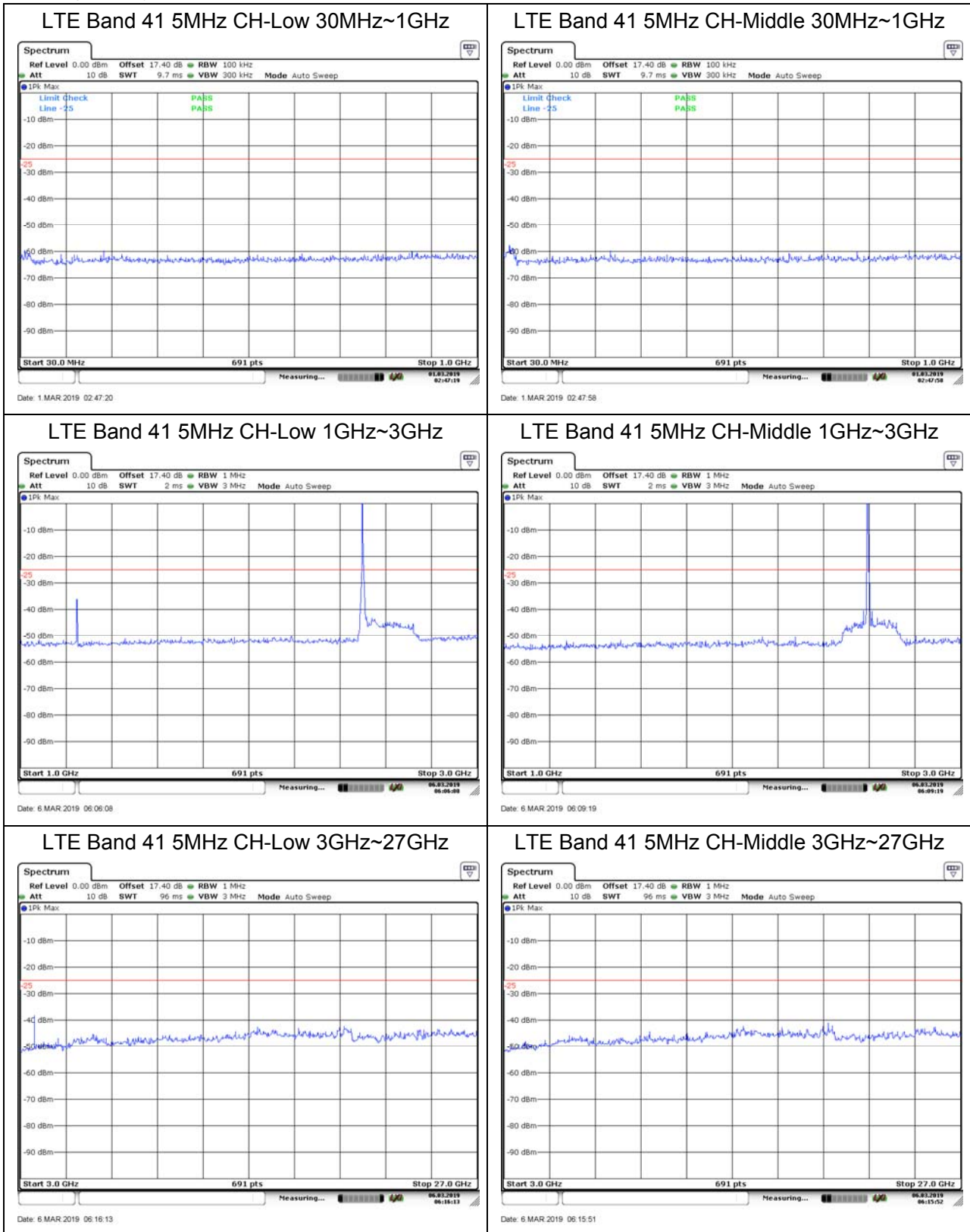



LTE Band 41 5MHz CH-High 30MHz~1GHz

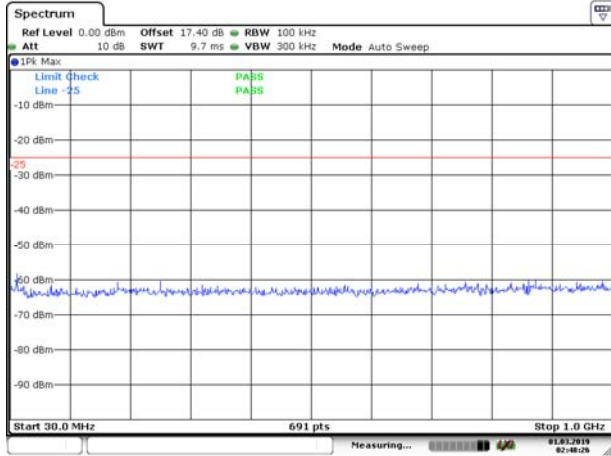

Date: 1.MAR.2019 02:48:27

LTE Band 41 10MHz CH-Low 30MHz~1GHz

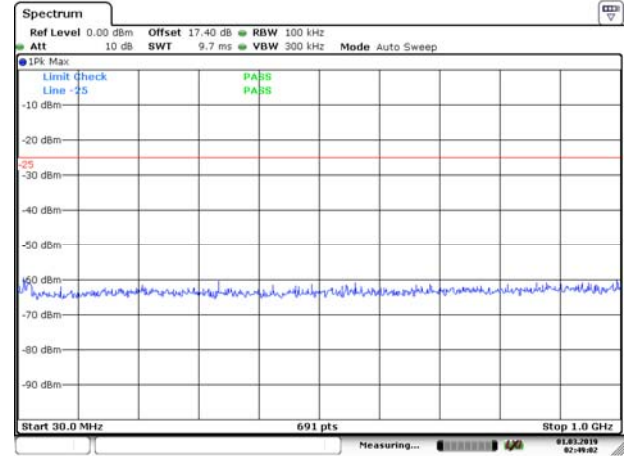

Date: 1.MAR.2019 02:49:02

LTE Band 41 5MHz CH-High 1GHz~3GHz

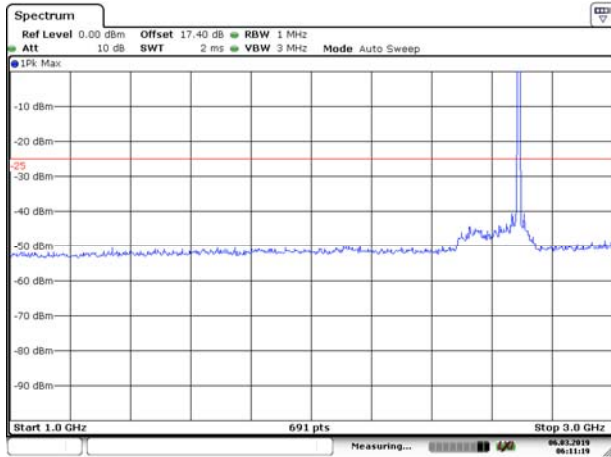

Date: 6.MAR.2019 06:11:19

LTE Band 41 10MHz CH-Low 1GHz~3GHz

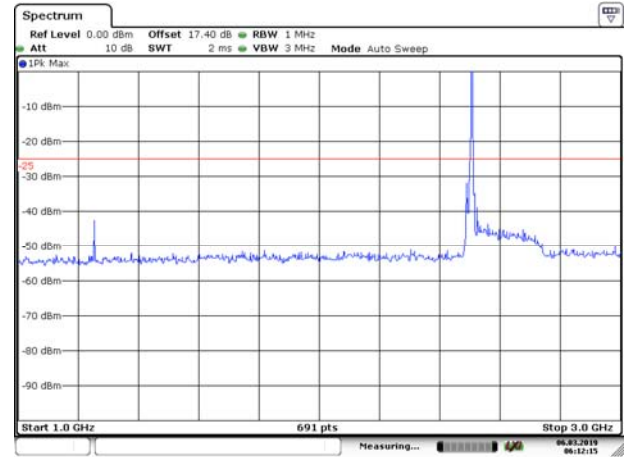

Date: 6.MAR.2019 06:12:14

LTE Band 41 5MHz CH-High 3GHz~27GHz

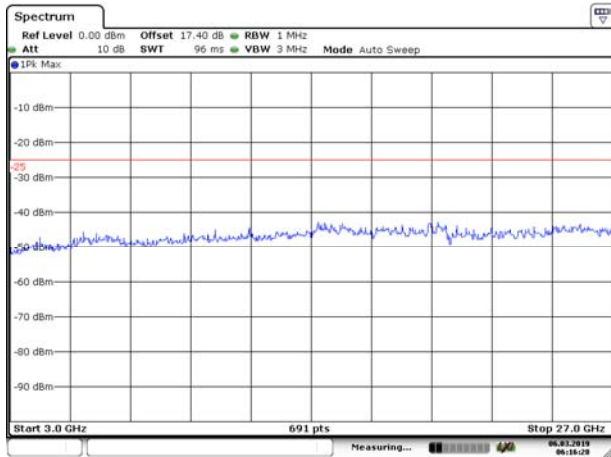

Date: 6.MAR.2019 06:16:29

LTE Band 41 10MHz CH-Low 3GHz~27GHz

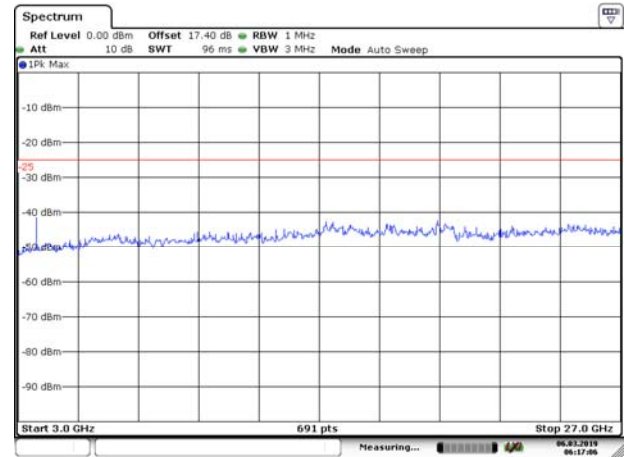

Date: 6.MAR.2019 06:17:06

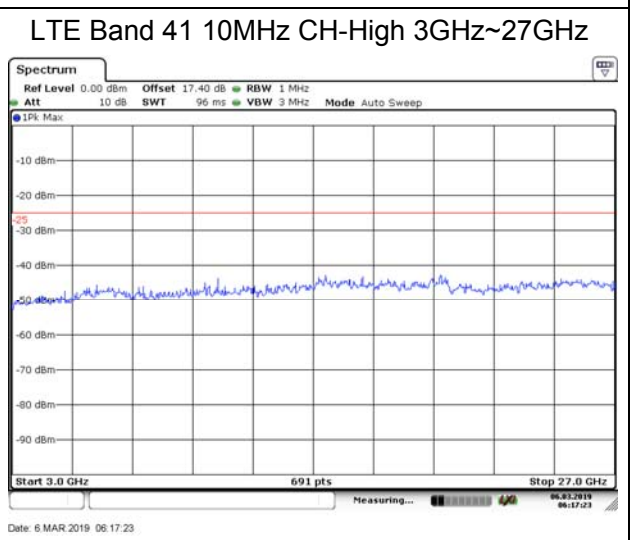
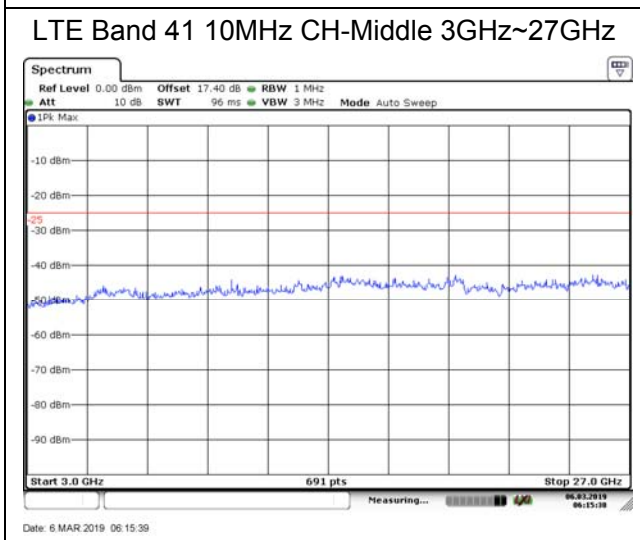
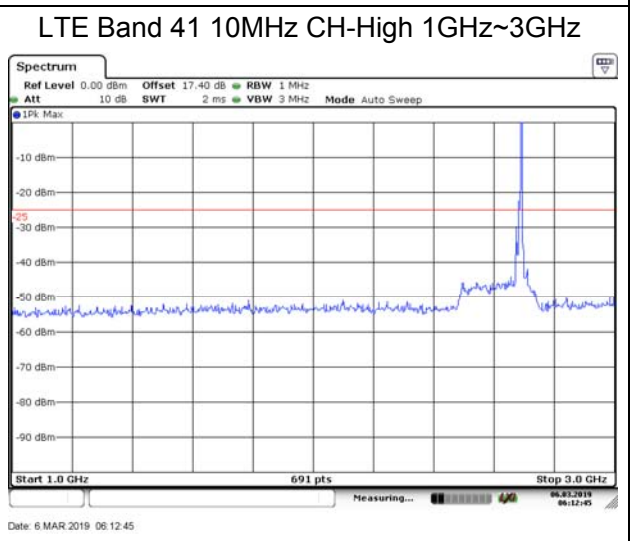
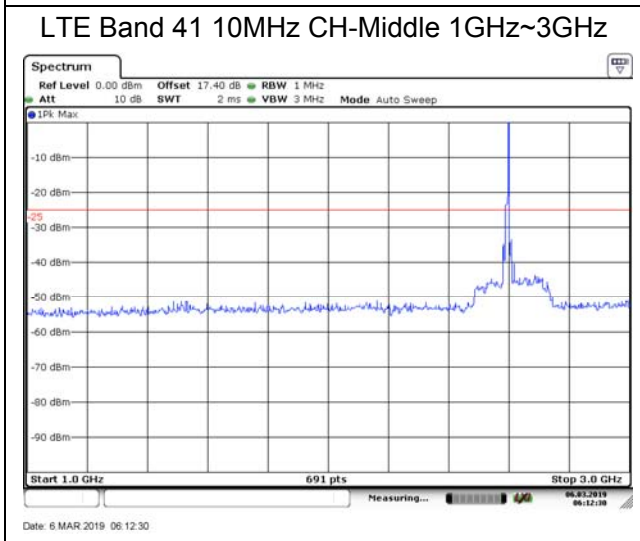
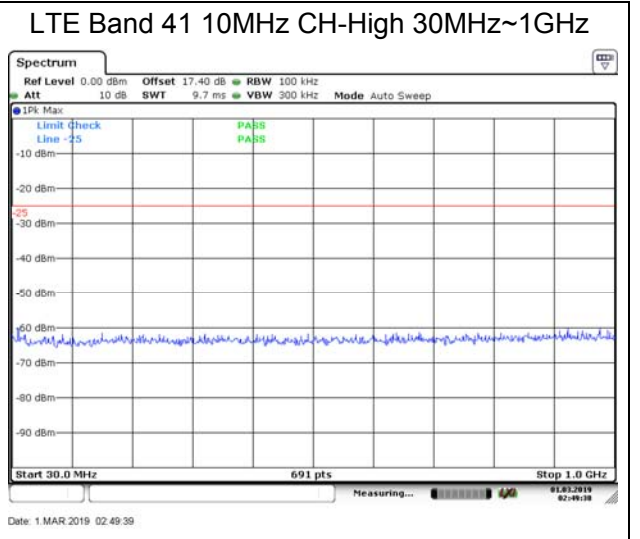
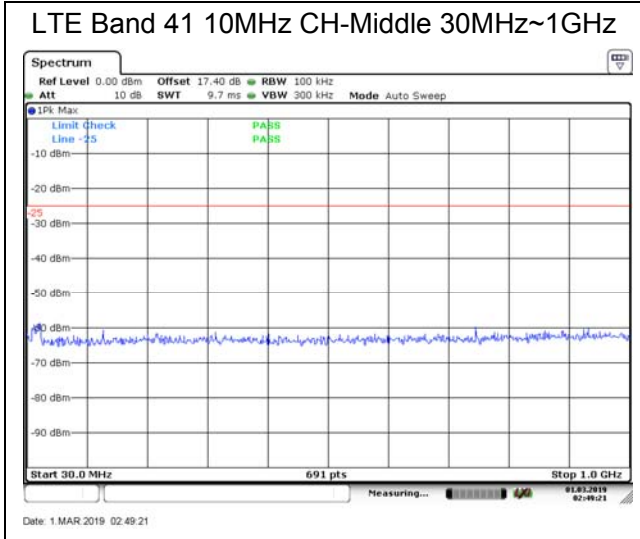



LTE Band 41 15MHz CH-Low 30MHz~1GHz

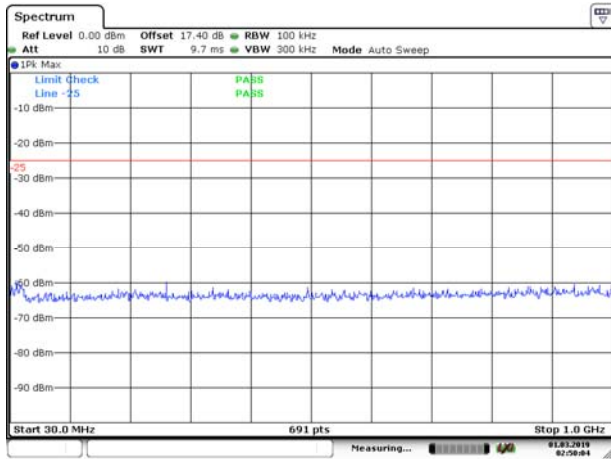

LTE Band 41 15MHz CH-Middle 30MHz~1GHz

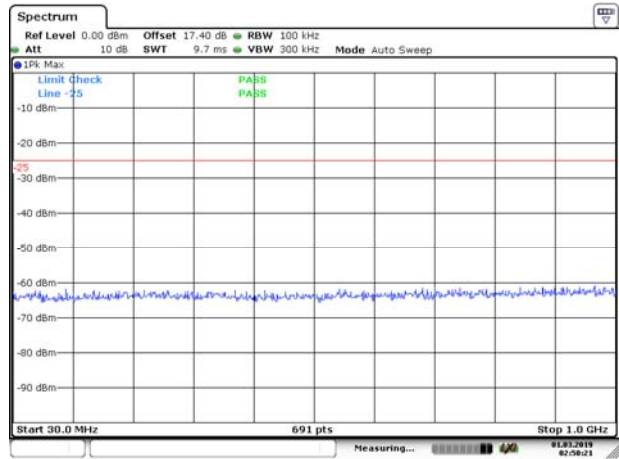

LTE Band 41 15MHz CH-Low 1GHz~3GHz

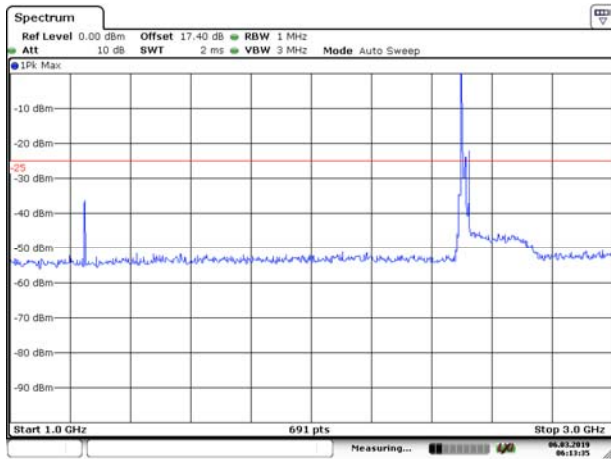

LTE Band 41 15MHz CH-Middle 1GHz~3GHz

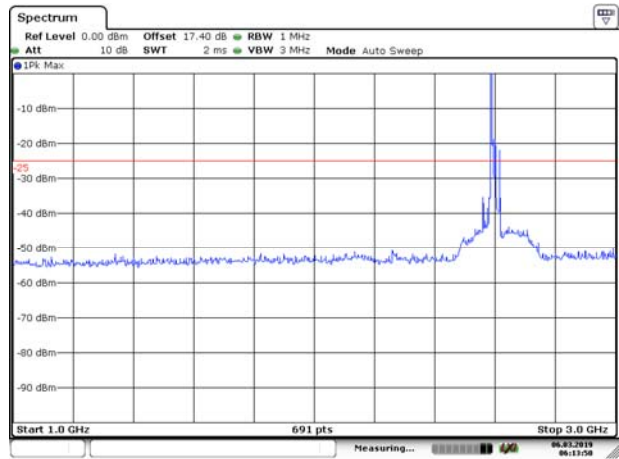

LTE Band 41 15MHz CH-Low 3GHz~27GHz

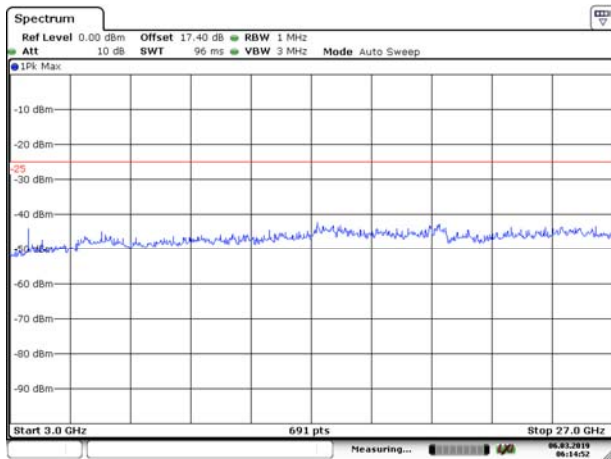

LTE Band 41 15MHz CH-Middle 3GHz~27GHz

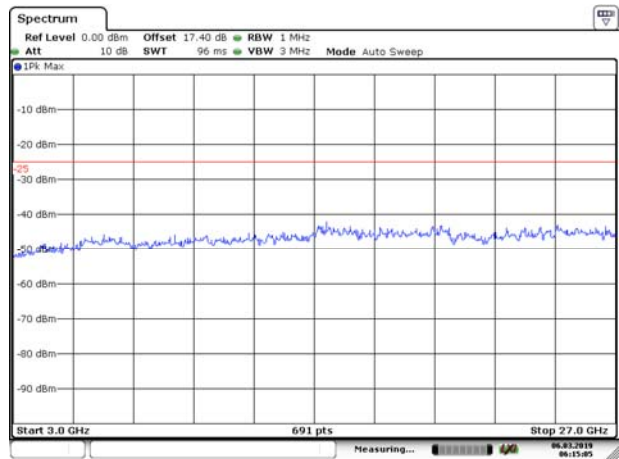



LTE Band 41 15MHz CH-High 30MHz~1GHz

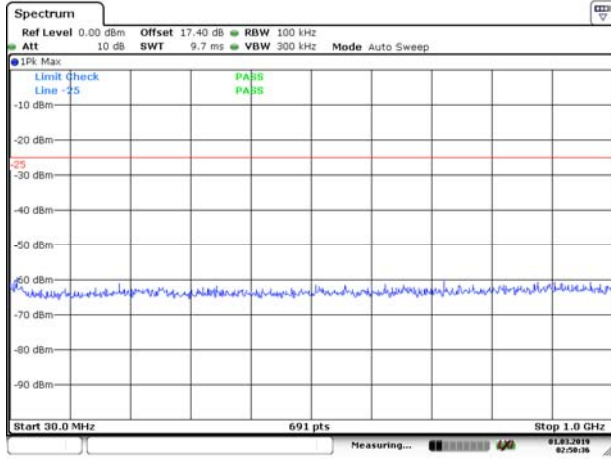

LTE Band 41 20MHz CH-Low 30MHz~1GHz

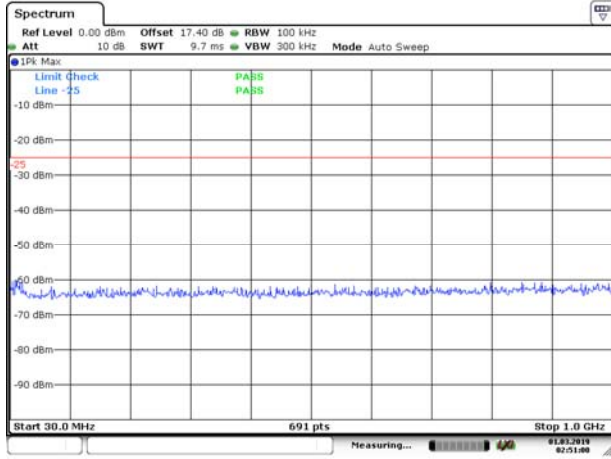

LTE Band 41 15MHz CH-High 1GHz~3GHz

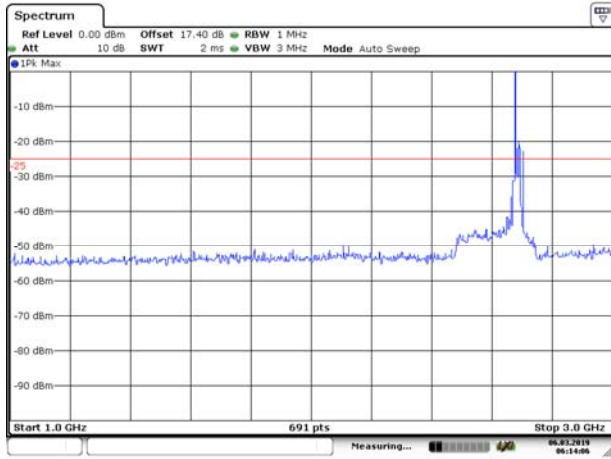

LTE Band 41 20MHz CH-Low 1GHz~3GHz

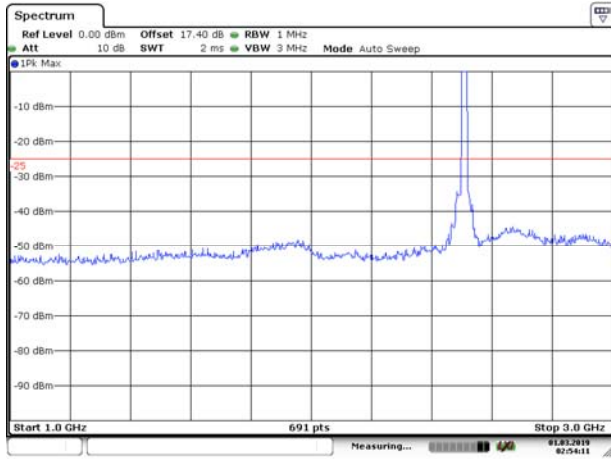

LTE Band 41 15MHz CH-High 3GHz~27GHz

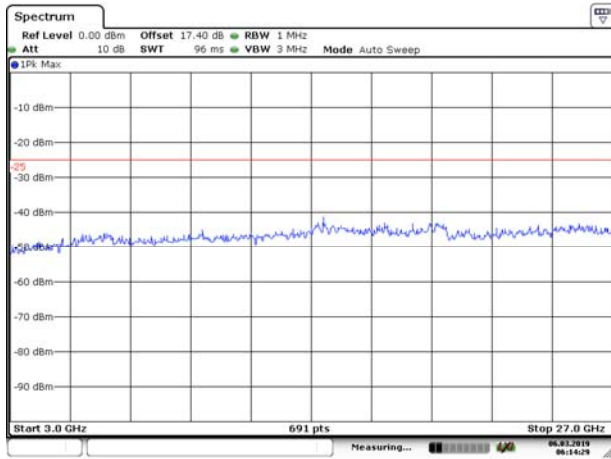

LTE Band 41 20MHz CH-Low 3GHz~27GHz

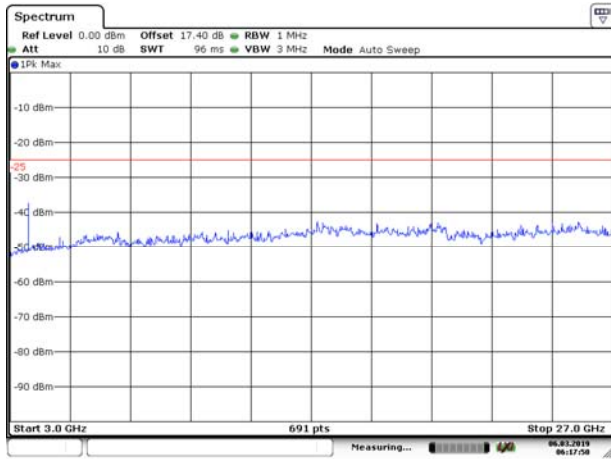



LTE Band 41 20MHz CH-Middle 30MHz~1GHz

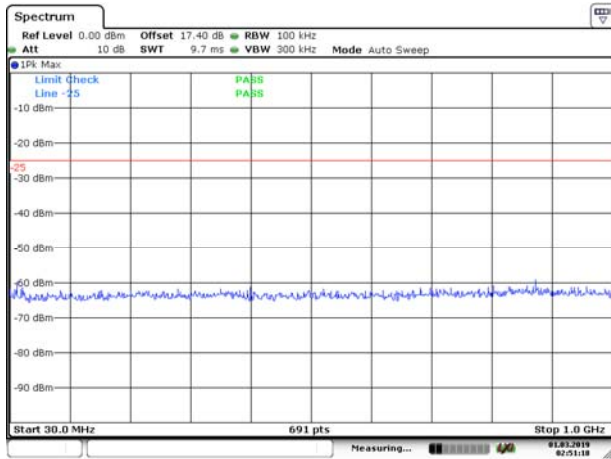

Date: 1.MAR.2019 02:51:18

LTE Band 41 20MHz CH-High 30MHz~1GHz

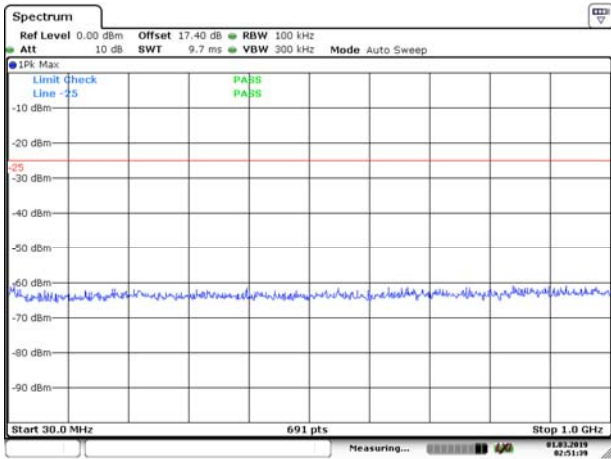

Date: 1.MAR.2019 02:51:40

LTE Band 41 20MHz CH-Middle 1GHz~3GHz

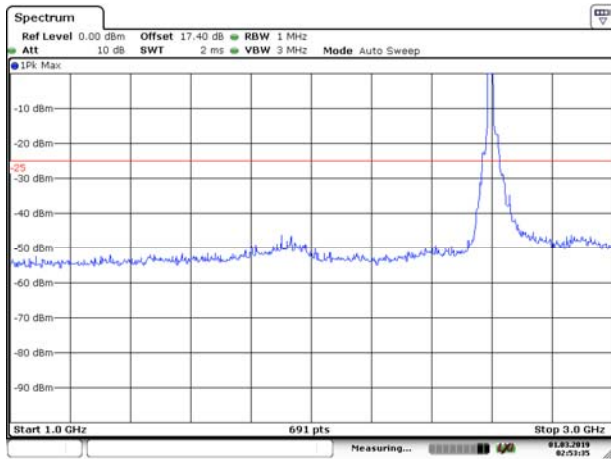

Date: 1.MAR.2019 02:53:35

LTE Band 41 20MHz CH-High 1GHz~3GHz

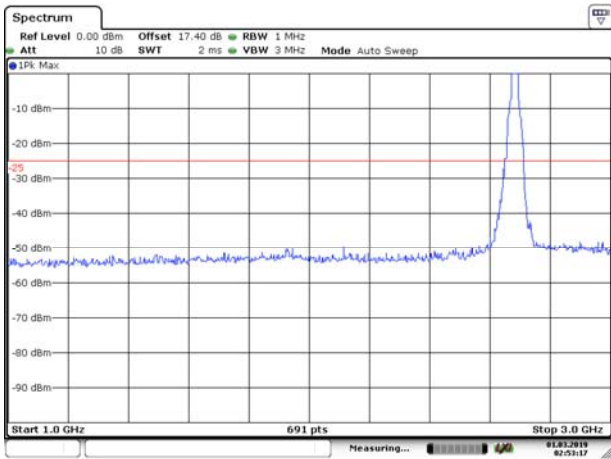

Date: 1.MAR.2019 02:53:17

LTE Band 41 20MHz CH-Middle 3GHz~27GHz

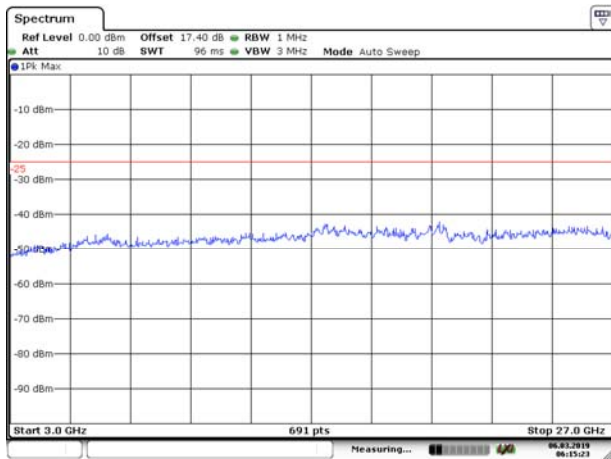

Date: 6.MAR.2019 06:15:24

LTE Band 41 20MHz CH-High 3GHz~27GHz

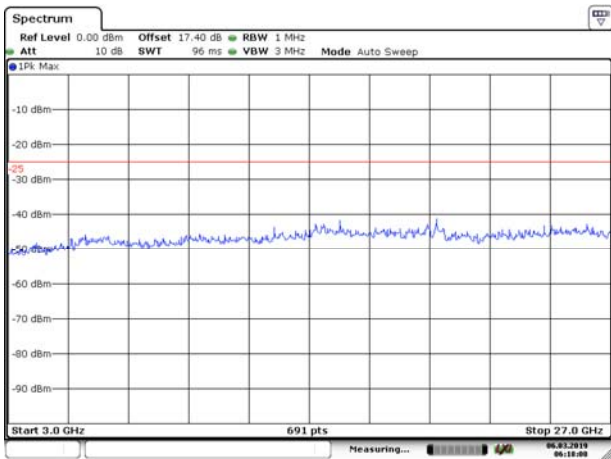

Date: 6.MAR.2019 06:18:09

5.8 Radiates Spurious Emission

Ambient condition

Temperature	Relative humidity	Pressure
23°C ~25°C	45%~50%	101.5kPa

Method of Measurement

- The testing follows FCC KDB 971168 D01 v03r01 Section 5.8 and ANSI C63.26 (2015).
- Below 1GHz: The EUT is placed on a turntable 0.8 meters above the ground in the chamber, 3 meter away from the antenna. The maximal emission value is acquired by adjusting the antenna height, polarisation and turntable azimuth. Normally, the height range of antenna is 1 m to 4 m, the azimuth range of turntable is 0° to 360°, and the receive antenna has two polarizations Vertical (V) and Horizontal (H). Above 1GHz: (Note: the FCC's permission to use 1.5m as an alternative per TCBC Conf call of Dec. 2, 2014.) The EUT is placed on a turntable 1.5 meters above the ground in the chamber, 3 meter away from the antenna. The maximal emission value is acquired by adjusting the antenna height, polarisation and turntable azimuth. Normally, the height range of antenna is 1 m to 4 m, the azimuth range of turntable is 0° to 360°, and the receive antenna has two polarizations Vertical (V) and Horizontal (H).
- A loop antenna, A log-periodic antenna or horn antenna shall be substituted in place of the EUT. The log-periodic antenna will be driven by a signal generator and the level will be adjusted till the same power value on the spectrum analyzer or receiver. The level of the spurious emissions can be calculated through the level of the signal generator, cable loss, the gain of the substitution antenna and the reading of the spectrum analyzer or receiver.
- The EUT is then put into continuously transmitting mode at its maximum power level during the test. Set Test Receiver or Spectrum RBW=200Hz,VBW=600Hz for 9kHz150kHz , RBW=10kHz, VBW=30kHz 150kHz-30MHz ,RBW=100kHz,VBW=300kHz for 30MHz to 1GHz and RBW=1MHz, VBW=3MHz for above 1GHz And the maximum value of the receiver should be recorded as (Pr).
- The EUT shall be replaced by a substitution antenna. In the chamber, an substitution antenna for the frequency band of interest is placed at the reference point of the chamber. An RF Signal source for the frequency band of interest is connected to the substitution antenna with a cable that has been constructed to not interfere with the radiation pattern of the antenna. A power (PMea) is applied to the input of the substitution antenna, and adjust the level of the signal generator output until the value of the receiver reach the previously recorded (Pr). The power of signal source (PMea) is recorded. The test should be performed by rotating the test item and adjusting the receiving antenna polarization.
- A amplifier should be connected to the Signal Source output port. And the cable should be connect between the Amplifier and the Substitution Antenna. The cable loss (Pcl) ,the Substitution Antenna Gain (Ga) and the Amplifier Gain (PAg) should be recorded after test.
- The measurement results are obtained as described below:
 $Power(EIRP)=PMea- PAg - Pcl + Ga$
 The measurement results are amend as described below:
 $Power(EIRP)=PMea- Pcl + Ga$
- This value is EIRP since the measurement is calibrated using an antenna of known gain (2.15 dBi) and known input power. ERP can be calculated from EIRP by subtracting the gain of the dipole, ERP

= EIRP-2.15dBi.

The modulation mode and RB allocation refer to section 5.1, using the maximum output power configuration.

Test setup

9KHz ~ 30MHz

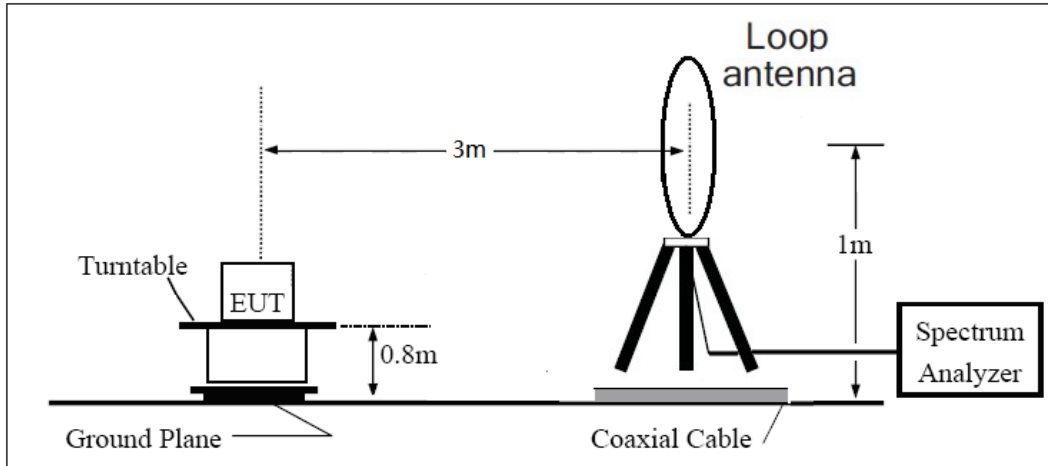

30MHz ~ 1GHz

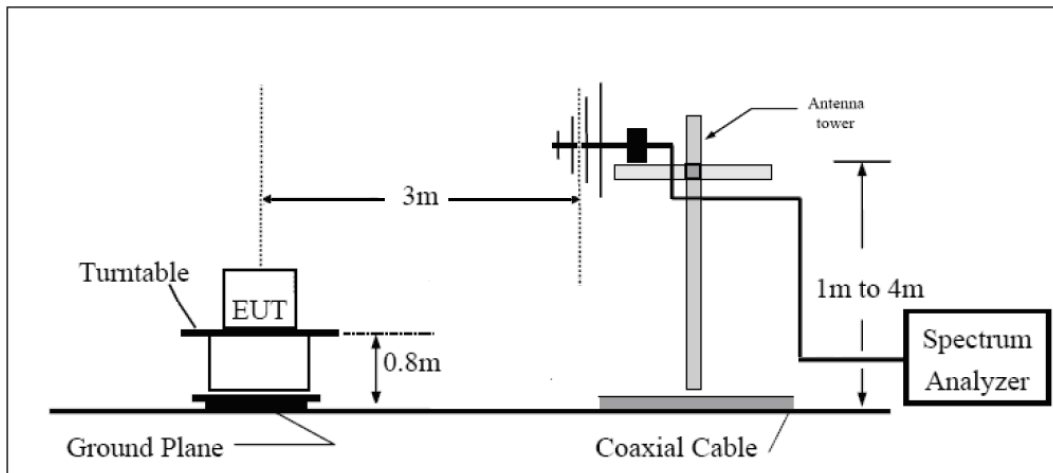

Above 1GHz

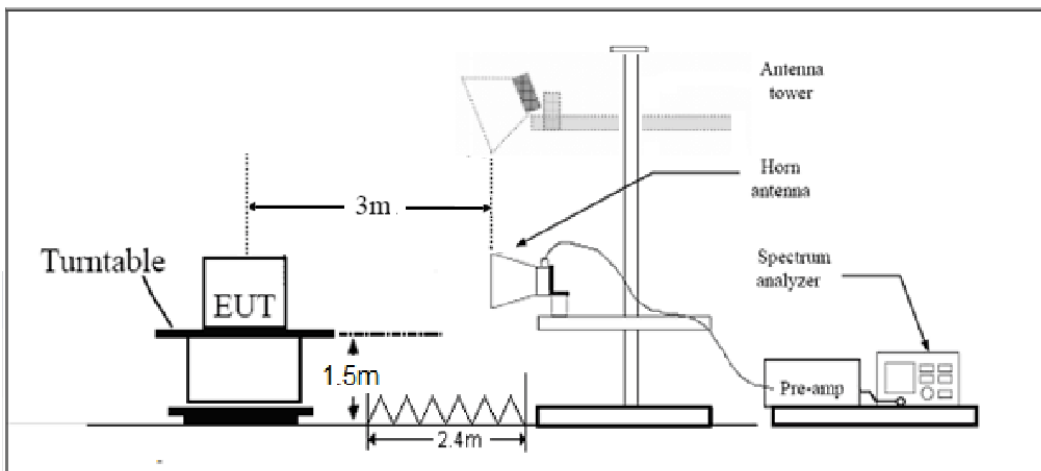

Note: Area side:2.4mX3.6m

**Limits**

Rule Part 27.53(m) $55 + 10 \log (P)$ dB on all frequencies more than X megahertz from the channel edge, where X is the greater of 6 megahertz or the actual emission bandwidth as defined in paragraph (m)(4) of this section.

Part 27.53(m) Limit	-25 dBm
---------------------	---------

Measurement Uncertainty

The assessed measurement uncertainty to ensure 95% confidence level for the normal distribution is with the coverage factor $k = \pm 1.96$, $U = \pm 3.55$ dB.

Test Result

Sweep the whole frequency band through the range from 9kHz to the 10th harmonic of the carrier, the emissions below the noise floor will not be recorded in the report.

LTE Band 41 QPSK 20MHz CH-Low, RB 1

Harmonic	Frequency (MHz)	SG (dBm)	Cable Loss (dB)	Gain (dBi)	Antenna Polarization	EIRP Level (dBm)	Limit (dBm)	Margin (dB)	Azimuth (deg)
2	5012.00	-57.69	2.00	10.15	Vertical	-49.54	-25.00	24.54	135
3	7518.00	-46.24	2.50	11.35	Vertical	-37.39	-25.00	12.39	45
4	10024.00	-39.77	4.20	12.05	Vertical	-31.92	-25.00	6.92	225
5	12530.00	-52.39	5.20	14.85	Vertical	-42.74	-25.00	17.74	90
6	15036.00	-53.11	5.50	13.23	Vertical	-45.38	-25.00	20.38	180
7	17542.00	-50.22	5.70	12.15	Vertical	-43.77	-25.00	18.77	225
8	20048.00	--	--	--	--	--	--	--	--
9	22554.00	--	--	--	--	--	--	--	--
10	25060.00	--	--	--	--	--	--	--	--

Note: 1.The other Spurious RF Radiated emissions level is no more than noise floor.
2. The worst emission was found in the antenna is Vertical position.

LTE Band 41 QPSK 20MHz CH-Middle, RB 1

Harmonic	Frequency (MHz)	SG (dBm)	Cable Loss (dB)	Gain (dBi)	Antenna Polarization	EIRP Level (dBm)	Limit (dBm)	Margin (dB)	Azimuth (deg)
2	5186.00	-54.17	2.00	10.15	Vertical	-46.02	-25.00	21.02	135
3	7779.00	-44.91	2.50	11.35	Vertical	-36.06	-25.00	11.06	180
4	10372.00	-40.85	4.20	12.05	Vertical	-33.00	-25.00	8.00	0
5	12965.00	-54.11	5.20	14.85	Vertical	-44.46	-25.00	19.46	45
6	15558.00	-55.01	5.50	13.23	Vertical	-47.28	-25.00	22.28	315
7	18151.00	--	--	--	--	--	--	--	--
8	20744.00	--	--	--	--	--	--	--	--
9	23337.00	--	--	--	--	--	--	--	--
10	25930.00	--	--	--	--	--	--	--	--

Note: 1.The other Spurious RF Radiated emissions level is no more than noise floor.
2. The worst emission was found in the antenna is Vertical position.

LTE Band 41 QPSK 20MHz CH-High, RB 1

Harmonic	Frequency (MHz)	SG (dBm)	Cable Loss (dB)	Gain (dBi)	Antenna Polarization	EIRP Level (dBm)	Limit (dBm)	Margin (dB)	Azimuth (deg)
2	5360.00	-53.64	2.00	10.15	Vertical	-45.49	-25.00	20.49	180
3	8040.00	-51.63	2.50	11.35	Vertical	-42.78	-25.00	17.78	45
4	10720.00	-43.84	4.20	12.05	Vertical	-35.99	-25.00	10.99	315
5	13400.00	-54.11	5.20	14.85	Vertical	-44.46	-25.00	19.46	225
6	16080.00	-55.26	5.50	13.23	Vertical	-47.53	-25.00	22.53	90
7	18760.00	--	--	--	--	--	--	--	--
8	21440.00	--	--	--	--	--	--	--	--
9	24120.00	--	--	--	--	--	--	--	--
10	26800.00	--	--	--	--	--	--	--	--

Note: 1. The other Spurious RF Radiated emissions level is no more than noise floor.
 2. The worst emission was found in the antenna is Vertical position.

6 Main Test Instruments

Name	Manufacturer	Type	Serial Number	Calibration Date	Expiration Date
Base Station Simulator	R&S	CMW500	113824	2018-05-20	2019-05-19
Power Splitter	Hua Xiang	SHX-GF2-2-13	10120101	/	/
Spectrum Analyzer	Key sight	N9010A	MY50210259	2018-05-20	2019-05-19
Signal Analyzer	R&S	FSV30	100815	2018-12-16	2019-12-15
Loop Antenna	SCHWARZBECK	FMZB1519	1519-047	2017-09-26	2019-09-25
Trilog Antenna	SCHWARZBECK	VUBL 9163	9163-201	2017-11-18	2019-11-17
Horn Antenna	R&S	HF907	100126	2018-07-07	2020-07-06
Horn Antenna	ETS-Lindgren	3160-09	00102643	2018-06-20	2020-06-19
Signal generator	R&S	SMB 100A	102594	2018-05-20	2019-05-19
Climatic Chamber	ESPEC	SU-242	93000506	2017-12-17	2020-12-16
Preamplifier	R&S	SCU18	102327	2018-05-20	2019-05-19
MOB COMMS DC SUPPLY	Keysight	66319D	MY43004105	2018-05-21	2019-05-20
RF Cable	Agilent	SMA 15cm	0001	2018-12-16	2019-03-15
Software	R&S	EMC32	9.26.0	/	/

*****END OF REPORT *****

ANNEX A: EUT Appearance and Test Setup

A.1 EUT Appearance

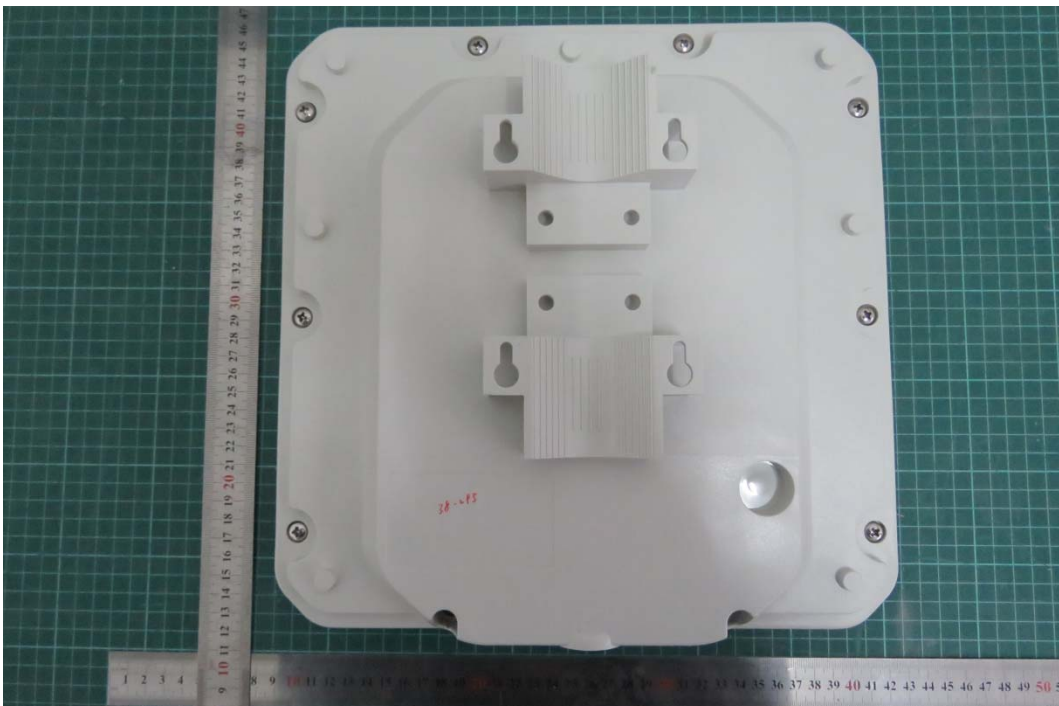

a: EUT



b: Adapter

Picture 1 EUT and Accessory

A.2 Test Setup

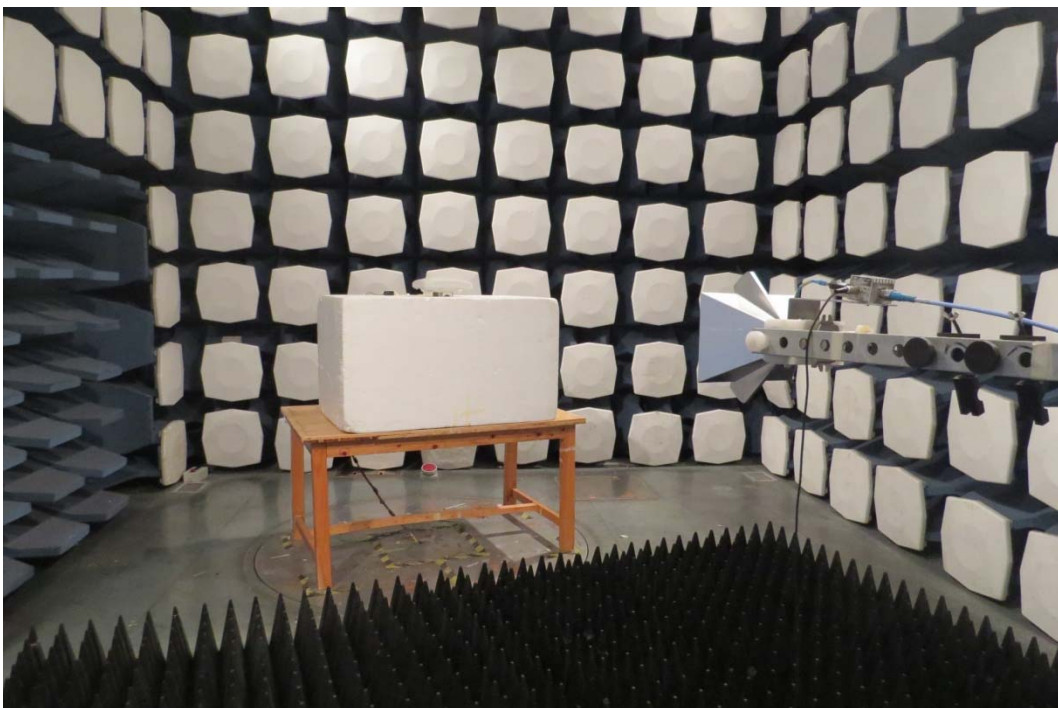

Picture 2 Radiated Spurious Emissions Test setup