



HERMON LABORATORIES

Test specification: Section 90.210, Conducted spurious emissions			
Test procedure: 47 CFR, Sections 2.1051 and 90.210(m)			
Test mode: Compliance		Verdict: PASS	
Date(s): 03-Jan-24			
Temperature: 23 °C	Relative Humidity: 44 %	Air Pressure: 1016 hPa	Power: 48 VDC
Remarks:			

Plot 7.5.40 Spurious emission measurements in 3000 – 4927.5 MHz range at low carrier frequency

MODULATION:
CHANNEL SPACING:
ANTENNA CHAIN: #1

QPSK (worst case variant)
25 MHz
ANTENNA CHAIN: #2

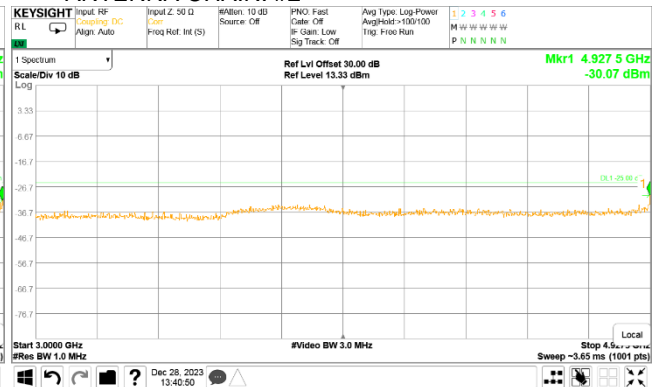
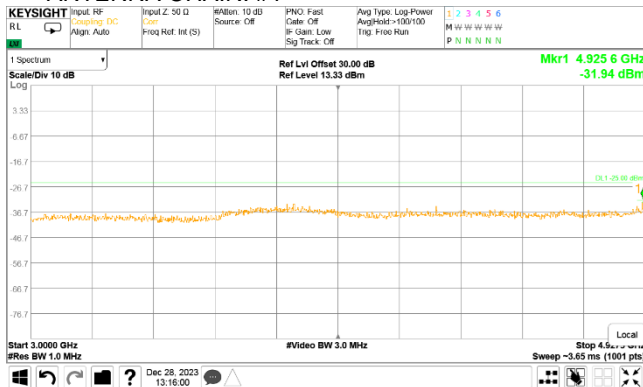

Plot 7.5.41 Spurious emission measurements in 3000 - 4927.5 MHz range at mid carrier frequency

MODULATION:
CHANNEL SPACING:
ANTENNA CHAIN: #1

QPSK (worst case variant)
25 MHz
ANTENNA CHAIN: #2

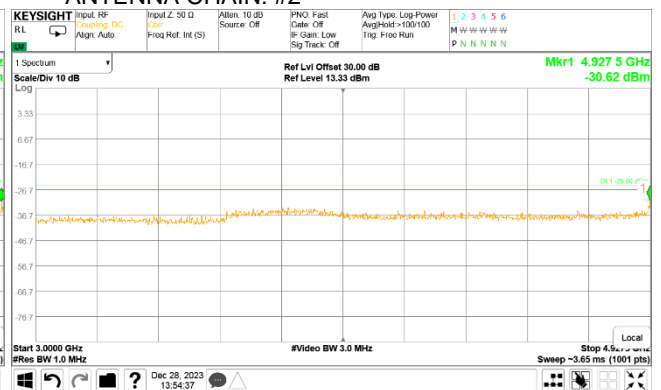
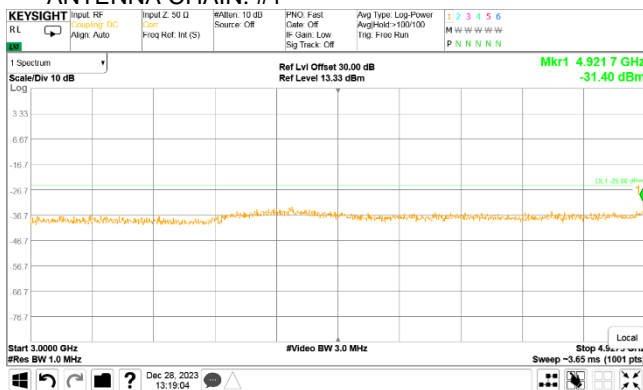



HERMON LABORATORIES

Test specification: Section 90.210, Conducted spurious emissions			
Test procedure: 47 CFR, Sections 2.1051 and 90.210(m)			
Test mode: Compliance		Verdict: PASS	
Date(s): 03-Jan-24			
Temperature: 23 °C	Relative Humidity: 44 %	Air Pressure: 1016 hPa	Power: 48 VDC
Remarks:			

Plot 7.5.42 Spurious emission measurements in 3000 - 4927.5 MHz range at high carrier frequency

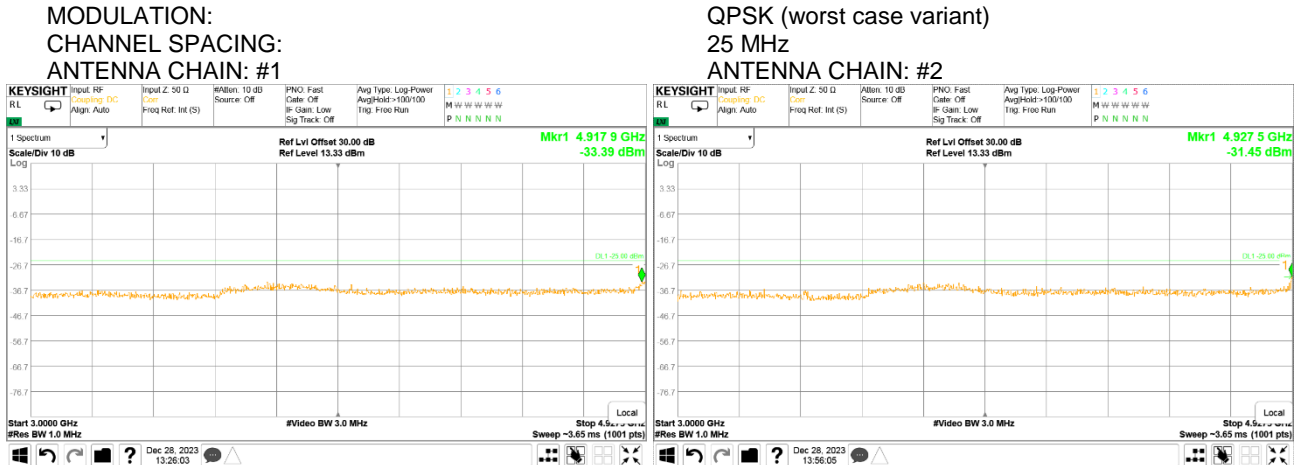

Plot 7.5.43 Spurious emission measurements in 5002.5 - 18000 MHz range at low carrier frequency

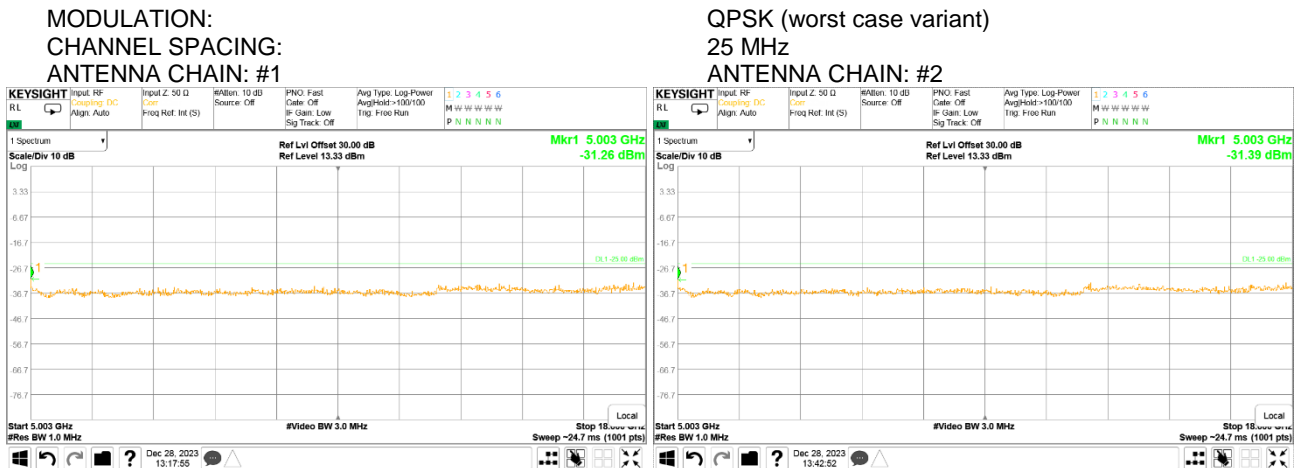



HERMON LABORATORIES

Test specification: Section 90.210, Conducted spurious emissions			
Test procedure: 47 CFR, Sections 2.1051 and 90.210(m)			
Test mode: Compliance		Verdict: PASS	
Date(s): 03-Jan-24			
Temperature: 23 °C	Relative Humidity: 44 %	Air Pressure: 1016 hPa	Power: 48 VDC
Remarks:			

Plot 7.5.44 Spurious emission measurements in 5002.5 - 18000 MHz range at mid carrier frequency

MODULATION:
CHANNEL SPACING:
ANTENNA CHAIN: #1

QPSK (worst case variant)
25 MHz
ANTENNA CHAIN: #2

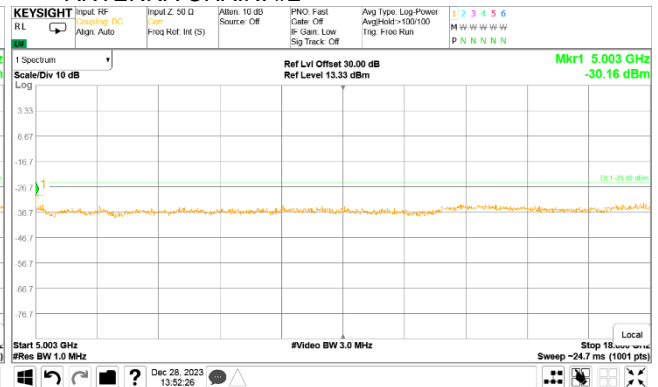
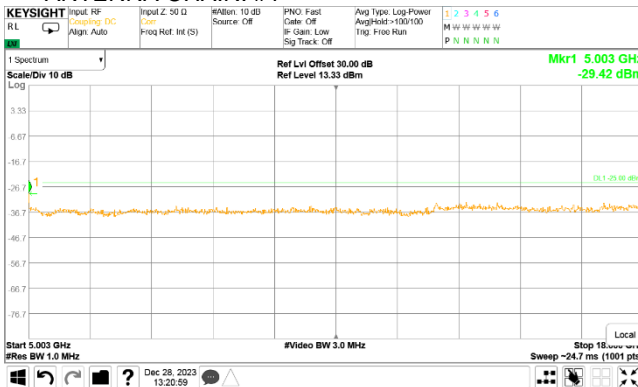

Plot 7.5.45 Spurious emission measurements in 5002.5 - 18000 MHz range at high carrier frequency

MODULATION:
CHANNEL SPACING:
ANTENNA CHAIN: #1

QPSK (worst case variant)
25 MHz
ANTENNA CHAIN: #2

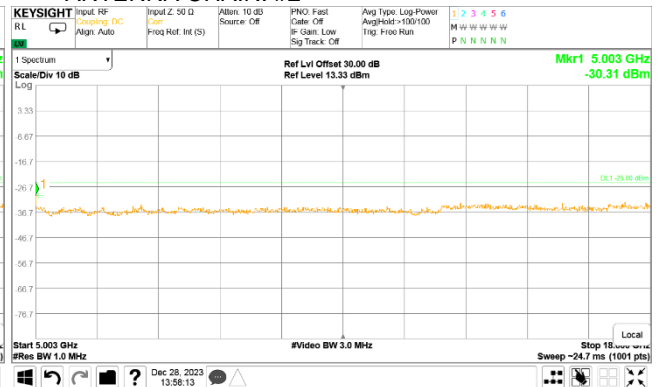
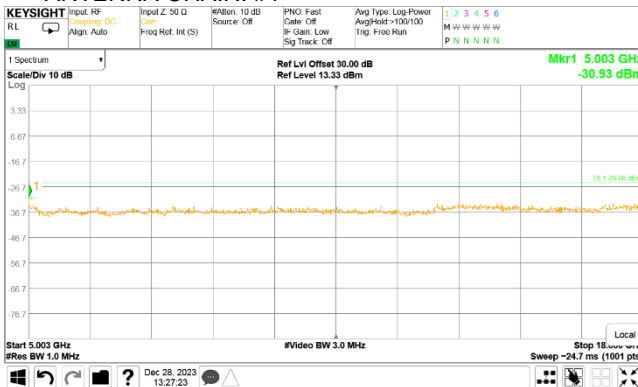



HERMON LABORATORIES

Test specification: Section 90.210, Conducted spurious emissions			
Test procedure: 47 CFR, Sections 2.1051 and 90.210(m)			
Test mode: Compliance		Verdict: PASS	
Date(s): 03-Jan-24			
Temperature: 23 °C	Relative Humidity: 44 %	Air Pressure: 1016 hPa	Power: 48 VDC
Remarks:			

Plot 7.5.46 Spurious emission measurements in 18 – 26.5 GHz range at low carrier frequency

MODULATION:
CHANNEL SPACING:
ANTENNA CHAIN: #1

QPSK (worst case variant)
25 MHz
ANTENNA CHAIN: #2

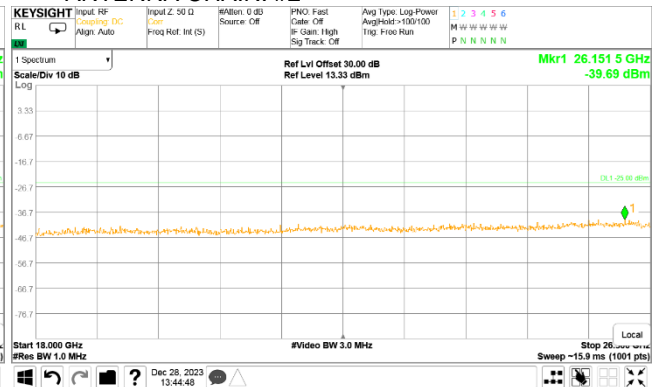
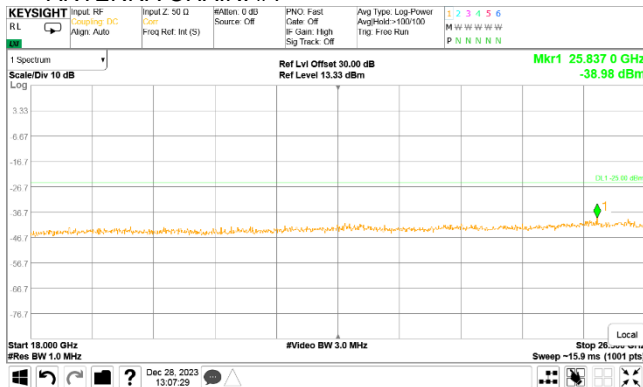

Plot 7.5.47 Spurious emission measurements in 18 – 26.5 GHz range at mid carrier frequency

MODULATION:
CHANNEL SPACING:
ANTENNA CHAIN: #1

QPSK (worst case variant)
25 MHz
ANTENNA CHAIN: #2

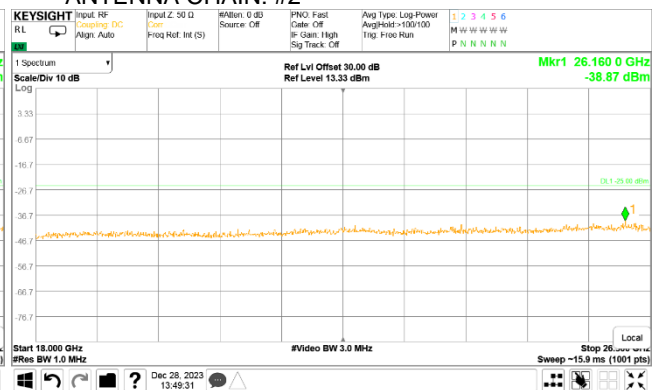
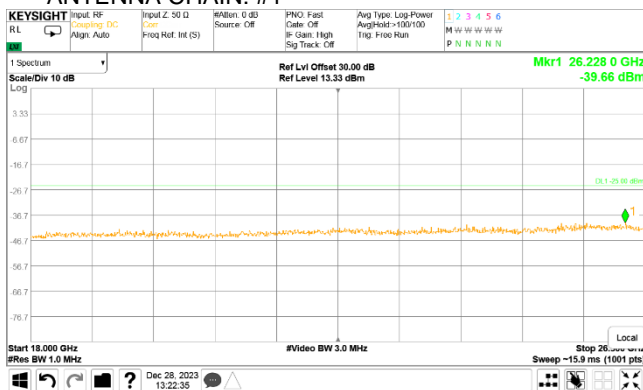



HERMON LABORATORIES

Test specification: Section 90.210, Conducted spurious emissions			
Test procedure: 47 CFR, Sections 2.1051 and 90.210(m)			
Test mode: Compliance		Verdict: PASS	
Date(s): 03-Jan-24			
Temperature: 23 °C	Relative Humidity: 44 %	Air Pressure: 1016 hPa	Power: 48 VDC
Remarks:			

Plot 7.5.48 Spurious emission measurements in 18 – 26.5 GHz range at high carrier frequency

MODULATION:
CHANNEL SPACING:
ANTENNA CHAIN: #1

QPSK (worst case variant)
25 MHz
ANTENNA CHAIN: #2

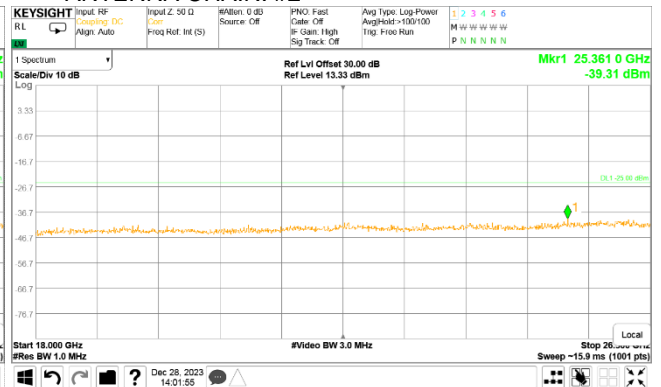
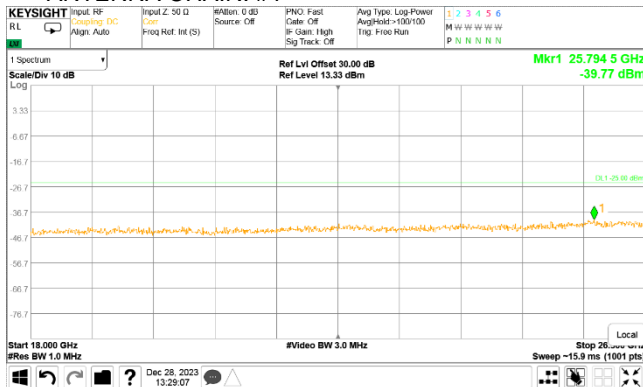

Plot 7.5.49 Spurious emission measurements in 26.5 - 32 GHz range at low carrier frequency

MODULATION:
CHANNEL SPACING:
ANTENNA CHAIN: #1

QPSK (worst case variant)
25 MHz
ANTENNA CHAIN: #2

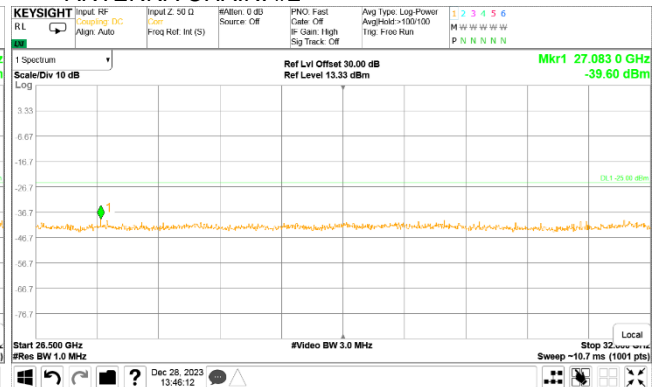
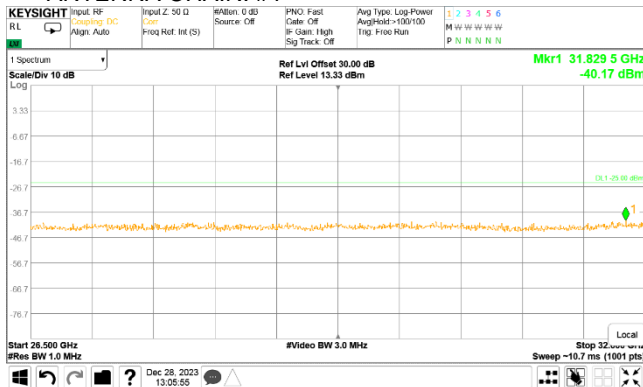



HERMON LABORATORIES

Test specification: Section 90.210, Conducted spurious emissions			
Test procedure: 47 CFR, Sections 2.1051 and 90.210(m)			
Test mode: Compliance		Verdict: PASS	
Date(s): 03-Jan-24			
Temperature: 23 °C	Relative Humidity: 44 %	Air Pressure: 1016 hPa	Power: 48 VDC
Remarks:			

Plot 7.5.50 Spurious emission measurements in 26.5 - 32 GHz range at mid carrier frequency

MODULATION:
CHANNEL SPACING:
ANTENNA CHAIN: #1

QPSK (worst case variant)
25 MHz
ANTENNA CHAIN: #2

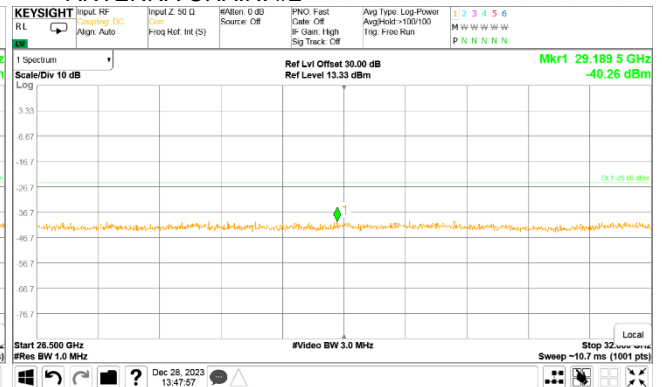

Plot 7.5.51 Spurious emission measurements in 26.5 - 32 GHz range at high carrier frequency

MODULATION:
CHANNEL SPACING:
ANTENNA CHAIN: #1

QPSK (worst case variant)
25 MHz
ANTENNA CHAIN: #2

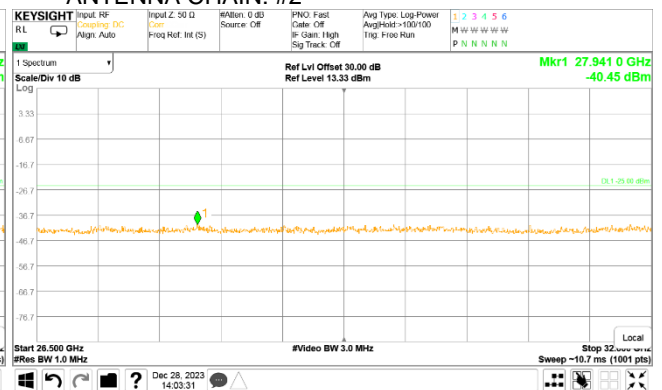
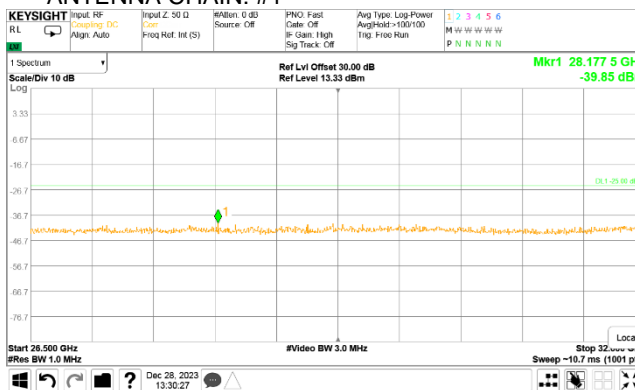



Test specification: Section 90.210, Conducted spurious emissions			
Test procedure: 47 CFR, Sections 2.1051 and 90.210(m)			
Test mode: Compliance		Verdict: PASS	
Date(s): 03-Jan-24			
Temperature: 23 °C	Relative Humidity: 44 %	Air Pressure: 1016 hPa	Power: 48 VDC
Remarks:			

Plot 7.5.52 Spurious emission measurements in 32 - 40 GHz range at low carrier frequency

MODULATION:
CHANNEL SPACING:
ANTENNA CHAIN: #1

QPSK (worst case variant)
25 MHz
ANTENNA CHAIN: #2

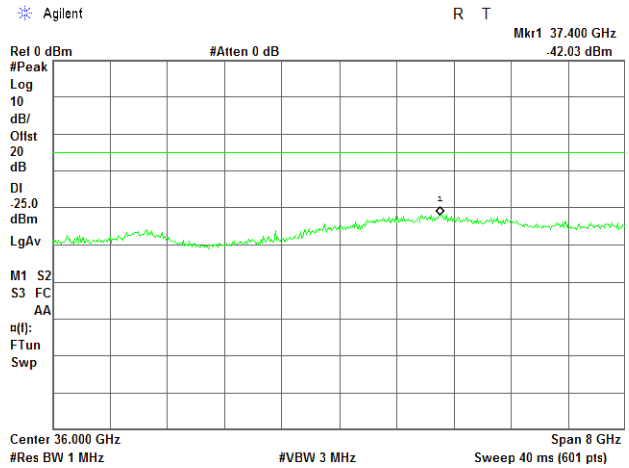
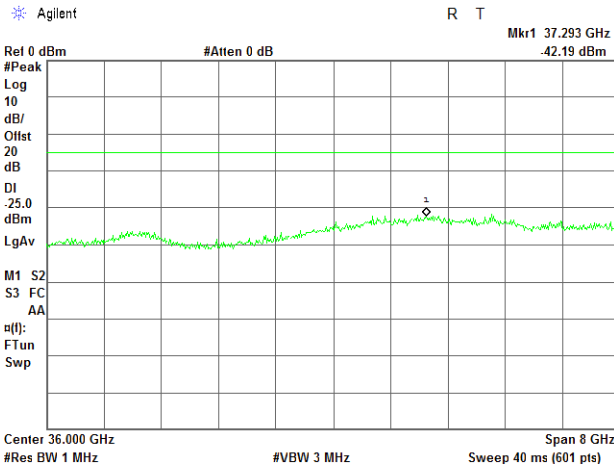

Plot 7.5.53 Spurious emission measurements in 32 - 40 GHz range at mid carrier frequency

MODULATION:
CHANNEL SPACING:
ANTENNA CHAIN: #1

QPSK (worst case variant)
25 MHz
ANTENNA CHAIN: #2

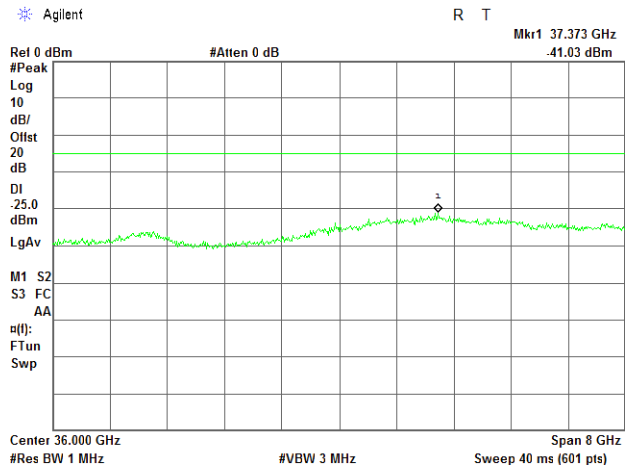
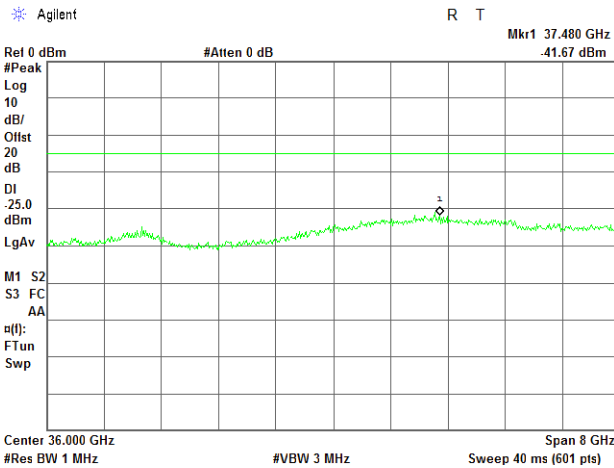



HERMON LABORATORIES

Test specification: Section 90.210, Conducted spurious emissions			
Test procedure: 47 CFR, Sections 2.1051 and 90.210(m)			
Test mode: Compliance		Verdict: PASS	
Date(s): 03-Jan-24			
Temperature: 23 °C	Relative Humidity: 44 %	Air Pressure: 1016 hPa	Power: 48 VDC
Remarks:			

Plot 7.5.54 Spurious emission measurements in 32 - 40 GHz range at high carrier frequency

MODULATION:
CHANNEL SPACING:
ANTENNA CHAIN: #1

QPSK (worst case variant)
25 MHz
ANTENNA CHAIN: #2

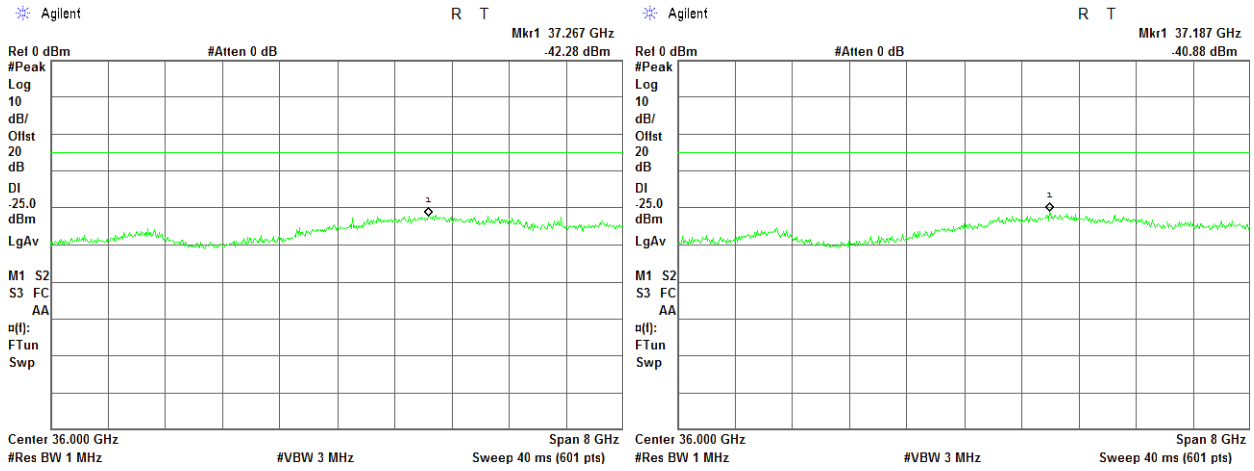



HERMON LABORATORIES

Test specification: Section 90.210, Conducted spurious emissions			
Test procedure: 47 CFR, Sections 2.1051 and 90.210(m)			
Test mode: Compliance		Verdict: PASS	
Date(s): 03-Jan-24			
Temperature: 23 °C	Relative Humidity: 44 %	Air Pressure: 1016 hPa	Power: 48 VDC
Remarks:			

Plot 7.5.55 Spurious emission measurements in 9 kHz - 150 kHz range at mid carrier frequency

MODULATION:
CHANNEL SPACING:
ANTENNA CHAIN: #1

QPSK (worst case variant)
50 MHz
ANTENNA CHAIN: #2

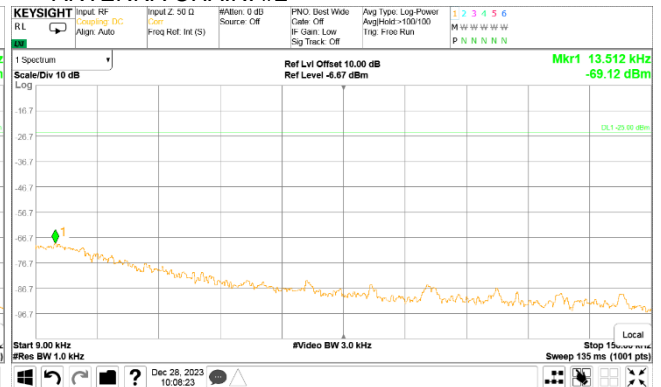
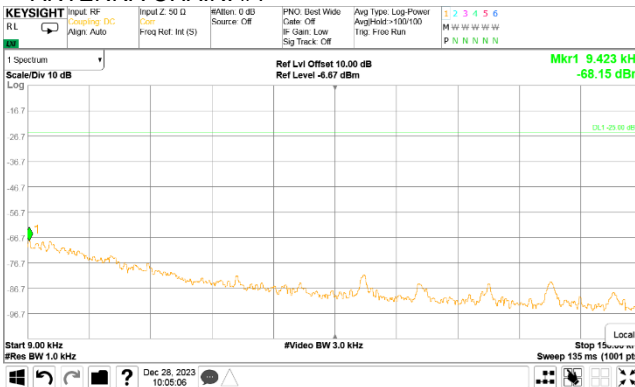

Plot 7.5.56 Spurious emission measurements in 150 kHz – 30 MHz range at mid carrier frequency

MODULATION:
CHANNEL SPACING:
ANTENNA CHAIN: #1

QPSK (worst case variant)
50 MHz
ANTENNA CHAIN: #2

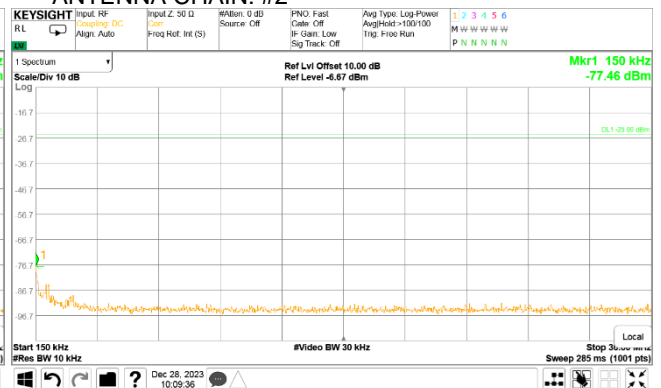
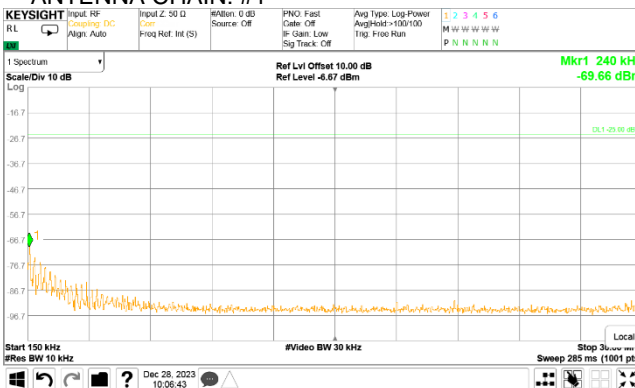



HERMON LABORATORIES

Test specification: Section 90.210, Conducted spurious emissions			
Test procedure: 47 CFR, Sections 2.1051 and 90.210(m)			
Test mode: Compliance		Verdict: PASS	
Date(s): 03-Jan-24			
Temperature: 23 °C	Relative Humidity: 44 %	Air Pressure: 1016 hPa	Power: 48 VDC
Remarks:			

Plot 7.5.57 Spurious emission measurements in 30 - 1400 MHz range at mid carrier frequency

MODULATION:
CHANNEL SPACING:
ANTENNA CHAIN: #1

QPSK (worst case variant)
50 MHz
ANTENNA CHAIN: #2

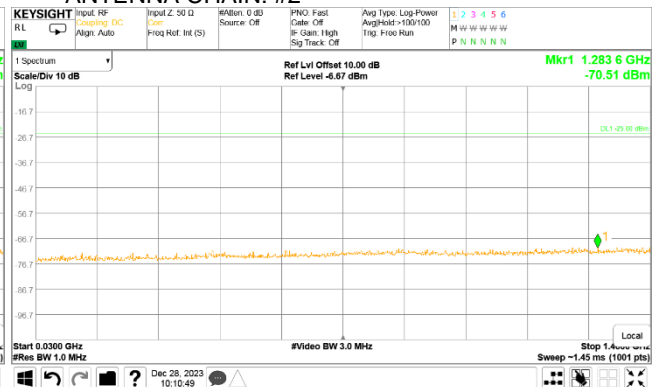
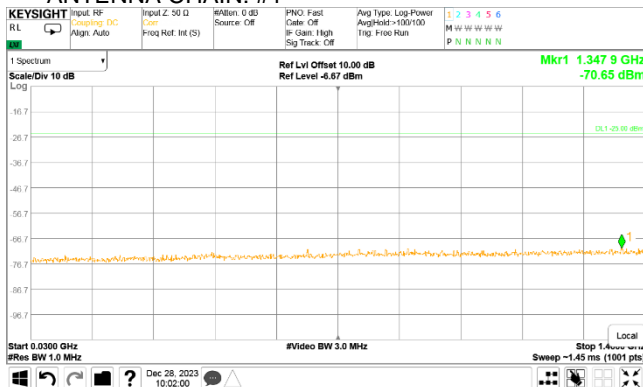

Plot 7.5.58 Spurious emission measurements in 1400 - 3000 MHz range at mid carrier frequency

MODULATION:
CHANNEL SPACING:
ANTENNA CHAIN: #1

QPSK (worst case variant)
50 MHz
ANTENNA CHAIN: #2

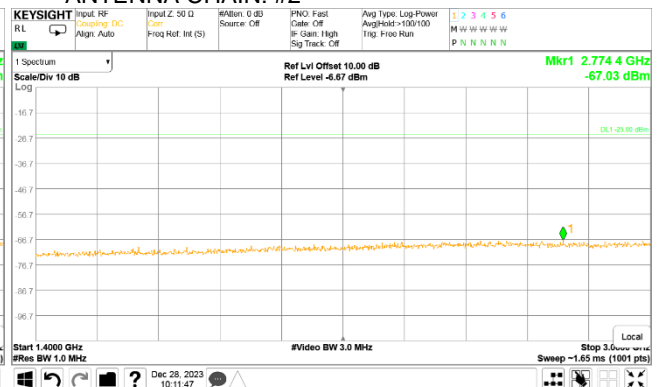
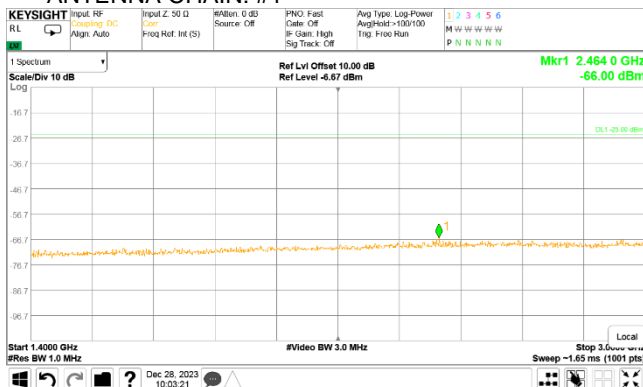



HERMON LABORATORIES

Test specification: Section 90.210, Conducted spurious emissions			
Test procedure: 47 CFR, Sections 2.1051 and 90.210(m)			
Test mode: Compliance		Verdict: PASS	
Date(s): 03-Jan-24			
Temperature: 23 °C	Relative Humidity: 44 %	Air Pressure: 1016 hPa	Power: 48 VDC
Remarks:			

Plot 7.5.59 Spurious emission measurements in 3000 - 4915 range at mid carrier frequency

MODULATION:
CHANNEL SPACING:
ANTENNA CHAIN: #1

QPSK (worst case variant)
50 MHz
ANTENNA CHAIN: #2

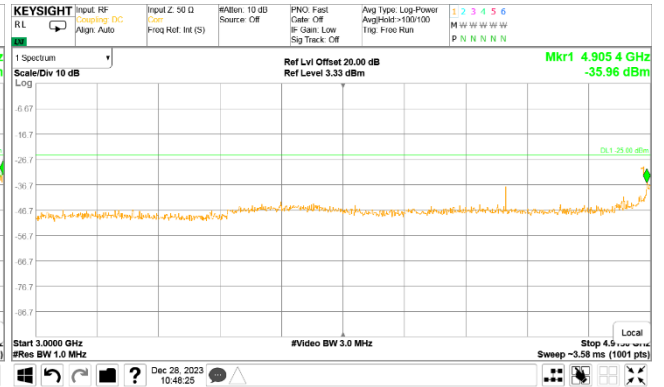
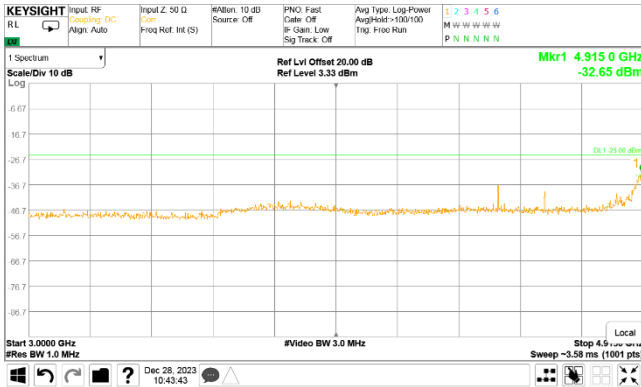



HERMON LABORATORIES

Test specification: Section 90.210, Conducted spurious emissions			
Test procedure: 47 CFR, Sections 2.1051 and 90.210(m)			
Test mode: Compliance		Verdict: PASS	
Date(s): 03-Jan-24			
Temperature: 23 °C	Relative Humidity: 44 %	Air Pressure: 1016 hPa	Power: 48 VDC
Remarks:			

Plot 7.5.60 Spurious emission measurements in 5015 - 18000 MHz range at mid carrier frequency

MODULATION:
CHANNEL SPACING:
ANTENNA CHAIN: #1

QPSK (worst case variant)
50 MHz
ANTENNA CHAIN: #2

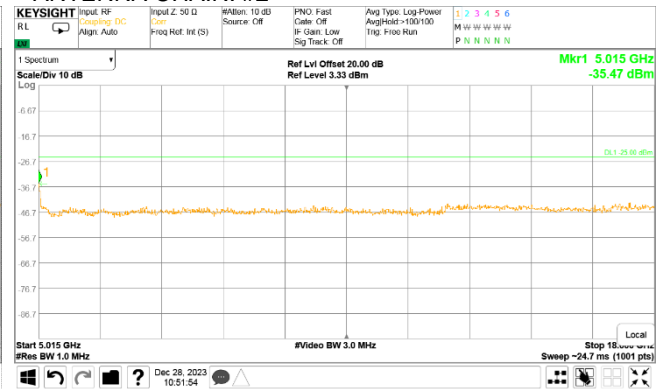
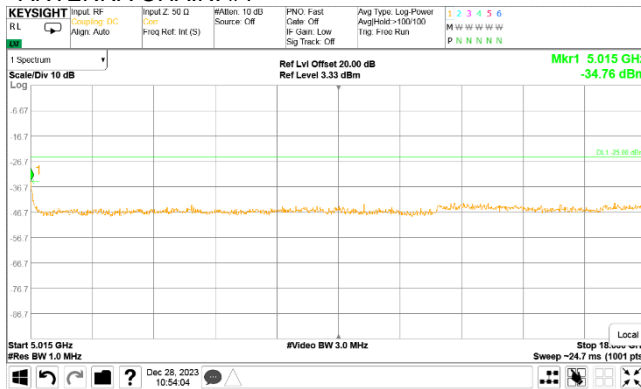

Plot 7.5.61 Spurious emission measurements in 18 – 26.5 GHz range at mid carrier frequency

MODULATION:
CHANNEL SPACING:
ANTENNA CHAIN: #1

QPSK (worst case variant)
50 MHz
ANTENNA CHAIN: #2

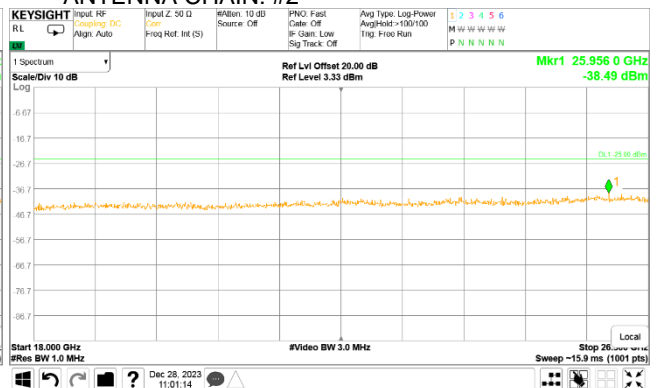
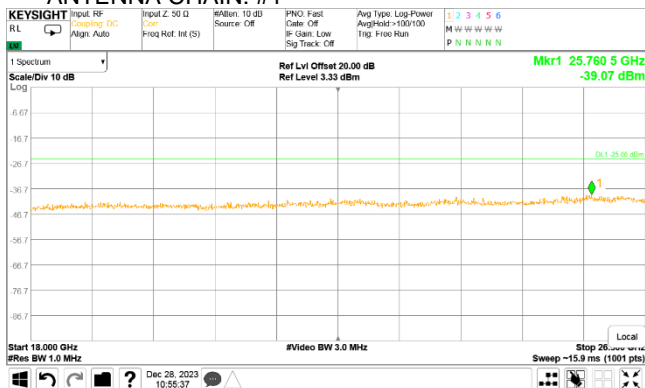



HERMON LABORATORIES

Test specification: Section 90.210, Conducted spurious emissions			
Test procedure: 47 CFR, Sections 2.1051 and 90.210(m)			
Test mode: Compliance		Verdict: PASS	
Date(s): 03-Jan-24			
Temperature: 23 °C	Relative Humidity: 44 %	Air Pressure: 1016 hPa	Power: 48 VDC
Remarks:			

Plot 7.5.62 Spurious emission measurements in 26.5 - 32 GHz range at mid carrier frequency

MODULATION:
CHANNEL SPACING:
ANTENNA CHAIN: #1

QPSK (worst case variant)
50 MHz
ANTENNA CHAIN: #2

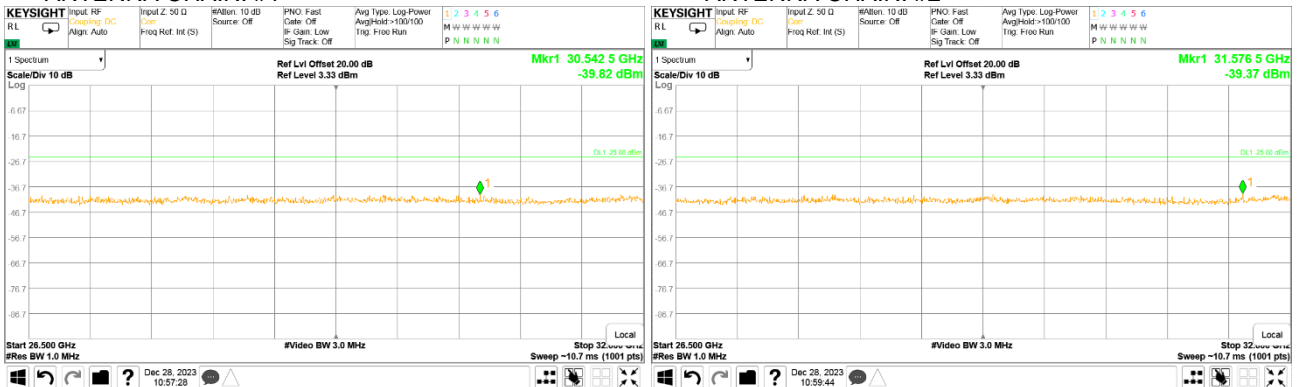

Plot 7.5.63 Spurious emission measurements in 32 - 40 GHz range at mid carrier frequency

MODULATION:
CHANNEL SPACING:
ANTENNA CHAIN: #1

QPSK (worst case variant)
50 MHz
ANTENNA CHAIN: #2

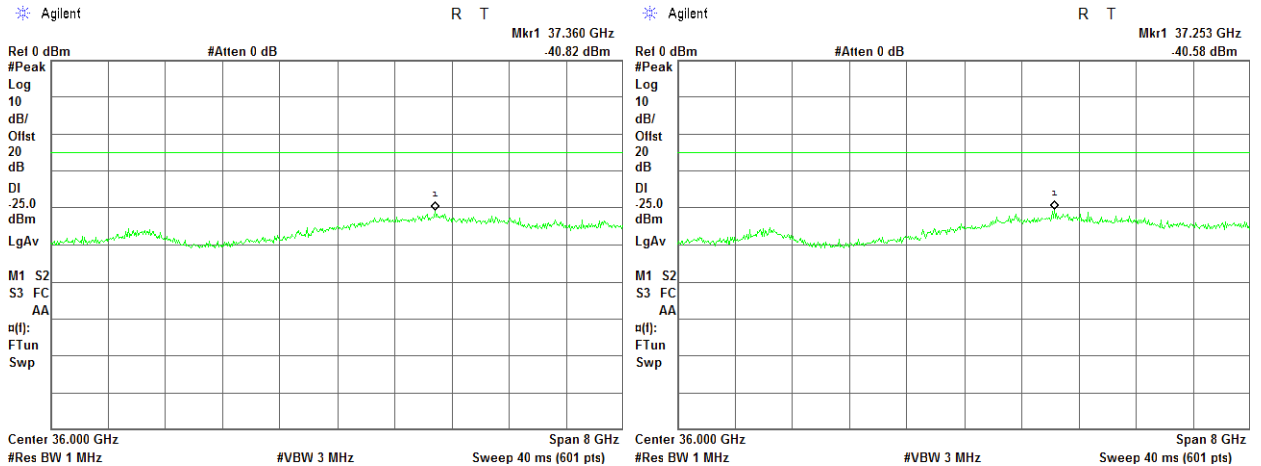



Test specification: Section 90.213, Frequency stability			
Test procedure: 47 CFR, Section 2.1055			
Test mode: Compliance		Verdict: PASS	
Date(s): 03-Jan-24			
Temperature: 23 °C	Relative Humidity: 44 %	Air Pressure: 1016 hPa	Power: 48 VDC
Remarks:			

7.6 Frequency stability test

7.6.1 General

This test was performed to measure frequency stability of transmitter RF carrier. Specification test limits are given in Table 7.6.1.

Table 7.6.1 Frequency stability limits

Assigned frequency, MHz	Maximum allowed frequency displacement	
	ppm	Hz
4945.0	NA	NA
4965.0		NA
4985.0		NA

7.6.2 Test procedure

- 7.6.2.1 The EUT was set up as shown in Figure 7.6.1, energized and its proper operation was checked.
- 7.6.2.2 The EUT power was turned off. Temperature within test chamber was set to +30°C and a period of time sufficient to stabilize all of the oscillator circuit components was allowed.
- 7.6.2.3 The EUT was powered on and carrier frequency was measured at start up moment and then every minute until frequency had been stabilized or 10 minutes elapsed whichever reached the last. The EUT was powered off.
- 7.6.2.4 The above procedure was repeated at 0°C and at the lowest test temperature.
- 7.6.2.5 The EUT was powered on and carrier frequency was measured at start up moment and at the end of stabilization period at the rest of test temperatures and voltages. The EUT was powered off.
- 7.6.2.6 Frequency displacement was calculated and compared with the limit as provided in Table 7.6.2.

Figure 7.6.1 Frequency stability test setup

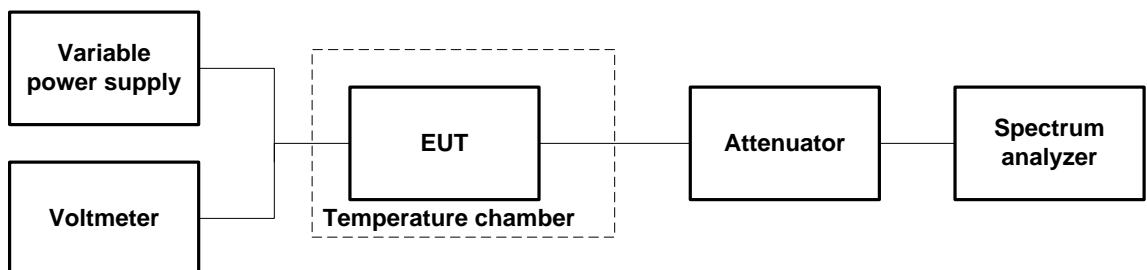



HERMON LABORATORIES

Test specification: Section 90.213, Frequency stability			
Test procedure: 47 CFR, Section 2.1055			
Test mode: Compliance		Verdict: PASS	
Date(s): 03-Jan-24			
Temperature: 23 °C	Relative Humidity: 44 %	Air Pressure: 1016 hPa	Power: 48 VDC
Remarks:			

Table 7.6.2 Frequency stability test results

OPERATING FREQUENCY: 4940.0 – 4990.0 MHz
 NOMINAL POWER VOLTAGE: 48 VDC
 TEMPERATURE STABILIZATION PERIOD: 20 min
 POWER DURING TEMPERATURE TRANSITION: Off
 SPECTRUM ANALYZER MODE: Counter
 RESOLUTION BANDWIDTH: 1 Hz
 VIDEO BANDWIDTH: 3 kHz
 MODULATION: Unmodulated

T, °C	Voltage, VDC	Frequency, MHz						Max frequency drift, Hz		Max frequency drift, ppm		
		Start up	1st min	2nd min	3rd min	4th min	5th min	10th min	Positive	Negative	Positive	Negative
Low channel 4945 MHz												
-30	nominal	4945006202.107	4945006202.140	4945006202.318	4945006202.352	4945006202.400	4945006202.331	4945006202.408	N/A	-5.473	N/A	N/A
-20	nominal	4945006198.859	NA	NA	NA	NA	NA	4945006199.632	N/A	-2.753	N/A	N/A
-10	nominal	4945006197.405	NA	NA	NA	NA	NA	4945006197.806	N/A	-0.927	N/A	N/A
0	nominal	4945006196.295	4945006196.385	4945006196.391	4945006195.363	4945006196.234	4945006196.598	4945006196.261	1.516	N/A	N/A	N/A
10	nominal	4945006194.494	NA	NA	NA	NA	NA	4945006194.777	2.385	N/A	N/A	N/A
20	55.2	4945006197.010	NA	NA	NA	NA	NA	4945006196.870	0.009	-0.131	N/A	N/A
20	48.0	4945006197.053	NA	NA	NA	NA	NA	4945006196.879*	0.000	-0.174	N/A	N/A
20	40.8	4945006197.012	NA	NA	NA	NA	NA	4945006196.862	0.017	-0.133	N/A	N/A
30	nominal	4945006195.928	4945006195.872	4945006195.936	4945006195.944	4945006195.828	4945006195.669	4945006195.421	1.458	N/A	N/A	N/A
40	nominal	4945006195.082	NA	NA	NA	NA	NA	4945006184.926	11.953	N/A	N/A	N/A
50	nominal	4945006194.919	4945006194.758	4945006194.829	4945006194.821	4945006194.746	4945006194.730	4945006194.506	2.373	N/A	N/A	N/A
Mid Channel 4965 MHz												
-30	nominal	4965006212.048	4965006212.009	4965006212.065	4965006211.995	4965006211.961	4965006211.996	4965006212.205	3.893	N/A	N/A	N/A
-20	nominal	4965006210.343	NA	NA	NA	NA	NA	4965006210.452	3.545	N/A	N/A	N/A
-10	nominal	4965006208.785	NA	NA	NA	NA	NA	4965006208.483	7.405	N/A	N/A	N/A
0	nominal	4965006207.464	4965006207.138	4965006206.924	4965006207.042	4965006207.523	4965006207.071	4965006207.110	8.964	N/A	N/A	N/A
10	nominal	4965006205.900	NA	NA	NA	NA	NA	4965006206.201	9.988	N/A	N/A	N/A
20	55.2	4965006220.781	NA	NA	NA	NA	NA	4965006215.376	0.512	-4.893	N/A	N/A
20	48.0	4965006223.508	NA	NA	NA	NA	NA	4965006215.888*	0.000	-7.620	N/A	N/A
20	40.8	4965006221.378	NA	NA	NA	NA	NA	4965006215.595	0.293	-5.490	N/A	N/A
30	nominal	4965006210.420	4965006210.244	4965006210.431	4965006210.189	4965006210.142	4965006210.146	4965006209.569	6.319	N/A	N/A	N/A
40	nominal	4965006207.734	NA	NA	NA	NA	NA	4965006207.269	8.619	N/A	N/A	N/A
50	nominal	4965006205.932	4965006205.893	4965006205.719	4965006205.810	4965006205.788	4965006205.835	4965006205.664	10.224	N/A	N/A	N/A
High channel 4985 MHz												
-30	nominal	4985006211.107	4985006211.112	4985006211.054	4985006211.031	4985006211.074	4985006211.047	4985006211.289	N/A	-7.894	N/A	N/A
-20	nominal	4985006209.785	NA	NA	NA	NA	NA	4985006209.404	N/A	-6.390	N/A	N/A
-10	nominal	4985006207.625	NA	NA	NA	NA	NA	4985006207.411	N/A	-4.230	N/A	N/A
0	nominal	4985006205.879	4985006206.553	4985006206.35	4985006206.970	4985006205.811	4985006206.094	4985006206.010	N/A	-3.575	N/A	N/A
10	nominal	4985006204.625	NA	NA	NA	NA	NA	4985006204.474	N/A	-1.230	N/A	N/A
20	55.2	4985006203.914	NA	NA	NA	NA	NA	4985006203.303	0.092	-0.519	N/A	N/A
20	48.0	4985006203.782	NA	NA	NA	NA	NA	4985006203.395*	0.000	-0.387	N/A	N/A
20	40.8	4985006203.633	NA	NA	NA	NA	NA	4985006203.444	N/A	-0.238	N/A	N/A
30	nominal	4985006202.686	4985006202.691	4985006202.649	4985006202.655	4985006202.500	4985006202.577	4985006202.511	0.895	N/A	N/A	N/A
40	nominal	4985006201.922	NA	NA	NA	NA	NA	4985006201.868	1.527	N/A	N/A	N/A
50	nominal	4985006201.500	4985006201.439	4985006201.441	4985006201.369	4985006201.397	4985006201.289	4985006201.239	2.156	N/A	N/A	N/A

* - Reference frequency

Note1: As no limit is specified by the applicable rule for 4940.0 – 4990.0 MHz band the test results are given in Table above for information purpose only.

Reference numbers of test equipment used

HL 3230	HL 5376	HL 5391	HL 5933			
---------	---------	---------	---------	--	--	--

Full description is given in Appendix A.



Test specification: FCC 47 CFR, Section 15.107, Conducted emissions			
Test procedure: ANSI C63.4, Section 7.3			
Test mode: Compliance		Verdict: PASS	
Date(s): 07-Jan-24			
Temperature: 23 °C	Relative Humidity: 48 %	Air Pressure: 1014 hPa	Power: 48 VDC
Remarks:			

8 Emissions tests according to 47CFR part 15 subpart B requirements

8.1 Conducted emissions

8.1.1 General

This test was performed to measure common mode conducted emissions at the mains power port. Specification test limits are given in Table 8.1.1. The worst test results (the lowest margins) were recorded in Table 8.1.2 and shown in the associated plots.

Table 8.1.1 Limits for conducted emissions

Frequency, MHz	Class B limit, dB(μV)		Class A limit, dB(μV)	
	QP	AVRG	QP	AVRG
0.15 - 0.5	66 - 56*	56 - 46*	79	66
0.5 - 5.0	56	46	73	60
5.0 - 30	60	50	73	60

* The limit decreases linearly with the logarithm of frequency.

8.1.2 Test procedure

- 8.1.2.1 The EUT was set up as shown in Figure 8.1.1 and associated photographs, energized and the performance check was conducted.
- 8.1.2.2 The measurements were performed at power terminals with the LISN, connected to a spectrum analyzer in the frequency range referred to in Table 8.1.2. Unused coaxial connector of the LISN was terminated with 50 Ohm. Quasi-peak and average detectors were used throughout the testing.
- 8.1.2.3 The position of the device cables was varied to determine maximum emission level.



Test specification: FCC 47 CFR, Section 15.107, Conducted emissions			
Test procedure: ANSI C63.4, Section 7.3			
Test mode: Compliance		Verdict: PASS	
Date(s): 07-Jan-24			
Temperature: 23 °C	Relative Humidity: 48 %	Air Pressure: 1014 hPa	Power: 48 VDC
Remarks:			

Figure 8.1.1 Setup for conducted emission measurements, table-top equipment

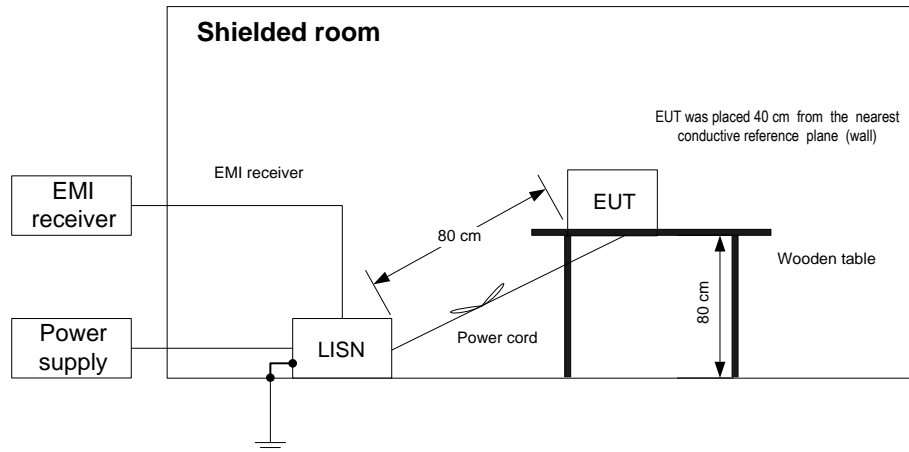



Test specification: FCC 47 CFR, Section 15.107, Conducted emissions			
Test procedure: ANSI C63.4, Section 7.3			
Test mode: Compliance		Verdict: PASS	
Date(s): 07-Jan-24			
Temperature: 23 °C	Relative Humidity: 48 %	Air Pressure: 1014 hPa	Power: 48 VDC
Remarks:			

Table 8.1.2 Conducted emission test results

LINE: AC mains
LIMIT: Class B
EUT OPERATING MODE: Stand-by
EUT SET UP: TABLE-TOP
TEST SITE: SHIELDED ROOM
DETECTORS USED: PEAK / QUASI-PEAK / AVERAGE
FREQUENCY RANGE: 150 kHz - 30 MHz
RESOLUTION BANDWIDTH: 9 kHz

Frequency, MHz	Peak emission, dB(µV)	Quasi-peak			Average			Line ID	Verdict
		Measured emission, dB(µV)	Limit, dB(µV)	Margin, dB*	Measured emission, dB(µV)	Limit, dB(µV)	Margin, dB*		
No emission found								L1	Pass
No emission found								L2	Pass

*- Margin = Measured emission - specification limit.

Reference numbers of test equipment used

HL 3016	HL 3230	HL 5558	HL 5707	HL 5937	HL 7546		
---------	---------	---------	---------	---------	---------	--	--

Full description is given in Appendix A.



HERMON LABORATORIES

Test specification: FCC 47 CFR, Section 15.107, Conducted emissions			
Test procedure: ANSI C63.4, Section 7.3			
Test mode: Compliance		Verdict: PASS	
Date(s): 07-Jan-24			
Temperature: 23 °C	Relative Humidity: 48 %	Air Pressure: 1014 hPa	Power: 48 VDC
Remarks:			

Plot 8.1.1 Conducted emission measurements

LINE: L1
LIMIT: Class B
EUT OPERATING MODE: Stand-by
LIMIT: QUASI-PEAK, AVERAGE
DETECTOR: PEAK

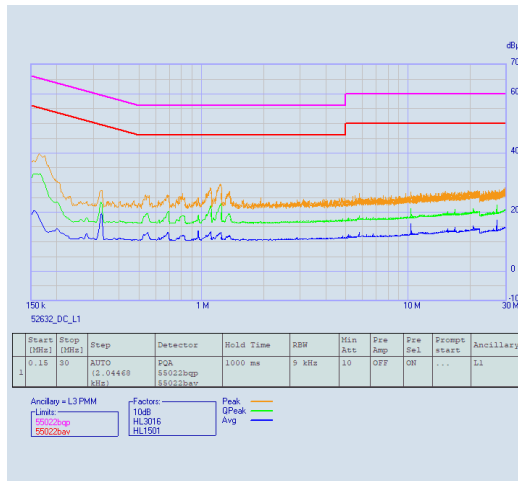

Plot 8.1.2 Conducted emission measurements

LINE: L2
LIMIT: Class B
EUT OPERATING MODE: Stand-by
LIMIT: QUASI-PEAK, AVERAGE
DETECTOR: PEAK

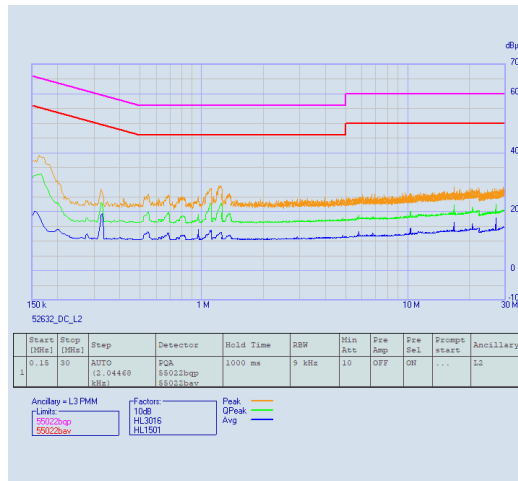



Test specification: FCC 47 CFR, Section 15.109, Radiated emissions			
Test procedure: ANSI C63.4, Section 8.3			
Test mode: Compliance		Verdict: PASS	
Date(s): 03-Jan-24			
Temperature: 23 °C	Relative Humidity: 44 %	Air Pressure: 1016 hPa	Power: 48 VDC
Remarks:			

8.2 Radiated emission measurements

8.2.1 General

This test was performed to measure radiated emissions from the EUT enclosure. Specification test limits are given in Table 8.2.1.

Table 8.2.1 Radiated emission test limits

Frequency, MHz	Class B limit, dB(μV/m)		Class A limit, dB(μV/m)	
	10 m distance	3 m distance	10 m distance	3 m distance
30 - 88	29.5*	40.0	39.0	49.5*
88 - 216	33.0*	43.5	43.5	54.0*
216 - 960	35.5*	46.0	46.4	56.9*
Above 960	43.5*	54.0	49.5	60.0*

* The limit for test distance other than specified was calculated using the inverse linear distance extrapolation factor as follows: $Lims_2 = Lims_1 + 20 \log(S_1/S_2)$, where S_1 and S_2 – standard defined and test distance respectively in meters.

8.2.2 Test procedure for measurements in semi-anechoic chamber

8.2.2.1 30 – 1000 MHz range. The EUT was set up as shown in Figure 8.2.1 and the associated photograph/s, energized and the EUT performance was checked.

8.2.2.2 The measurements were performed in the anechoic chamber at 3 m test distance. The specified frequency range was investigated with the antenna connected to the EMI receiver. To find the highest emission the turntable was rotated 360° and the measuring antenna height was swept from 1 to 4 m in both, vertical and horizontal polarizations. The EUT cables position was varied to maximize emission.

8.2.2.3 1000 – 40000 MHz range. The EUT was set up as shown in Figure 8.2.2 and the associated photograph/s, energized and the EUT performance was checked.

8.2.2.4 The measurements were performed in the semi anechoic chamber at 3 m test distance. The specified frequency range was investigated with the antenna connected to the EMI receiver. To find the highest emission the turntable was rotated 360° and the measuring antenna height was swept from 1 to 4 m in both, vertical and horizontal polarizations. In order to stay within the 3 dB beamwidth while keeping the antenna height scanned from 1 to 4 m, a few sweeps with different antenna angles over the entire height were performed.

8.2.2.5 The worst test results with respect to the limits were recorded in Table 8.2.2 and shown in the associated plots.



Test specification: FCC 47 CFR, Section 15.109, Radiated emissions			
Test procedure: ANSI C63.4, Section 8.3			
Test mode: Compliance		Verdict: PASS	
Date(s): 03-Jan-24			
Temperature: 23 °C	Relative Humidity: 44 %	Air Pressure: 1016 hPa	Power: 48 VDC
Remarks:			

Figure 8.2.1 Setup for radiated emission measurements in anechoic chamber, table-top equipment

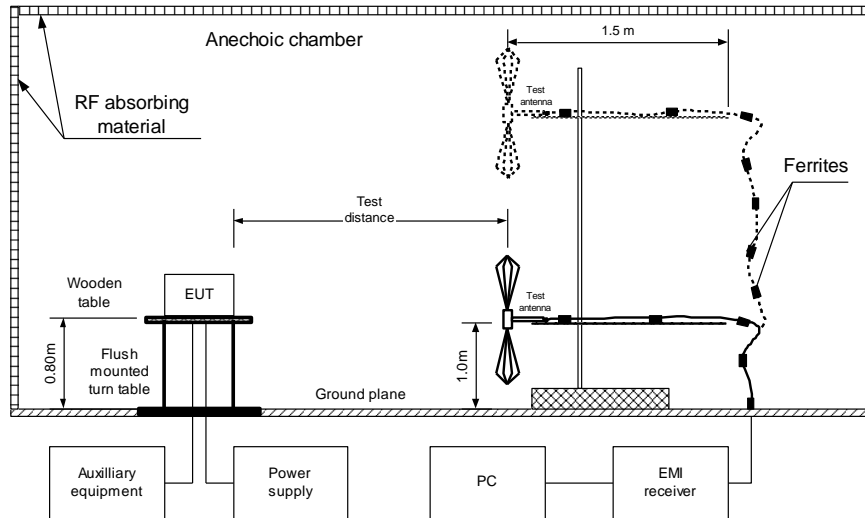
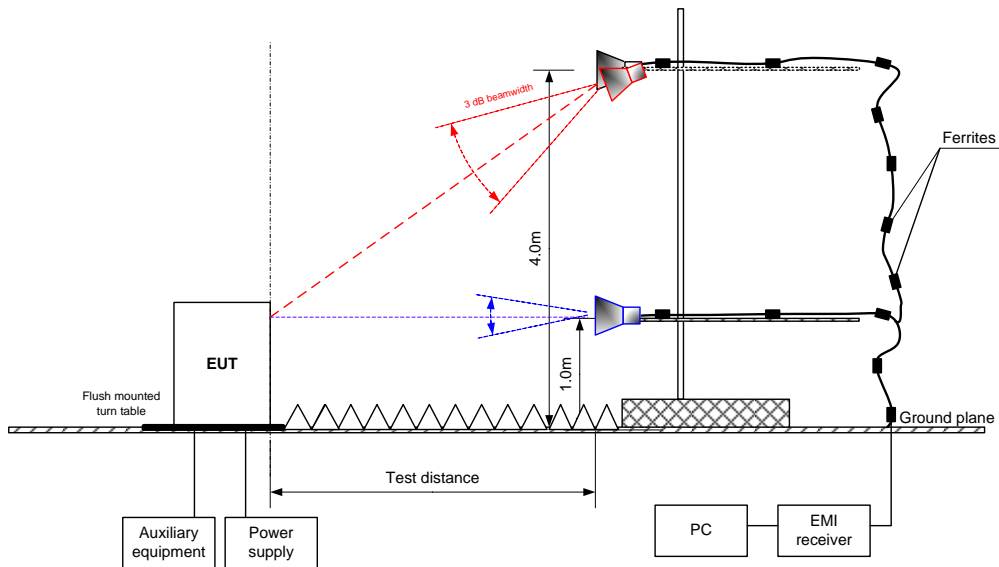

Figure 8.2.2 Setup for radiated emission measurements in 1000 – 40000 MHz range, floor standing EUT





Test specification: FCC 47 CFR, Section 15.109, Radiated emissions			
Test procedure: ANSI C63.4, Section 8.3			
Test mode: Compliance		Verdict: PASS	
Date(s): 03-Jan-24			
Temperature: 23 °C	Relative Humidity: 44 %	Air Pressure: 1016 hPa	Power: 48 VDC
Remarks:			

Table 8.2.2 Radiated emission test results

EUT SET UP: TABLE-TOP
LIMIT: Class B
EUT OPERATING MODE: Stand-by
TEST SITE: SEMI ANECHOIC CHAMBER
TEST DISTANCE: 3 m
DETECTORS USED: PEAK / QUASI-PEAK
FREQUENCY RANGE: 30 MHz – 1000 MHz
RESOLUTION BANDWIDTH: 120 kHz

Frequency, MHz	Peak emission, dB(µV/m)	Quasi-peak			Antenna polarization	Antenna height, m	Turn-table position**, degrees	Verdict
		Measured emission, dB(µV/m)	Limit, dB(µV/m)	Margin, dB*				
90.493	33.45	28.51	43.50	-14.99	Vertical	1.02	-70	Pass
100.487	33.20	30.72	43.50	-12.78	Vertical	1.00	-134	
236.191	35.39	31.44	46.00	-14.56	Vertical	1.02	-137	
325.023	37.39	33.29	46.00	-12.71	Vertical	1.00	-120	
434.256	36.89	32.97	46.00	-13.03	Vertical	1.02	24	
521.547	31.49	24.89	46.00	-21.11	Vertical	1.02	41	

TEST SITE: SEMI ANECHOIC CHAMBER
TEST DISTANCE: 3 m
DETECTORS USED: PEAK / AVERAGE
FREQUENCY RANGE: 1000 MHz – 25000 MHz
RESOLUTION BANDWIDTH: 1000 kHz

Frequency, MHz	Peak			Average			Antenna polarization	Antenna height, m	Turn-table position**, degrees	Verdict
	Measured emission, dB(µV/m)	Limit, dB(µV/m)	Margin, dB*	Measured emission, dB(µV/m)	Limit, dB(µV/m)	Margin, dB*				
1040.175	44.01	74.00	-29.99	41.25	54.00	-12.75	Vertical	1.04	-170	Pass
1624.907	36.19	74.00	-37.81	27.94	54.00	-26.06	Vertical	1.88	-8	
1933.190	38.59	74.00	-35.41	24.30	54.00	-29.70	Vertical	1.00	180	
2125.212	35.48	74.00	-38.52	25.25	54.00	-28.75	Horizontal	2.09	136	

*- Margin = Measured emission - specification limit.
**- EUT front panel refer to 0 degrees position of turntable.

Reference numbers of test equipment used

HL 3230	HL 3903	HL 4015	HL 4933	HL 4956	HL 5112	HL 5288	HL 5902
HL 7585							

Full description is given in Appendix A.