



Hermon Laboratories Ltd.
P.O. Box 23, Binyamina 3055001, Israel
Tel. +972 4628 8001
Fax. +972 4628 8277
E-mail: mail@hermonlabs.com

TEST REPORT

ACCORDING TO: FCC 47CFR part 96

FOR:

Airspan Networks Inc.
LTE Base Station Radio
Model: AirSpeed AS1030, 3.550-3.700 GHz (B48)
FCC ID: PIDAS1030

This report is in conformity with ISO/IEC 17025. The "A2LA Accredited" symbol endorsement applies only to the tests and calibrations that are listed in the scope of Hermon Laboratories accreditation. The test results relate only to the items tested.
This test report shall not be reproduced in any form except in full with the written approval of Hermon Laboratories Ltd.



Table of contents

1	Applicant information	3
2	Equipment under test attributes.....	3
3	Manufacturer information.....	3
4	Test details	3
5	Tests summary.....	4
6	EUT description.....	5
6.1	General information.....	5
6.2	Ports and lines	5
6.3	Support and test equipment.....	5
6.4	Changes made in the EUT.....	5
6.5	Test configuration.....	6
6.6	Transmitter characteristics.....	7
7	Transmitter tests according to 47CFR part 96.....	9
7.1	Maximum EIRP and maximum power spectral density.....	9
7.2	Peak-to-average power ratio (PAPR) test.....	37
7.3	Occupied bandwidth test.....	45
7.4	Emission outside the fundamental test	59
7.5	Radiated spurious emission measurements.....	90
7.6	Spurious emissions at RF antenna connector test	101
7.7	Frequency stability test.....	153
8	APPENDIX A Test equipment and ancillaries used for tests.....	155
9	APPENDIX B Test equipment correction factors.....	156
10	APPENDIX C Measurement uncertainties	163
11	APPENDIX D Test laboratory description	164
12	APPENDIX E Specification references	164
13	APPENDIX F Manufacturer's declaration of additional to be used antennas	165
14	APPENDIX G Abbreviations and acronyms.....	166

1 Applicant information

Client name: Airspan Networks Inc.
Address: 777 Yamato, Road Suite 310 Boca Raton, FL 33431, USA
Telephone: +1 561 893 8670
Fax: +1 561 893 8671
E-mail: zlevi@airspan.com
Contact name: Mr. Zion Levi

2 Equipment under test attributes

Product name: LTE Base Station Radio
Product type: Transceiver
Model(s): AirSpeed AS1030, 3.550-3.700 GHz (B48)
Serial number: E85A4572871A
Part number: AS103-U48-B03DP
Hardware version: 04
Software release: SR17.50
Receipt date: 15-Mar-20

3 Manufacturer information

Manufacturer name: Airspan Networks Inc.
Address: 777 Yamato, Road Suite 310 Boca Raton, FL 33431, USA
Telephone: +1 561 893 8670
Fax: +1 561 893 8671
E-Mail: zlevi@airspan.com
Contact name: Mr. Zion Levi

4 Test details

Project ID: 37551
Location: Hermon Laboratories Ltd. P.O. Box 23, Binyamina 3055001, Israel
Test started: 19-Apr-20
Test completed: 27-Jul-20
Test specification(s): FCC 47CFR part 96



5 Tests summary

Test	Status
Transmitter characteristics	
Section 96.41(b), Maximum EIRP and maximum power spectral density	Pass
Section 96.41(g), Peak-to- average power ratio	Pass
Section 2.1049, Occupied bandwidth	Pass
Section 96.41(e), Emission mask	Pass
Section 96.41(e)(2), Radiated spurious emissions	Pass
Section 96.41(e)(3), Conducted spurious emissions	Pass
Section 2.1055, Frequency stability	Pass

This test report supersedes the previously issued test report identified by Doc ID: AIRRAD_FCC.37551_Rev1

Testing was completed against all relevant requirements of the test standard. The results obtained indicate that the product under test complies in full with the requirements tested.
The test results relate only to the items tested. Pass/ fail decision was based on nominal values.

	Name and Title	Date	Signature
Tested by:	Mr. A. Morozov, test engineer, EMC & Radio	19-Apr-20 – 27-Jul-20	
Reviewed by:	Mrs. S. Peysahov Sheynin, test engineer, EMC & Radio	23-Aug-20	
Approved by:	Mr. S. Samokha, technical manager, EMC & Radio	23-Aug-20	

6 EUT description

Note: The following data in this clause is provided by the customer and represents his sole responsibility

6.1 General information

The EUT, Mobile Digital station, AirSpeed 3.55-3.7GHz, Band 48, is part of a LTE broadband fixed cellular wireless access system. The system provides a radio link between an end-user (a subscriber) and a network to give high-speed data access. The AirSpeed's transceiver/receiver (Up to 64 QAM modulation, data rate up to 95 Mbps) equipped with a 17.5 dBi external antenna. Advanced Antenna Techniques 2x2 MIMO are supported. The maximum RF output power (not including antenna gain) is 29.42 dBm for 17.5 dBi and it can be reduced by software. Antennas 1/2 is one sector and antennas 3/4 is another sector.

The AirSpeed is installed outdoors. The Subscriber transmits and receives traffic to and from the base station respectively. The transceiver provides subscribers with "always-on" Internet, high speed data only, or data and voice (VoIP) services and is configured with a unique base station reference number, preventing the LTE UE from relocating to another subscriber premises without authorization.

Note: The AS1030 equipment defined as Category B CBSD (Citizens Broadband Radio Service Device)

Antennas 1/2 arrange one sector while antenna 1 is cross polarized to antenna 2 and antennas 3/4 arrange another sector while antenna 3 is cross polarized to antenna 4. The transmitter output signals are completely uncorrelated. The sectors are either non overlapping by operation on different frequency channels or by different sectors coverage without overlapping of antenna beams.

According to manufacturer's declaration provided in Appendix F of the test report the following specific external antennas may be used in conjunction with this model radio at the appropriate listed power settings.

6.2 Ports and lines

Port type	Port description	Connected from	Connected to	Qty.	Cable type	Cable length, m
Power	DC power	EUT	AC/DC adapter	1	Unshielded	20
Signal	Ethernet	EUT	Laptop	1	Shielded	20
Signal*	Serial*	Not connected	Not connected	1	NA	NA

*for maintenance only

6.3 Support and test equipment

Description	Manufacturer	Model number	Serial number
Laptop	Dell	E7450	8TYRP32
USB to RS-232 convertor	ATEN	UC2324	NA
AC/DC adapter	MW	PSP-600-48	NA

6.4 Changes made in the EUT

No changes were implemented in the EUT during testing.



6.5 Test configuration

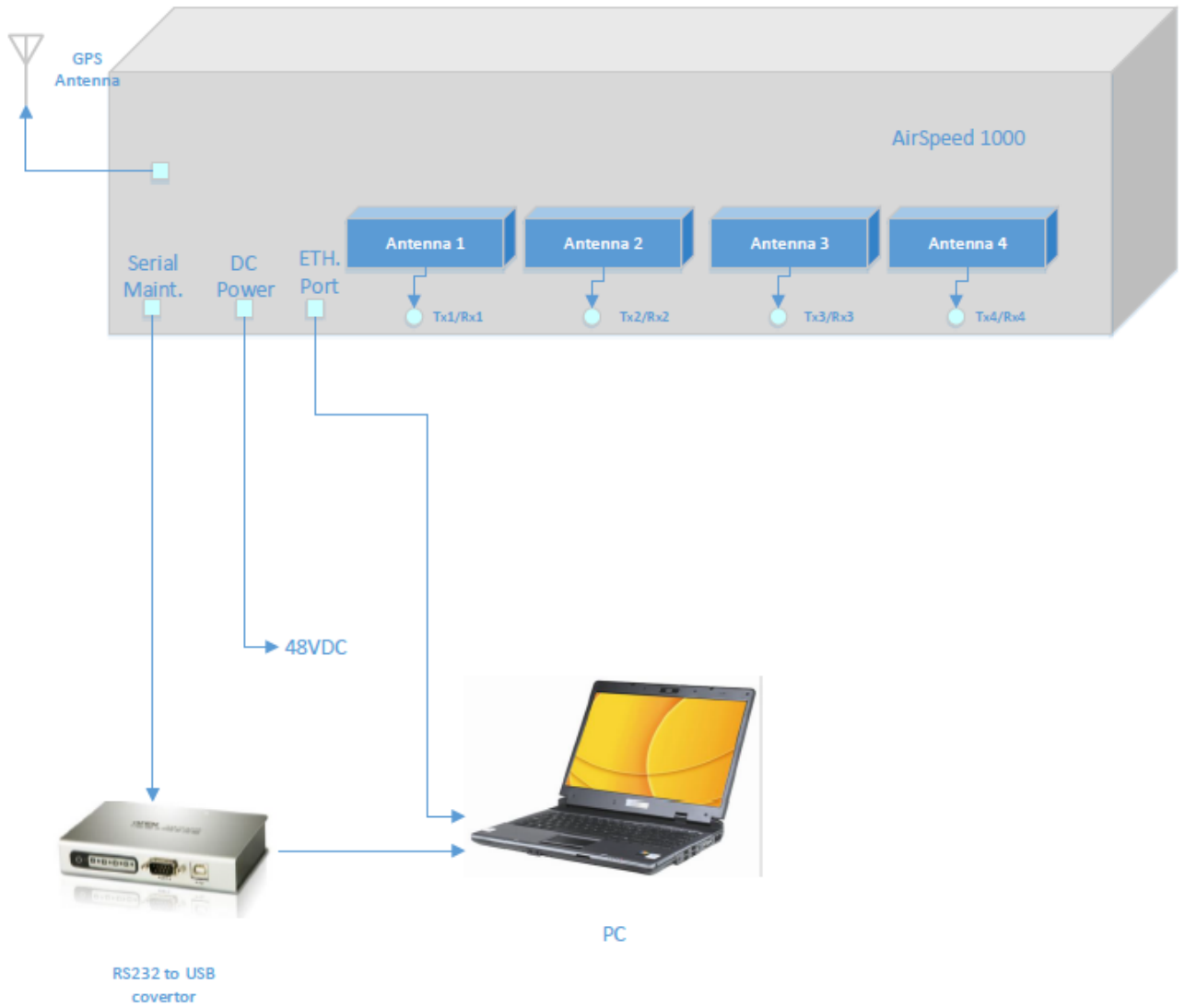



6.6 Transmitter characteristics

Type of equipment					
V	Stand-alone (Equipment with or without its own control provisions)				
	Combined equipment (Equipment where the radio part is fully integrated within another type of equipment)				
	Plug-in card (Equipment intended for a variety of host systems)				
Intended use		Condition of use			
V	fixed	Always at a distance more than 2 m from all people			
	mobile	Always at a distance more than 20 cm from all people			
	portable	May operate at a distance closer than 20 cm to human body			
Assigned frequency range		3550.0 – 3700.0 MHz			
Operating frequency (full bands)		3555.0 – 3695.0 MHz			
RF channel spacing		10 MHz, 20 MHz			
Maximum rated output power		At transmitter 50 Ω RF output connector (per port)	*29.42 dBm		
Is transmitter output power variable?		No			
		V	Yes	continuous variable	
				stepped variable with step size	0.25 dB
				minimum RF power	-30 dBm
		maximum RF power at antenna connector	dBm		
Antenna connection					
unique coupling	V	standard connector	Integral V with temporary RF connector without temporary RF connector		
Antenna/s technical characteristics					
Type	Manufacturer	Model number	Gain		
*External	ALPHA Wireless Ltd.	AW3782	17.5 dBi		
External	ALPHA Wireless Ltd.	AW3014	18 dBi		
External	ALPHA Wireless Ltd.	AW3170	20.5 dBi		
External	Laird Ltd.	HDDA3W-25	25 dBi		
Transmitter aggregate data rate/s, Mbps					
Transmitter 26dBc power bandwidth		Type of modulation			
		QPSK	16QAM	64QAM	
		10 MHz	22.7	47.3	
	20 MHz	45.4	95		
Type of multiplexing		TDD			
Modulating test signal (baseband)		PRBS			
Maximum transmitter duty cycle in normal use		0.74			
Transmitter power source					
V	DC	Nominal rated voltage	Battery type		
	AC mains	Nominal rated voltage	Frequency		
		48 VDC			
Common power source for transmitter and receiver		V	yes no		

* - The worst case of antenna configuration delivering the highest conducted power per port was tested



6.7 Table of calculations for the MAX EIRP at frequency range 3550 – 3700 MHz with different antenna configurations

Antenna configuration	Antenna Vendor	Antenna Model Number	Antenna Peak Gain (dB)	Signal Bandwidth (MHz)	Maximum Conducted Power (dBm)	EIRP (dBm/10MHz)	EIRP per Bandwidth (dBm)	Operational Category
1*	ALPHA	AW3782	17.5	10.0	27.36	44.86	44.86	B
				20.0	29.42	44.40	46.92	
2	ALPHA	AW3014	18.0	10.0	26.86	44.86	44.86	B
				20.0	28.92	44.40	46.92	
3	ALPHA	AW3170	20.5	10.0	24.36	44.86	44.86	B
				20.0	26.42	44.40	46.92	
4	Laird	HDDA3W-25	25.0	10.0	19.86	44.86	44.86	B
				20.0	21.92	44.40	46.92	

* - The worst case of antenna configuration delivering the highest conducted power was tested.



Test specification: Section 96.41(b), Maximum EIRP and maximum power spectral density			
Test procedure: Section 96.41(e)(3)			
Test mode: Compliance		Verdict: PASS	
Date(s): 22-Apr-20			
Temperature: 24 °C	Relative Humidity: 55 %	Air Pressure: 1011 hPa	Power: 48 VDC
Remarks:			

7 Transmitter tests according to 47CFR part 96

7.1 Maximum EIRP and maximum power spectral density

7.1.1 General

This test was performed to measure the maximum EIRP and maximum spectral power density at the transmitter RF antenna connector. Specification test limits are given in Table 7.1.1, Table 7.1.2.

Table 7.1.1 Maximum EIRP limits

Assigned frequency range, MHz	EIRP
	dBm/10 MHz
3550 - 3700	47.0

Table 7.1.2 Peak spectral power density limits

Assigned frequency range, MHz	Measurement bandwidth, MHz	Peak spectral power density, dBm
3550 - 3700	1.0	37.0

7.1.2 Test procedure

7.1.2.1 The EUT was set up as shown in Figure 7.1.1, energized and its proper operation was checked.

7.1.2.2 The EUT was adjusted to produce maximum available to end user RF output power.

7.1.2.3 The frequency span of spectrum analyzer was set to capture the entire 6 dB band of the transmitter, in average mode with resolution bandwidth set to 1.0 MHz, video bandwidth wider than resolution bandwidth, sweep time and sufficient number of sweeps was allowed for trace stabilization.

7.1.2.4 Spectrum analyzer was set in average mode, sufficient number of sweeps was allowed for trace stabilization and peak spectral power density was measured as provided in Table 7.1.3, Table 7.1.4 and the associated plots.

Figure 7.1.1 Maximum EIRP and power spectral density test setup

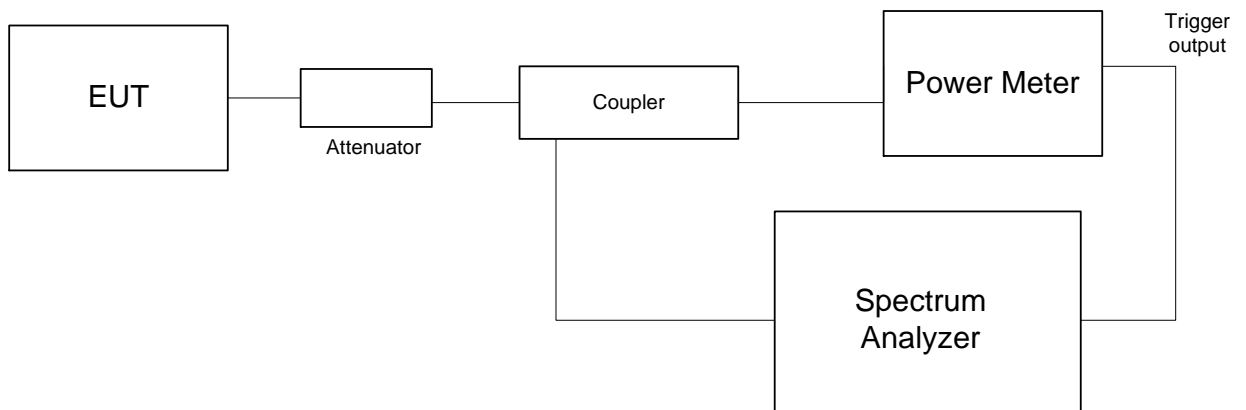



Test specification: Section 96.41(b), Maximum EIRP and maximum power spectral density			
Test procedure: Section 96.41(e)(3)			
Test mode: Compliance		Verdict: PASS	
Date(s): 22-Apr-20			
Temperature: 24 °C	Relative Humidity: 55 %	Air Pressure: 1011 hPa	Power: 48 VDC
Remarks:			

Table 7.1.3 Maximum EIRP test results

ASSIGNED FREQUENCY RANGE: 3550.0 – 3700.0 MHz
 DETECTOR USED: Average (gated)
 VIDEO BANDWIDTH: ≥ Resolution bandwidth
 CHANNEL SPACING: 10 MHz

Frequency, MHz	RF Output power				Antenna gain, dBi	EIRP*, dBm/10 MHz	Limit, dBm/10 MHz	Margin, dB**	Verdict
	Chain RF#1, dBm	Chain RF#2, dBm	Chain RF#3, dBm	Chain RF#4, dBm					
Modulation QPSK									
3555.0	27.00	26.80	26.84	26.79	17.5	44.50	47.0	-2.50	Pass
3625.0	27.26	26.97	27.17	27.01	17.5	44.76	47.0	-2.24	Pass
3695.0	27.13	27.01	27.13	26.76	17.5	44.63	47.0	-2.37	Pass
Modulation 16QAM									
3555.0	26.10	26.47	25.91	26.19	17.5	43.69	47.0	-3.31	Pass
3625.0	26.17	26.63	26.08	26.07	17.5	44.13	47.0	-2.87	Pass
3695.0	26.28	26.59	26.23	26.02	17.5	43.78	47.0	-3.22	Pass
Modulation 64QAM									
3555.0	27.03	26.72	26.84	27.01	17.5	44.53	47.0	-2.47	Pass
3625.0	27.29	27.05	26.81	27.08	17.5	44.79	47.0	-2.21	Pass
3695.0	27.36	26.99	27.04	26.79	17.5	44.86	47.0	-2.14	Pass

* - EIRP = Max SA reading (Chains #1&2 and #3&4) + Antenna gain: The transmitter output signal are completely uncorrelated, antennas 1/2 is one sector and antennas 3/4 is another sector.

** - Margin = EIRP, dBm – specification limit.

CHANNEL SPACING: 20 MHz

Frequency, MHz	RF Output power				Antenna gain, dBi	EIRP*, dBm/20 MHz	EIRP*, dBm/10 MHz	Limit, dBm/10 MHz	Margin, dB**	Verdict
	Chain RF#1, dBm	Chain RF#2, dBm	Chain RF#3, dBm	Chain RF#4, dBm						
Modulation QPSK										
3560.0	29.33	28.81	29.17	29.42	17.5	46.92	44.40	47.0	-2.60	Pass
3625.0	28.54	28.49	28.20	28.32	17.5	46.04	43.52	47.0	-3.48	Pass
3690.0	28.47	28.36	28.50	28.29	17.5	46.00	43.48	47.0	-3.52	Pass
Modulation 16QAM										
3560.0	29.34	29.14	29.20	29.08	17.5	46.84	44.32	47.0	-2.68	Pass
3625.0	28.72	28.67	28.62	28.56	17.5	46.22	43.70	47.0	-3.30	Pass
3690.0	28.99	28.59	28.67	28.69	17.5	46.49	43.97	47.0	-3.03	Pass
Modulation 64QAM										
3560.0	29.00	29.03	29.23	29.16	17.5	46.73	44.21	47.0	-2.79	Pass
3625.0	28.50	28.67	28.49	28.66	17.5	46.17	43.65	47.0	-3.35	Pass
3690.0	28.46	28.45	28.70	28.68	17.5	46.20	43.68	47.0	-3.32	Pass

* - EIRP = Max SA reading (Chains #1&2 and #3&4) - 10*log[OBW(MHz) / 10 MHz] + Antenna gain = Max SA reading – 2.52 dB + Antenna gain: The transmitter output signal are completely uncorrelated, antennas 1/2 is one sector and antennas 3/4 is another sector.

** - Margin = EIRP, dBm – specification limit.



Test specification: Section 96.41(b), Maximum EIRP and maximum power spectral density			
Test procedure: Section 96.41(e)(3)			
Test mode: Compliance		Verdict: PASS	
Date(s): 22-Apr-20			
Temperature: 24 °C	Relative Humidity: 55 %	Air Pressure: 1011 hPa	Power: 48 VDC
Remarks:			

Table 7.1.4 Peak spectral power density test results

ASSIGNED FREQUENCY RANGE: 3550.0 – 3700.0 MHz
 DETECTOR USED: Average (gated)
 VIDEO BANDWIDTH: ≥ Resolution bandwidth
 NUMBER OF CHAINS: 4

Frequency, MHz	SA Reading, dBm/MHz				Antenna gain, dBi	Total PSD*, dBm/ MHz	Limit, dBm/MHz	Margin, dB	Verdict
	Chain RF#1,	Chain RF#2,	Chain RF#3,	Chain RF#4,					
Channel spacing 10 MHz									
Modulation QPSK									
3555.0	17.74	17.74	17.66	17.52	17.5	36.91	37.0	-0.09	Pass
3625.0	17.67	17.54	17.56	17.71	17.5	36.88	37.0	-0.12	Pass
3695.0	17.76	17.70	17.71	17.63	17.5	36.93	37.0	-0.07	Pass
Modulation 16QAM									
3555.0	17.60	17.67	17.55	17.64	17.5	36.84	37.0	-0.16	Pass
3625.0	17.66	17.64	17.74	17.40	17.5	36.91	37.0	-0.09	Pass
3695.0	17.59	17.63	17.67	17.71	17.5	36.88	37.0	-0.12	Pass
Modulation 64QAM									
3555.0	17.46	17.54	17.70	17.73	17.5	36.90	37.0	-0.10	Pass
3625.0	17.57	17.43	17.71	17.54	17.5	36.88	37.0	-0.12	Pass
3695.0	17.76	17.75	17.76	17.80	17.5	36.97	37.0	-0.03	Pass
Channel spacing 20 MHz									
Modulation QPSK									
3560.0	17.61	17.58	17.67	17.79	17.5	36.99	37.0	-0.01	Pass
3625.0	17.59	17.77	17.72	17.69	17.5	36.97	37.0	-0.03	Pass
3690.0	17.76	17.77	17.61	17.71	17.5	36.97	37.0	-0.03	Pass
Modulation 16QAM									
3560.0	17.74	17.60	17.63	17.55	17.5	36.94	37.0	-0.06	Pass
3625.0	17.78	17.72	17.76	17.70	17.5	36.98	37.0	-0.02	Pass
3690.0	17.72	17.66	17.48	17.77	17.5	36.97	37.0	-0.03	Pass
Modulation 64QAM									
3560.0	17.69	17.77	17.75	17.70	17.5	36.97	37.0	-0.03	Pass
3625.0	17.79	17.60	17.74	17.77	17.5	36.99	37.0	-0.01	Pass
3690.0	17.63	17.70	17.57	17.76	17.5	36.96	37.0	-0.04	Pass

* - Total PSD = Max SA reading (Chains #1&2 or chains #3&4) + Antenna Gain: The transmitter output signal are completely uncorrelated, antennas 1/2 is one sector and antennas 3/4 is another sector.

** - Margin = Total PSD, dBm – specification limit.

Reference numbers of test equipment used

HL 2909	HL 5409	HL 4366	HL 3301	HL 3302	HL 5376	HL 3901	
---------	---------	---------	---------	---------	---------	---------	--

Full description is given in Appendix A.



HERMON LABORATORIES

Test specification: Section 96.41(b), Maximum EIRP and maximum power spectral density	
Test procedure: Section 96.41(e)(3)	
Test mode: Compliance	Verdict: PASS
Date(s): 22-Apr-20	
Temperature: 24 °C	Relative Humidity: 55 %
Air Pressure: 1011 hPa	Power: 48 VDC
Remarks:	

Plot 7.1.1 Peak spectral power density at low frequency

CHANNEL SPACING:
ANTENNA CHAIN:
Modulation: QPSK

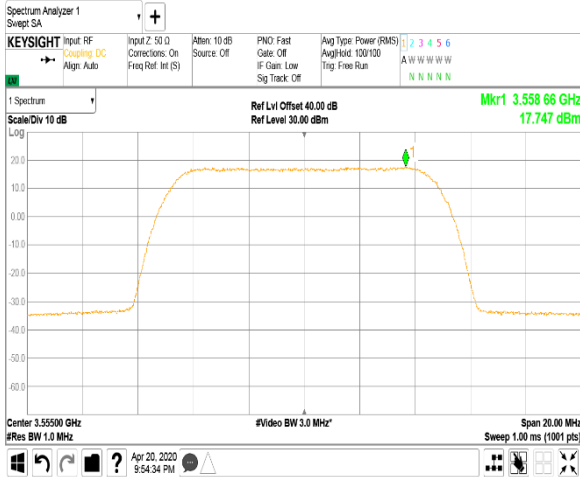

10 MHz
1
Modulation: 16QAM

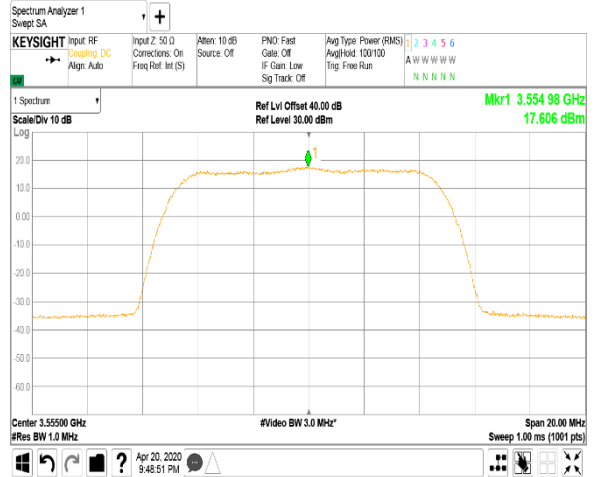

Modulation: 64QAM

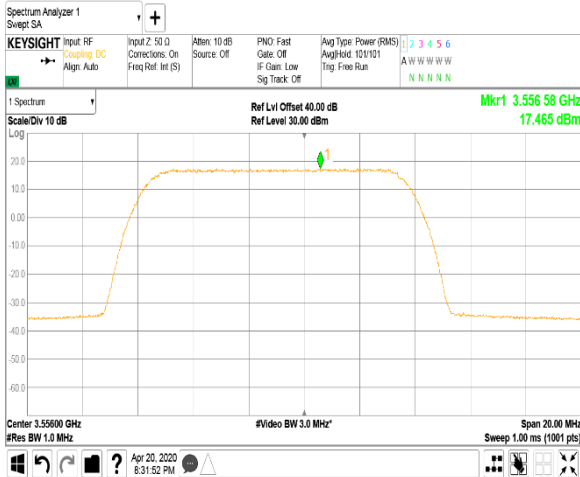



HERMON LABORATORIES

Test specification: Section 96.41(b), Maximum EIRP and maximum power spectral density	
Test procedure: Section 96.41(e)(3)	
Test mode: Compliance	Verdict: PASS
Date(s): 22-Apr-20	
Temperature: 24 °C	Relative Humidity: 55 %
Air Pressure: 1011 hPa	Power: 48 VDC
Remarks:	

Plot 7.1.2 Peak spectral power density at mid frequency

CHANNEL SPACING:
ANTENNA CHAIN:
Modulation: QPSK

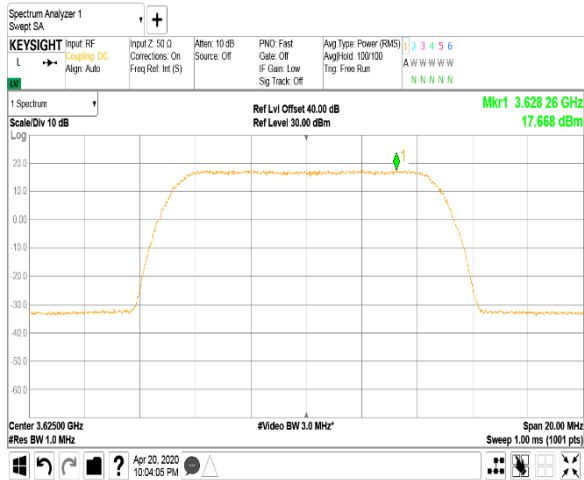

10 MHz
1
Modulation: 16QAM

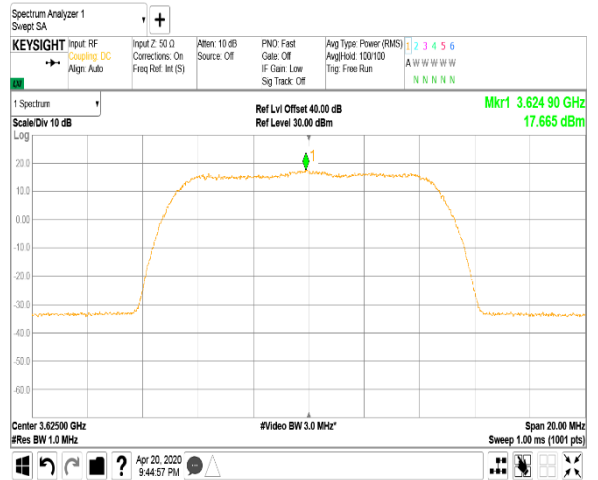

Modulation: 64QAM

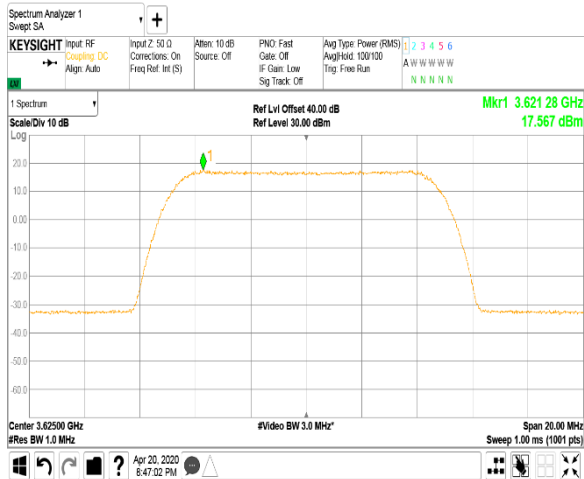



HERMON LABORATORIES

Test specification: Section 96.41(b), Maximum EIRP and maximum power spectral density	
Test procedure: Section 96.41(e)(3)	
Test mode: Compliance	Verdict: PASS
Date(s): 22-Apr-20	
Temperature: 24 °C	Relative Humidity: 55 %
Air Pressure: 1011 hPa	Power: 48 VDC
Remarks:	

Plot 7.1.3 Peak spectral power density at high frequency

CHANNEL SPACING:
ANTENNA CHAIN:
Modulation: QPSK

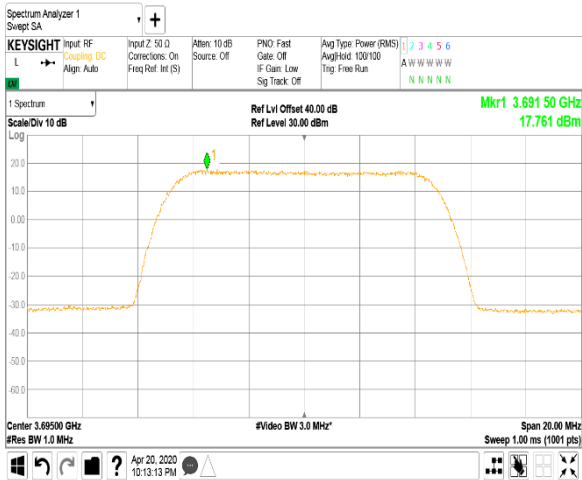

10 MHz
1
Modulation: 16QAM

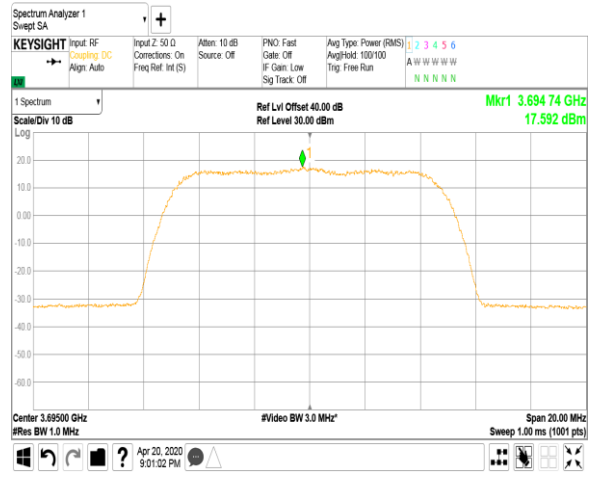

Modulation: 64QAM

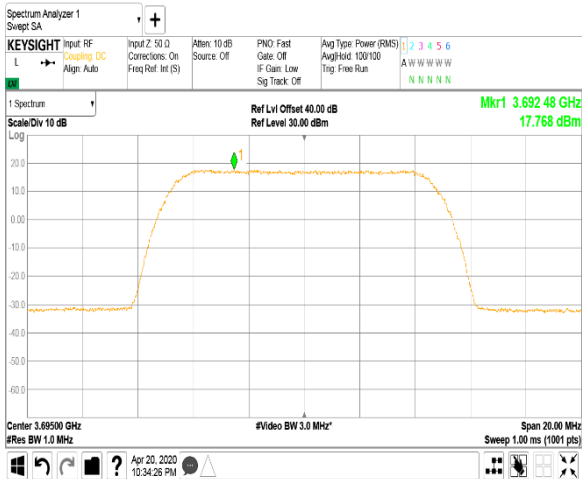



HERMON LABORATORIES

Test specification: Section 96.41(b), Maximum EIRP and maximum power spectral density	
Test procedure: Section 96.41(e)(3)	
Test mode: Compliance	Verdict: PASS
Date(s): 22-Apr-20	
Temperature: 24 °C	Relative Humidity: 55 %
Air Pressure: 1011 hPa	Power: 48 VDC
Remarks:	

Plot 7.1.4 Peak spectral power density at low frequency

CHANNEL SPACING:
ANTENNA CHAIN:
Modulation: QPSK

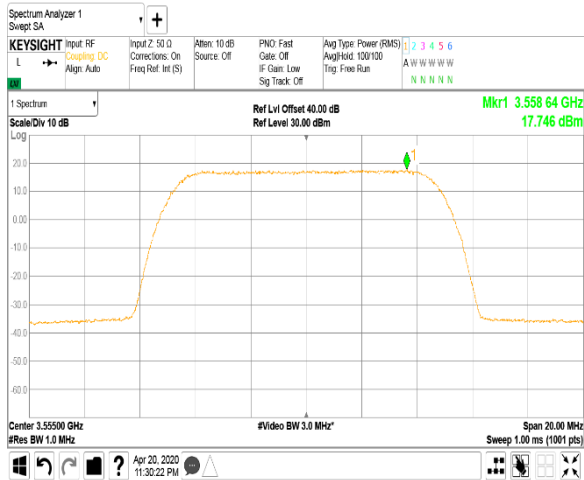

10 MHz
2
Modulation: 16QAM

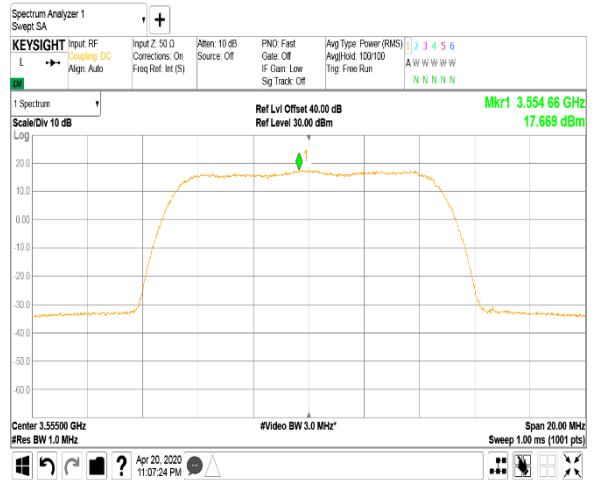

Modulation: 64QAM

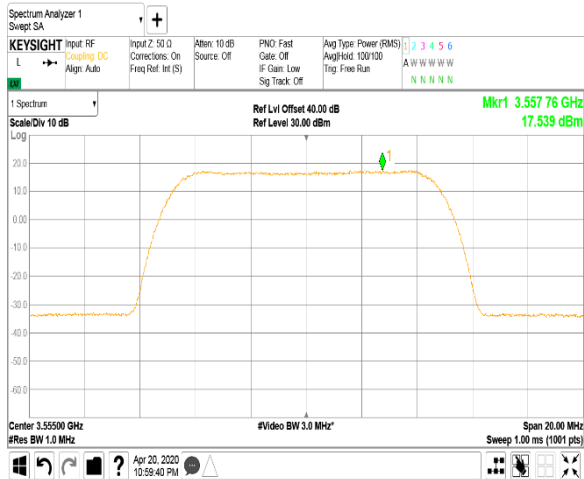



HERMON LABORATORIES

Test specification: Section 96.41(b), Maximum EIRP and maximum power spectral density	
Test procedure: Section 96.41(e)(3)	
Test mode: Compliance	Verdict: PASS
Date(s): 22-Apr-20	
Temperature: 24 °C	Relative Humidity: 55 %
Air Pressure: 1011 hPa	Power: 48 VDC
Remarks:	

Plot 7.1.5 Peak spectral power density at mid frequency

CHANNEL SPACING:
ANTENNA CHAIN:
Modulation: QPSK

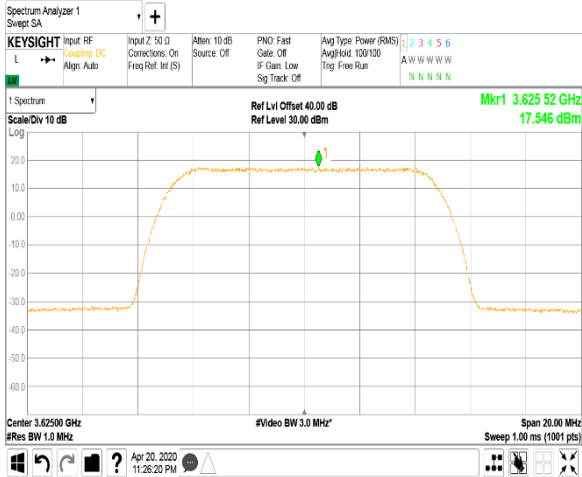

10 MHz
2
Modulation: 16QAM

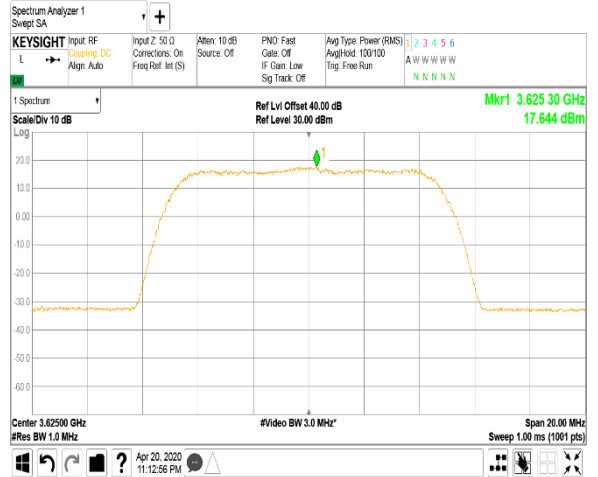

Modulation: 64QAM

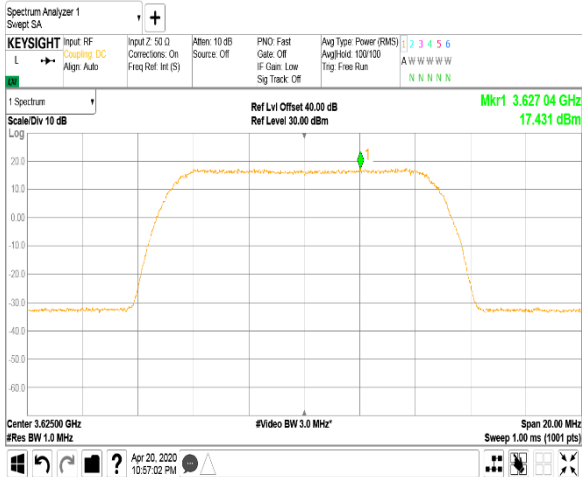



HERMON LABORATORIES

Test specification: Section 96.41(b), Maximum EIRP and maximum power spectral density	
Test procedure: Section 96.41(e)(3)	
Test mode: Compliance	Verdict: PASS
Date(s): 22-Apr-20	
Temperature: 24 °C	Relative Humidity: 55 %
Air Pressure: 1011 hPa	Power: 48 VDC
Remarks:	

Plot 7.1.6 Peak spectral power density at high frequency

CHANNEL SPACING:
ANTENNA CHAIN:
Modulation: QPSK

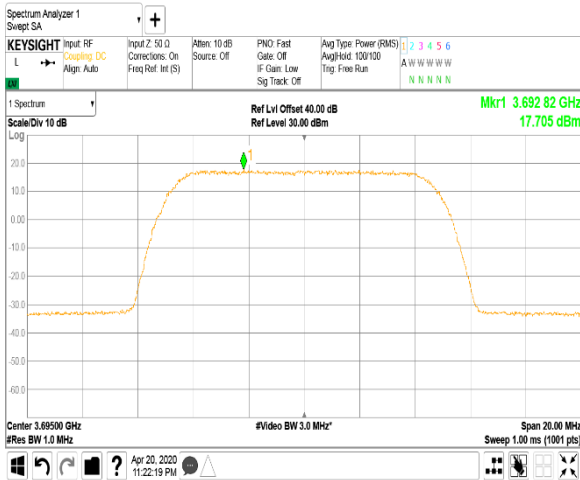

10 MHz
2
Modulation: 16QAM

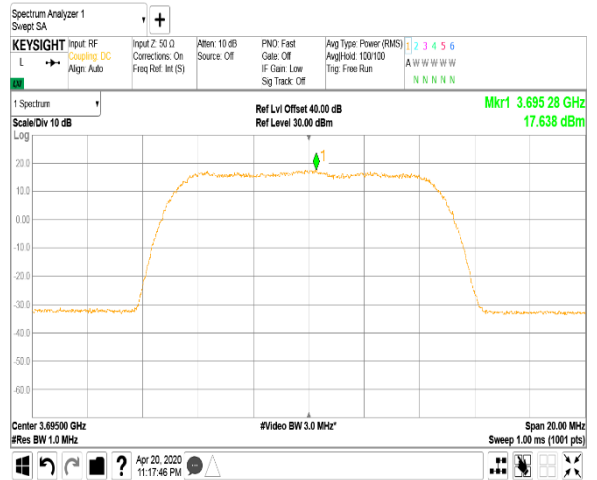

Modulation: 64QAM

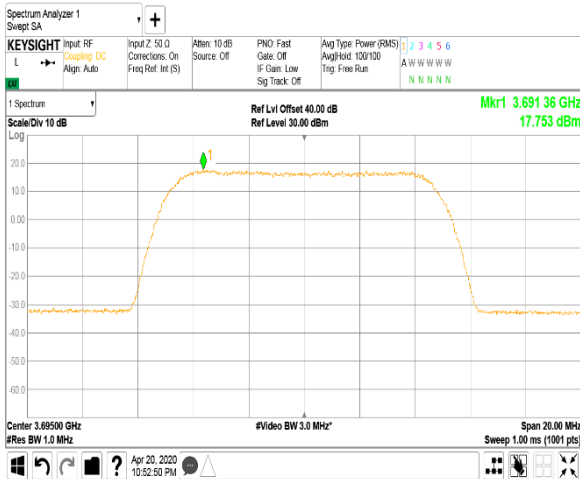



HERMON LABORATORIES

Test specification: Section 96.41(b), Maximum EIRP and maximum power spectral density	
Test procedure: Section 96.41(e)(3)	
Test mode: Compliance	Verdict: PASS
Date(s): 22-Apr-20	
Temperature: 24 °C	Relative Humidity: 55 %
Air Pressure: 1011 hPa	Power: 48 VDC
Remarks:	

Plot 7.1.7 Peak spectral power density at low frequency

CHANNEL SPACING:
ANTENNA CHAIN:
Modulation: QPSK

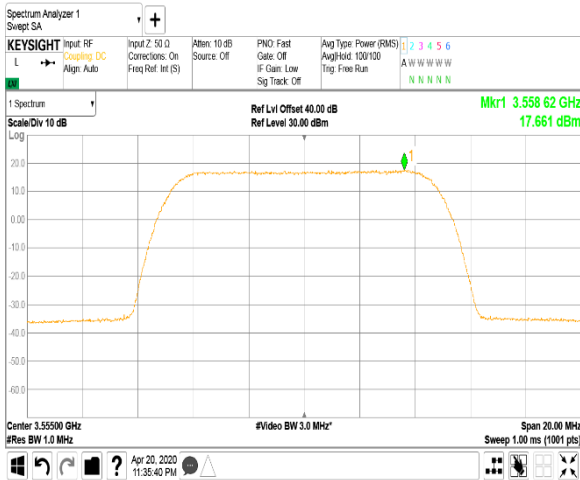

10 MHz
3
Modulation: 16QAM

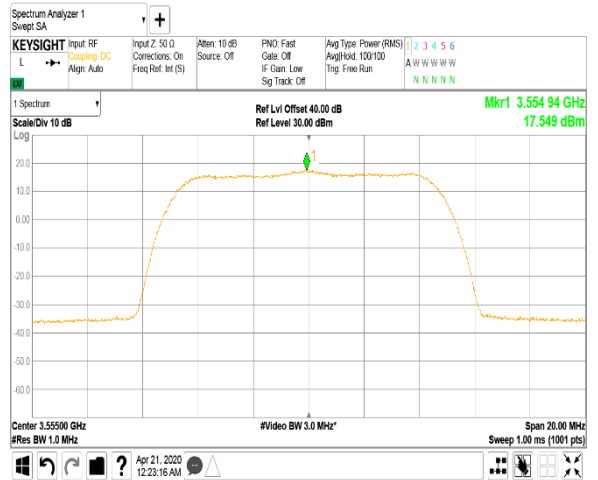

Modulation: 64QAM

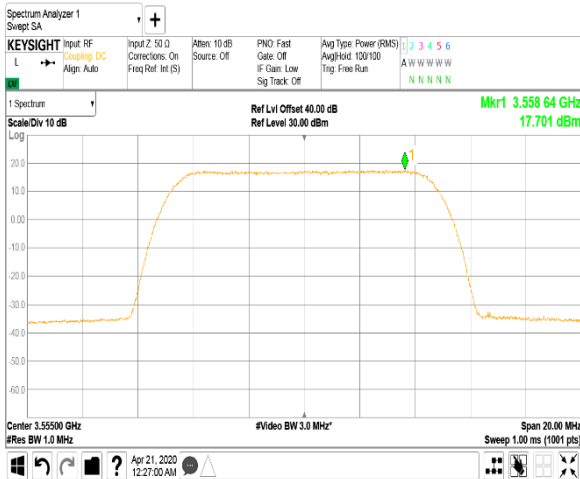



HERMON LABORATORIES

Test specification: Section 96.41(b), Maximum EIRP and maximum power spectral density	
Test procedure: Section 96.41(e)(3)	
Test mode: Compliance	Verdict: PASS
Date(s): 22-Apr-20	
Temperature: 24 °C	Relative Humidity: 55 %
Air Pressure: 1011 hPa	Power: 48 VDC
Remarks:	

Plot 7.1.8 Peak spectral power density at mid frequency

CHANNEL SPACING:
ANTENNA CHAIN:
Modulation: QPSK

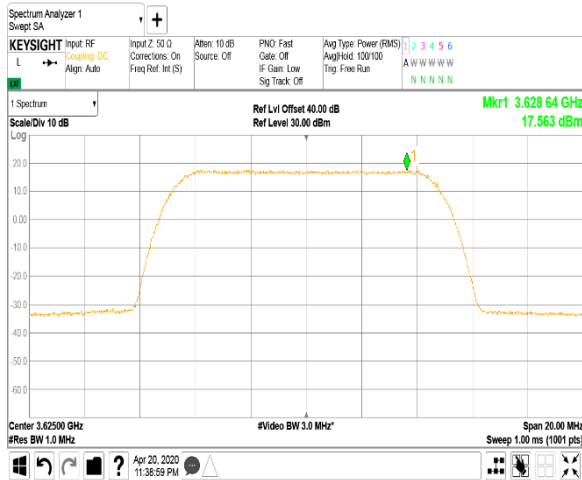

10 MHz
3
Modulation: 16QAM

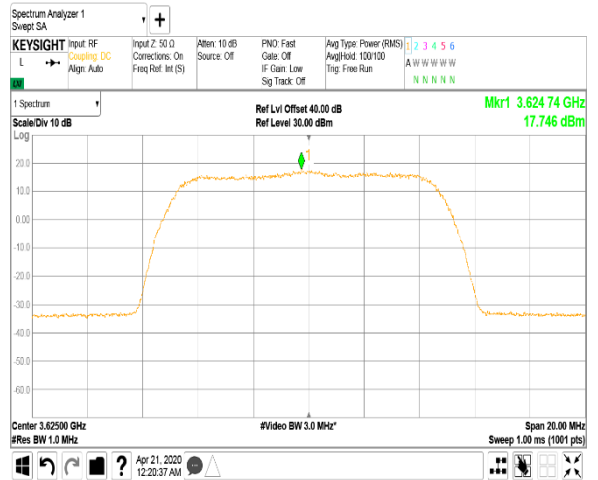

Modulation: 64QAM

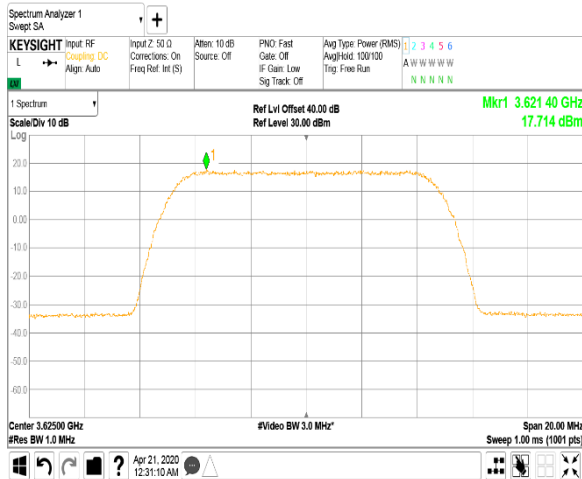



HERMON LABORATORIES

Test specification: Section 96.41(b), Maximum EIRP and maximum power spectral density	
Test procedure: Section 96.41(e)(3)	
Test mode: Compliance	Verdict: PASS
Date(s): 22-Apr-20	
Temperature: 24 °C	Relative Humidity: 55 %
Air Pressure: 1011 hPa	Power: 48 VDC
Remarks:	

Plot 7.1.9 Peak spectral power density at high frequency

CHANNEL SPACING:
ANTENNA CHAIN:
Modulation: QPSK

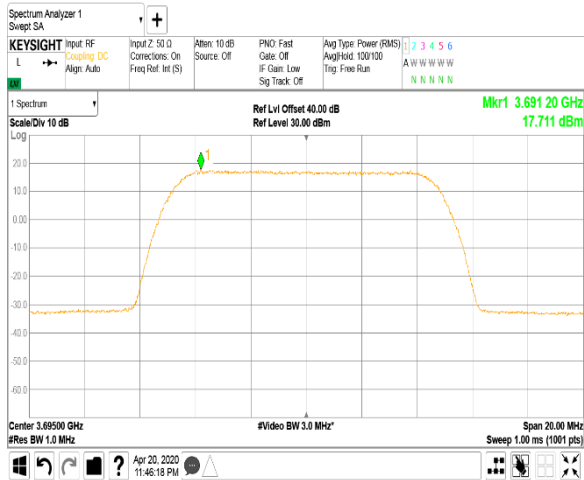

10 MHz
3
Modulation: 16QAM

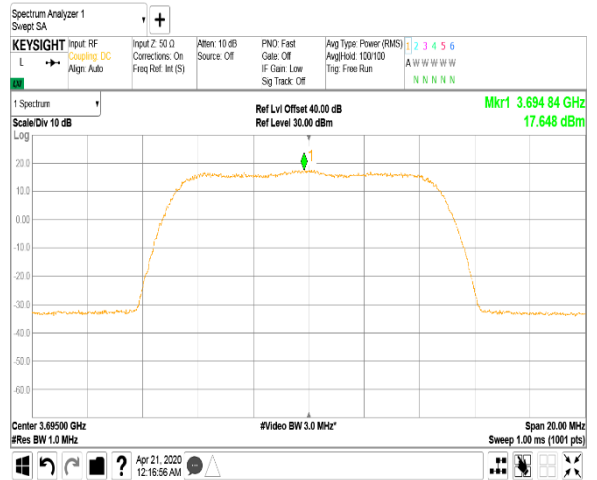

Modulation: 64QAM

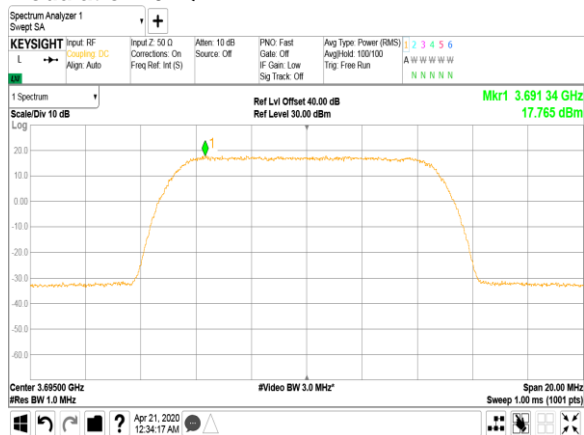



HERMON LABORATORIES

Test specification: Section 96.41(b), Maximum EIRP and maximum power spectral density	
Test procedure: Section 96.41(e)(3)	
Test mode: Compliance	Verdict: PASS
Date(s): 22-Apr-20	
Temperature: 24 °C	Relative Humidity: 55 %
Air Pressure: 1011 hPa	Power: 48 VDC
Remarks:	

Plot 7.1.10 Peak spectral power density at low frequency

CHANNEL SPACING:
ANTENNA CHAIN:
Modulation: QPSK

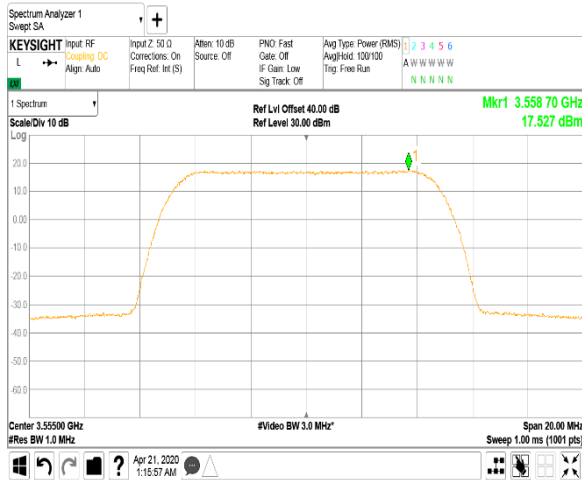

10 MHz
4
Modulation: 16QAM

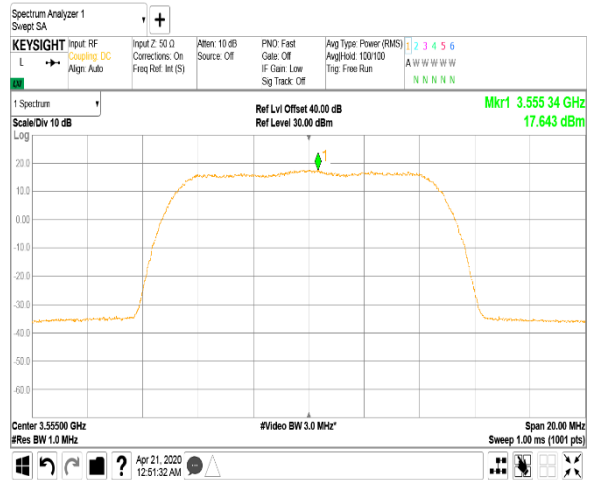

Modulation: 64QAM

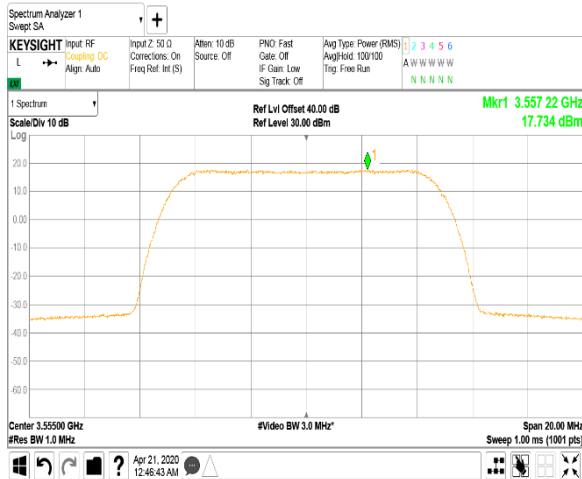



HERMON LABORATORIES

Test specification: Section 96.41(b), Maximum EIRP and maximum power spectral density	
Test procedure: Section 96.41(e)(3)	
Test mode: Compliance	Verdict: PASS
Date(s): 22-Apr-20	
Temperature: 24 °C	Relative Humidity: 55 %
Air Pressure: 1011 hPa	Power: 48 VDC
Remarks:	

Plot 7.1.11 Peak spectral power density at mid frequency

CHANNEL SPACING:
ANTENNA CHAIN:
Modulation: QPSK

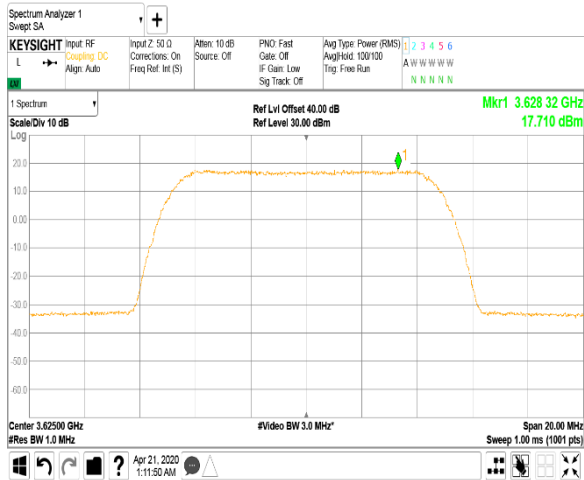

10 MHz
4
Modulation: 16QAM

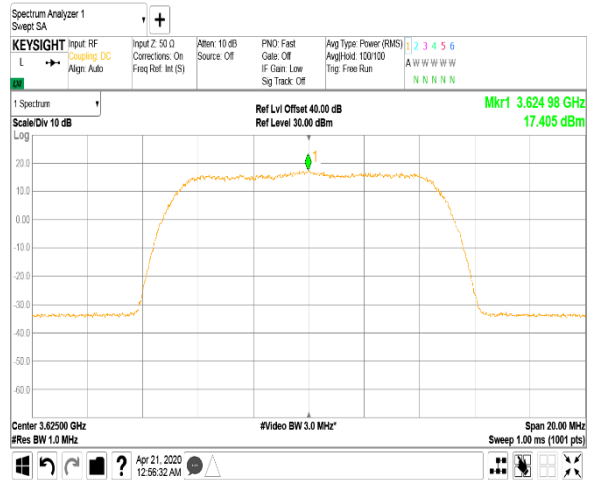

Modulation: 64QAM

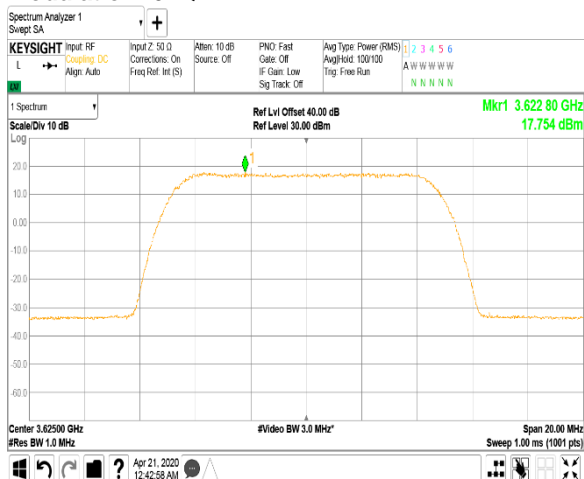



HERMON LABORATORIES

Test specification: Section 96.41(b), Maximum EIRP and maximum power spectral density	
Test procedure: Section 96.41(e)(3)	
Test mode: Compliance	Verdict: PASS
Date(s): 22-Apr-20	
Temperature: 24 °C	Relative Humidity: 55 %
Air Pressure: 1011 hPa	Power: 48 VDC
Remarks:	

Plot 7.1.12 Peak spectral power density at high frequency

CHANNEL SPACING:
ANTENNA CHAIN:
Modulation: QPSK

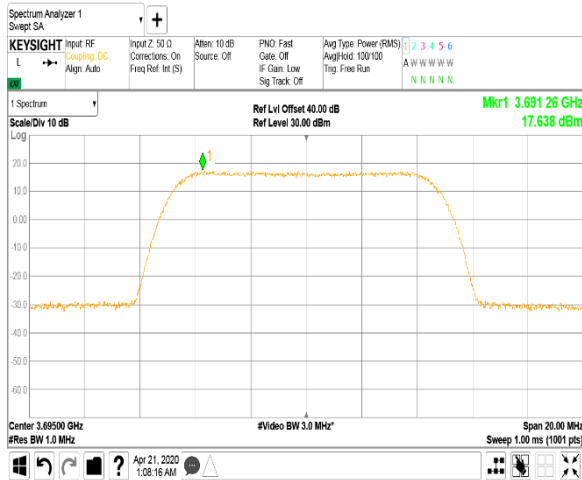

10 MHz
4
Modulation: 16QAM

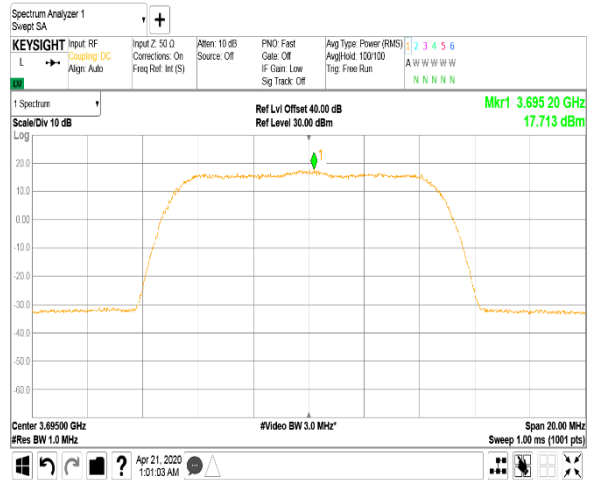

Modulation: 64QAM

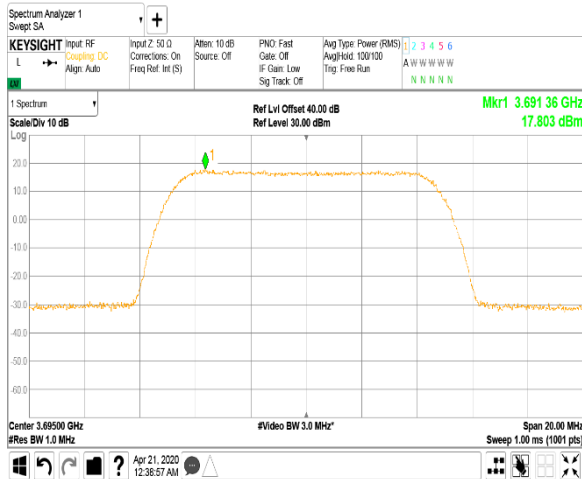



HERMON LABORATORIES

Test specification: Section 96.41(b), Maximum EIRP and maximum power spectral density	
Test procedure: Section 96.41(e)(3)	
Test mode: Compliance	Verdict: PASS
Date(s): 22-Apr-20	
Temperature: 24 °C	Relative Humidity: 55 %
Air Pressure: 1011 hPa	Power: 48 VDC
Remarks:	

Plot 7.1.13 Peak spectral power density at low frequency

CHANNEL SPACING:
ANTENNA CHAIN:
Modulation: QPSK

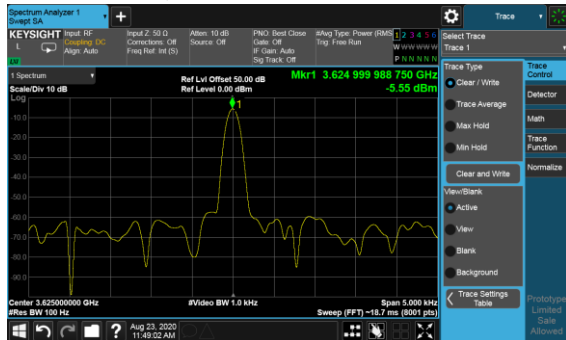

20 MHz
1
Modulation: 16QAM

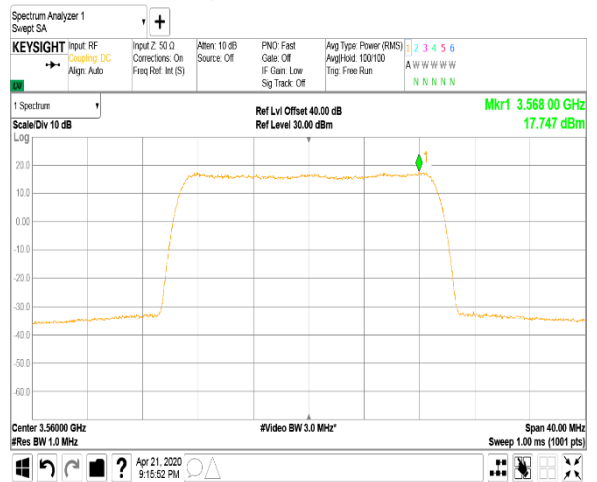

Modulation: 64QAM

