



AirSpeed 1030 B48 Installation Guide

Part Number: DUG01623

System Release: 17.5

Revision: A1

Published: August 2020

© Copyright by **Airspan Networks Ltd.**, 2020. All rights reserved worldwide.

Legal Notices

The information contained within this document is proprietary, privileged and intended only for the recipient. As such, the information is subject to all relevant copyright, patent and other laws protecting intellectual property, as well as any specific agreements protecting Airspan Networks Ltd. rights in the aforesaid information. Neither this document nor the information contained herein may be published, reproduced, transmitted or disclosed to third parties, in whole or in part, without the express, prior, written permission of Airspan Networks Ltd. In addition, any use of this document or the information contained herein for the purposes other than those for which it is disclosed is strictly forbidden.

Airspan Networks Ltd. reserves the right, without prior notice or liability, to make changes in equipment design or specifications.

Information supplied by Airspan Networks Ltd. is believed in good faith to be accurate and reliable, while every care has been taken in preparing these documents. However, Airspan Networks Ltd. does not make any representations and gives no warranties of whatever nature in respect of these documents, including without limitation, the accuracy or completeness of any information, facts and/or opinions contained therein. No responsibility is assumed by Airspan Networks Ltd. for the use of the documents nor for the rights of third parties which may be effected in any way by the use thereof. The provision of these documents (and the documents themselves) does not constitute professional advice of any kind. Any representation(s) in these documents concerning performance of Airspan Networks Ltd. product(s) are for informational purposes only and are not warranties of future performance, either expressed or implied. Airspan Networks Ltd., its affiliates, directors, employees and agents shall not be held liable for any damages or losses, of any nature whatsoever, arising from any use of and/or reliance on the documents.

These documents may contain flaws, omissions or typesetting errors; no warranty is granted nor liability assumed in relation thereto unless specifically undertaken in Airspan Networks Ltd. sales contract or order confirmation. Information contained herein is periodically updated and changes will be incorporated into subsequent editions. If you have encountered an error, please notify Airspan Networks Ltd.

Product performance figures quoted within this document are indicative and for information purposes only.

UK WEEE Registration number: WEEE/AB0207WZ. For more information, see [WEEE Information for Airspan Customers and Recyclers](#).

Acknowledgements



© Intel Corporation <http://www.intel.com/>



© Microsoft Corporation <http://www.microsoft.com>

Table of Contents

Document Information	5
Abstract.....	5
Revision History	5
Warnings and Cautions	6
Human Exposure to Radio Frequencies	6
Avertissement et Precautions d'Utilisation	6
Exposition des personnes aux fréquences radioélectriques	6
Radio Interference	6
Modifications	6
General	6
Général	6
⚠ Important Safety Instructions	7
Safety	7
Securite.....	7
Warning of Hazardous Voltages	8
Attention aux Voltages Hasardeux.....	8
Adherence to European Directive 2014/53/EU	8
Warning Symbols.....	8
Service Information	8
UL Information	9
DECLARATION OF CONFORMITY	9
Maximum Output TX Power	11
Product Variants	11
Power Consumption.....	12
External Antennas (Optional)	13
About This Document.....	14
Purpose.....	14
Intended Audience	14
Document Conventions.....	14

Related Reading	15
Customer Care Help Desk	16
Airspan Encourages Comments	16
1 Introduction.....	17
1.1 AirSpeed 1030 B48	17
2 Getting Started	18
2.1 Workflow of Installation	18
2.2 AirSpeed 1030 B48 Installation Checklist.....	18
3 Verifying Prerequisites	19
3.1 Verifying Site Requirements.....	19
3.2 Verify Installation Requirements.....	19
3.2.1 Verify the Tools.....	19
3.2.2 Verify the Parts and Kits	20
3.2.3 Power Supply.....	21
3.2.4 Connections.....	21
3.2.5 Physical Dimensions.....	23
3.2.6 Environmental.....	23
3.3 LEDs Display.....	24
4 AirSpeed 1030 B48 Installation	25
4.1 Back Bracket Assembly.....	25
4.2 Connecting the GPS Antenna	26
4.3 Weather-proofing Antenna Connections	26
4.4 Pole Mounting Assembly.....	27
4.5 Wall Mount Assembly.....	29
4.6 Tilt Adjustment	30
5 Connect and Manage Cables	31
5.1 Grounding	31
5.2 Fiber Ethernet (SFP) Cable Preparation	31
5.3 Copper Ethernet Cable Preparation	35
5.4 DC Cable Preparation	38
5.5 Remote (External) Antenna Assembly	42

A Job Sheet44

B Checklist.....45

C Abbreviations.....46

Figures

Figure 1: AirSpeed 1030 B48 (GPS Attached) 13

Figure 2: AirSpeed 1030 B48 Front View 17

Figure 3: Workflow 18

Figure 4: AirSpeed 1030 B48 Top Ports 21

Figure 5: AirSpeed 1030 B48 Bottom Ports..... 22

Figure 6: Back Bracket Assembly 25

Figure 7: Attaching GPS Antenna..... 26

Figure 8: Pole Mounting Assembly 27

Figure 9: Mounted on Pole..... 28

Figure 10: AirSpeed on Wall 29

Figure 11: Tilt Adjustment 30

Figure 12: Ground Connection..... 31

Figure 13: Pre-assembled LC Duplex Cable 31

Figure 14: Open Housing Lock 32

Figure 15: Gland Nut on Cable 32

Figure 16: Insert Tightening Cone on Cable 32

Figure 17: Insert Rubber Gland on Cable 32

Figure 18: Pass Cable thru Housing 33

Figure 19: Insert Cable into Transceiver..... 33

Figure 20: Insert Holder over theTransceiver 33

Figure 21: Holder into Housing Base 33

Figure 22: Holder into Transceiver..... 34

Figure 23: Lift Lever 34

Figure 24: Insert Gland 34

Figure 25: Insert Cone 34

Figure 26: Tighten Gland Nut..... 35

Figure 27: Secure Housing Lock..... 35

Figure 28: Pre-assembled RJ45 Cable 35

Figure 29: Gland Nut on Cable 36

Figure 30: Insert Tightening Cone on Cable 36

Figure 31: Insert Rubber Gland on Cable 36

Figure 32: Insert Housing onto Cable 36

Figure 33: Insert Holder onto RJ45	37
Figure 34: Holder into Housing Base	37
Figure 35: Align RJ45 into Holder	37
Figure 36: Lift Lever	37
Figure 37: Insert Gland	38
Figure 38: Tighten Gland Nut.....	38
Figure 39: Secure Housing Lock.....	38
Figure 40: Stripping Dimensions (DC Cable).....	39
Figure 41: Open Housing Lock	39
Figure 42: Separate into Sections.....	39
Figure 43: Insert Gland Nut.....	40
Figure 44: Pass DC Cable Thru.....	40
Figure 45: Tighten Two (2) Set Screws	40
Figure 46: Tighten the Strap Clamp.....	40
Figure 47: Align Marks + Click in Place	41
Figure 48: Place Split Rubber Gland	41
Figure 49: Place Tightening Cone on Split Gland.....	41
Figure 50: Tighten gland Nut.....	41
Figure 51: Secure Housing Lock.....	42
Figure 52: Antenna RF Cables	42
Figure 53: Connecting Antenna RF Cable	43

Tables

Table 1: AirSpeed 1030 B48 ETSI Maximum Output TX Power	11
Table 2: AirSpeed 1030 B48 FCC Maximum Output TX Power	11
Table 3: Supported Frequency Bands	11
Table 4: Power Consumption.....	12
Table 5: Typographic Conventions	14
Table 6. Minimum Hardware Requirements	19
Table 7. Parts & Kits	20
Table 8. AirSpeed 1030 B48 Physical Dimensions	23
Table 9. AirSpeed 1030 B48 Environment Compliance	23
Table 10: LED Display	24
Table 11: ABBREVIATIONS & DEFINITIONS.....	46

Document Information

Abstract

This document details procedures for installing the Airspan's AirSpeed 1030 B48 Pico-class LTE eNodeB variant.

Revision History

Revision Details	Date	Summary of Changes
Rev 0.1 – 0.5	June 2020	<ul style="list-style-type: none">• Initial document – draft• comments
Rev A	June 2020	<ul style="list-style-type: none">• Published after comments
Rev A1	August 2020	<ul style="list-style-type: none">• Added antenna variants + CBRS Note

Warnings and Cautions

Human Exposure to Radio Frequencies

The AirSpeed 1030 B48 should be installed and operated from a minimum safe distance of at least 24.8 in. (63 cm) and installed higher than 2 meters to prevent unauthorized access.

Avertissement et Précautions d'Utilisation

Exposition des personnes aux fréquences radioélectriques

Les AirSpeed 1030 B48 doivent être installées et utilisées de façon à garantir la distance minimale de sécurité de 63 cm et installé à plus de 2 mètres pour empêcher tout accès non autorisé.

Radio Interference

This AirSpeed 1030 B48 generates, uses, and can radiate radio frequency energy and, if not installed and used in accordance with the instructions, may cause harmful interference to radio communications. However, there is no guarantee that interference will not occur in a particular installation. If this equipment does cause harmful interference to radio, television reception or WiFi AP, which can be determined by turning the equipment on and off, the technician is encouraged to try to correct the interference by performing one or more of the following measures:

- Re-orientate or relocate the unit
- Increase separation between the units and/or End Devices
- Connect the equipment to an outlet on a circuit different from that to which the power source is connected

Modifications

Any changes and modifications to this device that are not expressly approved by Airspan Networks may void the user's authority to operate the equipment.

General

- Only qualified personnel should be allowed to install, replace, and service the equipment.
- The device cannot be sold retail, to the general public or by mail order. It must be sold to operators.
- Installation must be controlled.
- Installation must be performed by licensed professionals.
- Installation requires special training. The AirSpeed 1030 B48 should be installed **ONLY** by experienced installation professionals who are familiar with local building and safety codes and, wherever applicable, are licensed by the appropriate government regulatory authorities. Failure to do so may void Airspan's product warranty and may expose the end user or the service provider to legal and financial liabilities.
- Airspan and its resellers or distributors are not liable for injury, damage or violation of regulations associated with the installation of units or antennas.

Général

- Seul le personnel qualifié peut être autorisé pour installer ou remplacer l'équipement ainsi qu'effectuer les opérations de maintenance pour cet équipement.
- L'équipement ne peut pas être vendu en grande distribution ou par commande via email à destination du public. Il doit être vendu aux opérateurs de télécommunications.
- Son installation doit être contrôlée
- Son installation doit être effectuée par des professionnels autorisés.

- Son installation requiert une formation spécifique du personnel. L'AirSpeed 1030 B48, radio et antenne doit être installée UNIQUEMENT par des installateurs professionnels expérimentés et ayant une connaissance des constructions locales et règles de sécurité, ainsi que, dès que nécessaire, disposant d'un accord des autorités gouvernementales de régulation. Toute infraction à ces obligations peut annuler la garantie délivrée par Airspan pour ces produits et peut exposer l'utilisateur final ou le fournisseur de services à des dommages légaux et financiers.
- Airspan et ses revendeurs ou ses distributeurs ne sont pas responsables des blessures, dommages ou violations de la réglementation en vigueur liées à l'installation du système ou des antennes.

Important Safety Instructions

- Read and Save these instructions
- This Installation Guide contains instructions and warnings that should be followed during installation, and operation.
- Failure to follow these instructions could cause bodily injury and/or product failure

Safety

1. Read this guide and follow all operating and safety instructions.
2. No user serviceable parts inside.
3. Position the power cord to avoid possible damage; do not overload circuits.
4. Do not place this product on or near a direct heat source, and avoid placing objects on the terminal.
5. Use only a damp cloth for cleaning. Do not use liquid or aerosol cleaners. Disconnect the power before cleaning.
6. The units should not be located near power lines or other electrical power circuits.
7. It is the user's responsibility to install this device in accordance with the local electrical codes.
8. Installation of the AirSpeed 1030 B48 must be contracted to a professional installer.
9. The circuit breaker should be easily accessible in case you have to disconnect the device.
10. When installed in the final configuration, the product must comply with the applicable Safety Standards and regulatory requirements of the country in which it is installed. If necessary, consult with the appropriate regulatory agencies and inspection authorities to ensure compliance.

Securete

1. Lire attentivement ce guide et suivre les instructions d'utilisation et de sécurité.
2. Aucune pièce à l'intérieur est d'utilité pour l'utilisateur.
3. Positionner le cordon d'alimentation de façon à éviter des dommages potentiels. Ne pas surcharger les circuits.
4. Ne pas placer ce produit sur ou à proximité d'une source directe de chaleur et éviter de placer des objets sur le terminal.
5. Utiliser uniquement chiffon de coton pour nettoyage. Ne pas utiliser de produits liquides ou d'aérosols. Déconnecter le produit de la source d'alimentation avant nettoyage.
6. L'unité ne doit pas être située trop près de lignes électriques ou autres circuits de puissance, avec lesquels il pourrait entrer en contact.
7. L'utilisateur est tenu responsable de l'installation du produit conformément aux règles électriques en vigueur localement.

8. L'installation de AirSpeed 1030 B48 doit être contractualisée avec un installateur professionnel.
9. L'interrupteur de circuit électrique doit être facilement accessible afin de pouvoir déconnecter l'équipement.
10. Lors de l'installation de la configuration finale, le produit doit être conforme aux Standards de Sécurité en vigueur ainsi qu'aux exigences réglementaires du pays dans lequel il est installé. Si nécessaire, consulter les agences réglementaires appropriées, ainsi que les autorités chargées de l'inspection afin de garantir la conformité.

Warning of Hazardous Voltages

On AC installations, hazardous voltages exist. Use caution when verifying or working with AC power. Remove metal jewellery that could come into contact with AC power.

On DC sections, short-circuiting the low voltage, low impedance circuits can cause severe arcing that may result in burns or eye damage. Remove rings, watches etc. to avoid shorting DC circuits.

Note: Airspan products do not contain hazardous substances (as defined in UK Control of Substances Hazardous to Health Regulations 1989 and the Dangerous Substances Regulations 1990). At the end of any Airspan products life cycle, the customer should consult with Airspan to ensure that the product is disposed of in conformance with the relevant regulatory requirements.

Attention aux Voltages Hasardeux

Sur les installations de réseau électrique de type courant alternatif (CA), des voltages hasardeux peuvent survenir. Garder une Attention particulière lors d'une vérification ou de travaux sur réseau électrique CA. Retirer tous bijoux en métal qui pourraient entrer en contact avec l'alimentation ou le réseau CA.

Sur les portions de réseau électrique de type courant continu (CC), un circuit basse impédance peut causer de sérieux arcs électriques qui pourraient brûler ou endommager les yeux. Retirer bagues, anneaux, montres etc... afin d'éviter les court-circuit sur le réseau CC.

Adherence to European Directive 2014/53/EU

European Council Recommendation 2014/53/EU details basic restrictions and reference levels on human exposure to electromagnetic fields as advised by the ICNIRP. Adherence to these recommended restrictions and reference levels should provide a high level of protection as regards the established health effects that may result from exposure to electromagnetic fields.

Warning Symbols

The following symbols may be encountered during installation or troubleshooting. These warning symbols mean danger. Bodily injury may result if you are not aware of the safety hazards involved in working with electrical equipment and radio transmitters. Familiarize yourself with standard safety practices before continuing.



Caution, hot surface



Caution



Electro-Magnetic
Radiation



DC

Service Information

Refer all repairs to qualified service personnel. Do not modify any part of this device, as this will void the warranty.

Disconnect the power to this product and return it for service if the following conditions apply:

- a. The terminal does not function after following the operating instructions outlined in this manual.
- b. Liquid has been spilled, a foreign object is inside, or the terminal has been exposed to rain.
- c. The product has been dropped or the housing is damaged.

Locate the serial number of the terminal and record this on your registration card for future reference. Also record the MAC address, located on the product sticker.

UL Information

- The electrical source must be properly grounded according with NEC and other local safety code requirements.

- AirSpeed 1030 B48 is designed to operate in environmental conditions complying with IP40 and relevant standards.

DECLARATION OF CONFORMITY

Declaration of Conformity with Regard to the R&TTE Directive 2014/53/EU

Czech:

Airspan tímto prohlašuje, že tento přístroj je ve shodě se základními požadavky a dalšími příslušnými ustanoveními směrnice 2014/53 / EU.

Danish:

Undertegnede, Airspan erklærer hermed, at følgende udstyrsenhed opfylder de væsentlige krav og andre relevante krav i direktiv 2014/53 / EF.

Deutsch:

Hiermit erklärt Airspan, dass die Produkteinheit die grundlegenden Anforderungen und anderen relevanten Bestimmungen der Richtlinie 2014/53 / EU erfüllt.

Estonian:

Käesolevaga kinnitab Airspan, et seadme seade vastab direktiivi 2014/53 / EL oluliste nõuetele ja muudele kõnealuse direktiivi asjakohastele sätetele.

English:

This equipment is in compliance with the essential requirements and other relevant provisions of Directive 2014/53/EU.

Español:

Por medio de este Airspan, declara que la unidad cumple con los requisitos esenciales y cualquier otra disposición aplicable o exigible de la Directiva 2014/53 / UE.

Greek:

ΜΕ ΤΗΝ ΠΑΡΟΥΣΑ ΠΡΟΔΙΑΓΡΑΦΗ, η Airspan ΔΗΛΩΝΕΤΑΙ ότι η μονάδα συμμορφώνεται με τις ουσιώδεις απαιτήσεις και τις λοιπές σχετικές διατάξεις της οδηγίας 2014/53 / ΕΕ.

Français:

Airspan déclare par la présente que l'appareil est conforme aux exigences essentielles et aux autres dispositions pertinentes de la directive 2014/53 / UE.

Italiano:

Con la presente Airspan dichiara che questa unità è conforme ai requisiti essenziali e alle altre disposizioni pertinenti stabilite dalla direttiva 2014/53 / UE.

Latvian:

Ar šo Airspan paziņo, ka vienība atbilst Direktīvas 2014/53 / ES būtiskajām prasībām un citiem attiecīgajiem noteikumiem;

Lithuanian:

Šis „Airspan“ pareiškia, kad šis įrenginys atitinka esminius Direktyvos 2014/53 / ES reikalavimus ir kitas nuostatas.

Nederlands:

Airspan verklaart hierbij dat de apparaateenheid voldoet aan de essentiële vereisten en andere relevante bepalingen van richtlijn 2014/53 / EU.

Maltese:

Hawnhekk, Airspan, tiddikjara li din l-unità tikkonforma mar-rekwiżiti essenzjali u dispożizzjonijiet rilevanti oħra li jinsabu fid-Direttiva 2014/53 / UE.

Hungarian:

Alulírott, az Airspan kijelenti, hogy az egység megfelel a 2014/53 / EU irányelv vonatkozó alapvető követelményeinek és egyéb követelményeinek.

Polish:

Niniejszym Airspan oświadcza, że urządzenie jest zgodne z zasadniczymi wymaganiami i innymi odpowiednimi postanowieniami dyrektywy 2014/53 / UE.

Português:

Airspan declara que esta unidade está em conformidade com os requisitos essenciais e outras disposições da Diretiva 2014/53 / UE.

Slovenian:

Airspan izjavlja, da je ta enota skladna z bistvenimi zahtevami in drugimi ustreznimi določbami Direktive 2014/53 / EU.

Slovak:

Airspan týmto vyhlasuje, že tento prístroj spĺňa základné požiadavky a všetky príslušné ustanovenia Smernice 2014/53 / EU.

Suomalainen:

Airspan vakuuttaa täten, että laitteen tyyppi on direktiivin 2014/53 / EU olennaisten vaatimusten ja muiden asiaankuuluvien säännösten mukainen.

Swedish:

Därmed intygar Airspan att denna enhet överensstämmer med de väsentliga egenskapskraven och andra relevanta bestämmelser som anges i direktiv 2014/53 / EU.

Íslenska:

Airspan lýsir hér með yfir að þessi eining uppfylli grunnkröfur og aðrar kröfur tilskipunar 2014/53 / ESB.

Norsk:

Airspan erklærer herved at utstyrsenheten oppfyller grunnleggende krav og andre relevante krav i direktiv 2014/53 / EU.

Român:

Airspan declarâm pe propria răspundere cã produsul produsului respectã cerinþele esenþiale și alte prevederi aplicabile din Directiva 2014/53 / UE.

The Declaration of Conformity related to this product can be obtained from PLM@Airspan.com.

Maximum Output TX Power

Table 1: AirSpeed 1030 B48 ETSI Maximum Output TX Power

Frequency Band (MHz)	ETSI		Antenna Gain (dBi)	Variant
	TX (dBm)	EIRP (dBm)		
3550-3700	33	50	17	1030

Table 2: AirSpeed 1030 B48 FCC Maximum Output TX Power

Frequency Band (MHz)	FCC		Antenna Gain (dBi)	Variant
	TX (dBm)	EIRP (dBm)		
3550-3700	27.36 @ 10MHz 29.42 @ 20MHz	44.86 @10MHz 46.92 @20MHz	17.5	1030
	26.86 @ 10MHz 28.92 @ 20MHz	44.86 @10MHz 46.92 @20MHz	18	1030
	24.36 @ 10MHz 26.42 @ 20MHz	44.86 @10MHz 46.92 @20MHz	20.5	1030
	19.86 @ 10MHz 21.92 @ 20MHz	44.86 @10MHz 46.92 @20MHz	25	1030

Note: The AirSpeed 1030 requires operation using an Airspan FCC-specific version of Netspan acting as a CBRS Domain Proxy.

Caution: Do not set maximum output TX total power to higher than local regulations.

Product Variants

AirSpeed supports the following frequency bands with the specific performance values:

Table 3: Supported Frequency Bands

LTE Band	Variant	Downlink Freq. (MHz)	Uplink Freq. (MHz)	Tx / Rx Conf.	Tx Power per Port (dBm)	Power Source
48	AS103-U48-B03DP	3550-3700	3550-3700	2 x 2T2R	4x 33 (4x2W)	DC

Power Consumption

Table 4: Power Consumption

Power Source	Nominal Power Consumption (W)	Max Nominal Power Consumption (W)
DC	65	95

Note: Nominal Power Consumption (W) - refers to average power consumption over time.

External Antennas (Optional)

AirSpeed 1030 B48 can be connected to external antennas (if required) via four (4) N-Type female connectors located at the top panel. The antenna should be mounted to its appropriate mounting facility.

The supported antennas should be dual slant, cross polar, DC grounded antennas.

Note: For a list of compatible external antennas, please contact your nearest Airspan Sales representative.

Figure 1: AirSpeed 1030 B48 (GPS Attached)



About This Document

Purpose

This guide provides the workflow and step-by-step procedures for installing the Airspan's AirSpeed 1030 B48, Pico-class LTE eNodeB variant. These procedures include:

- Verify prerequisites
- Install Back bracket & Pole/Wall bracket
- Install the AirSpeed 1030 B48
- Connect and manage cables

Intended Audience

This guide is intended for persons who are responsible for installing the AirSpeed 1030 B48 equipment.

Document Conventions

This document uses the following typographic conventions.

Table 5: Typographic Conventions

Convention	Element
Blue underlined text	Cross-reference links.
Bold text	Keyboard buttons and GUI elements.
Command	Command names or phrases.
Computer output	Text displayed by the computer.
Hyperlinks	Website and e-mail addresses.
Danger	Signifies a hazardous situation—if not avoided—will cause death or serious injury. Describes how to avoid it.
Warning	Signifies a hazardous situation—if not avoided—can cause death or serious personal injury. Describes how to avoid it.
Caution	Signifies a hazardous situation—if not avoided—can void the product warranty, and cause property damage. Describes how to avoid it.
Important	Provides necessary information to explain a task.
Note	Provides additional information.
Tip	Provides helpful hints.

Related Reading

The following documents contain related information:

- [AirSpeed 1030 B48 Product Datasheet](#)
- [Airspan LTE Commissioning Manual](#)

Customer Care Help Desk

Airspan's *Customer Care Help Desk* offers prompt and efficient customer support services.

Note: To avail Airspan's *Customer Care Help Desk* support, you must be a registered user and must have a valid support contract. To register, click [here](#) and fill the **Registration** form.

To create and update issue logs, send e-mails to [Customer Care Help Desk](#). Once you submit your issue, the system generates a new issue and sends an issue number for your reference. The system uses this issue number to categorize and store e-mails under the appropriate issue.

To help *Customer Care Help Desk* identify your issue, include the issue number and your *Customer Care Helpdesk* account details in all further communications.

Main Operations

Airspan Communications Ltd.
Capital Point
33 Bath Road
Slough, Berkshire
SL1 3UF, United Kingdom
Tel: +44-1895-467-100

Worldwide Headquarters

Airspan Networks Inc.
777, Yamato Road, Suite 105
Boca Raton, FL 3341-4408, USA
Tel: +1 561 893 8670

Airspan Encourages Comments

Airspan welcomes any feedback and suggestions that help to improve the quality of the documentation. Send your feedback to documentfeedback@airspan.com.

1 Introduction

This section provides a descriptive overview of the Airspan's AirSpeed 1030 B48 small cell eNodeB variant and its place in the Airspan product suite.

1.1 AirSpeed 1030 B48

AirSpeed 1030 B48 is part of Airspan's carrier-class LTE Advanced outdoor small cell eNodeB family. AirSpeed 1030 B48 provides high-speed data, mobility, Voice over LTE, and broadcast/multicast services.

AirSpeed 1030 B48 is a super compact, easy to install eNodeB, allowing an operator to deploy LTE broadband services on any Street Furniture, rooftop or building front.

AirSpeed 1030 B48 is a dual sector / carrier 2x2 MIMO product with integrated front antenna.

Note: For management please refer to the Airspan LTE Commissioning Manual as well as the Netspan User Manual.

The AirSpeed 1030 B48 unit is displayed below.

Figure 2: AirSpeed 1030 B48 Front View



2 Getting Started

2.1 Workflow of Installation

The Workflow to install the AirSpeed 1030 B48 is displayed in the following diagram:

Figure 3: Workflow

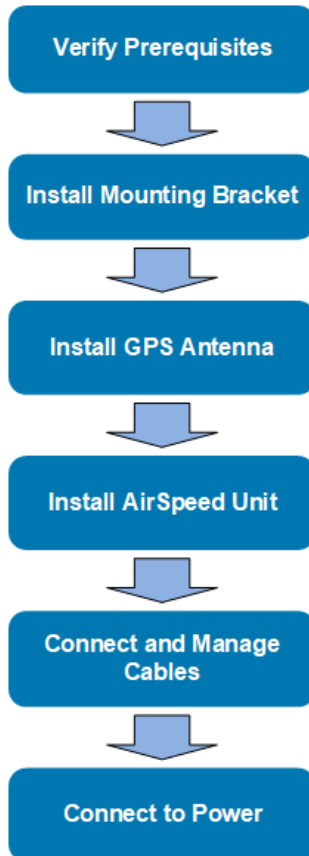

2.2 AirSpeed 1030 B48 Installation Checklist

Plan the installation of the AirSpeed 1030 B48 by using the Installation Checklist, which you can find as a removable job aid in [Appendix B](#) for this guide.

3 Verifying Prerequisites

Prior to installing the AirSpeed 1030 B48, verify the required safety, power, tools, parts and components. This chapter includes the hardware, software, and client requirements for installation.

Important: Set up requirements for the installation is detailed in the **Job Sheet**, see [Appendix A](#).

3.1 Verifying Site Requirements

To set up the AirSpeed 1030 B48, an IP connection to a Netspan server is required.

3.2 Verify Installation Requirements

3.2.1 Verify the Tools

Table 6. Minimum Hardware Requirements







Tool	Use
Large flat bladed screwdriver	securing the pole straps (bands)
13 mm wrench	for securing M8 nuts
10 mm or 13/32 inch wrench	for securing M6 nuts

Note: Airspan does not provide screws and wall anchors for mounting the unit to the wall. The screw size depends on the structure of the building to which the unit is to be attached. When selecting screw sizes, consideration must be given to the weight of the unit and load that may be induced in windy conditions.

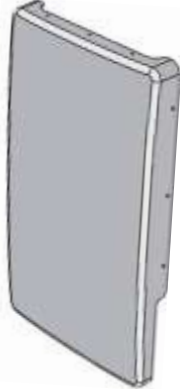
3.2.2 Verify the Parts and Kits

Note: Verify order and requirements to ensure the correct unit type is being installed.

Table 7. Parts & Kits

Installation Kit / Part	Product Code	Consisting of:	Images
AirSpeed 1030, 3.55-3.7 GHz (B48)	AS103-U48-B03DP	AirSpeed 1030, B48, Dual Sector, Integrated Antenna, DC	
		Connector for DC connection - included	
Accessories (ordered separately)			
GPS Antenna Kit	GPS-ANT-4	GPS Antenna with Interference Rejection	
AirSpeed 1030 universal pole and wall Mounting KIT	AS103-U-PMK-1	AirSpeed 1030 B48 mounting kit for 50 - 300 mm (2.0 to 11.8 inch) pole including: <ul style="list-style-type: none"> ▪ 1 - Pole mount Bracket Base kit, including back bracket and pole/wall mounting bracket ▪ 2- Maxi Clamps, band 9/16" wide + quick adjustment lock – for 63mm-406mm (2.5"-16") 	
Connector Adapter SFP	CON-ADP-OCT-SFP-1R	OCTIS Connector Adapter SFP (ordered separately)	
Connector Adapter RJ45	CON-ADP-OCT-RJ45-1R	Adapter for RJ45 copper Ethernet connector ,Right (R) pitch 26mm (ordered separately)	

3.2.3 Power Supply

AirSpeed 1030 B48 supports direct connection to -48VDC power source:

- Operational Voltage Range: -40.5 to -57 VDC

3.2.4 Connections

The following diagrams display the connections on the top and bottom panels of the AirSpeed 1030 B48.

Note: The unit requires a secure ground connection and a grounding screw fitted with a flat washer and lock washer is provided on the back and clearly marked with the universal ground symbol.

Figure 4: AirSpeed 1030 B48 Top Ports

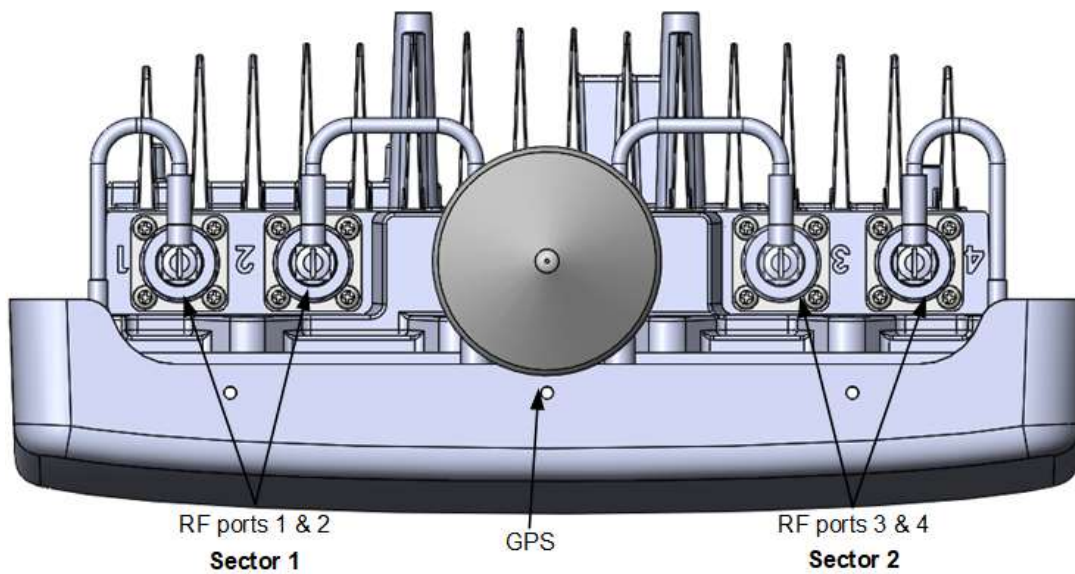

Note: RF ports 1 & 2 are specified as Sector 1. RF ports 3 & 4 are specified as Sector 2

Figure 5: AirSpeed 1030 B48 Bottom Ports

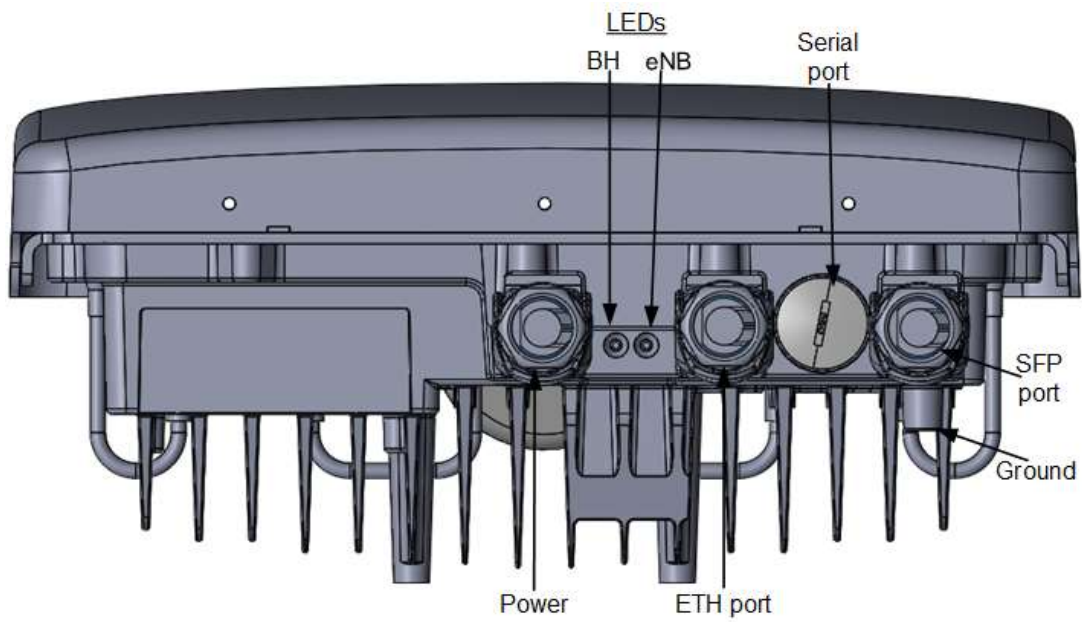

Note: When the Serial port or one of the backhaul ports are not in use it should be sealed with a cap or plug to keep it secured and environmentally protected.

3.2.5 Physical Dimensions

AirSpeed 1030 B48 is an outdoor enclosure.

Table 8. AirSpeed 1030 B48 Physical Dimensions

Variant	Dimensions (H x W x D)	Comment
AirSpeed 1030 B48	500 x 285 x 125 mm / 19.68 x 11.22 x 4.92 in.	The dimensions exclude connectors and protruding screws
Weight		
Main Unit	7.5 Kg / 16.53 Lbs.	
Mounting Bracket (Bracket Base)	1 Kg. / 2.2 Lbs.	

3.2.6 Environmental

Note: AirSpeed 1030 B48 is not meant to be used in a Marine environment.

AirSpeed 1030 B48 meets the following environmental requirements:

- IEC 60529
- IEC 60068
- ETSI EN 300-019-2-4 Operational (non-weather protected equipment)
- ETSI EN 300-019-2-1 Storage (weather protected, not temperature controlled locations)
- ETSI EN 300-019-2-2 Transportation (Public Transportation)
- GR-63, Issue 4

Table 9. AirSpeed 1030 B48 Environment Compliance

Type	Details
Operating temperature	-40°C to 55°C / -40°F to 131°F
Operating humidity	5% - 100% non-condensing
Storage temperature	-40°C to 70° C / -40°F to 158°F
Storage humidity	5% - 100% non-condensing
Rain and Dust Ingress protection	IP66

3.3 LEDs Display

Two (2) LEDs appear on the bottom of the unit, providing unit status indication.

When powering up refer to the following table for indication of current status:

Table 10: LED Display

Name	Color	Status	Description
Powering Up	Yellow	On Continuously	Till the eNodeB SW starts loading
Software loading	Green	Blinking (3Hz)	While SW is loading
Normal Operation	Green	On Continuously	Normal operation (radiating)
Major Alarm	Red	Blinking (3Hz)	Service not affected
Critical alarm or Sector OOS	Red	On Continuously	Service affected

4 AirSpeed 1030 B48 Installation

AirSpeed 1030 B48 offers two optional methods for outdoor mounting using the mounting kit, either:

- Pole Mounting
- Wall mounting

The AirSpeed 1030 B48 Mounting Kit - includes a back bracket and pole/wall mounting bracket for fastening the unit to a pole or on a wall. Prior to installation the back bracket must be assembled on the AirSpeed unit and then the mounting bracket must be affixed in place on either the pole or a wall.

Note: Mounting kits are ordered separately.

4.1 Back Bracket Assembly

Prior to installation the back bracket must be assembled on the AirSpeed unit, (unless pre-assembled).

1. Lie the unit on its face to expose the back.
2. Orient the back bracket so the lifting handle will be assembled in the direction of the top panel, where the GPS and RF ports are located.
3. Line up the four (4) holes on the back bracket with four (4) threaded holes on the back of the AirSpeed unit.
4. Insert and screw in the four (4) (M6 X 20) screws to tighten (tighten to a torque of no more than 5.2 Nm (46.02 in-lbs.) max., as shown below.

Figure 6: Back Bracket Assembly

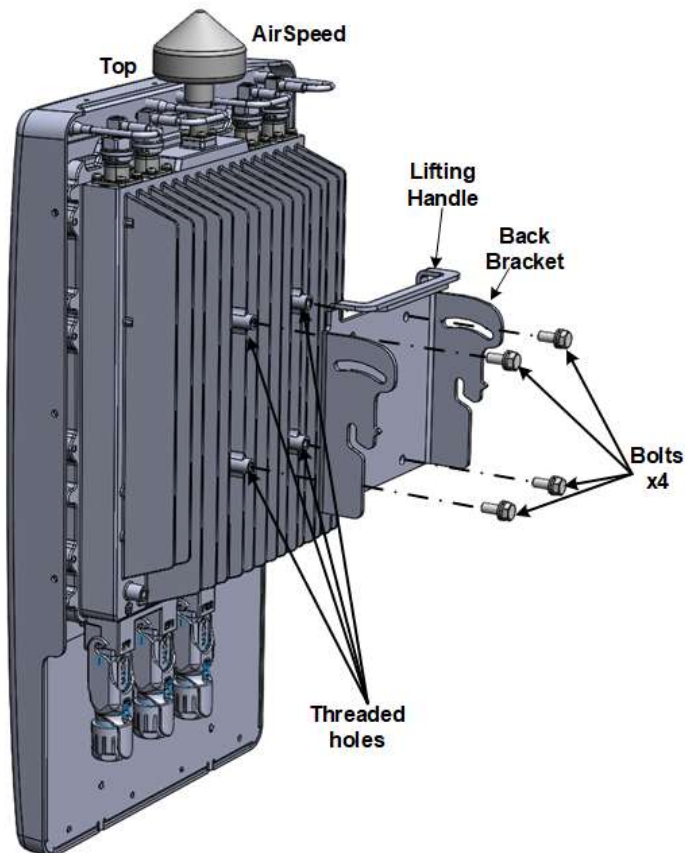

4.2 Connecting the GPS Antenna

Note: The GPS Antenna Kit is ordered separately.

Note: AirSpeed 1030 B48 works only with GPS antennas that are approved by Airspan.

The following describes the connection of the GPS antenna which is installed directly to the top of the unit.

1. Unscrew the protective metal sealed cap from the GPS antenna jack prior to mounting the GPS on the AirSpeed-1030 B48 unit.
2. Align the GPS jack with the plug attached to the top panel on the unit.
3. Attach the GPS antenna to the TNC connector on the unit.

Figure 7: Attaching GPS Antenna



Caution: Take care not to over tighten so as not to damage the threads.

Note: It is required to weather-proof all the antenna connections. This is done with a layer of self-amalgamating tape followed by an over layer of PVC tape. See [Weather-proofing Antenna Connections](#).

Note: In the event no external GPS antenna is required (i.e. – when used for 1588 clock sync), leave the sealed cap in place and weather-proof the antenna connection, as described below.

4.3 Weather-proofing Antenna Connections

Note: The RF connectors on the Front Mount Antenna arrive pre-connected. Weather-proofing is best done at this stage to give easier access to the connections.

Weather-proofing of the antenna connections is required. This is done with a layer of self-amalgamating tape followed by an over layer of PVC tape. Verify the RF connector is completely weather-sealed.

4.4 Pole Mounting Assembly

Caution: Mount the AirSpeed 1030 B48 unit in an orientation such that its ports (located on the bottom) face downwards. This prevents rain water from settling on the port, and thereby, avoiding damage to the unit such as corrosion and electrical short-circuiting.

The following describes the pole mounting procedure:

1. Select the location on the pole to mount the AirSpeed 1030 B48 mounting bracket.
2. Position the mounting bracket onto the pole at the required height.
3. Insert the clamp bands by passing them through the upper and lower slots in the bracket, in two (2) places
4. Assemble the 2 SEMS screws (M8 x 20) into the lower threaded holes on the mounting (base) bracket, do not tighten.
5. Carefully align and position the unit so that the screws (1 on each side) fit into the notched grooves provided on the back bracket (pre-assembled on the unit) and hand tighten. Insert the M8 screws, washers and nuts (supplied) and fasten the back bracket (pre-assembled on the unit) to the mounting bracket.
6. Adjust the unit so that the GPS is positioned upright. Check and tighten all fixing screws. (Tighten to a torque of no more than 12.5 Nm (9.22 ft-lb) max.)

Figure 8: Pole Mounting Assembly

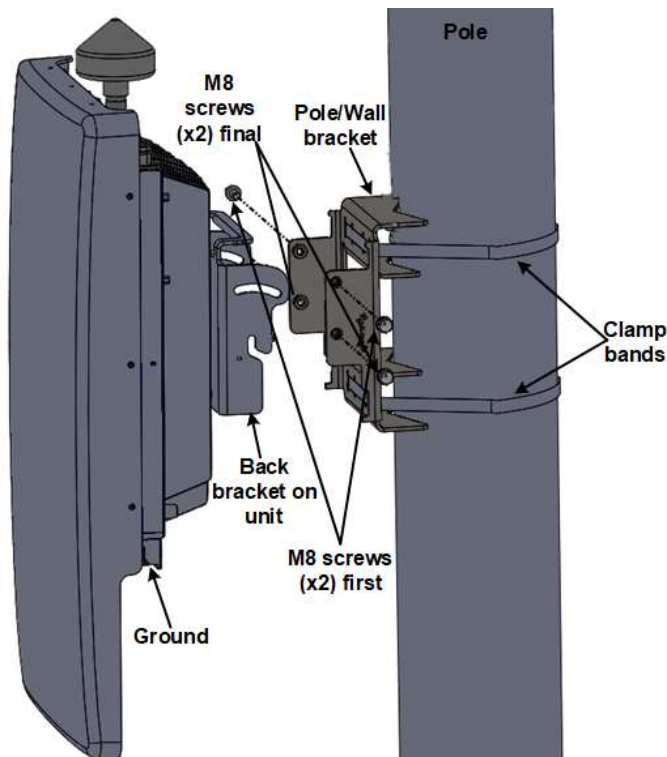

The following displays the AirSpeed 1030 B48 mounted on a pole.

Figure 9: Mounted on Pole

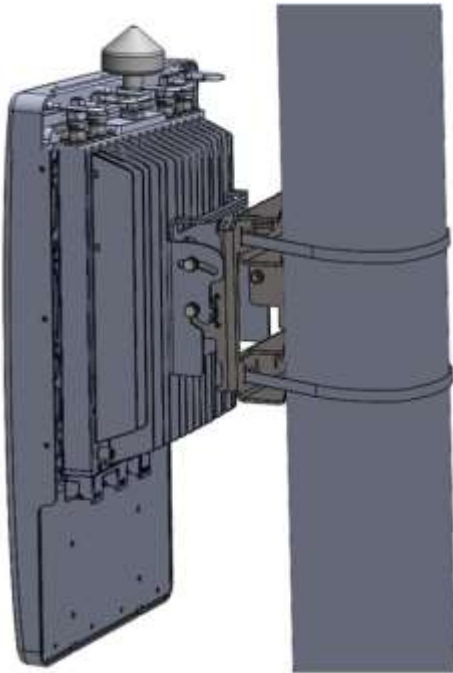

4.5 Wall Mount Assembly

The following describes the wall mounting procedure:

1. Select the location on the wall to mount the AirSpeed 1030 B48 mounting bracket.
2. Position the mounting (base) bracket onto the wall at the required height and mark where to drill the holes.
3. Insert screws and appropriate wall anchors (not provided) and tighten in place.
4. Assemble the 2 SEMS screws (M8 x 20) into the lower threaded holes on the mounting (base) bracket, do not tighten.

Note: Wall plugs (x4) and necessary hardware are **not** supplied by Airspan and are the responsibility of the installer. Use appropriate wall plugs according to field conditions.

5. Carefully align and position the unit so that the screws (1 on each side) fit into the notched grooves provided on the back bracket (pre-assembled on the unit) and hand tighten. Insert the M8 screws, washers and nuts (supplied) and fasten the back bracket (pre-assembled on the unit) to the mounting bracket.
6. Adjust the unit so that the GPS is positioned upright. Check and tighten all fixing screws. (Tighten to a torque of no more than 12.5 Nm (9.22 ft-lb) max.)

Figure 10: AirSpeed on Wall

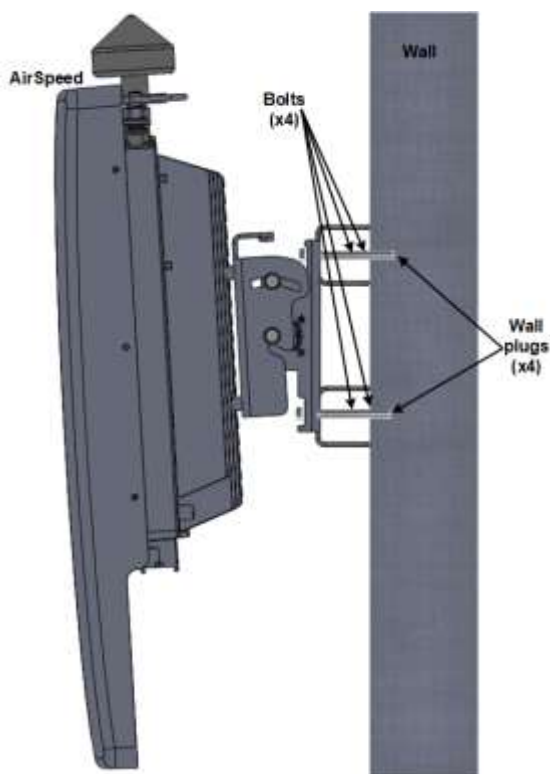

4.6 Tilt Adjustment

On the AirSpeed 1030 B48 it is possible, after assembly to adjust the unit's tilt, either up or down. This allows for maximum system optimization and reduce interference while increasing coverage. There are adjustment slots located on the sides of unit body where it is attached to the Mounting bracket.

Note: The AirSpeed 1030 B48 unit body has a yield of a maximum tilt of +20° (up) and -30° (down).

Once the AirSpeed unit is mounted in place and a tilt adjustment is needed:

1. Slightly (①) loosen the four (4) bolts on both sides of the mounting bracket.
2. Adjust (②) the unit to the required tilt.
3. After adjustment to the required tilt (③) tighten all four (4) bolts on both sides.

Figure 11: Tilt Adjustment

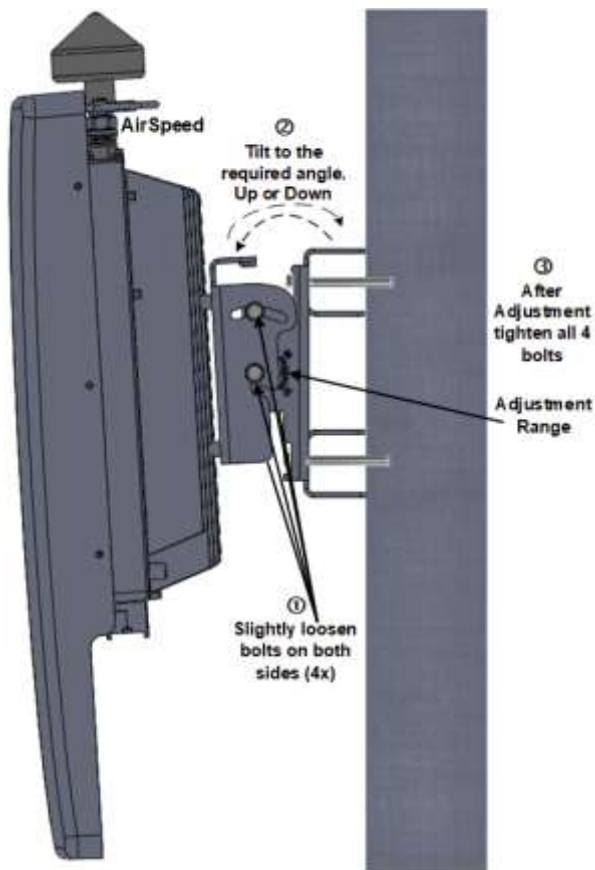

5 Connect and Manage Cables

The following section explains the grounding procedure, cable preparation, external antenna assembly and general instructions on how to connect the DC power cable and the Fiber Ethernet (SFP) cable to the AirSpeed 1050 unit.

Note: Grounding cable, Fiber cables, SFP connector adaptor and AC power cable. Ethernet cables and RJ45 copper connector adaptor are not supplied as part of the AirSpeed 1030 B48 and can be ordered separately.

5.1 Grounding

The AirSpeed 1030 B48 requires a secure ground connection and a grounding screw fitted with a flat washer and lock washer is provided on the back and clearly marked with the universal ground symbol.

The cable (not supplied) should be grounded and bonded according to international or local standards.

Figure 12: Ground Connection



5.2 Fiber Ethernet (SFP) Cable Preparation

Note: Additional parts required for the SFP assembly:

- LC Duplex cable assembly
- SFP Transceiver

Note: To ensure proper operation, SFP's that are approved by Airspan should be used.

The following displays the proper steps for SFP cable preparation:

1. Have the pre-assembled LC Duplex cable assembly ready.

Note: Diameter of cable is in the 4.8 to 6.8mm (0.19"-0.26") range.

Figure 13: Pre-assembled LC Duplex Cable

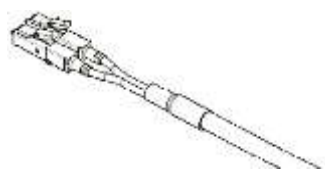

2. Open the housing lock by sliding up then lift the clamp handle,
-

Figure 14: Open Housing Lock

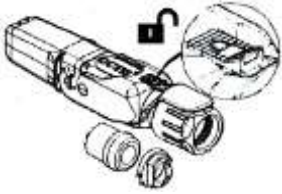

3. Separate the housing into its component sections.
 4. Insert the gland nut through the front end of LC Duplex assembly.
-

Figure 15: Gland Nut on Cable

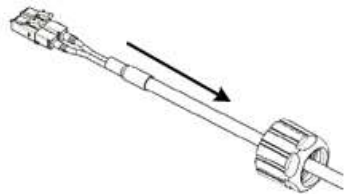

5. Insert the “split tightening cone” from the side of the cable.
-

Figure 16: Insert Tightening Cone on Cable

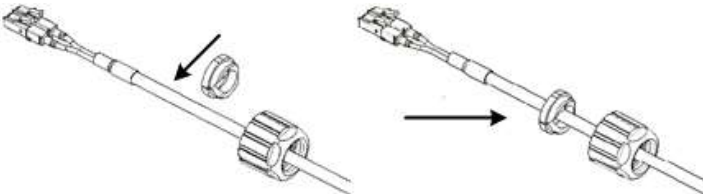

6. Insert the “split rubber gland” from side of the cable.
-

Note: Make sure to select the correct gland size. Inner diameter of rubber gland is in the range of 4.8 to 6.8mm (0.19”-0.26”) range.

Figure 17: Insert Rubber Gland on Cable

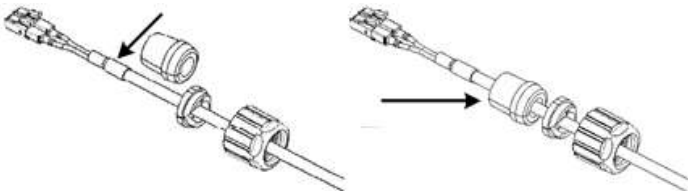

7. Pass the LC Duplex cable thru the housing.
-

Figure 18: Pass Cable thru Housing

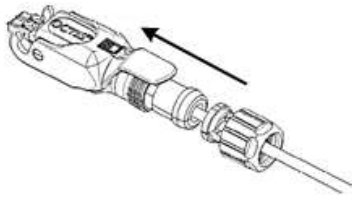

-
8. Insert the LC Duplex cable into the transceiver. A “click” is heard when engaged.
-

Figure 19: Insert Cable into Transceiver

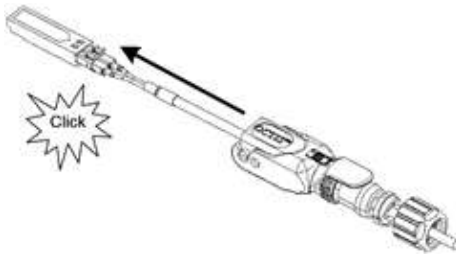

-
9. Insert the holder subset section from the front end of Transceiver.
-

Figure 20: Insert Holder over the Transceiver

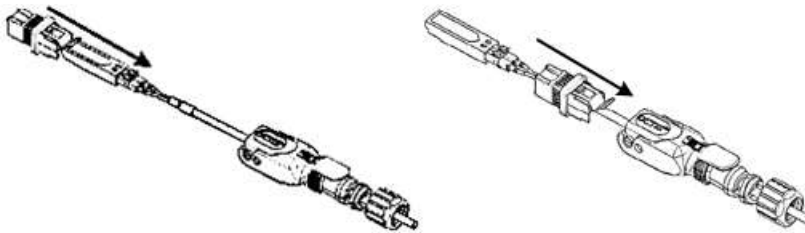

-
10. Fix the holder into the housing base. A “click” is heard when engaged.
-

Figure 21: Holder into Housing Base

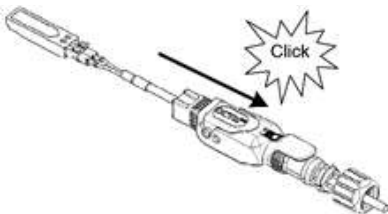

-
11. Secure the holder into the transceiver, “click” when engaged.
-

Figure 22: Holder into Transceiver



-
12. Lift the lever of housing base slightly so that the rubber gland, tightening cone and gland nut can be inserted and tightened correctly.
-

Figure 23: Lift Lever

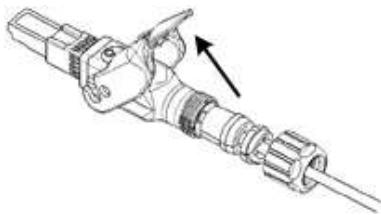

-
13. Push to insert the rubber gland.
-

Figure 24: Insert Gland

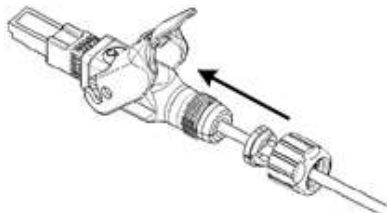

-
14. Push to insert the tightening cone.
-

Figure 25: Insert Cone

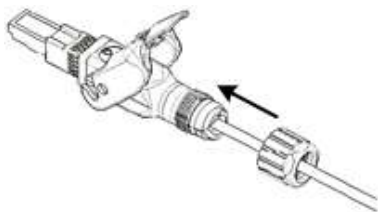

-
15. Tighten the gland nut with a 21mm wrench, to a torque of no more than 2-2.5 Nm (1.47 – 1.84 ft-lb) max.
-

Figure 26: Tighten Gland Nut

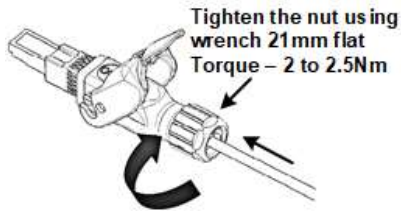

16. Insert the connector into the SFP port on the bottom of the chassis. Verify that the connector's latch faces the rear of the unit to enable potential unlocking.
17. Close the lever and secure the lock by sliding the secondary lock/button, so that lever can't be lifted.

Figure 27: Secure Housing Lock

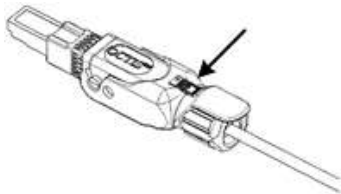

5.3 Copper Ethernet Cable Preparation

Note: A pre-assembled RJ45 cable is required for the Copper Ethernet assembly.

The following displays the proper steps for the Copper (ETH) cable preparation:

1. Have the pre-assembled RJ45 cable assembly ready.

Note: Diameter of cable is in the 5.8mm to 6.8mm or 8.8mm to 9.8mm range. Make sure to select the correct gland size.

Figure 28: Pre-assembled RJ45 Cable



2. Insert the gland nut through the front end of RJ45 assembly.

Figure 29: Gland Nut on Cable

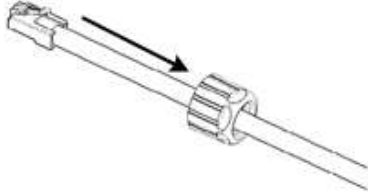

3. Insert the “split tightening cone” from the side of the cable.

Figure 30: Insert Tightening Cone on Cable

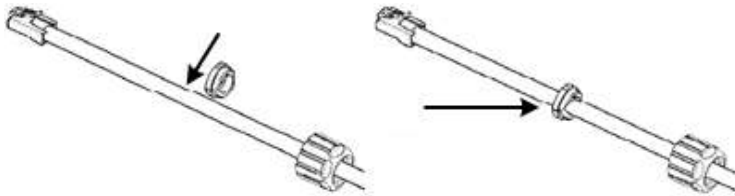

4. Insert the “split rubber gland” from side of the cable.

Note: Inner diameter of rubber gland is in the 5.8mm to 6.8mm or 8.8mm to 9.8mm range. Make sure to select the correct gland size.

Figure 31: Insert Rubber Gland on Cable

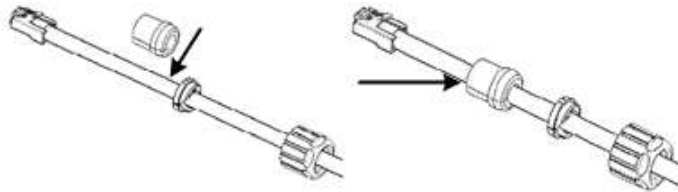

5. Insert the housing onto the RJ45 cable.

Figure 32: Insert Housing onto Cable

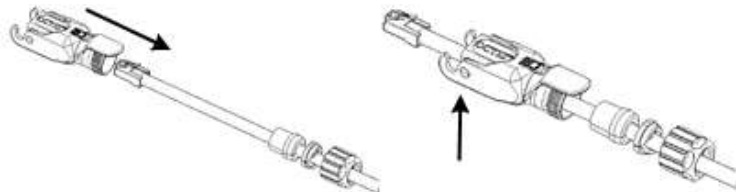

6. Insert the holder section onto the front of the RJ45.

Figure 33: Insert Holder onto RJ45

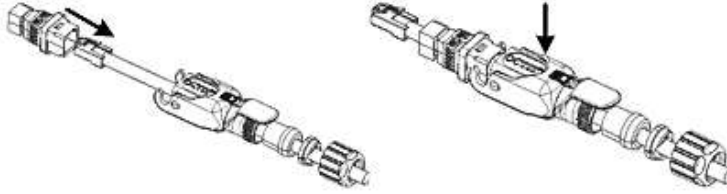

7. Fix the holder into the housing base. A “click” is heard when engaged.
-

Figure 34: Holder into Housing Base

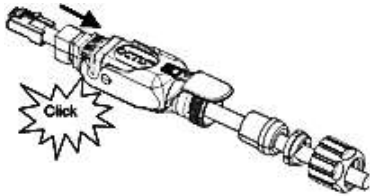

8. Ensure correct alignment of the RJ45 in the housing by raising the lever to allow free movement and then push the RJ45 plug into the plug cap to ensure proper location, then lock the cap.
-

Figure 35: Align RJ45 into Holder

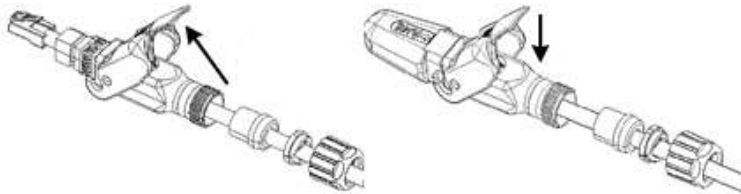

9. Lift the lever of housing base slightly so that the rubber gland, tightening cone and gland nut can be inserted and tightened correctly.
-

Figure 36: Lift Lever

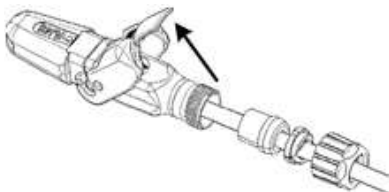

10. Push the rubber gland to insert in place then push the tightening cone to insert in place.
-

Figure 37: Insert Gland

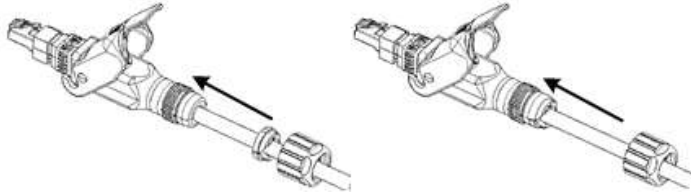

11. Tighten the gland nut with a 21mm wrench, to a torque of no more than 2-2.5 Nm (1.47 – 1.84 ft-lb) max.

Figure 38: Tighten Gland Nut

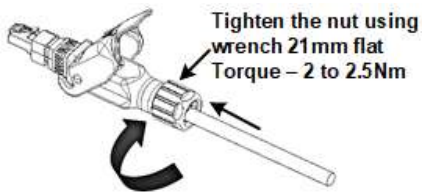

12. Insert the connector into the Copper Ethernet port on the bottom of the chassis. Verify that the connector's latch faces the rear of the unit to enable potential unlocking.
13. Close the lever and secure the lock by sliding the secondary lock/button, so that lever can't be lifted.

Figure 39: Secure Housing Lock

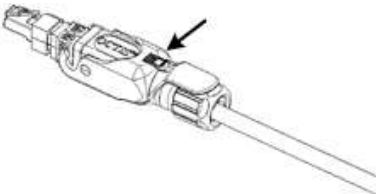

5.4 DC Cable Preparation

The following demonstrates the recommended assembly instructions, hardware and tool requirements for the proper DC cable assembly used by Airspan products.

Note: Power Cable:

- Diameter - 8.4mm to 9.4mm
- Wire Size - AWG16 to AWG14

Caution: Safety - Disconnection of power supply

- When AirSpeed unit is connected directly to wiring a suitably rated and easily accessible circuit breaker shall be incorporated externally to the equipment.
- Power source disconnection is required before disconnecting the power connector.

Warning: This unit incorporates **double pole/neutral fusing**. Both the Line & Neutral have fuses in them.

Warning: The onsite source circuit breaker (6A) should be gang operated, **two (2) pole** (single phase type).

The following displays the proper steps for DC cable preparation:

1. Strip back and remove the outer sheath to a length of $9.0\text{mm} \pm 2$ (0.35 in) to expose the inner insulated wires to a length of $13.5\text{mm} \pm 2$ (0.53 in). Then strip back $7\text{mm} \pm 2$ (0.27 in) of the inner core insulation.
-

Figure 40: Stripping Dimensions (DC Cable)

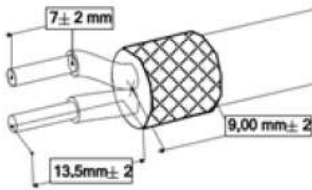

2. Open the housing lock by sliding up then lift the clamp handle.
-

Figure 41: Open Housing Lock

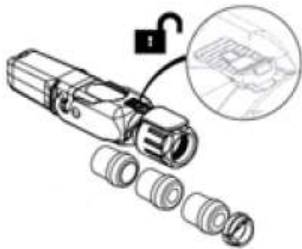

3. Separate the housing into its component sections.
-

Figure 42: Seperate into Sections

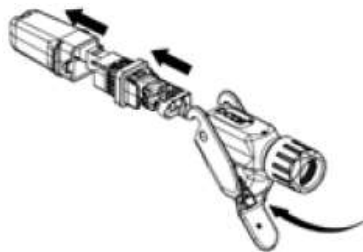

4. Insert the Gland nut through the other end of the cable.

Figure 43: Insert Gland Nut

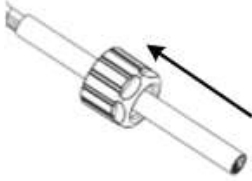

-
5. Loosen the strap clamp and feed the prepared end of the source power cable into the inner part of the DC connector housing.
-

Figure 44: Pass DC Cable Thru

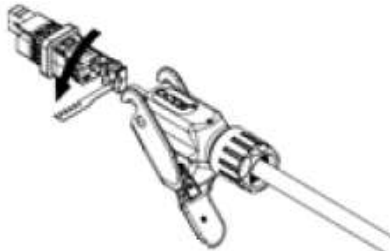

-
6. Secure the prepared ends of the cable into the inner part of the connector housing and tighten the 2 screws.
-

Caution: Verify the wire polarity before securing.

Figure 45: Tighten Two (2) Set Screws

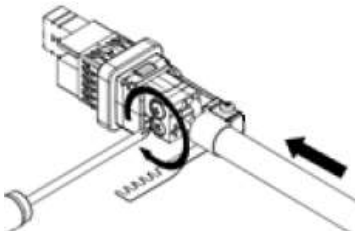

-
7. Tighten the strap clamp screw as shown below.
-

Figure 46: Tighten the Strap Clamp

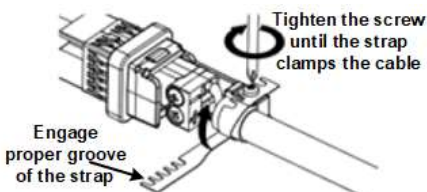

-
8. Insert into outer housing until "click" in place, align marks for proper alignment.
-

Figure 47: Align Marks + Click in Place

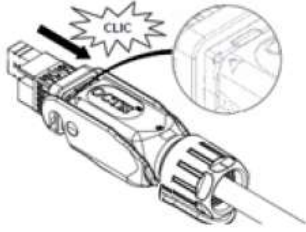

9. Place the split rubber gland onto the cable.
-

Figure 48: Place Split Rubber Gland

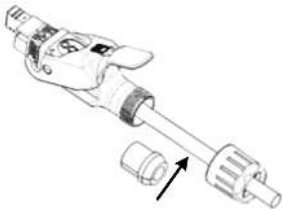

10. Place the tightening cone onto the split rubber gland.
-

Figure 49: Place Tightening Cone on Split Gland

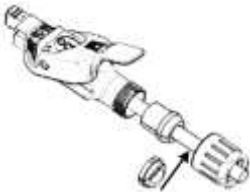

11. Tighten the gland nut with a 21mm wrench, to a torque of no more than 2-2.5 Nm (1.47 – 1.84 ft-lb) max.
-

Figure 50: Tighten gland Nut

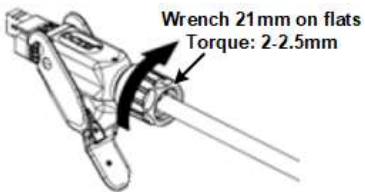

12. Insert the connector into the Power port on the bottom of the chassis. Verify that the connector's latch faces the rear of the unit to enable potential unlocking.
 13. Close the lever and secure the lock by sliding the secondary lock/button, so that lever can't be lifted.
-

Figure 51: Secure Housing Lock

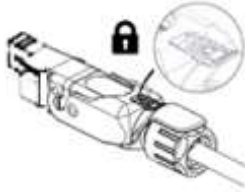

Note: When securing the cable verify there is no tension on the connector so that it is easy to disconnect and re-connect for future maintenance actions.

5.5 Remote (External) Antenna Assembly

Note: External antennas connected to AirSpeed 1030 B48 should be DC grounded.

Caution: Power down the AirSpeed unit prior to disconnecting the antenna, to prevent damage.

The AirSpeed 1030 B48 unit can utilize remotely attached antennas.

For installation of the remotely mounted antennas follow the antenna manufacturer's instructions and connect the antenna to the AirSpeed 1030 B48 using the appropriate cables. (Weather-proofed N-type Helix RF cables (ordered separately)).

1. Carefully unscrew and disconnect each of the RF cables which connect the integrated antenna to the unit.

Figure 52: Antenna RF Cables



2. Screw on a protective cap(s) on the integrated antenna cable, to prevent environmental damage, in the event they need to be re-connected. Weather-proof the caps (with a layer of self-amalgamating tape followed by an over layer of PVC tape).
3. Gather the cables securely together to prevent damage.
4. Attach, connect and secure the RF cable(s) between the external antenna and the appropriate RF connection on the top of the unit.
5. Weather-proof all cable connections, with a layer of self-amalgamating tape followed by an over layer of PVC tape. See [Weather-proofing Antenna Connections](#).

Figure 53: Connecting Antenna RF Cable



Caution: Do not over-tighten the RF connector. RF failures can result when the RF connector is over-tightened.

A Job Sheet

This job sheet enables the users to keep track of their installation. It covers all the prerequisites required for accomplishing the AirSpeed 1030 B48 installation.

Site Requirements
<ul style="list-style-type: none">○ Position on Pole / Wall○ Access restrictions (local regulations) (when applicable)○ Method of reaching pole or wall positions (ladders, Elevated work platform)○ Configuration programming details known○ Point of connection for Ethernet (if applicable)○ All equipment items available at the installation site<ul style="list-style-type: none">○ AirSpeed 1030 B48 unit○ Mounting bracket kit○ Cable assembly
Tool Requirements (For further information, see Verify the Tools.)
<ul style="list-style-type: none">○ Large flat bladed screw driver○ 13 mm wrench○ 10 mm or 13/32 inch wrench○ Large pliers○ Hammer (to insert and set the wall plugs)
Required Ancillary Equipment
<ul style="list-style-type: none">○ Laptop PC for initial configuration○ Ethernet cable for temporary connection of the lap top

B Checklist

During installation, review and perform all the steps on this checklist (in the given order). This checklist is meant for the person who performs the AirSpeed 1030 B48 installation.

Tip: To make sure you complete all the tasks, detach or print this checklist and use it as a job aid. After performing, check off each task.

Procedure	Action	Check If Performed
Verify the prerequisites	Verify the site requirements.	<input type="checkbox"/>
	Verify the installation requirements.	<input type="checkbox"/>
	Verify the tool requirements.	<input type="checkbox"/>
	Verify the parts & kits required.	<input type="checkbox"/>
AirSpeed 1030 B48 installation	Install the back bracket and then the Pole/Wall bracket	<input type="checkbox"/>
	Install AirSpeed 1030 B48 on the mounting bracket (as required).	<input type="checkbox"/>
Connect & manage Cables	Connect SFP or Copper cable (depending on the variant)	<input type="checkbox"/>
Connect power system	Connect power cable	<input type="checkbox"/>

C Abbreviations

Table 11: ABBREVIATIONS & DEFINITIONS

Term	Expansion
3GPP	3rd Generation Partnership Project, responsible for LTE
AWGN	Additive White Gaussian Noise is a channel model in which the only impairment to communication is a linear addition of white noise with a constant spectral density and a Gaussian distribution of amplitude.
BER	Bit Error Rate
dB	Decibel. A logarithmic unit used to describe a ratio (such as power ratio in radio telecommunications)
dBm	An abbreviation for the power ratio in decibels (dB) of the measured power referenced to one milliwatt (mW). It is used as a convenient measure of absolute power because of its capability to express both very large and very small values in a short form
eNodeB	Evolved Node B, is the element in E-UTRAN of LTE
ESP	Encapsulating Security Payloads (ESP) provide confidentiality, data-origin authentication, connectionless integrity, an anti-replay service (a form of partial sequence integrity), and limited traffic-flow confidentiality
E-UTRAN	Evolved Universal Terrestrial Radio Access Network, is the air interface of 3GPP's Long Term Evolution
FDD	Frequency-Division Duplexing. A transceiver mode where the transmitter and receiver operate at different carrier frequencies
GNSS	Global Navigation Satellite System is a term used to describe a satellite navigation system with global coverage. There are currently two fully operational GNSSs – the US GPS and the Russian GLONASS.
HPBW	Half Power Beam Width is the angular separation in an antenna, in which the magnitude of the radiation pattern decreases by 50% (or -3 dB) from the peak of the main beam
IPSec	Internet Protocol Security is a protocol suite for securing Internet Protocol (IP) communications by authenticating and encrypting each IP packet of a communication session
LED	Light Emitting Diode
LTE	Long Term Evolution
MAC	Medium Access Controller – responsible for several functions such Scheduling, Packet (De)Multiplexing, etc...

Term	Expansion
MME	Mobility Management Entity is the key control-node for the LTE access-network. It is responsible, among other things for idle mode UE tracking and paging procedure including retransmissions
MTBF	Mean Time Between Failures
NL	Network Listening
OFDMA	Orthogonal Frequency-Division Multiple Access (OFDMA) is a multiple access version of OFDM digital modulation scheme, used for eNodeB transmissions to UEs
PDU	Protocol Data Unit
PTP	Precision Time Protocol is used to synchronize clocks throughout a network. In this document, PTP is referring to IEEE1588-2008 protocol
ROHS	Restriction Of Hazardous Substances
S-GW	Serving Gateway. A Core entity in the LTE EPC architecture responsible for routing and forwarding user data packets, while also acting as the mobility anchor for the user plane during inter-eNodeB handovers and as the anchor for mobility between LTE and other 3GPP technologies
SC-FDMA	Single-Carrier FDMA is a frequency-division multiple access scheme, dealing with the assignment of multiple users to a shared communication resource. Used in LTE for UE transmissions to the eNodeB
SDR	Software Defined Radio
TDD	Time-Division Duplexing. A transceiver mode where the transmitter and receiver operate on the same carrier frequency
UE	User Equipment. The end user in LTE
WEEE	Waste Electrical and Electronic Equipment