



HERMON LABORATORIES



Electrical

Hermon Laboratories Ltd.
P.O.Box 23
Binyamina 30500, Israel
Tel. +972 4628 8001
Fax. +972 4628 8277
e-mail: mail@hermonlabs.com

RADIO TEST REPORT

according to 47CFR Parts 2, 27 and Part 15, subpart B
for

Airspan Networks (Israel) Ltd.

EQUIPMENT UNDER TEST:

Base station radio unit

Model: BSR 700MHz TDD Ext

This report is in conformity with ISO/IEC 17025. The A2LA logo endorsement applies only to the test methods and the standards that are listed in the scope of Hermon Laboratories accreditation.
The test results relate only to the items tested. **This test report must not be reproduced in any form except in full with the approval of Hermon Laboratories Ltd.**



Contents

1	Project information.....	3
2	Summary of tests and signatures.....	4
3	EUT description	6
3.1	GENERAL INFORMATION	6
3.2	EUT TEST CONFIGURATION	6
4	Test results.....	8
4.1	PEAK OUTPUT POWER TEST	8
4.2	FREQUENCY STABILITY TEST	11
4.3	OCCUPIED BANDWIDTH TEST	13
4.4	SPURIOUS EMISSIONS AT RF ANTENNA CONNECTOR TEST.....	22
4.5	RADIATED SPURIOUS EMISSION MEASUREMENTS	45
4.6	CONDUCTED EMISSIONS	67
4.7	ANTENNA POWER CONDUCTED MEASUREMENTS FOR RECEIVER	71
4.8	RADIATED EMISSION MEASUREMENTS	76
APPENDIX A	Test equipment used for tests.....	81
APPENDIX B	Measurement uncertainties	83
APPENDIX C	Test facility description.....	84
APPENDIX D	Specification references	84
APPENDIX E	Abbreviations and acronyms.....	85
APPENDIX F	Test equipment correction factors.....	86



1 Project information

EUT attributes

Test item	Base station radio unit
Type (Model)	BSR 700MHz TDD Ext
Equipment FCC code	TNB

Applicant information

Applicant's responsible person	Mr. Zion Levi, compliance & testing engineer
Applicant/Manufacturer	Airspan Networks (Israel) Ltd.
Address	1, Harava street, "Unitronics" building
P.O.B.	199
City	Airport City
Postal code	70100
Country	Israel
Telephone number	+972 3977 7444
Telefax number	+972 3977 7400

Test details

Project number	15799
Location	Hermon Laboratories
Test started	February 22, 2004
Test completed	March 11, 2004
Purpose of test	Apparatus compliance verification in accordance with emission requirements
Test specifications	47CFR Parts 2, 27, 15 subpart B



2 Summary of tests and signatures

The tests listed in the table below were performed.
The EUT was found complying with the limits of 47CFR Parts 2, 27, 15 subpart B.

Test description	Specification reference	Limits			Test report paragraph	Verdict
Intentional radiation						
Peak output power at RF antenna connector	2.1046, 27.50c(1)(i)	Frequency, MHz	Limit, dBm		4.1	Pass
			Conducted power	ERP, dBm		
		F _{low} = 699.5	ERP-11.85 dBd (antenna gain)	60.0, providing antenna height <305 m		
		F _{mid} = 720.5				
F _{high} = 744.5						
Frequency stability	2.1055, 27.54	Temperature, °C	Voltave, V	Limit	4.2	Pass
		-30	U _{nom}	26 dBc points including frequency tolerance shall remain within the assigned band		
		-20	U _{nom}			
		-10	U _{nom}			
		0	U _{nom}			
		10	U _{nom}			
		20	0.85 U _{nom}			
		20	U _{nom}			
		20	1.15 U _{nom}			
		30	U _{nom}			
		40	U _{nom}			
50	U _{nom}					
Occupied bandwidth	2.1049	Frequency, MHz	Attenuation versus carrier, dBc		4.3	Pass
		F _{low} = 699.5	26			
		F _{mid} = 720.5				
		F _{high} = 744.5				
Spurious emissions RF antenna connector	2.1047, 2.1051, 27.53f	Frequency	Attenuation versus carrier, dBc	RBW	4.4	Pass
		9 kHz – 7.5 GHz	43+10logP	100 kHz (30 kHz for allotted band and band edges)		
Spurious emissions (radiated)	2.1053, 27.53f	Frequency	Attenuation versus carrier, dBc	RBW	4.5	Pass
		9 kHz – 7.5 GHz	43+10logP	100 kHz		



Test description	Specification reference	Limits		Test report paragraph	Verdict	
Unintentional radiation						
Conducted emissions at AC power port	15.107	Frequency, MHz	Class B limit, dBuV		4.6	Pass
			QP	AVR		
		0.15 – 0.5	66 – 56	56 – 46		
		0.5 – 5.0	56	46		
		5.0 – 30	60	50		
Antenna power conducted measurements for receiver	15.111	Receiver operating in 30 – 960 MHz		4.7	Pass	
		Frequency, MHz	Power limit, nW (dBm)			
		30 – 2200 (2 nd harmonic of LO)	2 (-57)			
Radiated emissions	15.109	Frequency, MHz	Class B limit dBuV/m		4.8	Pass
		30 – 88	40.0			
		88 – 216	43.5			
		216 – 960	46.0			
		960 – 2200 (2 nd harmonic of LO)	54.0			

Test report prepared by:

Ms. N. Averin, MA, certification engineer

Test report approved by:

Mr. Michael Nikishin, MScEE, group leader

Mr. Edward Usoskin, PhD, C.E.O.



3 EUT description

3.1 General information

A base station radio, BSR 700MHz TDD Ext, is a part of a WipLL broadband fixed cellular wireless access system. The system provides a radio link between an end-user (a subscriber) and a network itself to give high-speed data access. The EUT is a transceiver (FSK digital modulation, data rate 1, 2, 3 Mbps or 1.33, 4 Mbps), operating in 698 MHz to 746 MHz range, equipped with a 14 dBi (11.85 dBd) gain external panel antenna. It is installed outside the base station site and typically is mounted on a pole.

The BSR is powered via a subscriber data adapter (SDA), which provides 48 V DC power.

3.2 EUT test configuration

The EUT ports and lines description is given in Table 3.2.1 and system/test configuration is shown in Figures 3.2.1, 3.2.2.

The device operating frequencies generated by clocks and oscillators are provided in Table 3.2.2.

Table 3.2.1

EUT ports and lines

Port type	Port description	Connector type	Quantity	Cable type	Cable length, m	Indoor / outdoor	Connected to
Data + DC	48 VDC + Ethernet	D type 15 pin	2	Cat. 5 – 4x2 twisted pair	100	Outdoor	SDA
Antenna	RF output / input	N type to 7/16	1	RG-58	1.5	Outdoor	External antenna

Table 3.2.2

EUT operating frequencies

Frequency, MHz	Identification
699.5	F_{low}
720.5	F_{mid}
744.5	F_{high}
322	IF1
6	IF2
20	Oscillator
48	Oscillator
1021.5	LO1 ($IF1 + F_{low}$)
1042.5	LO1 ($IF1 + F_{mid}$)
1066.5	LO1 ($IF1 + F_{high}$)
328	LO2



Figure 3.2.1

General WipLL system configuration

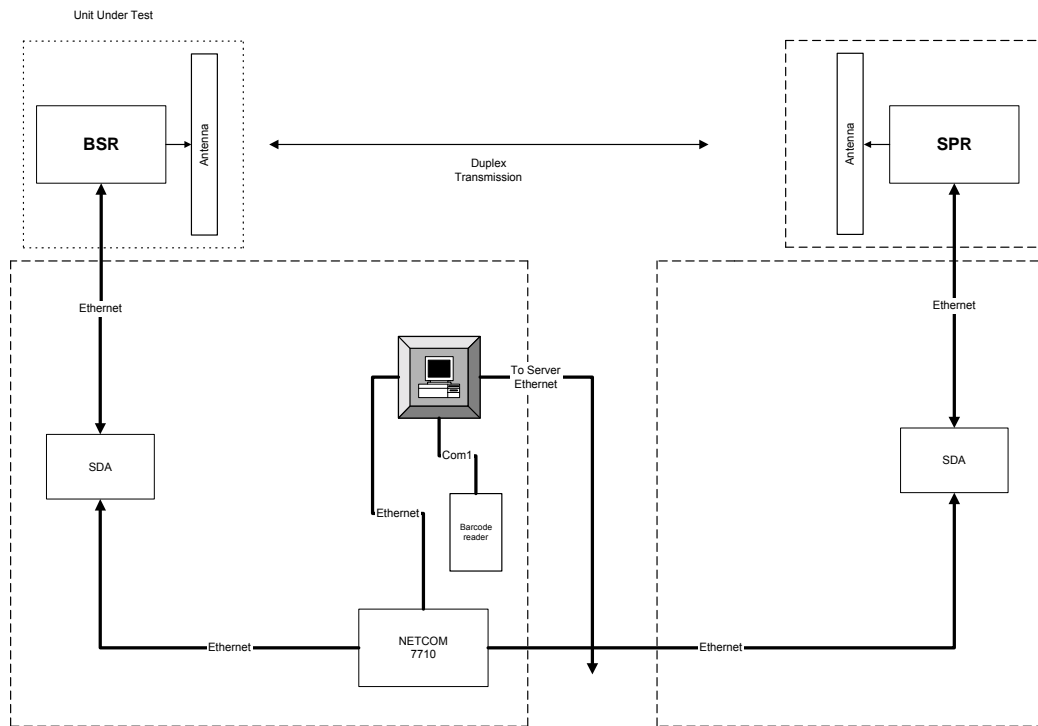
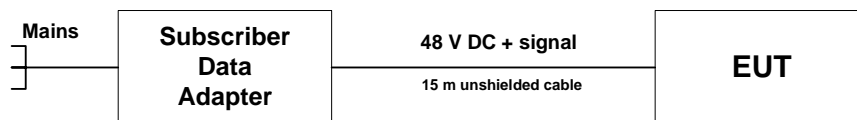

Figure 3.2.2

EUT test configuration for conducted emission at AC line measurements





4 Test results

4.1 Peak output power test

4.1.1 General

This test was performed to measure the peak output power at RF antenna connector. Specification test limits are given in Table 4.1.1. The test results are provided in Table 4.1.2 and associated plots.

Table 4.1.1 Peak output power limits

Assigned frequency range, MHz	ERP, dBm
698 - 746	60

4.1.2 Test procedure

4.1.2.1 The EUT was set up as shown in Figure 4.1.1, energized and its proper operation was checked.

4.1.2.2 The EUT was adjusted to produce maximum available for end user RF output power.

4.1.2.3 The peak output power was measured with spectrum analyzer as provided in Table 4.1.2 and associated plots.

Figure 4.1.1 Peak output power test setup

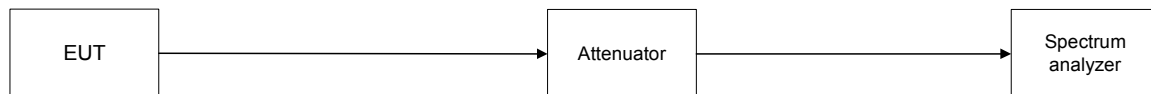



Table 4.1.2 Peak output power test results

OPERATING FREQUENCY RANGE: 698 – 746 MHz
 DETECTOR USED: Peak
 RESOLUTION BANDWIDTH: 1 MHz
 VIDEO BANDWIDTH: 3 MHz
 MODULATION: Unmodulated
 MODULATING SIGNAL: NA
 TRANSMITTER OUTPUT POWER SETTINGS: Maximum

Carrier frequency, MHz	RF output power, dBm	ERP*, dBm	ERP limit, dBm	Margin, dB	Verdict
699	31.50	43.35	60.00	16.65	Pass
721	31.83	43.68	60.00	16.32	Pass
745	31.67	43.52	60.00	16.48	Pass

* ERP (dBm) = RF output power (dBm) + antenna gain (dBd),
 where antenna gain declared by customer is 14 dBi, which equals to 11.85 dBd

Reference numbers of test equipment used

HL 0057	HL 1424	HL 2254					
---------	---------	---------	--	--	--	--	--

Full description is given in Appendix A.

Plot 4.1.1 Peak output power test results at low frequency

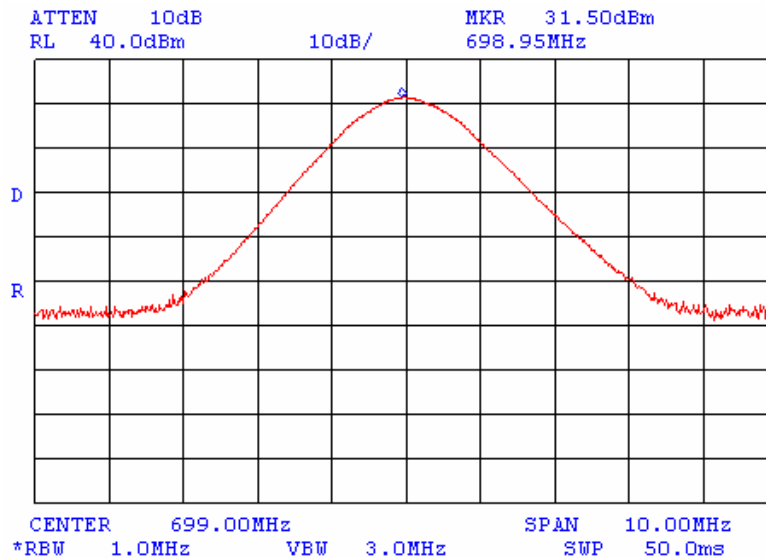



Plot 4.1.2 Peak output power test results at mid frequency

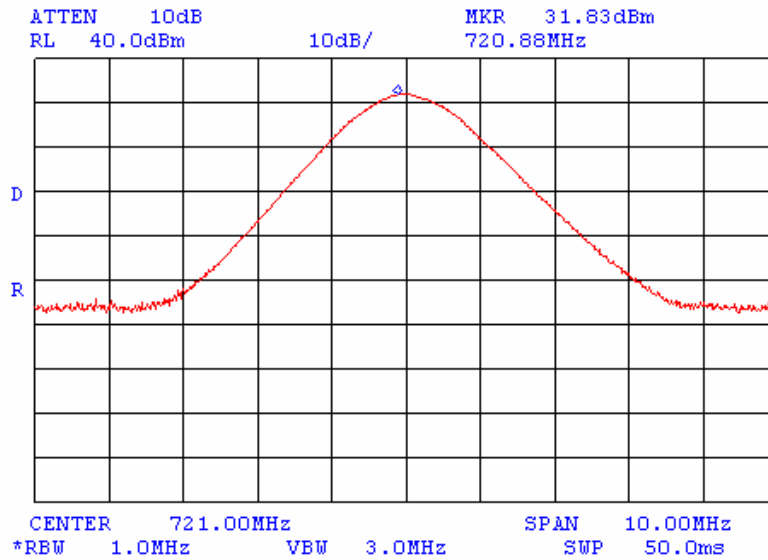

Plot 4.1.3 Peak output power test results at high frequency

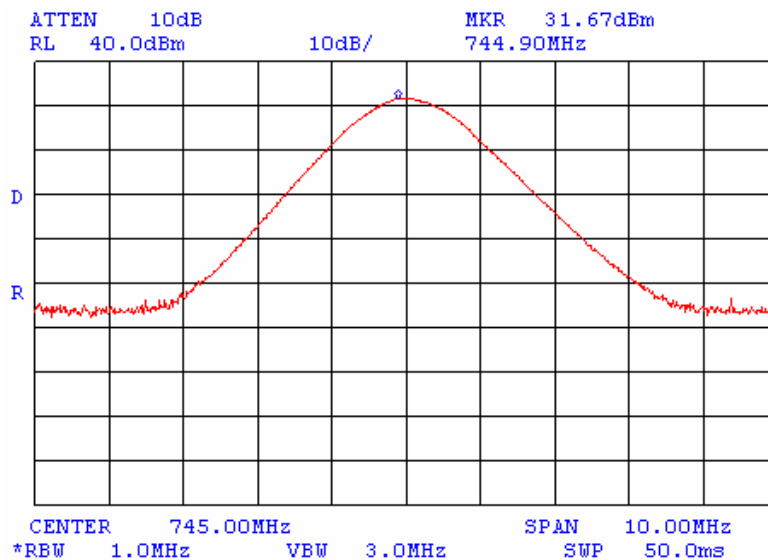



4.2 Frequency stability test

4.2.1 General

This test was performed to measure frequency stability of transmitter RF carrier. Specification test limits are given in Table 4.2.1. The test results are provided in Table 4.2.2.

Table 4.2.1 Frequency stability limits

Assigned frequency, MHz	Maximum allowed frequency displacement
699	26 dBc points including frequency tolerance shall remain within the assigned band
721	
745	

4.2.2 Test procedure

- 4.2.2.1 The EUT was set up as shown in Figure 4.2.1, energized and its proper operation was checked.
- 4.2.2.2 The EUT power was turned off. Temperature within test chamber was set to +30°C and a period of time sufficient to stabilize all of the oscillator circuit components was allowed.
- 4.2.2.3 The EUT was powered on and carrier frequency was measured at start up moment and then every minute until frequency had been stabilized or 10 minutes elapsed whichever reached the last. The EUT was powered off.
- 4.2.2.4 The above procedure was repeated at 0°C and at the lowest test temperature.
- 4.2.2.5 The EUT was powered on and carrier frequency was measured at start up moment and at the end of stabilization period at the rest of test temperatures and voltages. The EUT was powered off.
- 4.2.2.6 Frequency displacement was calculated as provided in Table 4.2.2.

Figure 4.2.1 Frequency stability test setup

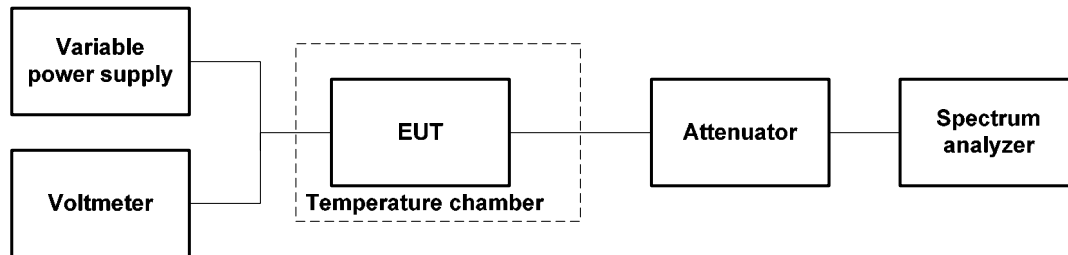



Table 4.2.2 Frequency stability test results

OPERATING FREQUENCY RANGE: 698 – 746 MHz
NOMINAL POWER VOLTAGE: 48V
TEMPERATURE STABILIZATION PERIOD: 10 min
POWER DURING TEMPERATURE TRANSITION: Off
SPECTRUM ANALYZER MODE: Counter
MODULATION: Unmodulated

T, °C	Voltage, V	Frequency, Hz				Positive drift, Hz	Negative drift, Hz	Max frequency drift, Hz	Min frequency drift, Hz
		Start up	2 nd min	5 th min	10 th min				
Low frequency									
-30	nominal	698998986	698999738	699000096	699000254	231	-1037	3366	-3898
-20	nominal	699002254	699002517	699002571	699002779	2756	2231		
-10	nominal	699003362	699003378	699003389	699003381	3366	3339		
0	nominal	699003183	699003087	699002995	699002945	3160	2922		
10	nominal	699002202	699001994	699001807	699001709	2179	1686		
20	+15%	699000427	699000268	699000096	699000019	404	-4		
20	nominal	699000540	699000329	699000114	699000023*	517	0		
20	-15%	699000509	699000285	699000106	699000019	486	-4		
30	nominal	698998683	698998454	698998290	698998173	-1340	-1850		
40	nominal	698997226	698997065	698996924	698996851	-2797	-3172		
50	nominal	698996240	698996164	698996134	698996125	-3783	-3898		
Mid frequency									
-30	nominal	720999404	720999858	721000208	721000356	372	-580	3497	-3960
-20	nominal	721002430	721002614	721002807	7211002879	2895	2446		
-10	nominal	721003455	721003471	721003478	721003481	3497	3471		
0	nominal	721003173	721003116	721003040	721002998	3189	3014		
10	nominal	721002113	721001947	721001796	721001719	2129	1735		
20	+15%	721000409	721000239	721000067	720999979	425	-5		
20	nominal	721000593	721000277	721000091	720999984*	609	0		
20	-15%	721000559	721000235	721000089	720999992	575	8		
30	nominal	720998318	720998221	720998082	720998048	-1666	-1936		
40	nominal	720997078	720996924	720996774	720996731	-2906	-3253		
50	nominal	720996146	720996071	720996035	720996024	-3838	-3960		
High frequency									
-30	nominal	744999266	744999714	745000079	745000263	248	-749	3582	-4103
-20	nominal	745002470	745002761	745002892	745002917	2902	2455		
-10	nominal	745003554	745003579	745003585	745003597	3582	3539		
0	nominal	745003348	745003266	745003181	745003141	3333	3126		
10	nominal	745002180	745002047	745001887	745001823	2165	1808		
20	+15%	745000433	745000269	745000104	745000029	418	14		
20	nominal	745000365	745000237	745000094	745000015*	350	0		
20	-15%	745000437	745000291	745000107	745000036	422	21		
30	nominal	744998172	744998198	744998204	744998131	-1811	-1884		
40	nominal	744996986	744996855	744996723	744996664	-3029	-3351		
50	nominal	744669062	744995975	744995924	744995912	-3953	-4103		

* - Reference frequency

6-MHz channel, MHz	Measured 26 dBc point, MHz	Frequency drift, Hz		26 dBc point including frequency tolerance, MHz	Verdict
		Positive	Negative		
698 – 704	698.12	NA	-3898	698.116102	Pass
716 – 722	721.87	3497	NA	721.873497	Pass
740 – 746	745.88	3582	NA	745.883582	Pass

Reference numbers of test equipment used

HL 0026	HL 0057	HL 0493	HL 0559	HL 1207	HL 1458		
---------	---------	---------	---------	---------	---------	--	--

Full description is given in Appendix A.



4.3 Occupied bandwidth test

4.3.1 General

This test was performed to measure transmitter occupied bandwidth. Specification test limits are given in Table 4.3.1. The test results are provided in Table 4.3.2 and associated plots.

Table 4.3.1 Occupied bandwidth limits

Assigned frequency, MHz	Modulation envelope reference points*, dBc
699	26
721	
745	

* - Modulation envelope reference points provided in terms of attenuation below unmodulated carrier.

4.3.2 Test procedure

4.3.2.1 The EUT was set up as shown in Figure 4.3.1, energized and its proper operation was checked.

4.3.2.2 The EUT was set to transmit unmodulated carrier and reference peak power level was measured.

4.3.2.3 The EUT was set to transmit modulated carrier.

4.3.2.4 The transmitter occupied bandwidth was measured with spectrum analyzer as frequency delta between reference points on modulation envelope and provided in Table 4.3.2 and associated plots.

Figure 4.3.1 Occupied bandwidth test setup

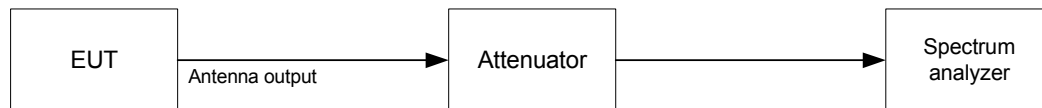



Table 4.3.2 Occupied bandwidth test results

DETECTOR USED: Peak hold
RESOLUTION BANDWIDTH: 100 kHz
VIDEO BANDWIDTH: 300 kHz
MODULATION ENVELOPE REFERENCE POINTS: 26 dBc
MODULATION: FSK
MODULATING SIGNAL: PRBS

BIT RATE: 4 Mbps

Carrier frequency, MHz	Occupied bandwidth, MHz
699	1.75
721	1.77
745	1.76

BIT RATE: 1.33 Mbps

Carrier frequency, MHz	Occupied bandwidth, MHz
721	1.75

BIT RATE: 1 Mbps

Carrier frequency, MHz	Occupied bandwidth, MHz
721	1.32

BIT RATE: 2 Mbps

Carrier frequency, MHz	Occupied bandwidth, MHz
721	1.32

BIT RATE: 3 Mbps

Carrier frequency, MHz	Occupied bandwidth, MHz
721	1.32

The 4 Mbps rate was used for full measurements as the worst case.

Reference numbers of test equipment used

HL 0057	HL 1424	HL 2254				
---------	---------	---------	--	--	--	--

Full description is given in Appendix A.



Plot 4.3.1 Occupied bandwidth test results at low frequency

Band edge: Left
Bit rate: 4 Mbps

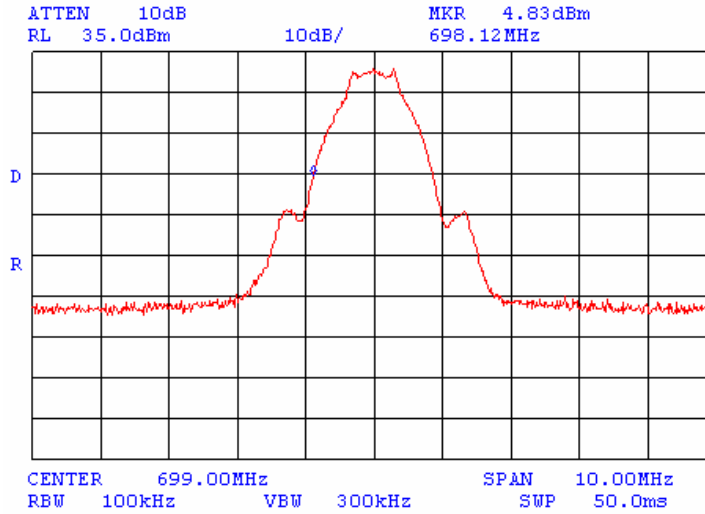

Plot 4.3.2 Occupied bandwidth test results at low frequency

Band edge: Right
Bit rate: 4 Mbps

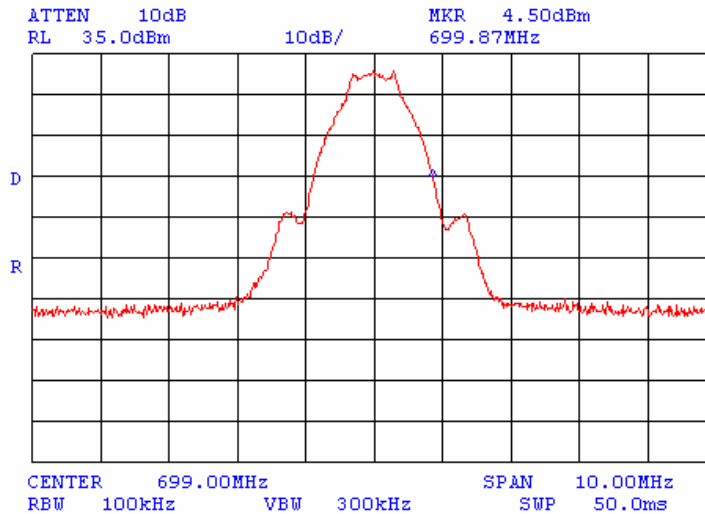



Plot 4.3.3 Occupied bandwidth test results at mid frequency

Band edge: Left
Bit rate: 4 Mbps

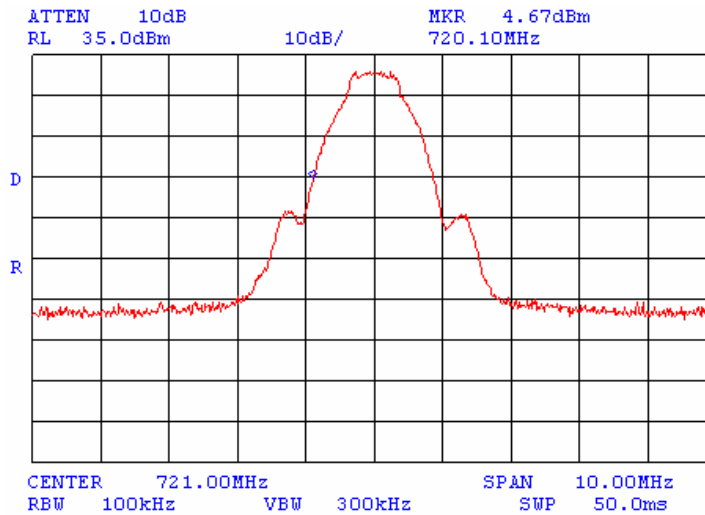

Plot 4.3.4 Occupied bandwidth test results at mid frequency

Band edge: Right
Bit rate: 4 Mbps

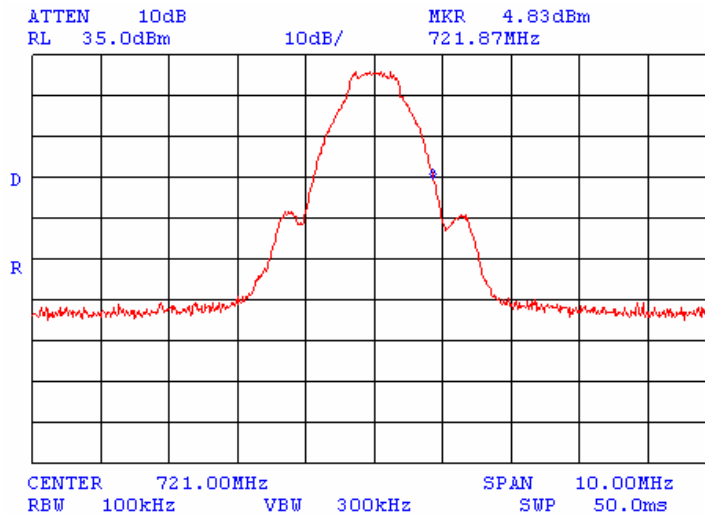



Plot 4.3.5 Occupied bandwidth test results at high frequency

Band edge: Left
Bit rate: 4 Mbps

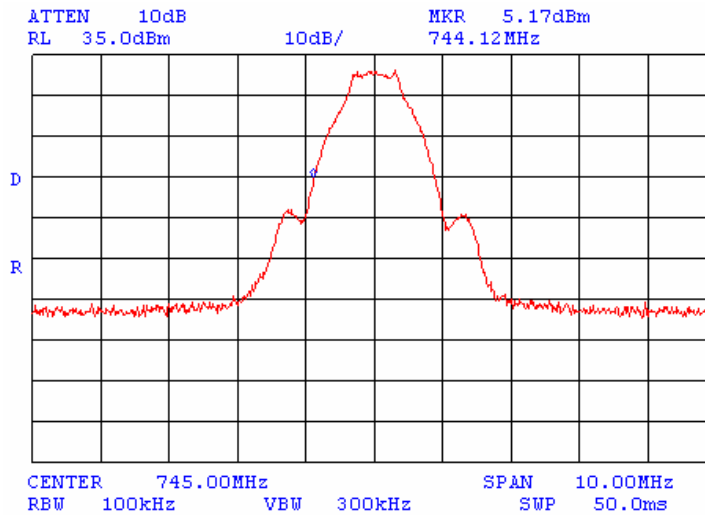

Plot 4.3.6 Occupied bandwidth test results at high frequency

Band edge: Right
Bit rate: 4 Mbps

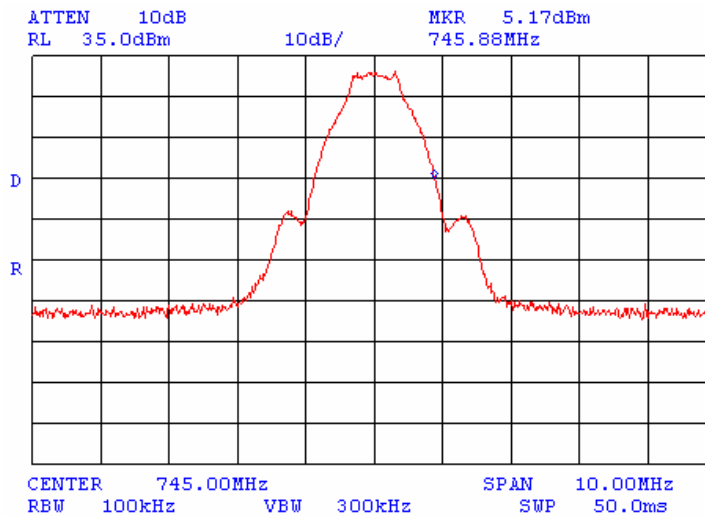



Plot 4.3.7 Occupied bandwidth test results at mid frequency

Band edge: Left
Bit rate: 1.33 Mbps

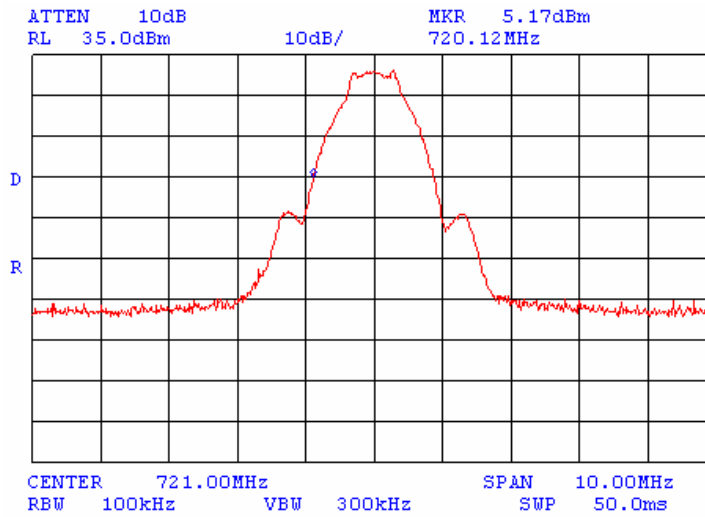

Plot 4.3.8 Occupied bandwidth test results at mid frequency

Band edge: Right
Bit rate: 1.33 Mbps

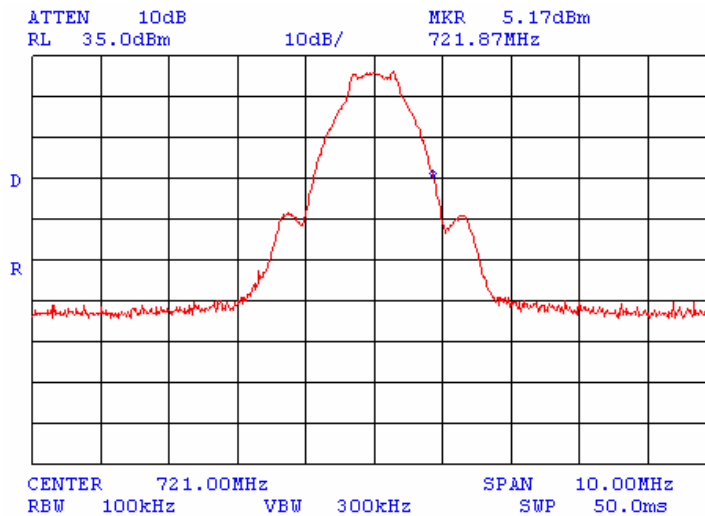



Plot 4.3.9 Occupied bandwidth test results at mid frequency

Band edge: Left
Bit rate: 1 Mbps

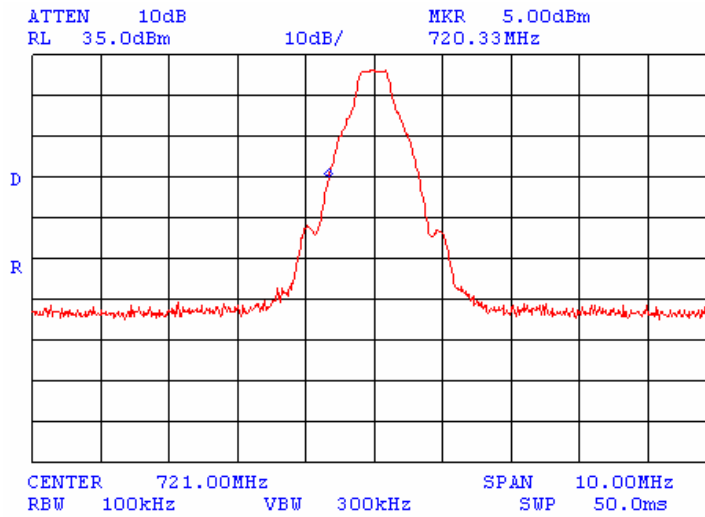

Plot 4.3.10 Occupied bandwidth test results at mid frequency

Band edge: Right
Bit rate: 1 Mbps

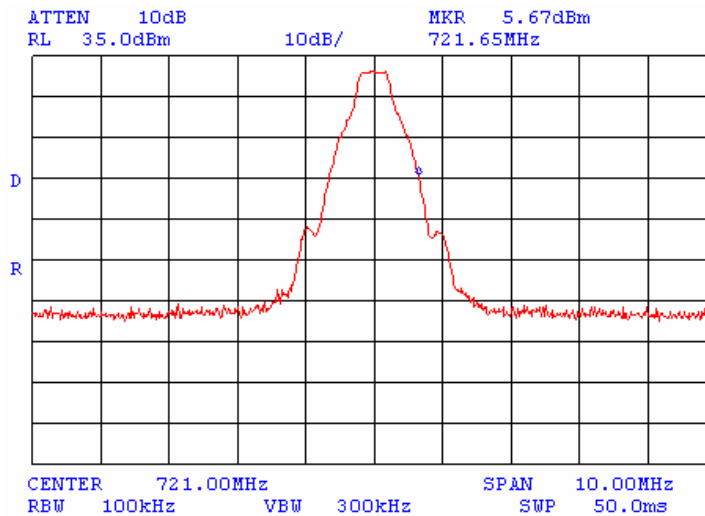



Plot 4.3.11 Occupied bandwidth test results at mid frequency

Band edge: Left
Bit rate: 2 Mbps

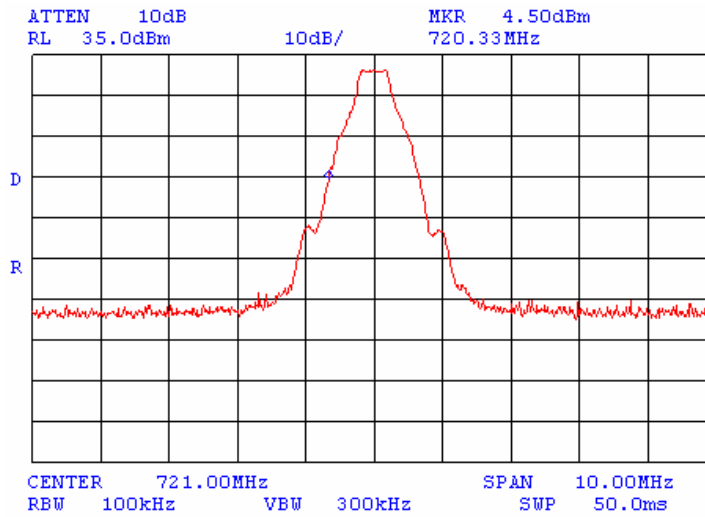

Plot 4.3.12 Occupied bandwidth test results at mid frequency

Band edge: Right
Bit rate: 2 Mbps

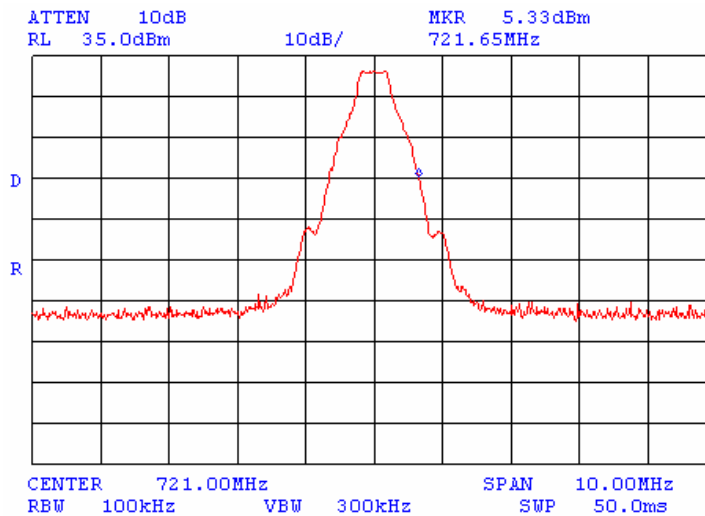



Plot 4.3.13 Occupied bandwidth test results at mid frequency

Band edge: Left
Bit rate: 3 Mbps

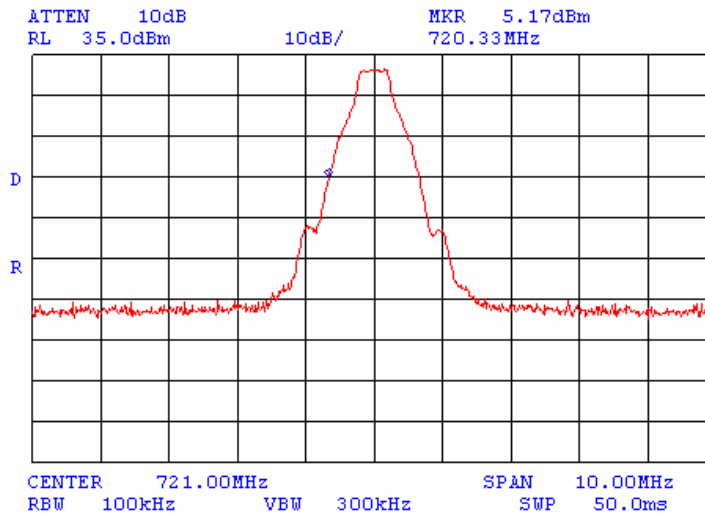

Plot 4.3.14 Occupied bandwidth test results at mid frequency

Band edge: Right
Bit rate: 3 Mbps

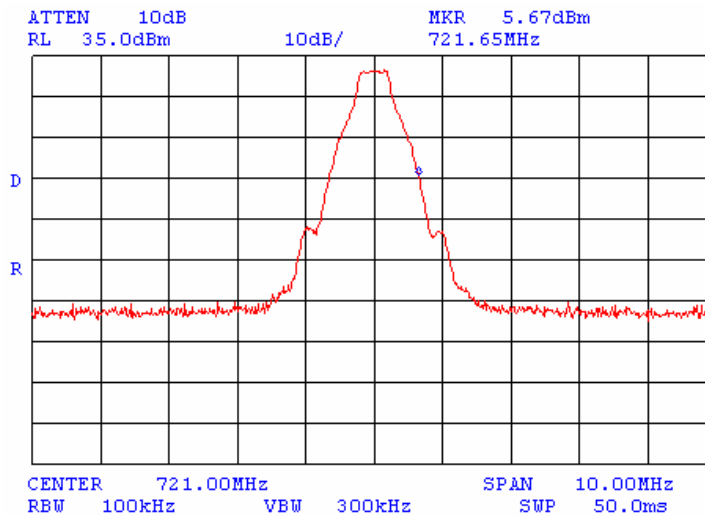



4.4 Spurious emissions at RF antenna connector test

4.4.1 General

This test was performed to measure spurious emissions at RF antenna connector. Specification test limits are given in Table 4.4.1. The test results are provided in Table 4.4.2 and associated plots.

Table 4.4.1 Spurious emission limits

Frequency, MHz*	Attenuation below carrier, dBc	Spurious emissions, dBm
0.009 – 10 th harmonic	43+10logP*	-13

* - P is transmitter output power in Watts.

4.4.2 Test procedure

4.4.2.1 The EUT was set up as shown in Figure 4.4.1, energized and its proper operation was checked.

4.4.2.2 The EUT was adjusted to produce maximum available for end user RF output power.

4.4.2.3 The spurious emission was measured with spectrum analyzer as provided in Table 4.4.2 and associated plots.

Figure 4.4.1 Spurious emission test setup

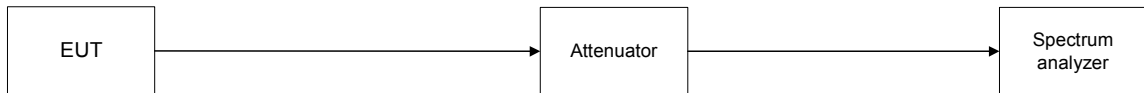



Table 4.4.2 Spurious emission test results

ASSIGNED FREQUENCY RANGE: 698 – 746 MHz
INVESTIGATED FREQUENCY RANGE: 0.009 – 7500 MHz
DETECTOR USED: Peak
VIDEO BANDWIDTH: ≥ Resolution bandwidth
MODULATION: Unmodulated (at band edges – FSK modulated)
MODULATING SIGNAL: NA (at band edges – PRBS)
BIT RATE: 3, 4 Mbps (for measurements at band edges)
TRANSMITTER OUTPUT POWER SETTINGS: Maximum
TRANSMITTER OUTPUT POWER: 31.33 dBm at low frequency
31.83 dBm at mid frequency
31.67 dBm at high frequency

Frequency, MHz	Bit rate, Mbps	RBW, kHz	Spurious emission, dBm	Limit, dBm	Margin, dB*	Verdict
Low channel						
0.792	—	100	-29.17	-13.00	-16.17	Pass
697.862	3	100	-26.83	-13.00	-13.83	Pass
697.894	4	100	-18.33	-13.00	-5.33	Pass
697.988	3	30	-31.00	-13.00	-17.00	Pass
698.000	4	30	-17.00	-13.00	-4.00	Pass
704.001	3	30	-30.33	-13.00	-17.33	Pass
704.004	4	30	-17.33	-13.00	-4.33	Pass
704.101	4	100	-18.83	-13.00	-5.83	Pass
704.128	3	100	-27.00	-13.00	-14.00	Pass
Mid channel						
0.791	—	100	-29.17	-13.00	-16.17	Pass
715.475	3	100	-26.67	-13.00	-13.67	Pass
715.891	4	100	-17.67	-13.00	-4.67	Pass
715.984	3	30	-30.67	-13.00	-17.67	Pass
715.999	4	30	-16.83	-13.00	-3.83	Pass
722.001	3	30	-30.83	-13.00	-17.83	Pass
722.004	4	30	-16.83	-13.00	-3.83	Pass
722.100	4	100	-19.17	-13.00	-6.17	Pass
722.178	3	100	-27.17	-13.00	-14.17	Pass
1442.003	—	100	-33.50	-13.00	-20.50	Pass
High channel						
0.801	—	100	-29.33	-13.00	-16.33	Pass
739.892	4	100	-17.67	-13.00	-4.67	Pass
739.900	3	100	-26.50	-13.00	-13.50	Pass
739.987	3	30	-30.50	-13.00	-17.50	Pass
739.990	4	30	-17.17	-13.00	-4.17	Pass
746.000	3	30	-30.50	-13.00	-17.50	Pass
746.000	4	30	-16.83	-13.00	-3.83	Pass
746.104	4	100	-19.50	-13.00	-6.50	Pass
746.445	3	100	-26.83	-13.00	-13.83	Pass
1489.992	—	100	-30.83	-13.00	-17.83	Pass
5215.003	—	100	-32.17	-13.00	-19.17	Pass

*- Margin = Spurious emission – specification limit.

Emissions at the band edges are provided in Plots 4.4.19 to 4.4.42.

Reference numbers of test equipment used

HL 0057	HL 1424	HL 2254				
---------	---------	---------	--	--	--	--

Full description is given in Appendix A.



Plot 4.4.1 Spurious emission measurements at RF antenna connector, low channel

Frequency range: 9 – 150 kHz

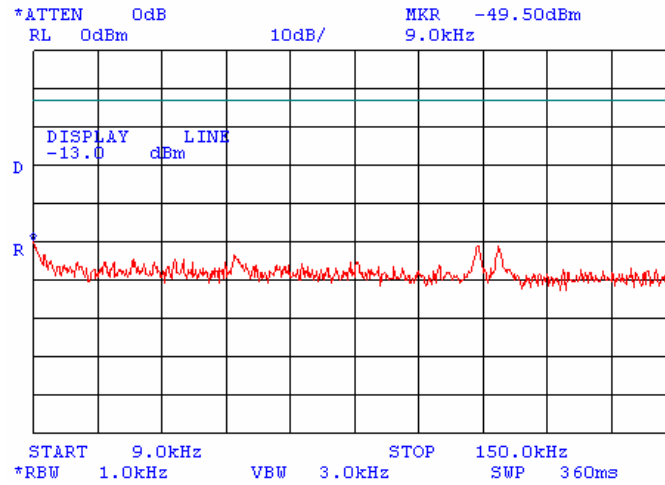

Plot 4.4.2 Spurious emission measurements at RF antenna connector, low channel

Frequency range: 0.15 – 30 MHz

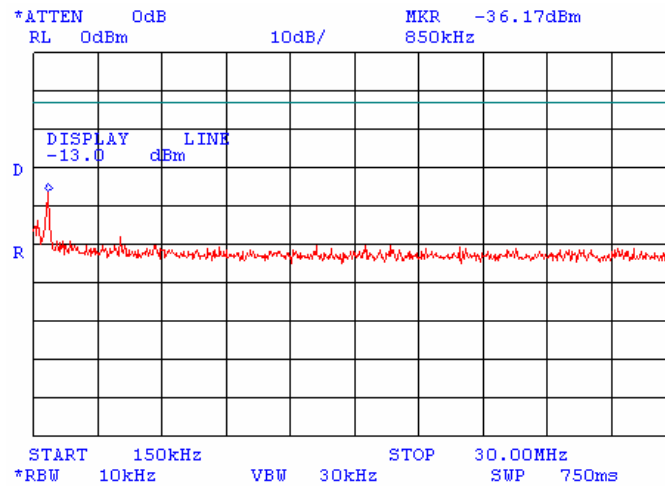



Plot 4.4.3 Spurious emission measurements at RF antenna connector, low channel

Center frequency: 795.8 kHz

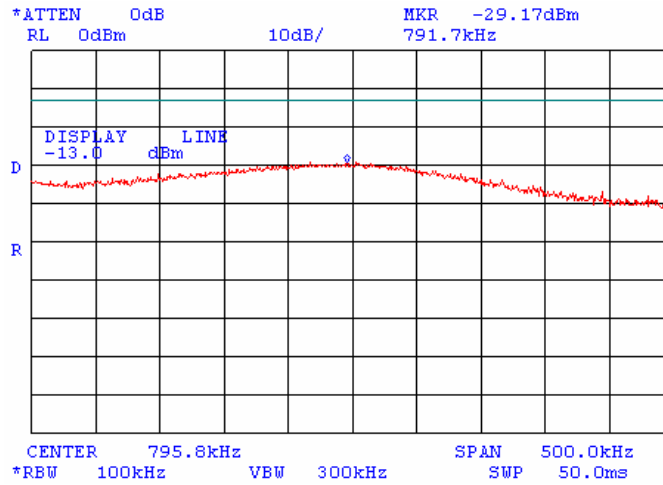

Plot 4.4.4 Spurious emission measurements at RF antenna connector, low channel

Frequency range: 30 – 1000 MHz

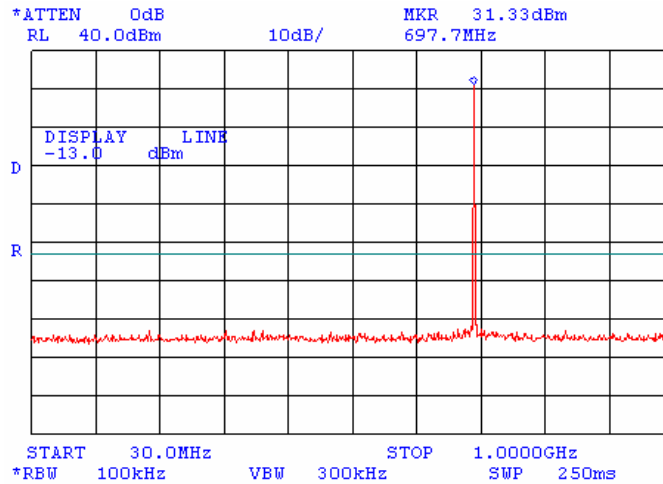



Plot 4.4.5 Spurious emission measurements at RF antenna connector, low channel

Frequency range: 1 – 7.5 GHz

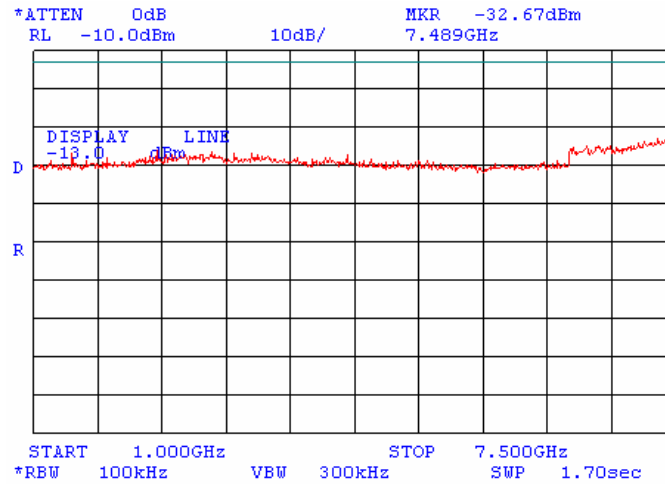

Plot 4.4.6 Spurious emission measurements at RF antenna connector, mid channel

Frequency range: 9 – 150 kHz

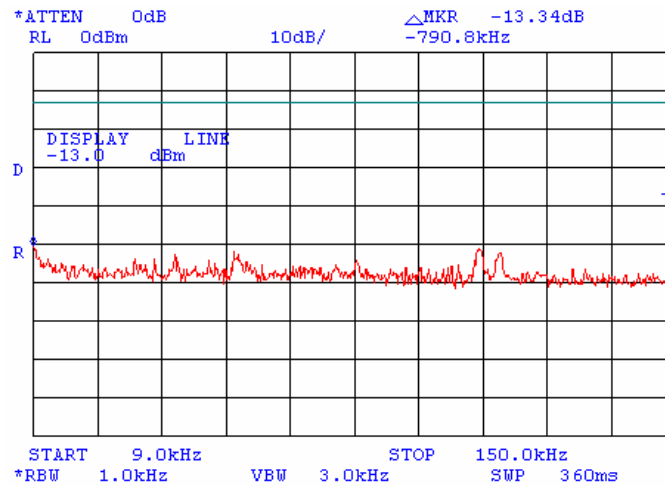



Plot 4.4.7 Spurious emission measurements at RF antenna connector, mid channel

Frequency range: 0.15 – 30 MHz

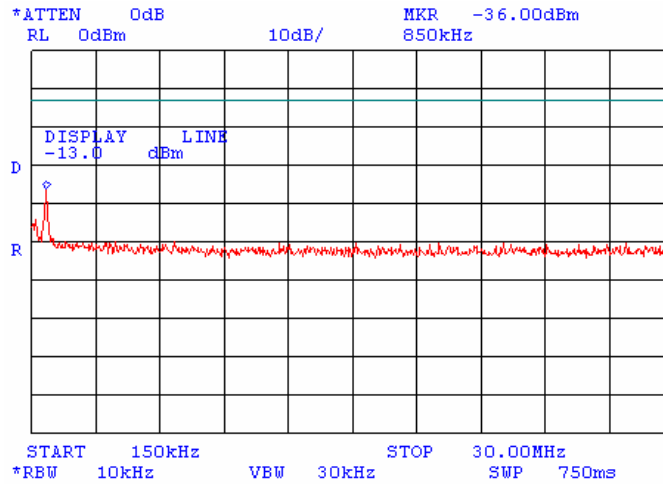

Plot 4.4.8 Spurious emission measurements at RF antenna connector, mid channel

Center frequency: 799.0 kHz

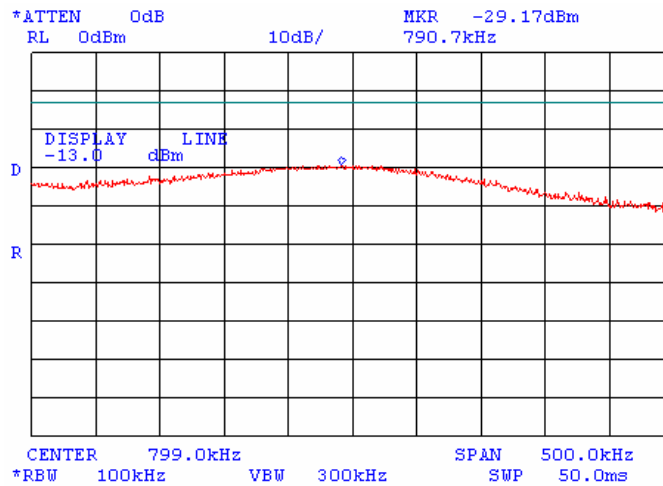



Plot 4.4.9 Spurious emission measurements at RF antenna connector, mid channel

Frequency range: 30 – 1000 MHz

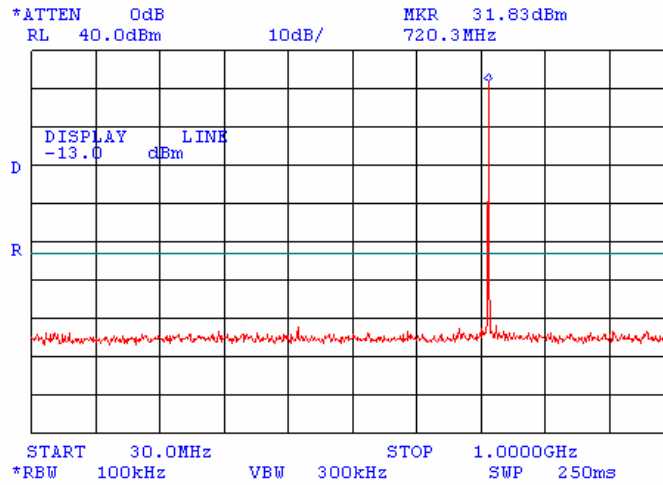

Plot 4.4.10 Spurious emission measurements at RF antenna connector, mid channel

Frequency range: 1 – 7.5 GHz

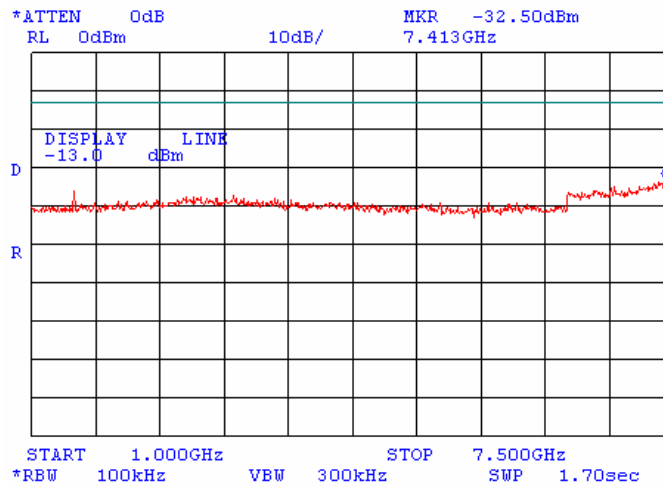



Plot 4.4.11 Spurious emission measurements at RF antenna connector, mid channel

The 2nd harmonic: 1.4 GHz

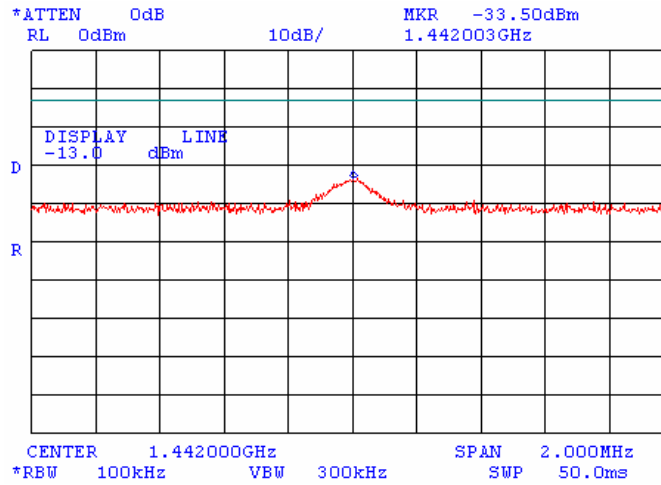

Plot 4.4.12 Spurious emission measurements at RF antenna connector, high channel

Frequency range: 9 – 150 kHz

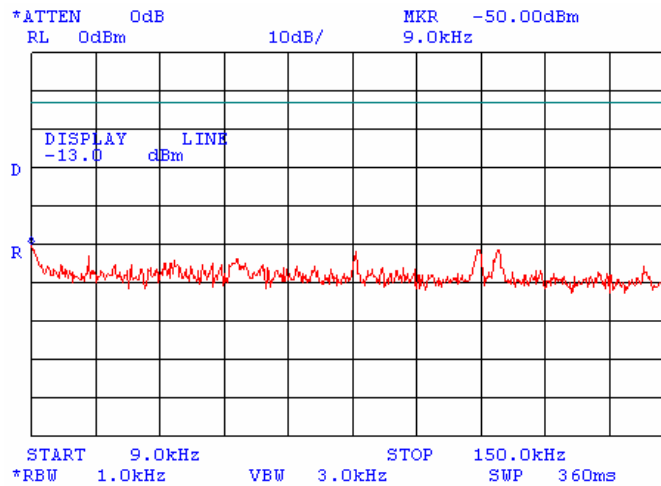



Plot 4.4.13 Spurious emission measurements at RF antenna connector, high channel

Frequency range: 0.15 – 30 MHz

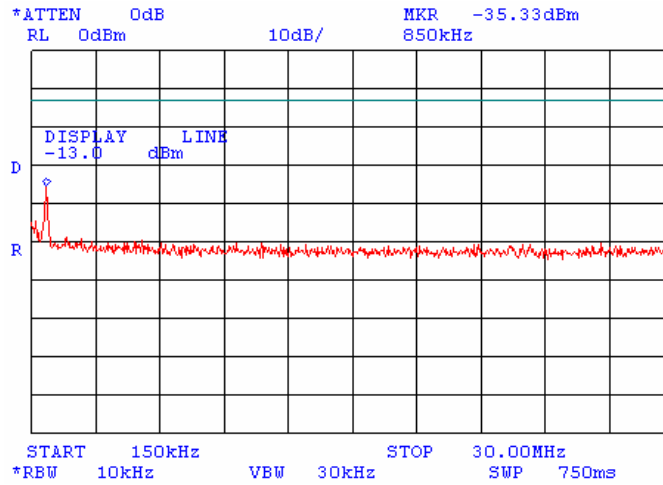

Plot 4.4.14 Spurious emission measurements at RF antenna connector, high channel

Center frequency: 800.7 kHz

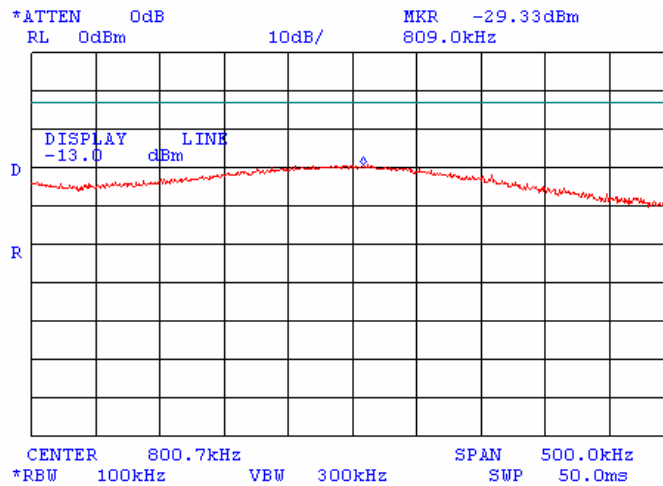



Plot 4.4.15 Spurious emission measurements at RF antenna connector, high channel

Frequency range: 30 – 1000 MHz

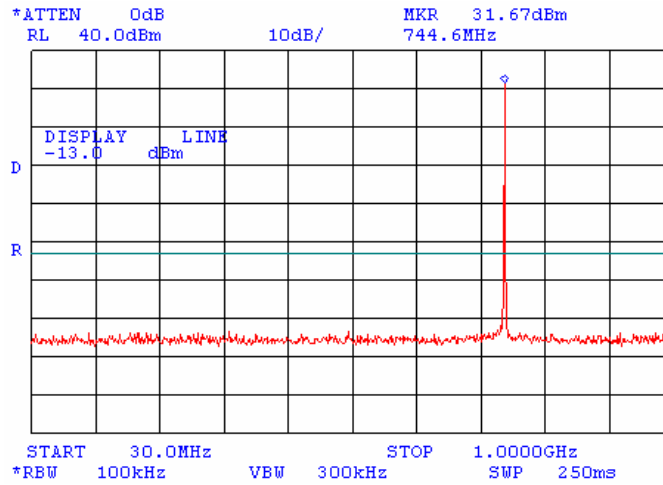

Plot 4.4.16 Spurious emission measurements at RF antenna connector, high channel

Frequency range: 1 – 7.5 GHz

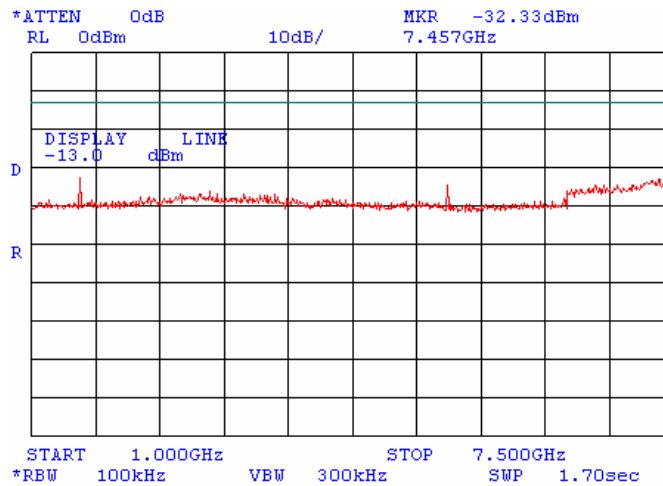



Plot 4.4.17 Spurious emission measurements at RF antenna connector, high channel

The 2nd harmonic: 1.489 GHz

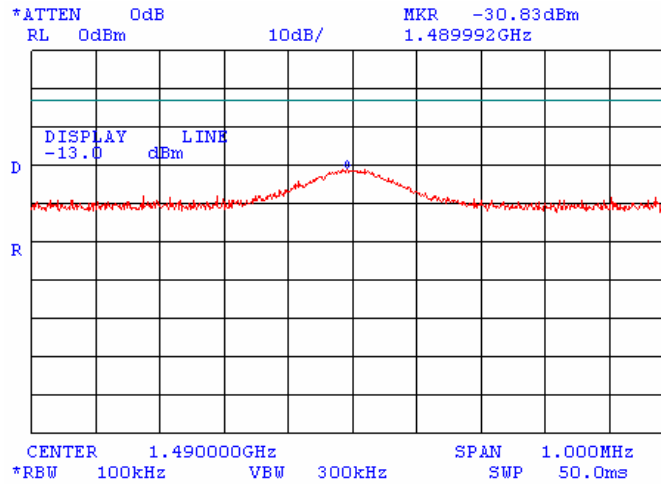

Plot 4.4.18 Spurious emission measurements at RF antenna connector, high channel

The 7th harmonic: 5.215 GHz

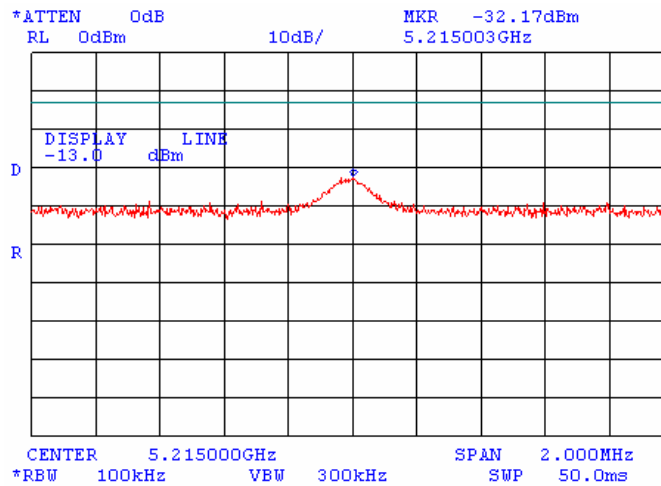



Plot 4.4.19 Spurious emissions at RF antenna connector, low channel band edge measurements

Frequency: 699.5 MHz
6-MHz channel: 698 – 704 MHz
Frequency range: 697.0 – 697.9 MHz
Bit rate: 3 Mbps

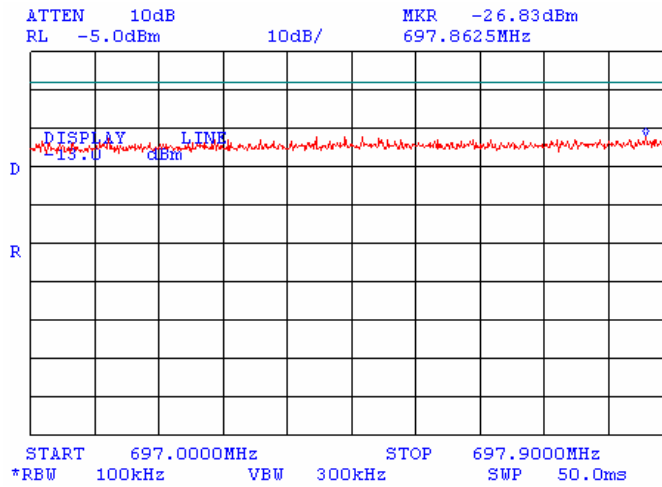

Plot 4.4.20 Spurious emissions at RF antenna connector, low channel band edge measurements

Frequency: 699.5 MHz
6-MHz channel: 698 – 704 MHz
Band edge: 697.9 – 698.0 MHz
Bit rate: 3 Mbps

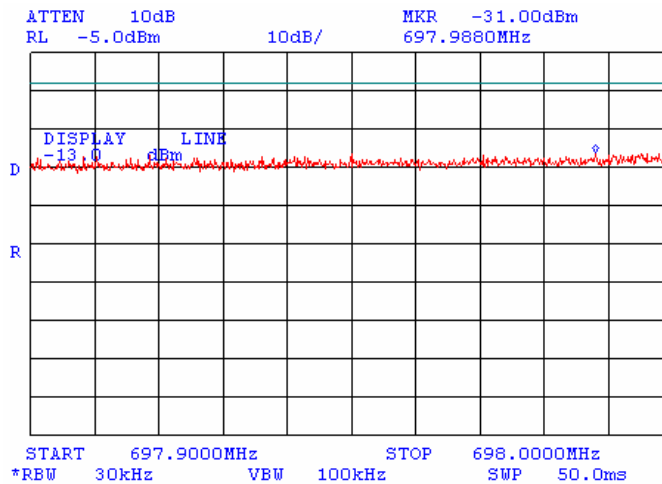



Plot 4.4.21 Spurious emissions at RF antenna connector, low channel band edge measurements

Frequency: 699.5 MHz
6-MHz channel: 698 – 704 MHz
Frequency range: 697.0 – 697.9 MHz
Bit rate: 4 Mbps

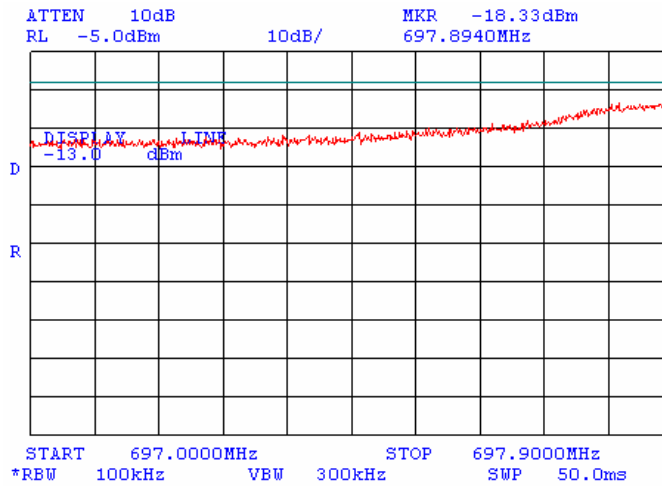

Plot 4.4.22 Spurious emissions at RF antenna connector, low channel band edge measurements

Frequency: 699.5 MHz
6-MHz channel: 698 – 704 MHz
Band edge: 697.9 – 698.0 MHz
Bit rate: 4 Mbps

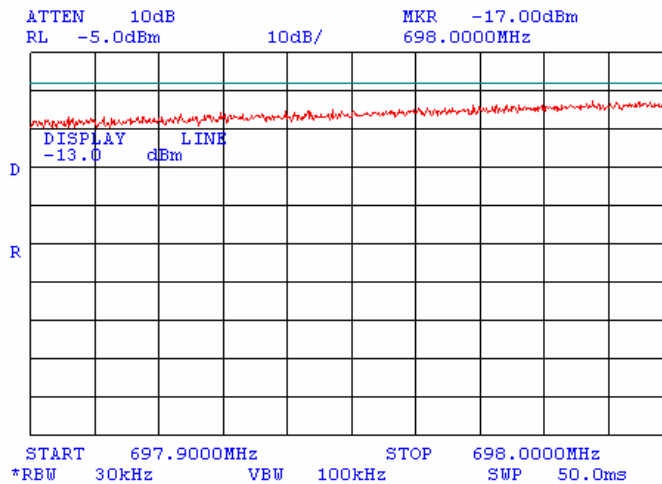



Plot 4.4.23 Spurious emissions at RF antenna connector, low channel band edge measurements

Frequency: 702.5 MHz
6-MHz channel: 698 – 704 MHz
Band edge: 704.0 – 704.1 MHz
Bit rate: 3 Mbps

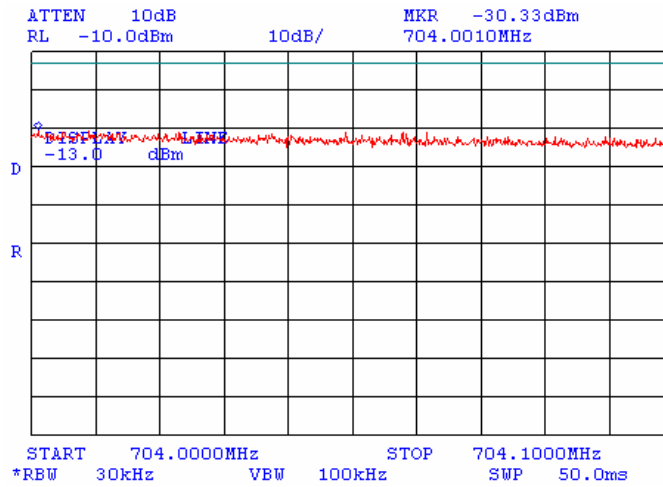

Plot 4.4.24 Spurious emissions at RF antenna connector, low channel band edge measurements

Frequency: 702.5 MHz
6-MHz channel: 698 – 704 MHz
Frequency range: 704.1 – 705.0 MHz
Bit rate: 3 Mbps

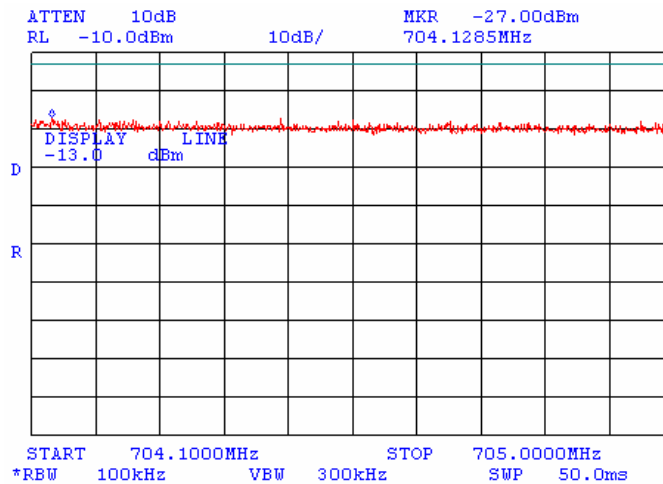



Plot 4.4.25 Spurious emissions at RF antenna connector, low channel band edge measurements

Frequency: 702.5 MHz
6-MHz channel: 698 – 704 MHz
Band edge: 704.0 – 704.1 MHz
Bit rate: 4 Mbps

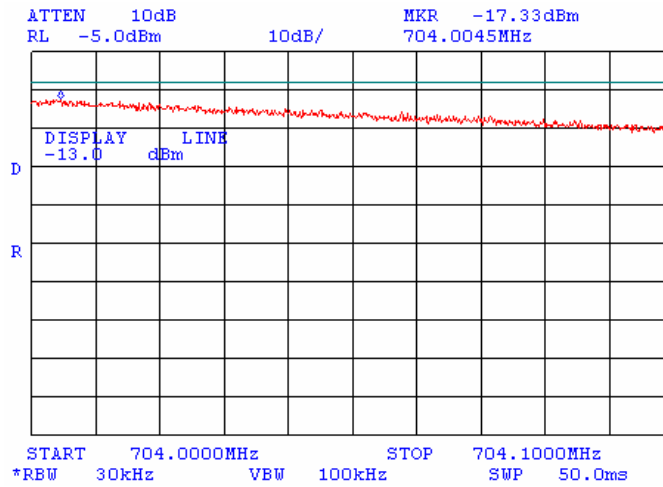

Plot 4.4.26 Spurious emissions at RF antenna connector, low channel band edge measurements

Frequency: 702.5 MHz
6-MHz channel: 698 – 704 MHz
Frequency range: 704.1 – 705.0 MHz
Bit rate: 4 Mbps

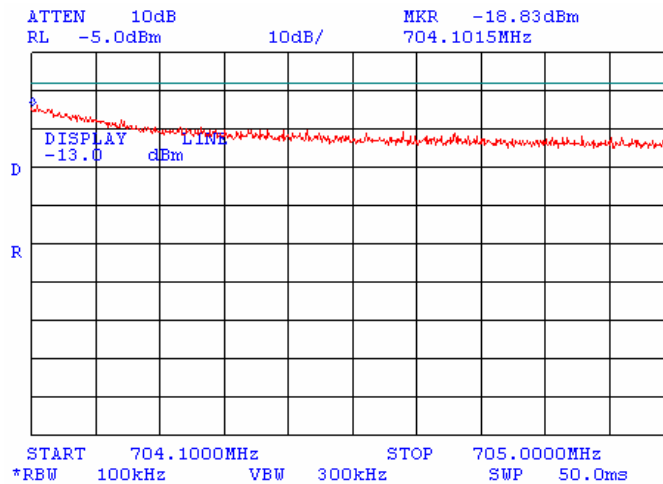



Plot 4.4.27 Spurious emissions at RF antenna connector, mid channel band edge measurements

Frequency: 717.5 MHz
6-MHz channel: 716 – 722 MHz
Frequency range: 715.0 – 715.9 MHz
Bit rate: 3 Mbps

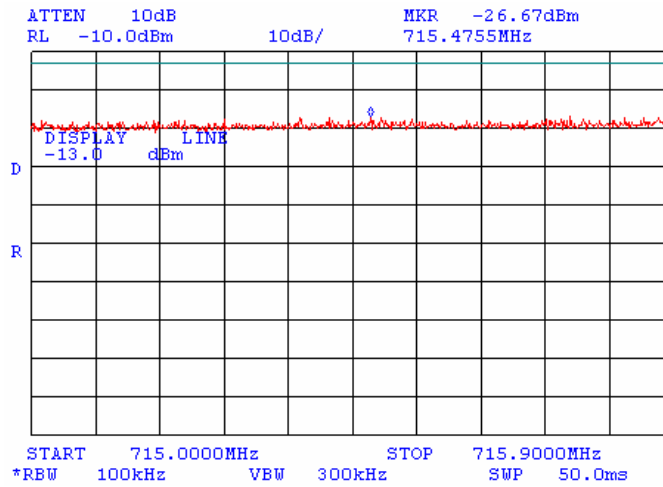

Plot 4.4.28 Spurious emissions at RF antenna connector, mid channel band edge measurements

Frequency: 717.5 MHz
6-MHz channel: 716 – 722 MHz
Band edge: 715.9 – 716.0 MHz
Bit rate: 3 Mbps

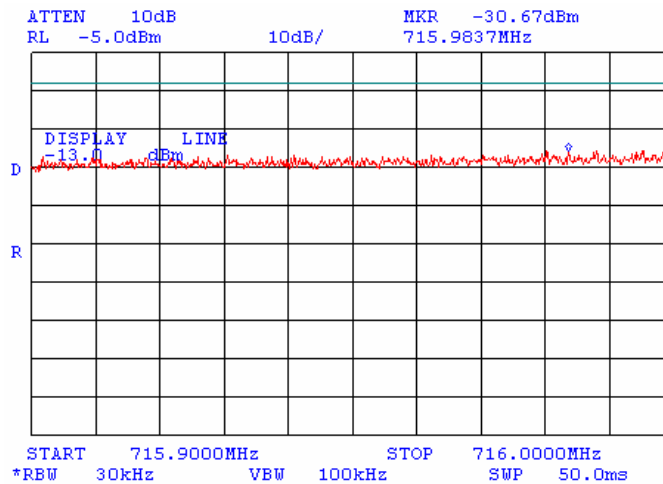



Plot 4.4.29 Spurious emissions at RF antenna connector, mid channel band edge measurements

Frequency: 717.5 MHz
6-MHz channel: 716 – 722 MHz
Frequency range: 715.0 – 715.9 MHz
Bit rate: 4 Mbps

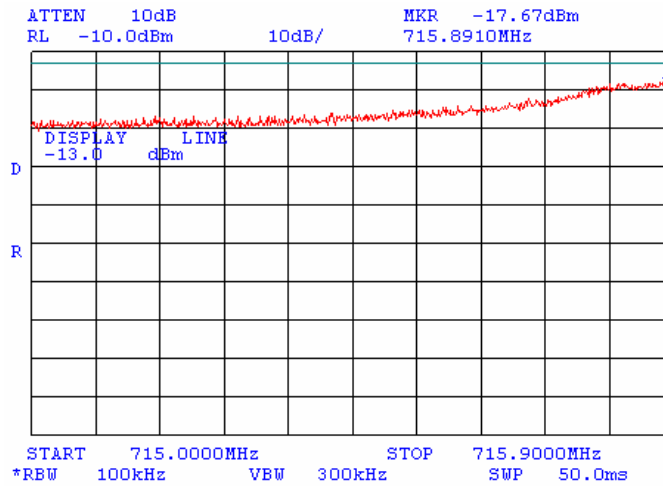

Plot 4.4.30 Spurious emissions at RF antenna connector, mid channel band edge measurements

Frequency: 717.5 MHz
6-MHz channel: 716 – 722 MHz
Band edge: 715.9 – 716.0 MHz
Bit rate: 4 Mbps

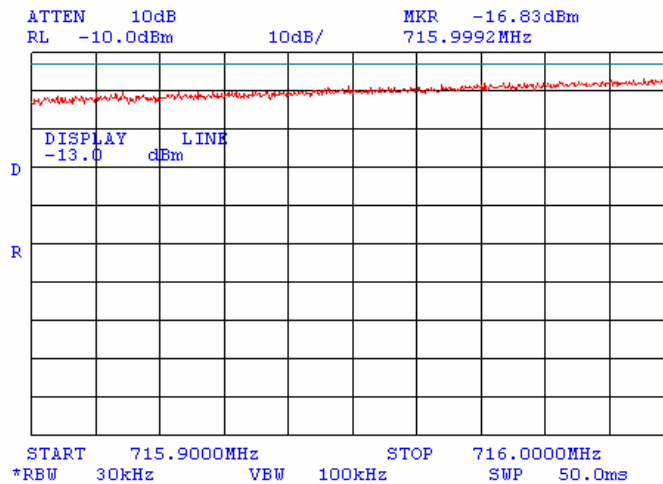



Plot 4.4.31 Spurious emissions at RF antenna connector, mid channel band edge measurements

Frequency: 720.5 MHz
6-MHz channel: 716 – 722 MHz
Band edge: 722.0 – 722.1 MHz
Bit rate: 3 Mbps

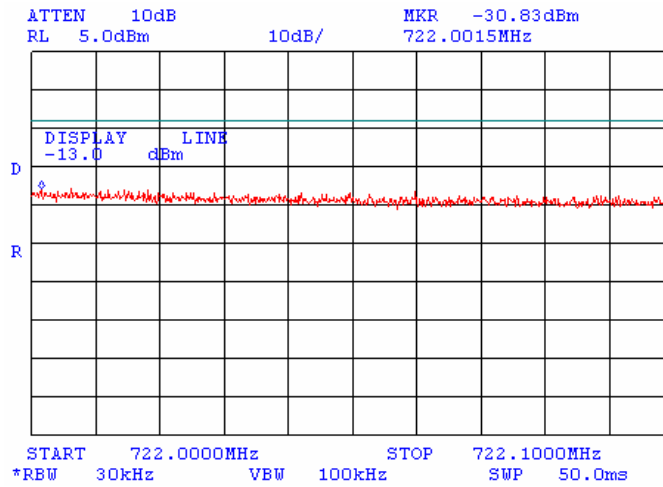

Plot 4.4.32 Spurious emissions at RF antenna connector, mid channel band edge measurements

Frequency: 720.5 MHz
6-MHz channel: 716 – 722 MHz
Frequency range: 722.1 – 723.0 MHz
Bit rate: 3 Mbps

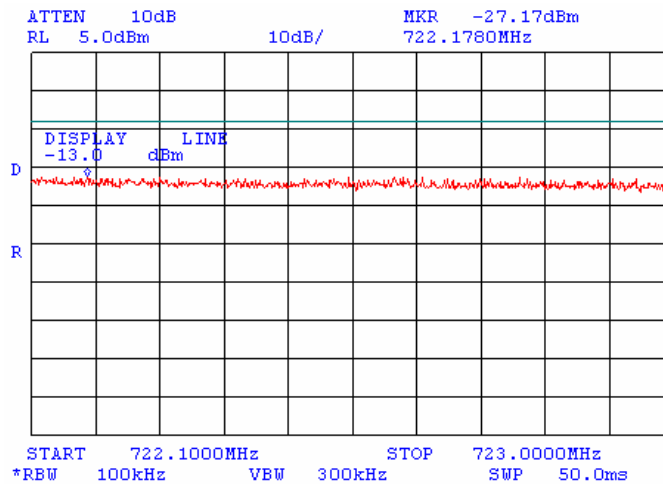



Plot 4.4.33 Spurious emissions at RF antenna connector, mid channel band edge measurements

Frequency: 720.5 MHz
6-MHz channel: 716 – 722 MHz
Band edge: 722.0 – 722.1 MHz
Bit rate: 4 Mbps

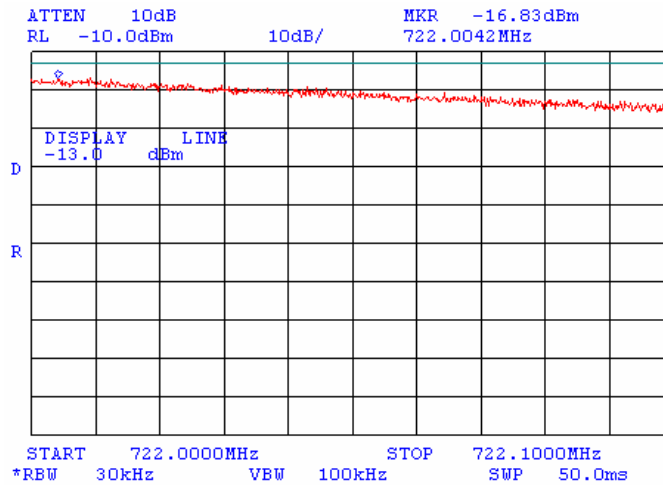

Plot 4.4.34 Spurious emissions at RF antenna connector, mid channel band edge measurements

Frequency: 720.5 MHz
6-MHz channel: 716 – 722 MHz
Frequency range: 722.1 – 723.0 MHz
Bit rate: 4 Mbps

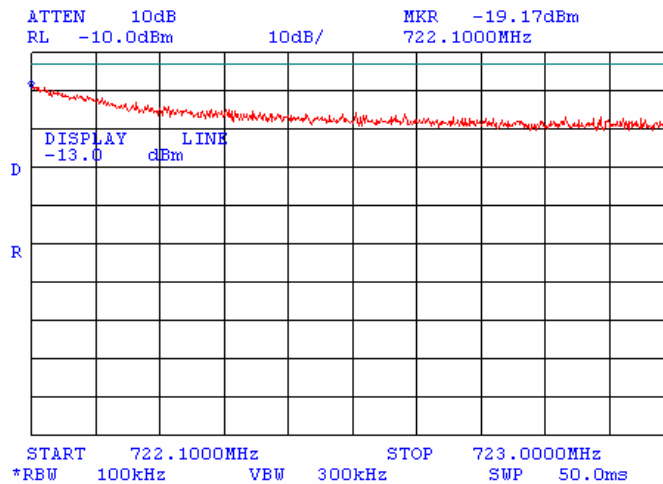



Plot 4.4.35 Spurious emissions at RF antenna connector, high channel band edge measurements

Frequency: 741.5 MHz
6-MHz channel: 740 – 746 MHz
Frequency range: 739.0 – 739.9 MHz
Bit rate: 3 Mbps

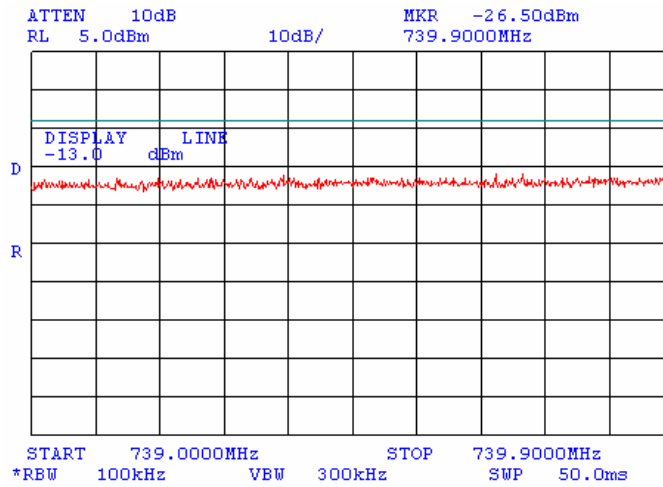

Plot 4.4.36 Spurious emissions at RF antenna connector, high channel band edge measurements

Frequency: 741.5 MHz
6-MHz channel: 740 – 746 MHz
Band edge: 739.9 – 740.0 MHz
Bit rate: 3 Mbps

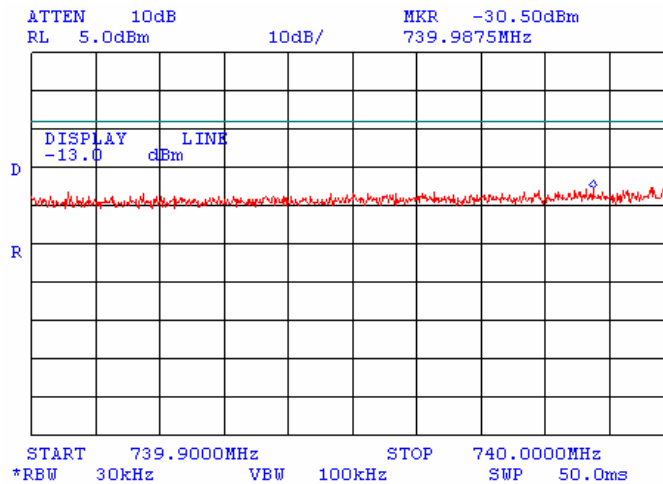



Plot 4.4.37 Spurious emissions at RF antenna connector, high channel band edge measurements

Frequency: 741.5 MHz
6-MHz channel: 740 – 746 MHz
Frequency range: 739.0 – 739.9 MHz
Bit rate: 4 Mbps

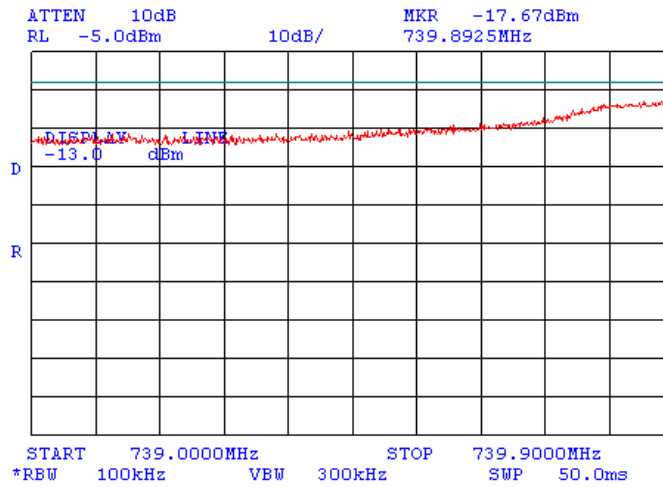

Plot 4.4.38 Spurious emissions at RF antenna connector, high channel band edge measurements

Frequency: 741.5 MHz
6-MHz channel: 740 – 746 MHz
Band edge: 739.9 – 740.0 MHz
Bit rate: 4 Mbps

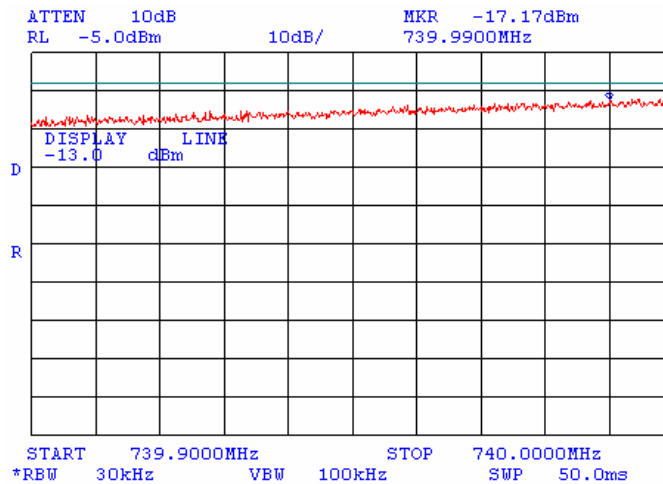



Plot 4.4.39 Spurious emissions at RF antenna connector, high channel band edge measurements

Frequency: 744.5 MHz
6-MHz channel: 740 – 746 MHz
Band edge: 746.0 – 746.1 MHz
Bit rate: 3 Mbps

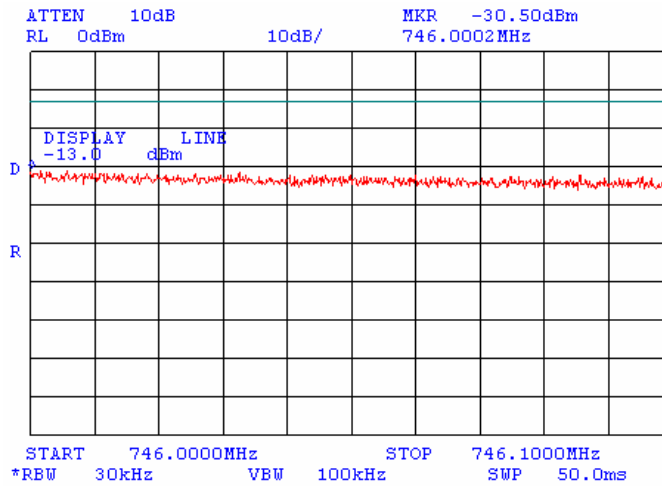

Plot 4.4.40 Spurious emissions at RF antenna connector, high channel band edge measurements

Frequency: 744.5 MHz
6-MHz channel: 740 – 746 MHz
Frequency range: 746.1 – 747.0 MHz
Bit rate: 3 Mbps

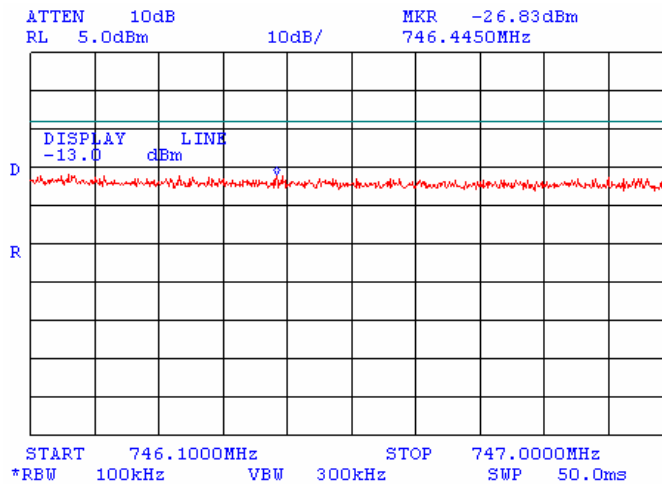



Plot 4.4.41 Spurious emissions at RF antenna connector, high channel band edge measurements

Frequency: 744.5 MHz
6-MHz channel: 740 – 746 MHz
Band edge: 746.0 – 746.1 MHz
Bit rate: 4 Mbps

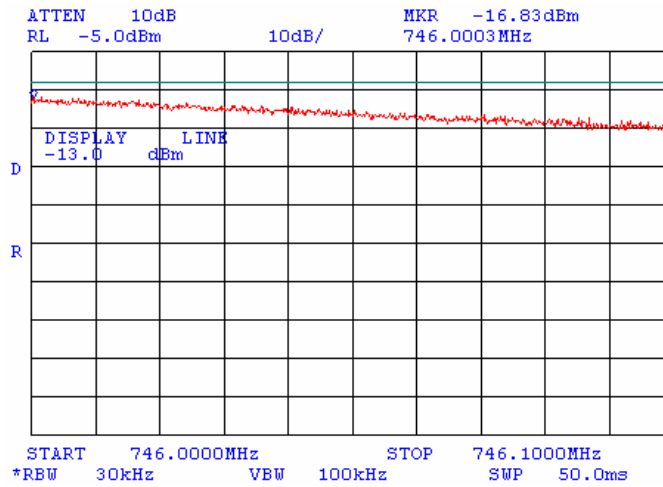

Plot 4.4.42 Spurious emissions at RF antenna connector, high channel band edge measurements

Frequency: 744.5 MHz
6-MHz channel: 740 – 746 MHz
Frequency range: 746.1 – 747.0 MHz
Bit rate: 4 Mbps

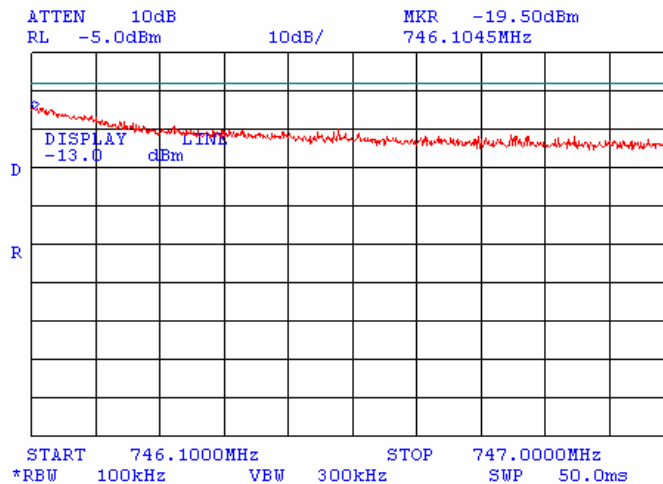



4.5 Radiated spurious emission measurements

4.5.1 General

This test was performed to measure radiated spurious emissions from the EUT enclosure with antenna connector terminated with 50 Ohm dummy load.
Specification test limits are given in Table 4.5.1.

Table 4.5.1 Radiated spurious emission test limits

Frequency, MHz*	Attenuation below carrier, dBc	Spurious emissions, dBm	Equivalent field strength limit @ 3m, dB(μ V/m)**
0.009 – 10 th harmonic	43+10logP*	-13	84.4

* - P is transmitter output power in Watts.

** - Equivalent field strength limit was calculated from maximum allowed ERP of spurious as follows:
 $E = \sqrt{30 \times P \times 1.64} / r$, where P is ERP in Watts, 1.64 is numeric gain of ideal dipole and r is antenna to EUT distance in meters.

4.5.2 Test procedure for spurious emission field strength measurements in 9 kHz to 30 MHz band

- 4.5.2.1 The EUT was set up as shown in Figure 4.5.1, energized and the performance check was conducted.
4.5.2.2 The specified frequency range was investigated with antenna connected to spectrum analyzer. To find maximum radiation the turntable was rotated 360° and the measuring antenna was rotated around its vertical axis.
4.5.2.3 The test results were recorded in Table 4.5.2 and shown in the associated plots.

4.5.3 Test procedure for spurious emission field strength measurements above 30 MHz

- 4.5.3.1 The EUT was set up as shown in Figures 4.5.2, 4.5.3, energized and the performance check was conducted.
4.5.3.2 The specified frequency range was investigated with antennas connected to spectrum analyzer. To find maximum radiation the turntable was rotated 360° and the measuring antenna height was swept from 1 to 4 m in both, vertical and horizontal, polarizations.
4.5.3.3 The worst test results (the lowest margins) were recorded in Table 4.5.2 and shown in the associated plots.

4.5.4 Test procedure for substitution ERP measurements of spurious

- 4.5.4.1 The test equipment was set up as shown in Figure 4.5.4 and energized.
4.5.4.2 RF signal generator was set to the frequency of investigated spurious emission and the RF output level was preliminary adjusted to produce the same field strength as it was measured from the EUT.
4.5.4.3 The test antenna height was swept from 1 to 4 m to find maximum emission from substitution antenna and RF signal generator output was fine adjusted to produce the same field strength as it was measured from the EUT.
4.5.4.4 The above procedure was performed in both, horizontal and vertical, polarizations of the test and substitution antennas.
4.5.4.5 The ERP of spurious emissions was calculated as a sum of signal generator output power in dBm, antenna gain in dBd and cable loss in dB.
4.5.4.6 The above procedure was repeated at the rest of investigated frequencies.
4.5.4.7 The worst test results (the lowest margins) were recorded in Table 4.5.3 and shown in the associated plots.



Figure 4.5.1 Setup for spurious emission field strength measurements in 9 kHz to 30 MHz band

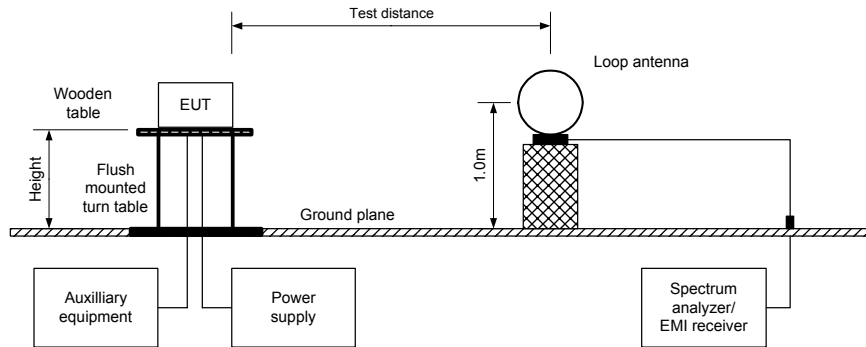

Photograph 4.5.1 Setup for spurious emission field strength measurements in 9 kHz to 30 MHz band





Figure 4.5.2 Setup for spurious emission field strength measurements in 30 MHz to 6.5 GHz band

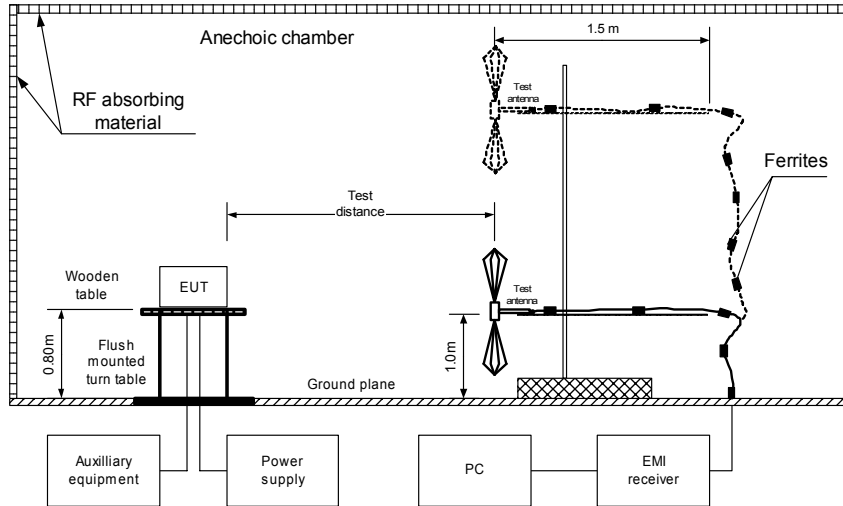

Photograph 4.5.2 Setup for spurious emission field strength measurements in 30 MHz to 1 GHz band, general view





Photograph 4.5.3 Setup for spurious emission field strength measurements in 1 to 6.5 GHz band, general view

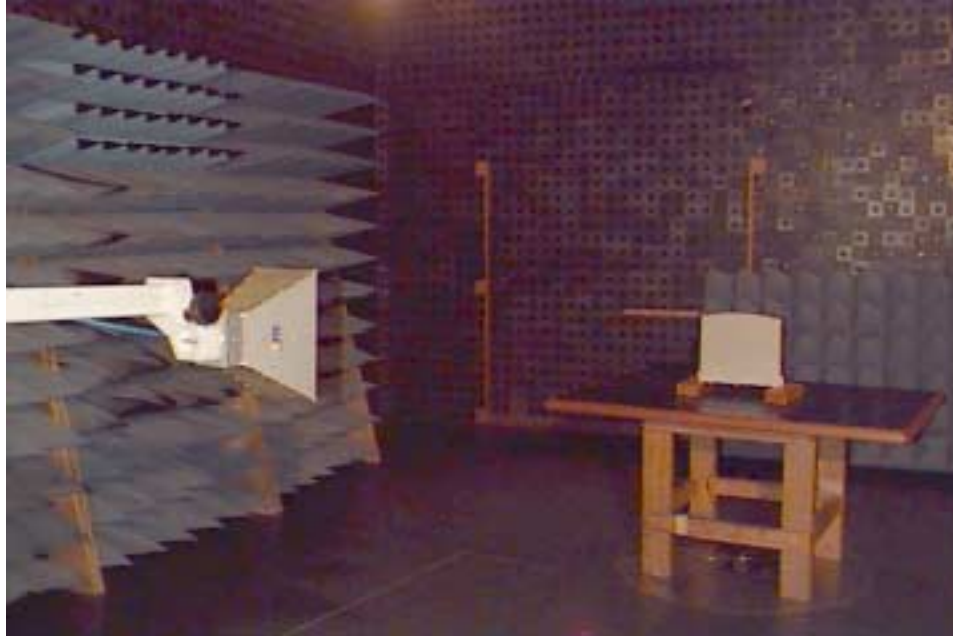

Photograph 4.5.4 Setup for spurious emission field strength measurements in 9 kHz to 6.5 GHz band, EUT view

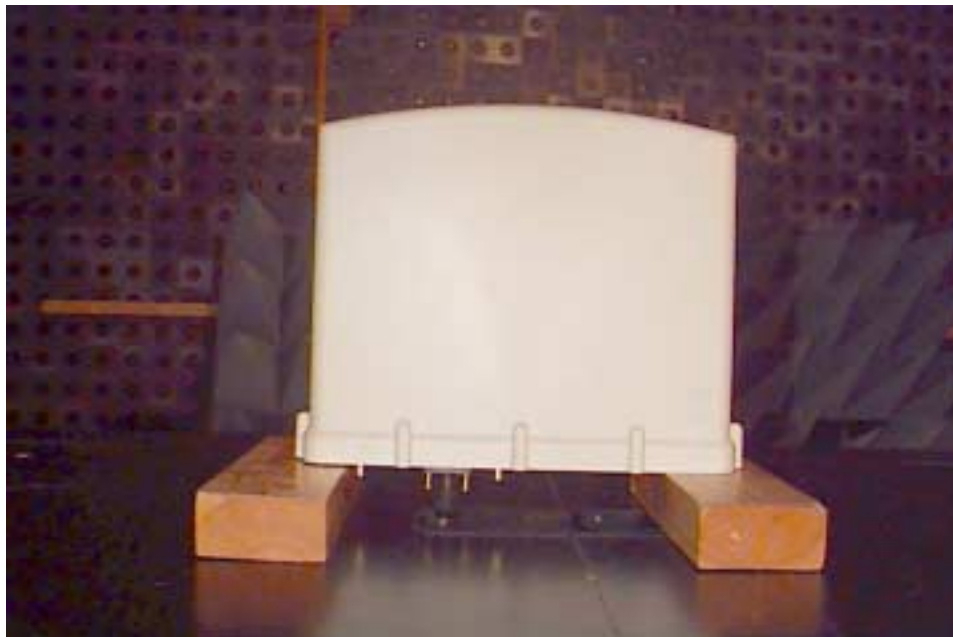
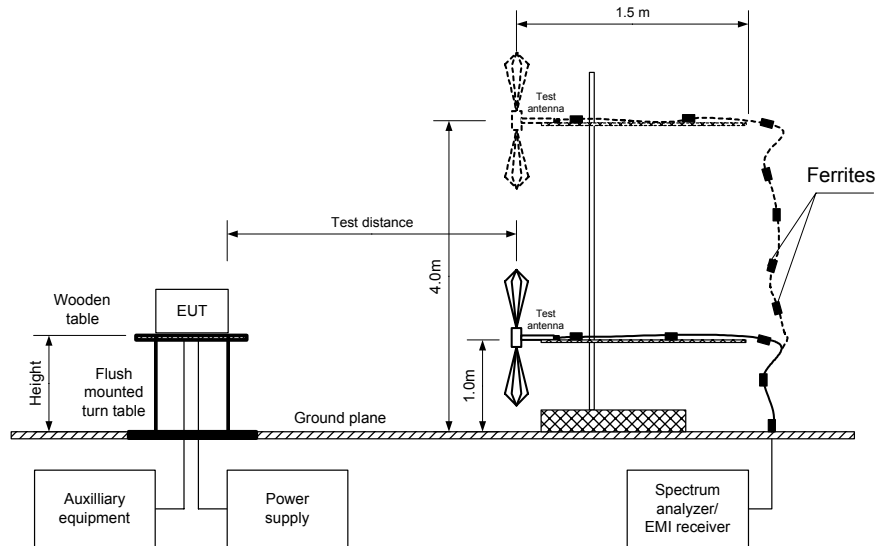



Figure 4.5.3 Setup for spurious emission field strength measurements in 1 to 7.5 GHz band



Photograph 4.5.5 Setup for spurious emission field strength measurements in 1 to 7.5 GHz band





Figure 4.5.4 Setup for substitution ERP measurements of spurious

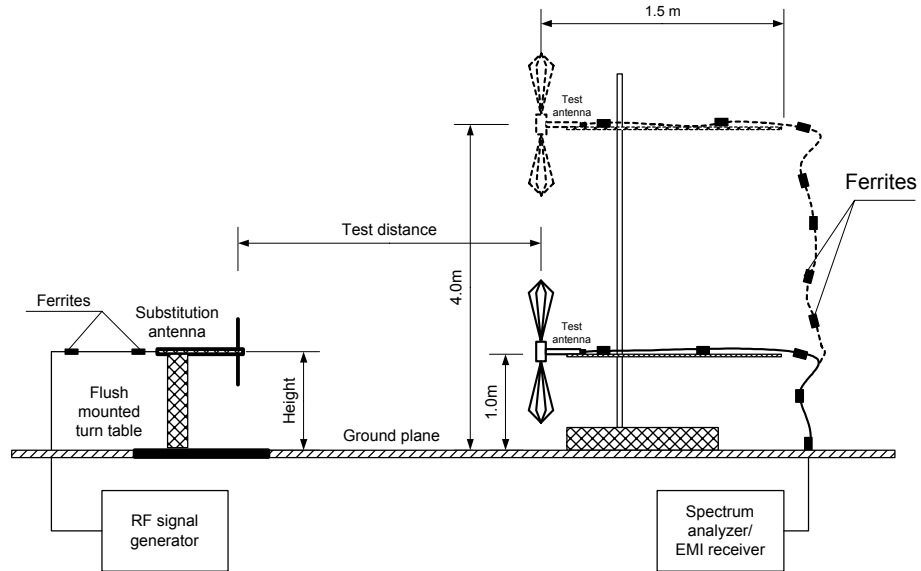

**Table 4.5.2 Spurious emission field strength test results**

ASSIGNED FREQUENCY RANGE: 698 – 746 MHz
TEST DISTANCE: 3 m
EUT HEIGHT: 0.8 m
INVESTIGATED FREQUENCY RANGE: 0.009 – 7500 MHz
DETECTOR USED: Peak
VIDEO BANDWIDTH: ≥ Resolution bandwidth
TEST ANTENNA TYPE: Active loop (9 kHz – 30 MHz)
Biconilog (30 MHz – 1000 MHz)
Double ridged guide (above 1000 MHz)
Unmodulated
MODULATION: NA
MODULATING SIGNAL: NA
TRANSMITTER OUTPUT POWER SETTINGS: Maximum
TRANSMITTER OUTPUT POWER: 31.33 dBm at low frequency
31.83 dBm at mid frequency
31.67 dBm at high frequency

Frequency, MHz	Antenna polarization	RBW, kHz	Field strength, dB(μV/m)	Limit, dB(μV/m)	Margin, dB*	Verdict
Low carrier frequency						
0.009 - 30	All radiated spurious emissions were found more than 20 dB below the limit					Pass
30 - 1000	All radiated spurious emissions were found more than 20 dB below the limit					Pass
4193.90	Horizontal	1000	56.00	84.40	-28.40	Pass
4892.85	Horizontal	1000	58.50	84.40	-25.90	Pass
5591.93	Horizontal	1000	65.33	84.40	-19.07	Pass
6290.80	Horizontal	1000	70.83	84.40	-13.57	Pass
6989.83	Horizontal	1000	56.83	84.40	-27.57	Pass
Mid carrier frequency						
0.009 - 30	All radiated spurious emissions were found more than 20 dB below the limit					Pass
30 - 1000	All radiated spurious emissions were found more than 20 dB below the limit					Pass
2883.99	Vertical	100	63.51	84.40	-20.89	Pass
4326.05	Horizontal	1000	56.33	84.40	-28.07	Pass
5046.95	Horizontal	1000	57.83	84.40	-26.57	Pass
6488.82	Horizontal	1000	72.17	84.40	-12.23	Pass
High carrier frequency						
0.009 - 30	All radiated spurious emissions were found more than 20 dB below the limit					Pass
30 - 1000	All radiated spurious emissions were found more than 20 dB below the limit					Pass
2979.85	Vertical	1000	64.83	84.40	-19.57	Pass
4469.88	Horizontal	1000	61.17	84.40	-23.23	Pass
5960.03	Horizontal	1000	61.00	84.40	-23.40	Pass
6704.88	Horizontal	1000	71.50	84.40	-12.90	Pass

*- Margin = Field strength of spurious – calculated field strength limit.



Table 4.5.3 Substitution ERP of spurious test results

ASSIGNED FREQUENCY RANGE: 698 – 746 MHz
TRANSMITTER OUTPUT POWER: 31.33 dBm at low frequency
31.83 dBm at mid frequency
31.67 dBm at high frequency
TEST SITE: OATS
TEST DISTANCE: 3 m
SUBSTITUTION ANTENNA HEIGHT: 0.8 m
DETECTOR USED: Peak
VIDEO BANDWIDTH: ≥ Resolution bandwidth
SUBSTITUTION ANTENNA TYPE: Double ridged guide

Frequency, MHz	Antenna polarization	RBW, kHz	Field strength, dB(μV/m)	RF generator output, dBm	Antenna gain, dBd	Cable loss, dB	ERP result**, dBm	ERP limit, dBm	Margin, dB*	Verdict
Low carrier frequency										
4193.90	Horizontal	1000	56.00	-48.3	7.6	1.2	-41.9	-13.0	-28.9	Pass
4892.85	Horizontal	1000	58.50	-46.7	7.9	1.3	-40.1	-13.0	-27.1	Pass
5591.93	Horizontal	1000	65.33	-39.7	8.1	1.3	-32.9	-13.0	-19.9	Pass
6290.80	Horizontal	1000	70.83	-34.1	8.7	1.4	-26.8	-13.0	-13.8	Pass
6989.83	Horizontal	1000	56.83	-47.7	8.7	1.5	-40.5	-13.0	-27.5	Pass
Mid carrier frequency										
2883.99	Vertical	100	63.51	-40.1	7.0	1.0	-34.1	-13.0	-21.1	Pass
4326.05	Horizontal	1000	56.33	-48.6	7.9	1.2	-41.9	-13.0	-28.9	Pass
5046.95	Horizontal	1000	57.83	-47.2	7.8	1.3	-40.7	-13.0	-27.7	Pass
6488.82	Horizontal	1000	72.17	-33.1	8.9	1.5	-25.7	-13.0	-12.7	Pass
High carrier frequency										
2979.85	Vertical	1000	64.83	-38.9	6.9	1.0	-33.0	-13.0	-20.0	Pass
4469.88	Horizontal	1000	61.17	-44.3	8.2	1.2	-37.3	-13.0	-24.3	Pass
5960.03	Horizontal	1000	61.00	-43.3	8.4	1.4	-36.3	-13.0	-23.3	Pass
6704.88	Horizontal	1000	71.50	-33.3	8.8	1.5	-26.0	-13.0	-13.0	Pass

*- Margin = Spurious emission – specification limit.

** ERP = P_{gen} – CL + G_{ant}, where

P_{gen} - signal generator output power in dBm

CL - cable loss in dB

G_{ant} - antenna gain in dBd

Reference numbers of test equipment used

HL 0038	HL 0091	HL 0287	HL 0446	HL 0465	HL 0521	HL 0589	HL 0604
HL 0661	HL 1004	HL 1424	HL 1942	HL 1984	HL 2254	HL 2259	HL 2400
HL 2432							

Full description is given in Appendix A.



Plot 4.5.1 Radiated emission measurements in 9 - 150 kHz range

TEST SITE: Semi anechoic chamber
CARRIER FREQUENCY: Low
ANTENNA POLARIZATION: Vertical
TEST DISTANCE: 3 m

12:26:47 FEB 26, 2004

ACTV DET: PEAK
MEAS DET: PEAK OP AVG
MKR 9.4 kHz
58.66 dB μ V/m

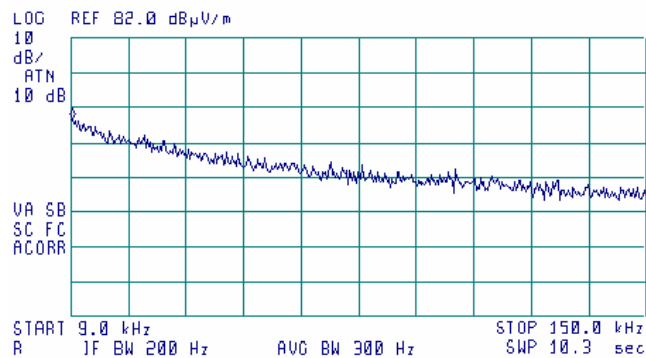

Equivalent field strength limit @ 3m = 84.4 dB(μ V/m)

Plot 4.5.2 Radiated emission measurements in 0.15 - 30 MHz range

TEST SITE: Semi anechoic chamber
CARRIER FREQUENCY: Low
ANTENNA POLARIZATION: Vertical
TEST DISTANCE: 3 m

12:29:07 FEB 26, 2004

ACTV DET: PEAK
MEAS DET: PEAK OP AVG
MKR 150 kHz
55.47 dB μ V/m

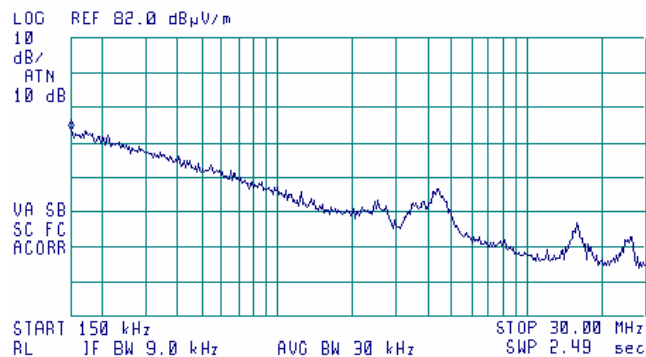

Equivalent field strength limit @ 3m = 84.4 dB(μ V/m)



Plot 4.5.3 Radiated emission measurements in 30 - 1000 MHz range

TEST SITE: Semi anechoic chamber
CARRIER FREQUENCY: Low
ANTENNA POLARIZATION: Vertical and Horizontal
TEST DISTANCE: 3 m

11:39:44 FEB 26, 2004

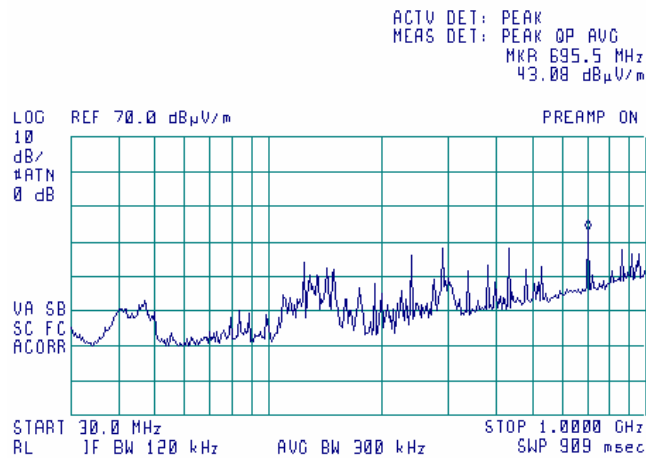

Equivalent field strength limit @ 3m = 84.4 dB(µV/m)

Plot 4.5.4 Radiated emission measurements in 1 – 6.5 GHz range

TEST SITE: Semi anechoic chamber
CARRIER FREQUENCY: Low
ANTENNA POLARIZATION: Vertical and Horizontal
TEST DISTANCE: 3 m

14:23:41 FEB 26, 2004

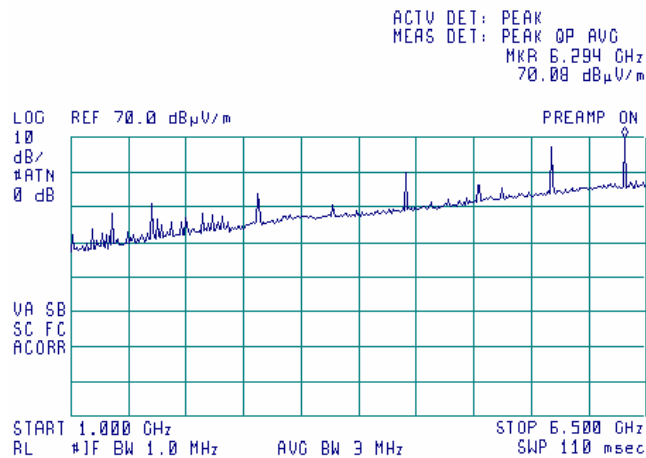

Equivalent field strength limit @ 3m = 84.4 dB(µV/m)



Plot 4.5.5 Radiated emission measurements in 6.5 – 7.5 GHz range

TEST SITE: OATS
CARRIER FREQUENCY: Low
ANTENNA POLARIZATION: Vertical and Horizontal
TEST DISTANCE: 3 m

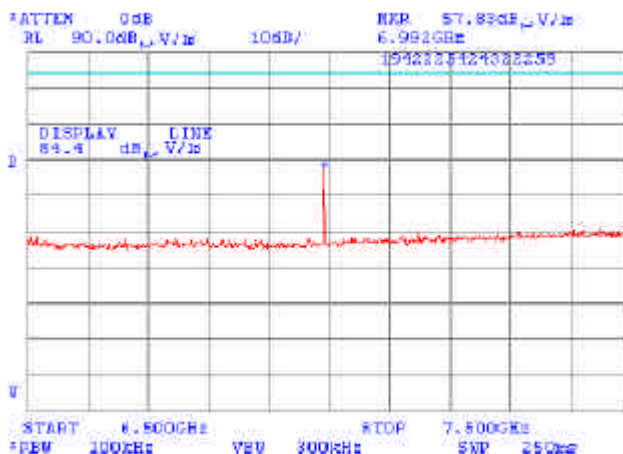

Plot 4.5.6 Radiated emission measurements at the 6th harmonic

TEST SITE: OATS
CARRIER FREQUENCY: Low
ANTENNA POLARIZATION: Horizontal
TEST DISTANCE: 3 m

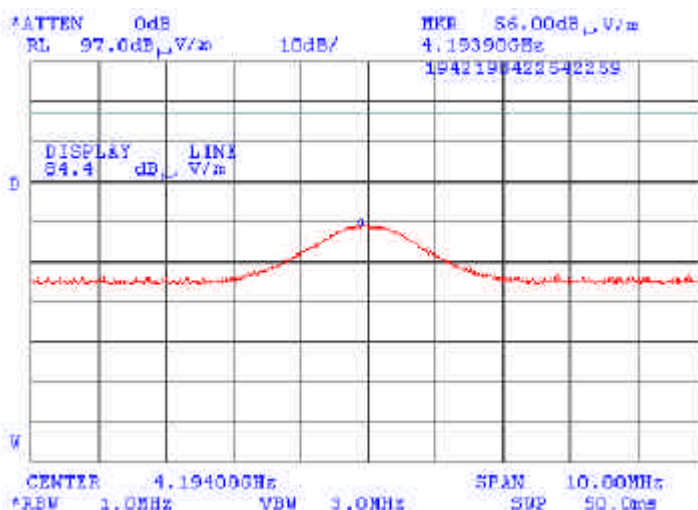



Plot 4.5.7 Radiated emission measurements at the 7th harmonic

TEST SITE: OATS
CARRIER FREQUENCY: Low
ANTENNA POLARIZATION: Horizontal
TEST DISTANCE: 3 m

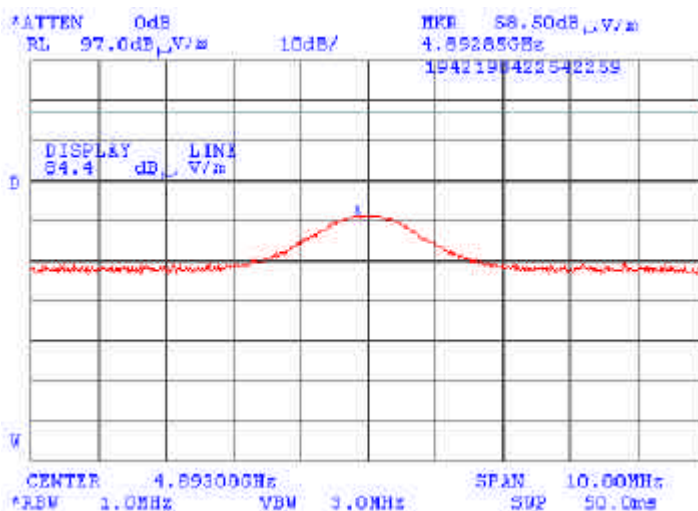

Plot 4.5.8 Radiated emission measurements at the 8th harmonic

TEST SITE: OATS
CARRIER FREQUENCY: Low
ANTENNA POLARIZATION: Horizontal
TEST DISTANCE: 3 m

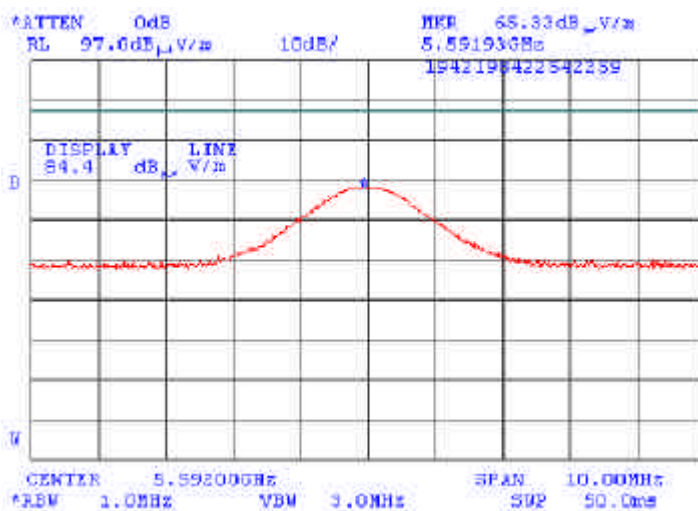



Plot 4.5.9 Radiated emission measurements at the 9th harmonic

TEST SITE: OATS
CARRIER FREQUENCY: Low
ANTENNA POLARIZATION: Horizontal
TEST DISTANCE: 3 m

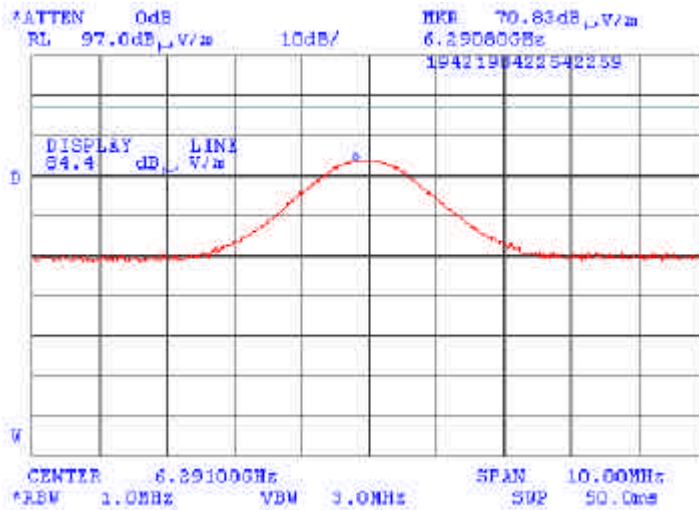

Plot 4.5.10 Radiated emission measurements at the 10th harmonic

TEST SITE: OATS
CARRIER FREQUENCY: Low
ANTENNA POLARIZATION: Horizontal
TEST DISTANCE: 3 m

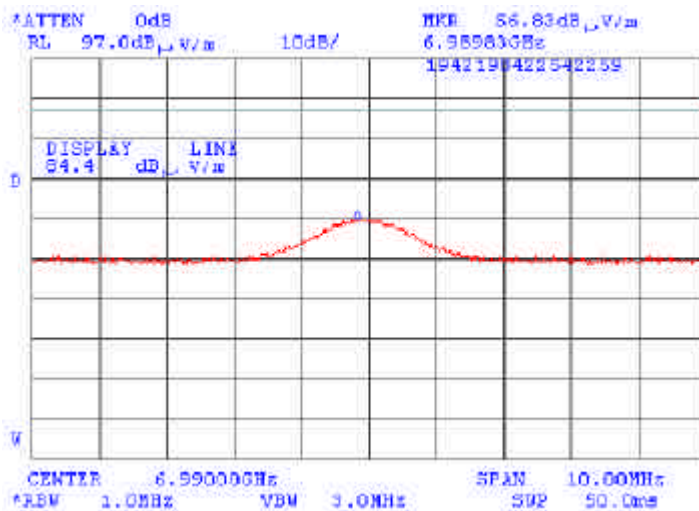



Plot 4.5.11 Radiated emission measurements in 9 - 150 kHz range

TEST SITE: Semi anechoic chamber
CARRIER FREQUENCY: Mid
ANTENNA POLARIZATION: Vertical
TEST DISTANCE: 3 m

13:17:49 FEB 26, 2004

ACTV DET: PEAK
MEAS DET: PEAK OP AVG
MKR 10.8 kHz
58.53 dB μ V/m

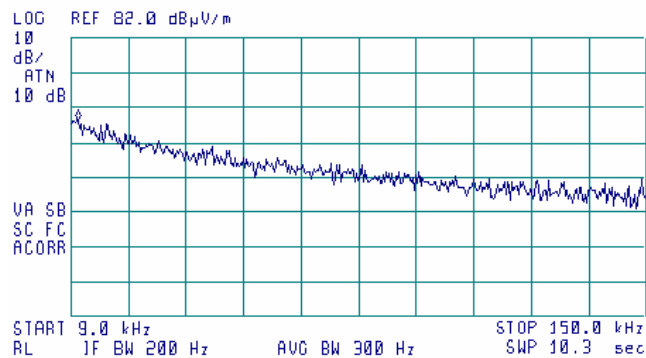

Equivalent field strength limit @ 3m = 84.4 dB(μ V/m)

Plot 4.5.12 Radiated emission measurements in 0.15 - 30 MHz range

TEST SITE: Semi anechoic chamber
CARRIER FREQUENCY: Mid
ANTENNA POLARIZATION: Vertical
TEST DISTANCE: 3 m

13:10:35 FEB 26, 2004

ACTV DET: PEAK
MEAS DET: PEAK OP AVG
MKR 160 kHz
55.33 dB μ V/m

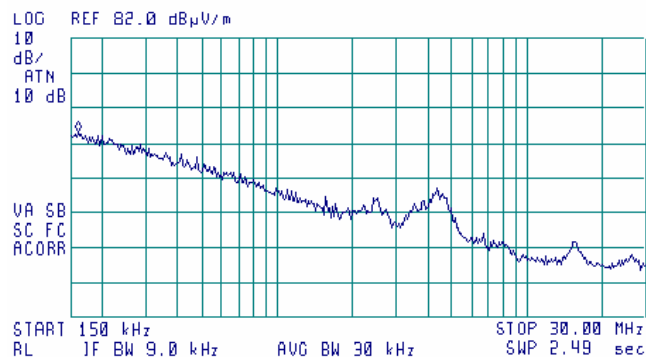

Equivalent field strength limit @ 3m = 84.4 dB(μ V/m)



Plot 4.5.13 Radiated emission measurements in 30 - 1000 MHz range

TEST SITE: Semi anechoic chamber
CARRIER FREQUENCY: Mid
ANTENNA POLARIZATION: Vertical and Horizontal
TEST DISTANCE: 3 m

11:07:27 FEB 26, 2004

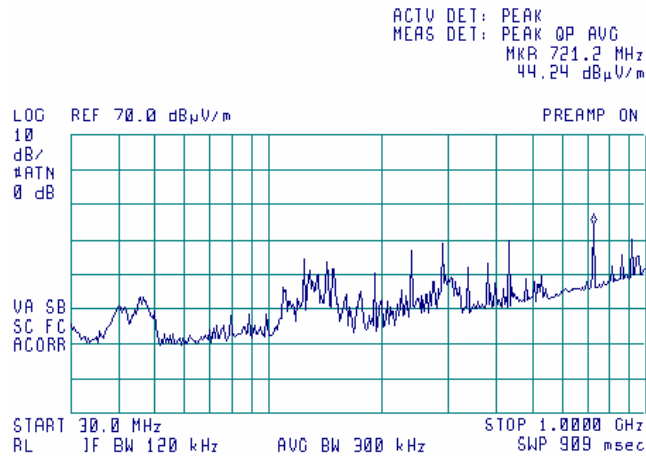

Equivalent field strength limit @ 3m = 84.4 dB(µV/m)

Plot 4.5.14 Radiated emission measurements in 1 – 6.5 GHz range

TEST SITE: Semi anechoic chamber
CARRIER FREQUENCY: Mid
ANTENNA POLARIZATION: Vertical and Horizontal
TEST DISTANCE: 3 m

14:09:58 FEB 26, 2004

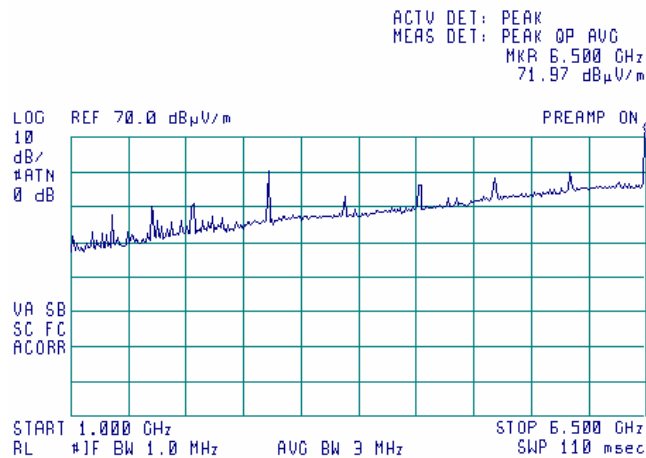

Equivalent field strength limit @ 3m = 84.4 dB(µV/m)



Plot 4.5.15 Radiated emission measurements in 6.5 – 7.5 GHz range

TEST SITE: OATS
CARRIER FREQUENCY: Mid
ANTENNA POLARIZATION: Vertical and Horizontal
TEST DISTANCE: 3 m

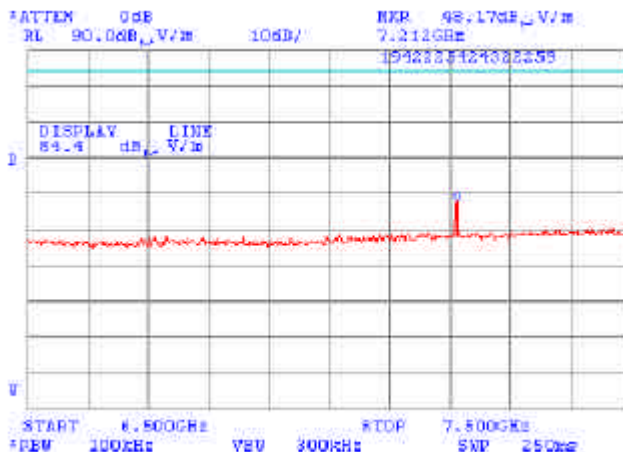

Plot 4.5.16 Radiated emission measurements at the 4th harmonic

TEST SITE: OATS
CARRIER FREQUENCY: Mid
ANTENNA POLARIZATION: Vertical
TEST DISTANCE: 3 m

11:49:55 MAR 01, 2004

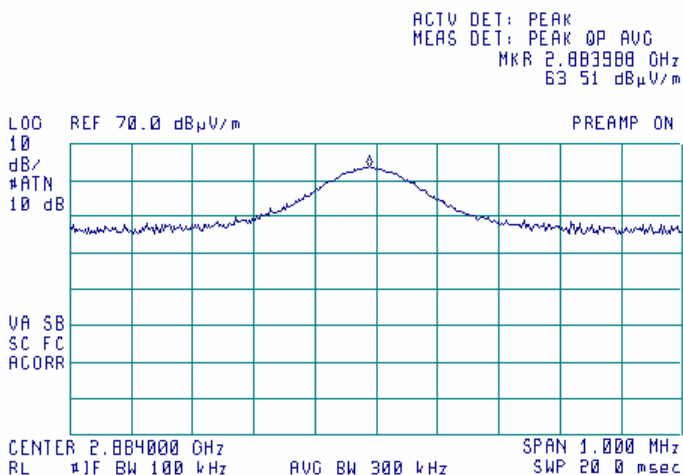

Equivalent field strength limit @ 3m = 84.4 dB(μV/m)



Plot 4.5.17 Radiated emission measurements at the 6th harmonic

TEST SITE: OATS
CARRIER FREQUENCY: Mid
ANTENNA POLARIZATION: Horizontal
TEST DISTANCE: 3 m

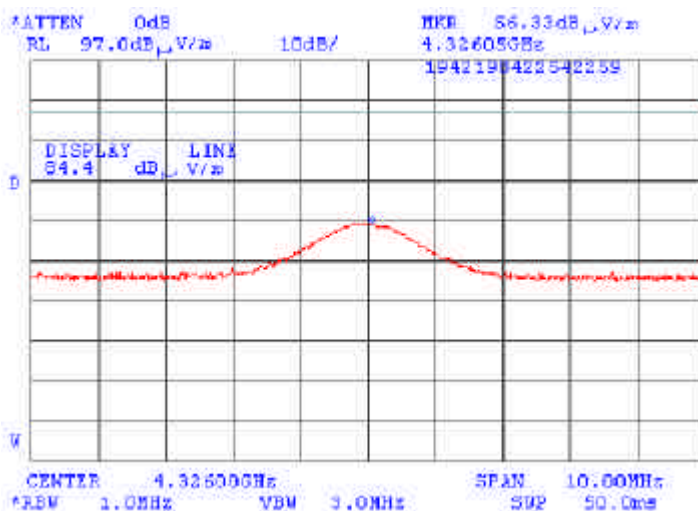

Plot 4.5.18 Radiated emission measurements at the 7th harmonic

TEST SITE: OATS
CARRIER FREQUENCY: Mid
ANTENNA POLARIZATION: Horizontal
TEST DISTANCE: 3 m

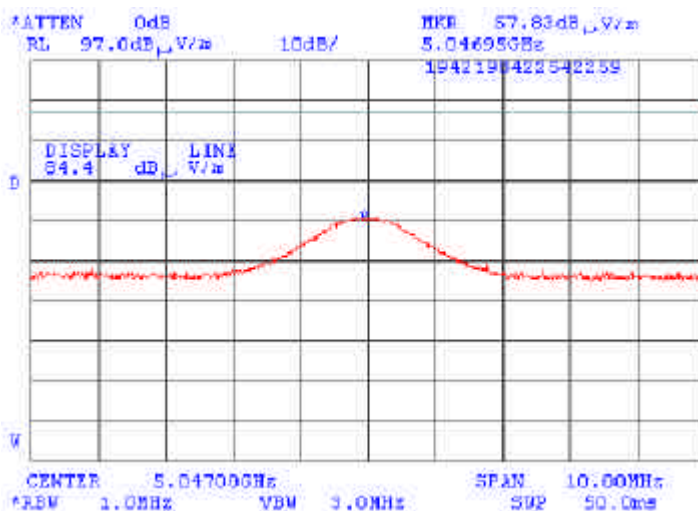



Plot 4.5.19 Radiated emission measurements at the 9th harmonic

TEST SITE: OATS
CARRIER FREQUENCY: Mid
ANTENNA POLARIZATION: Horizontal
TEST DISTANCE: 3 m

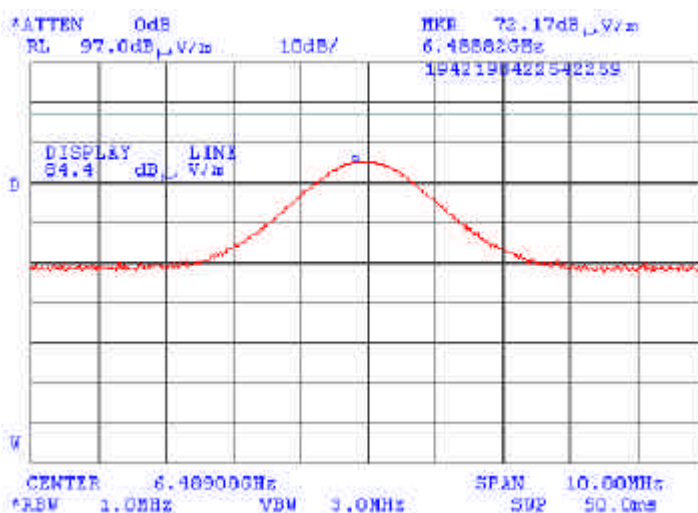

Plot 4.5.20 Radiated emission measurements in 9 - 150 kHz range

TEST SITE: Semi anechoic chamber
CARRIER FREQUENCY: High
ANTENNA POLARIZATION: Vertical
TEST DISTANCE: 3 m

13:20:34 FEB 26, 2004

ACTV DET: PEAK
MEAS DET: PEAK OP AVG
MKR 10.1 kHz
59.38 dBμV/m

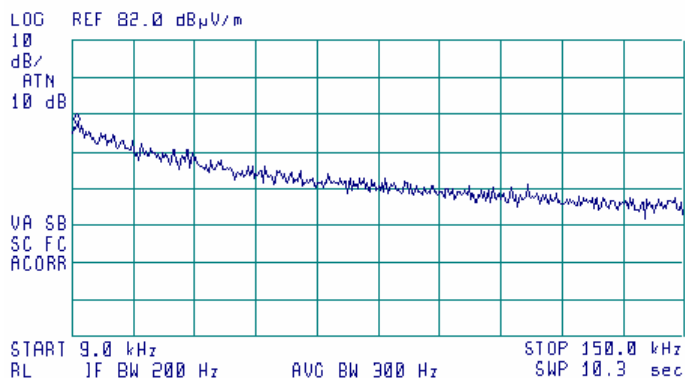

Equivalent field strength limit @ 3m = 84.4 dB(μV/m)



Plot 4.5.21 Radiated emission measurements in 0.15 - 30 MHz range

TEST SITE: Semi anechoic chamber
CARRIER FREQUENCY: High
ANTENNA POLARIZATION: Vertical
TEST DISTANCE: 3 m

13:23:43 FEB 26, 2004

ACTV DET: PEAK
MEAS DET: PEAK OP AVG
MKR 170 kHz
55.44 dB μ V/m

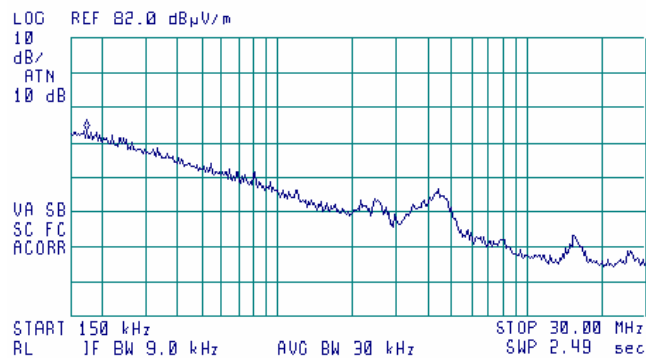

Equivalent field strength limit @ 3m = 84.4 dB(μ V/m)

Plot 4.5.22 Radiated emission measurements in 30 - 1000 MHz range

TEST SITE: Semi anechoic chamber
CARRIER FREQUENCY: High
ANTENNA POLARIZATION: Vertical and Horizontal
TEST DISTANCE: 3 m

10:57:54 FEB 26, 2004

ACTV DET: PEAK
MEAS DET: PEAK OP AVG
MKR 740.4 MHz
51.54 dB μ V/m

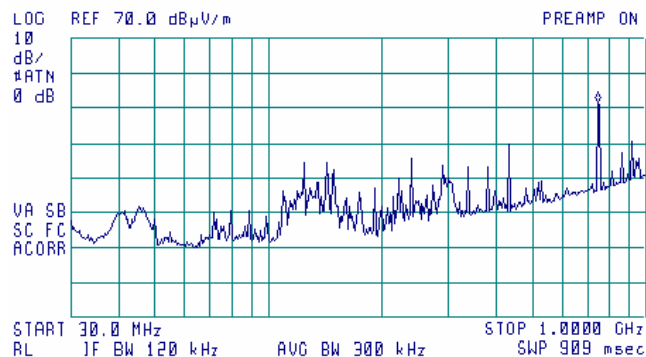

Equivalent field strength limit @ 3m = 84.4 dB(μ V/m)



Plot 4.5.23 Radiated emission measurements in 1 – 6.5 GHz range

TEST SITE:	Semi anechoic chamber
CARRIER FREQUENCY:	High
ANTENNA POLARIZATION:	Vertical and Horizontal
TEST DISTANCE:	3 m

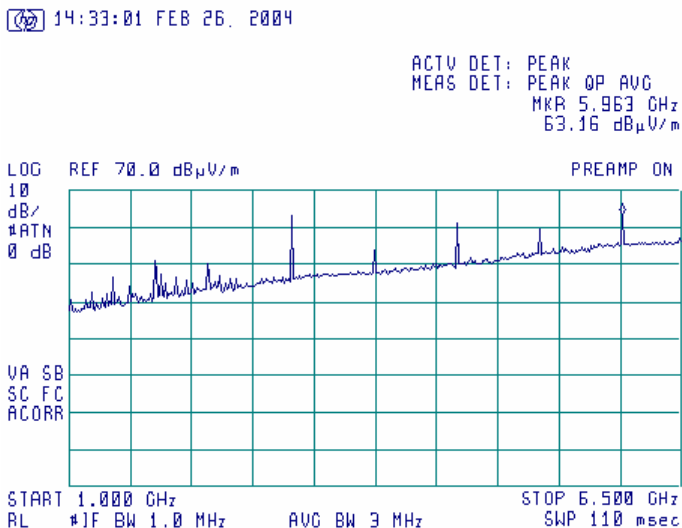

Equivalent field strength limit @ 3m = 84.4 dB(μ V/m)

Plot 4.5.24 Radiated emission measurements in 6.5 – 7.5 GHz range

TEST SITE:	OATS
CARRIER FREQUENCY:	High
ANTENNA POLARIZATION:	Vertical and Horizontal
TEST DISTANCE:	3 m

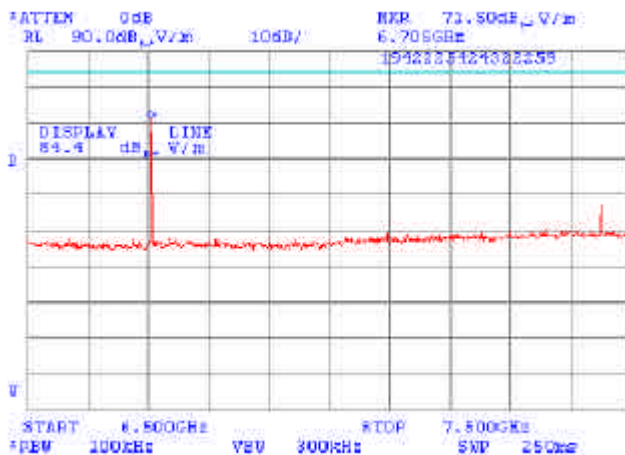



Plot 4.5.25 Radiated emission measurements at the 4th harmonic

TEST SITE: OATS
CARRIER FREQUENCY: High
ANTENNA POLARIZATION: Vertical
TEST DISTANCE: 3 m

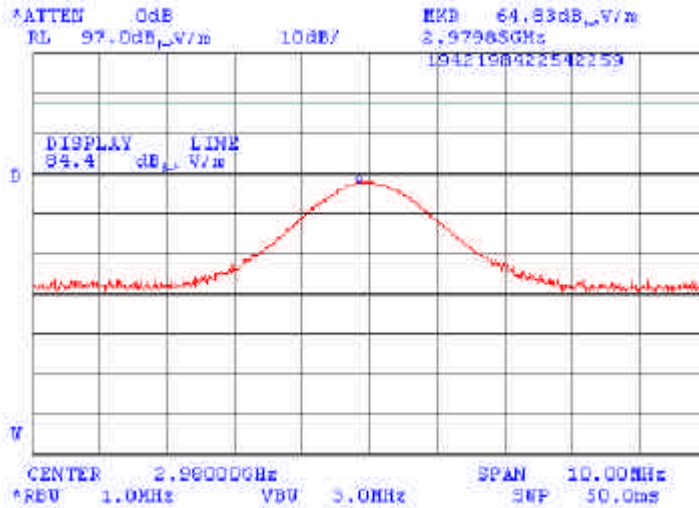

Plot 4.5.26 Radiated emission measurements at the 6th harmonic

TEST SITE: OATS
CARRIER FREQUENCY: High
ANTENNA POLARIZATION: Horizontal
TEST DISTANCE: 3 m

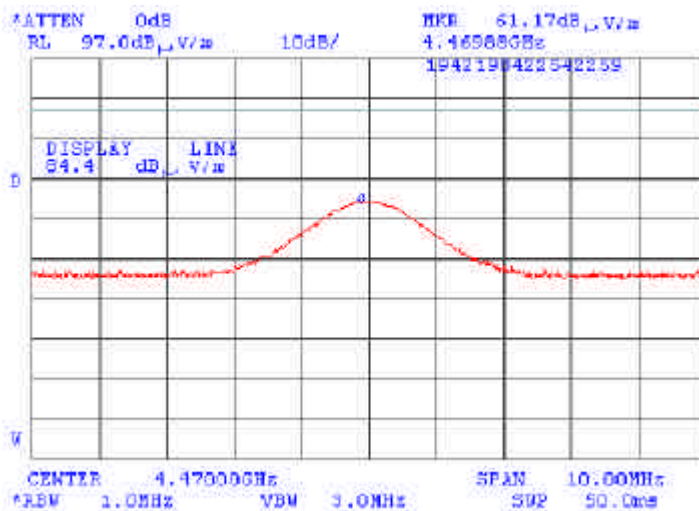



Plot 4.5.27 Radiated emission measurements at the 8th harmonic

TEST SITE: OATS
CARRIER FREQUENCY: High
ANTENNA POLARIZATION: Horizontal
TEST DISTANCE: 3 m

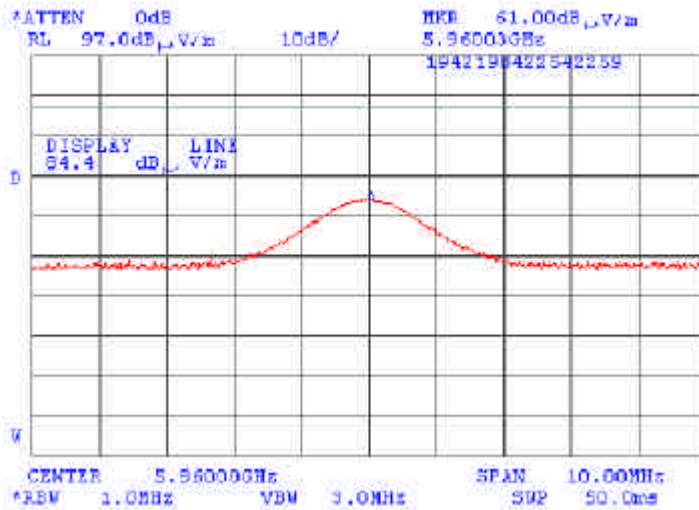

Plot 4.5.28 Radiated emission measurements at the 9th harmonic

TEST SITE: OATS
CARRIER FREQUENCY: High
ANTENNA POLARIZATION: Horizontal
TEST DISTANCE: 3 m

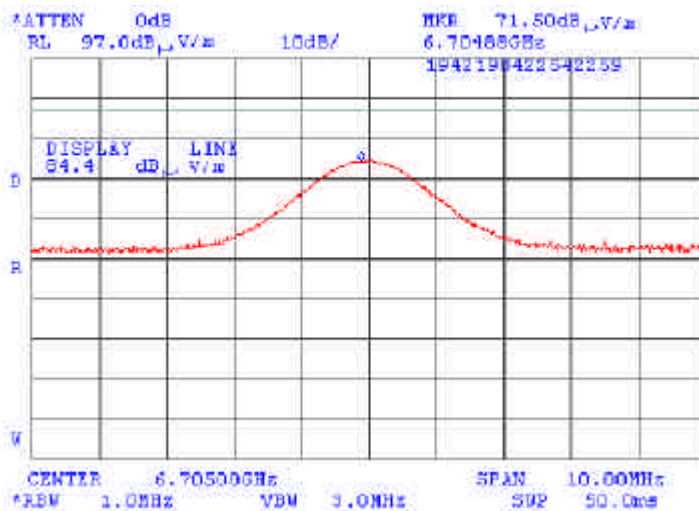



4.6 Conducted emissions

4.6.1 General

This test was performed to measure common mode conducted emissions at the power port. The EUT antenna connector was terminated with 50 Ohm dummy load. Specification test limits are given in Table 4.6.1. The worst test results (the lowest margins) were recorded in Table 4.6.2 and shown in the associated plots.

Table 4.6.1 Limits for conducted emissions

Frequency, MHz	Class B limit, dB(μ V)	
	QP	AVRG
0.15 - 0.5	66 - 56*	56 - 46*
0.5 - 5.0	56	46
5.0 - 30	60	50

* The limit decreases linearly with the logarithm of frequency.

4.6.2 Test procedure

4.6.2.1 The EUT was set up as shown in Figure 4.6.1 and associated photographs, energized and the performance check was conducted.

4.6.2.2 The measurements were performed at SDA power terminal with the LISN, connected to a spectrum analyzer in the frequency range referred to in Table 4.6.2. Unused coaxial connector of the LISN was terminated with 50 Ohm. Quasi-peak and average detectors were used throughout the testing.

4.6.2.3 The position of the device cables was varied to determine maximum emission level.

Figure 4.6.1 Setup for conducted emission measurements, table-top equipment

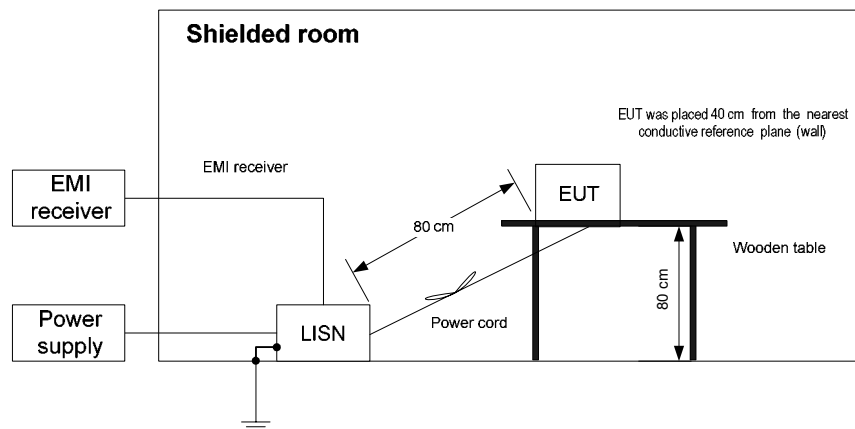



Photograph 4.6.1 Setup for conducted emission measurements, front view



Photograph 4.6.2 Setup for conducted emission measurements, side view





Table 4.6.2 Conducted emission test results

LINE: AC mains
EUT OPERATING MODE: Receive
EUT SET UP: TABLE-TOP
TEST SITE: SHIELDED ROOM
DETECTORS USED: PEAK / QUASI-PEAK / AVERAGE
FREQUENCY RANGE: 150 kHz - 30 MHz
RESOLUTION BANDWIDTH: 9 kHz

Frequency, MHz	Peak emission, dB(μV)	Quasi-peak			Average			Line ID	Verdict
		Measured emission, dB(μV)	Limit, dB(μV)	Margin, dB*	Measured emission, dB(μV)	Limit, dB(μV)	Margin, dB*		
0.15 - 30	All emissions were found more than 20 dB below the average limit							L1	Pass
0.185950	38.44	36.47	64.25	-27.78	34.48	54.25	-19.77	L2	Pass
0.235375	38.37	37.02	62.29	-25.27	32.84	52.29	-19.45		
0.278177	36.83	35.79	60.93	-25.14	31.33	50.93	-19.60		
0.604375	34.30	32.78	56.00	-23.22	29.94	46.00	-16.06		
0.652115	34.16	32.69	56.00	-23.31	29.10	46.00	-16.90		
0.882063	33.66	32.04	56.00	-23.96	28.52	46.00	-17.48		

*- Margin = Measured emission - specification limit.

Reference numbers of test equipment used

HL 0163	HL 0672	HL 0787	HL 1204	HL 1430	HL 1502	HL 1510	
---------	---------	---------	---------	---------	---------	---------	--

Full description is given in Appendix A.



Plot 4.6.1 Conducted emission measurements

LINE: L1
EUT OPERATING MODE: Receive
LIMIT: QUASI-PEAK, AVERAGE
DETECTOR: PEAK

15:17:43 MAR 09, 2004

ACTV DET: PEAK
MEAS DET: PEAK OP AVG
MKR 100 kHz
31.06 dBµV

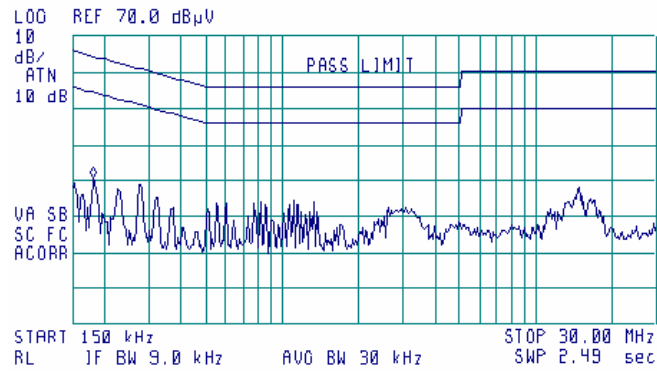

Plot 4.6.2 Conducted emission measurements

LINE: L2
EUT OPERATING MODE: Receive
LIMIT: QUASI-PEAK, AVERAGE
DETECTOR: PEAK

15:33:58 MAR 09, 2004

ACTV DET: PEAK
MEAS DET: PEAK OP AVG
MKR 230 kHz
37.32 dBµV

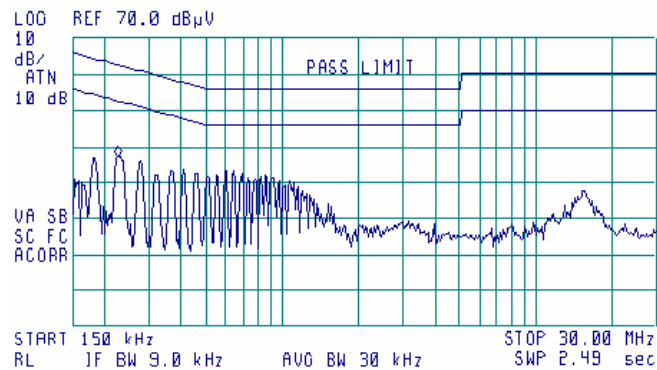



4.7 Antenna power conducted measurements for receiver

4.7.1 General

This test was performed to measure spurious emissions at RF antenna connector of receiver operated within 30 to 960 MHz band, which was tested for compliance with radiated emission limits with the antenna port connected to resistive termination. Specification test limits are given in Table 4.7.1. The test results are provided in Table 4.7.2 and associated plots.

Table 4.7.1 Antenna power conduction limits for receiver

Frequency, MHz	EUT type	Power of spurious	
		nW	dBm
30 MHz – 2 nd harmonic*	Superheterodyne receiver	2.0	-57.0

* - harmonic of the highest local oscillator frequency.

4.7.2 Test procedure

4.7.2.1 The EUT was set up as shown in Figure 4.7.1, energized and its proper operation was checked.

4.7.2.2 The spurious emissions were measured with spectrum analyzer as provided in Table 4.7.2 and associated plots.

Figure 4.7.1 Spurious emission test setup

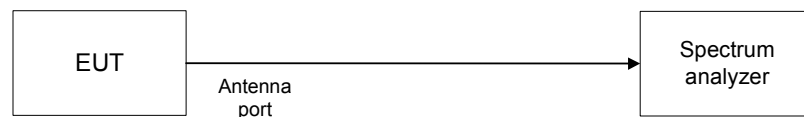



Table 4.7.2 Antenna port conducted test results

INVESTIGATED FREQUENCY RANGE:	30 MHz – 2.2 GHz
RECEIVER TYPE:	Superheterodyne
EUT OPERATING MODE:	Receive
DETECTOR USED:	Peak
RESOLUTION BANDWIDTH:	100 kHz (30 – 1000 MHz range)
	1 MHz (1 – 2.2 GHz range)
VIDEO BANDWIDTH:	300 kHz (30 – 1000 MHz range)
	3 MHz (1 – 2.2 GHz range)

No emissions were found.

Reference numbers of test equipment used

HL 1424	HL 2254						
---------	---------	--	--	--	--	--	--

Full description is given in Appendix A.



Plot 4.7.1 Antenna port conducted measurements for receiver at low frequency

Frequency range: 30 – 1000 MHz

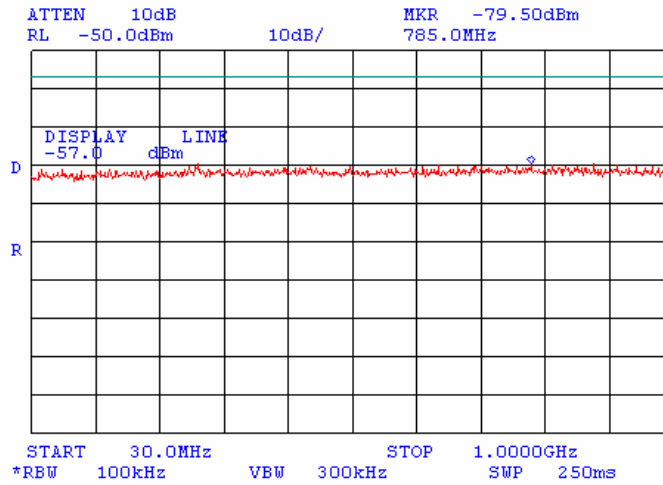

Plot 4.7.2 Antenna port conducted measurements for receiver at low frequency

Frequency range: 1 – 2.2 GHz

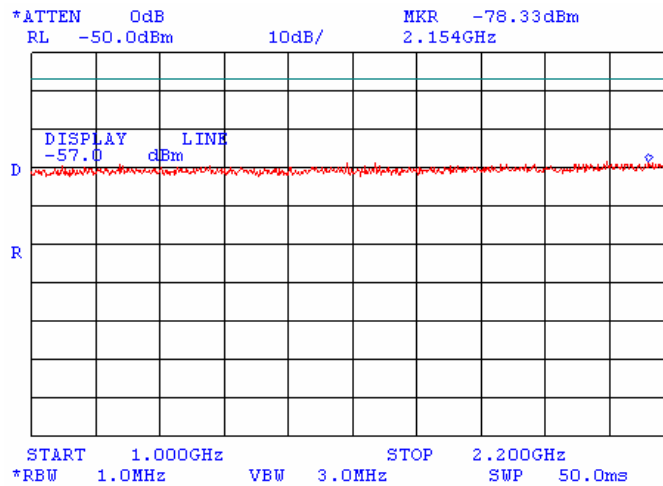



Plot 4.7.3 Antenna port conducted measurements for receiver at mid frequency

Frequency range: 30 – 1000 MHz

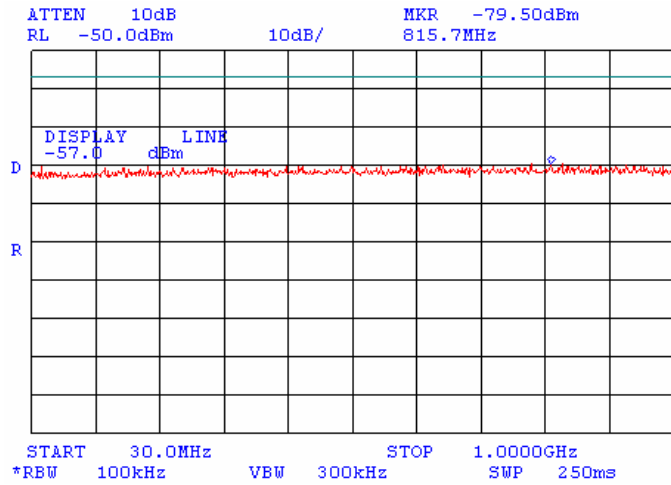

Plot 4.7.4 Antenna port conducted measurements for receiver at mid frequency

Frequency range: 1 – 2.2 GHz

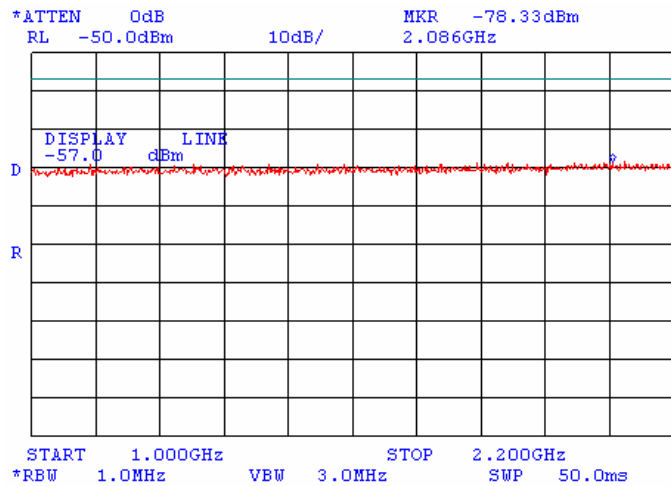



Plot 4.7.5 Antenna port conducted measurements for receiver at high frequency

Frequency range: 30 – 1000 MHz

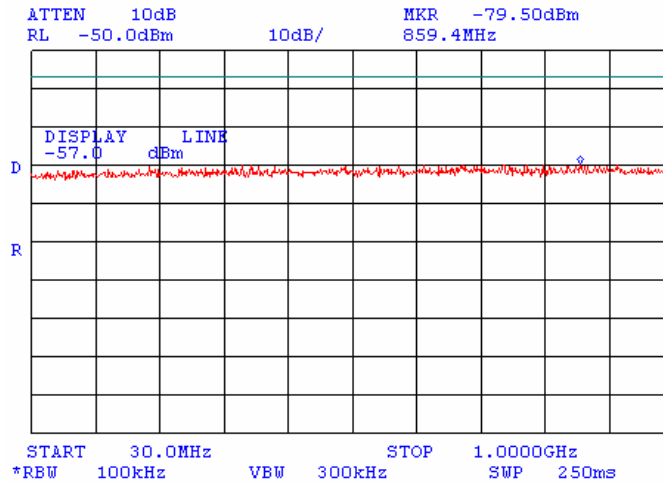

Plot 4.7.6 Antenna port conducted measurements for receiver at high frequency

Frequency range: 1 – 2.2 GHz

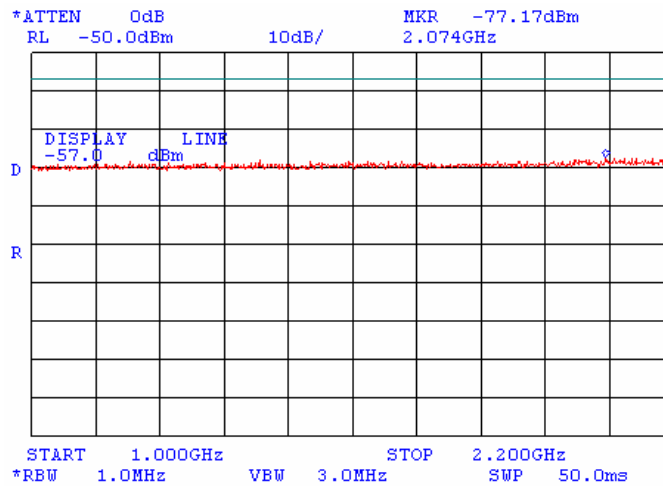



4.8 Radiated emission measurements

4.8.1 General

This test was performed to measure radiated emissions from the EUT enclosure with antenna connector terminated with 50 Ohm dummy load. Specification test limits are given in Table 4.8.1.

Table 4.8.1 Radiated emission test limits

Frequency, MHz	Class B limit, dB(μ V/m)
	3 m distance
30 - 88	40.0
88 - 216	43.5
216 - 960	46.0
Above 960	54.0

4.8.2 Test procedure for measurements in semi-anechoic chamber

- 4.8.2.1 The EUT was set up as shown in Figure 4.8.1 and associated photographs, energized and the performance check was conducted.
- 4.8.2.2 The specified frequency range was investigated with biconilog and double ridged waveguide horn antennas connected to EMI receiver. To find maximum radiation the turntable was rotated 360°, the measuring antenna height was changed from 1 to 4 m, its polarization was switched from vertical to horizontal and the EUT cables position was varied.
- 4.8.2.3 The worst test results (the lowest margins) were recorded in Table 4.8.2 and shown in the associated plots.

Figure 4.8.1 Setup for radiated emission measurements in anechoic chamber, table-top equipment

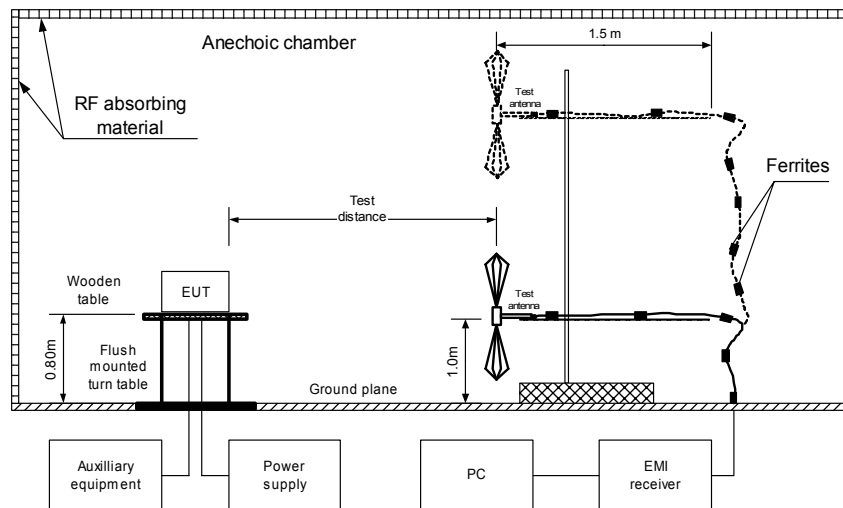



Photograph 4.8.1 Setup for radiated emission measurements in 30 – 1000 MHz range, general view



Photograph 4.8.2 Setup for radiated emission measurements in 1 – 2.2 GHz range, general view





Photograph 4.8.3 Setup for radiated emission measurements, EUT view

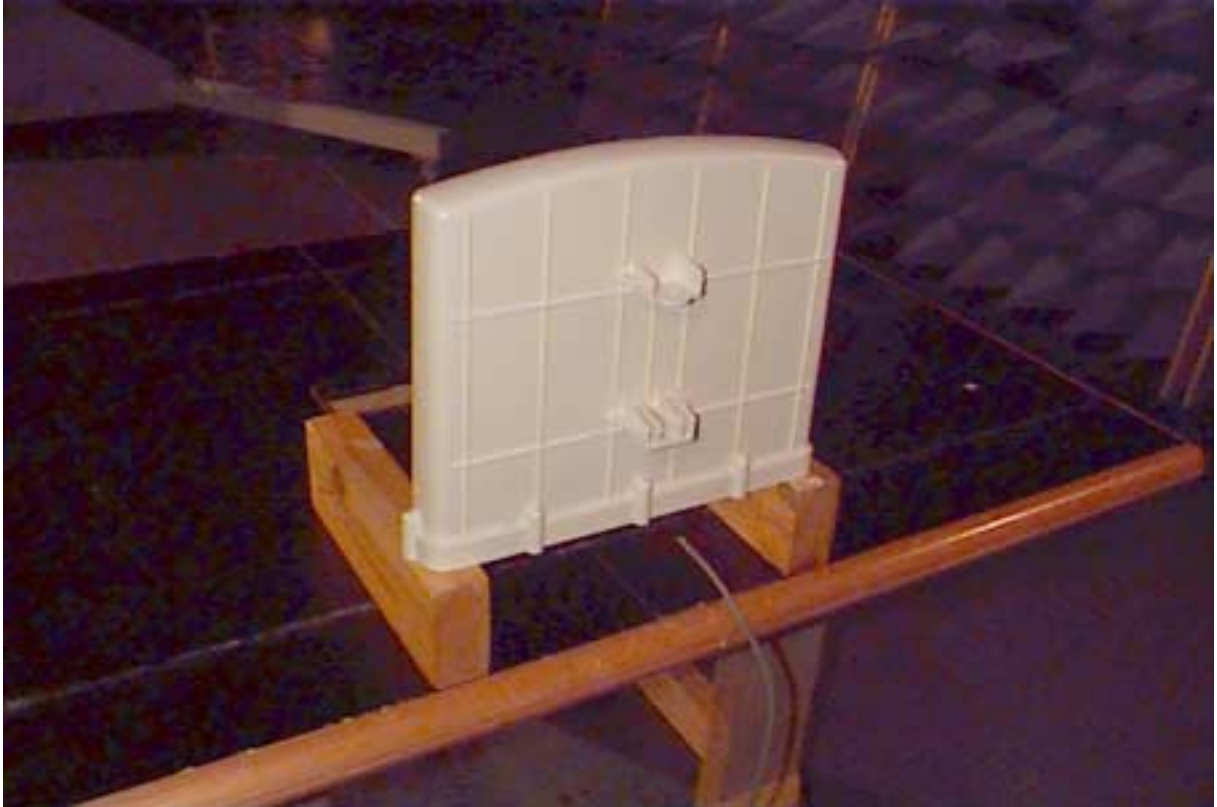



Table 4.8.2 Radiated emission test results

EUT SET UP: TABLE-TOP
LIMIT: Class B
EUT OPERATING MODE: Receive
TEST SITE: SEMI ANECHOIC CHAMBER
TEST DISTANCE: 3 m
DETECTORS USED: PEAK / QUASI-PEAK
FREQUENCY RANGE: 30 – 1000 MHz
RESOLUTION BANDWIDTH: 120 kHz

Frequency, MHz	Peak emission, dB(μ V/m)	Quasi-peak			Antenna polarization	Antenna height, m	Turn-table position**, degrees	Verdict
		Measured emission, dB(μ V/m)	Limit, dB(μ V/m)	Margin, dB*				
125.019000	34.17	32.99	43.50	-10.51	Vertical	1.0	178	Pass
144.001000	36.01	34.03	43.50	-9.47	Vertical	1.0	253	
150.014750	35.18	33.28	43.50	-10.22	Vertical	1.0	191	
240.000500	36.42	35.12	46.00	-10.88	Horizontal	1.0	124	
288.000000	44.33	42.83	46.00	-3.17	Horizontal	1.0	167	
432.015000	41.97	41.07	46.00	-4.93	Vertical	1.0	111	
912.000000	45.61	42.98	46.00	-3.02	Horizontal	1.0	204	

TEST SITE: SEMI ANECHOIC CHAMBER
TEST DISTANCE: 3 m
DETECTORS USED: PEAK / AVERAGE
FREQUENCY RANGE: 1 – 2.2 GHz
RESOLUTION BANDWIDTH: 1 MHz

Frequency, MHz	Peak emission, dB(μ V/m)	Average			Antenna polarization	Antenna height, m	Turn-table position**, degrees	Verdict
		Measured emission, dB(μ V/m)	Limit, dB(μ V/m)	Margin, dB*				
1008.000000	46.26	39.68	54.00	-14.32	Horizontal	1.3	192	Pass
1200.000000	48.27	41.13	54.00	-12.87	Vertical	1.2	166	
1392.001250	48.26	43.14	54.00	-10.86	Vertical	1.2	177	
1420.140000	51.96	26.20	54.00	-27.80	Vertical	1.0	167	
1968.000000	49.84	44.33	54.00	-9.67	Vertical	1.0	173	

*- Margin = Measured emission - specification limit.

** - EUT front panel refer to 0 degrees position of turntable.

Reference numbers of test equipment used

HL 0465	HL 0521	HL 0589	HL 0592	HL 0593	HL 0594	HL 0604	HL 1004
HL 2009	HL 2432						

Full description is given in Appendix A.



Plot 4.8.1 Radiated emission measurements in 30- 1000 MHz range, vertical & horizontal antenna polarization

TEST SITE: Semi anechoic chamber
LIMIT: Class B
TEST DISTANCE: 3 m
EUT OPERATING MODE: Receive

17:51:16 FEB 26, 2004

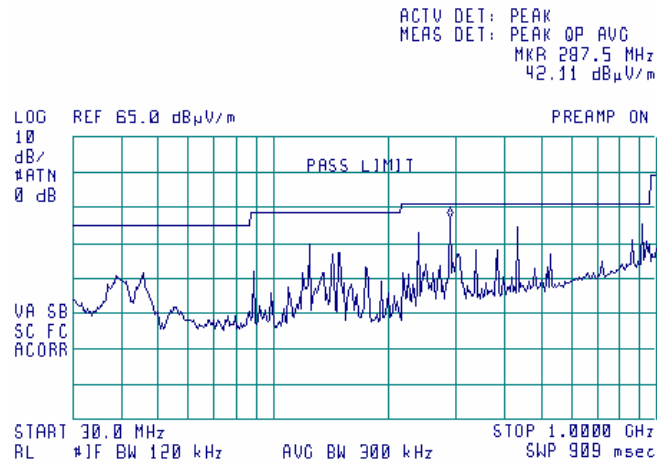

Plot 4.8.2 Radiated emission measurements in 1- 2.2 GHz range, vertical & horizontal antenna polarization

TEST SITE: Semi anechoic chamber
LIMIT: Class B
TEST DISTANCE: 3 m
EUT OPERATING MODE: Receive

16:16:02 MAR 01, 2004

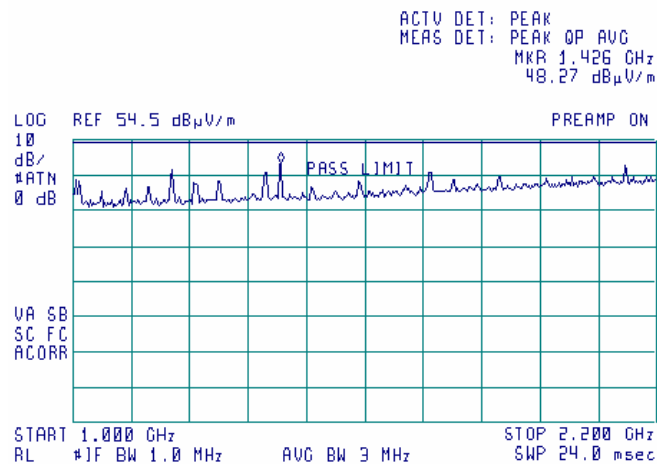



APPENDIX A Test equipment used for tests

HL Serial No.	Description	Manufacturer information			Due calibration Month/ year
		Name	Model No.	Serial No.	
0026	Spectrum analyzer, 100 Hz-2.2 GHz	Anritsu	MS 2601A	3460	9/04
0038	Antenna Mast, 1-4 m	Hermon Labs	AM-1	028	2/05 check
0057	Attenuator, 50 Ohm, 2W, 0-18 GHz, 30 dB	Hewlett Packard	8492A	129	3/05
0091	Position controller for antenna mast + turntable, OFTS	Hermon Labs	CRL-2	NA	4/04 check
0163	LISN FCC/VDE/MIL -STD	Electro-Metrics	ANS-25/2	1314	10/04
0287	Turntable, motorized diameter, 2 m	Hermon Labs	TMD-2	042	11/04 check
0446	Active loop antenna 10 kHz-30 MHz	Electro-Mechanics	6502	2857	10/04
0465	Anechoic chamber 9 (L) x 6.5 (W) x 5.5 (H) m	Hermon Labs	AC-1	023	10/04
0493	Oven temperature	Thermotron	S-1.2 Mini- Max	4016	9/04
0521	Spectrum analyzer with RF filter section (EMI receiver 9 kHz - 6.5 GHz)	Hewlett Packard	8546A	0319	7/04
0559	Multimeter digital	Fluke	Fluke 76	0903	10/04
0589	Cable coaxial, GORE A2POL118.2, 3m	Hermon Labs	GORE-3	589	11/04
0592	Position controller	Hermon Labs	L2-SR3000	100	5/04 check
0593	Antenna mast, 1-4 m/ 1-6 m Pneumatic	Hermon Labs	AM-F1	101	2/05 check
0594	Turntable for anechoic chamber, flush mounted, d=1.2 m, pneumatic	Hermon Labs	WDC1	102	1/05 check
0604	Antenna biconilog log-periodic/T bow- tie, 26 - 2000 MHz	EMCO	3141	9611-1011	1/05
0661	Generator swept signal, 10MHz to 40GHz+ 10dBm	Hewlett Packard	83640B	3614A00266	9/04
0672	Shielded room 4.6(L) x 4.2(W) x 2.4(H) m	Hermon Labs	SR-3	027	11/04 Check
0787	Transient limiter	Hewlett Packard	11947A-8ZE	3107A01877	11/04
1004	Cable coaxial, ANDREW PSWJ4, 6 m	Hermon Labs	ANDREW-6	163	12/04
1204	One phase voltage regulator, 2kVA, 0-250V	Hermon Labs	TDGC-2	99	6/04 Check
1207	One phase voltage regulator, 2kVA, 0-250V	Hermon Labs	TDGC-2	NA	6/04 Check
1424	Spectrum analyzer, 30 Hz - 40 GHz	Agilent Technologies	8564EC	3946A00219	8/04
1430	EMI receiver system, 9 kHz - 2.9 GHz	Agilent Technologies	8542E	3807A00262	9/04



HL Serial No.	Description	Manufacturer information			Due calibration Month/ year
		Name	Model No.	Serial No.	
1458	Cable, 1 m	Harbour Industries	MIL 17/60- RG142	1458	9/04 Check
1502	Cable RF, 6 m	Belden	M17/167 MIL-C-17	1502	12/04 Check
1510	Cable RF, 8 m	Belden	M17/167 MIL-C-17	1510	12/04 Check
1942	Cable 18 GHz, 4 m, blue	Rhophase Microwave Ltd	SPS-1803A- 4000-NPS	T4658	10/04
1984	Antenna, double ridged waveguide horn, 1-18 GHz, 300W, N-type	EMC Test Systems	3115	9911-5964	3/05
2009	Cable RF, 8 m	Alpha Wire	RG-214	2009	12/04
2254	Cable 40GHz, 0.8 m, blue	Rhophase Microwave Limited	KPS-1503A- 800-KPS	W4907	11/04
2259	Amplifier low noise 2-20 GHz	Sophia Wireless	LNA0220-C	0223	11/04
2400	Cable 40GHz, 1.5 m, green	Rhophase Microwave Limited	KPS-1503A- 1500-KPS	X2946	6/04
2432	Antenna, double ridged waveguide horn	EMC Test Systems	3115	000271777	7/04



APPENDIX B Measurement uncertainties

Expanded uncertainty at 95% confidence in Hermon Labs EMC measurements

Test description	Expanded uncertainty
Conducted emissions with LISN	9 kHz to 150 kHz: ± 3.9 dB 150 kHz to 30 MHz: ± 3.8 dB
Radiated emissions at 3 m measuring distance Horizontal polarization	Biconilog antenna: ± 5.3 dB Double ridged horn antenna: ± 5.3 dB Biconilog antenna: ± 6.0 dB
Vertical polarization	Double ridged horn antenna: ± 6.0 dB
Conducted emissions at RF antenna connector	9 kHz to 2.9 GHz: ± 2.6 dB 2.9 GHz to 6.46 GHz: ± 3.5 dB 6.46 GHz to 13.2 GHz: ± 4.3 dB 13.2 GHz to 22.0 GHz: ± 5.0 dB 22.0 GHz to 26.8 GHz: ± 5.5 dB 26.8 GHz to 40.0 GHz: ± 4.8 dB
Occupied bandwidth	± 8.0 %
Frequency stability	± 168 Hz (0.56 ppm)

The test equipment has been calibrated according to its recommended procedures and is within the manufacturer's published limit of error. The standards and instruments used in the calibration system conform to the present requirements of ISO/IEC 17025 (or alternately ANSI/NC SL Z540-1).

The laboratory calibrates its measurement standards by a third party (traceable to NIST, USA) on a regular basis according to equipment manufacturer requirements. The Hermon Labs EMC measurements uncertainty is given in the table above.

Person for contact: Mr. Alex Usoskin, QA manager.



APPENDIX C Test facility description

Tests were performed at Hermon Laboratories Ltd., which is a fully independent, private, EMC, safety, environmental and telecommunication testing facility. Hermon Laboratories is listed by the Federal Communications Commission (USA) for all parts of Code of Federal Regulations 47 (CFR 47) and by Industry Canada for electromagnetic emissions (file numbers IC 2186-1 for OATS and IC 2186-2 for anechoic chamber), certified by VCCI, Japan (the registration numbers are R-808 for OATS, R-1082 for anechoic chamber, C-845 for conducted emissions site), assessed by TNO Certification EP&S (Netherlands) for a number of EMC, telecommunications, environmental, safety standards, and by AMTAC (UK) for safety of medical devices. The laboratory is accredited by American Association for Laboratory Accreditation (USA) according to ISO/IEC 17025 for electromagnetic compatibility, product safety, telecommunications testing and environmental simulation (for exact scope please refer to Certificate No. 839.01).

Address: P.O. Box 23, Binyamina 30500, Israel.
Telephone: +972 4628 8001
Fax: +972 4628 8277
e-mail: mail@hermonlabs.com
website: www.hermonlabs.com

Person for contact: Mr. Alex Usoskin, QA manager.

APPENDIX D Specification references

47CFR part 2	Frequency allocations and radio treaty matters; general rules and regulations
47CFR part 27	Miscellaneous wireless communications services
47CFR part 15 subpart B: 2003	Radio Frequency Devices
ANSI C63.2: 1996	American National Standard for Instrumentation-Electromagnetic Noise and Field Strength, 10 kHz to 40 GHz-Specifications.
ANSI C63.4: 2001	American National Standard for Methods of Measurement of Radio-Noise Emissions from Low-Voltage Electrical and Electronic Equipment in the Range of 9 kHz to 40 GHz.



APPENDIX E Abbreviations and acronyms

A	ampere
AC	alternating current
AVRG	average (detector)
BB	broad band
cm	centimeter
dB	decibel
dBm	decibel referred to one milliwatt
dB(μ V)	decibel referred to one microvolt
dB(μ V/m)	decibel referred to one microvolt per meter
dB(μ A)	decibel referred to one microampere
dB Ω	decibel referred to one Ohm
DC	direct current
ERP	effective radiated power
EUT	equipment under test
F	frequency
GHz	gigahertz
GND	ground
H	height
HL	Hermon laboratories
Hz	hertz
k	kilo
kHz	kilohertz
LISN	line impedance stabilization network
LO	local oscillator
m	meter
MHz	megahertz
min	minute
mm	millimeter
ms	millisecond
μ s	microsecond
NA	not applicable
NB	narrow band
NT	not tested
OATS	open area test site
Ω	Ohm
PCB	printed circuit board
PS	power supply
ppm	part per million (10^{-6})
QP	quasi-peak
RE	radiated emission
RF	radio frequency
rms	root mean square
Rx	receive
s	second
SDA	subscriber data adapter
SPR	subscriber premises radio unit
T	temperature
TDD	time division duplex
Tx	transmit
V	volt
VA	volt-ampere
WB	wideband



APPENDIX F Test equipment correction factors

Antenna factor
Active loop antenna
Model 6502
Serial number 2857

Frequency, MHz	Magnetic antenna factor, dB	Electric antenna factor, dB
0.009	-32.8	18.7
0.010	-33.8	17.7
0.020	-38.3	13.2
0.050	-41.1	10.4
0.075	-41.3	10.2
0.100	-41.6	9.9
0.150	-41.7	9.8
0.250	-41.6	9.9
0.500	-41.8	9.8
0.750	-41.9	9.7
1.000	-41.4	10.1
2.000	-41.5	10.0
3.000	-41.4	10.2
4.000	-41.4	10.1
5.000	-41.5	10.1
10.000	-41.9	9.6
15.000	-41.9	9.6
20.000	-42.2	9.3
25.000	-42.8	8.7
30.000	-44.0	7.5

Antenna factor in dB(1/m) is to be added to receiver meter reading in dB(μ V) to convert it into field intensity in dB(μ V/m).



**Antenna factor
Biconilog antenna EMCO, model 3141,
serial number1011**

Frequency, MHz	Antenna factor, dB(1/m)
26	7.8
28	7.8
30	7.8
40	7.2
60	7.1
70	8.5
80	9.4
90	9.8
100	9.7
110	9.3
120	8.8
130	8.7
140	9.2
150	9.8
160	10.2
170	10.4
180	10.4
190	10.3
200	10.6
220	11.6
240	12.4
260	12.8
280	13.7
300	14.7
320	15.2
340	15.4
360	16.1
380	16.4
400	16.6
420	16.7
440	17.0
460	17.7
480	18.1
500	18.5
520	19.1
540	19.5
560	19.8
580	20.6
600	21.3
620	21.5
640	21.2
660	21.4
680	21.9
700	22.2
720	22.2
740	22.1
760	22.3
780	22.6
800	22.7
820	22.9
840	23.1
860	23.4
880	23.8
900	24.1
920	24.1

Frequency, MHz	Antenna factor, dB(1/m)
940	24.0
960	24.1
980	24.5
1000	24.9
1020	25.0
1040	25.2
1060	25.4
1080	25.6
1100	25.7
1120	26.0
1140	26.4
1160	27.0
1180	27.0
1200	26.7
1220	26.5
1240	26.5
1260	26.5
1280	26.6
1300	27.0
1320	27.8
1340	28.3
1360	28.2
1380	27.9
1400	27.9
1420	27.9
1440	27.8
1460	27.8
1480	28.0
1500	28.5
1520	28.9
1540	29.6
1560	29.8
1580	29.6
1600	29.5
1620	29.3
1640	29.2
1660	29.4
1680	29.6
1700	29.8
1720	30.3
1740	30.8
1760	31.1
1780	31.0
1800	30.9
1820	30.7
1840	30.6
1860	30.6
1880	30.6
1900	30.6
1920	30.7
1940	30.9
1960	31.2
1980	31.6
2000	32.0

Antenna factor in dB(1/m) is to be added to receiver meter reading in dB(μV) to convert it into field intensity in dB(μV/m).



Antenna factor
Double-ridged wave guide horn antenna
Model 3115, serial number 9911-5964

Frequency, MHz	Antenna factor, dB(1/m)
1000.0	24.7
1500.0	25.7
2000.0	27.6
2500.0	28.9
3000.0	31.2
3500.0	32.0
4000.0	32.5
4500.0	32.7
5000.0	33.6
5500.0	35.1
6000.0	35.4
6500.0	34.9
7000.0	36.1
7500.0	37.8
8000.0	38.0
8500.0	38.1
9000.0	39.1
9500.0	38.3
10000.0	38.6
10500.0	38.2
11000.0	38.7
11500.0	39.5
12000.0	40.0
12500.0	40.4
13000.0	40.5
13500.0	41.1
14000.0	41.6
14500.0	41.7
15000.0	38.7
15500.0	38.2
16000.0	38.8
16500.0	40.5
17000.0	42.5
17500.0	45.9
18000.0	49.4

Antenna factor in dB(1/m) is to be added to receiver meter reading in dB(μ V) to convert it into field intensity in dB(μ V/m).



Antenna factor
Double-ridged waveguide horn antenna
Model 3115, serial number: 00027177

Frequency, MHz	Antenna factor. dB(1/m)
1000.0	24.7
1500.0	25.7
2000.0	27.8
2500.0	28.9
3000.0	30.7
3500.0	31.8
4000.0	33.0
4500.0	32.8
5000.0	34.2
5500.0	34.9
6000.0	35.2
6500.0	35.4
7000.0	36.3
7500.0	37.3
8000.0	37.5
8500.0	38.0
9000.0	38.3
9500.0	38.3
10000.0	38.7
10500.0	38.7
11000.0	38.9
11500.0	39.5
12000.0	39.5
12500.0	39.4
13000.0	40.5
13500.0	40.8
14000.0	41.5
14500.0	41.3
15000.0	40.2
15500.0	38.7
16000.0	38.5
16500.0	39.8
17000.0	41.9
17500.0	45.8
18000.0	49.1

Antenna factor in dB(1/m) is to be added to receiver meter reading in dB(μ V) to convert it into field intensity in dB(μ V/m).



**Correction factor
Line impedance stabilization network
Model ANS-25/2
Electro-Metrics**

Frequency, MHz	Correction factor, dB
0.01	4.7
0.02	2.1
0.03	1.1
0.04	0.7
0.05	0.5
0.1	0.2
0.2	0.1
0.4	0.1
0.6	0.1
0.8	0.1
1	0.1
2	0.1
3	0.1
4	0.1
6	0.1
10	0.1
12	0.1
16	0.1
18	0.1
20	0.1
25	0.1
28	0.1
30	0.1

The correction factor in dB is to be added to meter readings of an interference analyzer or a spectrum analyzer.



Cable loss
Cable coaxial, GORE A2P01POL118, 2.3 m, model:GORE-3, HL 0589
+ Cable coaxial, ANDREW PSWJ4, 6m, model: ANDREW-6, HL 1004

No.	Frequency, MHz	Cable loss, dB	Tolerance (Specification), dB	Measurement uncertainty, dB
1	30	0.33	≤ 6.5	±0.12
2	50	0.40		
3	100	0.57		
4	300	0.97		
5	500	1.25		
6	800	1.59		
7	1000	1.81		
8	1200	1.97		
9	1400	2.15		
10	1600	2.28		
11	1800	2.43		
12	2000	2.61		
13	2200	2.75		
14	2400	2.89		
15	2600	2.97		
16	2800	3.21	≤ 6.5	±0.12
17	3000	3.32		
18	3300	3.47		
19	3600	3.62		
20	3900	3.84		
21	4200	3.92		
22	4500	4.07		
23	4800	4.36		
24	5100	4.62		
25	5400	4.78		
26	5700	5.16		
27	6000	5.67		
28	6500	5.99		±0.17



Cable loss
Cable 18 GHz, 4 m, blue, model: SPS-1803A-4000-NPS, serial number T4658, HL 1942

Frequency, GHz	Cable loss, dB
0.03	0.21
0.05	0.26
0.10	0.36
0.20	0.50
0.30	0.61
0.40	0.70
0.50	0.78
0.60	0.85
0.70	0.93
0.80	0.99
0.90	1.04
1.00	1.10
1.10	1.16
1.20	1.22
1.30	1.26
1.40	1.31
1.50	1.35
1.60	1.41
1.70	1.45
1.80	1.49
1.90	1.53
2.00	1.57
2.10	1.61
2.20	1.65
2.30	1.69
2.40	1.72
2.50	1.76
2.60	1.79
2.70	1.83
2.80	1.87
2.90	1.90
3.10	1.97
3.30	2.04
3.50	2.11
3.70	2.18
3.90	2.24
4.10	2.31
4.30	2.38
4.50	2.43
4.70	2.53
4.90	2.53
5.10	2.63
5.30	2.65
5.50	2.72
5.70	2.76
5.90	2.79

Frequency, GHz	Cable loss, dB
6.10	2.88
6.30	2.90
6.50	2.97
6.70	3.02
6.90	3.04
7.10	3.07
7.30	3.12
7.50	3.13
7.70	3.19
7.90	3.24
8.10	3.30
8.30	3.36
8.50	3.45
8.70	3.41
8.90	3.45
9.10	3.42
9.30	3.55
9.50	3.48
9.70	3.58
9.90	3.61
10.10	3.66
10.30	3.68
10.50	3.70
10.70	3.70
10.90	3.75
11.10	3.78
11.30	3.86
11.50	3.98
11.70	4.10
11.90	4.12
12.10	4.09
12.40	4.13
13.00	4.23
13.50	4.35
14.00	4.40
14.50	4.44
15.00	4.57
15.50	4.66
16.00	4.64
16.50	4.66
17.00	4.75
17.50	4.85
18.00	4.93



Cable loss
RF cable 8 m, model RG-214, HL 2009

No.	Frequency, MHz	Cable loss, dB	Tolerance (Specification), dB	Measurement uncertainty, dB
1	1	0.10	NA	±0.12
2	10	0.14		
3	30	0.25		
4	50	0.34		
5	100	0.53		
6	300	0.99		
7	500	1.31		
8	800	1.73		
9	1000	1.98		
10	1100	2.11		
11	1200	2.21		
12	1300	2.35		
13	1400	2.46		
14	1500	2.55		
15	1600	2.68		
16	1700	2.78		
17	1800	2.88		
18	1900	2.98		
19	2000	3.09		



Cable loss
Cable 40 GHz, 0.8 m, blue, model: KPS-1503A-800-KPS, serial number W4907 (HL 2254)

Frequency, GHz	Cable loss, dB	Frequency, GHz	Cable loss, dB	Frequency, GHz	Cable loss, dB
0.03	0.04	5.10	0.80	15.00	1.49
0.05	0.07	5.30	0.83	15.50	1.49
0.10	0.09	5.50	0.83	16.00	1.46
0.20	0.15	5.70	0.84	16.50	1.47
0.30	0.19	5.90	0.87	17.00	1.50
0.40	0.25	6.10	0.86	17.50	1.57
0.50	0.29	6.30	0.89	18.00	1.63
0.60	0.33	6.50	0.90	18.50	1.57
0.70	0.37	6.70	0.89	19.00	1.63
0.80	0.41	6.90	0.93	19.50	1.65
0.90	0.44	7.10	0.92	20.00	1.64
1.00	0.45	7.30	0.95	20.50	1.75
1.10	0.48	7.50	0.96	21.00	1.72
1.20	0.51	7.70	0.97	21.50	1.78
1.30	0.53	7.90	1.01	22.00	1.76
1.40	0.54	8.10	1.00	22.50	1.72
1.50	0.57	8.30	1.05	23.00	1.83
1.60	0.59	8.50	1.04	23.50	1.80
1.70	0.04	8.70	1.07	24.00	1.90
1.80	0.07	8.90	1.11	24.50	1.81
1.90	0.09	9.10	1.09	25.00	1.98
2.00	0.15	9.30	1.14	25.50	1.91
2.10	0.19	9.50	1.12	26.00	2.02
2.20	0.25	9.70	1.15	26.50	1.92
2.30	0.29	9.90	1.16	27.00	1.97
2.40	0.33	10.10	1.16	28.00	2.02
2.50	0.37	10.30	1.19	29.00	1.95
2.60	0.41	10.50	1.14	30.00	1.94
2.70	0.44	10.70	1.19	31.00	2.11
2.80	0.45	10.90	1.17	32.00	2.17
2.90	0.48	11.10	1.13	33.00	2.27
3.10	0.61	11.30	1.20	34.00	2.27
3.30	0.64	11.50	1.13	35.00	2.29
3.50	0.65	11.70	1.20	36.00	2.35
3.70	0.68	11.90	1.18	37.00	2.37
3.90	0.69	12.10	1.14	38.00	2.40
4.10	0.71	12.40	1.19	39.00	2.57
4.30	0.73	13.00	1.34	40.00	2.36
4.50	0.75	13.50	1.33		
4.70	0.77	14.00	1.48		
4.90	0.79	14.50	1.45		



Cable 40 GHz, 1.5 m, green; model KPS-1503A-1500-KPS, serial number X2946 (HL 2400)

Frequency, GHz	Insertion loss, dB
0.03	0.06
0.05	0.08
0.1	0.15
0.2	0.23
0.3	0.29
0.5	0.37
0.7	0.46
0.9	0.53
1.1	0.58
1.3	0.65
1.5	0.66
1.7	0.72
1.9	0.76
2.1	0.79
2.3	0.85
2.5	0.90
2.7	0.91
2.9	0.97
3.1	0.97
3.3	1.03
3.5	1.06
3.7	1.10
3.9	1.13
4.1	1.16
4.3	1.18
4.5	1.21
4.7	1.23
4.9	1.26
5.1	1.28
5.3	1.31
5.5	1.32
5.7	1.36
5.9	1.37
6.1	1.38
6.3	1.44
6.5	1.46
6.7	1.49
6.9	1.50
7.1	1.51
7.3	1.55
7.5	1.56
7.7	1.58
7.9	1.60
8.1	1.61
8.3	1.68
8.5	1.68
8.7	1.75
8.9	1.74
9.1	1.81
9.3	1.79
9.5	1.86
9.7	1.85
9.9	1.87
10.1	1.88

Frequency, GHz	Insertion loss, dB
10.30	1.82
10.50	1.92
10.70	1.86
10.90	1.96
11.10	1.90
11.30	1.99
11.50	1.95
11.70	2.00
11.90	2.01
12.10	1.99
12.40	2.06
13.00	2.11
13.50	2.17
14.00	2.36
14.50	2.32
15.00	2.30
15.50	2.34
16.00	2.34
16.50	2.40
17.00	2.46
17.50	2.54
18.00	2.61
18.50	2.59
19.00	2.59
19.50	2.67
20.00	2.62
20.50	2.73
21.00	2.71
21.50	2.78
22.00	2.83
22.50	2.81
23.00	2.91
23.50	2.97
24.00	2.98
24.50	2.97
25.00	3.03
25.50	3.04
26.00	3.11
26.50	2.97
27.00	3.15
28.00	3.07
29.00	3.13
30.00	3.13
31.00	3.18
32.00	3.31
33.00	3.32
34.00	3.37
35.00	3.36
36.00	3.46
37.00	3.49
38.00	3.52
39.00	3.62
40.00	3.77



Cable RF, 6m, model: M17/167 MIL-C-17, serial number 1502 (HL 1502)
Calibration data (0.1 – 1000 MHz)

No.	Parameter	Set, MHz	Measured, dB	Deviation	Tolerance (specification), dB	Measured uncertainty dB
1	Attenuation	0.1	0.02	NA	NA	±0.12
2		1	0.07			
3		3	0.15			
4		5	0.17			
5		10	0.26			
6		30	0.43			
7		50	0.57			
8		80	0.72			
9		100	0.81			
10		300	1.48			
11		500	2.00			
12		800	2.70			
13		1000	3.09			



Cable RF, 8m, model: M17/167 MIL-C-17, serial number 1510 (HL 1510)
Calibration data (0.1 – 1000 MHz)

No.	Parameter	Set, MHz	Measured, dB	Deviation	Tolerance (specification), dB	Measured uncertainty dB
1	Attenuation	0.1	0.05	NA	NA	±0.12
2		1	0.09			
3		3	0.16			
4		5	0.18			
5		10	0.27			
6		30	0.44			
7		50	0.58			
8		80	0.69			
9		100	0.82			
10		300	1.48			
11		500	2.01			
12		800	2.65			
13		1000	3.12			