

TEST REPORT

ACCORDING TO: TO: FCC 47CFR part 96

FOR:

Airspan Networks Inc.

LTE Base Station Radio

Model: AirHarmony 4200 3550-3700MHz (B48)

FCC ID:PIDAH4200

This report is in conformity with ISO/ IEC 17025. The "A2LA Accredited" symbol endorsement applies only to the tests and calibrations that are listed in the scope of Hermon Laboratories accreditation. The test results relate only to the items tested.
This test report shall not be reproduced in any form except in full with the written approval of Hermon Laboratories Ltd.



Table of contents

1	Applicant information.....	3
2	Equipment under test attributes	3
3	Manufacturer information	3
4	Test details.....	3
5	Tests summary.....	4
6	EUT description.....	5
6.1	General information.....	5
6.2	Ports and lines	5
6.3	Support and test equipment	5
6.4	Changes made in the EUT	5
6.5	Test configuration.....	6
6.6	Transmitter characteristics	7
7	Transmitter tests according to 47CFR part 96.....	8
7.1	Maximum EIRP and maximum power spectral density	8
7.2	Peak-to-average power ratio (PAPR) test	37
7.3	Occupied bandwidth test	45
7.4	Emission outside the fundamental test.....	57
7.5	Radiated spurious emission measurements.....	70
7.6	Spurious emissions at RF antenna connector test	81
7.7	Frequency stability test.....	98
8	APPENDIX A Test equipment and ancillaries used for tests	100
9	APPENDIX B Measurement uncertainties.....	102
10	APPENDIX C Test facility description	103
11	APPENDIX D Specification references	103
12	APPENDIX E Test equipment correction factors.....	104
13	APPENDIX F Abbreviations and acronyms.....	112

1 Applicant information

Client name: Airspan Networks Inc.
Address: 777 Yamato, Road Suite 310 Boca Raton, FL 33431, USA
Telephone: +1 561 893 8670
Fax: +1 561 893 8671
E-mail: zlevi@airspan.com
Contact name: Mr. Zion Levi

2 Equipment under test attributes

Product name: LTE Base Station Radio
Product type: Transceiver
Model(s): AirHarmony 4200 3550-3700MHz (B48)
Serial number: D5EF25CED5BC
Hardware version: C2
Software release: SR 16.00
Receipt date: 16-Dec-18

3 Manufacturer information

Manufacturer name: Airspan Networks Inc.
Address: 777 Yamato, Road Suite 310 Boca Raton, FL 33431, USA
Telephone: +1 561 893 8670
Fax: +1 561 893 8671
E-Mail: zlevi@airspan.com
Contact name: Mr. Zion Levi

4 Test details

Project ID: 31875
Location: Hermon Laboratories Ltd. P.O. Box 23, Binyamina 3055001, Israel
Test started: 16-Dec-18
Test completed: 01-Feb-19
Test specification(s): FCC 47CFR part 96



5 Tests summary

Test	Status
Transmitter characteristics	
Section 96.41(b), Maximum EIRP and maximum power spectral density	Pass
Section 96.41(g), Peak-to- average power ratio	Pass
Section 2.1049, Occupied bandwidth	Pass
Section 96.41(e), Emission mask	Pass
Section 96.41(e)(2), Radiated spurious emissions	Pass
Section 96.41(e)(3), Conducted spurious emissions	Pass
Section 2.1055, Frequency stability	Pass

Testing was completed against all relevant requirements of the test standard. The results obtained indicate that the product under test complies in full with the requirements tested.
The test results relate only to the items tested. Pass/ fail decision was based on nominal values.

This test report supersedes the previously issued test report identified by Doc ID:AIRRAD_FCC.31875_rev2.

	Name and Title	Date	Signature
Tested by:	Mr. S. Samokha, test engineer Mrs. E. Pitt, test engineer Mr. A. Morozov, test engineer	February 1, 2019	
Reviewed by:	Mrs. S Peysahov Sheynin test engineer EMC & Radio	October 31, 2019	
Approved by:	Mr. M. Nikishin, EMC and Radio group manager	October 31, 2019	



6 EUT description

6.1 General information

The EUT, Mobile Digital station, AirHarmony 4200 3550-3700MHz (B48), is part of a LTE broadband fixed cellular wireless access system. The system provides a radio link between an end-user (a subscriber) and a network to give high-speed data access. The AirHarmony's transceiver/receiver (Up to 64 QAM modulation, data rate up to 95 Mbps) equipped with a 9.5 dBi external antenna. Advanced Antenna Techniques 2x2 MIMO are supported. The maximum RF output power (not including antenna gain) is 36.9 dBm for 9.5 dBi and it can be reduced by software.

The AirHarmony is installed outdoors. The Subscriber transmits and receives traffic to and from the base station respectively. The transceiver provides subscribers with "always-on" Internet, high speed data only, or data and voice (VoIP) services and is configured with a unique base station reference number, preventing the LTE UE from relocating to another subscriber premises without authorization.

Note: The AH4200 equipment defined as Category B CBSD (Citizens Broadband Radio Service Device). The transmitter output signal are completely uncorrelated, antennas 1/2 is one sector and antennas 3/4 is another sector. The sectors are not working on the same frequency, each sector has the different frequency.

6.2 Ports and lines

Port type	Port description	Connected from	Connected to	Qty.	Cable type	Cable length, m
Power	DC power	EUT	AC/DC adapter	1	Unshielded	20
Signal	Ethernet	EUT	Laptop	1	Shielded	20
Signal*	Serial*	Not connected	Not connected	1	NA	NA

*for maintenance only

6.3 Support and test equipment

Description	Manufacturer	Model number	Serial number
Laptop	Dell	E7450	8TYRP32
USB to RS-232 convertor	ATEN	UC2324	NA
AC/DC adapter	DVE	DSA-96PFB-12 1 120750	P/N DSA-96PFB-12 1 120750-W25

6.4 Changes made in the EUT

No changes were implemented in the EUT during testing.



6.5 Test configuration

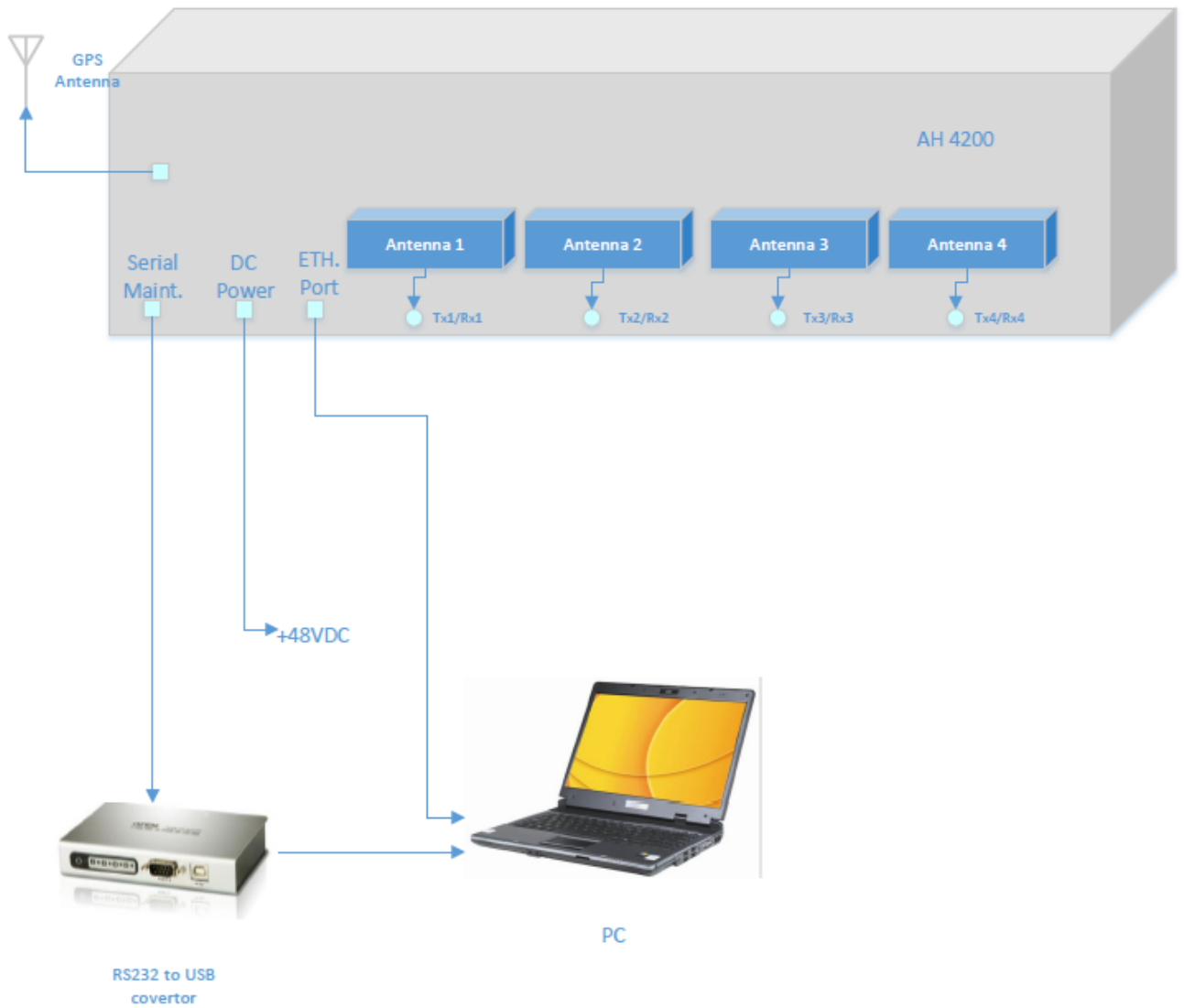



6.6 Transmitter characteristics

Type of equipment						
<input checked="" type="checkbox"/>	Stand-alone (Equipment with or without its own control provisions)					
<input type="checkbox"/>	Combined equipment (Equipment where the radio part is fully integrated within another type of equipment)					
<input type="checkbox"/>	Plug-in card (Equipment intended for a variety of host systems)					
Intended use		Condition of use				
<input checked="" type="checkbox"/>	fixed	Always at a distance more than 2 m from all people				
<input type="checkbox"/>	mobile	Always at a distance more than 20 cm from all people				
<input type="checkbox"/>	portable	May operate at a distance closer than 20 cm to human body				
Assigned frequency range		3550.0 – 3700.0 MHz				
Operating frequency (full bands)		3555.0 – 3695.0 MHz				
RF channel spacing		10 MHz, 20 MHz				
Maximum rated output power		At transmitter 50 Ω RF output connector (per port)	36.9 dBm			
Is transmitter output power variable?		No				
		<input checked="" type="checkbox"/>	Yes	continuous variable		
			Yes	<input checked="" type="checkbox"/>	stepped variable with step size	0.25 dB
					minimum RF power	-30 dBm
		maximum RF power at antenna connector	dBm			
Antenna connection						
<input type="checkbox"/>	unique coupling	<input checked="" type="checkbox"/>	standard connector			
<input type="checkbox"/>		<input type="checkbox"/>	Integral			
<input checked="" type="checkbox"/>		<input type="checkbox"/>	with temporary RF connector			
<input type="checkbox"/>		<input type="checkbox"/>	without temporary RF connector			
Antenna/s technical characteristics						
Type	Manufacturer	Model number	Gain			
External	ALPHA Wireless Ltd.	AW3089	9.5 dBi			
Transmitter aggregate data rate/s, Mbps						
Transmitter 26dBc power bandwidth	Type of modulation					
		QPSK	16QAM	64QAM		
	10 MHz	10.7	22.7	47.3		
20 MHz	23.4	45.4	95			
Type of multiplexing		TDD				
Modulating test signal (baseband)		PRBS				
Maximum transmitter duty cycle in normal use		0.74				
Transmitter power source						
	Nominal rated voltage		Battery type			
<input checked="" type="checkbox"/>	DC	Nominal rated voltage	48 VDC			
	AC mains	Nominal rated voltage	Frequency			
Common power source for transmitter and receiver		<input checked="" type="checkbox"/>	yes			
		<input type="checkbox"/>	no			



Test specification: Section 96.41(b), Maximum EIRP and maximum power spectral density			
Test procedure: Section 96.41(e)(3)			
Test mode: Compliance		Verdict: PASS	
Date(s): 16-Dec-18 - 17-Dec-18			
Temperature: 23 °C	Relative Humidity: 55 %	Air Pressure: 1010 hPa	Power: 48 VDC
Remarks:			

7 Transmitter tests according to 47CFR part 96

7.1 Maximum EIRP and maximum power spectral density

7.1.1 General

This test was performed to measure the maximum EIRP and maximum spectral power density at the transmitter RF antenna connector. Specification test limits are given in Table 7.1.1, Table 7.1.2.

Table 7.1.1 Peak output power limits

Assigned frequency range, MHz	EIRP	
	W/10 MHz	dBm/10 MHz
3550 - 3700	17.0	47.0

Table 7.1.2 Peak spectral power density limits

Assigned frequency range, MHz	Measurement bandwidth, MHz	Peak spectral power density, dBm
3550 - 3700	1.0	37.0

7.1.2 Test procedure

7.1.2.1 The EUT was set up as shown in Figure 7.1.1, energized and its proper operation was checked.

7.1.2.2 The EUT was adjusted to produce maximum available to end user RF output power.

7.1.2.3 The peak output power was measured with power meter as provided in Table 7.1.3.

7.1.2.4 Spectrum analyzer was set in average mode, sufficient number of sweeps was allowed for trace stabilization and peak spectral power density was measured as provided in Table 7.1.4 to Table 7.1.7 and the associated plots.

Figure 7.1.1 Peak output power and spectral power density test setup

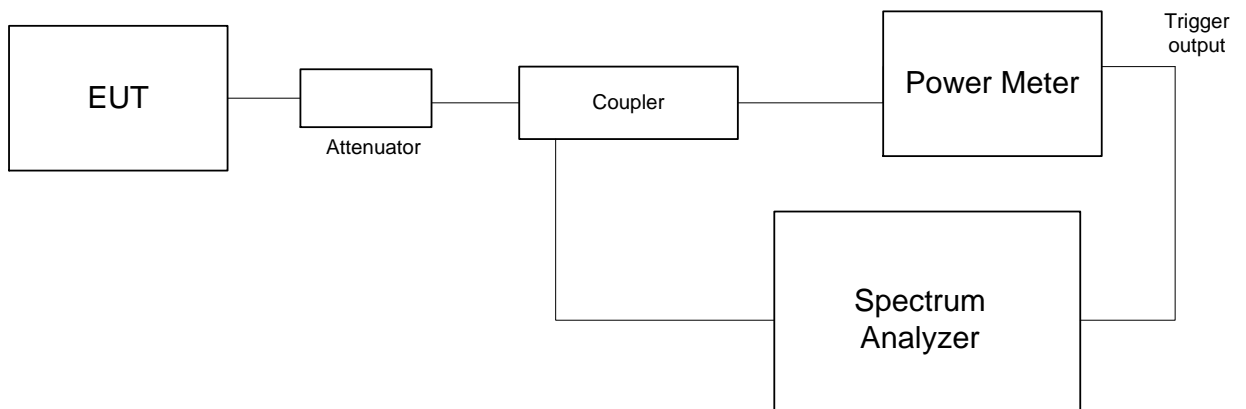



Test specification: Section 96.41(b), Maximum EIRP and maximum power spectral density			
Test procedure: Section 96.41(e)(3)			
Test mode: Compliance		Verdict: PASS	
Date(s): 16-Dec-18 - 17-Dec-18			
Temperature: 23 °C	Relative Humidity: 55 %	Air Pressure: 1010 hPa	Power: 48 VDC
Remarks:			

Table 7.1.3 Maximum EIRP test results

ASSIGNED FREQUENCY RANGE:
DETECTOR USED:
VIDEO BANDWIDTH:
CHANNEL SPACING:

3550.0 – 3700.0 MHz
Average (gated)
≥ Resolution bandwidth
10 MHz

Frequency, MHz	RF Output power				Antenna gain, dBi	EIRP*, dBm/10 MHz	Limit, dBm/10 MHz	Margin, dB**	Verdict
	Chain RF#1, dBm	Chain RF#2, dBm	Chain RF#3, dBm	Chain RF#4, dBm					
Modulation QPSK									
3555.0	35.76	35.87	35.73	35.79	9.5	45.37	47.0	-1.63	Pass
3625.0	35.55	35.58	35.62	35.93	9.5	45.43	47.0	-1.57	Pass
3695.0	35.78	35.43	35.56	35.63	9.5	45.28	47.0	-1.72	Pass
Modulation 16QAM									
3555.0	36.13	36.79	35.82	35.77	9.5	46.29	47.0	-0.71	Pass
3625.0	36.17	36.90	35.88	35.82	9.5	46.40	47.0	-0.60	Pass
3695.0	36.23	36.57	35.79	35.45	9.5	46.07	47.0	-0.93	Pass
Modulation 64QAM									
3555.0	36.03	35.87	35.96	35.78	9.5	45.53	47.0	-1.47	Pass
3625.0	35.72	35.84	35.78	35.82	9.5	45.34	47.0	-1.66	Pass
3695.0	35.83	36.05	35.53	35.73	9.5	45.55	47.0	-1.45	Pass

* - EIRP = Max SA reading (Chains #1&2 and #3&4) + Antenna gain

** - Margin = EIRP, dBm – specification limit.

CHANNEL SPACING: 20 MHz

Frequency, MHz	RF Output power				Antenna gain, dBi	EIRP*, dBm/10 MHz	Limit, dBm/10 MHz	Margin, dB**	Verdict
	Chain RF#1, dBm	Chain RF#2, dBm	Chain RF#3, dBm	Chain RF#4, dBm					
Modulation QPSK									
3560.0	37.53	37.65	37.44	37.46	9.5	44.70	47.0	-2.30	Pass
3625.0	37.22	38.11	38.01	37.38	9.5	45.16	47.0	-1.84	Pass
3690.0	36.76	37.75	37.62	36.88	9.5	44.80	47.0	-2.20	Pass
Modulation 16QAM									
3560.0	37.52	37.66	37.39	37.43	9.5	44.71	47.0	-2.29	Pass
3625.0	37.35	37.87	37.33	37.29	9.5	44.92	47.0	-2.08	Pass
3690.0	37.41	37.84	37.29	37.23	9.5	44.89	47.0	-2.11	Pass
Modulation 64QAM									
3560.0	37.45	37.36	37.65	37.66	9.5	44.71	47.0	-2.29	Pass
3625.0	37.32	37.92	37.51	37.62	9.5	44.97	47.0	-2.03	Pass
3690.0	37.12	37.61	37.28	37.57	9.5	44.66	47.0	-2.34	Pass

* - EIRP = Max SA reading (Chains #1&2 and #3&4) - 10*log[OBW(MHz) / 10 MHz] + Antenna gain =
= Max SA reading – 2.45 dB + Antenna gain

** - Margin = EIRP, dBm – specification limit.



Test specification: Section 96.41(b), Maximum EIRP and maximum power spectral density			
Test procedure: Section 96.41(e)(3)			
Test mode: Compliance		Verdict: PASS	
Date(s): 16-Dec-18 - 17-Dec-18			
Temperature: 23 °C	Relative Humidity: 55 %	Air Pressure: 1010 hPa	Power: 48 VDC
Remarks:			

Table 7.1.4 Peak spectral power density test results

ASSIGNED FREQUENCY RANGE:
DETECTOR USED:
VIDEO BANDWIDTH:
NUMBER OF CHAINS:

3550.0 – 3700.0 MHz
Average (gated)
≥ Resolution bandwidth
4

Frequency, MHz	RF Output power				Total PSD*, dBm/MHz	Limit, dBm/MHz	Margin, dB	Verdict
	Chain RF#1, dBm	Chain RF#2, dBm	Chain RF#3, dBm	Chain RF#4, dBm				
Channel Spacing 10 MHz								
Modulation QPSK								
3555.0	24.51	24.64	24.76	24.60	36.70	37.0	-0.30	Pass
3625.0	23.80	23.80	23.78	24.48	36.42	37.0	-0.58	Pass
3695.0	24.70	24.22	24.24	24.08	36.64	37.0	-0.36	Pass
Modulation 16QAM								
3555.0	24.80	24.42	24.76	24.44	36.74	37.0	-0.26	Pass
3625.0	24.69	24.99	24.40	24.45	36.93	37.0	-0.07	Pass
3695.0	24.28	24.09	24.57	24.07	36.51	37.0	-0.49	Pass
Modulation 64QAM								
3555.0	24.93	24.88	24.75	24.41	36.87	37.0	-0.13	Pass
3625.0	24.48	24.03	24.49	24.23	36.43	37.0	-0.57	Pass
3695.0	24.73	24.60	23.89	24.47	36.93	37.0	-0.07	Pass
Channel Spacing 20 MHz								
Modulation QPSK								
3560.0	23.88	23.89	23.78	23.79	35.83	37.0	-1.17	Pass
3625.0	23.10	23.82	24.31	23.41	36.25	37.0	-0.75	Pass
3690.0	22.74	23.74	23.41	22.95	35.68	37.0	-1.32	Pass
Modulation 16QAM								
3560.0	24.32	23.51	23.92	23.35	36.26	37.0	-0.74	Pass
3625.0	23.27	24.07	23.13	22.95	36.01	37.0	-0.99	Pass
3690.0	22.88	23.91	23.55	23.25	35.85	37.0	-1.15	Pass
Modulation 64QAM								
3560.0	23.66	23.55	23.86	24.21	36.15	37.0	-0.85	Pass
3625.0	23.17	23.99	23.65	23.74	35.93	37.0	-1.07	Pass
3690.0	23.07	23.94	23.41	23.78	35.88	37.0	-1.12	Pass

* - Total PSD = Max SA reading (Chains #1&2 or chains #3&4) + Antenna Gain + Duty Cycle Factor

** - Margin = Total PSD, dBm – specification limit.

Reference numbers of test equipment used

HL 2909	HL 3301	HL 3433	HL 5409			
---------	---------	---------	---------	--	--	--

Full description is given in Appendix A.



HERMON LABORATORIES

Test specification: Section 96.41(b), Maximum EIRP and maximum power spectral density			
Test procedure: Section 96.41(e)(3)			
Test mode: Compliance		Verdict: PASS	
Date(s): 16-Dec-18 - 17-Dec-18			
Temperature: 23 °C	Relative Humidity: 55 %	Air Pressure: 1010 hPa	Power: 48 VDC
Remarks:			

Plot 7.1.1 Peak spectral power density at low frequency

CHANNEL SPACING:
ANTENNA CHAIN:
Modulation: QPSK

10 MHz
1
Modulation: 16QAM

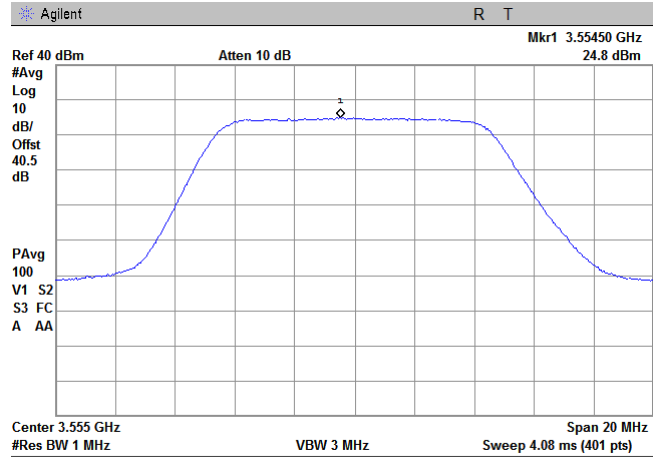
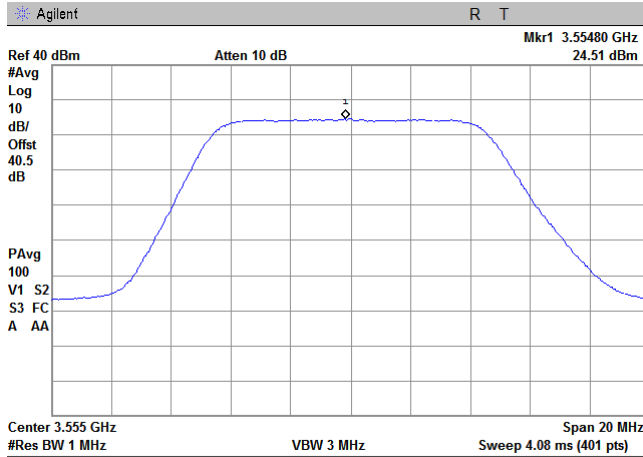

Modulation: 64QAM

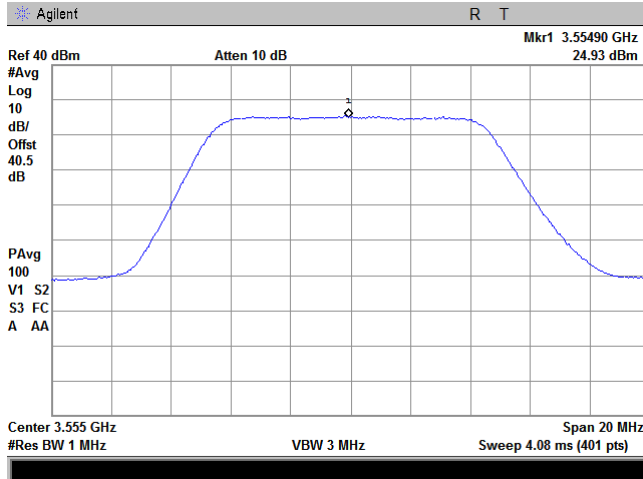



HERMON LABORATORIES

Test specification: Section 96.41(b), Maximum EIRP and maximum power spectral density			
Test procedure: Section 96.41(e)(3)			
Test mode: Compliance		Verdict: PASS	
Date(s): 16-Dec-18 - 17-Dec-18			
Temperature: 23 °C	Relative Humidity: 55 %	Air Pressure: 1010 hPa	Power: 48 VDC
Remarks:			

Plot 7.1.2 Peak spectral power density at mid frequency

CHANNEL SPACING:

10 MHz

ANTENNA CHAIN:

1

Modulation: QPSK

Modulation: 16QAM

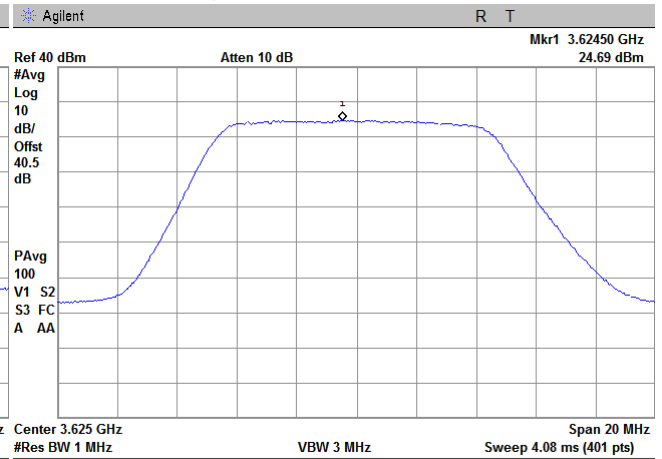
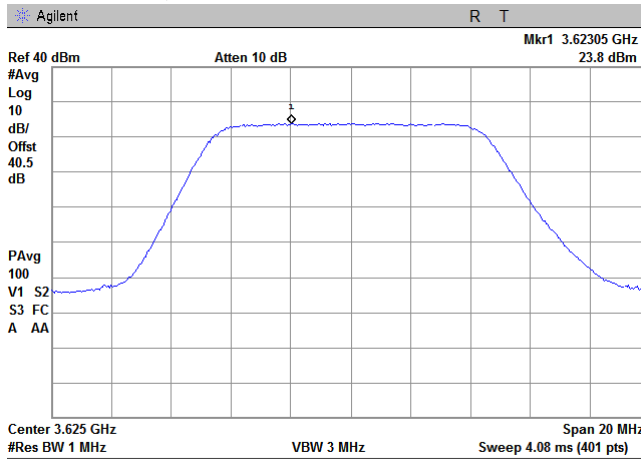

Modulation: 64QAM

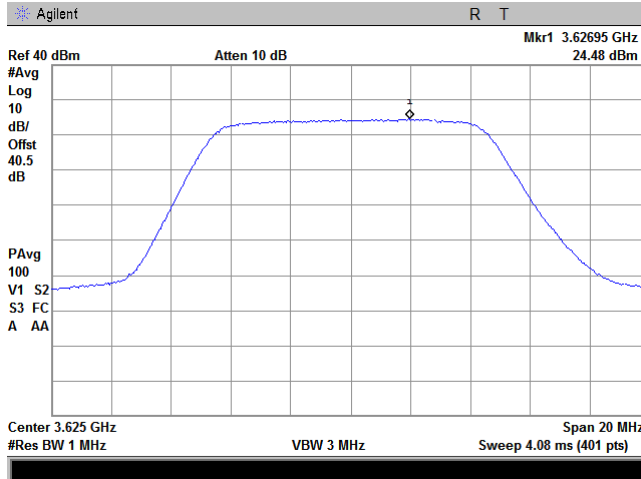



HERMON LABORATORIES

Test specification: Section 96.41(b), Maximum EIRP and maximum power spectral density			
Test procedure: Section 96.41(e)(3)			
Test mode: Compliance		Verdict: PASS	
Date(s): 16-Dec-18 - 17-Dec-18			
Temperature: 23 °C	Relative Humidity: 55 %	Air Pressure: 1010 hPa	Power: 48 VDC
Remarks:			

Plot 7.1.3 Peak spectral power density at high frequency

CHANNEL SPACING:
ANTENNA CHAIN:
Modulation: QPSK

10 MHz
1
Modulation: 16QAM

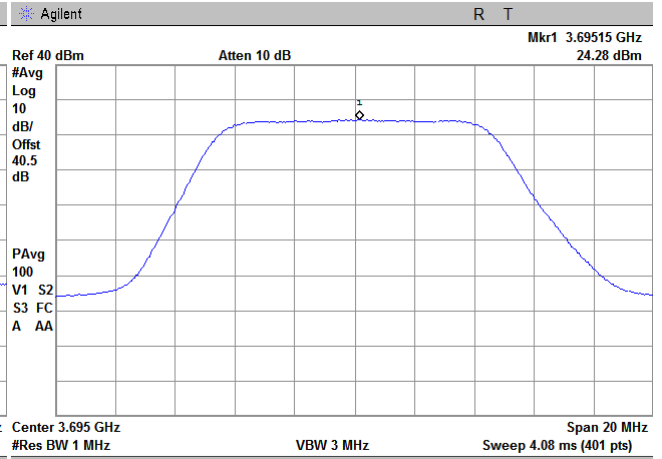
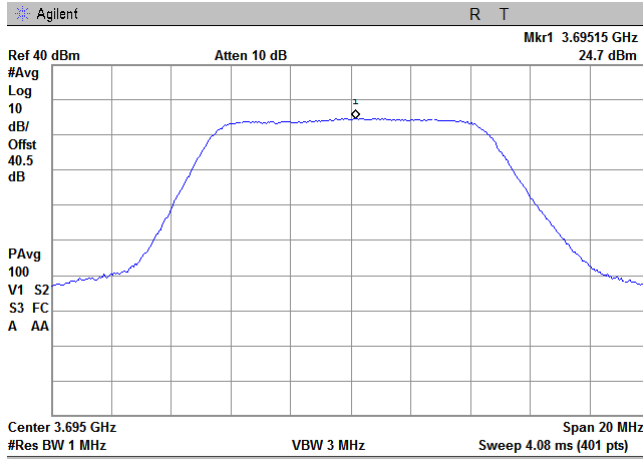

Modulation: 64QAM

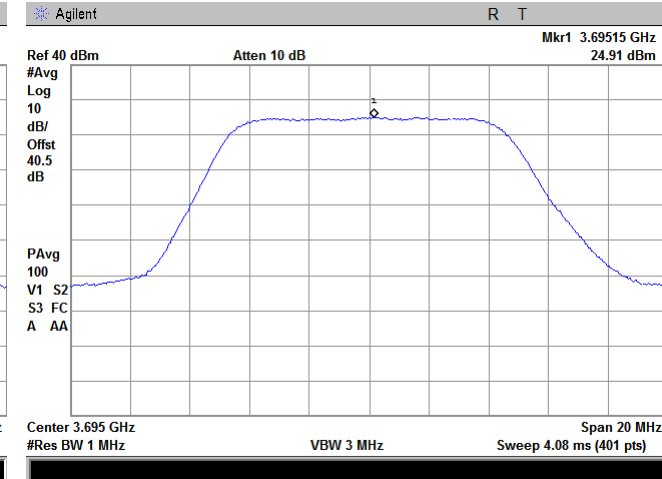
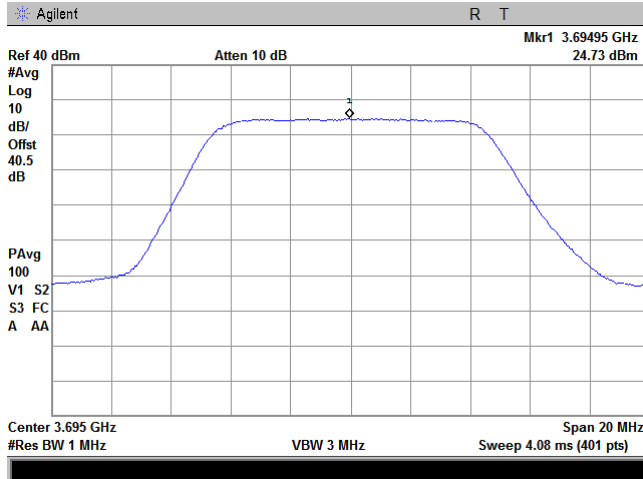



HERMON LABORATORIES

Test specification: Section 96.41(b), Maximum EIRP and maximum power spectral density			
Test procedure: Section 96.41(e)(3)			
Test mode: Compliance		Verdict: PASS	
Date(s): 16-Dec-18 - 17-Dec-18			
Temperature: 23 °C	Relative Humidity: 55 %	Air Pressure: 1010 hPa	Power: 48 VDC
Remarks:			

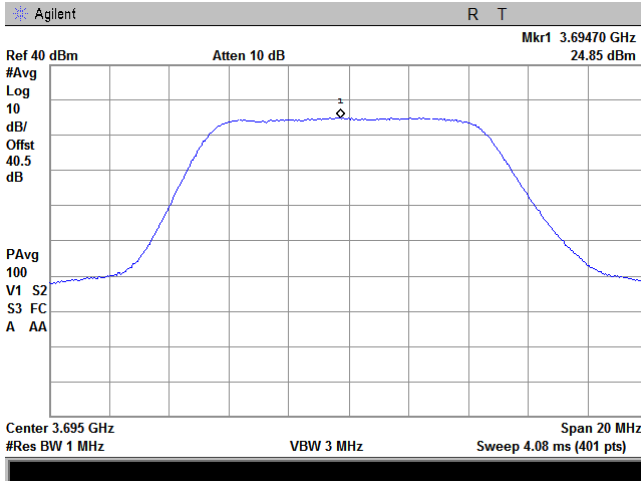



HERMON LABORATORIES

Test specification: Section 96.41(b), Maximum EIRP and maximum power spectral density			
Test procedure: Section 96.41(e)(3)			
Test mode: Compliance		Verdict: PASS	
Date(s): 16-Dec-18 - 17-Dec-18			
Temperature: 23 °C	Relative Humidity: 55 %	Air Pressure: 1010 hPa	Power: 48 VDC
Remarks:			

Plot 7.1.4 Peak spectral power density at low frequency

CHANNEL SPACING:
ANTENNA CHAIN:
Modulation: QPSK

10 MHz
2
Modulation: 16QAM

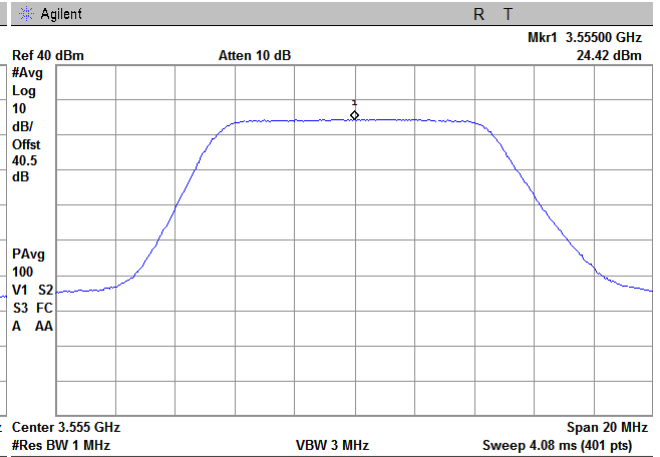
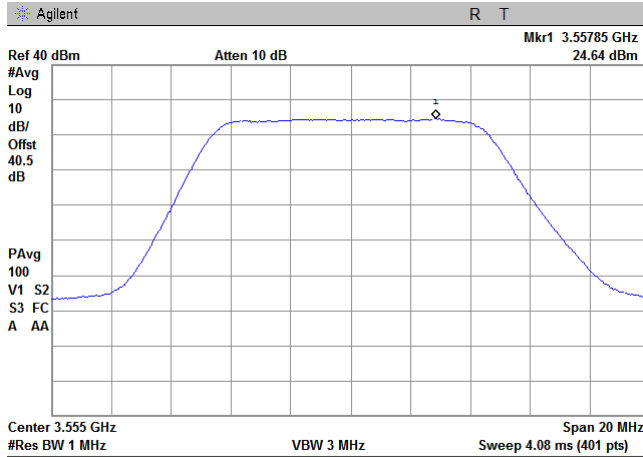

Modulation: 64QAM

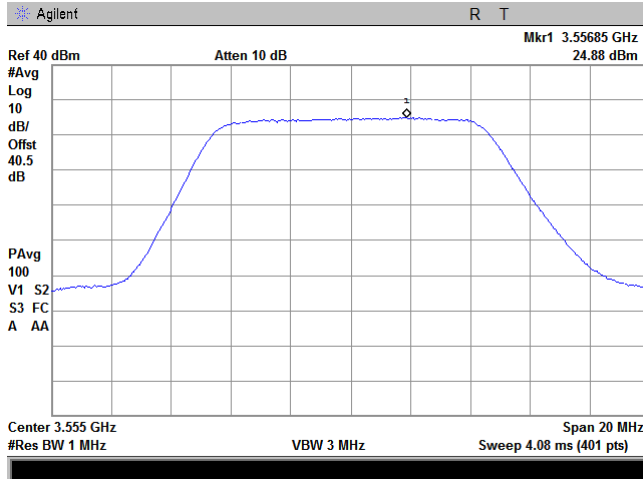



HERMON LABORATORIES

Test specification: Section 96.41(b), Maximum EIRP and maximum power spectral density			
Test procedure: Section 96.41(e)(3)			
Test mode: Compliance		Verdict: PASS	
Date(s): 16-Dec-18 - 17-Dec-18			
Temperature: 23 °C	Relative Humidity: 55 %	Air Pressure: 1010 hPa	Power: 48 VDC
Remarks:			

Plot 7.1.5 Peak spectral power density at mid frequency

CHANNEL SPACING:
ANTENNA CHAIN:
Modulation: QPSK

10 MHz
2
Modulation: 16QAM

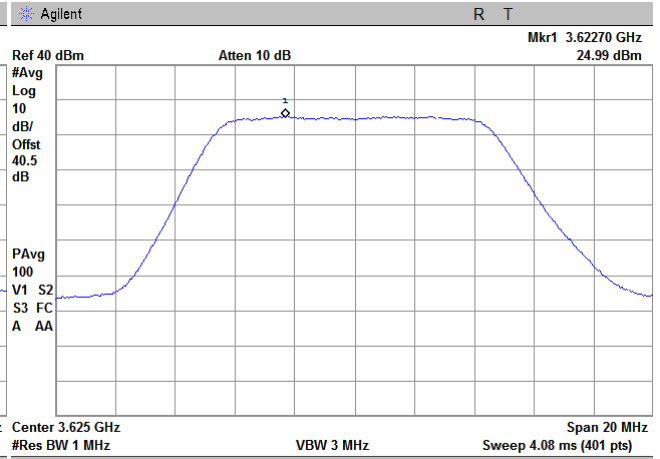
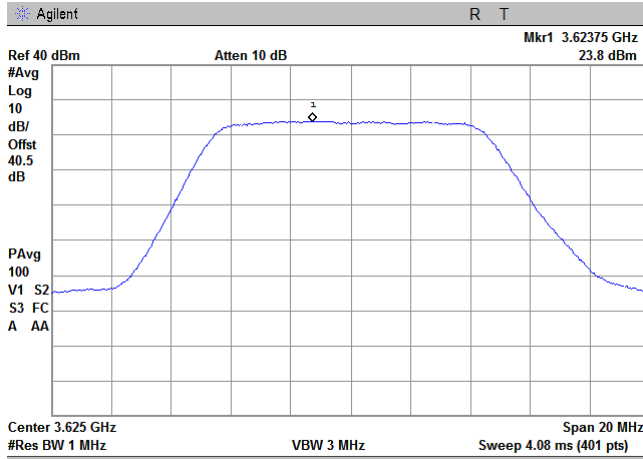

Modulation: 64QAM

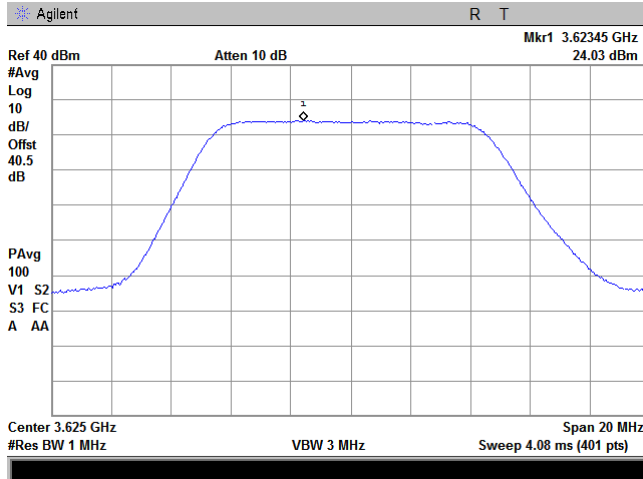



HERMON LABORATORIES

Test specification: Section 96.41(b), Maximum EIRP and maximum power spectral density			
Test procedure: Section 96.41(e)(3)			
Test mode: Compliance		Verdict: PASS	
Date(s): 16-Dec-18 - 17-Dec-18			
Temperature: 23 °C	Relative Humidity: 55 %	Air Pressure: 1010 hPa	Power: 48 VDC
Remarks:			

Plot 7.1.6 Peak spectral power density at high frequency

CHANNEL SPACING:

10 MHz

ANTENNA CHAIN:

2

Modulation: QPSK

Modulation: 16QAM

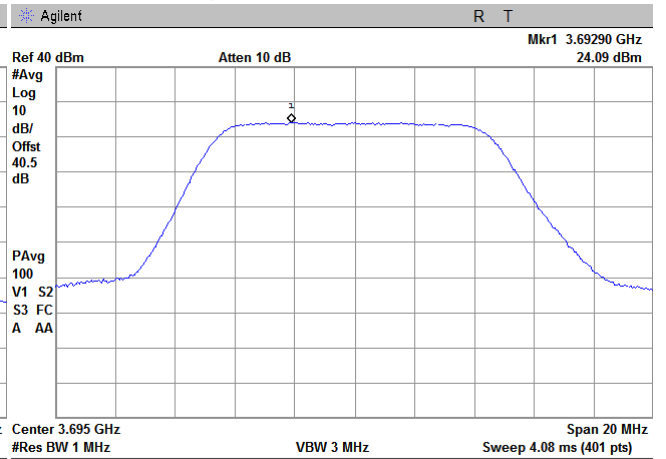
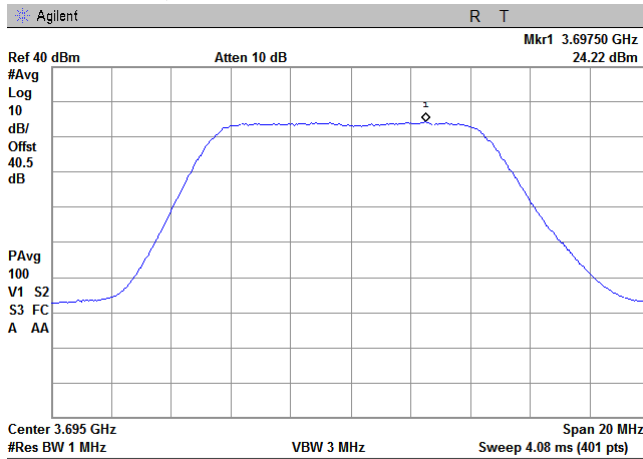

Modulation: 64QAM

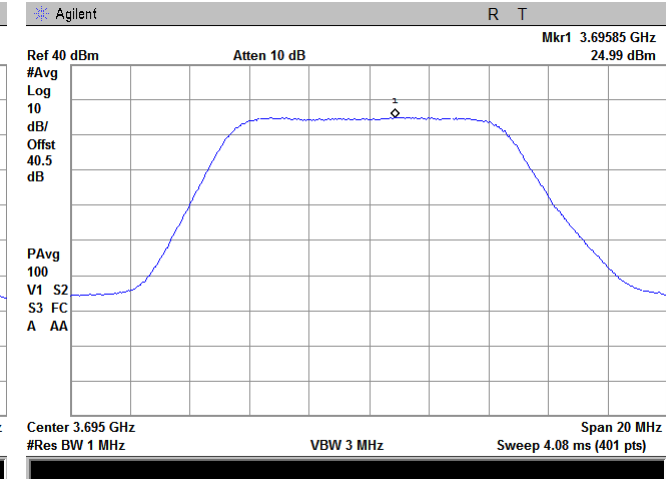
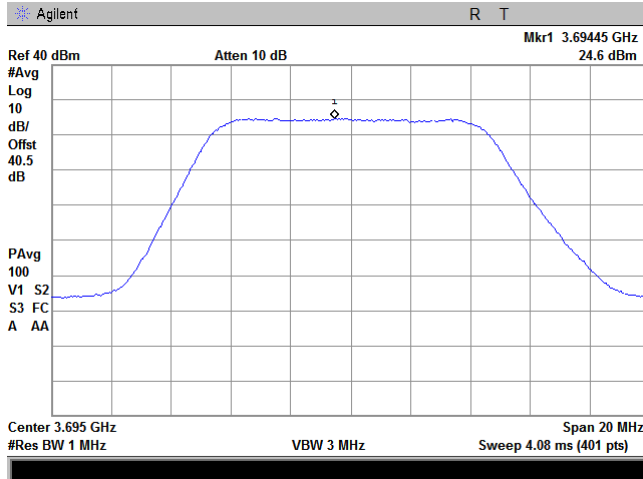



HERMON LABORATORIES

Test specification: Section 96.41(b), Maximum EIRP and maximum power spectral density			
Test procedure: Section 96.41(e)(3)			
Test mode: Compliance		Verdict: PASS	
Date(s): 16-Dec-18 - 17-Dec-18			
Temperature: 23 °C	Relative Humidity: 55 %	Air Pressure: 1010 hPa	Power: 48 VDC
Remarks:			

Plot 7.1.7 Peak spectral power density at low frequency

CHANNEL SPACING:
ANTENNA CHAIN:
Modulation: QPSK

10 MHz
3
Modulation: 16QAM

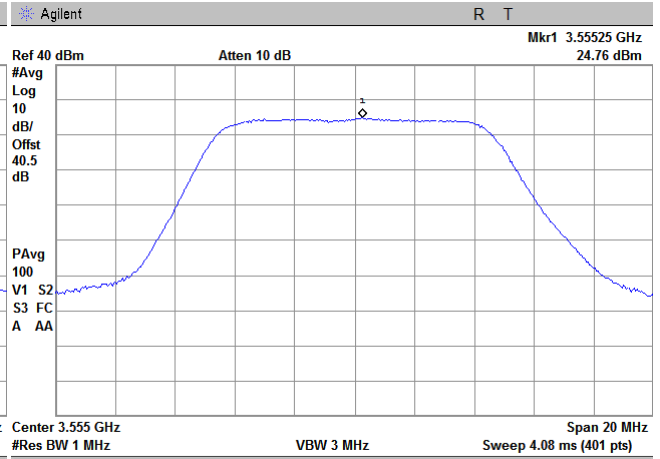
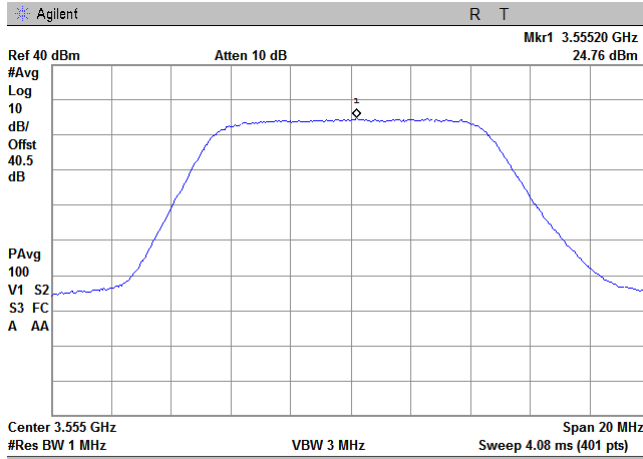

Modulation: 64QAM

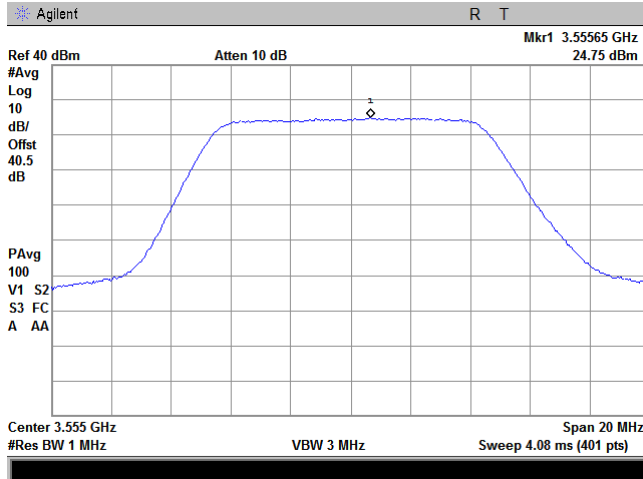



HERMON LABORATORIES

Test specification: Section 96.41(b), Maximum EIRP and maximum power spectral density			
Test procedure: Section 96.41(e)(3)			
Test mode: Compliance		Verdict: PASS	
Date(s): 16-Dec-18 - 17-Dec-18			
Temperature: 23 °C	Relative Humidity: 55 %	Air Pressure: 1010 hPa	Power: 48 VDC
Remarks:			

Plot 7.1.8 Peak spectral power density at mid frequency

CHANNEL SPACING:
ANTENNA CHAIN:
Modulation: QPSK

10 MHz
3
Modulation: 16QAM

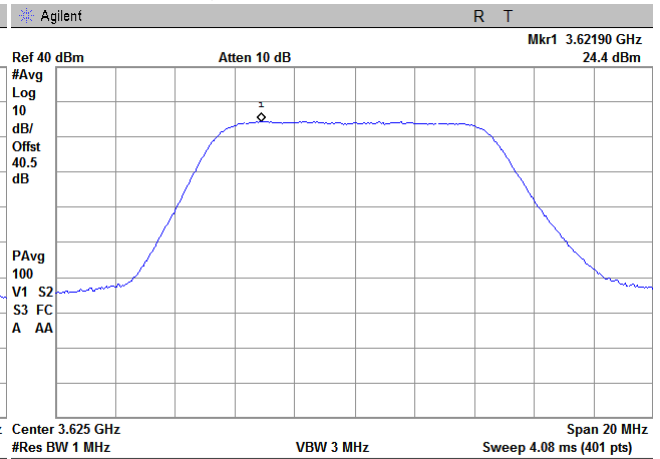
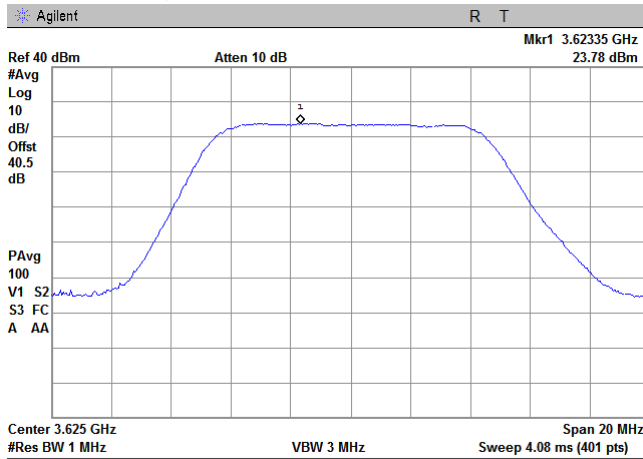

Modulation: 64QAM

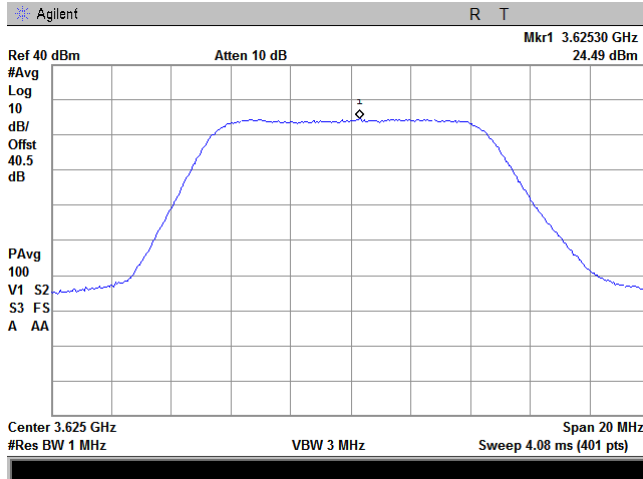



HERMON LABORATORIES

Test specification: Section 96.41(b), Maximum EIRP and maximum power spectral density			
Test procedure: Section 96.41(e)(3)			
Test mode: Compliance		Verdict: PASS	
Date(s): 16-Dec-18 - 17-Dec-18			
Temperature: 23 °C	Relative Humidity: 55 %	Air Pressure: 1010 hPa	Power: 48 VDC
Remarks:			

Plot 7.1.9 Peak spectral power density at high frequency

CHANNEL SPACING:

10 MHz

ANTENNA CHAIN:

3

Modulation: QPSK

Modulation: 16QAM

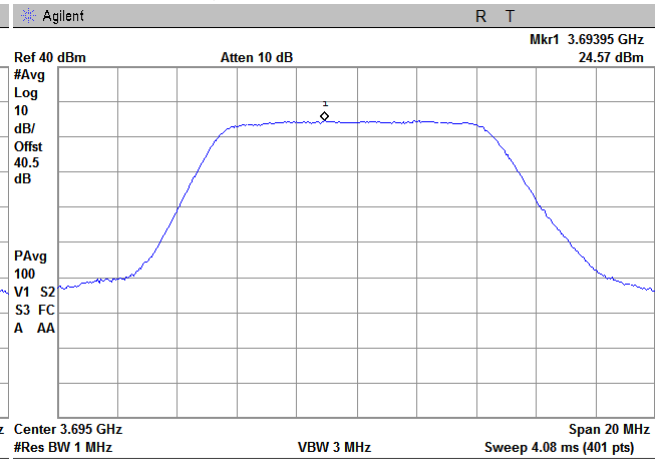
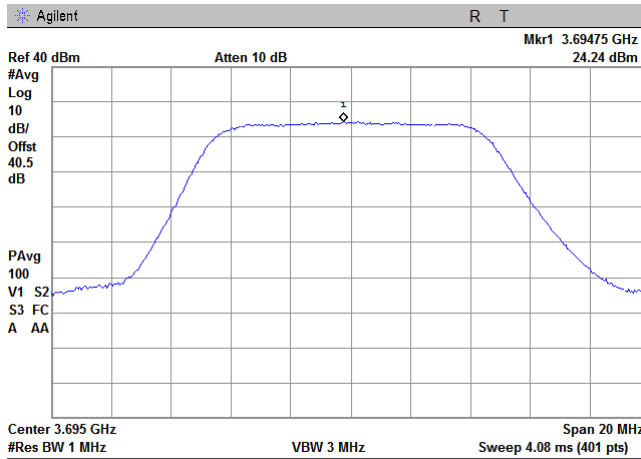

Modulation: 64QAM

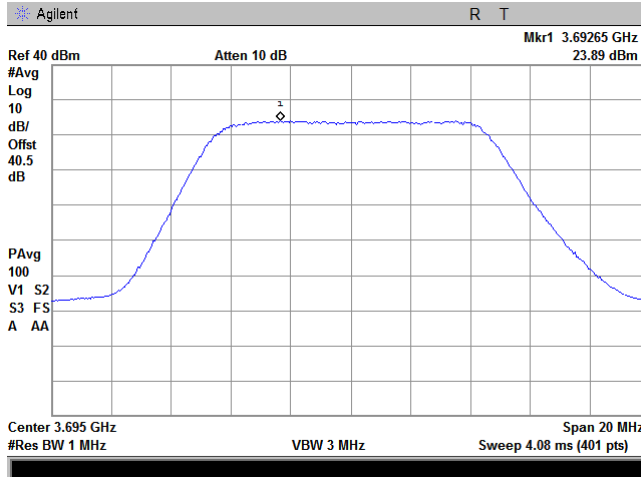



HERMON LABORATORIES

Test specification: Section 96.41(b), Maximum EIRP and maximum power spectral density			
Test procedure: Section 96.41(e)(3)			
Test mode: Compliance		Verdict: PASS	
Date(s): 16-Dec-18 - 17-Dec-18			
Temperature: 23 °C	Relative Humidity: 55 %	Air Pressure: 1010 hPa	Power: 48 VDC
Remarks:			

Plot 7.1.10 Peak spectral power density at low frequency

CHANNEL SPACING:
ANTENNA CHAIN:
Modulation: QPSK

10 MHz
4
Modulation: 16QAM

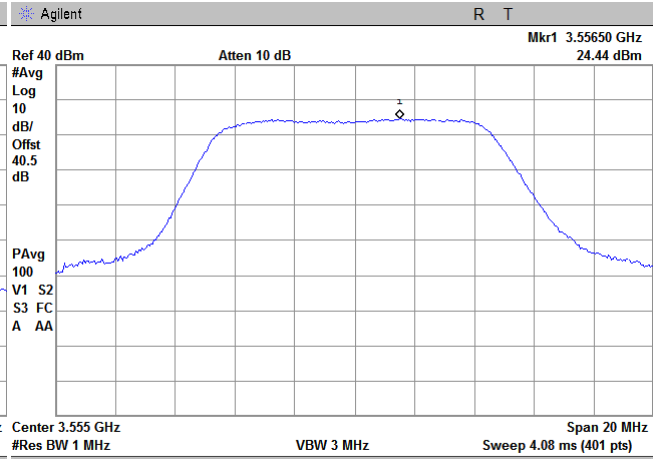
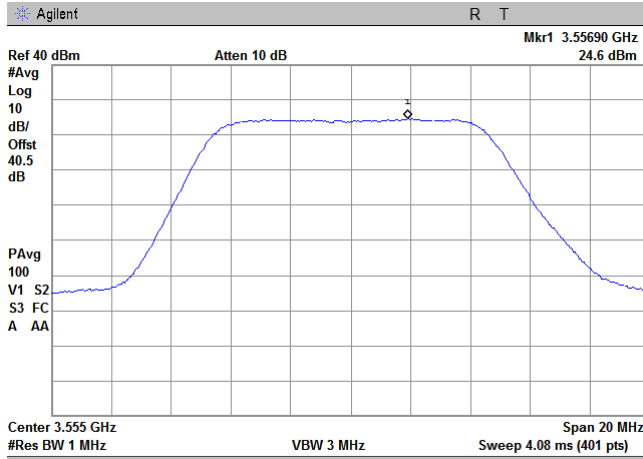

Modulation: 64QAM

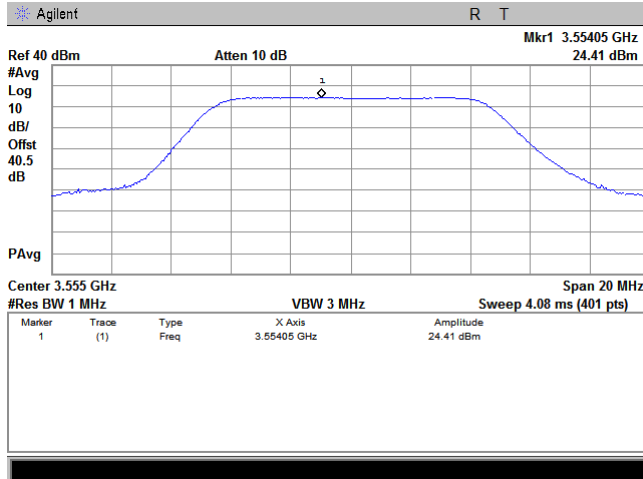



HERMON LABORATORIES

Test specification: Section 96.41(b), Maximum EIRP and maximum power spectral density			
Test procedure: Section 96.41(e)(3)			
Test mode: Compliance		Verdict: PASS	
Date(s): 16-Dec-18 - 17-Dec-18			
Temperature: 23 °C	Relative Humidity: 55 %	Air Pressure: 1010 hPa	Power: 48 VDC
Remarks:			

Plot 7.1.11 Peak spectral power density at mid frequency

CHANNEL SPACING:
ANTENNA CHAIN:
Modulation: QPSK

10 MHz
4
Modulation: 16QAM

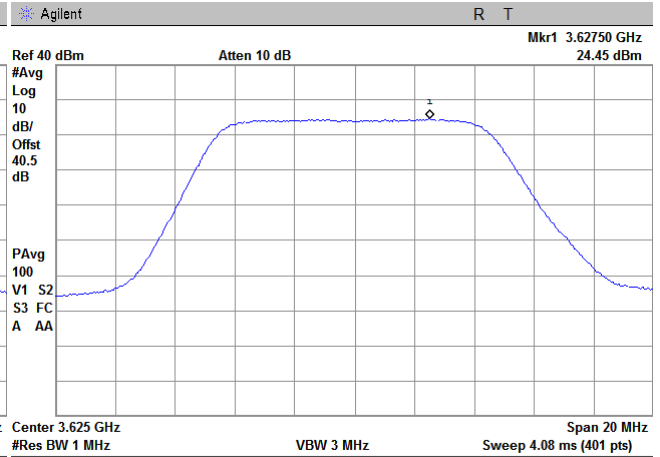
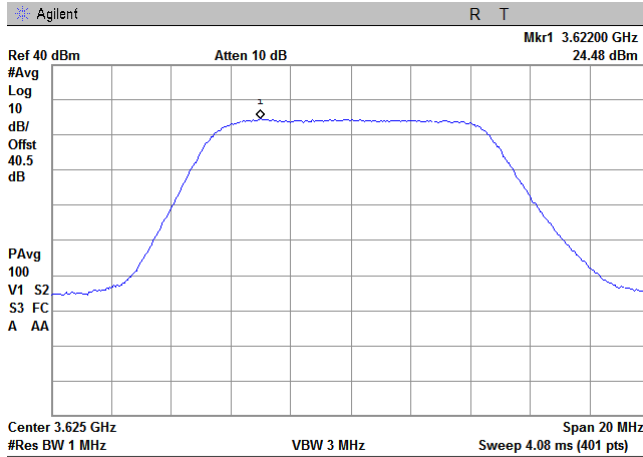

Modulation: 64QAM

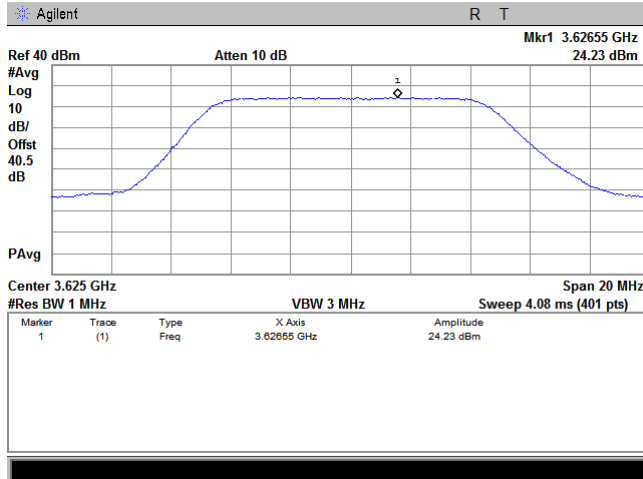



HERMON LABORATORIES

Test specification: Section 96.41(b), Maximum EIRP and maximum power spectral density			
Test procedure: Section 96.41(e)(3)			
Test mode: Compliance		Verdict: PASS	
Date(s): 16-Dec-18 - 17-Dec-18			
Temperature: 23 °C	Relative Humidity: 55 %	Air Pressure: 1010 hPa	Power: 48 VDC
Remarks:			

Plot 7.1.12 Peak spectral power density at high frequency

CHANNEL SPACING:
ANTENNA CHAIN:
Modulation: QPSK

10 MHz
4
Modulation: 16QAM

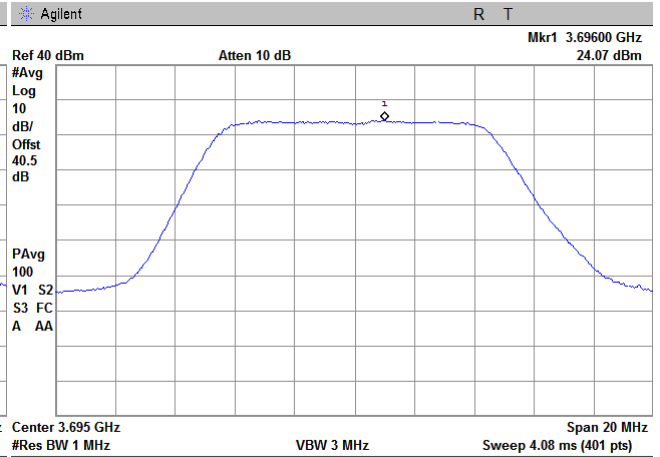
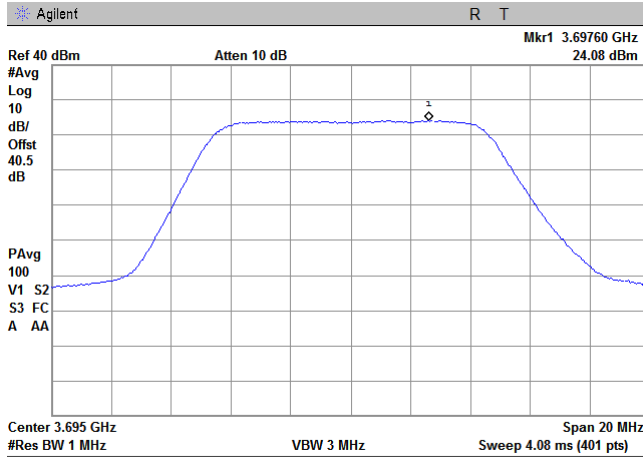

Modulation: 64QAM

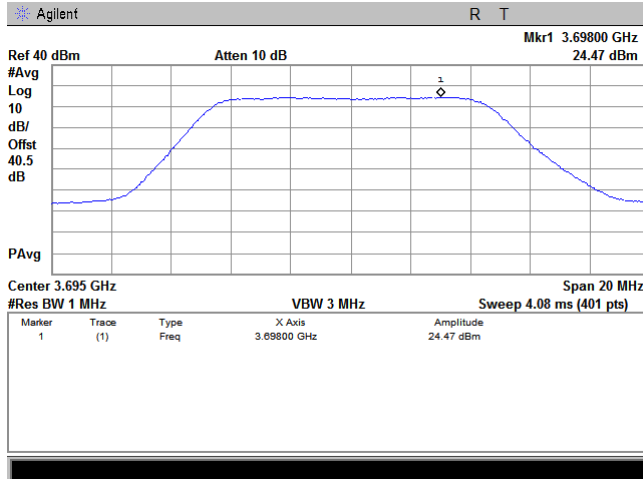



HERMON LABORATORIES

Test specification: Section 96.41(b), Maximum EIRP and maximum power spectral density			
Test procedure: Section 96.41(e)(3)			
Test mode: Compliance		Verdict: PASS	
Date(s): 16-Dec-18 - 17-Dec-18			
Temperature: 23 °C	Relative Humidity: 55 %	Air Pressure: 1010 hPa	Power: 48 VDC
Remarks:			

Plot 7.1.13 Peak spectral power density at low frequency within

CHANNEL SPACING:

20 MHz

ANTENNA CHAIN:

1

Modulation: QPSK

Modulation: 16QAM

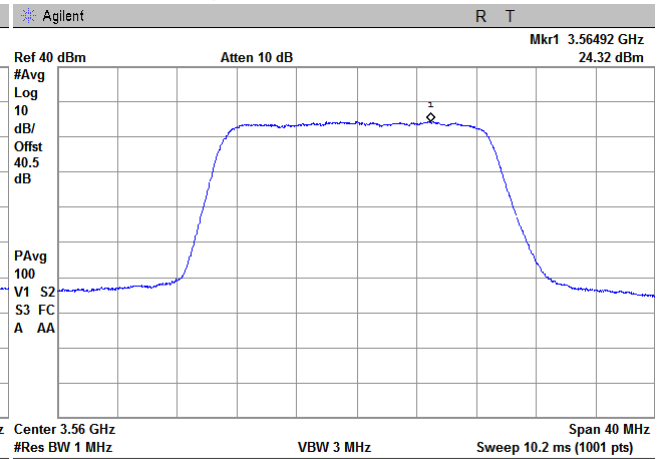
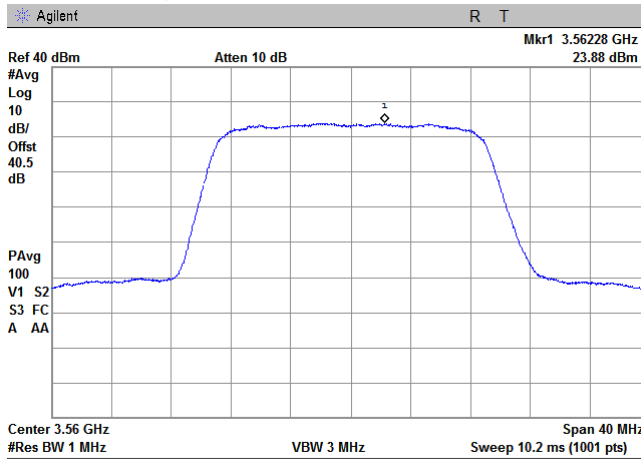

Modulation: 64QAM

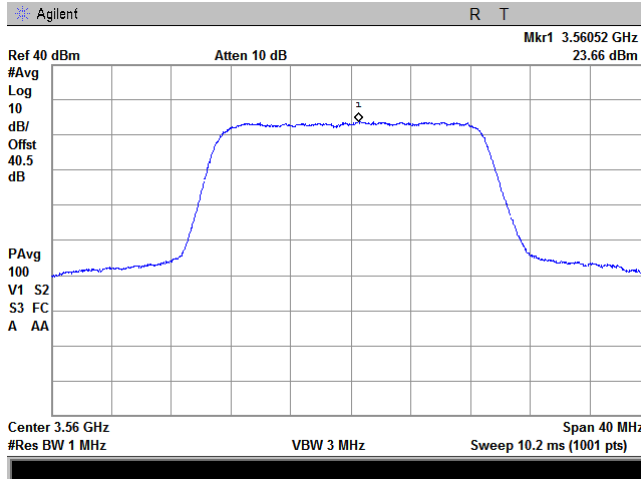



HERMON LABORATORIES

Test specification: Section 96.41(b), Maximum EIRP and maximum power spectral density			
Test procedure: Section 96.41(e)(3)			
Test mode: Compliance		Verdict: PASS	
Date(s): 16-Dec-18 - 17-Dec-18			
Temperature: 23 °C	Relative Humidity: 55 %	Air Pressure: 1010 hPa	Power: 48 VDC
Remarks:			

Plot 7.1.14 Peak spectral power density at mid frequency

MODULATION:
CHANNEL SPACING:
ANTENNA CHAIN:
Modulation: QPSK

QPSK
20 MHz
1
Modulation: 16QAM

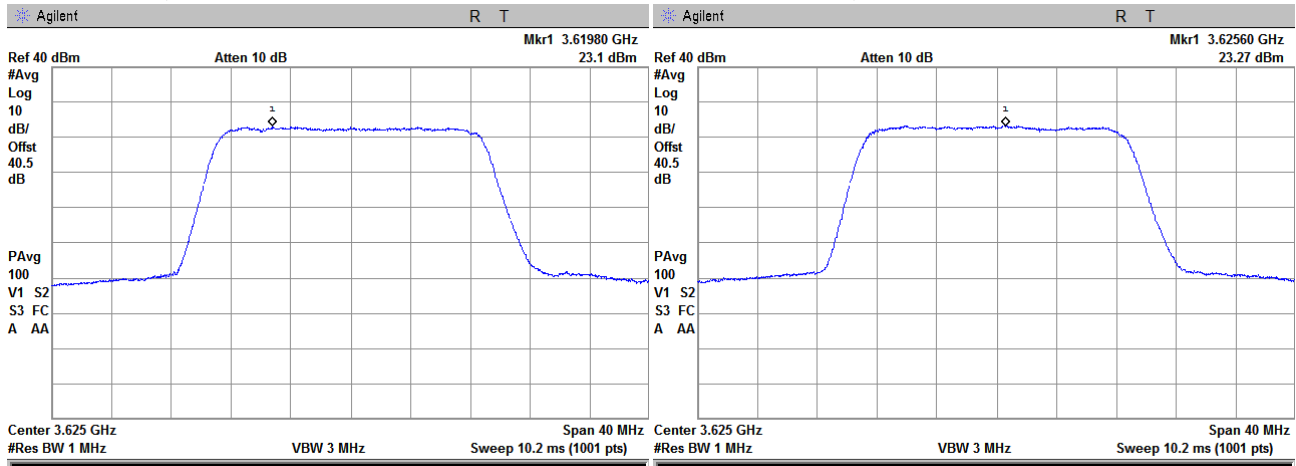

Modulation: 64QAM

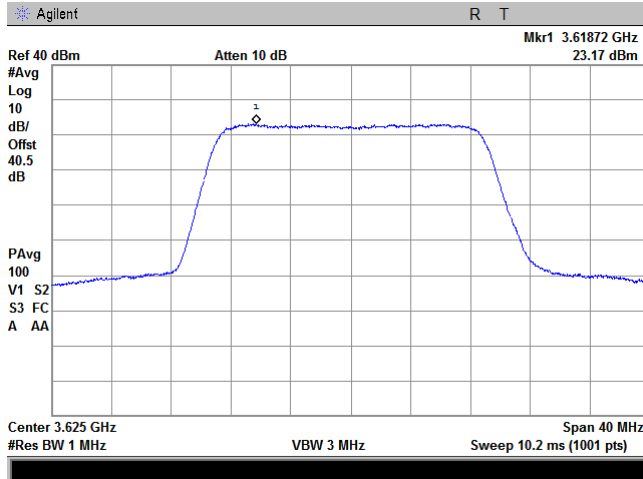



HERMON LABORATORIES

Test specification: Section 96.41(b), Maximum EIRP and maximum power spectral density			
Test procedure: Section 96.41(e)(3)			
Test mode: Compliance		Verdict: PASS	
Date(s): 16-Dec-18 - 17-Dec-18			
Temperature: 23 °C	Relative Humidity: 55 %	Air Pressure: 1010 hPa	Power: 48 VDC
Remarks:			

Plot 7.1.15 Peak spectral power density at high frequency

MODULATION:
CHANNEL SPACING:
ANTENNA CHAIN:
Modulation: QPSK

QPSK
20 MHz
1
Modulation: 16QAM

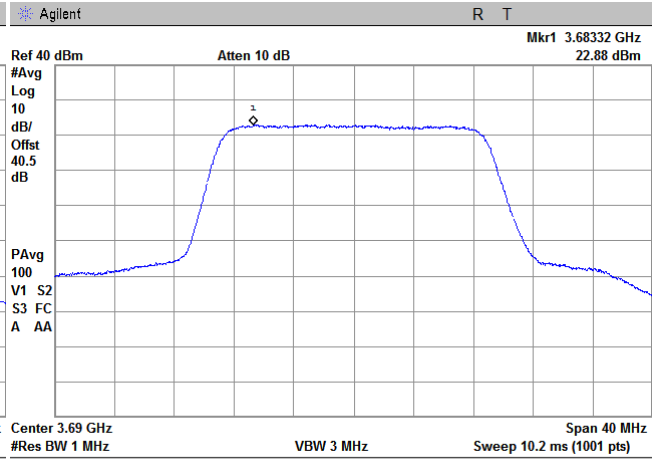
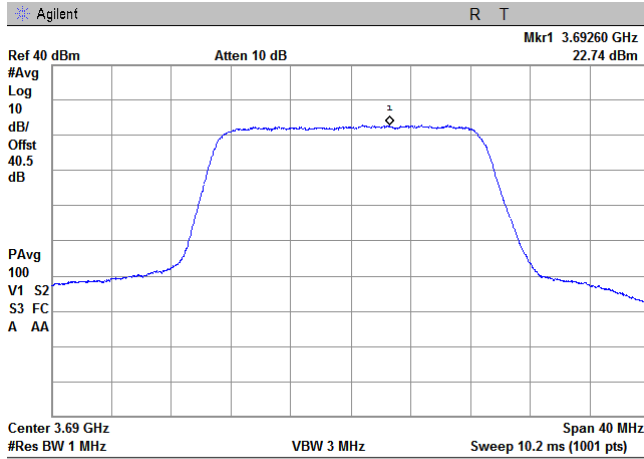

Modulation: 64QAM

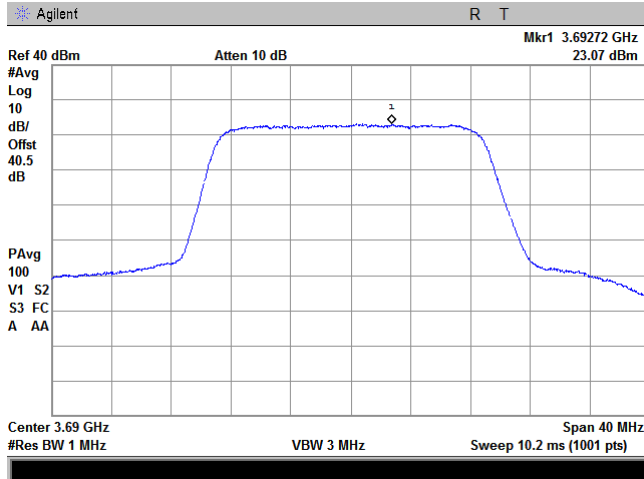



HERMON LABORATORIES

Test specification: Section 96.41(b), Maximum EIRP and maximum power spectral density			
Test procedure: Section 96.41(e)(3)			
Test mode: Compliance		Verdict: PASS	
Date(s): 16-Dec-18 - 17-Dec-18			
Temperature: 23 °C	Relative Humidity: 55 %	Air Pressure: 1010 hPa	Power: 48 VDC
Remarks:			

Plot 7.1.16 Peak spectral power density at low frequency

CHANNEL SPACING:
ANTENNA CHAIN:
Modulation: QPSK

20 MHz
2
Modulation: 16QAM

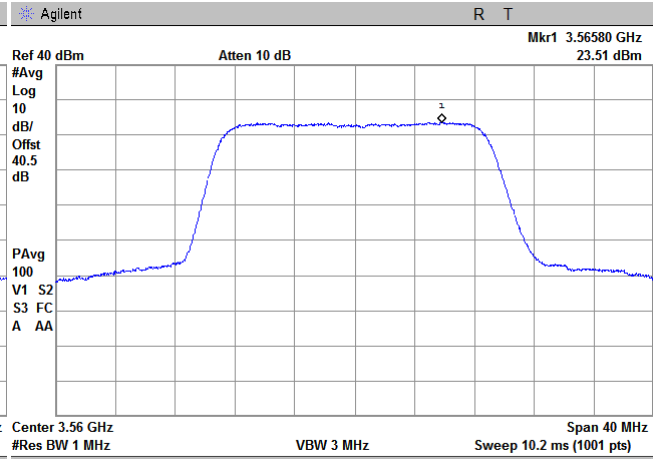
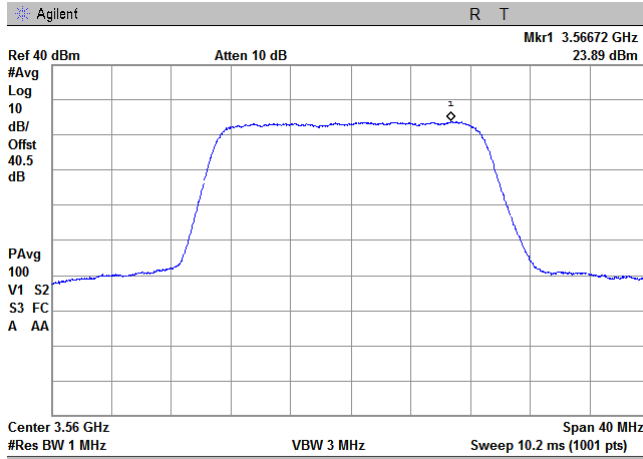

Modulation: 64QAM

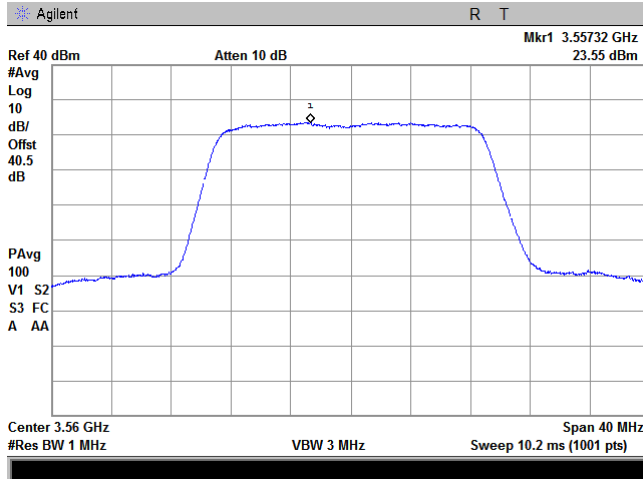



HERMON LABORATORIES

Test specification: Section 96.41(b), Maximum EIRP and maximum power spectral density			
Test procedure: Section 96.41(e)(3)			
Test mode: Compliance		Verdict: PASS	
Date(s): 16-Dec-18 - 17-Dec-18			
Temperature: 23 °C	Relative Humidity: 55 %	Air Pressure: 1010 hPa	Power: 48 VDC
Remarks:			

Plot 7.1.17 Peak spectral power density at mid frequency

CHANNEL SPACING:
ANTENNA CHAIN:
Modulation: QPSK

20 MHz
2
Modulation: 16QAM

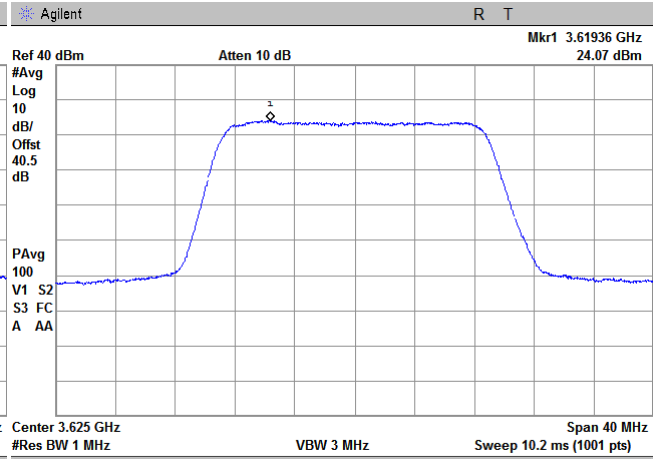
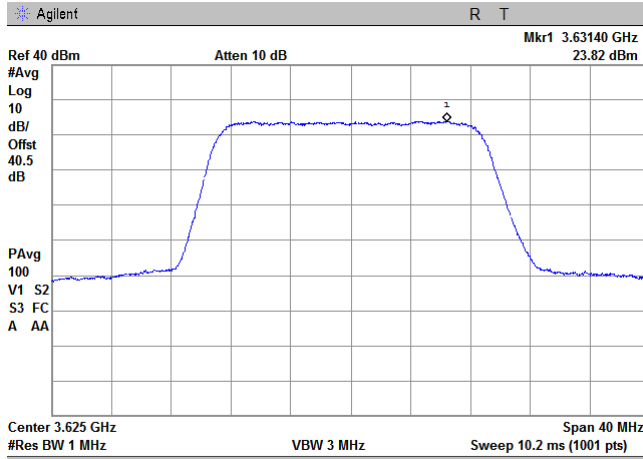

Modulation: 64QAM

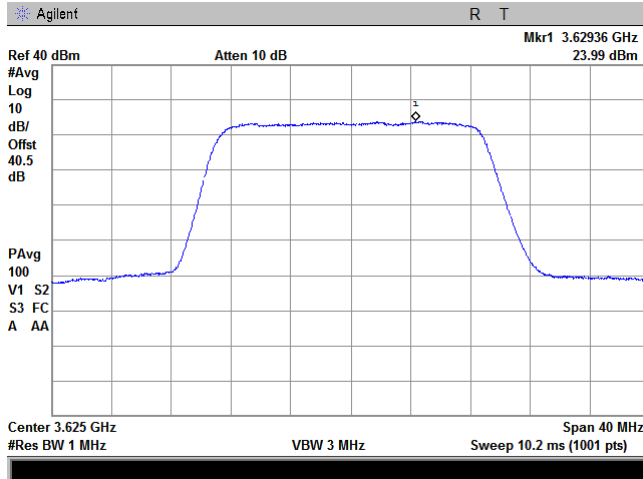



HERMON LABORATORIES

Test specification: Section 96.41(b), Maximum EIRP and maximum power spectral density			
Test procedure: Section 96.41(e)(3)			
Test mode: Compliance		Verdict: PASS	
Date(s): 16-Dec-18 - 17-Dec-18			
Temperature: 23 °C	Relative Humidity: 55 %	Air Pressure: 1010 hPa	Power: 48 VDC
Remarks:			

Plot 7.1.18 Peak spectral power density at high frequency

CHANNEL SPACING:
ANTENNA CHAIN:
Modulation: QPSK

20 MHz
2
Modulation: 16QAM

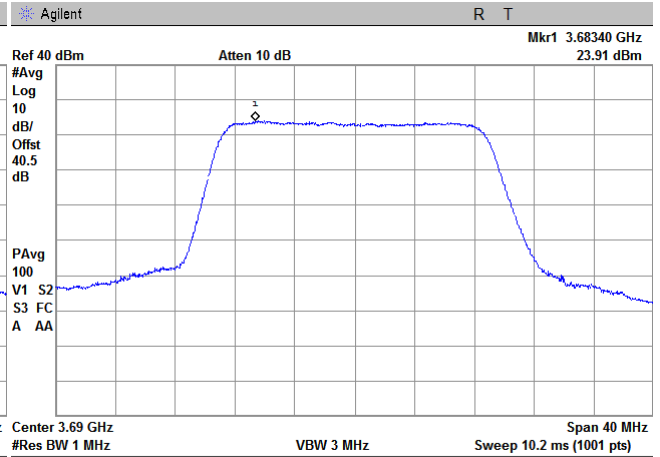
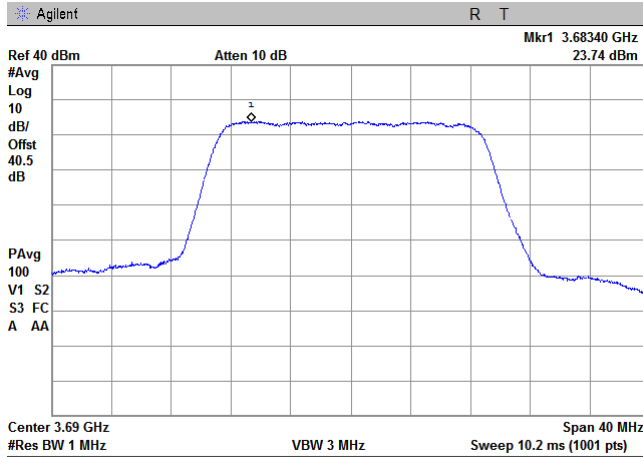

Modulation: 64QAM

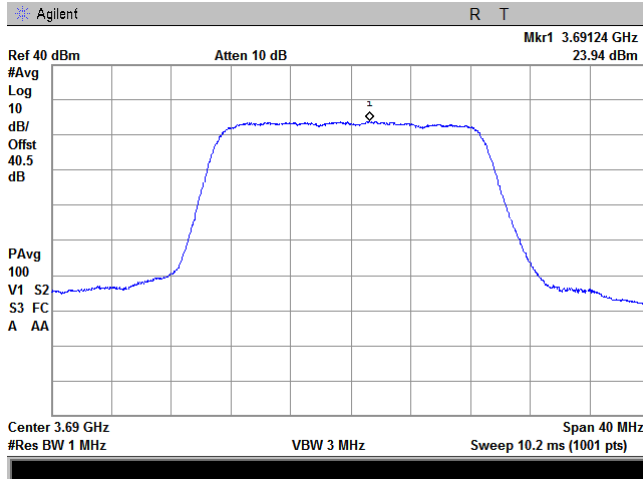



HERMON LABORATORIES

Test specification: Section 96.41(b), Maximum EIRP and maximum power spectral density			
Test procedure: Section 96.41(e)(3)			
Test mode: Compliance		Verdict: PASS	
Date(s): 16-Dec-18 - 17-Dec-18			
Temperature: 23 °C	Relative Humidity: 55 %	Air Pressure: 1010 hPa	Power: 48 VDC
Remarks:			

Plot 7.1.19 Peak spectral power density at low frequency

CHANNEL SPACING:
ANTENNA CHAIN:
Modulation: QPSK

20 MHz
3
Modulation: 16QAM

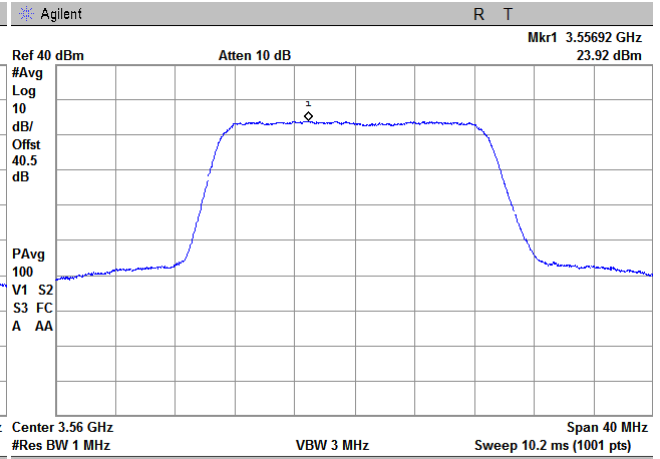
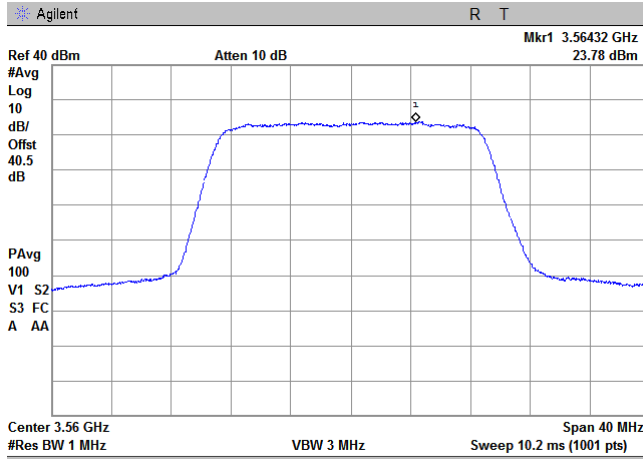

Modulation: 64QAM

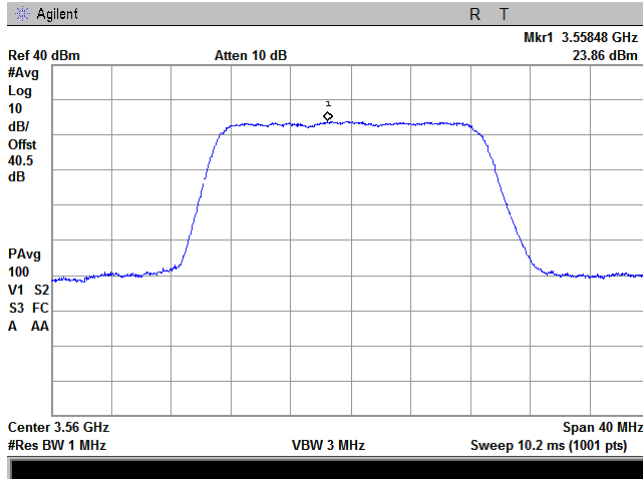



HERMON LABORATORIES

Test specification: Section 96.41(b), Maximum EIRP and maximum power spectral density			
Test procedure: Section 96.41(e)(3)			
Test mode: Compliance		Verdict: PASS	
Date(s): 16-Dec-18 - 17-Dec-18			
Temperature: 23 °C	Relative Humidity: 55 %	Air Pressure: 1010 hPa	Power: 48 VDC
Remarks:			

Plot 7.1.20 Peak spectral power density at mid frequency

CHANNEL SPACING:
ANTENNA CHAIN:
Modulation: QPSK

20 MHz
3
Modulation: 16QAM

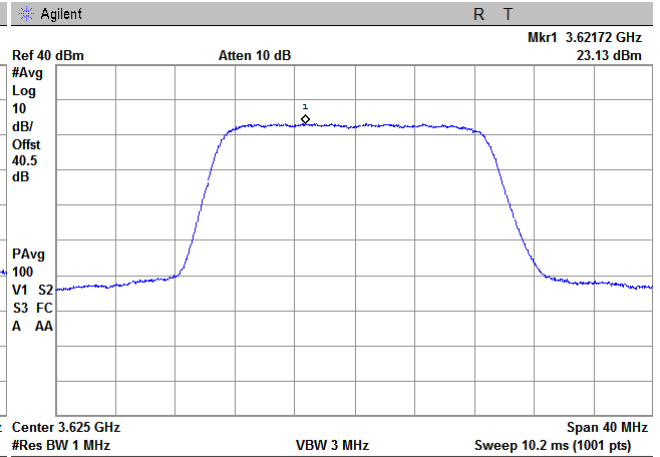
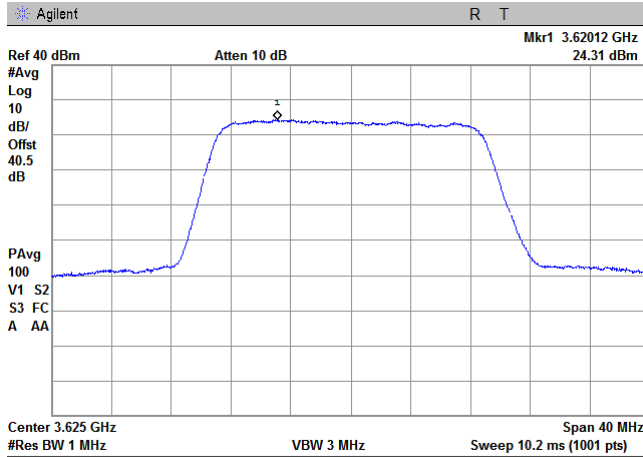

Modulation: 64QAM

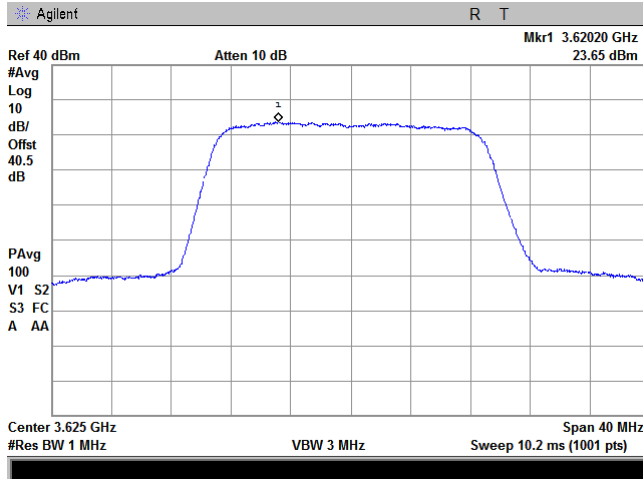



HERMON LABORATORIES

Test specification: Section 96.41(b), Maximum EIRP and maximum power spectral density			
Test procedure: Section 96.41(e)(3)			
Test mode: Compliance		Verdict: PASS	
Date(s): 16-Dec-18 - 17-Dec-18			
Temperature: 23 °C	Relative Humidity: 55 %	Air Pressure: 1010 hPa	Power: 48 VDC
Remarks:			

Plot 7.1.21 Peak spectral power density at high frequency

CHANNEL SPACING:
ANTENNA CHAIN:
Modulation: QPSK

20 MHz
3
Modulation: 16QAM

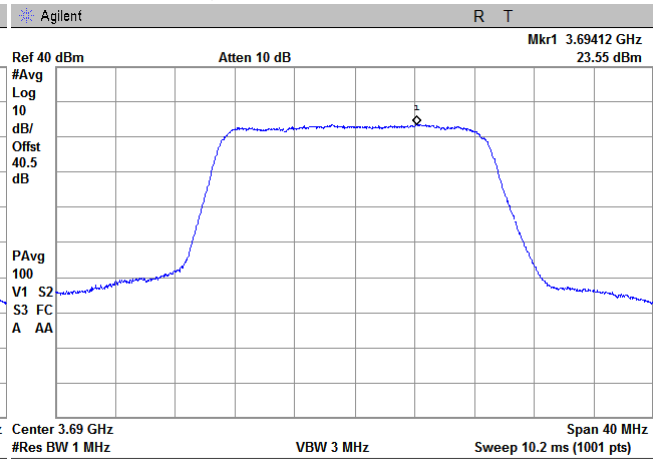
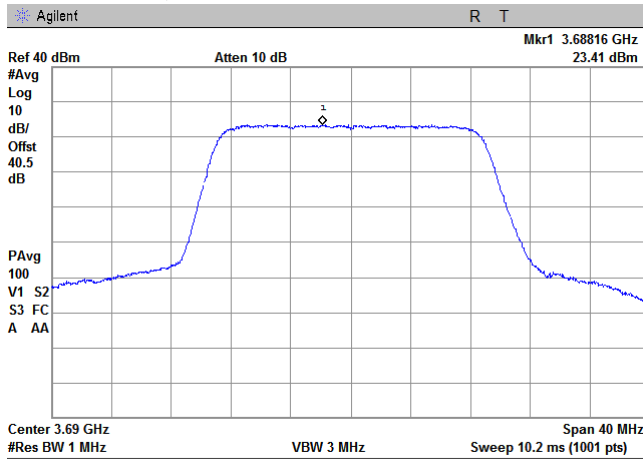

Modulation: 64QAM

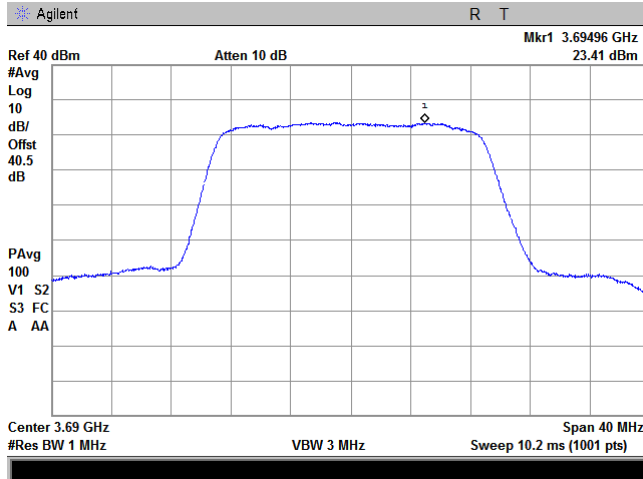



HERMON LABORATORIES

Test specification: Section 96.41(b), Maximum EIRP and maximum power spectral density			
Test procedure: Section 96.41(e)(3)			
Test mode: Compliance		Verdict: PASS	
Date(s): 16-Dec-18 - 17-Dec-18			
Temperature: 23 °C	Relative Humidity: 55 %	Air Pressure: 1010 hPa	Power: 48 VDC
Remarks:			

Plot 7.1.22 Peak spectral power density at low frequency

CHANNEL SPACING:
ANTENNA CHAIN:
Modulation: QPSK

20 MHz
4
Modulation: 16QAM

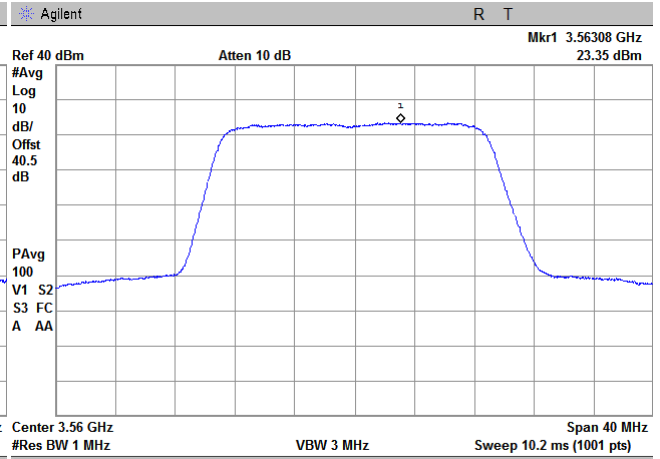
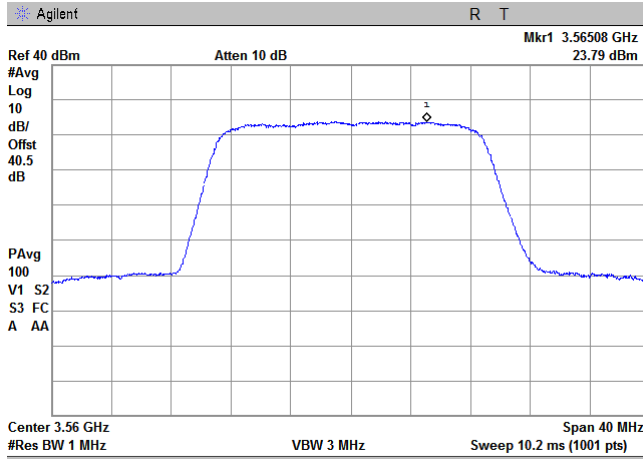

Modulation: 64QAM

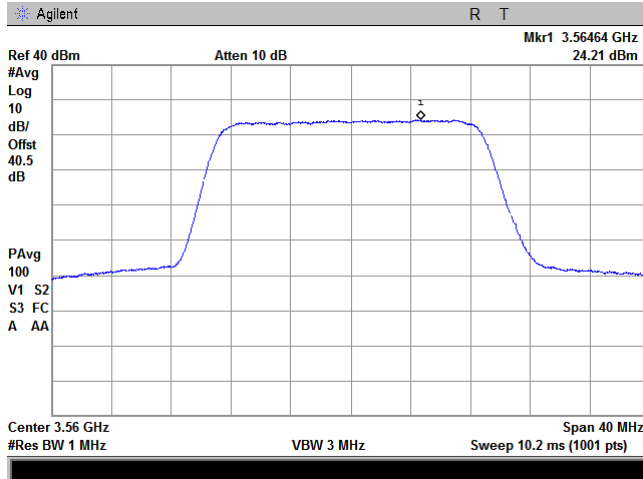



HERMON LABORATORIES

Test specification: Section 96.41(b), Maximum EIRP and maximum power spectral density			
Test procedure: Section 96.41(e)(3)			
Test mode: Compliance		Verdict: PASS	
Date(s): 16-Dec-18 - 17-Dec-18			
Temperature: 23 °C	Relative Humidity: 55 %	Air Pressure: 1010 hPa	Power: 48 VDC
Remarks:			

Plot 7.1.23 Peak spectral power density at mid frequency

CHANNEL SPACING:
ANTENNA CHAIN:
Modulation: QPSK

20 MHz
4
Modulation: 16QAM

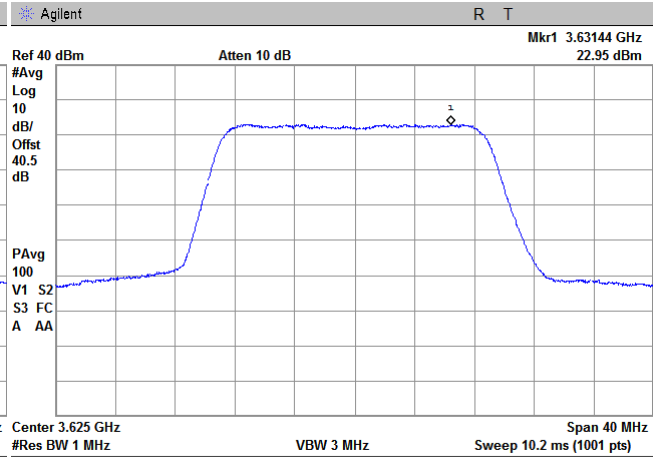
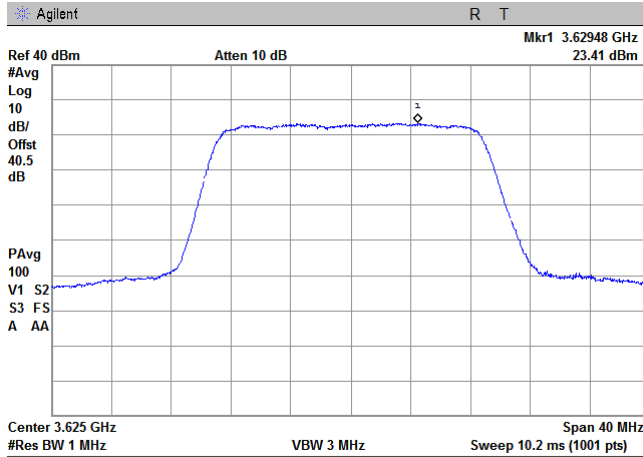

Modulation: 64QAM

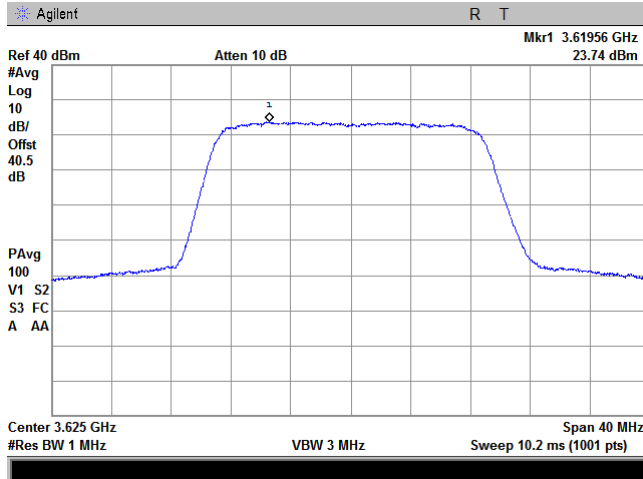



HERMON LABORATORIES

Test specification: Section 96.41(b), Maximum EIRP and maximum power spectral density			
Test procedure: Section 96.41(e)(3)			
Test mode: Compliance		Verdict: PASS	
Date(s): 16-Dec-18 - 17-Dec-18			
Temperature: 23 °C	Relative Humidity: 55 %	Air Pressure: 1010 hPa	Power: 48 VDC
Remarks:			

Plot 7.1.24 Peak spectral power density at high frequency

CHANNEL SPACING:
ANTENNA CHAIN:
Modulation: QPSK

20 MHz
4
Modulation: 16QAM

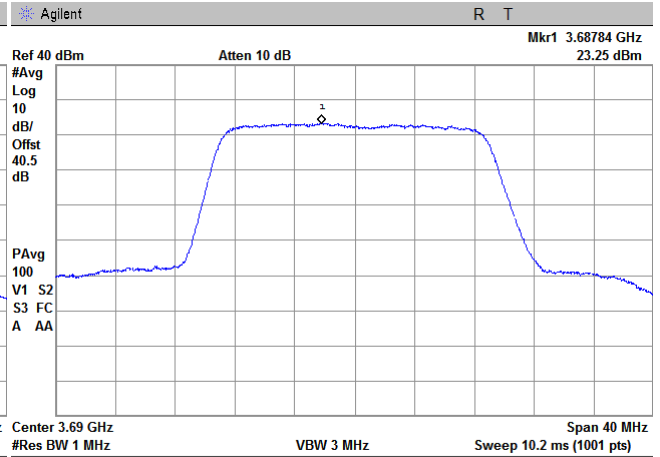
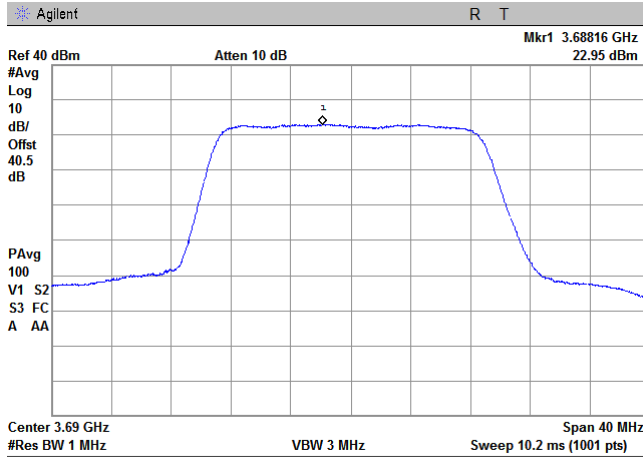

Modulation: 64QAM

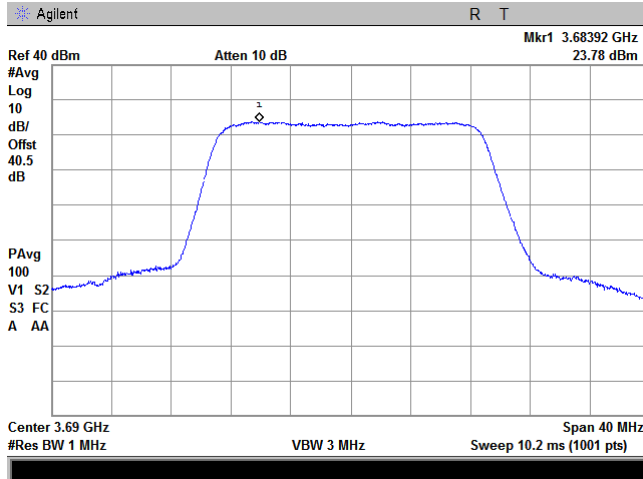



Test specification: Section 96.41(b), Maximum EIRP and maximum power spectral density			
Test procedure: Section 96.41(e)(3)			
Test mode: Compliance		Verdict: PASS	
Date(s): 16-Dec-18 - 17-Dec-18			
Temperature: 23 °C	Relative Humidity: 55 %	Air Pressure: 1010 hPa	Power: 48 VDC
Remarks:			

Plot 7.1.25 Transmission pulse duration and pulse period

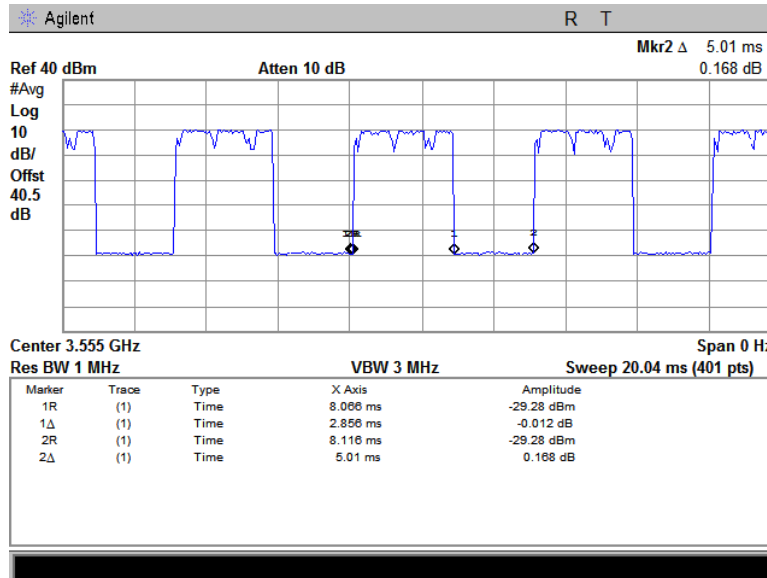

Duty cycle factor = $10 \cdot \log(2.856/5.01) = -2.44 \text{ dB}$



Test specification: Section 96.41(g), Peak-to- average power ratio			
Test procedure: Section 96.41(g)			
Test mode: Compliance		Verdict: PASS	
Date(s): 23-Dec-18			
Temperature: 24.3 °C	Relative Humidity: 48 %	Air Pressure: 1010 hPa	Power: 48 VDC
Remarks:			

7.2 Peak-to-average power ratio (PAPR) test

7.2.1 General

This test was performed to measure the peak to average power ratio at RF antenna connector. Specification test limits are given in Table 7.2.1.

Table 7.2.1 Peak-to-average power ratio limits

Assigned frequency range, MHz	Peak to average power ratio limit	
	Probability, %	dB
3550.0 – 3700.0	0.1	13.0

7.2.2 Test procedure

7.2.2.1 The EUT was set up as shown in Figure 7.2.1, energized and its proper operation was checked.

7.2.2.2 The EUT was adjusted to produce maximum available to the end user RF output power.

7.2.2.3 The peak to average power ratio was measured with power meter as provided in Table 7.2.2 and associated plots.

Figure 7.2.1 Peak-to-average power test setup

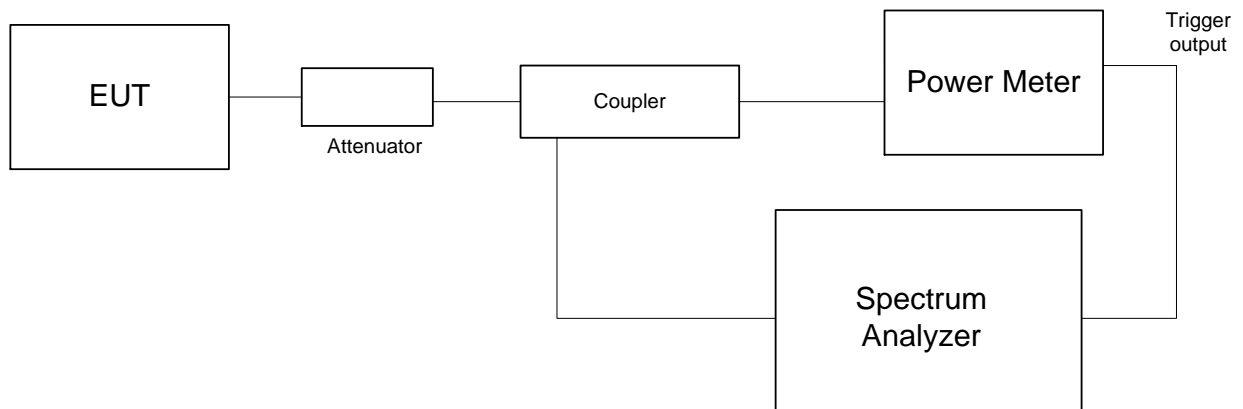



Test specification: Section 96.41(g), Peak-to- average power ratio			
Test procedure: Section 96.41(g)			
Test mode: Compliance		Verdict: PASS	
Date(s): 23-Dec-18			
Temperature: 24.3 °C	Relative Humidity: 48 %	Air Pressure: 1010 hPa	Power: 48 VDC
Remarks:			

Table 7.2.2 Peak-to-average power test results

OPERATING FREQUENCY RANGE: 3550 – 3700 MHz
 DETECTOR USED: Peak/Average
 MODULATING SIGNAL: PRBS
 TRANSMITTER OUTPUT POWER SETTINGS: Maximum

Carrier frequency, MHz	Peak to average ratio, dB	Limit, dBm	Margin, dB	Verdict
Channel Spacing 10 MHz				
Modulation QPSK				
3555.0	7.83	13.0	-5.17	Pass
3625.0	7.80	13.0	-5.20	Pass
3695.0	7.77	13.0	-5.23	Pass
Modulation 16QAM				
3555.0	7.88	13.0	-5.12	Pass
3625.0	7.86	13.0	-5.14	Pass
3695.0	7.86	13.0	-5.14	Pass
Modulation 64QAM				
3555.0	7.80	13.0	-5.20	Pass
3625.0	7.80	13.0	-5.20	Pass
3695.0	7.77	13.0	-5.23	Pass
Channel Spacing 20 MHz				
Modulation QPSK				
3560.0	11.40	13.0	-1.60	Pass
3625.0	11.62	13.0	-1.38	Pass
3690.0	11.22	13.0	-1.78	Pass
Modulation 16QAM				
3560.0	11.31	13.0	-1.69	Pass
3625.0	11.51	13.0	-1.49	Pass
3690.0	11.55	13.0	-1.45	Pass
Modulation 64QAM				
3560.0	11.43	13.0	-1.57	Pass
3625.0	11.71	13.0	-1.29	Pass
3690.0	11.50	13.0	-1.50	Pass

Note: Offset 42.93 dB included: coupling loss 10 dB, attenuator 30 dB, cables loss 2.93 dB

Reference numbers of test equipment used

HL 3301	HL 3302	HL 3434	HL 4355	
---------	---------	---------	---------	--

Full description is given in Appendix A.



HERMON LABORATORIES

Test specification: Section 96.41(g), Peak-to- average power ratio			
Test procedure: Section 96.41(g)			
Test mode: Compliance	Verdict: PASS		
Date(s): 23-Dec-18			
Temperature: 24.3 °C	Relative Humidity: 48 %	Air Pressure: 1010 hPa	Power: 48 VDC
Remarks:			

Plot 7.2.1 Peak-to-average power ratio test results at low frequency

CHANNEL SPACING:

10 MHz

ANTENNA PORT:

1

Modulation: QPSK

Modulation: 16QAM

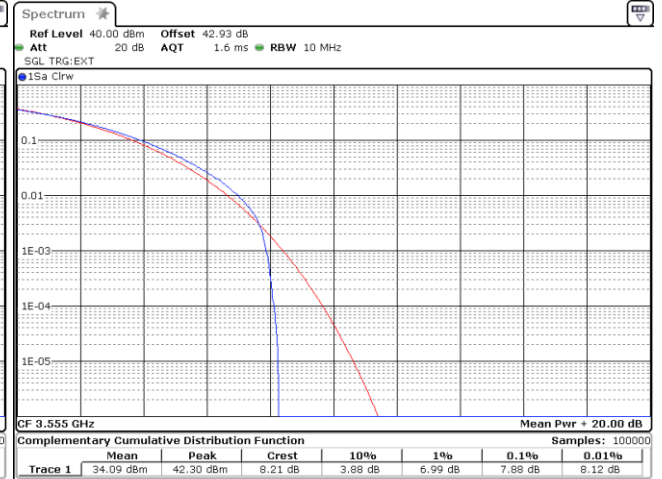
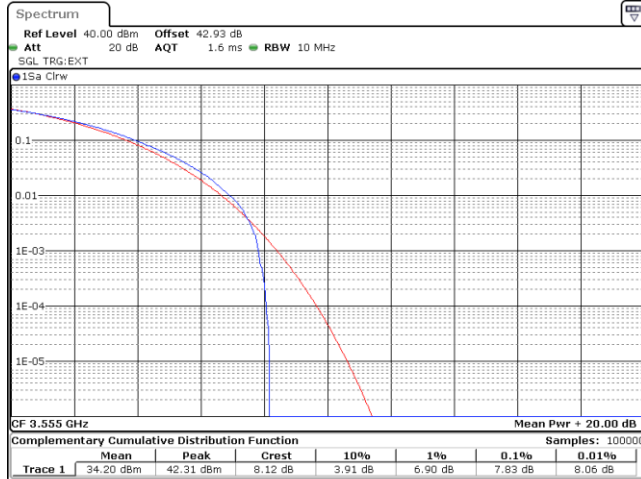

Date: 23.DEC.2018 10:23:01

Date: 1.JAN.2003 01:11:05

Modulation: 64QAM

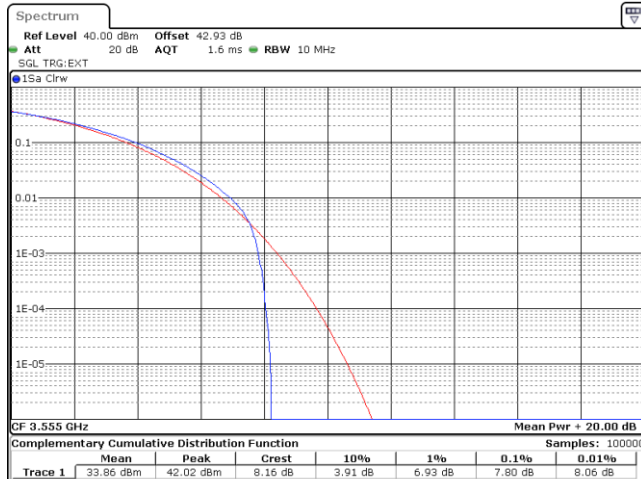

Date: 1.JAN.2003 00:59:17



HERMON LABORATORIES

Test specification: Section 96.41(g), Peak-to-average power ratio			
Test procedure: Section 96.41(g)			
Test mode: Compliance	Verdict: PASS		
Date(s): 23-Dec-18			
Temperature: 24.3 °C	Relative Humidity: 48 %	Air Pressure: 1010 hPa	Power: 48 VDC
Remarks:			

Plot 7.2.2 Peak-to-average power ratio test results at mid frequency

CHANNEL SPACING:
ANTENNA PORT:
Modulation: QPSK

10 MHz
1
Modulation: 16QAM

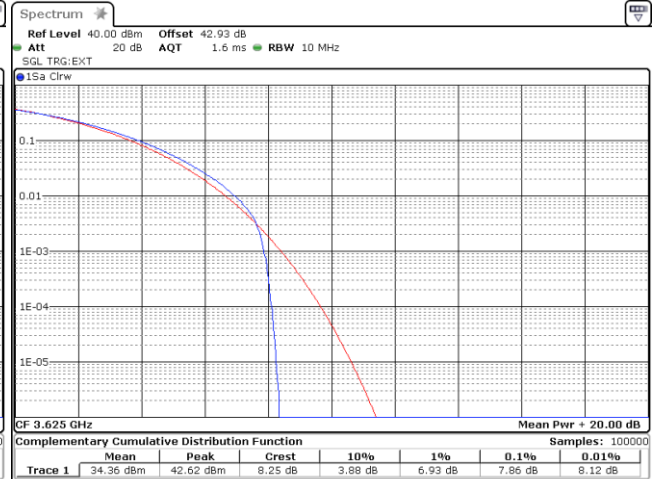
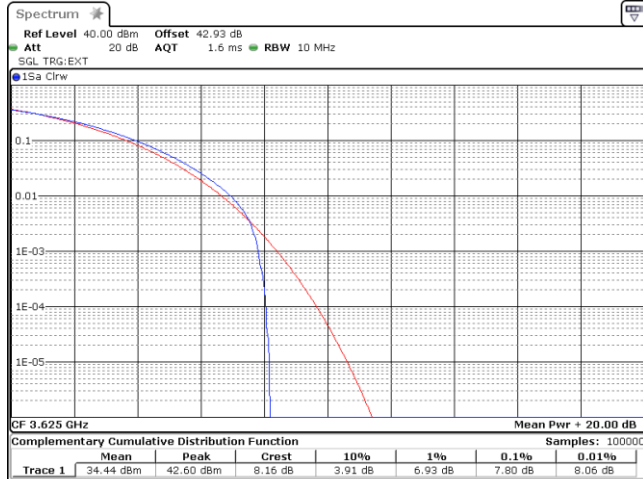

Date: 23.DEC.2018 10:23:45

Date: 1.JAN.2003 01:10:30

Modulation: 64QAM

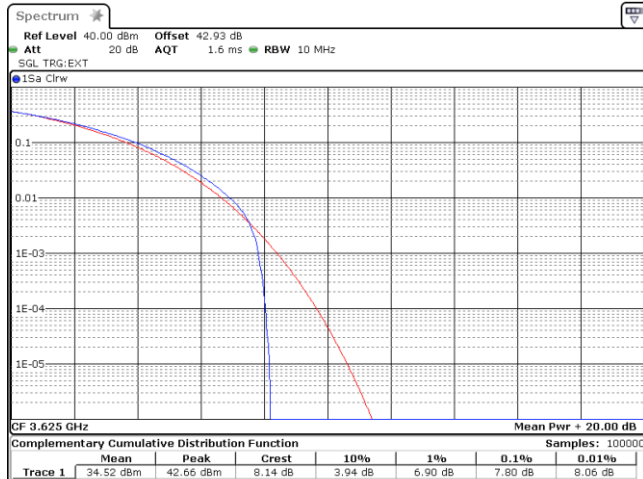

Date: 1.JAN.2003 01:01:15



HERMON LABORATORIES

Test specification: Section 96.41(g), Peak-to-average power ratio			
Test procedure: Section 96.41(g)			
Test mode: Compliance	Verdict: PASS		
Date(s): 23-Dec-18			
Temperature: 24.3 °C	Relative Humidity: 48 %	Air Pressure: 1010 hPa	Power: 48 VDC
Remarks:			

Plot 7.2.3 Peak-to-average power ratio test results at high frequency

CHANNEL SPACING:
ANTENNA PORT:
Modulation: QPSK

10 MHz
1
Modulation: 16QAM

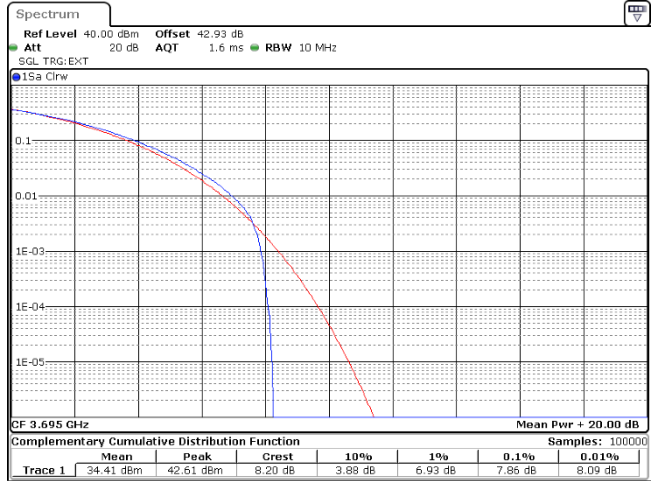
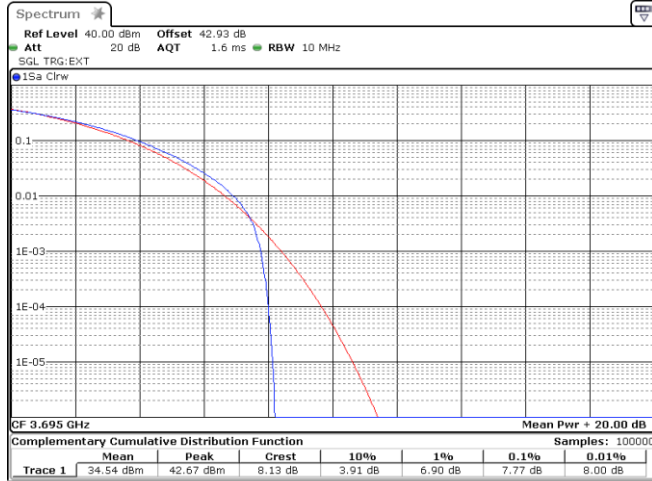

Modulation: 64QAM





HERMON LABORATORIES

Test specification: Section 96.41(g), Peak-to- average power ratio	
Test procedure: Section 96.41(g)	
Test mode: Compliance	Verdict: PASS
Date(s): 23-Dec-18	
Temperature: 24.3 °C	Relative Humidity: 48 %
Air Pressure: 1010 hPa	Power: 48 VDC
Remarks:	

Plot 7.2.4 Peak-to-average power ratio test results at low frequency

CHANNEL SPACING:
ANTENNA PORT:
Modulation: QPSK

20 MHz
1
Modulation: 16QAM

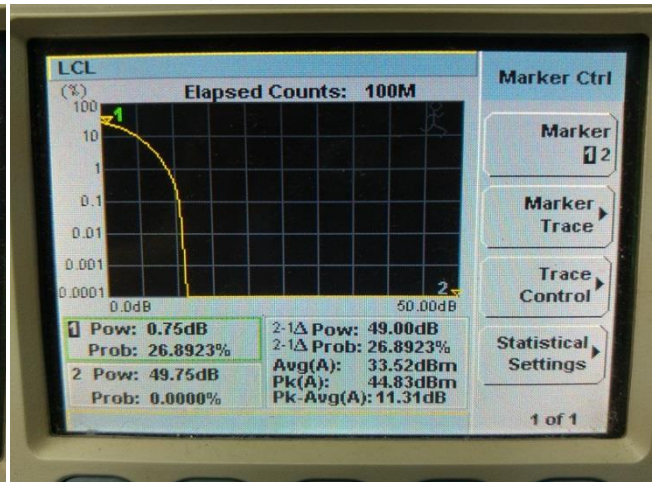
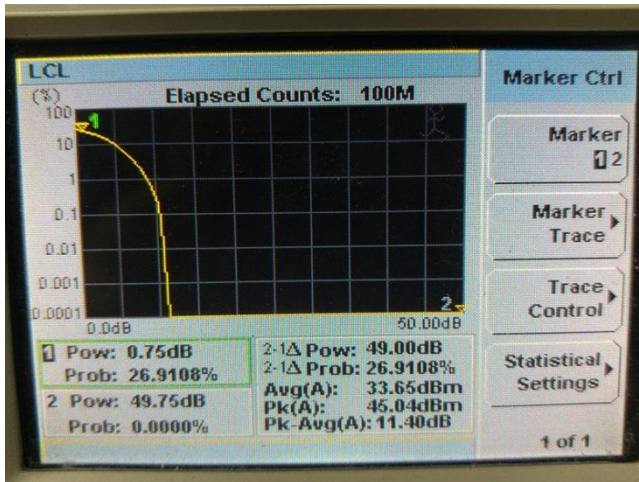

Modulation: 64QAM

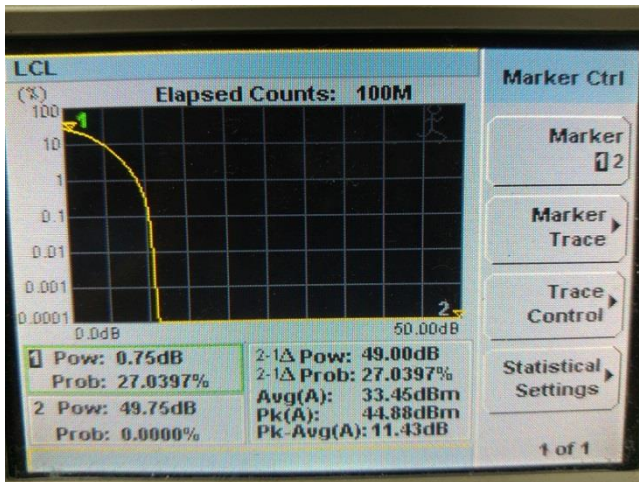



HERMON LABORATORIES

Test specification: Section 96.41(g), Peak-to- average power ratio	
Test procedure: Section 96.41(g)	
Test mode: Compliance	Verdict: PASS
Date(s): 23-Dec-18	
Temperature: 24.3 °C	Relative Humidity: 48 %
Air Pressure: 1010 hPa	Power: 48 VDC
Remarks:	

Plot 7.2.5 Peak-to-average power ratio test results at mid frequency

CHANNEL SPACING:
ANTENNA PORT:
Modulation: QPSK

20 MHz
1
Modulation: 16QAM

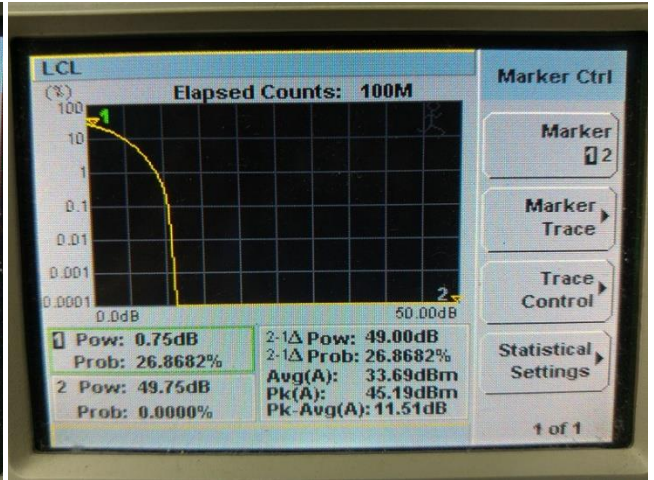
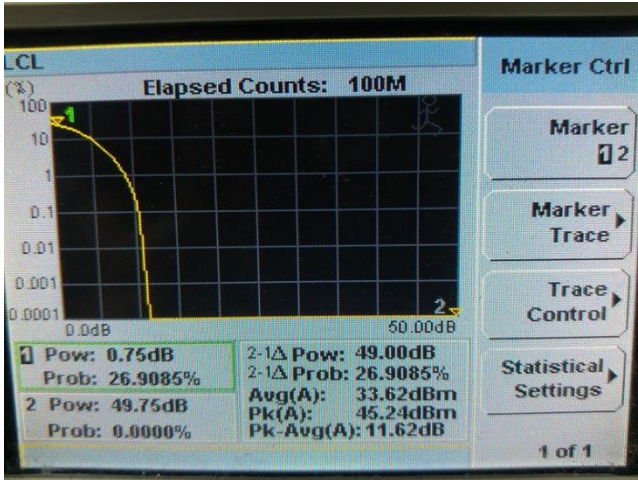

Modulation: 64QAM

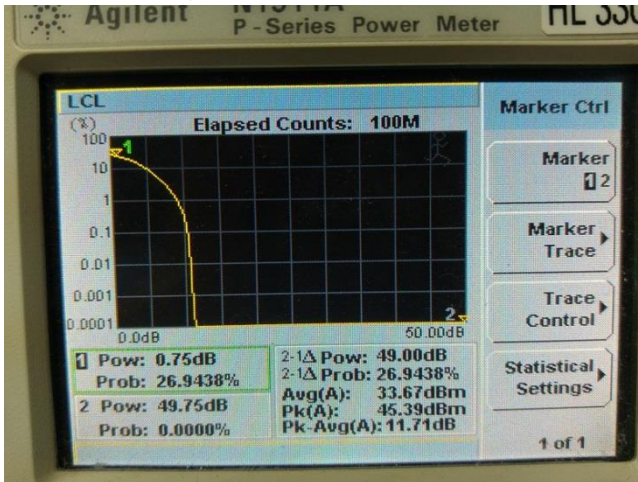



HERMON LABORATORIES

Test specification: Section 96.41(g), Peak-to- average power ratio			
Test procedure: Section 96.41(g)			
Test mode: Compliance		Verdict: PASS	
Date(s): 23-Dec-18			
Temperature: 24.3 °C	Relative Humidity: 48 %	Air Pressure: 1010 hPa	Power: 48 VDC
Remarks:			

Plot 7.2.6 Peak-to-average power ratio test results at high frequency

CHANNEL SPACING:
ANTENNA PORT:
Modulation: QPSK

20 MHz
1
Modulation: 16QAM

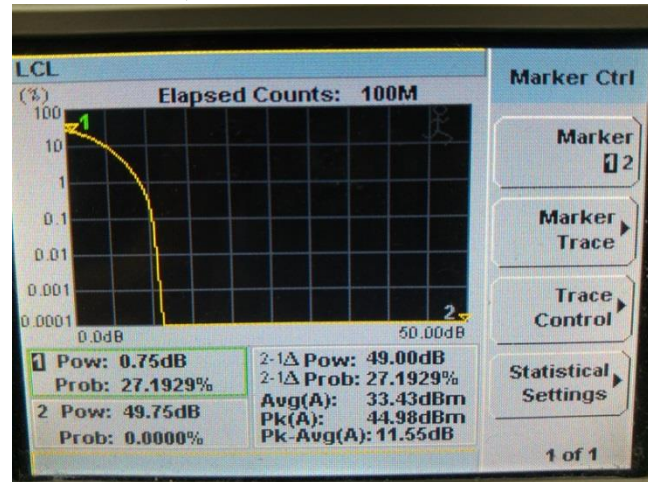
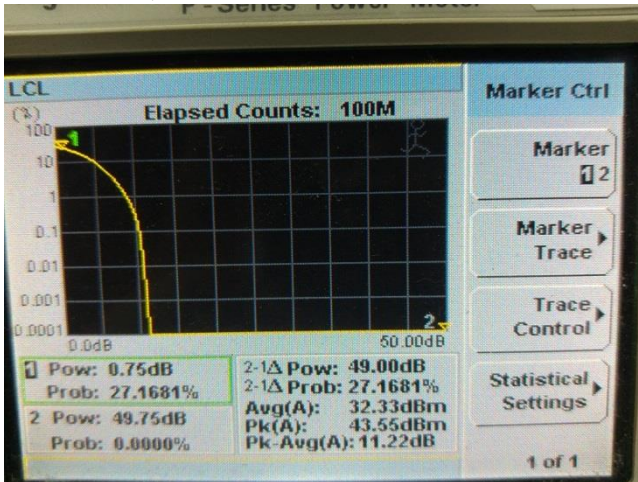

Modulation: 64QAM

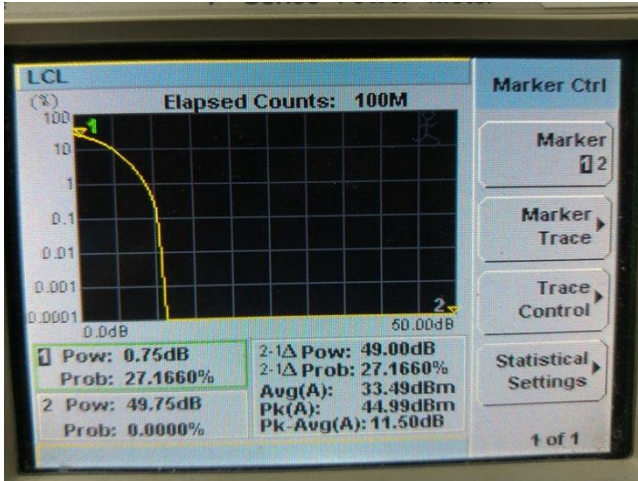



Test specification: Section 2.1049, Occupied bandwidth			
Test procedure: 47 CFR, Section 2.1049			
Test mode: Compliance		Verdict: PASS	
Date(s): 21-Dec-18			
Temperature: 23 °C	Relative Humidity: 55 %	Air Pressure: 1008 hPa	Power: 48 VDC
Remarks:			

7.3 Occupied bandwidth test

7.3.1 General

This test was performed to measure transmitter occupied bandwidth. Specification test limits are given in Table 7.3.1.

Table 7.3.1 Occupied bandwidth limits

Assigned frequency, MHz	Modulation envelope reference points*, %	Maximum allowed bandwidth, MHz
3550-3700	99	10 / 20 MHz

* - Modulation envelope reference points are provided in terms of attenuation below the unmodulated carrier.

7.3.2 Test procedure

7.3.2.1 The EUT was set up as shown in Figure 7.3.1, energized and its proper operation was checked.

7.3.2.2 The EUT was set to transmit the unmodulated carrier and the reference peak power level was measured.

7.3.2.3 The EUT was set to transmit the normally modulated carrier.

7.3.2.4 The transmitter occupied bandwidth was measured with spectrum analyzer as a frequency delta between the reference points on modulation envelope and provided in Table 7.3.2 and the associated plots.

Figure 7.3.1 Occupied bandwidth test setup

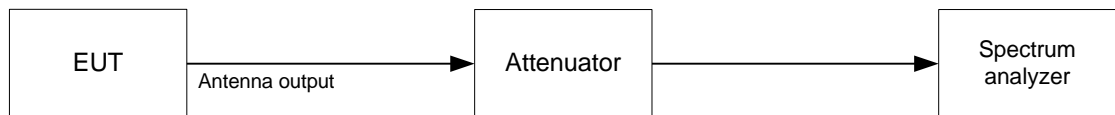



Test specification: Section2.1049, Occupied bandwidth			
Test procedure: 47 CFR, Section 2.1049			
Test mode: Compliance		Verdict: PASS	
Date(s): 21-Dec-18			
Temperature: 23 °C	Relative Humidity: 55 %	Air Pressure: 1008 hPa	Power: 48 VDC
Remarks:			

Table 7.3.2 Occupied bandwidth test results

DETECTOR USED: AVR
RESOLUTION BANDWIDTH: 300 kHz
VIDEO BANDWIDTH: 3 MHz
MODULATION ENVELOPE REFERENCE POINTS: 99%

CS=10 MHz

Modulation	Carrier frequency, MHz	Occupied bandwidth, MHz	Limit, MHz	Margin, MHz	Verdict
QPSK	3555	9.0279	10	-0.0721	Pass
	3625	9.0160	10	-0.9840	Pass
	3695	9.0066	10	-0.9934	Pass
16 QAM	3555	9.0135	10	-0.9865	Pass
	3625	9.0007	10	-0.9993	Pass
	3695	9.0040	10	-0.9960	Pass
64 QAM	3555	9.0257	10	-0.9743	Pass
	3625	9.0134	10	-0.9866	Pass
	3695	8.9717	10	-1.0283	Pass

CS=20 MHz

Modulation	Carrier frequency, MHz	Occupied bandwidth, MHz	Limit, MHz	Margin, kHz	Verdict
QPSK	3560	17.5700	20	-2.4300	Pass
	3625	17.5747	20	-2.4253	Pass
	3690	17.5779	20	-2.4221	Pass
16 QAM	3560	17.6201	20	-2.3799	Pass
	3625	17.5749	20	-2.4251	Pass
	3690	17.5821	20	-2.4179	Pass
64 QAM	3560	17.5841	20	-2.4159	Pass
	3625	17.5610	20	-2.4390	Pass
	3690	17.5826	20	-2.4174	Pass

Note: Offset 48 dB included: coupling loss 16 dB, attenuator 30 dB, cables loss 2.0 dB

Reference numbers of test equipment used

HL 3818						
---------	--	--	--	--	--	--

Full description is given in Appendix A.



Test specification: Section2.1049, Occupied bandwidth			
Test procedure: 47 CFR, Section 2.1049			
Test mode: Compliance		Verdict: PASS	
Date(s): 21-Dec-18			
Temperature: 23 °C	Relative Humidity: 55 %	Air Pressure: 1008 hPa	Power: 48 VDC
Remarks:			

Plot 7.3.1 Occupied bandwidth test result at low frequency

MODULATION: QPSK
CHANNEL SPACING: 10 MHz

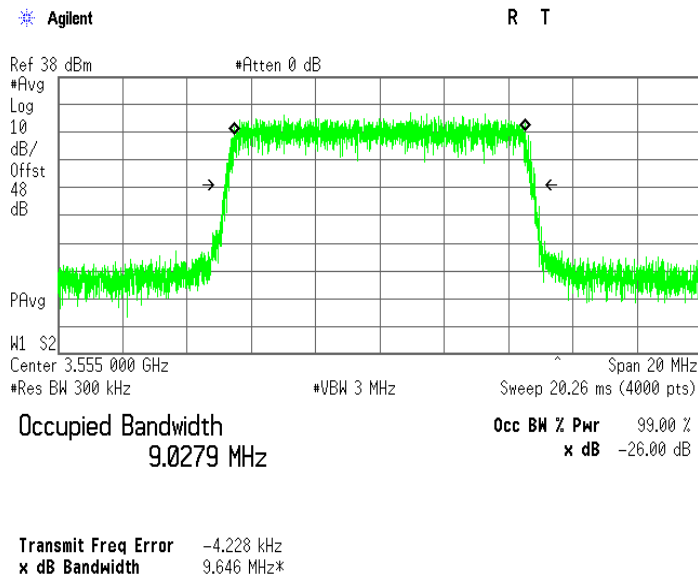

Plot 7.3.2 Occupied bandwidth test result at low frequency

MODULATION: 16QAM
CHANNEL SPACING: 10 MHz

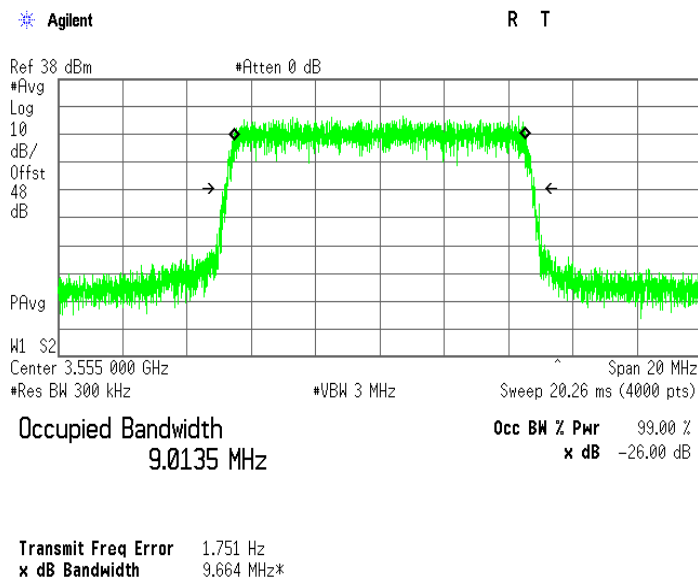



HERMON LABORATORIES

Test specification: Section 2.1049, Occupied bandwidth			
Test procedure: 47 CFR, Section 2.1049			
Test mode: Compliance		Verdict: PASS	
Date(s): 21-Dec-18			
Temperature: 23 °C	Relative Humidity: 55 %	Air Pressure: 1008 hPa	Power: 48 VDC
Remarks:			

Plot 7.3.3 Occupied bandwidth test result at low frequency

MODULATION: 64QAM
CHANNEL SPACING: 10 MHz

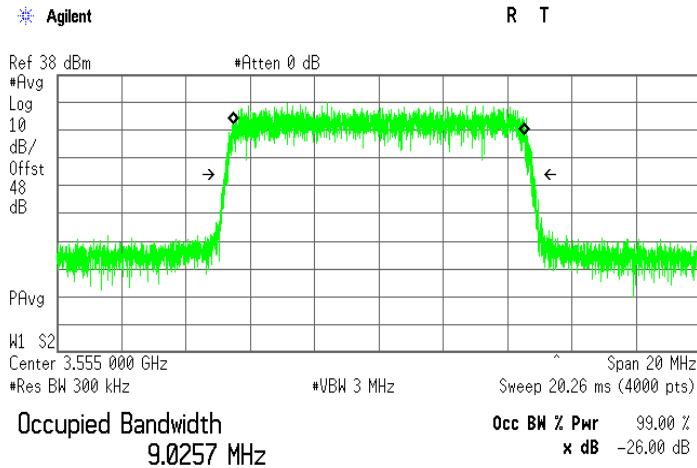

Transmit Freq Error 4.582 kHz
x dB Bandwidth 9.580 MHz*

Plot 7.3.4 Occupied bandwidth test result at mid frequency

MODULATION: QPSK
CHANNEL SPACING: 10 MHz

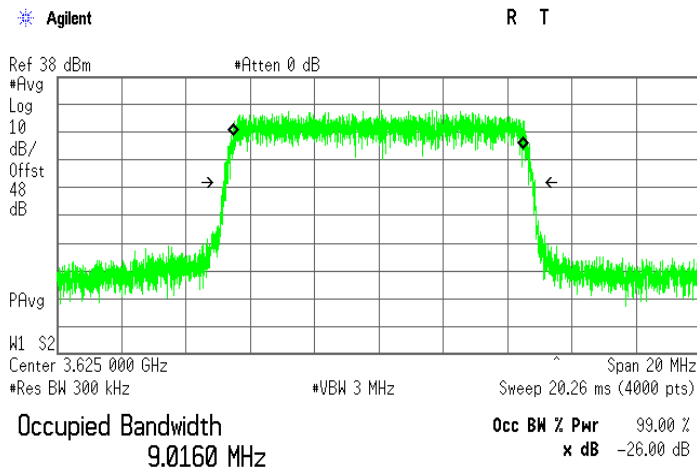

Transmit Freq Error -3.788 kHz
x dB Bandwidth 9.689 MHz*



Test specification: Section2.1049, Occupied bandwidth			
Test procedure: 47 CFR, Section 2.1049			
Test mode: Compliance	Verdict: PASS		
Date(s): 21-Dec-18			
Temperature: 23 °C	Relative Humidity: 55 %	Air Pressure: 1008 hPa	Power: 48 VDC
Remarks:			

Plot 7.3.5 Occupied bandwidth test result at mid frequency

MODULATION: 16QAM
CHANNEL SPACING: 10 MHz

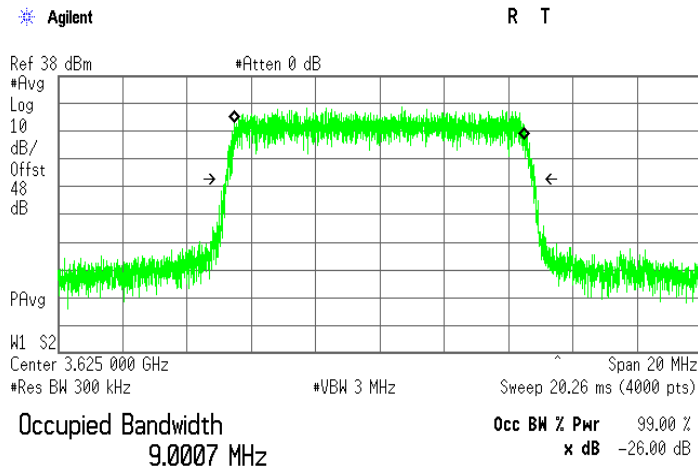

Transmit Freq Error -11.631 kHz
x dB Bandwidth 9.604 MHz*

Plot 7.3.6 Occupied bandwidth test result at mid frequency

MODULATION: 64QAM
CHANNEL SPACING: 10 MHz

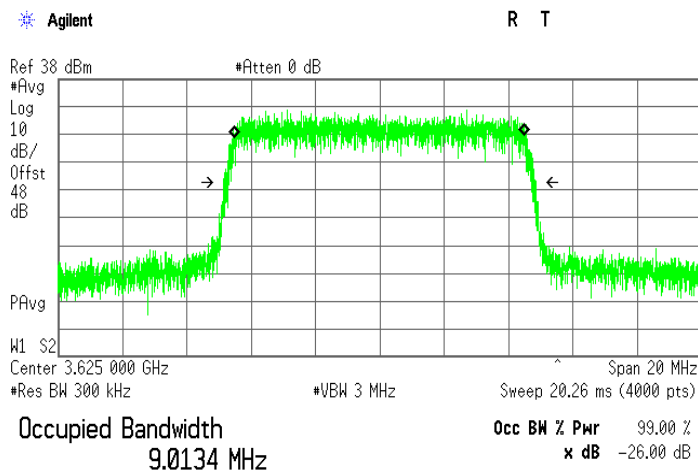

Transmit Freq Error -1.171 kHz
x dB Bandwidth 9.709 MHz*



HERMON LABORATORIES

Test specification: Section 2.1049, Occupied bandwidth			
Test procedure: 47 CFR, Section 2.1049			
Test mode: Compliance		Verdict: PASS	
Date(s): 21-Dec-18			
Temperature: 23 °C	Relative Humidity: 55 %	Air Pressure: 1008 hPa	Power: 48 VDC
Remarks:			

Plot 7.3.7 Occupied bandwidth test result at high frequency

MODULATION: QPSK
CHANNEL SPACING: 10 MHz

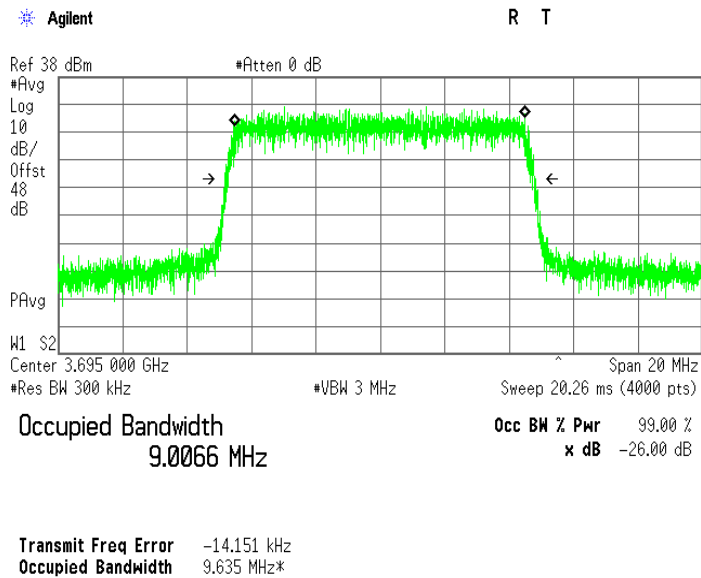

Plot 7.3.8 Occupied bandwidth test result at high frequency

MODULATION: 16QAM
CHANNEL SPACING: 10 MHz

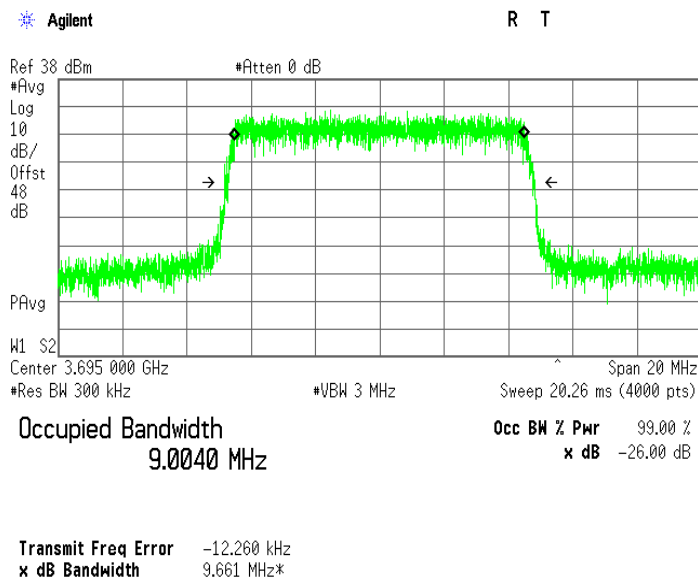



HERMON LABORATORIES

Test specification: Section 2.1049, Occupied bandwidth			
Test procedure: 47 CFR, Section 2.1049			
Test mode: Compliance		Verdict: PASS	
Date(s): 21-Dec-18			
Temperature: 23 °C	Relative Humidity: 55 %	Air Pressure: 1008 hPa	Power: 48 VDC
Remarks:			

Plot 7.3.9 Occupied bandwidth test result at high frequency

MODULATION: 64QAM
CHANNEL SPACING: 10 MHz
Agilent R T

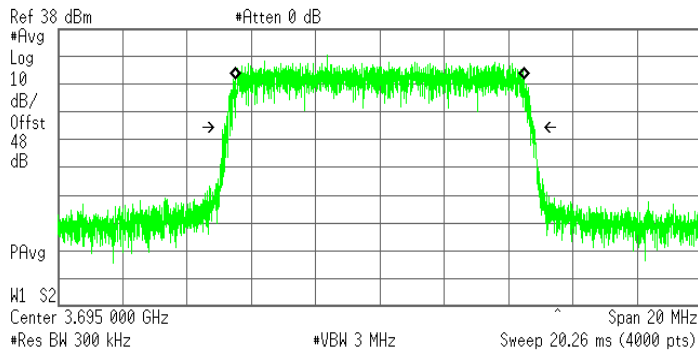

Occupied Bandwidth 8.9717 MHz
Occ BW % Pwr 99.00 %
x dB -26.00 dB

Transmit Freq Error -5.855 kHz
x dB Bandwidth 9.619 MHz*



HERMON LABORATORIES

Test specification: Section2.1049, Occupied bandwidth			
Test procedure: 47 CFR, Section 2.1049			
Test mode: Compliance		Verdict: PASS	
Date(s): 21-Dec-18			
Temperature: 23 °C	Relative Humidity: 55 %	Air Pressure: 1008 hPa	Power: 48 VDC
Remarks:			

Plot 7.3.10 Occupied bandwidth test result at low frequency

MODULATION: QPSK
CHANNEL SPACING: 20 MHz

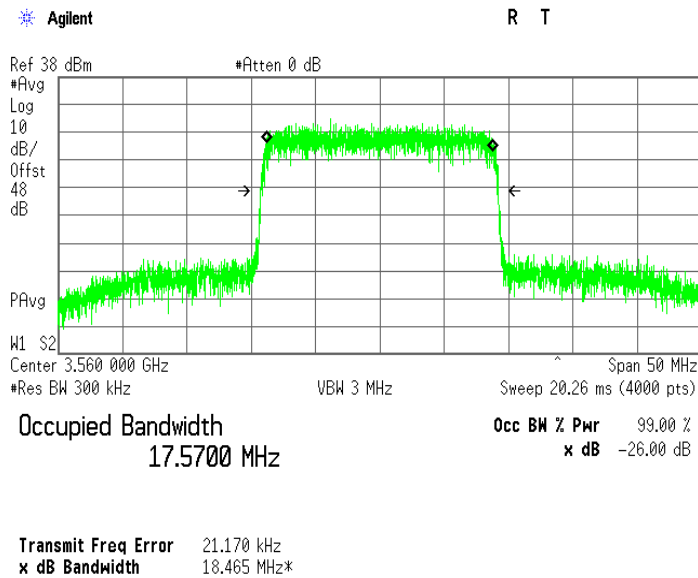

Plot 7.3.11 Occupied bandwidth test result at low frequency

MODULATION: 16QAM
CHANNEL SPACING: 20 MHz

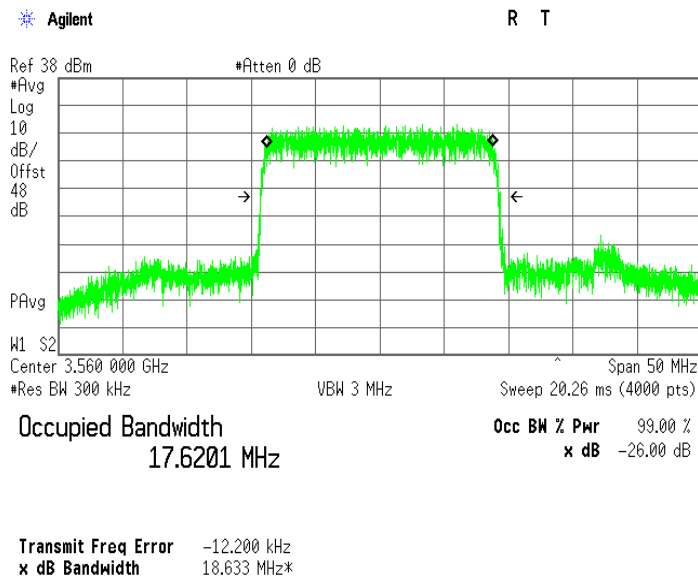



HERMON LABORATORIES

Test specification: Section 2.1049, Occupied bandwidth			
Test procedure: 47 CFR, Section 2.1049			
Test mode: Compliance		Verdict: PASS	
Date(s): 21-Dec-18			
Temperature: 23 °C	Relative Humidity: 55 %	Air Pressure: 1008 hPa	Power: 48 VDC
Remarks:			

Plot 7.3.12 Occupied bandwidth test result at low frequency

MODULATION: 64QAM
CHANNEL SPACING: 20 MHz

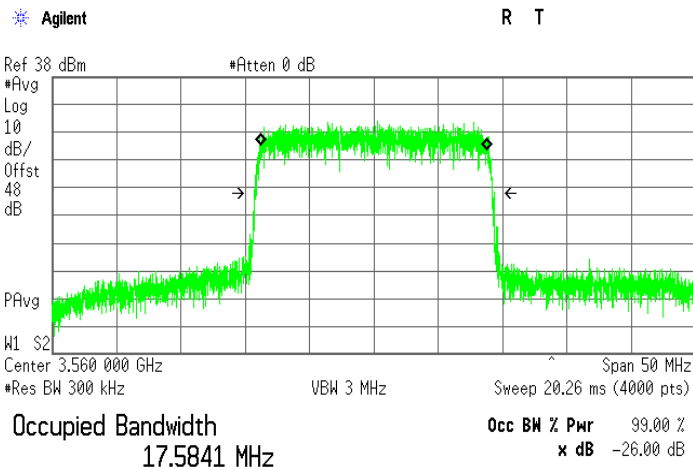

Transmit Freq Error 25.484 kHz
x dB Bandwidth 18.609 MHz*



Test specification: Section 2.1049, Occupied bandwidth			
Test procedure: 47 CFR, Section 2.1049			
Test mode: Compliance		Verdict: PASS	
Date(s): 21-Dec-18			
Temperature: 23 °C	Relative Humidity: 55 %	Air Pressure: 1008 hPa	Power: 48 VDC
Remarks:			

Plot 7.3.13 Occupied bandwidth test result at mid frequency

MODULATION: QPSK
CHANNEL SPACING: 20 MHz

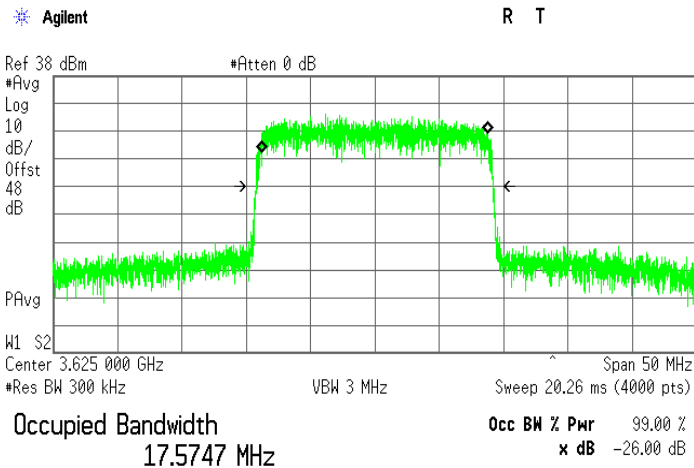

Transmit Freq Error 9.140 kHz
x dB Bandwidth 18.424 MHz*

Plot 7.3.14 Occupied bandwidth test result at mid frequency

MODULATION: 16QAM
CHANNEL SPACING: 20 MHz

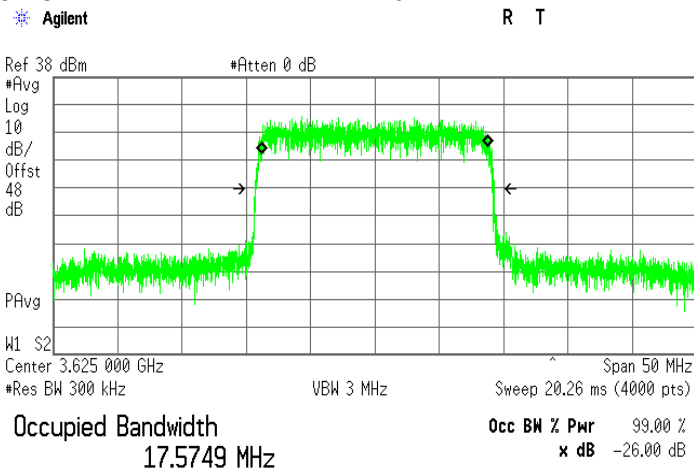

Transmit Freq Error -8.956 kHz
x dB Bandwidth 18.562 MHz*



Test specification: Section2.1049, Occupied bandwidth			
Test procedure: 47 CFR, Section 2.1049			
Test mode: Compliance		Verdict: PASS	
Date(s): 21-Dec-18			
Temperature: 23 °C	Relative Humidity: 55 %	Air Pressure: 1008 hPa	Power: 48 VDC
Remarks:			

Plot 7.3.15 Occupied bandwidth test result at mid frequency

MODULATION: 64QAM
CHANNEL SPACING: 20 MHz

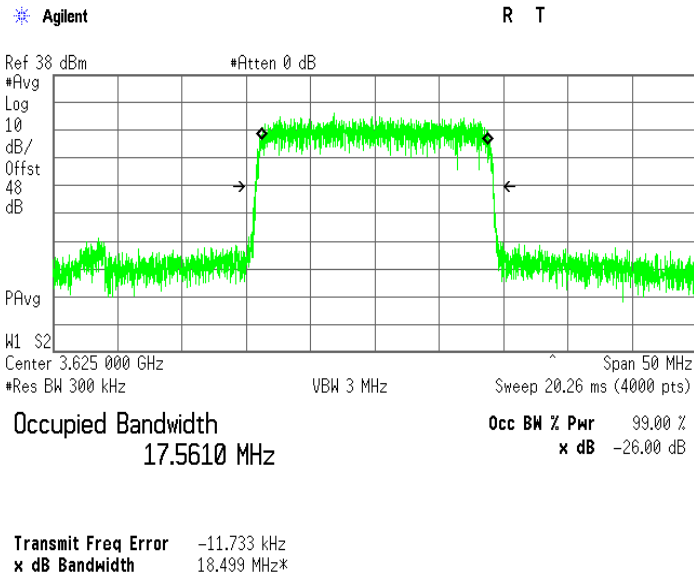

Plot 7.3.16 Occupied bandwidth test result at high frequency

MODULATION: QPSK
CHANNEL SPACING: 20 MHz

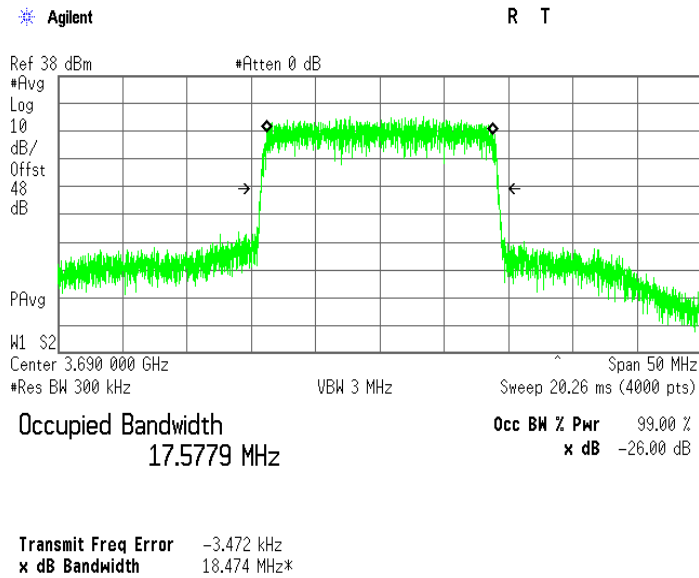



Test specification: Section2.1049, Occupied bandwidth			
Test procedure: 47 CFR, Section 2.1049			
Test mode: Compliance		Verdict: PASS	
Date(s): 21-Dec-18			
Temperature: 23 °C	Relative Humidity: 55 %	Air Pressure: 1008 hPa	Power: 48 VDC
Remarks:			

Plot 7.3.17 Occupied bandwidth test result at high frequency

MODULATION: 16QAM
CHANNEL SPACING: 20 MHz

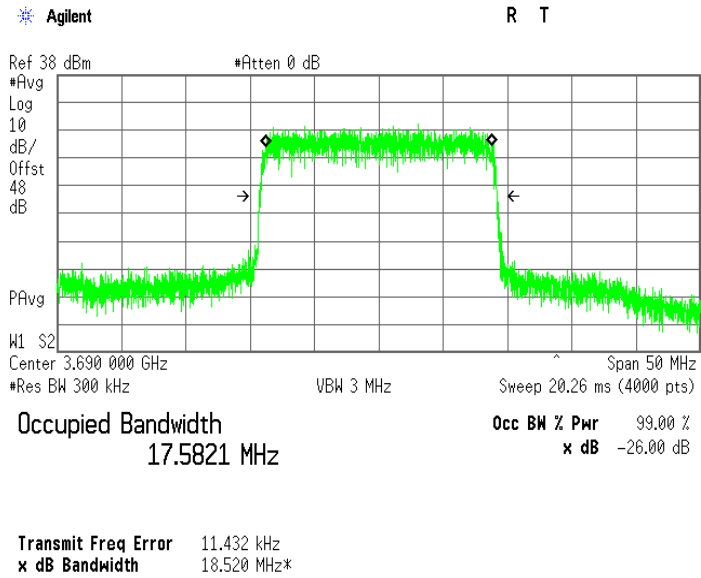

Plot 7.3.18 Occupied bandwidth test result at high frequency

MODULATION: 64QAM
CHANNEL SPACING: 20 MHz

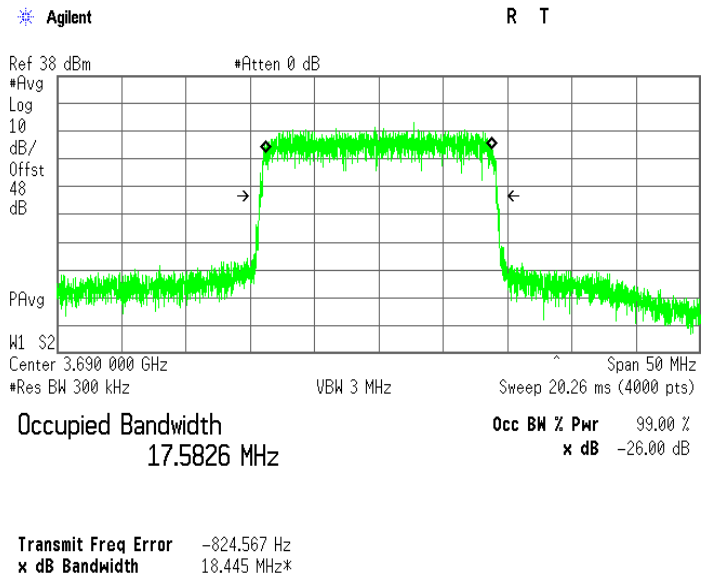



Test specification: Section 96.41(e), Emission mask			
Test procedure: Section 96.41(e)(3)			
Test mode: Compliance		Verdict: PASS	
Date(s): 21-Dec-18			
Temperature: 23 °C	Relative Humidity: 55 %	Air Pressure: 1008 hPa	Power: 48 VDC
Remarks:			

7.4 Emission outside the fundamental test

7.4.1 General

This test was performed to measure emission mask at RF antenna connector. Specification test limits are given in Table 7.4.1.

Table 7.4.1 Emission mask limits

Frequency displacement from frequency block	Limit*, dBm/MHz	RBW, kHz
Channel Spacing 10 MHz		
0 – 1 MHz	- 13	100
0 – 10 MHz	- 13	1000
10 – 20 MHz	- 25	1000
Above 3530 MHz and below 3720 MHz	- 25	1000
Below 3530 MHz and above 3720 MHz	- 40	1000
Channel Spacing 20 MHz		
0 – 1 MHz	- 13	200
0 – 10 MHz	- 13	1000
10 – 20 MHz	- 25	1000
Above 3530 MHz and below 3720 MHz	- 25	1000
Below 3530 MHz and above 3720 MHz	- 40	1000

* - Limit at each antenna connector (amount of antennas N = 2)

7.4.2 Test procedure

7.4.2.1 The EUT was set up as shown in Figure 7.4.1, energized and its proper operation was checked.

7.4.2.2 The emission mask was measured with spectrum analyzer as provided in Table 7.4.2, Table 7.4.3 and the the associated plots.



Test specification: Section 96.41(e), Emission mask			
Test procedure: Section 96.41(e)(3)			
Test mode: Compliance		Verdict: PASS	
Date(s): 21-Dec-18			
Temperature: 23 °C	Relative Humidity: 55 %	Air Pressure: 1008 hPa	Power: 48 VDC
Remarks:			

Figure 7.4.1 Emission mask test setup

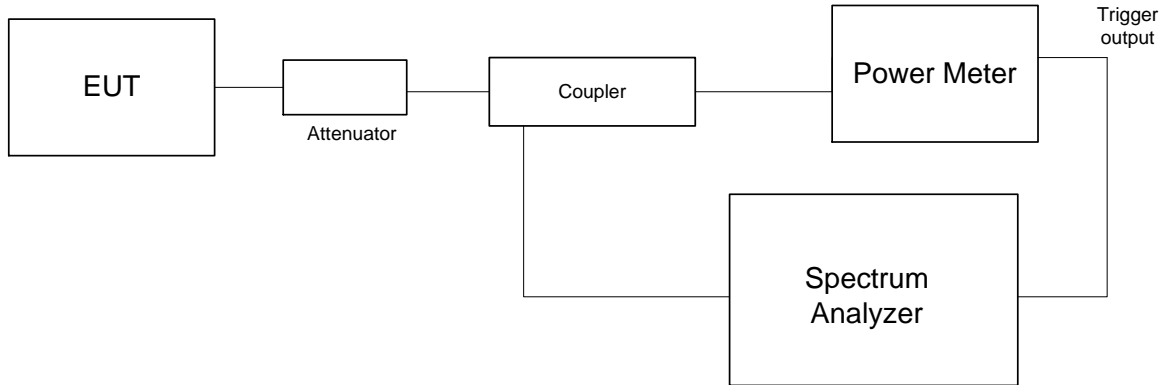



Test specification: Section 96.41(e), Emission mask			
Test procedure: Section 96.41(e)(3)			
Test mode: Compliance		Verdict: PASS	
Date(s): 21-Dec-18			
Temperature: 23 °C	Relative Humidity: 55 %	Air Pressure: 1008 hPa	Power: 48 VDC
Remarks:			

Table 7.4.2 Emission mask test results, CS=10 MHz

Modulation	Carrier frequency, MHz	Frequency displacement from EA frequency block	Test result, dBm/MHz	Limit*, dBm/MHz	Verdict
QPSK	Low	Within 0 to 10 MHz	-24.19	-16	Pass
		Greater than 10 MHz	-32.41	-28	Pass
		Below 3530 MHz	-43.16	-43	Pass
	Mid	Within 0 to 10 MHz	-21.05	-16	Pass
		Greater than 10 MHz	-31.34	-28	Pass
		Above 3720 MHz	-44.08	-43	Pass
	High	Within 0 to 10 MHz	-21.39	-16	Pass
		Greater than 10 MHz	-34.28	-28	Pass
		Above 3720 MHz	-44.08	-43	Pass
16 QAM	Low	Within 0 to 10 MHz	-23.77	-16	Pass
		Greater than 10 MHz	-31.13	-28	Pass
		Below 3530 MHz	-44.22	-43	Pass
	Mid	Within 0 to 10 MHz	-22.74	-16	Pass
		Greater than 10 MHz	-33.22	-28	Pass
		Above 3720 MHz	-43.79	-43	Pass
	High	Within 0 to 10 MHz	-22.13	-16	Pass
		Greater than 10 MHz	-33.14	-28	Pass
		Above 3720 MHz	-43.79	-43	Pass
64 QAM	Low	Within 0 to 10 MHz	-18.45	-16	Pass
		Greater than 10 MHz	-31.06	-28	Pass
		Below 3530 MHz	-43.68	-43	Pass
	Mid	Within 0 to 10 MHz	-23.19	-16	Pass
		Greater than 10 MHz	-33.11	-28	Pass
		Above 3720 MHz	-43.05	-43	Pass
	High	Within 0 to 10 MHz	-21.76	-16	Pass
		Greater than 10 MHz	-32.58	-28	Pass
		Above 3720 MHz	-43.05	-43	Pass

Note: Offset 48 dB included: coupling loss 16 dB, attenuator 30 dB, cables loss 2.0 dB

*The limit was reduced 3 dB due to 2 antennae.



Test specification: Section 96.41(e), Emission mask			
Test procedure: Section 96.41(e)(3)			
Test mode: Compliance		Verdict: PASS	
Date(s): 21-Dec-18			
Temperature: 23 °C	Relative Humidity: 55 %	Air Pressure: 1008 hPa	Power: 48 VDC
Remarks:			

Table 7.4.3 Emission mask test results, CS=20 MHz

Modulation	Carrier frequency, MHz	Frequency displacement from EA frequency block	Test result dBm/MHz	Limit* dBm/MHz	Verdict		
QPSK	Low	Within 0 to 10 MHz	-27.06	-16	Pass		
		Greater than 10 MHz	-32.41	-28	Pass		
		Below 3530 MHz	-43.17	-43	Pass		
	Mid	Within 0 to 10 MHz	-23.65	-16	Pass		
		Greater than 10 MHz	-31.07	-28	Pass		
		High	Within 0 to 10 MHz	-30.92	-16	Pass	
	16 QAM	Low	Greater than 10 MHz	-35.04	-28	Pass	
			Above 3720 MHz	-43.15	-43	Pass	
			Within 0 to 10 MHz	-26.30	-16	Pass	
Mid		Greater than 10 MHz	-31.44	-28	Pass		
		Below 3530 MHz	-43.15	-43	Pass		
		High	Within 0 to 10 MHz	-24.44	-16	Pass	
64 QAM	Low	Greater than 10 MHz	-30.28	-28	Pass		
		Above 3720 MHz	-43.03	-43	Pass		
		Within 0 to 10 MHz	-30.57	-16	Pass		
	Mid	Greater than 10 MHz	-35.30	-28	Pass		
		High	Within 0 to 10 MHz	-26.97	-16	Pass	
		Greater than 10 MHz	-31.62	-28	Pass		
	64 QAM	Low	Below 3530 MHz	-43.14	-43	Pass	
			Mid	Within 0 to 10 MHz	-23.63	-16	Pass
			Greater than 10 MHz	-28.71	-28	Pass	
High		Within 0 to 10 MHz	-29.81	-16	Pass		
		Greater than 10 MHz	-36.23	-28	Pass		
		Above 3720 MHz	-43.10	-43	Pass		

*The limit was reduced 3 dB due to 2 antennae.

Reference numbers of test equipment used

HL 3818						
---------	--	--	--	--	--	--

Full description is given in Appendix A.



HERMON LABORATORIES

Test specification: Section 96.41(e), Emission mask			
Test procedure: Section 96.41(e)(3)			
Test mode: Compliance		Verdict: PASS	
Date(s): 21-Dec-18			
Temperature: 23 °C	Relative Humidity: 55 %	Air Pressure: 1008 hPa	Power: 48 VDC
Remarks:			

Plot 7.4.1 Emission outside the fundamental test results at low carrier frequency

CHANNEL SPACING:
ANTENNA CHAIN:
Modulation: QPSK

10 MHz
1
Modulation: 16 QAM

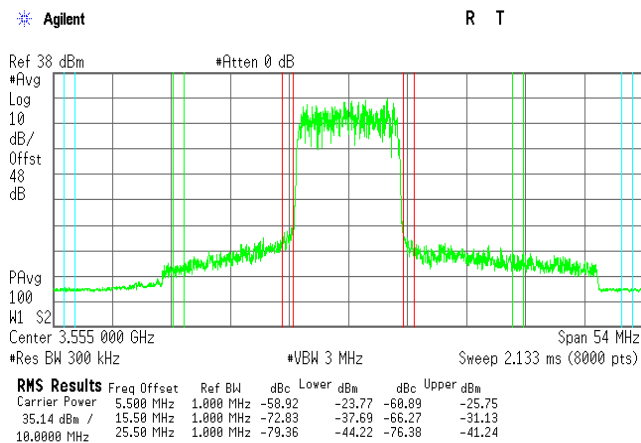
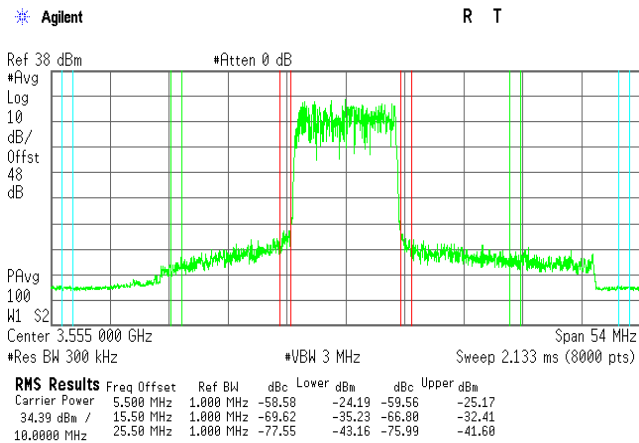

Modulation:64 QAM



HERMON LABORATORIES

Test specification: Section 96.41(e), Emission mask			
Test procedure: Section 96.41(e)(3)			
Test mode: Compliance		Verdict: PASS	
Date(s): 21-Dec-18			
Temperature: 23 °C	Relative Humidity: 55 %	Air Pressure: 1008 hPa	Power: 48 VDC
Remarks:			

* Agilent

R T

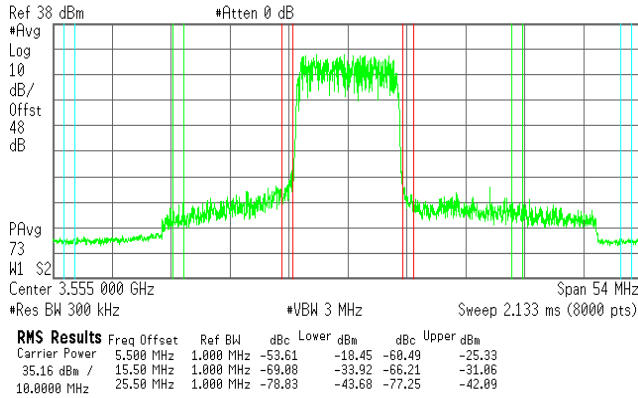



HERMON LABORATORIES

Test specification: Section 96.41(e), Emission mask			
Test procedure: Section 96.41(e)(3)			
Test mode: Compliance	Verdict: PASS		
Date(s): 21-Dec-18			
Temperature: 23 °C	Relative Humidity: 55 %	Air Pressure: 1008 hPa	Power: 48 VDC
Remarks:			

Plot 7.4.2 Emission outside the fundamental test results at mid carrier frequency

CHANNEL SPACING:
ANTENNA CHAIN:
Modulation: QPSK

10 MHz
1
Modulation: 16 QAM

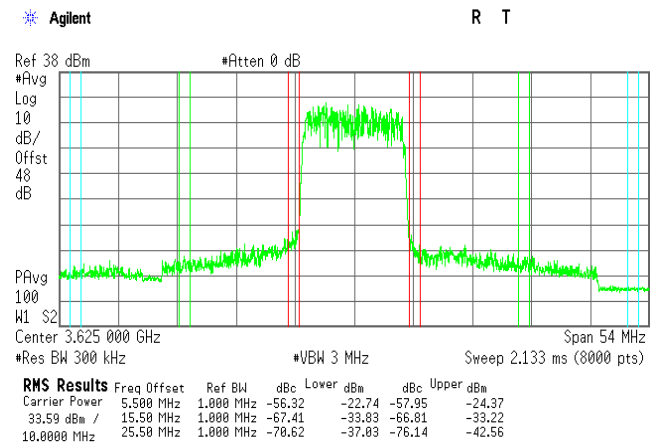
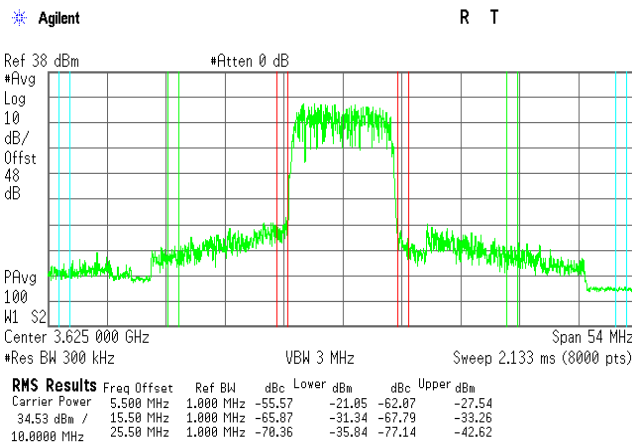

Modulation: 64 QAM

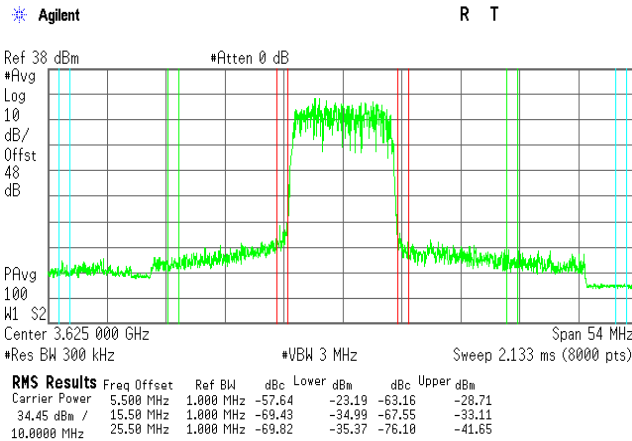



HERMON LABORATORIES

Test specification: Section 96.41(e), Emission mask			
Test procedure: Section 96.41(e)(3)			
Test mode: Compliance		Verdict: PASS	
Date(s): 21-Dec-18			
Temperature: 23 °C	Relative Humidity: 55 %	Air Pressure: 1008 hPa	Power: 48 VDC
Remarks:			

Plot 7.4.3 Emission outside the fundamental test results at high carrier frequency

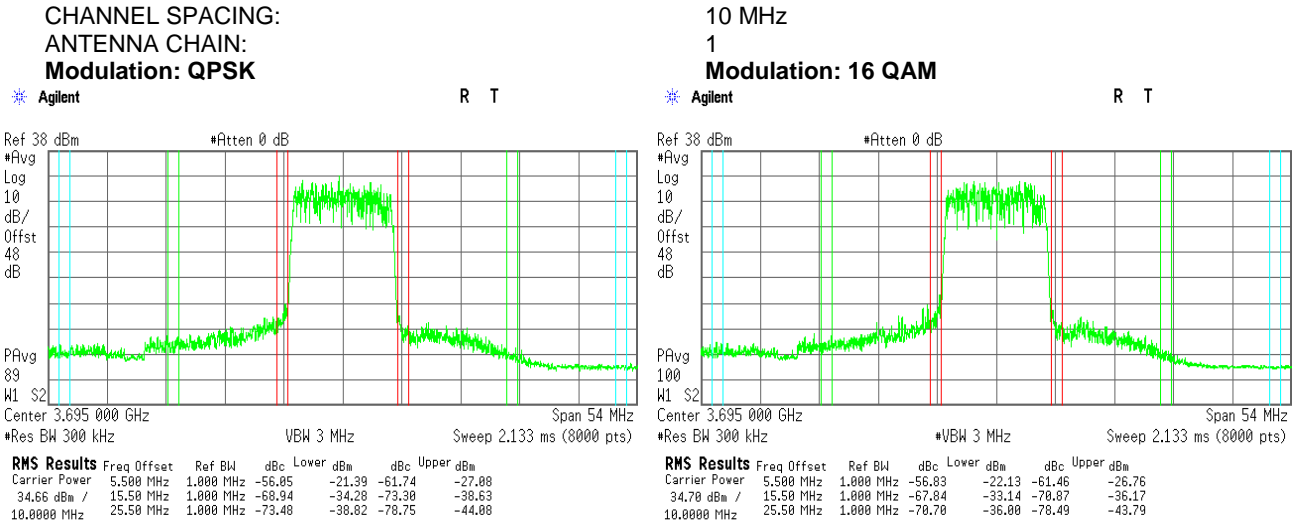

Modulation: 64 QAM

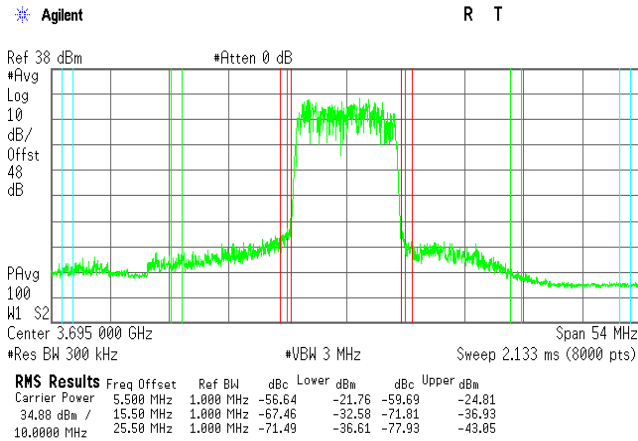



HERMON LABORATORIES

Test specification: Section 96.41(e), Emission mask			
Test procedure: Section 96.41(e)(3)			
Test mode: Compliance		Verdict: PASS	
Date(s): 21-Dec-18			
Temperature: 23 °C	Relative Humidity: 55 %	Air Pressure: 1008 hPa	Power: 48 VDC
Remarks:			

Plot 7.4.4 Emission mask test results at low carrier frequency

MODULATION: QPSK
CHANNEL SPACING: 20 MHz
ANTENNA CHAIN: 1

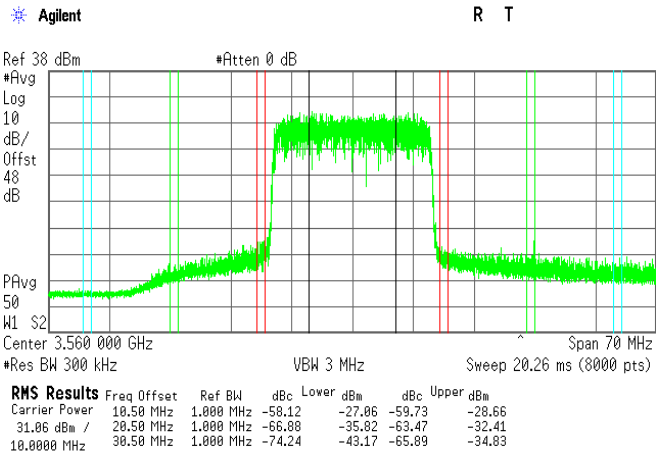

Plot 7.4.5 Emission mask test results at low carrier frequency

MODULATION: 16QAM
CHANNEL SPACING: 20 MHz
ANTENNA CHAIN: 1

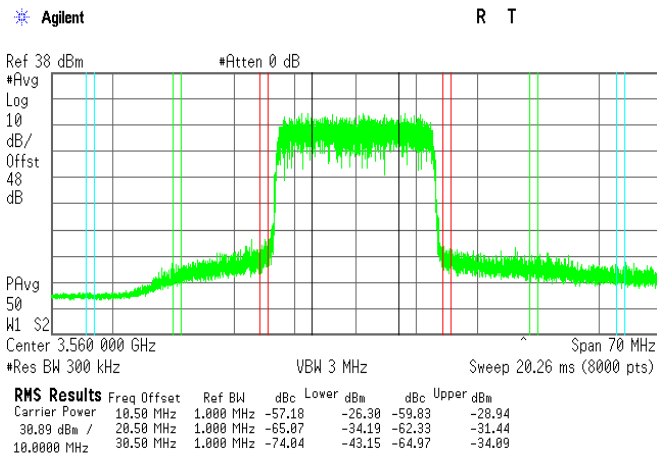



HERMON LABORATORIES

Test specification: Section 96.41(e), Emission mask			
Test procedure: Section 96.41(e)(3)			
Test mode: Compliance		Verdict: PASS	
Date(s): 21-Dec-18			
Temperature: 23 °C	Relative Humidity: 55 %	Air Pressure: 1008 hPa	Power: 48 VDC
Remarks:			

Plot 7.4.6 Emission mask test results at low carrier frequency

MODULATION: 64QAM
CHANNEL SPACING: 20 MHz
ANTENNA CHAIN: 1

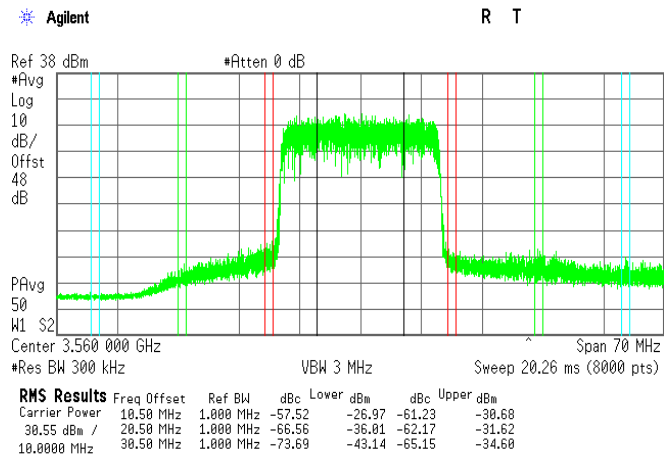

Plot 7.4.7 Emission mask test results at mid carrier frequency

MODULATION: QPSK
CHANNEL SPACING: 20 MHz
ANTENNA CHAIN: 1

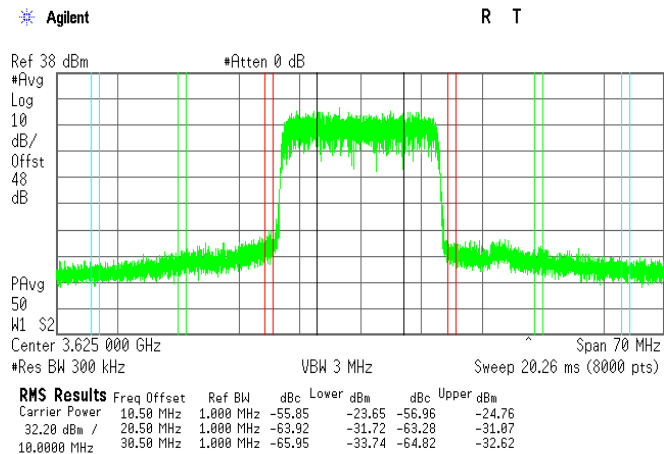



Test specification: Section 96.41(e), Emission mask			
Test procedure: Section 96.41(e)(3)			
Test mode: Compliance		Verdict: PASS	
Date(s): 21-Dec-18			
Temperature: 23 °C	Relative Humidity: 55 %	Air Pressure: 1008 hPa	Power: 48 VDC
Remarks:			

Plot 7.4.8 Emission mask test results at mid carrier frequency

MODULATION: 16QAM
CHANNEL SPACING: 20 MHz
ANTENNA CHAIN: 1

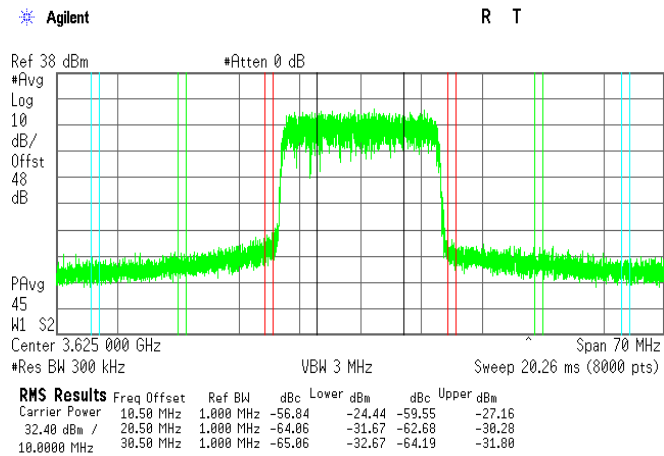

Plot 7.4.9 Emission mask test results at mid carrier frequency

MODULATION: 64QAM
CHANNEL SPACING: 20 MHz
ANTENNA CHAIN: 1

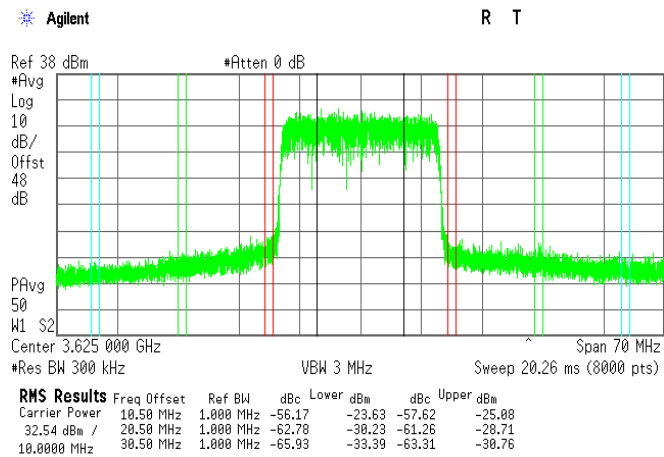



HERMON LABORATORIES

Test specification: Section 96.41(e), Emission mask			
Test procedure: Section 96.41(e)(3)			
Test mode: Compliance		Verdict: PASS	
Date(s): 21-Dec-18			
Temperature: 23 °C	Relative Humidity: 55 %	Air Pressure: 1008 hPa	Power: 48 VDC
Remarks:			

Plot 7.4.10 Emission mask test results at high carrier frequency

MODULATION: QPSK
CHANNEL SPACING: 20 MHz
ANTENNA CHAIN: 1

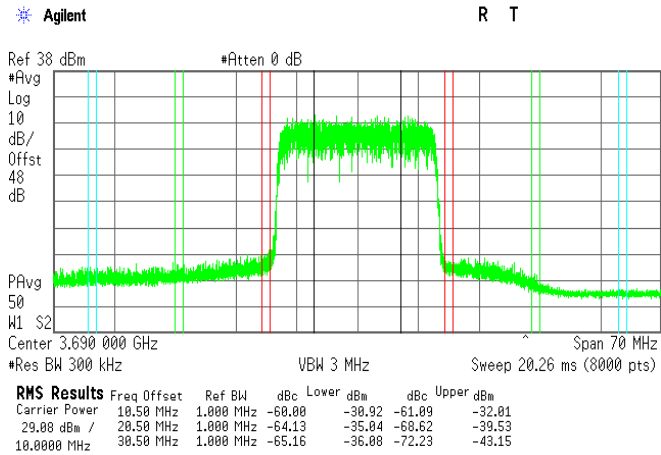

Plot 7.4.11 Emission mask test results at high carrier frequency

MODULATION: 16QAM
CHANNEL SPACING: 20 MHz
ANTENNA CHAIN: 1

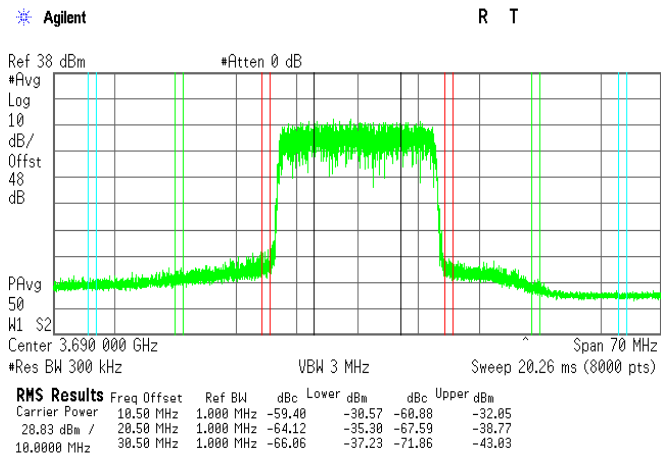



HERMON LABORATORIES

Test specification: Section 96.41(e), Emission mask			
Test procedure: Section 96.41(e)(3)			
Test mode: Compliance		Verdict: PASS	
Date(s): 21-Dec-18			
Temperature: 23 °C	Relative Humidity: 55 %	Air Pressure: 1008 hPa	Power: 48 VDC
Remarks:			

Plot 7.4.12 Emission mask test results at high carrier frequency

MODULATION: 64QAM
CHANNEL SPACING: 20 MHz
ANTENNA CHAIN: 1

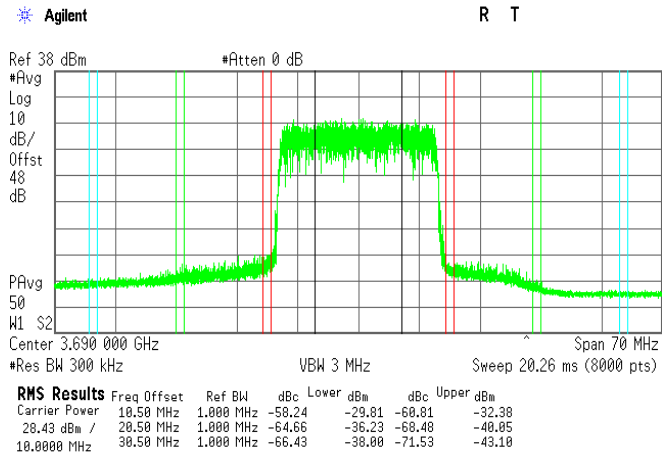



Test specification: Section 96.41(e)(2), Radiated spurious emissions			
Test procedure: Section 96.41(e)(3)			
Test mode: Compliance		Verdict: PASS	
Date(s): 18-Dec-18			
Temperature: 24 °C	Relative Humidity: 52 %	Air Pressure: 1020 hPa	Power: 48 VDC
Remarks:			

7.5 Radiated spurious emission measurements

7.5.1 General

This test was performed to measure radiated spurious emissions from the EUT. Specification test limits are given in Table 7.5.1.

Table 7.5.1 Radiated spurious emission test limits

Frequency, MHz	EIRP of spurious, dBm	Equivalent field strength limit @ 3m, dB(μV/m)***
0.09 – below 3530.0	-40.0	55.2
3720.0 – 10th harmonic*	-40.0	55.2

*** - Equivalent field strength limit was calculated from maximum allowed ERP of spurious as follows: $E = \sqrt{30 \times P \times 1.64} / r$, where P is ERP in Watts, 1.64 is numeric gain of ideal dipole and r is antenna to EUT distance in meters

7.5.2 Test procedure for spurious emission field strength measurements in 9 kHz to 30 MHz band

7.5.2.1 The EUT was set up as shown in Figure 7.5.1, energized and the performance check was conducted.

7.5.2.2 The specified frequency range was investigated with antenna connected to spectrum analyzer. To find maximum radiation the turntable was rotated 360° and the measuring antenna was rotated around its vertical axis.

7.5.2.3 The worst test results (the lowest margins) were recorded in Table 7.5.2 and shown in the associated plots.

7.5.3 Test procedure for spurious emission field strength measurements above 30 MHz

7.5.3.1 The EUT was set up as shown in Figure 7.5.2, energized and the performance check was conducted.

7.5.3.2 The specified frequency range was investigated with antenna connected to spectrum analyzer. To find maximum radiation the turntable was rotated 360° and the measuring antenna height was swept from 1 to 4 m in both, vertical and horizontal, polarizations.

7.5.3.3 The worst test results (the lowest margins) were recorded in Table 7.5.2 and shown in the associated plots.



Test specification: Section 96.41(e)(2), Radiated spurious emissions			
Test procedure: Section 96.41(e)(3)			
Test mode: Compliance		Verdict: PASS	
Date(s): 18-Dec-18			
Temperature: 24 °C	Relative Humidity: 52 %	Air Pressure: 1020 hPa	Power: 48 VDC
Remarks:			

Figure 7.5.1 Setup for spurious emission field strength measurements in 9 kHz to 30 MHz band

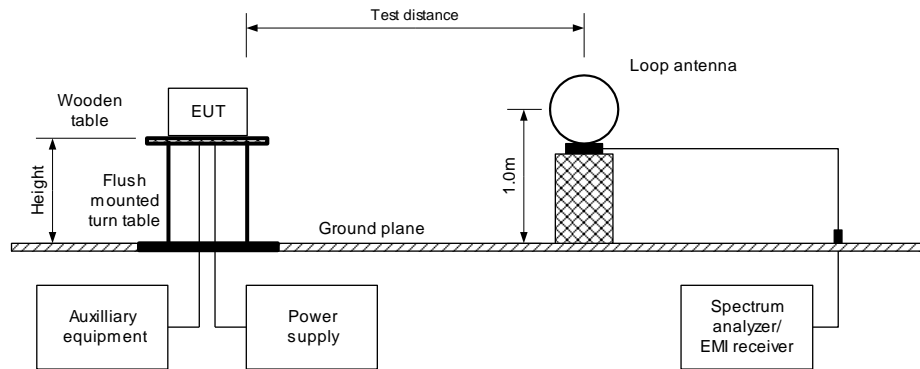
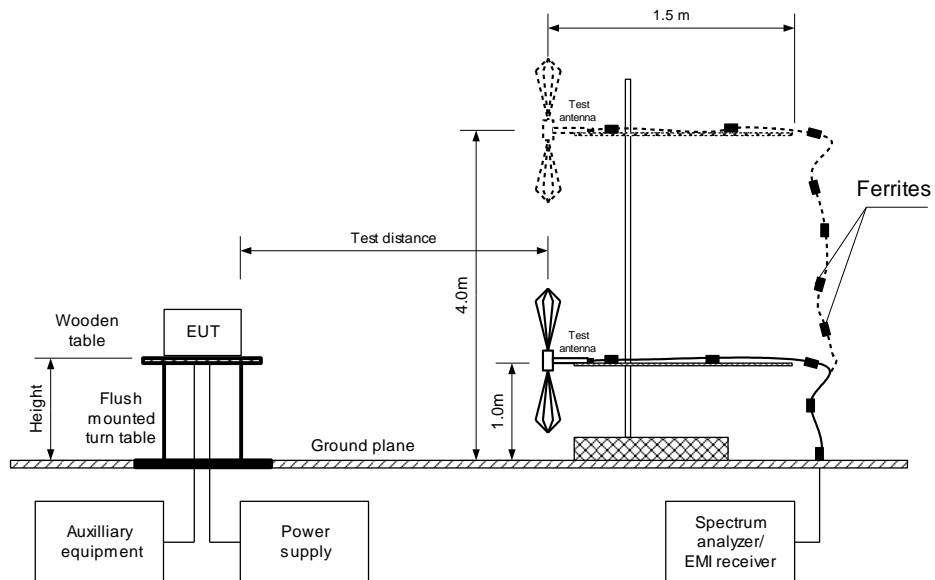

Figure 7.5.2 Setup for spurious emission field strength measurements above 30 MHz





Test specification: Section 96.41(e)(2), Radiated spurious emissions			
Test procedure: Section 96.41(e)(3)			
Test mode: Compliance		Verdict: PASS	
Date(s): 18-Dec-18			
Temperature: 24 °C	Relative Humidity: 52 %	Air Pressure: 1020 hPa	Power: 48 VDC
Remarks:			

Table 7.5.2 Spurious emission field strength test results

ASSIGNED FREQUENCY RANGE: 3550 - 3700 MHz
TEST DISTANCE: 3 m
TEST SITE: Semi anechoic chamber
INVESTIGATED FREQUENCY RANGE: 0.009 – 37000 MHz
DETECTOR USED: Peak
VIDEO BANDWIDTH: > Resolution bandwidth
TEST ANTENNA TYPE: Active loop (9 kHz – 30 MHz)
Biconilog (30 MHz – 1000 MHz)
Double ridged guide (above 1000 MHz)

MODULATION: QPSK
MODULATING SIGNAL: PRBS
TRANSMITTER OUTPUT POWER SETTINGS: Maximum

Frequency, MHz	Field strength, dB(μV/m)	Limit, dB(μV/m)	Margin, dB*	RBW, kHz	Antenna polarization	Antenna height, cm	Turn-table position**, degrees	Verdict
Low, mid and high frequency								
33.258	51.41	55.2	-3.79	100	Vertical	104	-173	Pass
499.190	39.78	55.2	-15.42	100	Vertical	102	62	Pass
1267.228	38.61	55.2	-16.59	1000	Horizontal	162	-149	Pass
1420.955	39.21	55.2	-15.99	1000	Horizontal	192	-121	Pass
1843.067	41.09	55.2	-14.11	1000	Vertical	192	-162	Pass
2400.227	39.81	55.2	-15.39	1000	Vertical	100	180	Pass
Mid frequency								
7250.075	51.27	55.2	-3.93	1000	Vertical	263	-167	Pass
High frequency								
7393.410	45.84	55.2	-9.36	1000	Vertical	223	22	Pass

*- Margin = Field strength of spurious – calculated field strength limit.

** - EUT front panel refers to 0 degrees position of turntable.

Reference numbers of test equipment used

HL 0446	HL 3903	HL 4360	HL 4933	HL 4956	HL 5111	HL 5288	HL 5405
---------	---------	---------	---------	---------	---------	---------	---------

Full description is given in Appendix A.



Test specification: Section 96.41(e)(2), Radiated spurious emissions			
Test procedure: Section 96.41(e)(3)			
Test mode: Compliance		Verdict: PASS	
Date(s): 18-Dec-18			
Temperature: 24 °C	Relative Humidity: 52 %	Air Pressure: 1020 hPa	Power: 48 VDC
Remarks:			

Plot 7.5.1 Radiated emission measurements in 9 kHz - 30 MHz range

TEST SITE: Semi anechoic chamber
 CARRIER FREQUENCY: Low
 TEST DISTANCE: 3 m

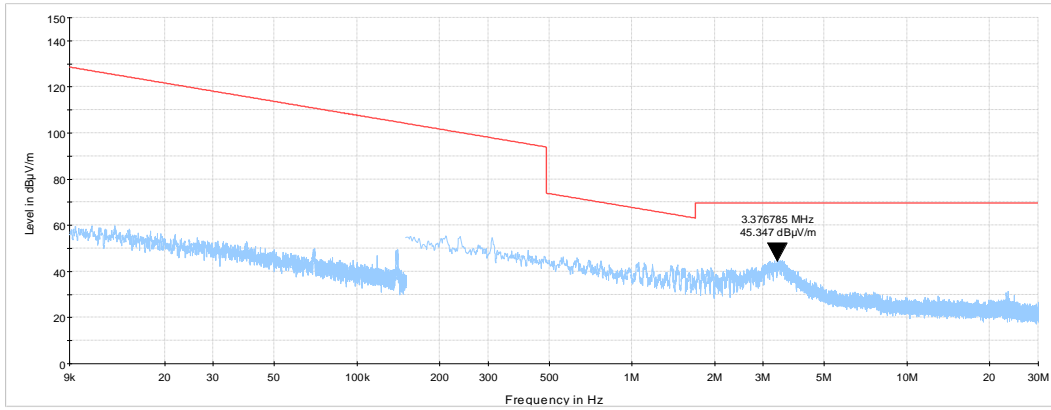

Plot 7.5.2 Radiated emission measurements in 9 kHz - 30 MHz range

TEST SITE: Semi anechoic chamber
 CARRIER FREQUENCY: Mid
 TEST DISTANCE: 3 m

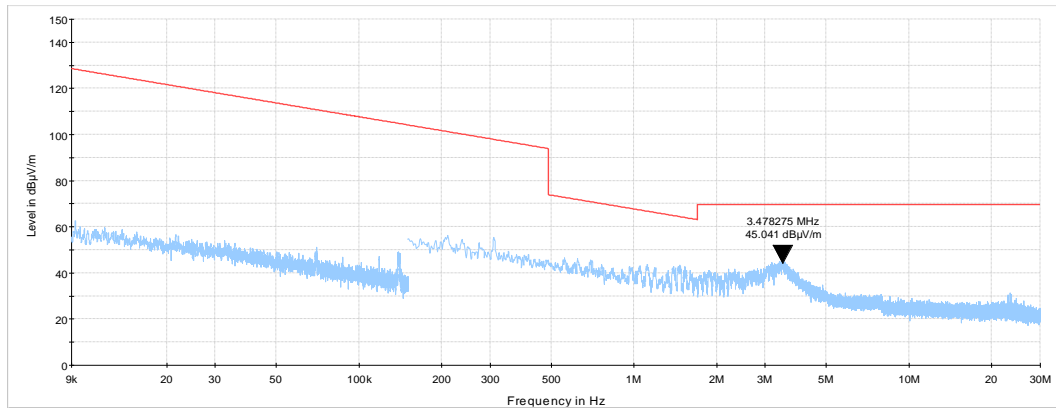



HERMON LABORATORIES

Test specification: Section 96.41(e)(2), Radiated spurious emissions			
Test procedure: Section 96.41(e)(3)			
Test mode: Compliance		Verdict: PASS	
Date(s): 18-Dec-18			
Temperature: 24 °C	Relative Humidity: 52 %	Air Pressure: 1020 hPa	Power: 48 VDC
Remarks:			

Plot 7.5.3 Radiated emission measurements in 9 kHz - 30 MHz range

TEST SITE: Semi anechoic chamber
CARRIER FREQUENCY: High
TEST DISTANCE: 3 m

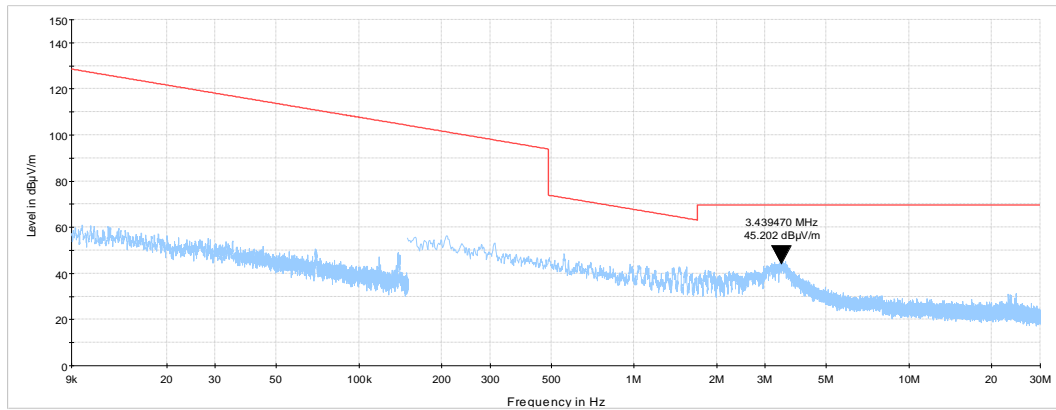



HERMON LABORATORIES

Test specification: Section 96.41(e)(2), Radiated spurious emissions			
Test procedure: Section 96.41(e)(3)			
Test mode: Compliance		Verdict: PASS	
Date(s): 18-Dec-18			
Temperature: 24 °C	Relative Humidity: 52 %	Air Pressure: 1020 hPa	Power: 48 VDC
Remarks:			

Plot 7.5.4 Radiated emission measurements in 30 - 1000 MHz range

TEST SITE:	Semi anechoic chamber
CARRIER FREQUENCY:	Low
ANTENNA POLARIZATION:	Vertical and Horizontal
TEST DISTANCE:	3 m

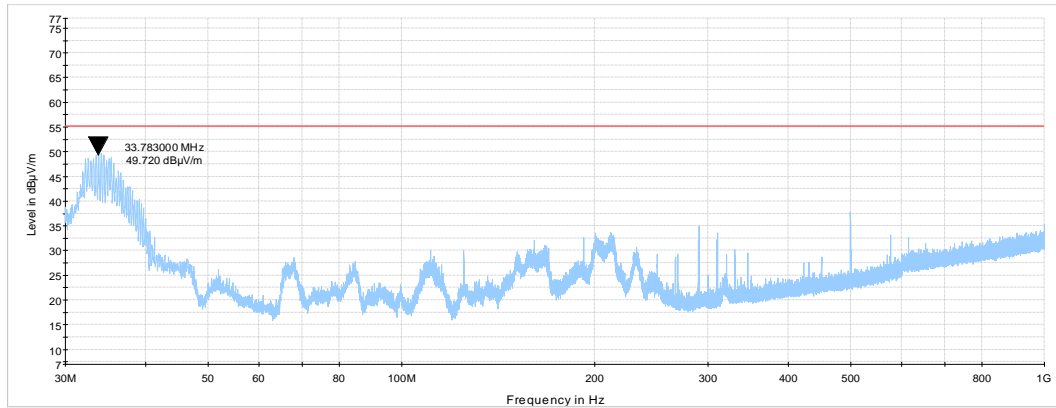

Plot 7.5.5 Radiated emission measurements in 30 - 1000 MHz range

TEST SITE:	Semi anechoic chamber
CARRIER FREQUENCY:	Mid
ANTENNA POLARIZATION:	Vertical and Horizontal
TEST DISTANCE:	3 m

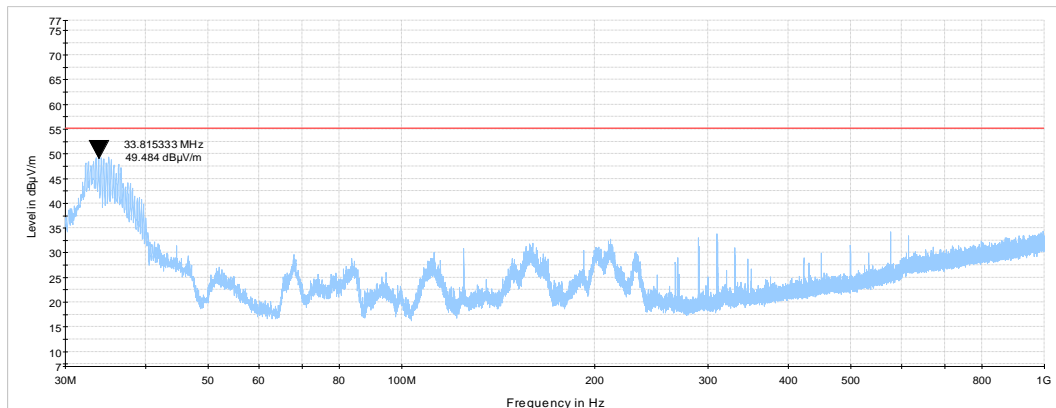



Test specification: Section 96.41(e)(2), Radiated spurious emissions			
Test procedure: Section 96.41(e)(3)			
Test mode: Compliance		Verdict: PASS	
Date(s): 18-Dec-18			
Temperature: 24 °C	Relative Humidity: 52 %	Air Pressure: 1020 hPa	Power: 48 VDC
Remarks:			

Plot 7.5.6 Radiated emission measurements in 30 - 1000 MHz range

TEST SITE:	Semi anechoic chamber
CARRIER FREQUENCY:	High
ANTENNA POLARIZATION:	Vertical and Horizontal
TEST DISTANCE:	3 m

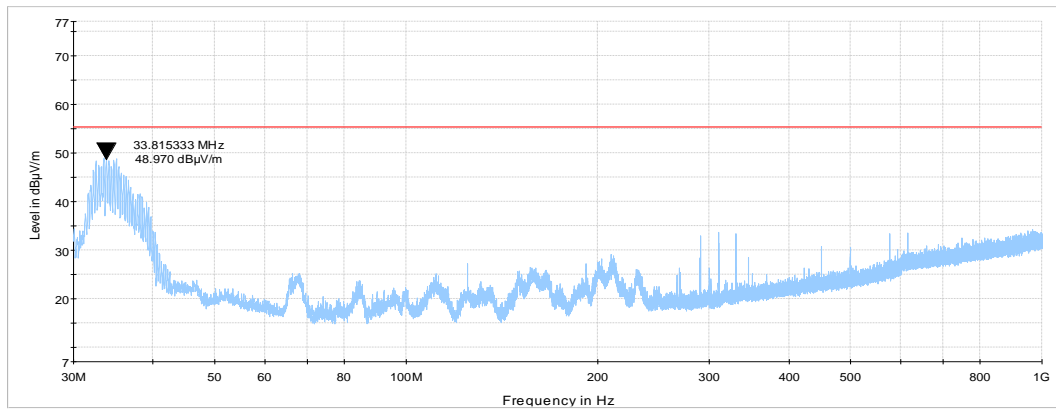



Test specification: Section 96.41(e)(2), Radiated spurious emissions			
Test procedure: Section 96.41(e)(3)			
Test mode: Compliance		Verdict: PASS	
Date(s): 18-Dec-18			
Temperature: 24 °C	Relative Humidity: 52 %	Air Pressure: 1020 hPa	Power: 48 VDC
Remarks:			

Plot 7.5.7 Radiated emission measurements in 1000 – 18000 MHz range

TEST SITE:	Semi anechoic chamber
CARRIER FREQUENCY:	Low
ANTENNA POLARIZATION:	Vertical and Horizontal
TEST DISTANCE:	3 m

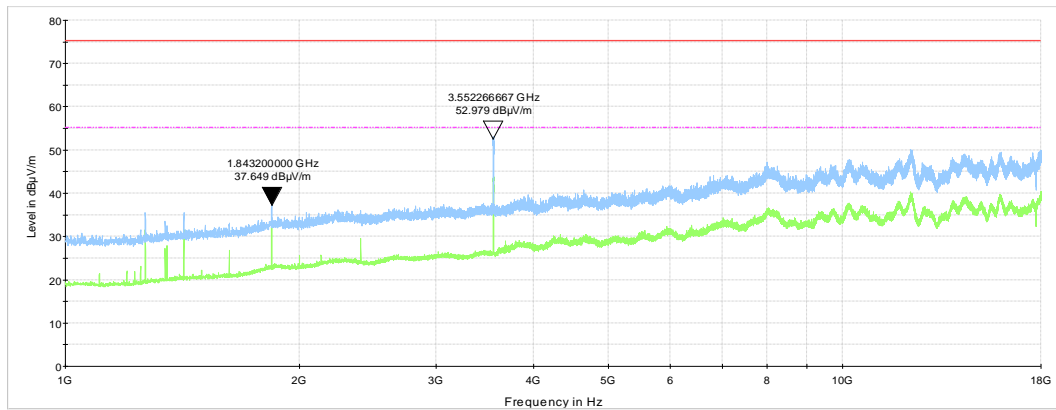

Plot 7.5.8 Radiated emission measurements in 1000 – 18000 MHz range

TEST SITE:	Semi anechoic chamber
CARRIER FREQUENCY:	Mid
ANTENNA POLARIZATION:	Vertical and Horizontal
TEST DISTANCE:	3 m

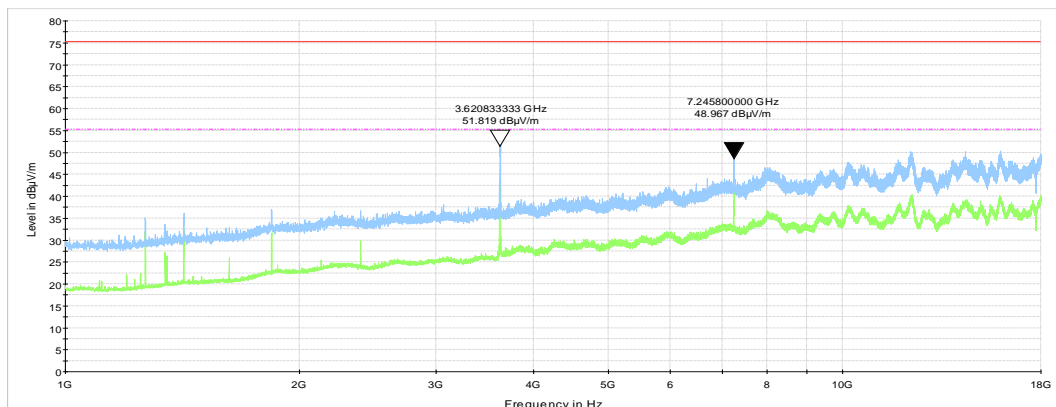



HERMON LABORATORIES

Test specification: Section 96.41(e)(2), Radiated spurious emissions			
Test procedure: Section 96.41(e)(3)			
Test mode: Compliance		Verdict: PASS	
Date(s): 18-Dec-18			
Temperature: 24 °C	Relative Humidity: 52 %	Air Pressure: 1020 hPa	Power: 48 VDC
Remarks:			

Plot 7.5.9 Radiated emission measurements in 1000 – 18000 MHz range

TEST SITE:	Semi anechoic chamber
CARRIER FREQUENCY:	High
ANTENNA POLARIZATION:	Vertical and Horizontal
TEST DISTANCE:	3 m

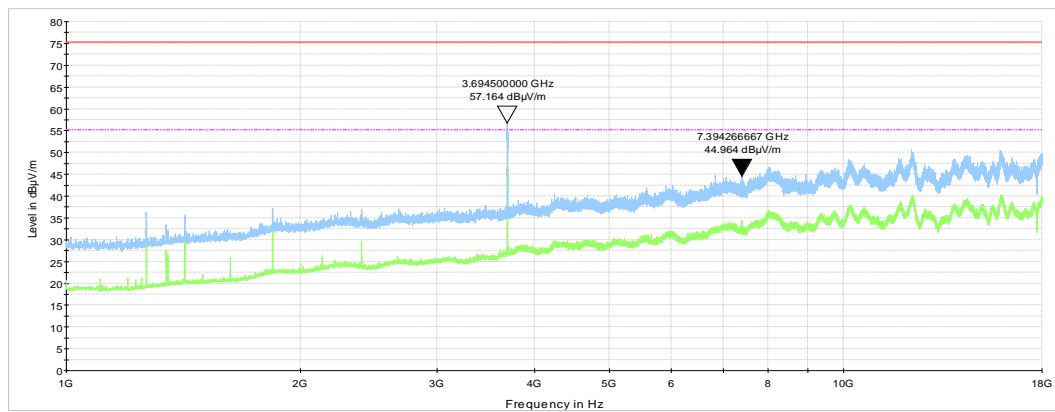



Test specification: Section 96.41(e)(2), Radiated spurious emissions			
Test procedure: Section 96.41(e)(3)			
Test mode: Compliance		Verdict: PASS	
Date(s): 18-Dec-18			
Temperature: 24 °C	Relative Humidity: 52 %	Air Pressure: 1020 hPa	Power: 48 VDC
Remarks:			

Plot 7.5.10 Radiated emission measurements in 18000 – 37000 MHz range

TEST SITE: Semi anechoic chamber
 CARRIER FREQUENCY: Low
 ANTENNA POLARIZATION: Vertical and Horizontal
 TEST DISTANCE: 3 m

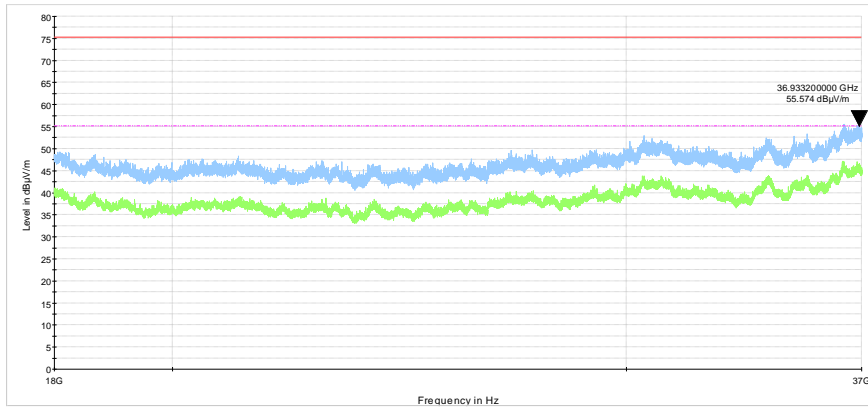

Plot 7.5.11 Radiated emission measurements in 18000 – 37000 MHz range

TEST SITE: Semi anechoic chamber
 CARRIER FREQUENCY: Mid
 ANTENNA POLARIZATION: Vertical and Horizontal
 TEST DISTANCE: 3 m

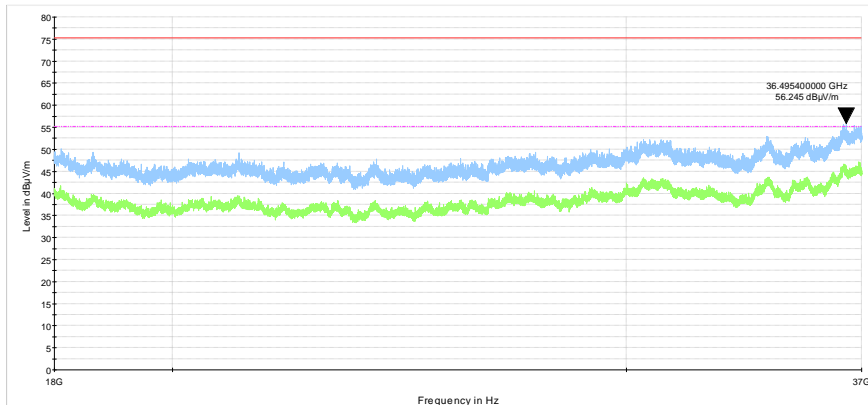



HERMON LABORATORIES

Test specification: Section 96.41(e)(2), Radiated spurious emissions			
Test procedure: Section 96.41(e)(3)			
Test mode: Compliance		Verdict: PASS	
Date(s): 18-Dec-18			
Temperature: 24 °C	Relative Humidity: 52 %	Air Pressure: 1020 hPa	Power: 48 VDC
Remarks:			

Plot 7.5.12 Radiated emission measurements in 18000 – 37000 MHz range

TEST SITE:	Semi anechoic chamber
CARRIER FREQUENCY:	High
ANTENNA POLARIZATION:	Vertical and Horizontal
TEST DISTANCE:	3 m

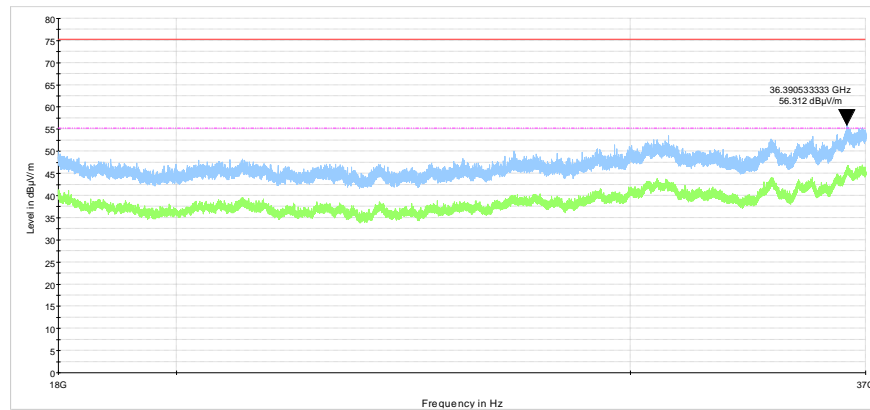



Test specification: Section 96.41(e)(3), Conducted spurious emissions			
Test procedure: Section 96.41(e)(3)			
Test mode: Compliance		Verdict: PASS	
Date(s): 23-Dec-18			
Temperature: 24.3 °C	Relative Humidity: 48 %	Air Pressure: 1009 hPa	Power: 48 VDC
Remarks:			

7.6 Spurious emissions at RF antenna connector test

7.6.1 General

This test was performed to measure spurious emissions at RF antenna connector. Specification test limits are given in Table 7.6.1.

Table 7.6.1 Spurious emission limits

Frequency offset from channel band edge, MHz	Attenuation below carrier, dBc	ERP of spurious, dBm
0 – 10	NA	-13.0
10 – 20	NA	-25.0
More than 20	NA	-40.0

* - spurious emission limits do not apply to the in band emission within $\pm 250\%$ of the authorized bandwidth from the carrier; investigated in course of emission mask testing

** - P is transmitter output power in Watts

7.6.2 Test procedure

7.6.2.1 The EUT was set up as shown in Figure 7.6.1, energized and its proper operation was checked.

7.6.2.2 The EUT was adjusted to produce maximum available for end user RF output power.

7.6.2.3 The spurious emission was measured with spectrum analyzer as provided in Table 7.6.2 and associated plots.

Figure 7.6.1 Spurious emission test setup

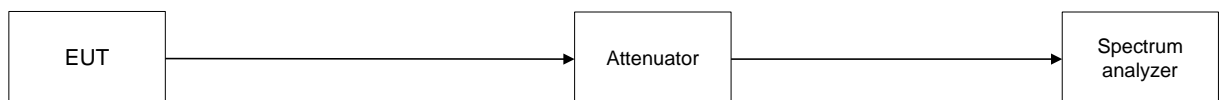



Test specification: Section 96.41(e)(3), Conducted spurious emissions			
Test procedure: Section 96.41(e)(3)			
Test mode: Compliance		Verdict: PASS	
Date(s): 23-Dec-18			
Temperature: 24.3 °C	Relative Humidity: 48 %	Air Pressure: 1009 hPa	Power: 48 VDC
Remarks:			

Table 7.6.2 Spurious emission test results

ASSIGNED FREQUENCY RANGE: 3550 - 3700 MHz
 INVESTIGATED FREQUENCY RANGE: 0.009 – 37000 MHz
 DETECTOR USED: Peak
 VIDEO BANDWIDTH: ≥ Resolution bandwidth
 MODULATION: QPSK
 MODULATING SIGNAL: PRBS
 CHANNEL SPACING: 10 MHz
 TRANSMITTER OUTPUT POWER SETTINGS: Maximum

Frequency, MHz	SA reading, dBm	Attenuator, dB	Cable loss, dB	RBW, kHz	Spurious emission, dBm	Attenuation below carrier, dBc	Limit, dBc	Margin, dB*	Verdict
Low carrier frequency 3555 MHz									
No emissions were found									Pass
Mid carrier frequency 3625 MHz									
No emissions were found									Pass
High carrier frequency 3695 MHz									
No emissions were found									Pass

*- Margin = Spurious emission – specification limit.

Note: in 0.009-18000 MHz range the offset 31.6 dB included: attenuator 30 dB, cables loss 1.6 dB
 in 18-37 GHz range the offset 32.9 dB included: attenuator 30 dB, cables loss 2.9 dB

Reference numbers of test equipment used

HL 4355	HL 3818	HL 3903	HL 3434	HL 4366	HL 5286
HL 3287	HL 4342	HL 5174	HL 5175		

Full description is given in Appendix A.



Test specification: Section 96.41(e)(3), Conducted spurious emissions			
Test procedure: Section 96.41(e)(3)			
Test mode: Compliance		Verdict: PASS	
Date(s): 23-Dec-18			
Temperature: 24.3 °C	Relative Humidity: 48 %	Air Pressure: 1009 hPa	Power: 48 VDC
Remarks:			

Plot 7.6.1 Spurious emission measurements in 9 - 150 kHz range at low carrier frequency

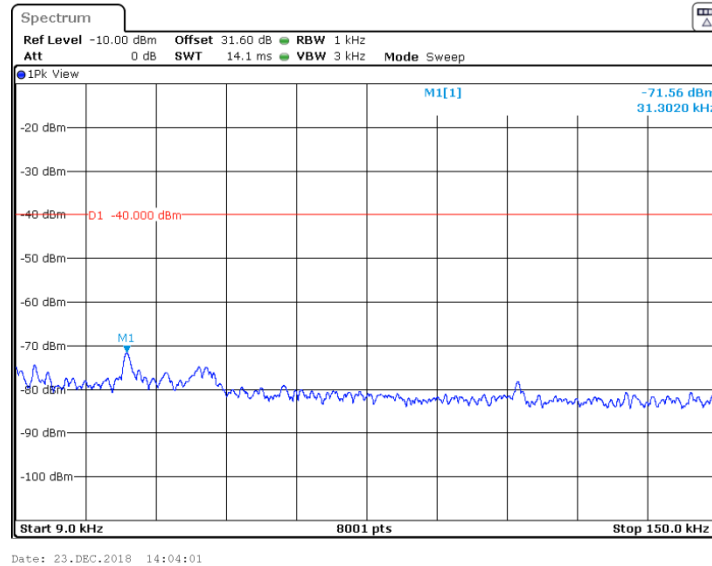

Plot 7.6.2 Spurious emission measurements in 9 - 150 kHz range at mid carrier frequency

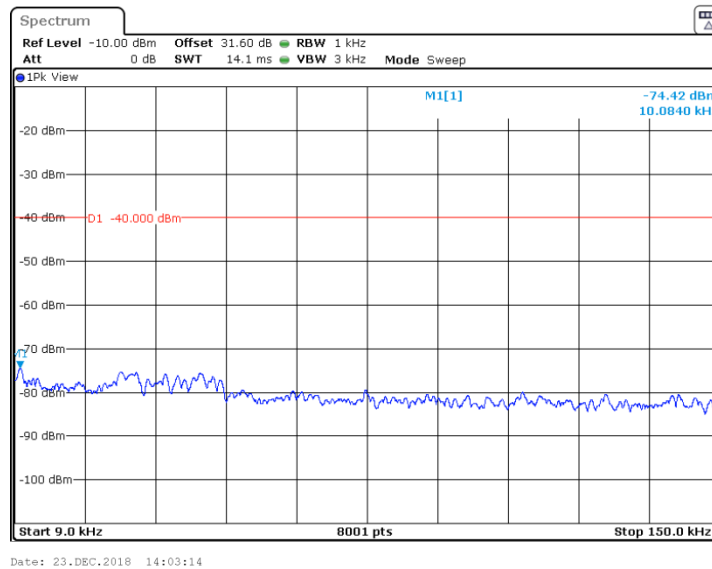



Test specification: Section 96.41(e)(3), Conducted spurious emissions			
Test procedure: Section 96.41(e)(3)			
Test mode: Compliance		Verdict: PASS	
Date(s): 23-Dec-18			
Temperature: 24.3 °C	Relative Humidity: 48 %	Air Pressure: 1009 hPa	Power: 48 VDC
Remarks:			

Plot 7.6.3 Spurious emission measurements in 9 - 150 kHz range at high carrier frequency

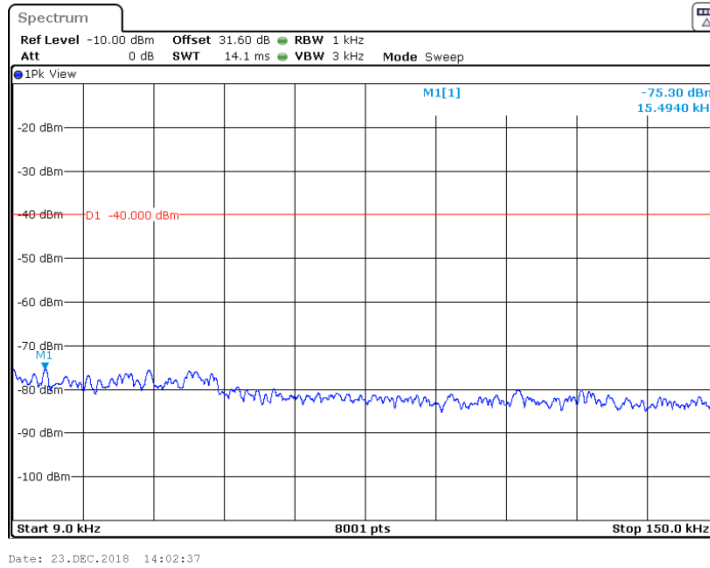

Plot 7.6.4 Spurious emission measurements in 0.15 – 1 MHz range at low carrier frequency

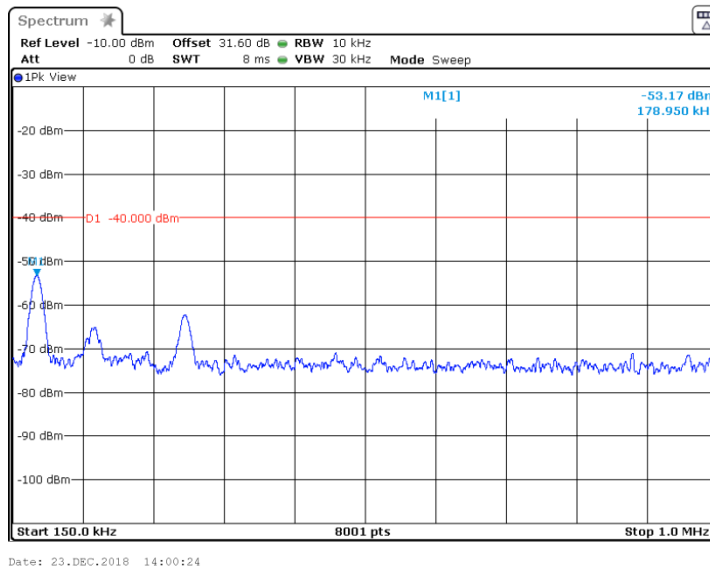



Test specification: Section 96.41(e)(3), Conducted spurious emissions			
Test procedure: Section 96.41(e)(3)			
Test mode: Compliance		Verdict: PASS	
Date(s): 23-Dec-18			
Temperature: 24.3 °C	Relative Humidity: 48 %	Air Pressure: 1009 hPa	Power: 48 VDC
Remarks:			

Plot 7.6.5 Spurious emission measurements in 0.15 - 1MHz range at mid carrier frequency

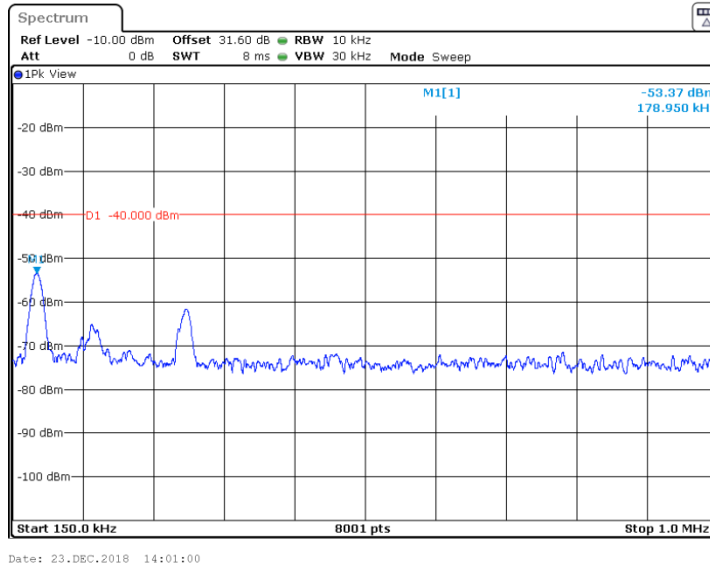

Plot 7.6.6 Spurious emission measurements in 0.15 – 1MHz range at high carrier frequency

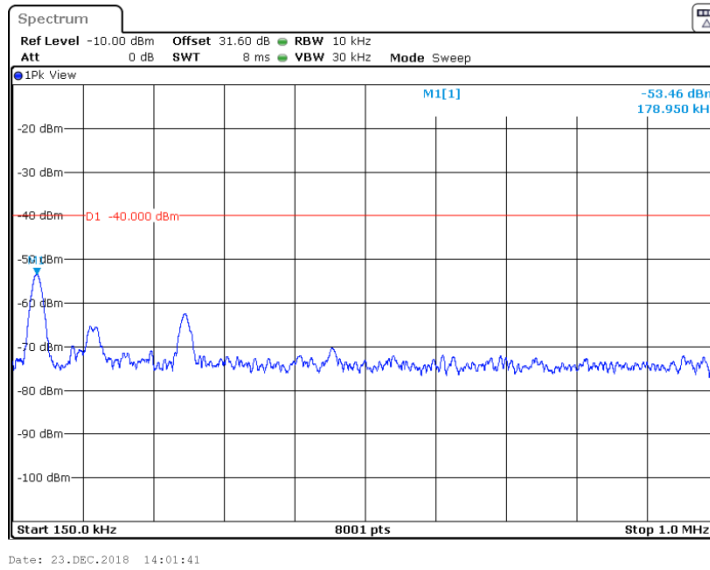



Test specification: Section 96.41(e)(3), Conducted spurious emissions			
Test procedure: Section 96.41(e)(3)			
Test mode: Compliance		Verdict: PASS	
Date(s): 23-Dec-18			
Temperature: 24.3 °C	Relative Humidity: 48 %	Air Pressure: 1009 hPa	Power: 48 VDC
Remarks:			

Plot 7.6.7 Spurious emission measurements in 1- 30.0 MHz range at low carrier frequency

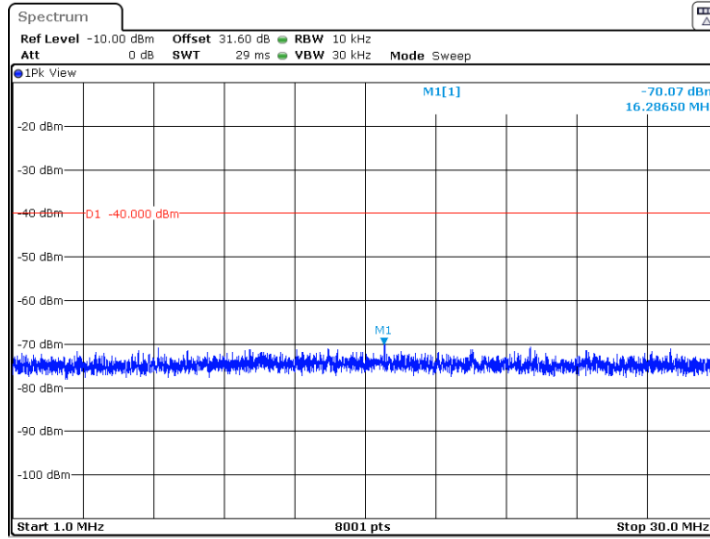

Date: 23.DEC.2018 13:59:42

Plot 7.6.8 Spurious emission measurements in 1- 30.0 MHz range at mid carrier frequency

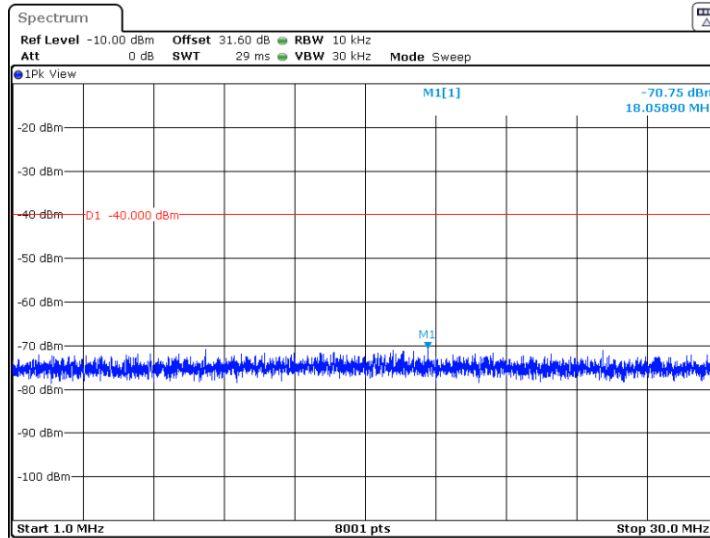

Date: 23.DEC.2018 13:59:11



Test specification: Section 96.41(e)(3), Conducted spurious emissions			
Test procedure: Section 96.41(e)(3)			
Test mode: Compliance		Verdict: PASS	
Date(s): 23-Dec-18			
Temperature: 24.3 °C	Relative Humidity: 48 %	Air Pressure: 1009 hPa	Power: 48 VDC
Remarks:			

Plot 7.6.9 Spurious emission measurements in 1 – 30.0 MHz range at high carrier frequency

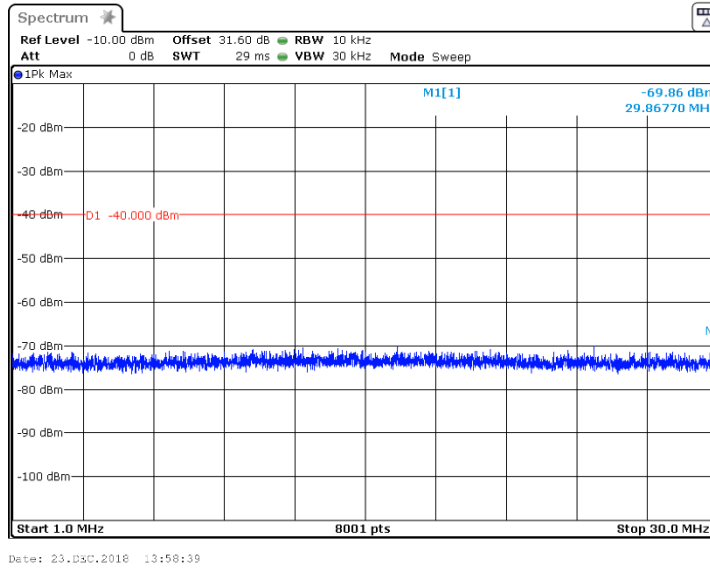

Plot 7.6.10 Spurious emission measurements in 30.0 - 1000 MHz range at low carrier frequency

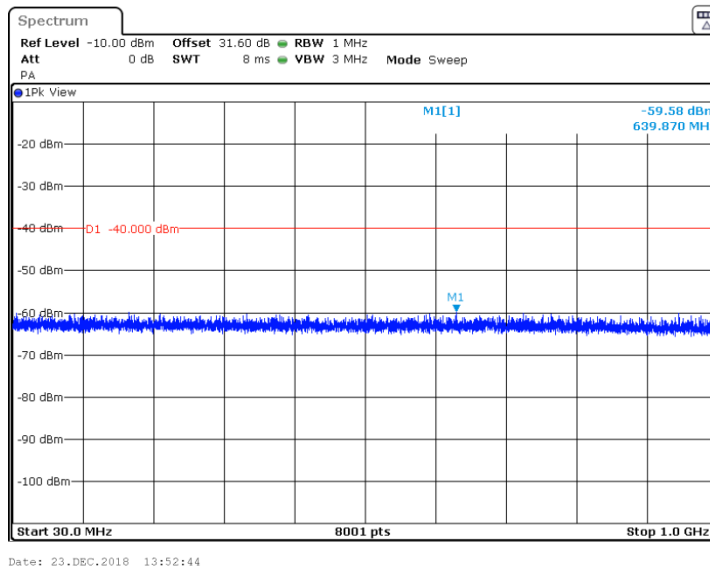



HERMON LABORATORIES

Test specification: Section 96.41(e)(3), Conducted spurious emissions			
Test procedure: Section 96.41(e)(3)			
Test mode: Compliance		Verdict: PASS	
Date(s): 23-Dec-18			
Temperature: 24.3 °C	Relative Humidity: 48 %	Air Pressure: 1009 hPa	Power: 48 VDC
Remarks:			

Plot 7.6.11 Spurious emission measurements in 30.0 - 1000 MHz range at mid carrier frequency

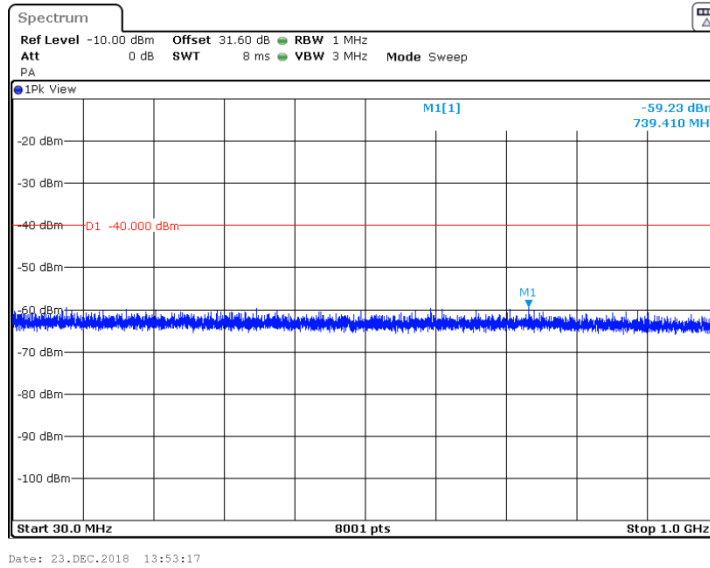

Plot 7.6.12 Spurious emission measurements in 30.0 - 1000 MHz range at high carrier frequency

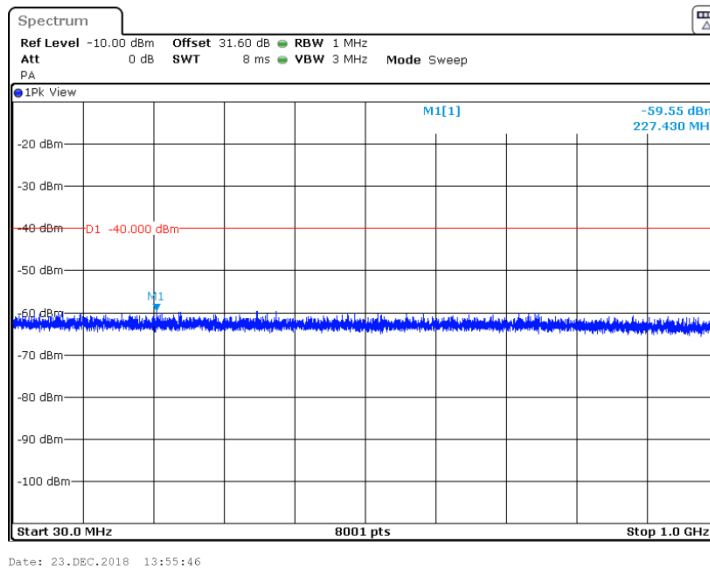



Test specification: Section 96.41(e)(3), Conducted spurious emissions			
Test procedure: Section 96.41(e)(3)			
Test mode: Compliance		Verdict: PASS	
Date(s): 23-Dec-18			
Temperature: 24.3 °C	Relative Humidity: 48 %	Air Pressure: 1009 hPa	Power: 48 VDC
Remarks:			

Plot 7.6.13 Spurious emission measurements in 1000 - 3500 MHz range at low carrier frequency

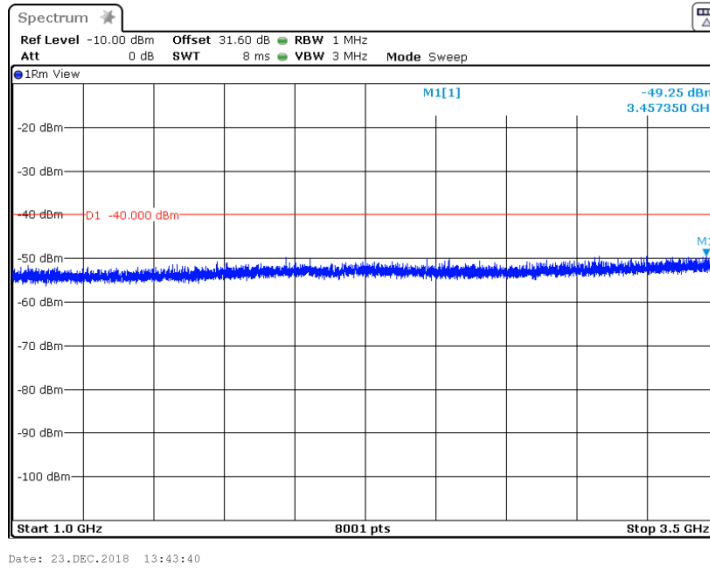

Plot 7.6.14 Spurious emission measurements in 1000 - 3500 MHz at mid carrier frequency

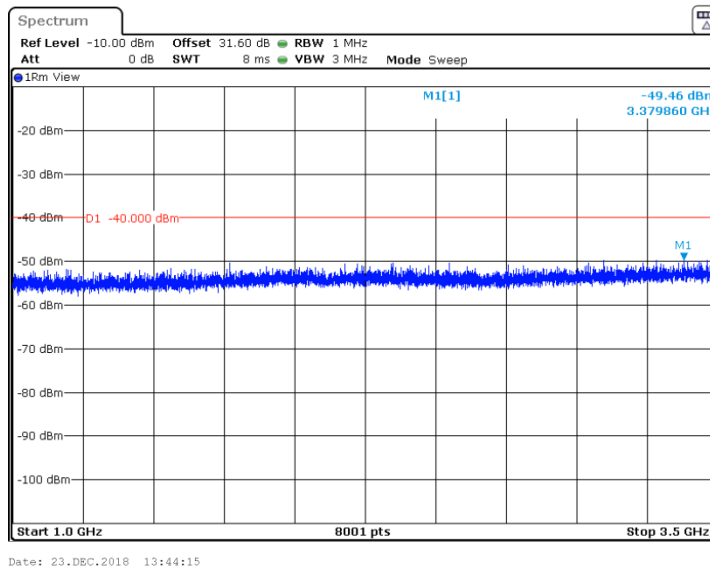



Test specification: Section 96.41(e)(3), Conducted spurious emissions			
Test procedure: Section 96.41(e)(3)			
Test mode: Compliance		Verdict: PASS	
Date(s): 23-Dec-18			
Temperature: 24.3 °C	Relative Humidity: 48 %	Air Pressure: 1009 hPa	Power: 48 VDC
Remarks:			

Plot 7.6.15 Spurious emission measurements in 1000 - 3500 MHz at high carrier frequency

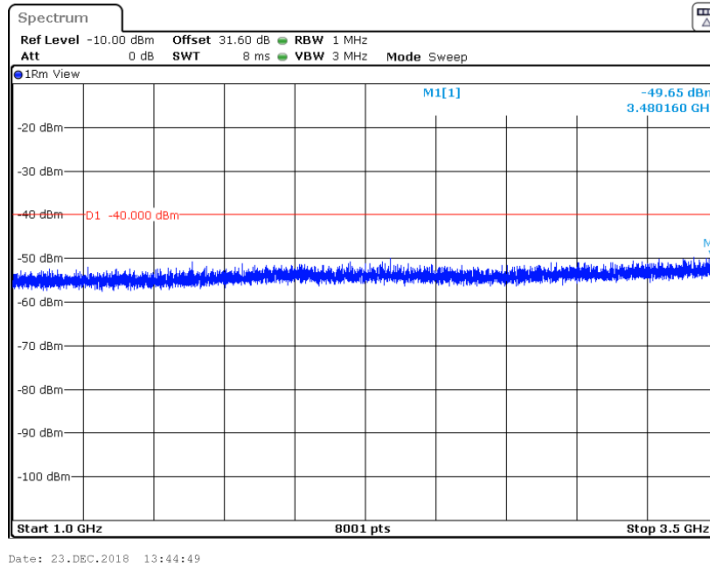

Plot 7.6.16 Spurious emission measurements in 3500 - 3530 MHz range at low carrier frequency

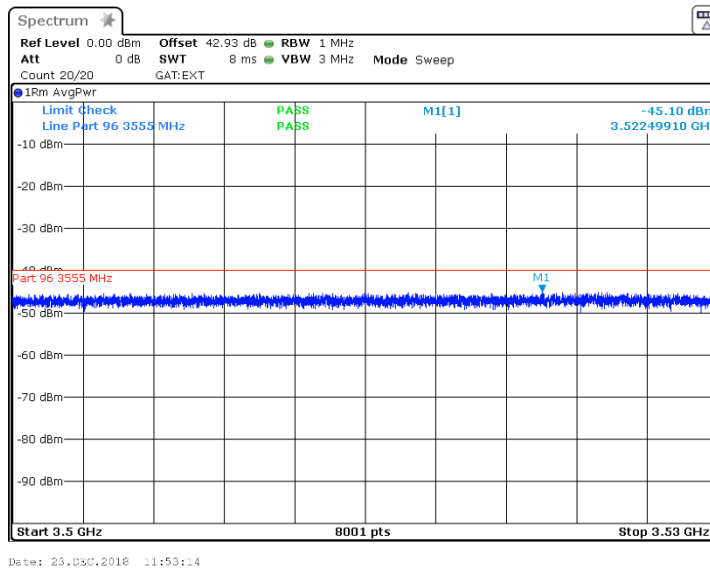



Test specification: Section 96.41(e)(3), Conducted spurious emissions			
Test procedure: Section 96.41(e)(3)			
Test mode: Compliance		Verdict: PASS	
Date(s): 23-Dec-18			
Temperature: 24.3 °C	Relative Humidity: 48 %	Air Pressure: 1009 hPa	Power: 48 VDC
Remarks:			

Plot 7.6.17 Spurious emission measurements in 3500 - 3600 MHz at mid carrier frequency

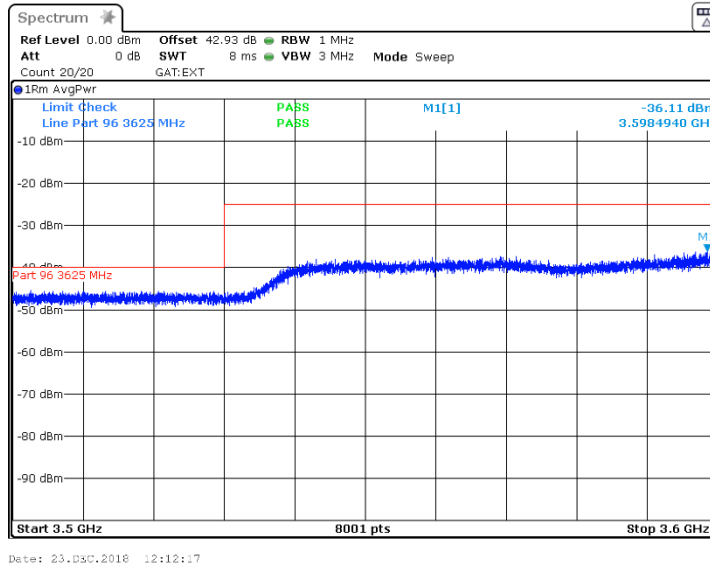

Plot 7.6.18 Spurious emission measurements in 3500 - 3680 MHz at high carrier frequency

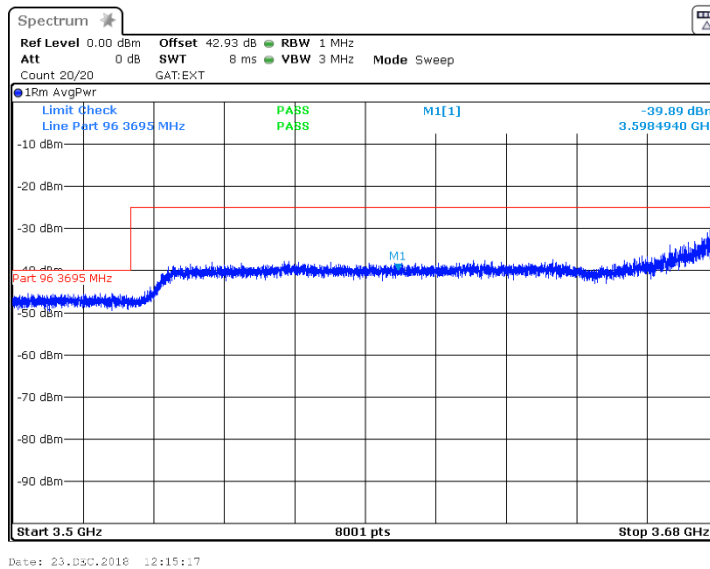



Test specification: Section 96.41(e)(3), Conducted spurious emissions			
Test procedure: Section 96.41(e)(3)			
Test mode: Compliance		Verdict: PASS	
Date(s): 23-Dec-18			
Temperature: 24.3 °C	Relative Humidity: 48 %	Air Pressure: 1009 hPa	Power: 48 VDC
Remarks:			

Plot 7.6.19 Spurious emission measurements in 3580 - 3800 MHz range at low carrier frequency

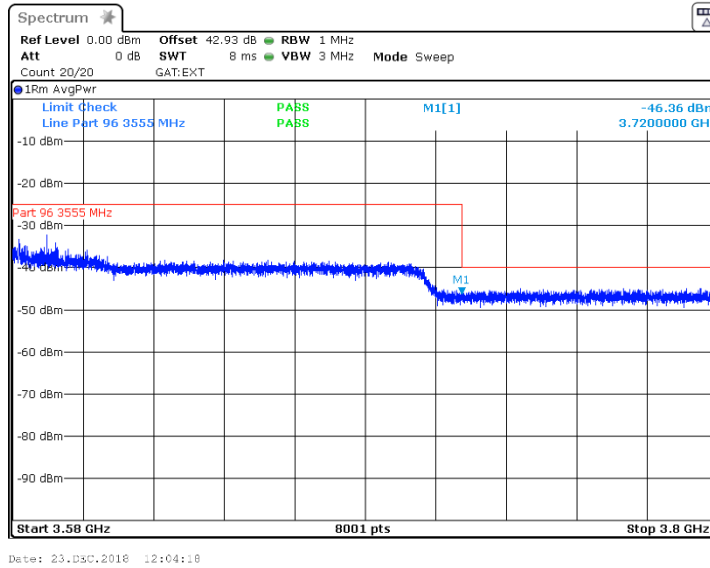

Plot 7.6.20 Spurious emission measurements in 3650 - 3800 MHz range at mid carrier frequency

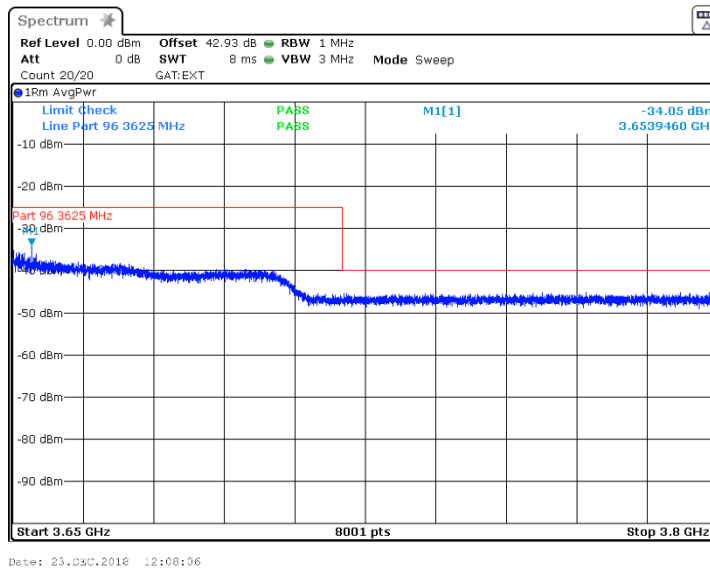



Test specification: Section 96.41(e)(3), Conducted spurious emissions			
Test procedure: Section 96.41(e)(3)			
Test mode: Compliance		Verdict: PASS	
Date(s): 23-Dec-18			
Temperature: 24.3 °C	Relative Humidity: 48 %	Air Pressure: 1009 hPa	Power: 48 VDC
Remarks:			

Plot 7.6.21 Spurious emission measurements in 3720 – 3800 MHz range at high carrier frequency

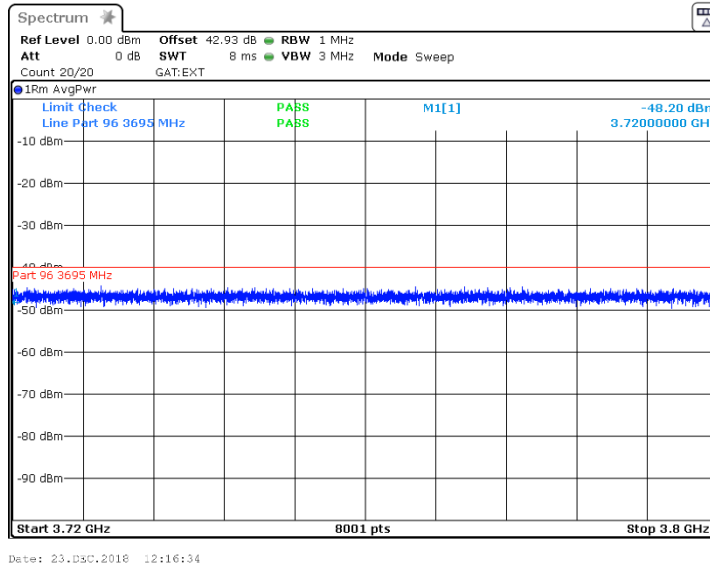

Plot 7.6.22 Spurious emission measurements in 3800 - 6000 MHz range at low carrier frequency

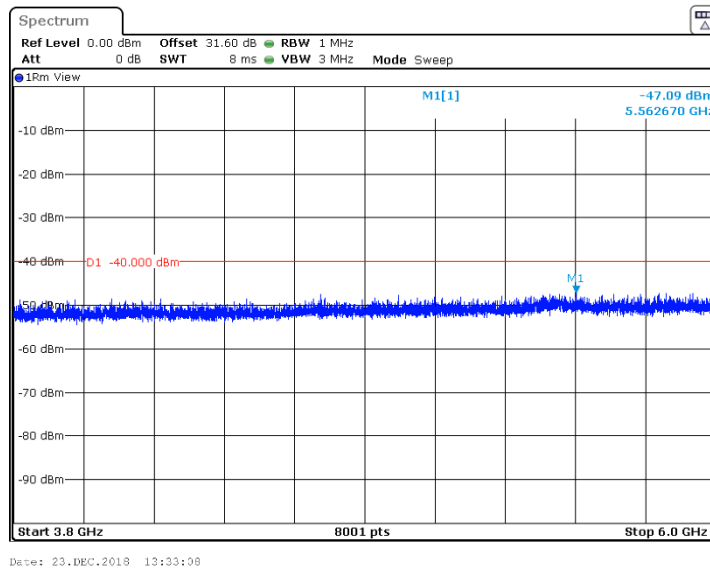



Test specification: Section 96.41(e)(3), Conducted spurious emissions			
Test procedure: Section 96.41(e)(3)			
Test mode: Compliance		Verdict: PASS	
Date(s): 23-Dec-18			
Temperature: 24.3 °C	Relative Humidity: 48 %	Air Pressure: 1009 hPa	Power: 48 VDC
Remarks:			

Plot 7.6.23 Spurious emission measurements in 3800 - 6000 MHz at mid carrier frequency

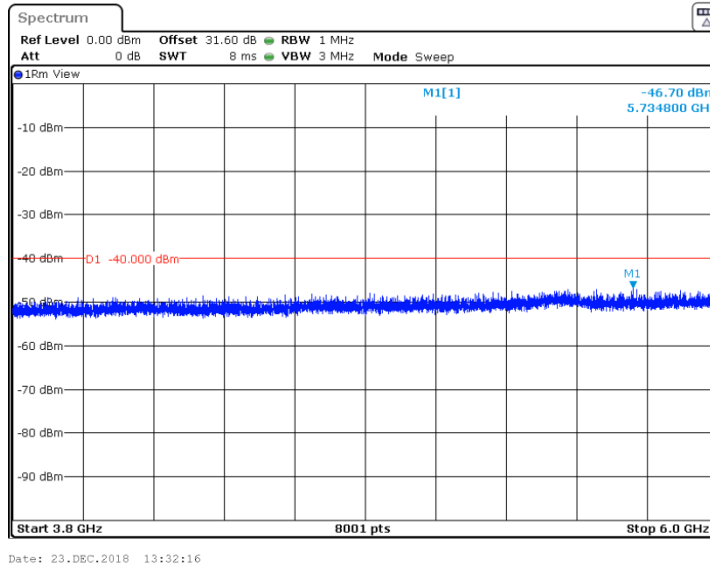

Plot 7.6.24 Spurious emission measurements in 3800 - 6000 MHz at high carrier frequency

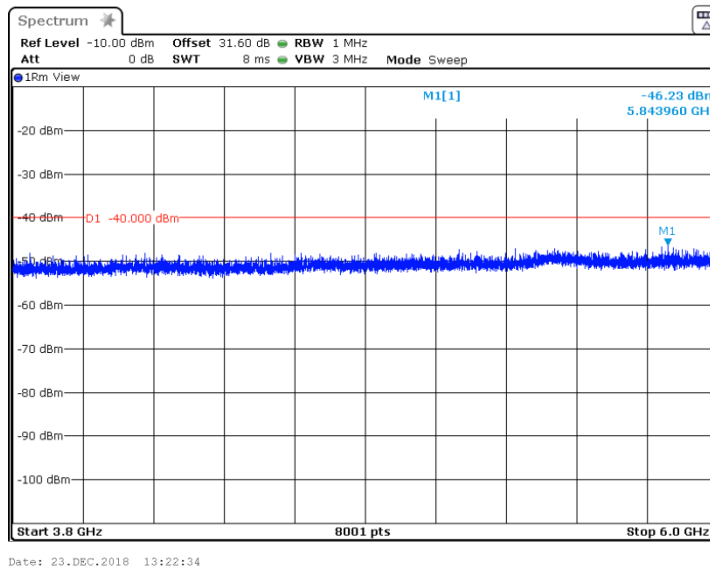



Test specification: Section 96.41(e)(3), Conducted spurious emissions			
Test procedure: Section 96.41(e)(3)			
Test mode: Compliance		Verdict: PASS	
Date(s): 23-Dec-18			
Temperature: 24.3 °C	Relative Humidity: 48 %	Air Pressure: 1009 hPa	Power: 48 VDC
Remarks:			

Plot 7.6.25 Spurious emission measurements in 18000 - 26500 MHz range at low carrier frequency

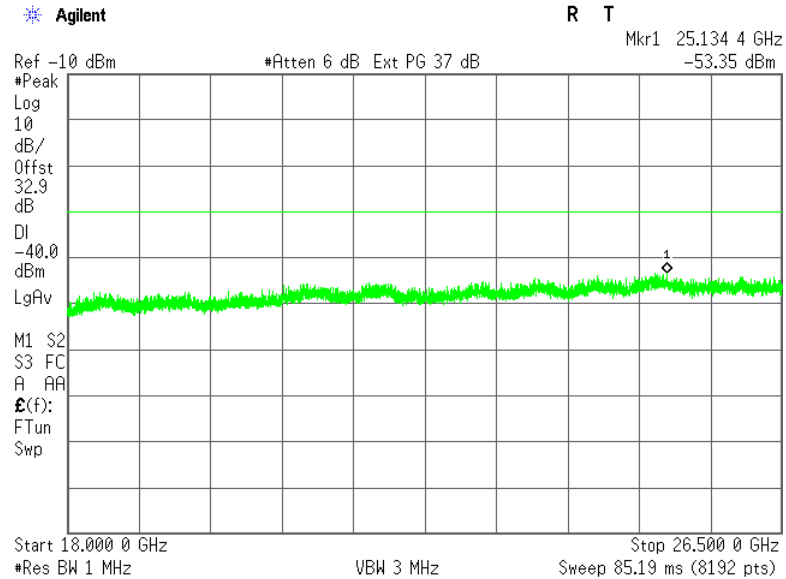

Plot 7.6.26 Spurious emission measurements in 18000 - 26500 MHz at mid carrier frequency

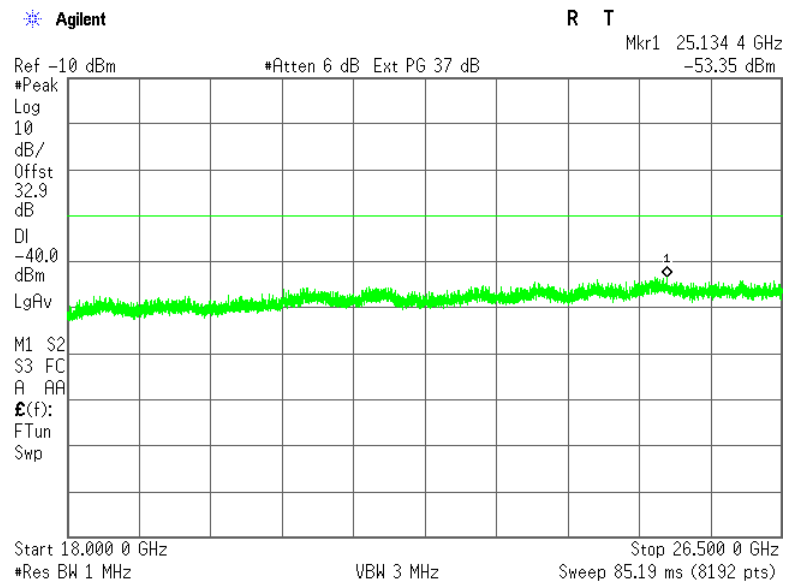



Test specification: Section 96.41(e)(3), Conducted spurious emissions			
Test procedure: Section 96.41(e)(3)			
Test mode: Compliance		Verdict: PASS	
Date(s): 23-Dec-18			
Temperature: 24.3 °C	Relative Humidity: 48 %	Air Pressure: 1009 hPa	Power: 48 VDC
Remarks:			

Plot 7.6.27 Spurious emission measurements in 18000 - 26500 MHz at high carrier frequency

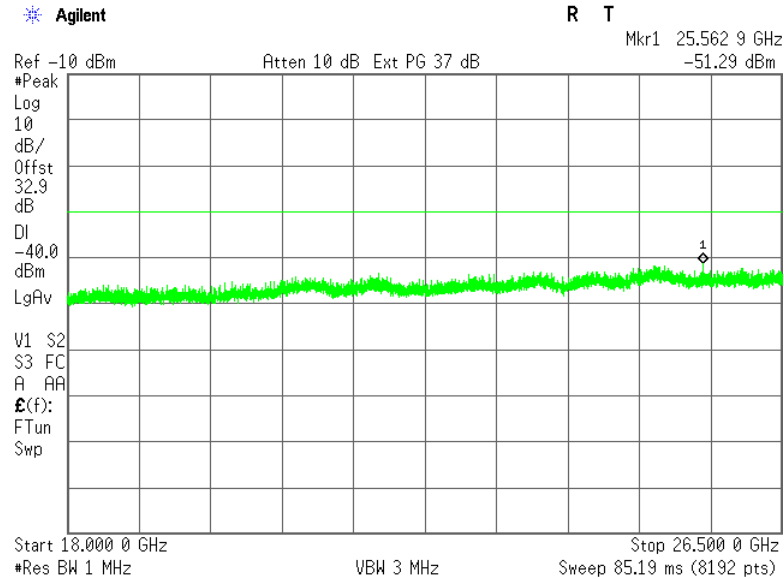

Plot 7.6.28 Spurious emission measurements in 26500 - 37000 MHz range at low carrier frequency

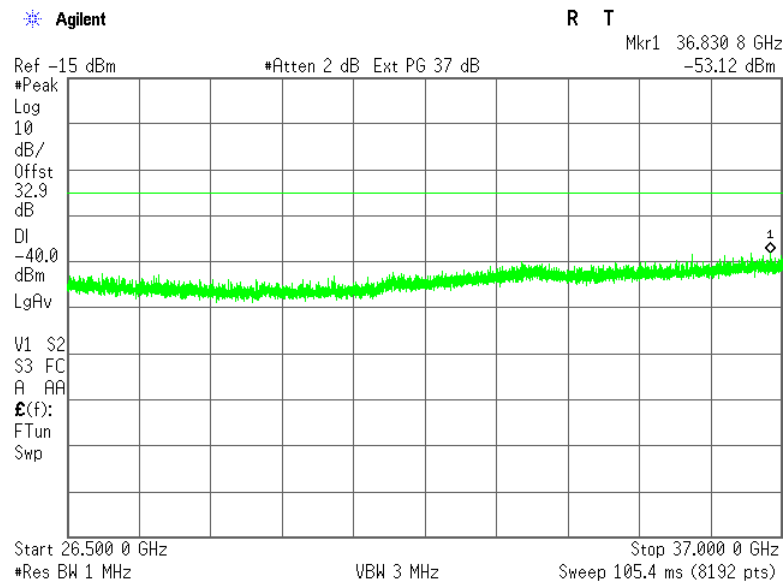



Test specification: Section 96.41(e)(3), Conducted spurious emissions			
Test procedure: Section 96.41(e)(3)			
Test mode: Compliance		Verdict: PASS	
Date(s): 23-Dec-18			
Temperature: 24.3 °C	Relative Humidity: 48 %	Air Pressure: 1009 hPa	Power: 48 VDC
Remarks:			

Plot 7.6.29 Spurious emission measurements in 26500 - 37000 MHz at mid carrier frequency

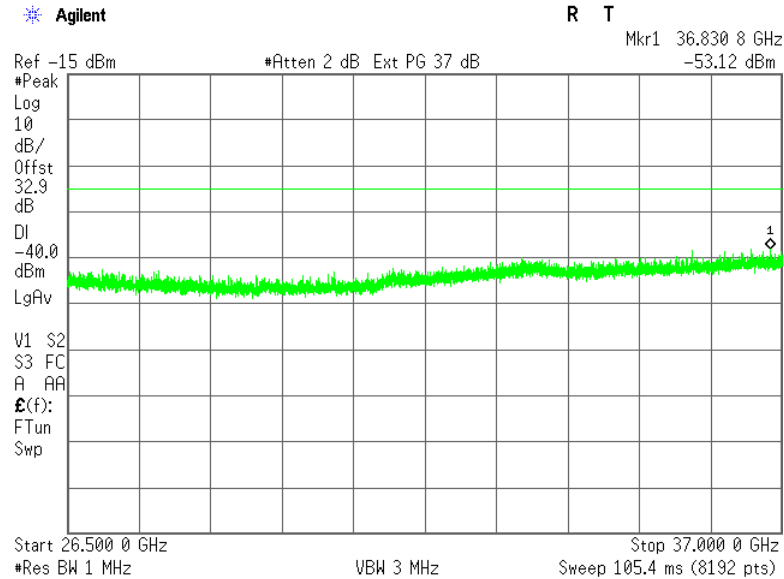

Plot 7.6.30 Spurious emission measurements in 26500 - 37000 MHz at high carrier frequency

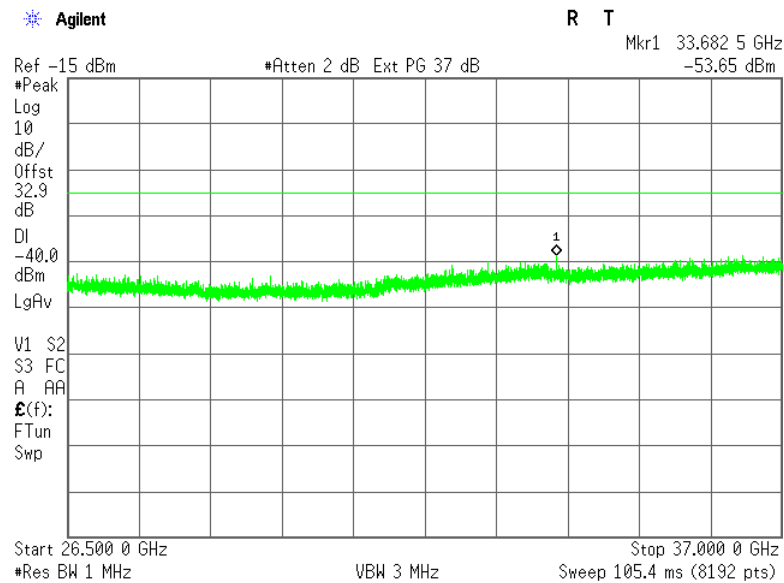



Test specification: Section 2.1055, Frequency stability			
Test procedure: 47 CFR, Section 2.1055			
Test mode: Compliance		Verdict: PASS	
Date(s): 03-Jan-19			
Temperature: 23 °C	Relative Humidity: 55 %	Air Pressure: 1008 hPa	Power: 48 VDC
Remarks:			

7.7 Frequency stability test

7.7.1 General

This test was performed to measure frequency stability of transmitter RF carrier. Specification test limits are given in Table 7.7.1.

Table 7.7.1 Frequency stability limits

Assigned frequency, MHz	Maximum allowed frequency displacement	
	ppm	Hz
3555.0	NA	NA
3625.0		NA
3695.0		NA

7.7.2 Test procedure

- 7.7.2.1 The EUT was set up as shown in Figure 7.7.1, energized and its proper operation was checked.
- 7.7.2.2 The EUT power was turned off. Temperature within test chamber was set to +30°C and a period of time sufficient to stabilize all of the oscillator circuit components was allowed.
- 7.7.2.3 The EUT was powered on and carrier frequency was measured at start up moment and then every minute until frequency had been stabilized or 10 minutes elapsed whichever reached the last. The EUT was powered off.
- 7.7.2.4 The above procedure was repeated at 0°C and at the lowest test temperature.
- 7.7.2.5 The EUT was powered on and carrier frequency was measured at start up moment and at the end of stabilization period at the rest of test temperatures and voltages. The EUT was powered off.
- 7.7.2.6 Frequency displacement was calculated and compared with the limit as provided in Table 7.7.2.

Figure 7.7.1 Frequency stability test setup

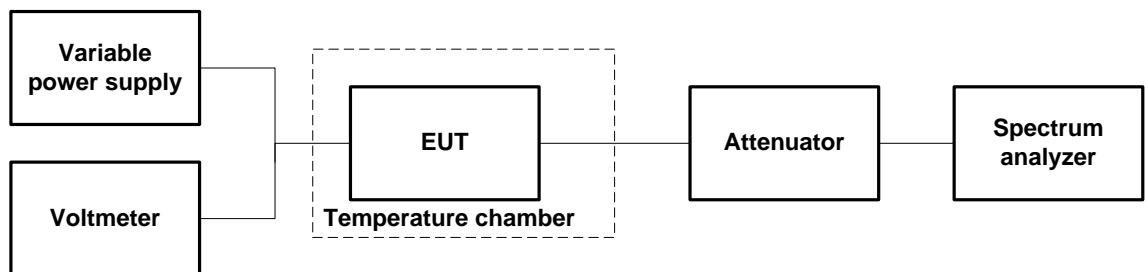



HERMON LABORATORIES

Test specification: Section 2.1055, Frequency stability			
Test procedure: 47 CFR, Section 2.1055			
Test mode: Compliance		Verdict: PASS	
Date(s): 03-Jan-19			
Temperature: 23 °C	Relative Humidity: 55 %	Air Pressure: 1008 hPa	Power: 48 VDC
Remarks:			

Table 7.7.2 Frequency stability test results

OPERATING FREQUENCY: 3550 – 3700 MHz
 NOMINAL POWER VOLTAGE: 48 VDC
 TEMPERATURE STABILIZATION PERIOD: 20 min
 POWER DURING TEMPERATURE TRANSITION: Off
 SPECTRUM ANALYZER MODE: Counter
 RESOLUTION BANDWIDTH: 1 kHz
 VIDEO BANDWIDTH: 1 kHz
 MODULATION: Unmodulated

T, °C	Voltage, V	Frequency, MHz							Max frequency drift, Hz		Verdict
		Start up	1 st min	2 nd min	3 rd min	4 th min	5 th min	10 th min	Positive	Negative	
Low frequency 3555.0 MHz											
-30	nominal	3555.00050	3555.00050	3555.00050	3555.00045	3555.00050	3555.00050	3555.00045	500	0	Comply
-20	nominal	3555.00055	NA	NA	NA	NA	NA	3555.00055	550	0	Comply
-10	nominal	3555.00055	NA	NA	NA	NA	NA	3555.00055	550	0	Comply
0	nominal	3555.0005	3555.00055	3555.00050	3555.00035	3555.00040	3555.00050	3555.00050	550	0	Comply
10	nominal	3555.00050	NA	NA	NA	NA	NA	3555.00045	500	0	Comply
20	15%	3554.99947	NA	NA	NA	NA	NA	3554.99922	0	-777	Comply
20	nominal	3554.99932	NA	NA	NA	NA	NA	3554.99889	0	-1114	Comply
20	-15%	3554.99932	NA	NA	NA	NA	NA	3554.99886	0	-1136	Comply
30	nominal	3554.99816	3555.00020	3555.00024	3555.00015	3555.00019	3555.00017	3555.00019	242	-1841	Comply
40	nominal	3554.99950	NA	NA	NA	NA	NA	3555.00055	550	-500	Comply
50	nominal	3555.00055	NA	NA	NA	NA	NA	3555.00050	550	0	Comply
Mid frequency 3625.0 MHz											
-30	nominal	3625.00055	3625.0005	3625.0005	3625.00055	3625.0005	3625.00045	3625.00045	550	0	Comply
-20	nominal	3625.00055	NA	NA	NA	NA	NA	3625.00045	550	0	Comply
-10	nominal	3624.99950	NA	NA	NA	NA	NA	3625.00055	550	-450	Comply
0	nominal	3625.00060	3625.00055	3625.0005	3625.00055	3625.0006	3625.0006	3625.0006	600	0	Comply
10	nominal	3625.00045	NA	NA	NA	NA	NA	3625.00045	450	0	Comply
20	15%	3624.99916	NA	NA	NA	NA	NA	3624.99929	0	-838	Comply
20	nominal	3624.99931	NA	NA	NA	NA	NA	3624.99948	0	-693	Comply
20	-15%	3624.99913	NA	NA	NA	NA	NA	3624.99926	0	-868	Comply
30	nominal	3624.99989	3625.00013	3625.00016	3625.00010	3625.00013	3625.00011	3625.00013	164	-110	Comply
40	nominal	3625.0005	NA	NA	NA	NA	NA	3625.0006	600	0	Comply
50	nominal	3625.00055	NA	NA	NA	NA	NA	3625.0004	550	0	Comply
High frequency 3695.0 MHz											
-30	nominal	3695.0005	3695.00050	3695.00055	3695.00055	3695.00055	3695.00055	3695.00055	550	0	Comply
-20	nominal	3695.00045	NA	NA	NA	NA	NA	3695.00055	550	0	Comply
-10	nominal	3695.00050	NA	NA	NA	NA	NA	3695.0006	600	0	Comply
0	nominal	3695.00045	3695.00045	3695.0005	3695.00055	3695.00055	3695.00055	3695.00055	550	0	Comply
10	nominal	3695.00040	NA	NA	NA	NA	NA	3695.00055	550	0	Comply
20	15%	3694.99921	NA	NA	NA	NA	NA	3694.99947	0	-793	Comply
20	nominal	3694.99921	NA	NA	NA	NA	NA	3694.99954	0	-337	Comply
20	-15%	3694.99951	NA	NA	NA	NA	NA	3694.99940	0	-598	Comply
30	nominal	3694.99905	3694.99928	3695.00021	3695.00017	3695.00018	3695.00016	3695.00012	210	-720	Comply
40	nominal	3695.00045	NA	NA	NA	NA	NA	3695.00045	450	0	Comply
50	nominal	3695.00045	NA	NA	NA	NA	NA	3695.0004	450	0	Comply

* - Reference frequency

Reference numbers of test equipment used

HL 2909	HL 2358	HL 5391					
---------	---------	---------	--	--	--	--	--

Full description is given in Appendix A.

**8 APPENDIX A Test equipment and ancillaries used for tests**

HL No	Description	Manufacturer	Model	Ser. No.	Last Cal./ Check	Due Cal./ Check
0446	Antenna, Loop, Active, 9 kHz - 30 MHz	EMCO	6502	2857	24-Feb-19	24-Feb-20
2358	Power Supply, 2 X 0-36VDC / 5A, 5VDC / 5A	Horizon Electronics	DHR3655 D	767469	03-Jun-18	03-Jun-19
2909	Spectrum analyzer, ESA-E, 100 Hz to 26.5 GHz	Agilent Technologies	E4407B	MY414447 62	27-Mar-18	27-Mar-19
3287	Low pass filter, DC-3.0 GHz	Unknown	NA	3287	01-Oct-17	01-Oct-19
3301	Power Meter, P-series, 50 MHz to 40 GHz	Agilent Technologies	N1911A	MY451010 57	02-May-18	02-May-19
3302	Power sensor, P-Series, 50 MHz to 40 GHz, -35/30 to 20 dBm	Agilent Technologies	N1922A	MY452405 86	02-May-18	02-May-19
3433	Test Cable , DC-18 GHz, 1.5 m, SMA - SMA	Mini-Circuits	CBL-5FT-SMSM+	25679	28-Mar-18	28-Mar-19
3434	Test Cable , DC-18 GHz, 1.5 m, SMA - SMA	Mini-Circuits	CBL-5FT-SMSM+	25683	28-Mar-18	28-Mar-19
3818	PSA Series Spectrum Analyzer, 3 Hz- 44 GHz	Agilent Technologies	E4446A	MY482502 88	28-May-18	28-May-19
3903	Microwave Cable Assembly, 40.0 GHz, 1.5 m, SMA/SMA	Huber-Suhner	SUCOFL EX 102A	1226/2A	07-Feb-18	07-Mar-19
4342	High Pass Filter, 50 Ohm, 10.6 to 26.5 GHz, SMA-M / SMA-FM	RLC Electronics	F-5738A	8425	17-May-18	17-May-19
4355	Signal and Spectrum Analyzer, 9 kHz to 7 GHz	Rohde & Schwarz	FSV 7	101630	28-Jun-18	28-Sep-19
4360	EMI Test Receiver, 20 Hz to 40 GHz.	Rohde & Schwarz	ESU40	100322	31-Dec-18	31-Dec-19
4366	Directional coupler, 1 GHz to 18 GHz, 10 dB, SMA Female	Tiger Micro-Electronics Institute	TGD-A1101-10	01e-JSDE805-007	21-May-18	21-May-20
4933	Active Horn Antenna, 1 GHz to 18 GHz	Com-Power Corporation	AHA-118	701046	06-Jan-19	06-Jan-20
4956	Active horn antenna, 18 to 40 GHz	Com-Power Corporation	AHA-840	105004	25-Jan-19	25-Jan-20
5111	RF cable, 40 GHz, 5.5 m, K-type	Huber-Suhner	SF102EA/11SK/11SK/5500M M	502493/2E A	09-Apr-18	09-Apr-19
5174	Medium Power Fixed Coaxial Attenuator DC to 40 GHz, 10 dB, 5 W	API Weinschel, Inc	75A-10-12	TD854	07-Feb-18	07-Feb-19
5175	Medium Power Fixed Coaxial Attenuator DC to 40 GHz, 20 dB, 5 W	API Weinschel, Inc	75A-20-12	TE289	07-Feb-18	07-Feb-19
5286	Band Pass Filter, 50 Ohm, 4.4 to 18 GHz, SMA/M-SMA/F	A-INFOMW	WBLB-T-HP-4.4-18-S	J10800000 305	28-Mar-18	28-Mar-19
5288	Trilog Antenna, 25 MHz - 8 GHz, 100W	Frankonia	ALX-8000E	00809	08-Feb-19	08-Feb-22



HERMON LABORATORIES

Report ID: AIRRAD_FCC.31875_rev3
Date of Issue: 31-Oct-19

HL No	Description	Manufacturer	Model	Ser. No.	Last Cal./ Check	Due Cal./ Check
5391	Temperature/Humidity Cycle Chamber, -77 - +177 deg., Humidity Range 20% RH to 95% RH	Thermotron	SM-8C	27737	22-Jul-18	22-Jul-19
5405	RF cable, 18 GHz, N-N, 6 m	Huber-Suhner	SF118/11 N(x2)	500023/118	01-Aug-18	01-Aug-19



9 APPENDIX B Measurement uncertainties

Expanded uncertainty at 95% confidence in Hermon Labs EMC measurements

Test description	Expanded uncertainty
Transmitter tests	
Carrier power conducted at antenna connector	± 1.7 dB
Carrier power radiated (substitution method)	± 4.5 dB
Occupied bandwidth	±8%
Conducted emissions at RF antenna connector	9 kHz to 2.9 GHz: ± 2.6 dB 2.9 GHz to 6.46 GHz: ± 3.5 dB 6.46 GHz to 13.2 GHz: ± 4.3 dB 13.2 GHz to 22.0 GHz: ± 5.0 dB 22.0 GHz to 26.8 GHz: ± 5.5 dB 26.8 GHz to 40.0 GHz: ± 4.8 dB
Spurious emissions radiated 30 MHz – 40 GHz (substitution method)	± 4.5 dB
Frequency error	30 – 300 MHz: ± 50.5 Hz (1.68 ppm) 300 – 1000 MHz: ± 168 Hz (0.56 ppm)
Transient frequency behaviour	187 Hz ± 13.9 %
Duty cycle, timing (Tx ON / OFF) and average factor measurements	± 1.0 %
Unintentional radiator tests	
Conducted emissions with LISN	9 kHz to 150 kHz: ± 3.9 dB 150 kHz to 30 MHz: ± 3.8 dB
Radiated emissions at 3 m measuring distance Horizontal polarization	Biconilog antenna: ± 5.3 dB Biconical antenna: ± 5.0 dB Log periodic antenna: ± 5.3 dB Double ridged horn antenna: ± 5.3 dB
Vertical polarization	Biconilog antenna: ± 6.0 dB Biconical antenna: ± 5.7 dB Log periodic antenna: ± 6.0 dB Double ridged horn antenna: ± 6.0 dB

Hermon Laboratories is accredited by A2LA for calibration according to present requirements of ISO/IEC 17025 and NCSL Z540-1. The accreditation is granted to perform calibration of parameters that are listed in the Scope of Hermon Laboratories Accreditation.

Hermon Laboratories calibrates its reference and transfer standards by calibration laboratories accredited to ISO/IEC 17025 by a mutually recognized Accreditation Body or by a recognized national metrology institute. All reference and transfer standards used in the calibration system are traceable to national or international standards.

In-house calibration of all test and measurement equipment is performed on a regular basis according to Hermon Laboratories calibration procedures, manufacturer calibration/verification procedures or procedures defined in the relevant standards. The Hermon Laboratories test and measurement equipment is calibrated within the tolerances specified by the manufacturers and/or by the relevant standards.



10 APPENDIX C Test facility description

Tests were performed at Hermon Laboratories Ltd., which is a fully independent, private, EMC, Radio, Safety, Environmental and Telecommunication testing facility.

Hermon Laboratories is recognized and accredited by the Federal Communications Commission (USA) for relevant parts of Code of Federal Regulations 47 (CFR 47), Test Firm Registration Number is 927748, Designation Number is IL1001; Recognized by Innovation, Science and Economic Development Canada for wireless and terminal testing (ISED), ISED #2186A, CAB identifier is IL1001; Certified by VCCI, Japan (the registration numbers are R-10808 for OATS, R-1082 for anechoic chamber, G-10869 for RE measurements above 1 GHz, C-10845 for conducted emissions site and T-11606 for conducted emissions at telecommunication ports).

The laboratory is accredited by American Association for Laboratory Accreditation (USA) according to ISO/IEC 17025 for electromagnetic compatibility, product safety, telecommunications testing, environmental simulation and calibration (for exact scope please refer to Certificate No. 839.01, 839.03 and 839.04).

Address: P.O. Box 23, Binyamina 3055001, Israel.
Telephone: +972 4628 8001
Fax: +972 4628 8277
e-mail: mail@hermonlabs.com
website: www.hermonlabs.com

Person for contact: Mr. Michael Nikishin, EMC&Radio group manager

11 APPENDIX D Specification references

FCC 47CFR part 96: 2017	Citizens Broadband Radio Service
FCC 47CFR part 1: 2017	Practice and procedure
FCC 47CFR part 2: 2017	Frequency allocations and radio treaty matters; general rules and regulations
ANSI C63.26:2015	American National Standard for Compliance Testing of Transmitters Used in Licensed Radio Services
ANSI C63.2: 1996	American National Standard for Instrumentation-Electromagnetic Noise and Field Strength, 10 kHz to 40 GHz-Specifications.
ANSI C63.4: 2014	American National Standard for Methods of Measurement of Radio-Noise Emissions from Low-Voltage Electrical and Electronic Equipment in the Range of 9 kHz to 40 GHz.
KDB 971168 D01 v03r01	Measurement Guidance for Certification of Licensed Digital Transmitters
KDB 940660 D01 v01	Certification and Test Procedures for Citizens Broadband Radio Service Devices Authorized under Part 96
KDB 662911 D01 v02r01	Emissions Testing of Transmitters with Multiple Outputs in the Same Band
KDB 662911 D02 v01	MIMO with Cross-Polarized Antenna



12 APPENDIX E Test equipment correction factors

Antenna factor
Active loop antenna
Model 6502, S/N 2857, HL 0446

Frequency, MHz	Measured antenna factor, dBS/m
0.009	-32.5
0.010	-33.4
0.020	-37.9
0.050	-40.6
0.075	-41.0
0.100	-41.2
0.150	-41.2
0.250	-41.2
0.500	-41.3
0.750	-41.3
1.000	-41.4
2.000	-41.4
3.000	-41.4
4.000	-41.5
5.000	-41.5
10.000	-41.8
15.000	-42.2
20.000	-42.9
25.000	-43.9
30.000	-45.4

Antenna factor is to be added to receiver meter reading in dB(μ V) to convert it into field strength in dB(μ V/m).



Antenna factor
Trilog antenna
Model ALX-8000E, Frankonia, S/N 00809, HL 5288, 30-1000 MHz

Frequency, MHz	Antenna factor, dB/m		
	Vert Up	Vert Down	Delta
30	-51.19	-51.28	0.09
35	-44.03	-44.12	0.09
40	-43.07	-43.12	0.05
45	-39.61	-39.79	0.18
50	-37.84	-38.14	0.3
60	-34.93	-34.9	0.03
70	-29.76	-29.66	0.1
80	-27.69	-27.82	0.13
90	-29.05	-29.07	0.02
100	-31.19	-31.19	0
120	-31.61	-31.6	0.01
140	-28.13	-28.06	0.07
160	-27.71	-27.75	0.04
180	-26.19	-26.15	0.04
200	-28.2	-28.15	0.05
250	-27.45	-27.47	0.02
300	-29.61	-29.63	0.02
400	-31.77	-31.78	0.01
500	-32.81	-32.81	0
600	-33.64	-33.61	0.03
700	-34.21	-34.21	0
800	-35.66	-35.66	0
900	-36.99	-36.91	0.08
1000	-38	-37.91	0.09

Antenna factor in dB(1/m) is to be added to receiver meter reading in dB(μ V) to convert it into field intensity in dB(μ V/m).



Antenna factor
Active Horn Antenna,
Com-Power Corporation, model: AHA-118, s/n 701046, HL 4933

Frequency, MHz	Measured antenna factor (with preamplifier), dB/m
1000	-16.1
1500	-15.1
2000	-10.9
2500	-11.9
3000	-11.1
3500	-10.6
4000	-8.6
4500	-8.3
5000	-5.9
5500	-5.7
6000	-3.3
6500	-4.0
7000	-2.2
7500	-1.7
8000	1.1
8500	-0.8
9000	-1.5
9500	-0.2

Frequency, MHz	Measured antenna factor (with preamplifier), dB/m
10000	1.8
10500	1.0
11000	0.3
11500	-0.5
12000	3.1
12500	1.4
13000	-0.3
13500	-0.4
14000	2.5
14500	2.2
15000	1.9
15500	0.5
16000	2.1
16500	1.2
17000	0.6
17500	3.1
18000	4.2

The antenna factor shall be added to receiver reading in dB μ V to obtain field strength in dB μ V/m.



Antenna factor
Active Horn Antenna,
Com-Power Corporation, model: AHA-840, s/n 105004, HL 4956

Frequency, MHz	Measured antenna factor (with preamplifier), dB/m
18000	2.5
18500	0.5
19000	-1.0
19500	-2.4
20000	-2.5
20500	-2.2
21000	-2.0
21500	-2.7
22000	-3.7
22500	-3.8
23000	-3.7
23500	-5.0
24000	-4.5
24500	-5.0
25000	-4.7
25500	-4.4
26000	-4.3
26500	-5.6
27000	-4.3
27500	-4.9
28000	-5.2
28500	-4.4

Frequency, MHz	Measured antenna factor (with preamplifier), dB/m
29000	-2.7
29500	-2.6
30000	-1.4
30500	-1.5
31000	-1.0
31500	-2.6
32000	-3.3
32500	-3.3
33000	-5.1
33500	-5.2
34000	-1.5
34500	-5.4
35000	-3.3
35500	-4.2
36000	-2.8
36500	-2.6
37000	-1.0
38000	1.8
38500	2.8
39000	1.3
39500	1.3
40000	0.3

The antenna factor shall be added to receiver reading in dB μ V to obtain field strength in dB μ V/m.



Cable loss
Test Cable, Mini-Circuits, CBL-5FT-SMSM+, SMA-SMA, 18 GHz, 1.5 m, S/N 25679
Mini-Circuits, HL 3433

Frequency, MHz	Cable loss, dB	Frequency, MHz	Cable loss, dB
10.0	0.06	9000	2.01
100	0.17	9500	2.06
500	0.41	10000	2.05
1000	0.58	10500	2.18
1500	0.72	11000	2.26
2000	0.86	11500	2.28
2500	0.96	12000	2.43
3000	1.04	12500	2.53
3500	1.13	13000	2.52
4000	1.23	13500	2.56
4500	1.31	14000	2.60
5000	1.41	14500	2.59
5500	1.49	15000	2.67
6000	1.55	15500	2.76
6500	1.63	16000	2.86
7000	1.71	16500	2.91
7500	1.78	17000	2.95
8000	1.86	17500	3.02
8500	1.92	18000	3.07



Cable loss
Test Cable, Mini-Circuits, CBL-5FT-SMSM+, SMA-SMA, 18 GHz, 1.5 m, S/N 25683
Mini-Circuits, HL 3434

Frequency, MHz	Cable loss, dB	Frequency, MHz	Cable loss, dB
10.0	0.06	9000	1.96
100	0.16	9500	2.01
500	0.40	10000	2.01
1000	0.57	10500	2.14
1500	0.72	11000	2.21
2000	0.85	11500	2.24
2500	0.95	12000	2.36
3000	1.03	12500	2.47
3500	1.11	13000	2.46
4000	1.21	13500	2.50
4500	1.29	14000	2.53
5000	1.39	14500	2.53
5500	1.46	15000	2.62
6000	1.52	15500	2.70
6500	1.60	16000	2.80
7000	1.68	16500	2.86
7500	1.75	17000	2.88
8000	1.83	17500	2.94
8500	1.88	18000	3.00



Cable loss
Microwave Cable Assembly, Huber-Suhner, 40 GHz, 1.5 m, SMA-SMA, S/N 1226/2A
HL 3903

Frequency, MHz	Cable loss, dB	Frequency, MHz	Cable loss, dB	Frequency, MHz	Cable loss, dB
10	-0.02	9500	1.84	21000	2.98
100	0.15	10000	1.86	22000	3.07
500	0.38	10500	1.93	23000	3.13
1000	0.56	11000	1.99	24000	3.21
1500	0.69	11500	2.04	25000	3.26
2000	0.82	12000	2.10	26000	3.48
2500	0.90	12500	2.15	27000	3.44
3000	0.98	13000	2.21	28000	3.53
3500	1.06	13500	2.25	29000	3.59
4000	1.11	14000	2.29	30000	3.66
4500	1.17	14500	2.34	31000	3.70
5000	1.24	15000	2.36	32000	3.79
5500	1.32	15500	2.40	33000	3.88
6000	1.40	16000	2.45	34000	3.94
6500	1.50	16500	2.48	35000	3.91
7000	1.56	17000	2.56	36000	4.05
7500	1.62	17500	2.58	37000	4.22
8000	1.68	18000	2.60	38000	4.25
8500	1.74	19000	2.84	39000	4.27
9000	1.78	20000	2.88	40000	4.33



HERMON LABORATORIES

Cable loss
RF Cable, Huber-Suhner, 18 GHz, 6 m,
SF118/11N(x2), S/N 500023/118
HL 5405

5405



Specific Test Report

Frequency Range [GHz]	IL min S21 [dB]	IL min S12 [dB]	RL max S11 [dB]	RL max S22 [dB]
0.040 - 1.836	-1.431	-1.431	-37.037	-37.704
1.836 - 3.632	-2.062	-2.066	-33.573	-32.848
3.632 - 5.428	-2.576	-2.576	-28.548	-29.602
5.428 - 7.224	-3.013	-3.014	-30.738	-32.523
7.224 - 9.020	-3.415	-3.416	-33.728	-32.257
9.020 - 10.816	-3.772	-3.772	-29.302	-30.735
10.816 - 12.612	-4.138	-4.138	-28.768	-26.255
12.612 - 14.408	-4.456	-4.462	-27.109	-26.151
14.408 - 16.204	-4.786	-4.786	-26.056	-27.116
16.204 - 18.000	-5.113	-5.111	-27.762	-28.508

Type: SF118/11N/11N/6000MM
Sales no.: 10497130
Serial no.: 500023 /118
PA no.: 1956306
Ring no.:
Cable length: 6 m
Test length:
Connector 1: SF_11_N-656
Connector 2: SF_11_N-656
Cable: SUCOFLEX_118
Meas. System: N5230C,MY49001834,A.09.42.22
Time: 7:04:21 AM
Date: 6/6/2018
Inspected by: AZ /111
Start Freq.: 0.04000 GHz
Stop Freq.: 18.00000 GHz
Meas Points: 801
Source Power: -5 dBm



13 APPENDIX F Abbreviations and acronyms

A	ampere
AC	alternating current
A/m	ampere per meter
AM	amplitude modulation
AVRG	average (detector)
BB	broad band
cm	centimeter
dB	decibel
dBm	decibel referred to one milliwatt
dB(μ V)	decibel referred to one microvolt
dB(μ V/m)	decibel referred to one microvolt per meter
dB(μ A)	decibel referred to one microampere
dB Ω	decibel referred to one Ohm
DC	direct current
EIRP	equivalent isotropically radiated power
ERP	effective radiated power
EUT	equipment under test
F	frequency
GHz	gigahertz
GND	ground
H	height
HL	Hermon laboratories
Hz	hertz
ITE	information technology equipment
k	kilo
kHz	kilohertz
LISN	line impedance stabilization network
LO	local oscillator
m	meter
MHz	megahertz
min	minute
mm	millimeter
ms	millisecond
μ s	microsecond
NA	not applicable
NB	narrow band
NT	not tested
OATS	open area test site
Ω	Ohm
QP	quasi-peak
PM	pulse modulation
PS	power supply
RE	radiated emission
RF	radio frequency
rms	root mean square
Rx	receive
s	second
T	temperature
Tx	transmit
V	volt
VA	volt-ampere

END OF DOCUMENT