

---

# Section 5

# Test Report

---

## TABLE OF CONTENTS

|            |   |           |
|------------|---|-----------|
| <b>5.1</b> | <b>Test Strategy.....</b>                                     | <b>2</b>  |
| <b>5.2</b> | <b>Test Equipment List .....</b>                              | <b>4</b>  |
| <b>5.3</b> | <b>RF Power Output .....</b>                                  | <b>5</b>  |
| 5.3.1.     | Conducted RF Power Output Test Results .....                  | 6         |
| 5.3.2.     | Conducted RF Power Output Plots .....                         | 7         |
| <b>5.4</b> | <b>Modulation Characteristics .....</b>                       | <b>16</b> |
| 5.4.1.     | Modulation Characteristics Test Results Summary .....         | 18        |
| 5.4.2.     | Modulation Characteristics Data Plots .....                   | 19        |
| <b>5.5</b> | <b>Occupied and Emission Bandwidth.....</b>                   | <b>20</b> |
| 5.5.1.     | Occupied and Emission Bandwidth Test Results Summary .....    | 21        |
| 5.5.2.     | Occupied and Emission Bandwidth Spectrum Analyzer Plots ..... | 21        |
| <b>5.6</b> | <b>Transmitter Spurious Emissions .....</b>                   | <b>25</b> |
| 5.6.1.     | Transmitter Spurious Emissions Plots.....                     | 26        |
| 5.6.2.     | Second Harmonic Emissions Plots .....                         | 35        |
| 5.6.3.     | Harmonic 3 Emissions Plots.....                               | 38        |
| <b>5.7</b> | <b>Field Strength of Spurious Radiation .....</b>             | <b>41</b> |
| <b>5.8</b> | <b>Frequency Stability Test .....</b>                         | <b>42</b> |
| 5.8.1.     | Temperature Variation Test Results.....                       | 44        |
| 5.8.2.     | Temperature Variation Spectrum Analyzer Plots .....           | 44        |
| 5.8.3.     | Supply Voltage Variation Test Results .....                   | 50        |
| 5.8.4.     | Supply Voltage Variation Spectrum Analyzer Plots .....        | 50        |

## 5.1 Test Strategy

The Motorola RDMi25100 is a dual mode residential subscriber unit which operates in either the proprietary Expedience mode or the WiMax mode. The operating mode is determined by the type of base station equipment with which this device would establish a communications exchange. This test report (Section 5A) covers the Expedience mode, and Section 5B covers the WiMax mode.

Verification of the performance of the Motorola, Inc., RDMi-25100 Expedience transmitter was accomplished by implementation of the procedures contained within TIA/EIA-603 and FCC requirements. Performance results contained within this Test Report and Appendix documents represent operational modes that are considered to be worst case within a functional system. Verification of product performance is presented for three frequencies across the RF bandwidth, two channel bandwidths, and four modulation configurations that are available within an operational system. The Motorola, Inc., RDMi-25100 product has been tested with equipment that is generally available in the open market. The primary requirements for the measurement of the RDMi-25100 product is that the measurement device, a spectrum analyzer in this case, contain a time gating function, a detector calibrated in terms of rms-equivalent voltage, and a power measurement capability to facilitate the accurate measurement of the channel power and emissions mask. The time gating function is configured to only allow the spectrum analyzer to sweep when the transmitter is active. Measurements performed on the RDMi-25100 product were completed with an Agilent E4440A spectrum analyzer with the time gating capability, use of the rms calibrated detector, and power measurement function as necessary. A comparison of channel power measurements with a power meter to channel power measurements with the spectrum analyzer were performed to ensure that the detector response time and limited resolution bandwidth of the spectrum analyzer was not introducing additional errors in the measurement of channel power. The outcome of this comparison indicated that the spectrum analyzer (E4440A) channel power measurement function accurately recorded the power of the emission when compared to a wide bandwidth power meter that also was calibrated in terms of rms-equivalent voltage. As such no additional correction factors needed to be applied to the measurements.

The Expedience system protocol utilizes all sub-channel carriers on each transmission burst. The Expedience system protocol does not make use of subchannelization. All carriers are utilized for each transmission. The Expedience system protocol does not allow for a mixed transmission within a single burst, i.e. all data within a single burst or transmission is one modulation type (4-QAM, 16-QAM, or 64-QAM). The same modulation is transmitted for the entire burst. To facilitate the product development, a test mode configuration was developed. The test mode allows for the selection of channel frequency, modulation bandwidth, and modulation type (4-QAM, 16-QAM, 64-QAM, 16-QAM Lite). Within the test mode, a pseudo random bit sequence is used to generate the transmitted data.

The Motorola, Inc. Expedience system is based on a proprietary protocol. As such there are no existing standards that are applicable. The Motorola, Inc. Expedience system protocol makes use of Time Division Duplex (TDD) operation as allowed by the FCC Report and Order and Further Notice of Proposed Rulemaking, FCC 04-135, at 134. Within the BRS and EBS frequency spectrum, channels are allocated in 5.5 MHz and 6.0 MHz single frequency blocks. FCC rules contained in 27.1220 allows for the splitting and combining of channel spectrum, when done jointly with other licensees that would accommodate the 6 MHz emission from an Expedience transmission anywhere within the BRS/EBS spectrum. Additional information is contained in the Technical Description document.

The Motorola, Inc., RDMi-25100 product does not contain “smart” antenna technology. The integral antenna contained within the RDMi-25100 product is a four-element patch array antenna. This antenna has a fixed gain and radiation pattern. Plots of the antenna performance are shown in the Section 13 Technical Description document.

## 5.2 Test Equipment List

| Test Equipment   | Description   |
|--|---|
| DUT  | Motorola Residential Dual Mode Subscriber Unit<br>Model No. RDMi-25100<br>Board No. 0092-0300-7180070   |
| Spectrum Analyzer  | Agilent E4440A<br>S/N: MY44022791<br>Calibrated: 05/21/2007<br>Calibration due: 05/21/2009  |
| Attenuators<br>(all applicable tests except<br>harmonic frequencies) | 40 dB, 10W Attenuator<br>MCE/Weinshel Model 23-40-34, S/N. BT 1498<br>10 dB, 10W Attenuator<br>MCE/Weinshel Model 23-10-34, S/N. BT 3857<br>Calibrated by user      |
| Filter/Attenuator Assembly<br>(harmonic frequency test<br>only)      | High Pass Filter 4-18 GHz, P/N H04G18G2, S/N 89099<br>Microwave Circuits<br>20 dB, 10W Attenuator,<br>MCE/Weinshel Model 23-20-34, S/N BP4391<br>Calibrated by user |
| Laptop Computer<br>(NN1303)  | Dell Precision M65<br>S/N: CRFK 381<br>Calibration not required   |
| Ethernet Switch  | D-Link<br>Model: DSS-5+<br>5-port 10/100Mbps<br>S/N: DT8615B009993<br>Calibration not required  |
| RSU Power Supply   | OPE-17-13<br>13V, 1.3A<br>Rev. Level 3 / Efficiency Level IV  |
| AC Power Source<br>(Frequency Stability Test<br>Only)                | Instek APS-9501<br>S/N: EF844094<br>Calibrated with voltmeter listed below.   |
| Digital Voltmeter  | HP 34401A<br>S/N: MY45001201<br>Calibrated: 5-4-2007 / Calibration due: 5-4-2009  |
| Temperature Chamber  | Test Equity<br>Model: 1007H<br>S/N: 61134<br>Temperature verified with thermocouple listed below  |
| Temperature Sensor   | Fluke 89 IV True RMS Multimeter S/N 87180024 with<br>K-Type Thermocouple  |

### 5.3 RF Power Output

FCC Rules: 2.1046, 27.4, 27.50(h)(2), 27.50(i)

FCC Requirement: User stations. All user stations are limited to 2.0 watts transmitter output power. (5.5 MHz or 6.0 MHz channel BW)

Standard: TIA-603-C  
TIA Standard, Land Mobile FM or PM Communications Equipment, Measurement and Performance Standards

Test Procedure: The peak conducted RF output power is measured over an interval of continuous transmission using a spectrum analyzer that has been calibrated in terms of rms-equivalent voltage. The peak power was recorded by utilizing the power measurement function within the spectrum analyzer. The power measurement function of this spectrum analyzer, when using a 100 kHz resolution bandwidth, has been compared against measurements performed with a power meter. The power measurements obtained from the spectrum analyzer and the power meter comparison produced the same value. As such, no additional correction factors were applied to the measured data.

The RF output of the transmitter was measured at J501 which is the RF output of the main board. The antenna board is soldered directly to this connector. This signal is applied to the spectrum analyzer through a coaxial cable and 40 dB attenuator. The spectrum analyzer is time gated by the Tx\_Enable signal on the main board such that only RF transmission bursts are captured.

The transmitter is enabled in test mode and set to the minimum and maximum power levels with the host computer. The RF loss of the attenuator and coax was measured and is included in the spectrum analyzer offset level for the maximum and minimum RF power measurements.

Measurements are performed at frequencies across the band and for each of the modulation formats available (4-, 16-, 64-, 16L-QAM) and channel bandwidths (5.5 and 6.0 MHz).

Test Conditions:      **Test Frequencies:** 2499, 2593, 2687 MHz (5.5 and 6.0 MHz bandwidth)  
                                  **Temperature:** 22°C  
                                  **Supply Voltage:** 120 VAC / 60 Hz nominal to DUT power supply

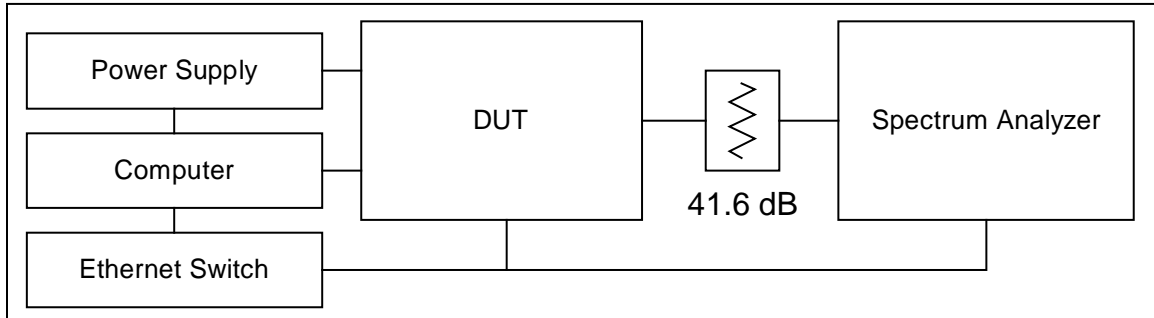

**Conducted RF Power Test Setup**

**5.3.1. Conducted RF Power Output Test Results**

| Maximum (2.0 W) Power Setting |                 |       |         |        |         |        |         |             |         |
|-------------------------------|-----------------|-------|---------|--------|---------|--------|---------|-------------|---------|
| Freq (MHz)                    | Bandwidth (MHz) | 4 QAM |         | 16 QAM |         | 64 QAM |         | 16 QAM Lite |         |
|                               |                 | (dBm) | (Watts) | (dBm)  | (Watts) | (dBm)  | (Watts) | (dBm)       | (Watts) |
| 2499                          | 6.0             | 32.62 | 1.83    | 32.72  | 1.87    | 32.80  | 1.91    | 32.82       | 1.91    |
| 2593                          | 6.0             | 32.77 | 1.89    | 32.79  | 1.90    | 32.78  | 1.90    | 32.78       | 1.90    |
| 2687                          | 6.0             | 33.00 | 2.00    | 32.99  | 1.99    | 32.99  | 1.99    | 32.99       | 1.99    |
|                               |                 |       |         |        |         |        |         |             |         |
| 2499                          | 5.5             | 32.74 | 1.88    | 32.76  | 1.89    | 32.78  | 1.90    | 32.73       | 1.87    |
| 2593                          | 5.5             | 32.73 | 1.87    | 32.72  | 1.87    | 32.75  | 1.88    | 32.72       | 1.87    |
| 2687                          | 5.5             | 32.99 | 1.99    | 33.00  | 2.00    | 32.99  | 1.99    | 33.00       | 2.00    |

| Minimum (1 mW) Power Setting |                 |       |         |        |         |        |         |             |         |
|------------------------------|-----------------|-------|---------|--------|---------|--------|---------|-------------|---------|
| Freq (MHz)                   | Bandwidth (MHz) | 4 QAM |         | 16 QAM |         | 64 QAM |         | 16 QAM Lite |         |
|                              |                 | (dBm) | (Watts) | (dBm)  | (Watts) | (dBm)  | (Watts) | (dBm)       | (Watts) |
| 2499                         | 6.0             | -0.51 | 0.0009  | -0.48  | 0.0009  | -0.49  | 0.0009  | -0.49       | 0.0009  |
| 2593                         | 6.0             | -0.50 | 0.0009  | -0.49  | 0.0009  | -0.51  | 0.0009  | -0.52       | 0.0009  |
| 2687                         | 6.0             | -0.53 | 0.0009  | -0.52  | 0.0009  | -0.51  | 0.0009  | -0.52       | 0.0009  |
|                              |                 |       |         |        |         |        |         |             |         |
| 2499                         | 5.5             | -0.49 | 0.0009  | -0.45  | 0.0009  | -0.48  | 0.0009  | -0.48       | 0.0009  |
| 2593                         | 5.5             | -0.48 | 0.0009  | -0.48  | 0.0009  | -0.49  | 0.0009  | -0.49       | 0.0009  |
| 2687                         | 5.5             | -0.47 | 0.0009  | -0.47  | 0.0009  | -0.45  | 0.0009  | -0.48       | 0.0009  |

### 5.3.2. Conducted RF Power Output Plots

The spectrum analyzer data for the 4-QAM peak power measurements is displayed on the following pages. The conducted power level is indicated in the lower part of the screen under “Carrier Power”. The plots for the 16, 64, and 16 LT QAM modulation levels are located in the Appendix (refer to “Conducted Power and Modulation Characteristics Plots”).

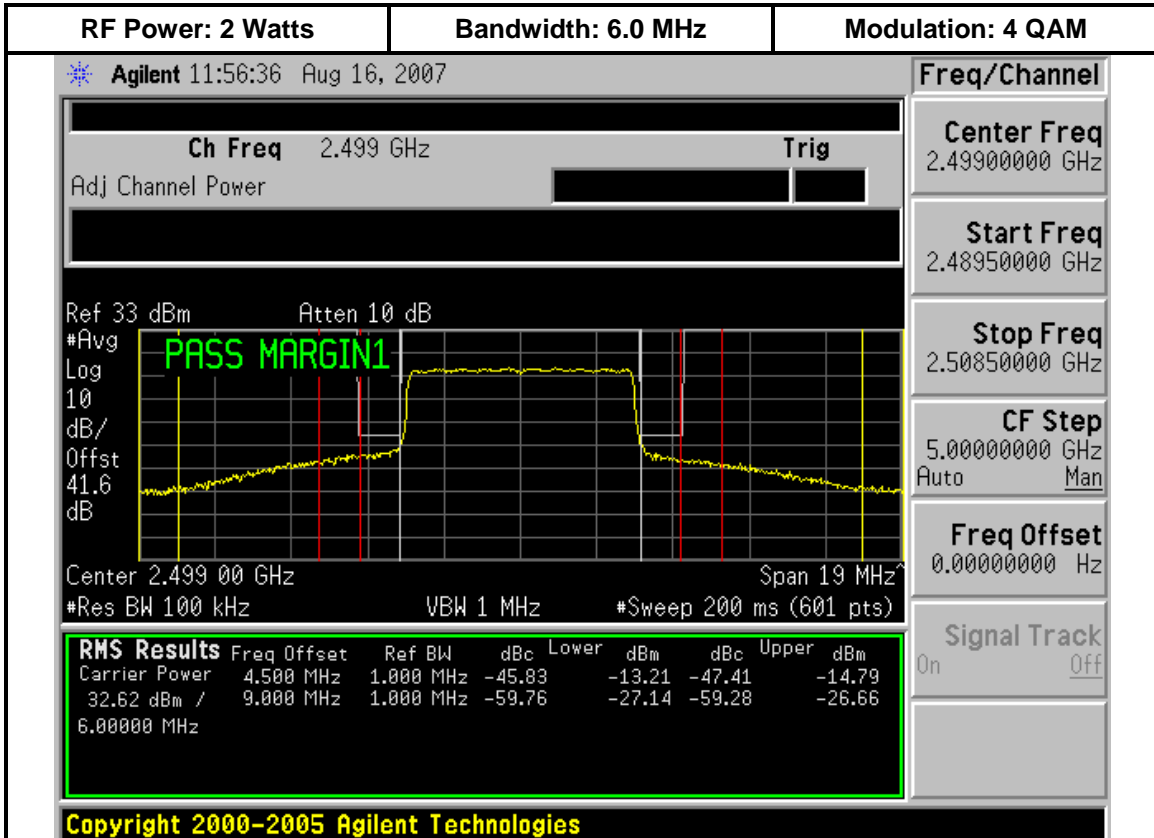

2499 MHz

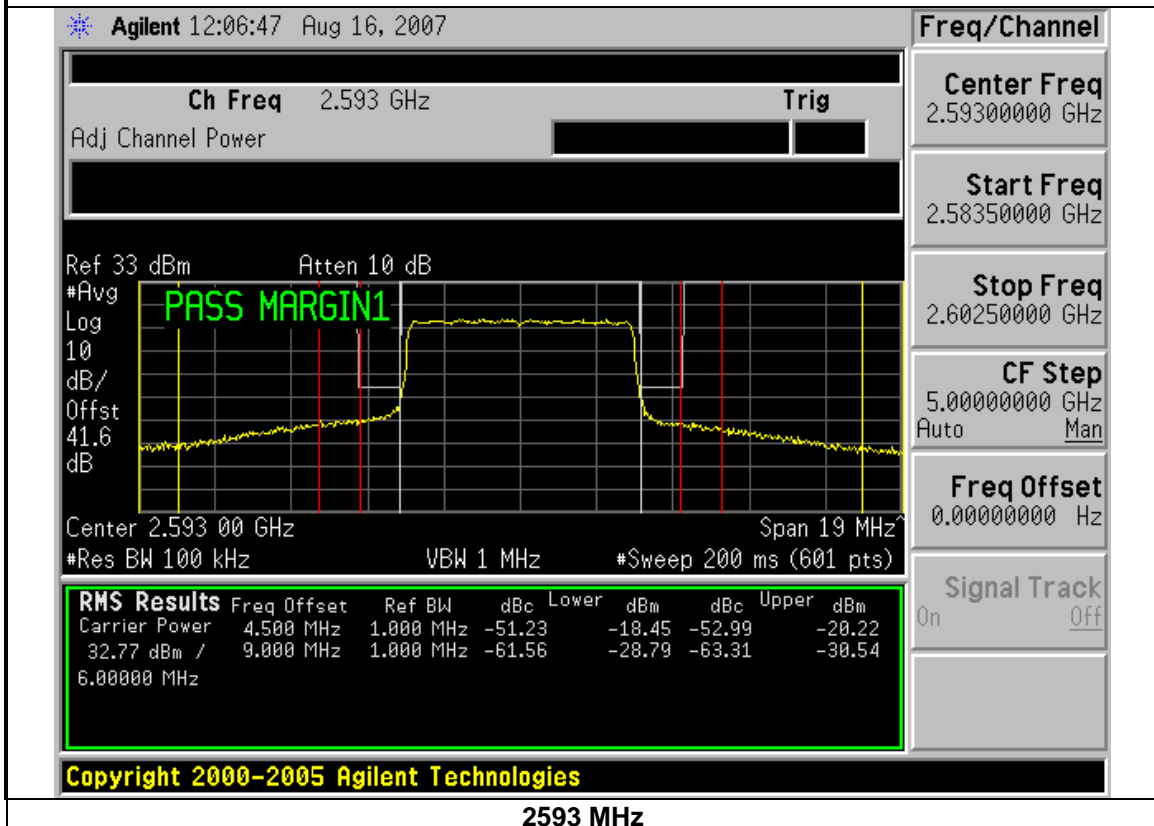

2593 MHz



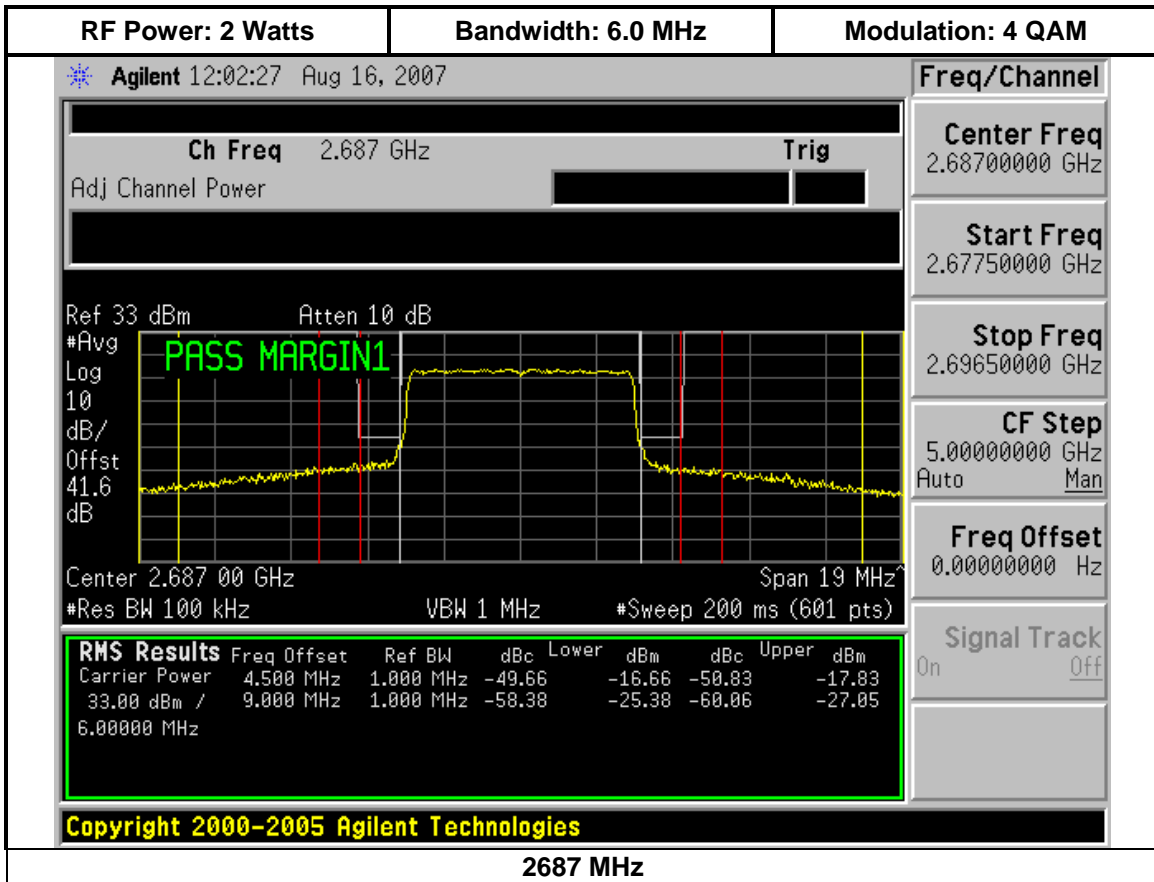

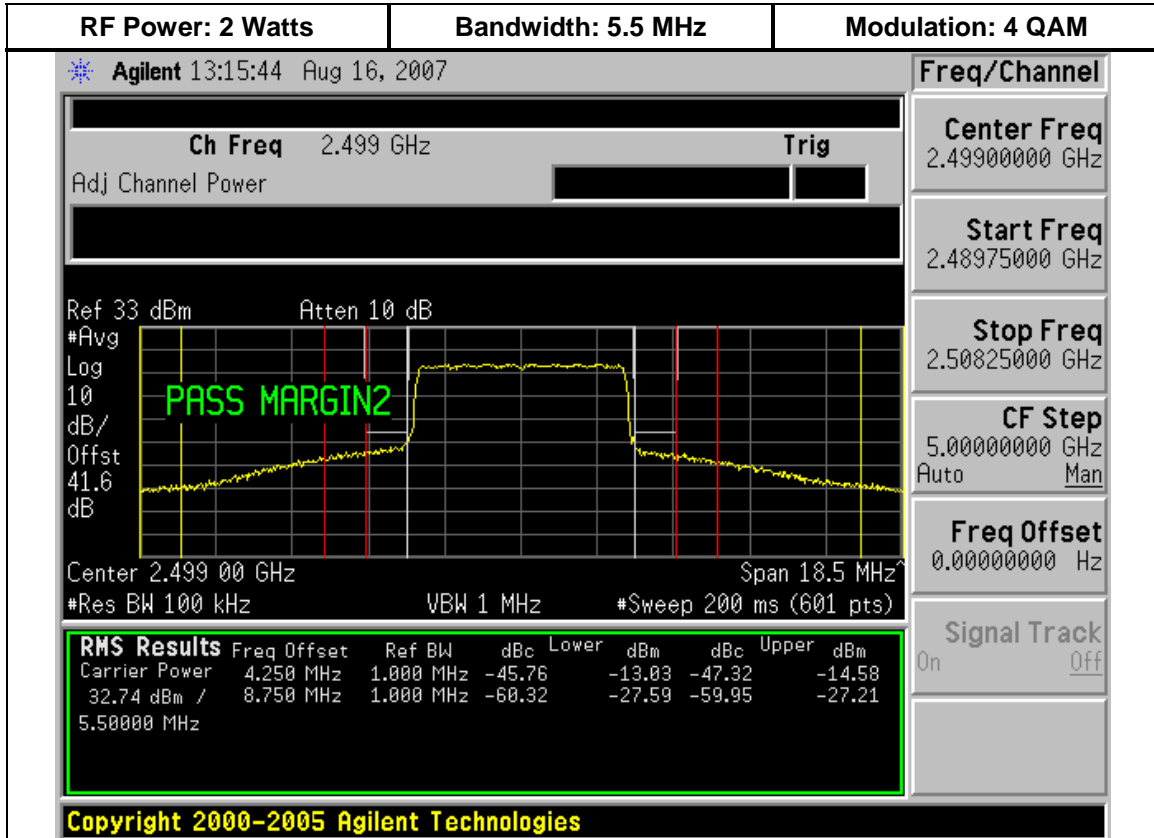

2499 MHz

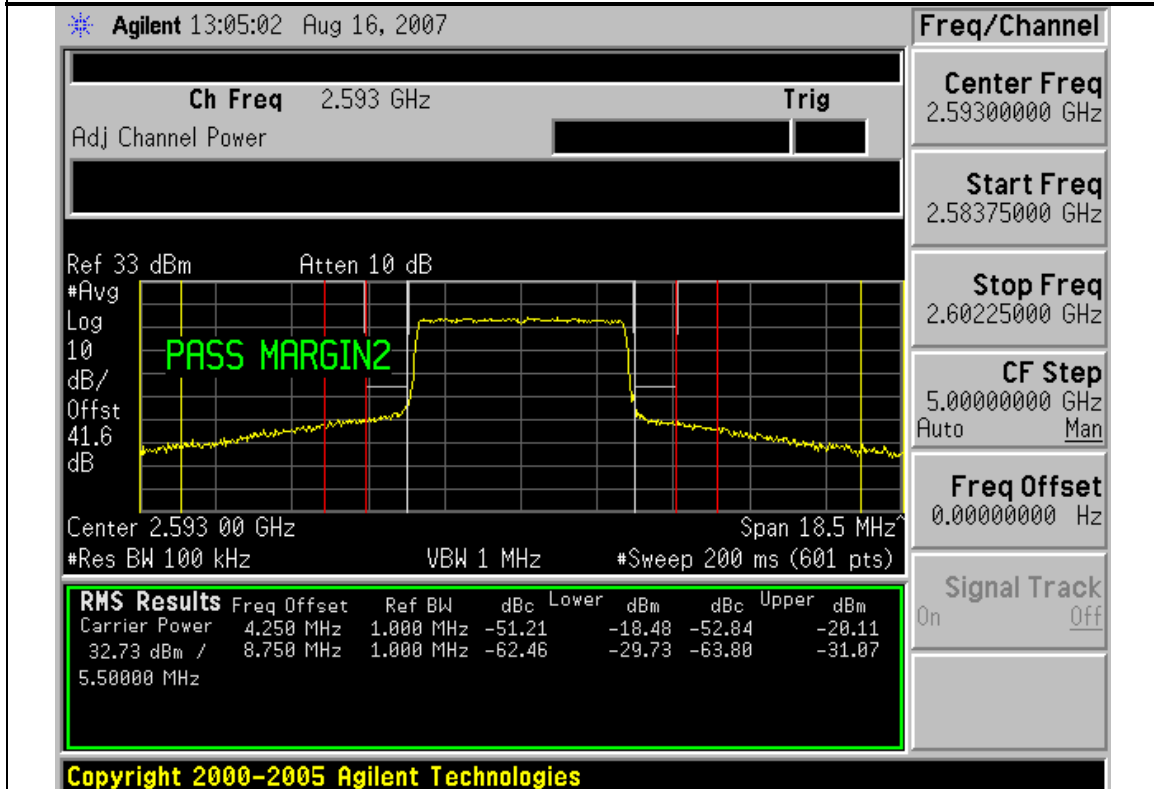

2593 MHz

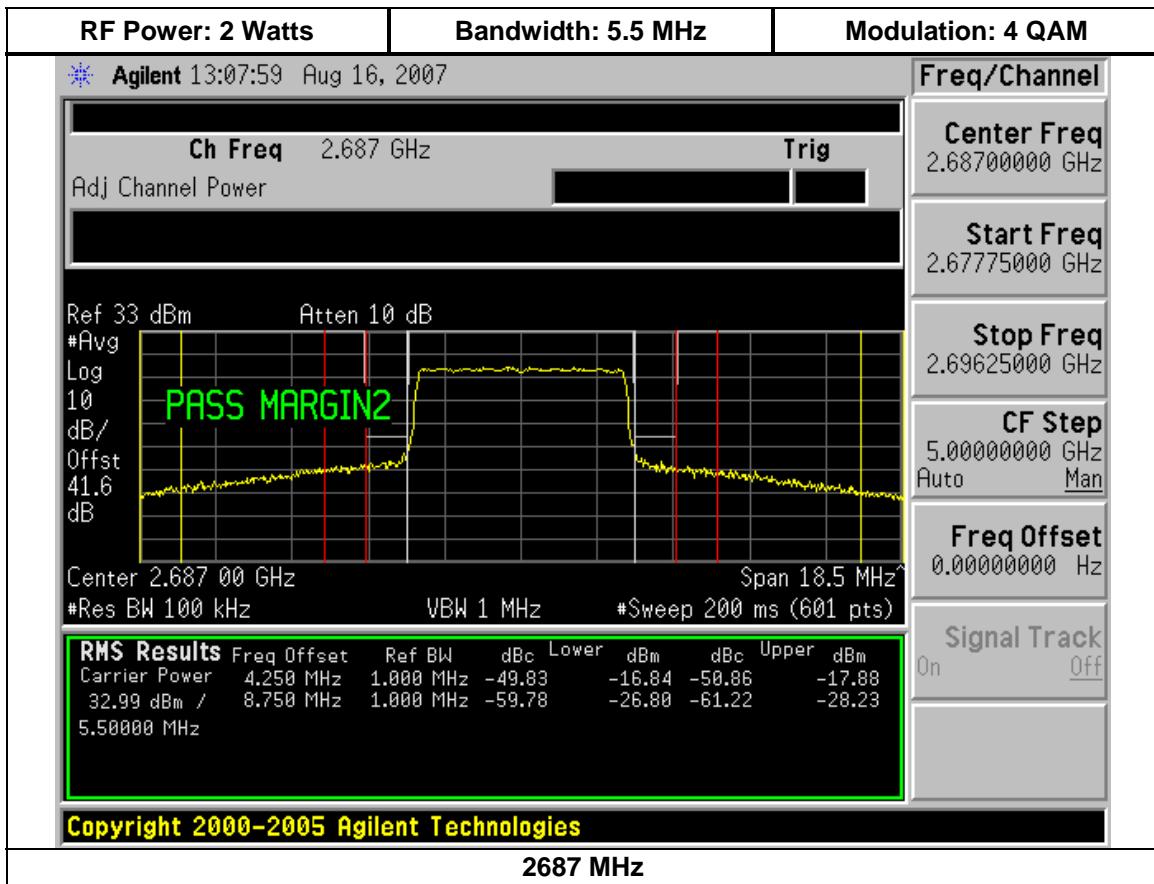

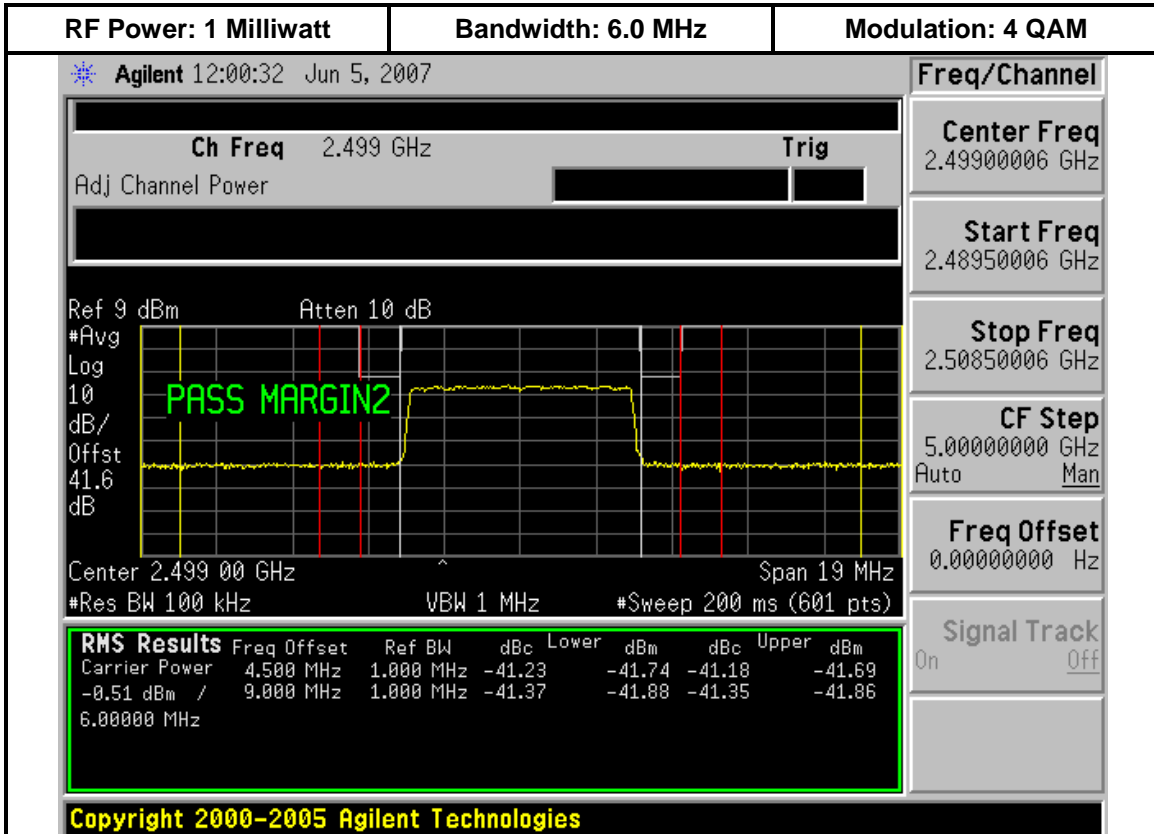

2499 MHz

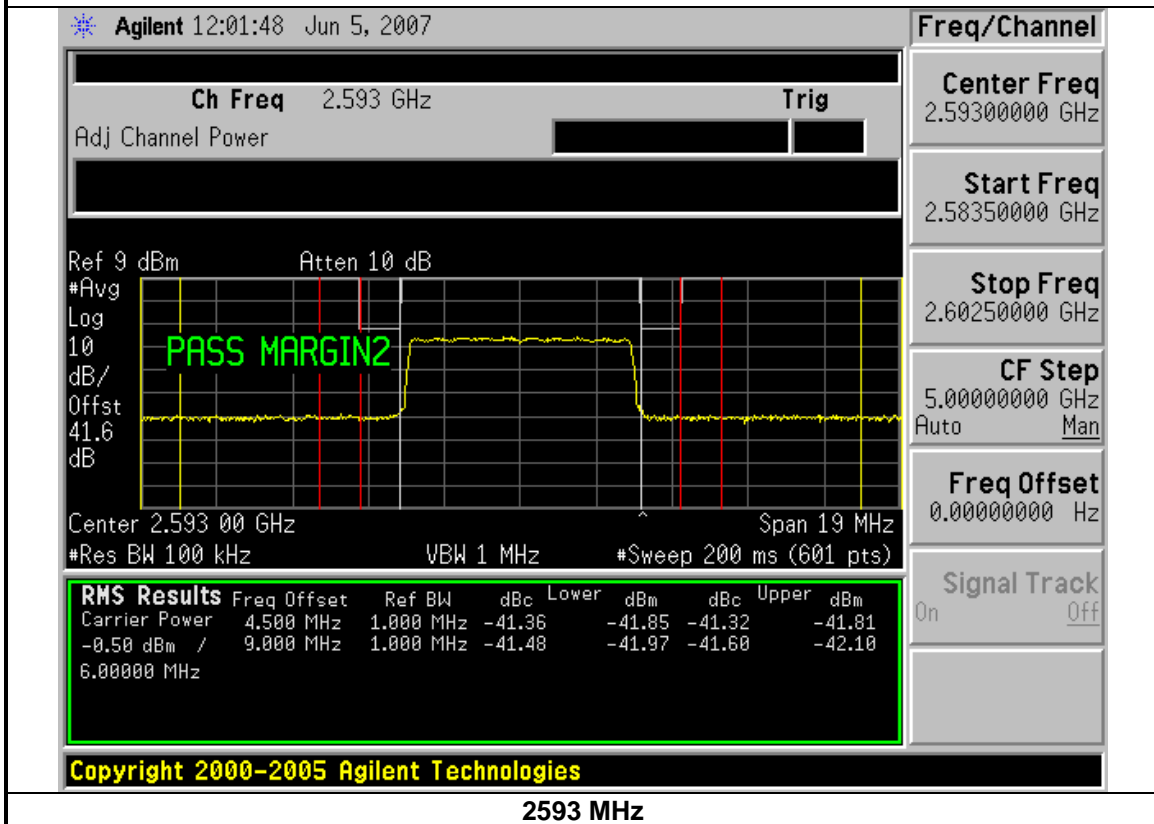

2593 MHz

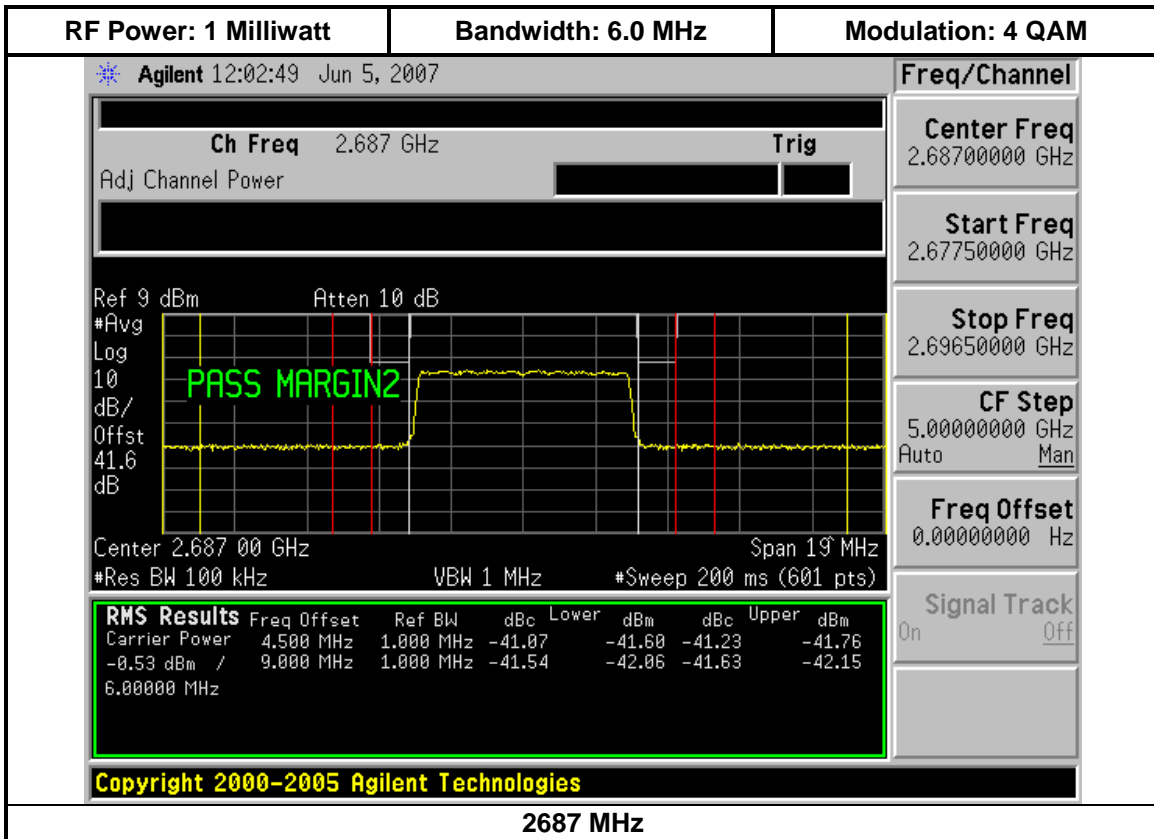

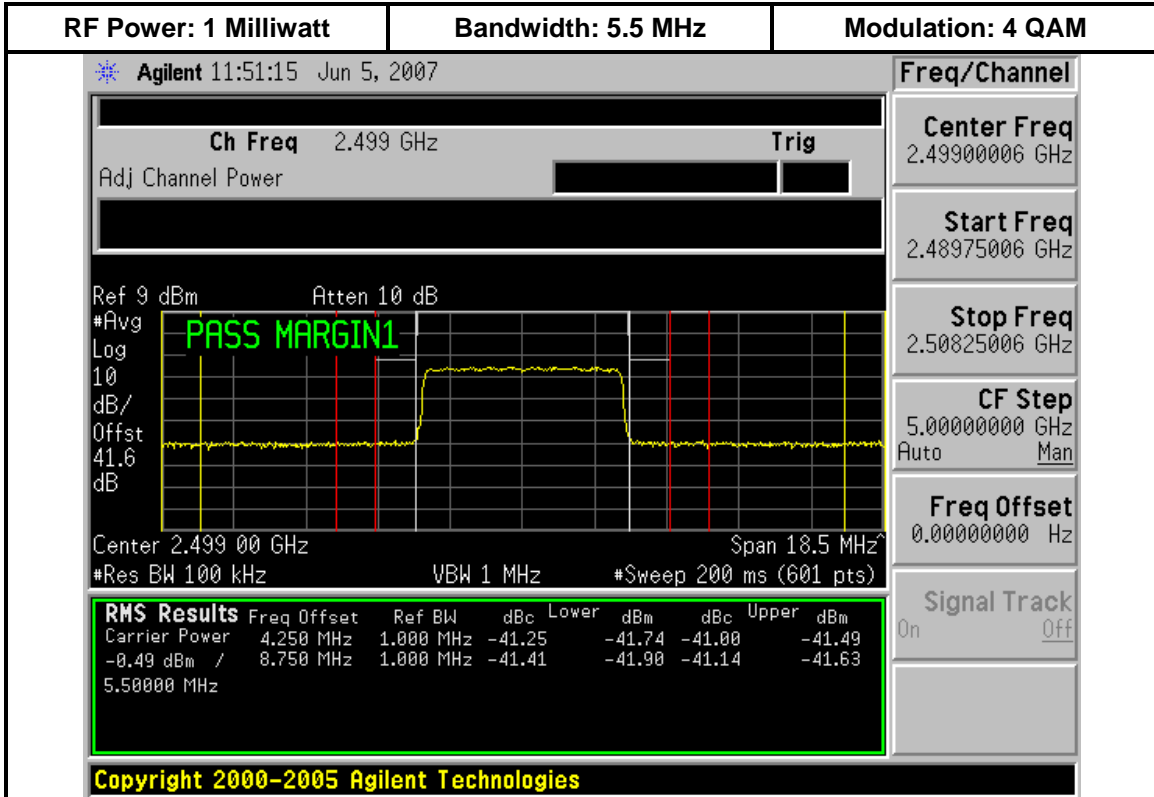

2499 MHz

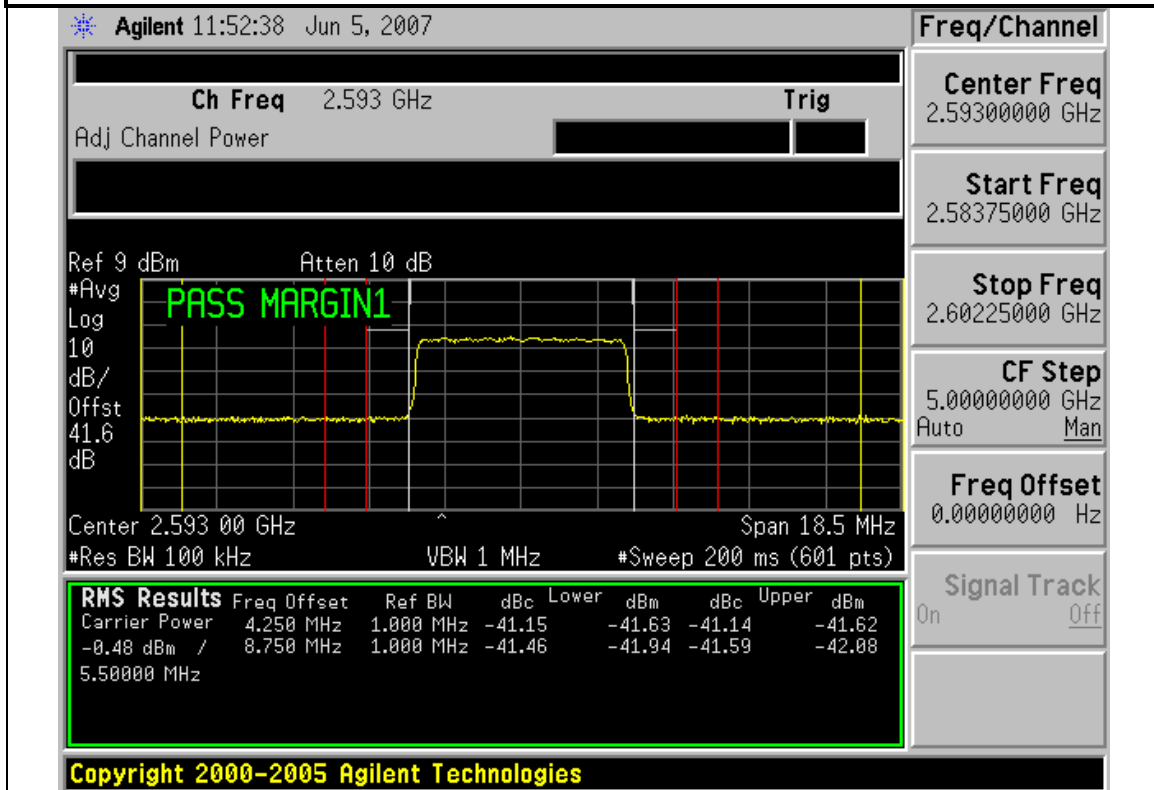

2593 MHz

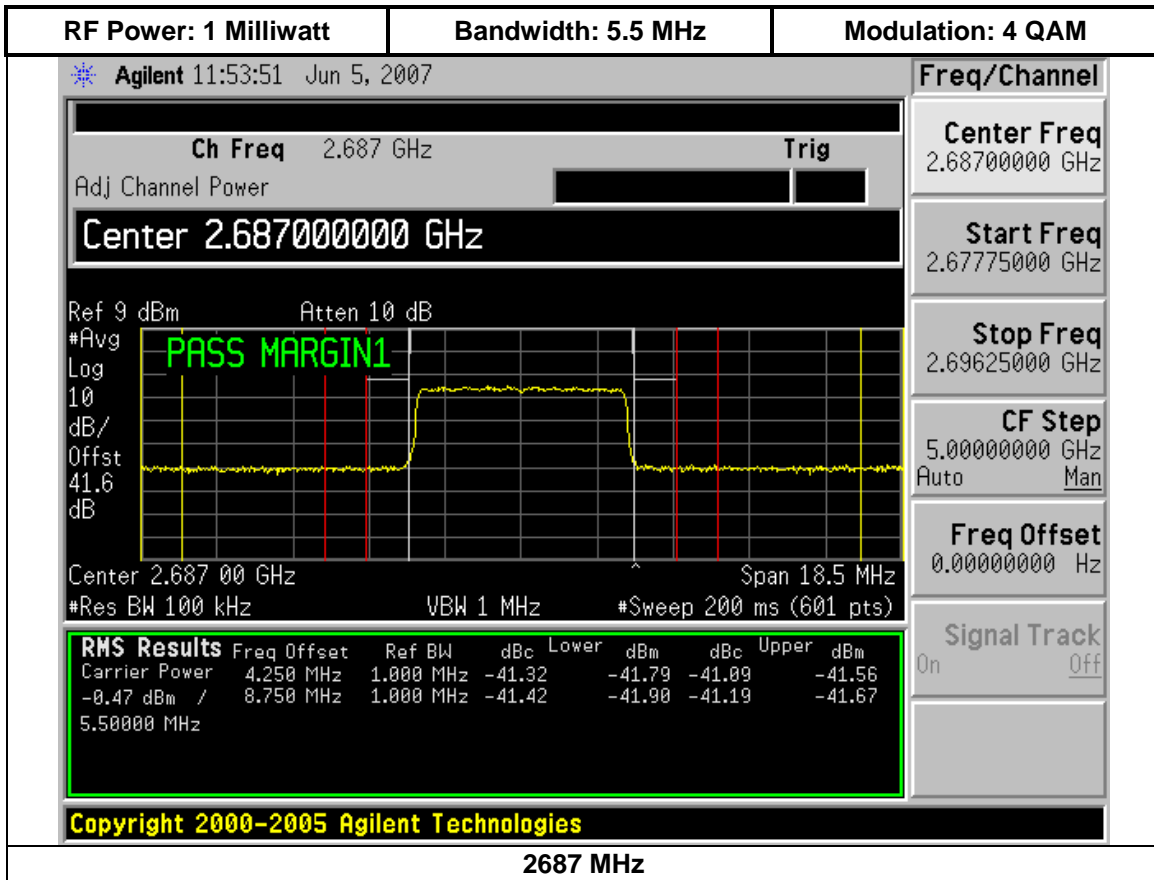

## 5.4 Modulation Characteristics

FCC Rules: 2.1047(d), 27.53(l)(4), 27.53(l)(6)

FCC requirement: Digital User Station

Attenuation at band edge =  $43 + 10 \cdot \log(P)$ ,  $P = 2$  watts

Attenuation at band edge =  $43 + 10 \cdot \log(2) = 43 + 3$

Attenuation at band edge = 46 dB (equates to -13 dBm)

Attenuation at 5.5 MHz edge =  $55 + 10 \cdot \log(P)$ ,  $P = 2$  watts

Attenuation at 5.5 MHz edge =  $55 + 10 \cdot \log(2) = 55 + 3$

Attenuation at 5.5 MHz edge = 58 dB (equates to -25 dBm)

Standard: 47CFR27.53(l)(4)

Test Procedure: The Orthogonal Frequency Division Multiplexing (OFDM) modulated Time Division Duplex (TDD), RF signal from the test unit is applied to a spectrum analyzer. A detector that has been calibrated in terms of rms-equivalent voltage is used to measure the power of the out of band emission. The emissions have been recorded and show compliance to the -13 dBm requirement. As allowed per the FCC rules, a measurement bandwidth of 100 kHz (1% or greater of the emissions bandwidth) was used for the test.

The Motorola, Inc., RDMi-25100 Expedience transmitter has been designed to comply with the mobile mask requirements of 27.53(l)(4). As such, the FCC mask for the BRS/EBS rules requires the spectral emissions to be less than -13 dBm in any 1 MHz of spectrum from the channel edge to 5.5 MHz from the channel edge and -25 dBm in a 1 MHz bandwidth at 5.5 MHz from the channel edge.

The first 1 MHz of spectral power outside of the channel must be less than -13 dBm when measured with a resolution bandwidth that is at least 1% of the transmitted signal emissions bandwidth. This first 1 MHz of spectrum, designated as bins a/A in the spectral plot shown below, is verified by establishing a limit line at -13dBm on the spectrum analyzer display. When all emissions in bins a/A are under the -13 dBm limit, a "PASS LIMIT1" (5.5 MHz channel) or "PASS LIMIT2" (6.0 MHz channel) is displayed. Conversely, a spectral plot with any emissions within bins a/A that are above the -13 dBm limit will produce a "FAIL MARGIN1" or "FAIL MARGIN2" on the display.



All other emissions, shown as bins b/B thru g/G, must be measured with a 1 MHz resolution bandwidth or at least a 1% resolution bandwidth and then integrate the spectral power over a 1 MHz frequency span. The worst case emission for the -13 dBm limit is found at bins b/B. The -25 dBm limit at +/- 5.5 MHz from the channel edge is shown on the plots as bins g/G. The table in section 5.4.1 contains a summary of the plot information for the test configurations.

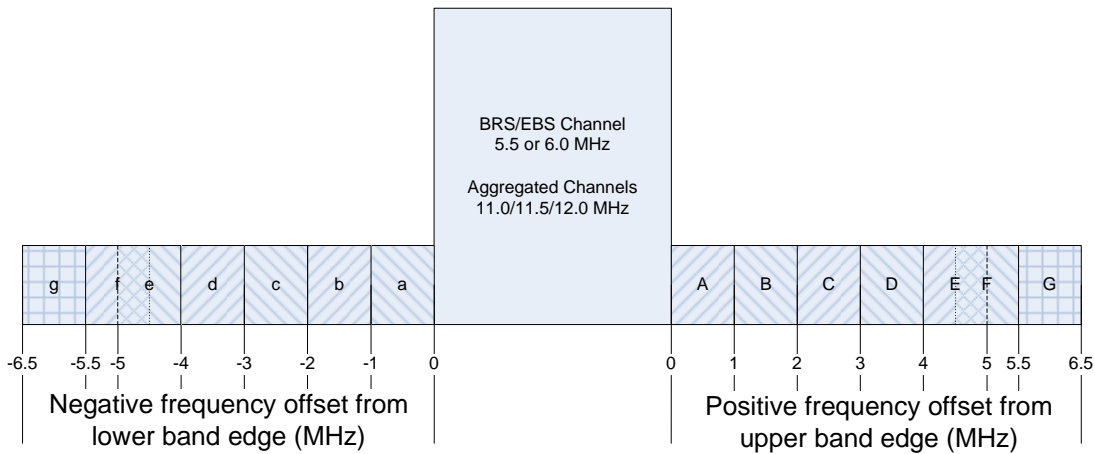

The RDMi-25100 Expedience transmitter is enabled in test mode by the attached computer. The RF loss of the attenuators and coax was measured and is included in the spectrum analyzer amplitude offset and is noted in the block diagram which follows.

Measurements are performed at three frequencies across the band, for each of the modulation formats available (4-, 16-, 64-, 16LT-QAM) and channel bandwidths (5.5 and 6.0 MHz). The test frequencies are at the low, mid, and high band points.



| 64-QAM   |                  |      |        |        |                         |        |        |                         |
|----------|------------------|------|--------|--------|-------------------------|--------|--------|-------------------------|
| Fo (MHz) | Channel BW (MHz) | a/A  | b      | B      | Margin to -13 dBm limit | g      | G      | Margin to -25 dBm limit |
| 2499     | 6                | Pass | -13.08 | -14.30 | 0.08                    | -26.62 | -26.33 | 1.33                    |
| 2593     | 6                | Pass | -18.09 | -20.18 | 5.09                    | -28.47 | -30.37 | 3.47                    |
| 2687     | 6                | Pass | -17.02 | -18.20 | 4.02                    | -26.02 | -27.20 | 1.02                    |
| 2499     | 5.5              | Pass | -13.04 | -14.55 | 0.04                    | -27.54 | -27.20 | 2.20                    |
| 2593     | 5.5              | Pass | -18.57 | -20.39 | 5.57                    | -29.82 | -31.38 | 4.82                    |
| 2687     | 5.5              | Pass | -17.00 | -17.63 | 4.00                    | -27.07 | -27.79 | 2.07                    |

| 16-QAM LT |                  |      |        |        |                         |        |        |                         |
|-----------|------------------|------|--------|--------|-------------------------|--------|--------|-------------------------|
| Fo (MHz)  | Channel BW (MHz) | a/A  | b      | B      | Margin to -13 dBm limit | g      | G      | Margin to -25 dBm limit |
| 2499      | 6                | Pass | -13.12 | -14.38 | 0.12                    | -26.76 | -26.07 | 1.07                    |
| 2593      | 6                | Pass | -18.35 | -20.10 | 5.35                    | -28.99 | -30.23 | 3.99                    |
| 2687      | 6                | Pass | -16.97 | -17.80 | 3.97                    | -25.69 | -26.89 | 0.69                    |
| 2499      | 5.5              | Pass | -13.05 | -14.32 | 0.05                    | -27.54 | -27.22 | 2.22                    |
| 2593      | 5.5              | Pass | -18.24 | -20.43 | 5.24                    | -29.95 | -31.24 | 4.95                    |
| 2687      | 5.5              | Pass | -16.91 | -17.49 | 3.91                    | -26.99 | -27.88 | 1.99                    |

#### 5.4.2. Modulation Characteristics Data Plots

The spectrum analyzer plots for the 2-watt, 4-QAM data is shown in the Conducted Power plots on the preceding pages starting on page 8. The plots for the 16, 64, and 16 LT QAM modulation levels are located in the Appendix A (refer to “RF Power Output and Modulation Characteristics Plots”).

## 5.5 Occupied and Emission Bandwidth

FCC Rules: 2.1049, 27.53(l)(6)

FCC Requirements: Report Results

Standard: ANSI C63.4-2003  
American National Standard for Methods of Measurement of Radio-Noise Emissions from Low-Voltage Electrical and Electronic Equipment in the Range of 9 kHz to 40 GHz.

Test Procedure: The Orthogonal Frequency Division Multiplexing (OFDM) modulated Time Division Duplex (TDD) RF signal from the test unit is applied to a spectrum analyzer. The bandwidth of the signal is recorded by measuring the modulation bandwidth with the built in measurement function in the spectrum analyzer. The transmitter is enabled in test mode with the attached computer. The RF loss of the attenuators and coax has been measured and is included in the spectrum analyzer offset level. Measurements are performed at frequencies at the low, mid, and high points the band, for each of the modulation formats available (4, 16, 64, and 16L QAM), and channel bandwidths (5.5 and 6 MHz).

Test Conditions: **Test Frequencies:** 2499, 2593, 2687 MHz (5.5 and 6.0 MHz bandwidth)  
**Temperature:** 22°C  
**Supply Voltage:** 120 VAC / 60 Hz nominal to DUT power supply

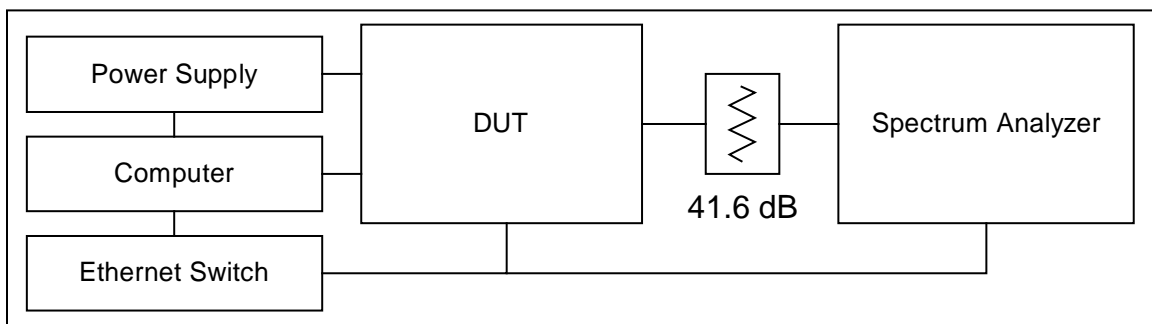

**Occupied/Emission Bandwidth Test Setup**

**5.5.1. Occupied and Emission Bandwidth Test Results Summary**

| Occupied Bandwidth (MHz) for 99.0% (-20 dB) |                 |       |        |        |             |
|---|-----------------|-------|--------|--------|-------------|
| Freq (MHz)                                  | Bandwidth (MHz) | 4 QAM | 16 QAM | 64 QAM | 16 QAM Lite |
| 2499  | 6.0             | 5.489 | 5.490  | 5.489  | 5.491       |
| 2593  | 6.0             | 5.492 | 5.488  | 5.486  | 5.488       |
| 2687  | 6.0             | 5.486 | 5.485  | 5.489  | 5.487       |
|   |                 |       |        |        |             |
| 2499  | 5.5             | 4.969 | 4.974  | 4.970  | 4.972       |
| 2593  | 5.5             | 4.972 | 4.971  | 4.974  | 4.970       |
| 2687  | 5.5             | 4.971 | 4.971  | 4.971  | 4.970       |

| Emission Bandwidth (MHz) for 99.75% (-26 dB) |                 |       |        |        |             |
|--|-----------------|-------|--------|--------|-------------|
| Freq (MHz)                                   | Bandwidth (MHz) | 4 QAM | 16 QAM | 64 QAM | 16 QAM Lite |
| 2499   | 6.0             | 5.805 | 5.781  | 5.782  | 5.780       |
| 2593   | 6.0             | 5.773 | 5.778  | 5.786  | 5.773       |
| 2687   | 6.0             | 5.776 | 5.769  | 5.793  | 5.772       |
|  |                 |       |        |        |             |
| 2499   | 5.5             | 5.247 | 5.258  | 5.237  | 5.241       |
| 2593   | 5.5             | 5.248 | 5.251  | 5.236  | 5.262       |
| 2687   | 5.5             | 5.247 | 5.260  | 5.250  | 5.247       |

**5.5.2. Occupied and Emission Bandwidth Spectrum Analyzer Plots**

The following are spectrum analyzer plots of the 4 QAM data in the preceding tables. The plots for the 16 QAM, 64 QAM, and 16 QAM Lite modulation levels are similar and are shown in the Appendix (refer to “Occupied/Emission Bandwidth Plots”).

Both Occupied and Emission Bandwidth is shown in the same plot. The 99% Occupied Bandwidth is displayed in large type under “Occupied Bandwidth”, and the -26 x dB Emission Bandwidth is displayed in smaller type to the right of “x dB Bandwidth”.

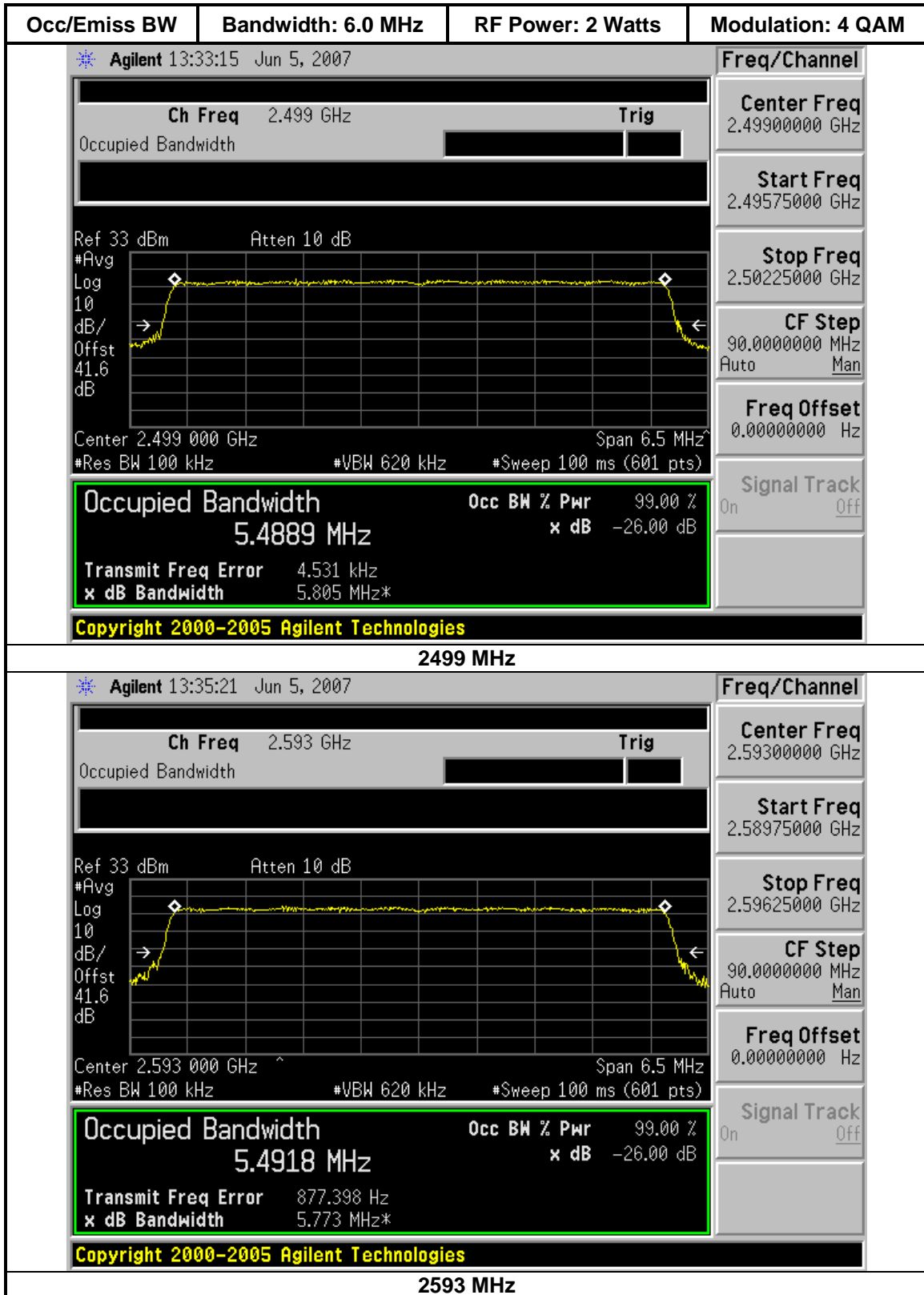

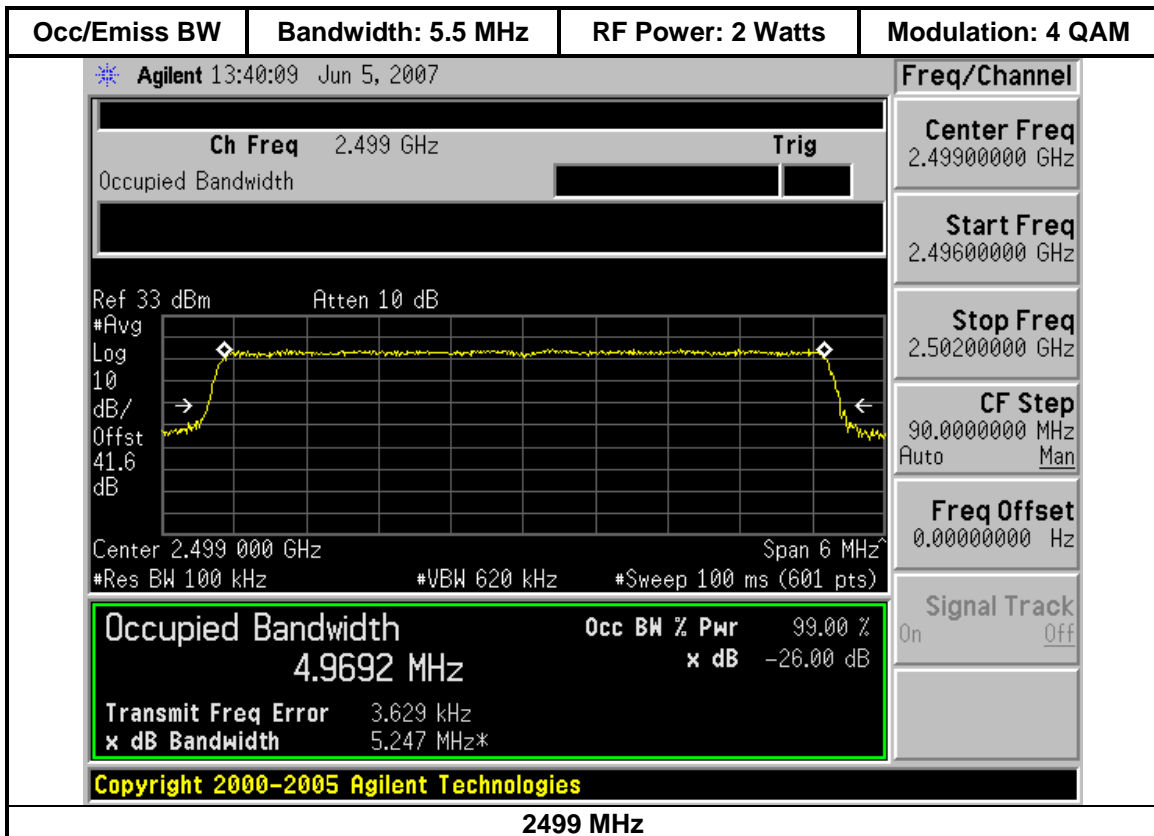
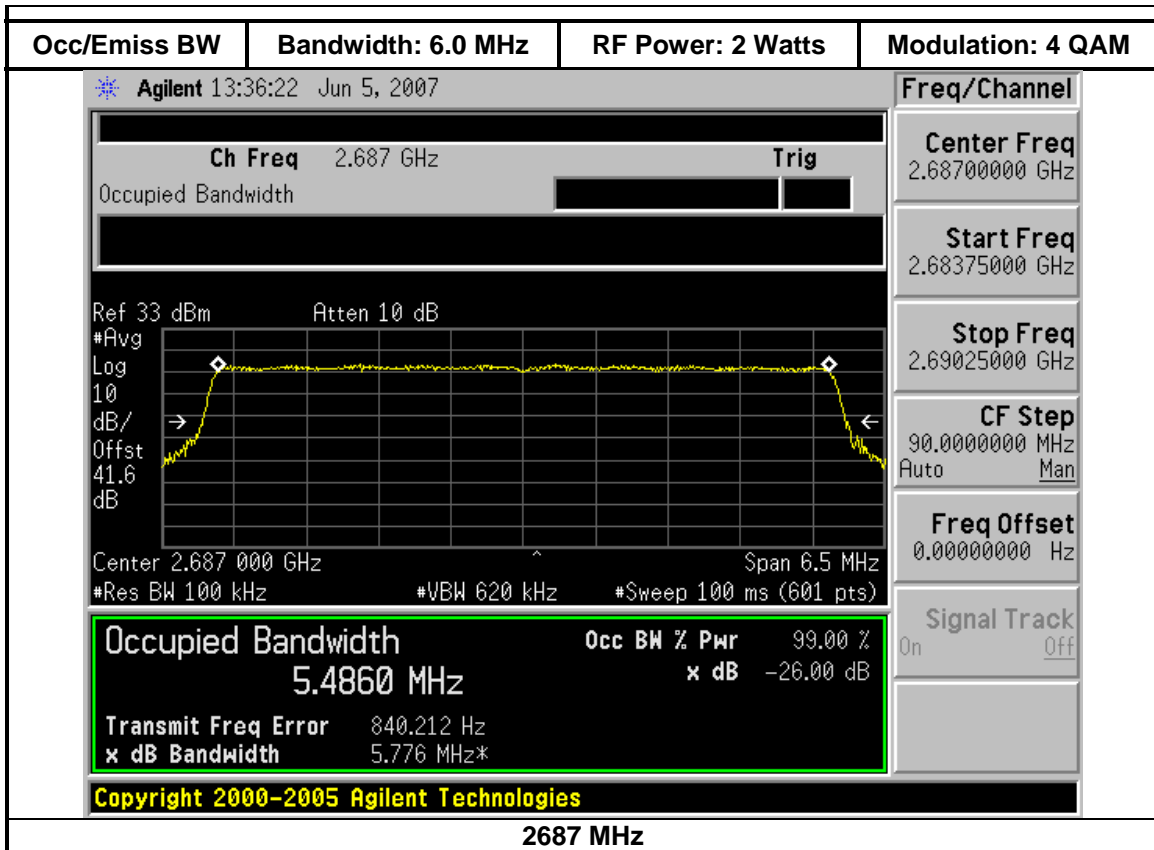

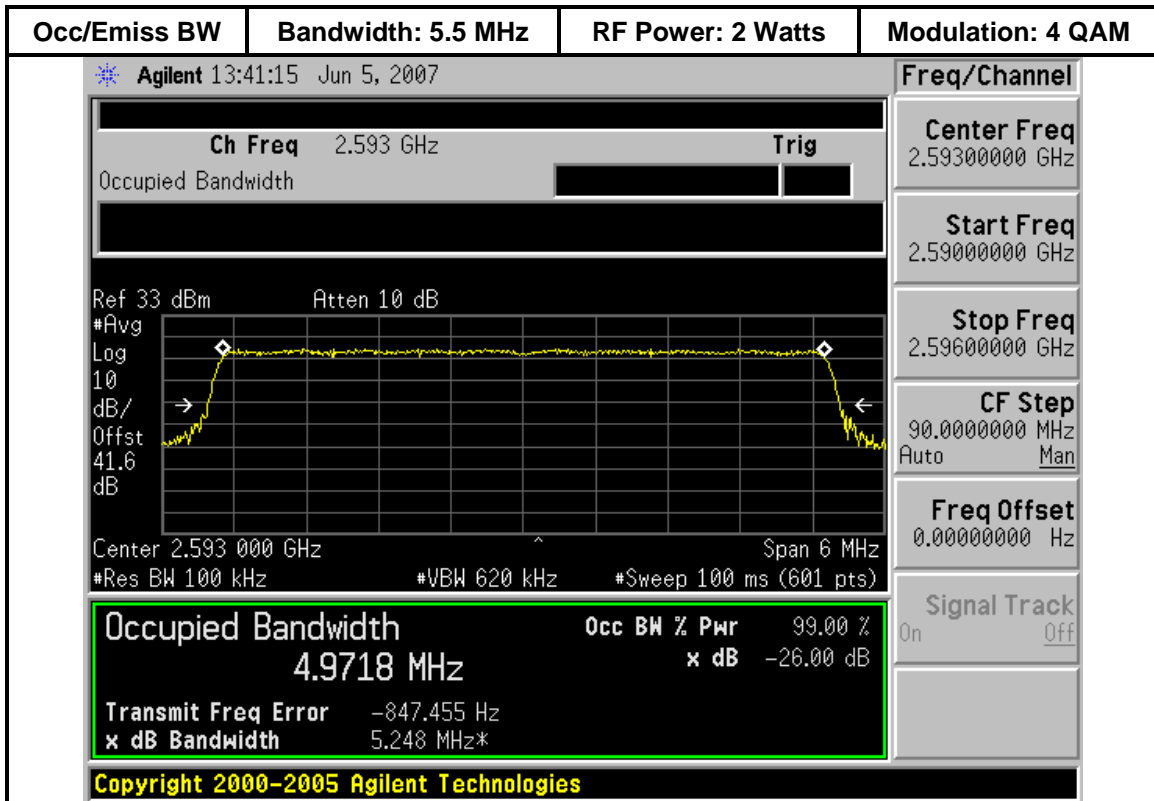

2593 MHz

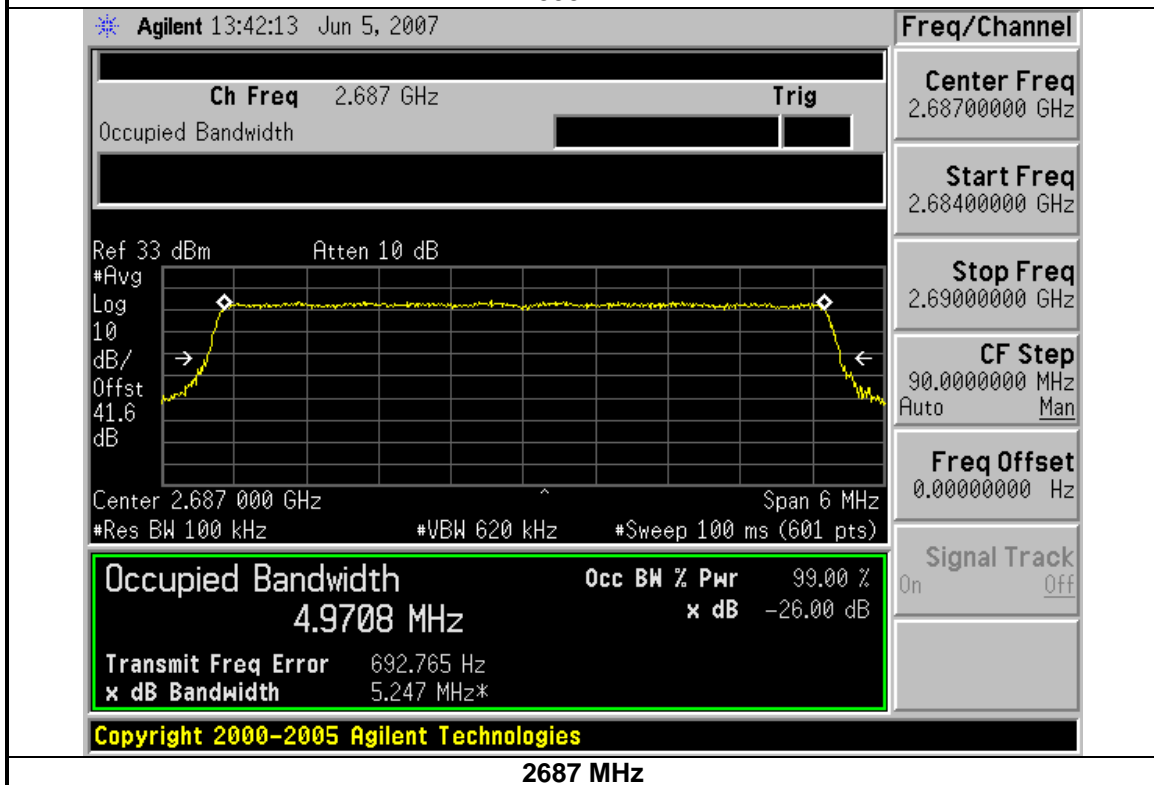

2687 MHz



## 5.6 Transmitter Spurious Emissions

FCC Rules: 2.1051, 2.1049, 2.1057

Standard: TIA-603-C  
TIA Standard, Land Mobile FM or PM Communications  
Equipment, Measurement and Performance Standards

Test Procedure: The Orthogonal Frequency Division Multiplexing (OFDM) modulated Time Division Duplex (TDD) RF signal from the test unit is applied to a spectrum analyzer thru an attenuator and coax, or, for harmonic measurements, through an attenuator, high pass filter and coax that was calibrated for RF loss at each harmonic frequency being tested. The transmission is recorded from 9 kHz to 26.5 GHz in multiple plots. The transmitter is enabled in test mode with the attached computer. The RF loss of the attenuator and coax is included in the spectrum analyzer offset level. Measurements are performed at frequencies across the band and both channel bandwidths (5.5 MHz and 6 MHz). A modulation level of 4 QAM was used for all measurements.

One data plot from each channel bandwidth is included for measurements below the BRS/EBS frequency band (below 2.48 GHz). All other channels measured had similar-looking spectral plots. For tests above the BRS/EBS frequency (2.7-26.5 GHz), plots for all channels are included.

For harmonic tests, plots are shown for the second harmonic of all test channels. Then the worst channel (2504.75 MHz) was chosen to show compliance for harmonics three to ten. The other channels tested have similar or lower harmonic levels.

Test Conditions: **Channels:** 2499, 2593, and 2687 MHz (5.5 and 6.0 MHz bandwidth)  
**Temperature:** 22°C  
**Supply Voltage:** 120 VAC / 60 Hz nominal to the DUT power supply

Test Results: Passes conducted emissions from 9 kHz to 26.86 MHz. All spurious and harmonic emissions are more than 20 dB below the -13 dBm limit.

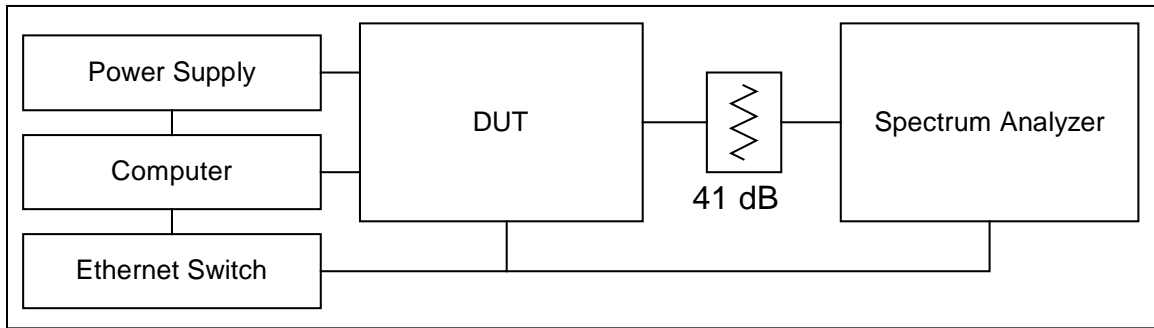

**Spurious Emissions Test Setup**

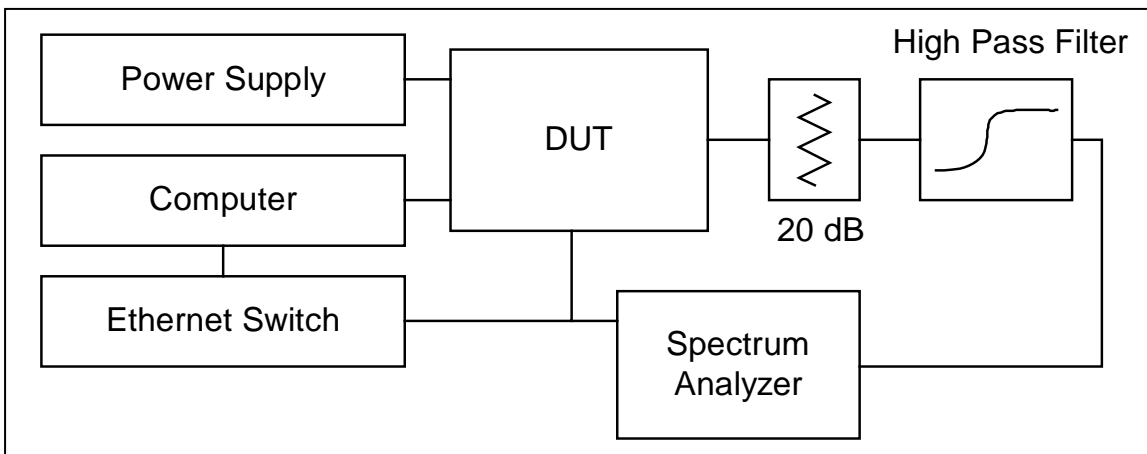

**Harmonic Emissions Test Setup**

### 5.6.1. Transmitter Spurious Emissions Plots

For frequencies below 2.48 GHz, plots for only the 2499 MHz (6.0 and 5.5 MHz bandwidth) channels are shown on the pages which follow. The plots for the other channels are similar and are located in the Appendix. For frequencies above 2.48 GHz, plots for all test channels are shown.

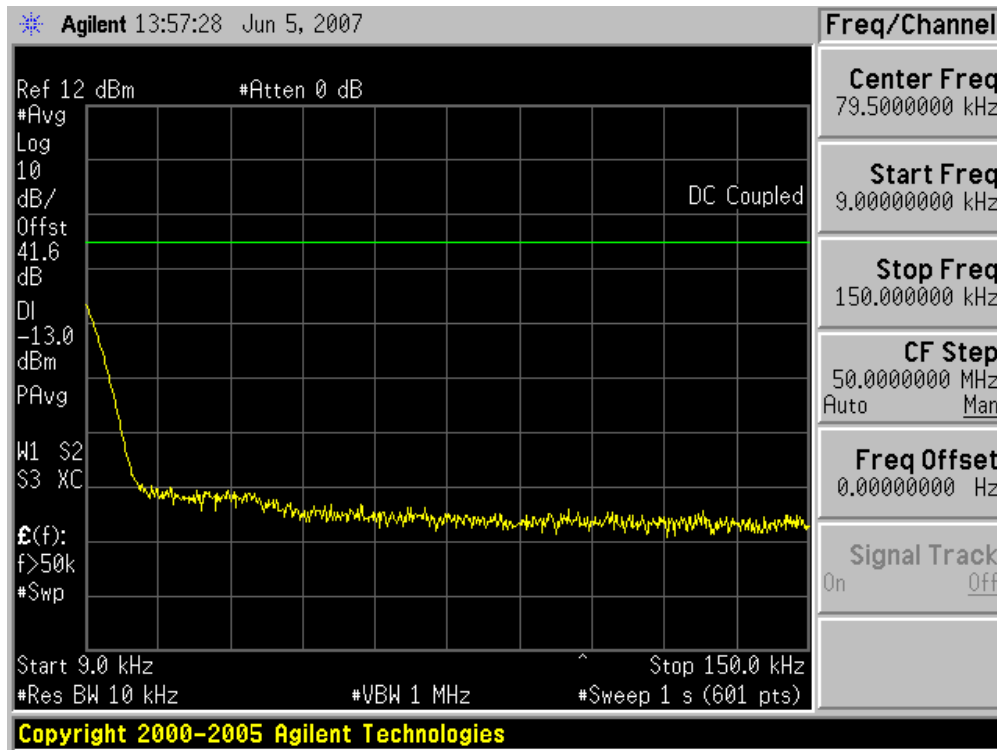

9 kHz – 150 kHz (2499 MHz, 6 MHz Channel)

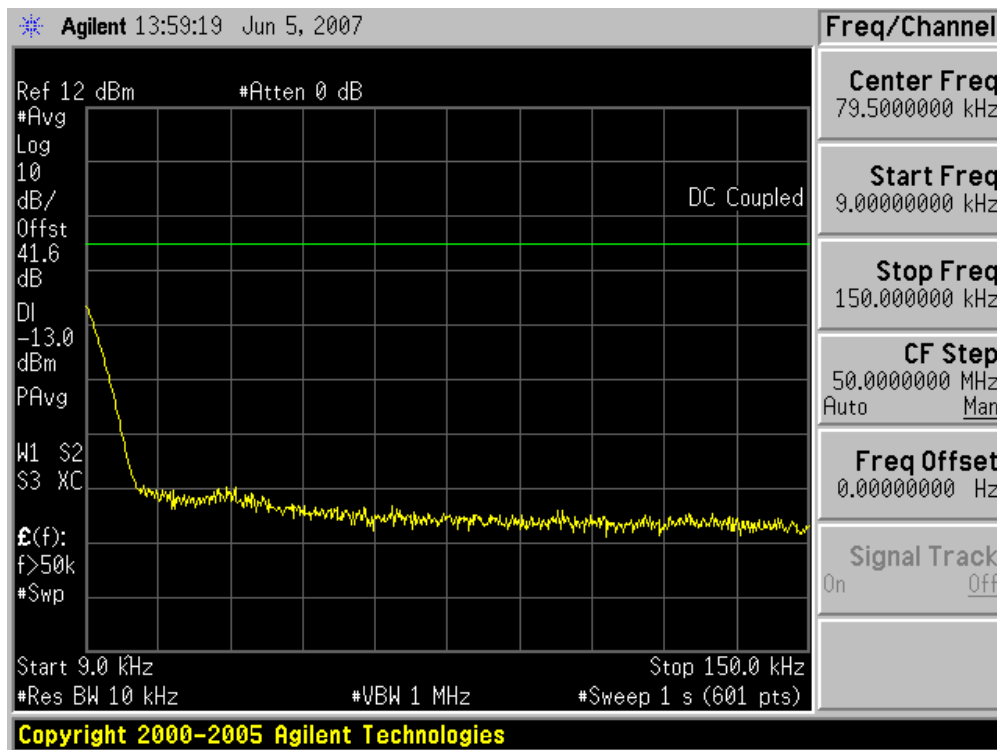

9 kHz – 150 kHz (2499 MHz, 5.5 MHz Channel)

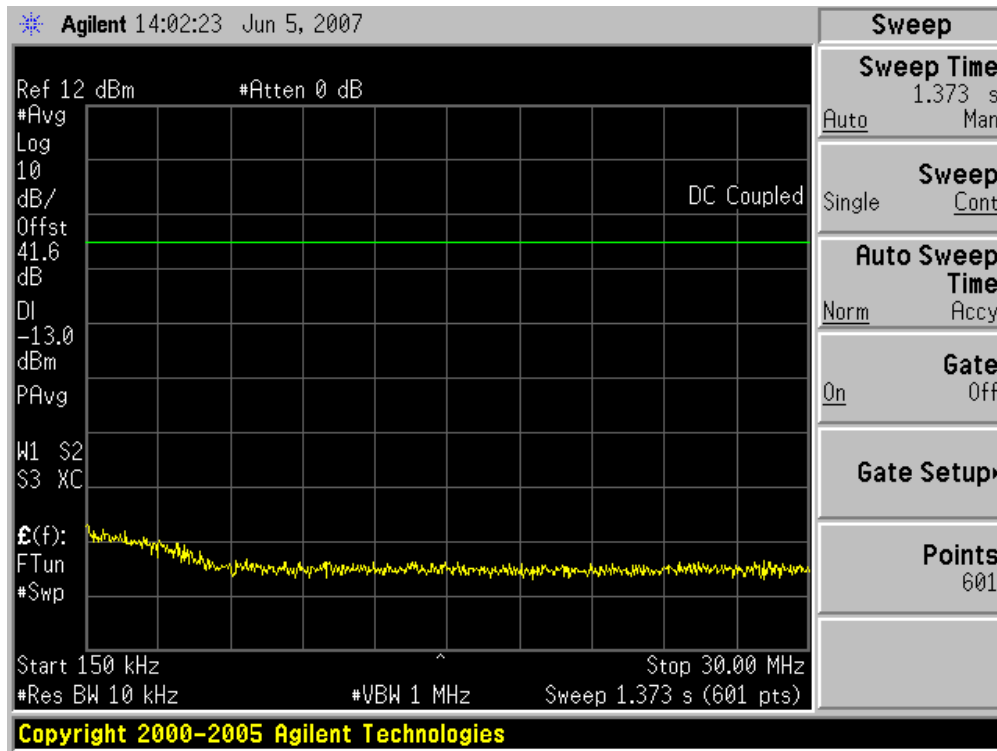

150 kHz – 30 MHz (2499 MHz, 6 MHz Channel)

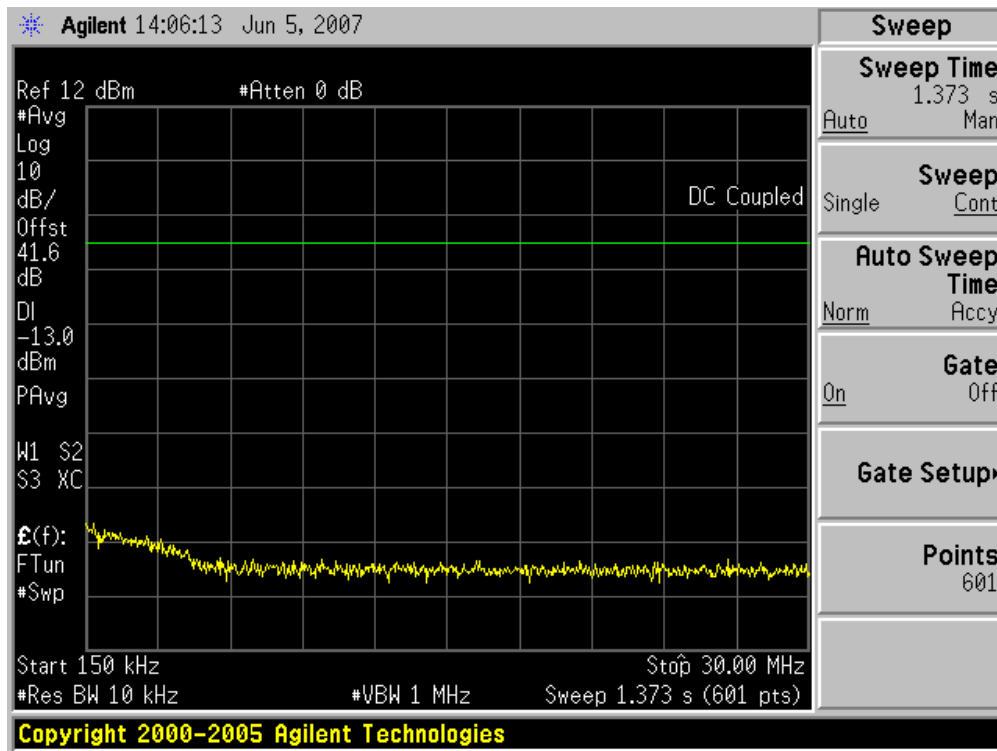

150 kHz – 30 MHz (2499 MHz, 5.5 MHz Channel)

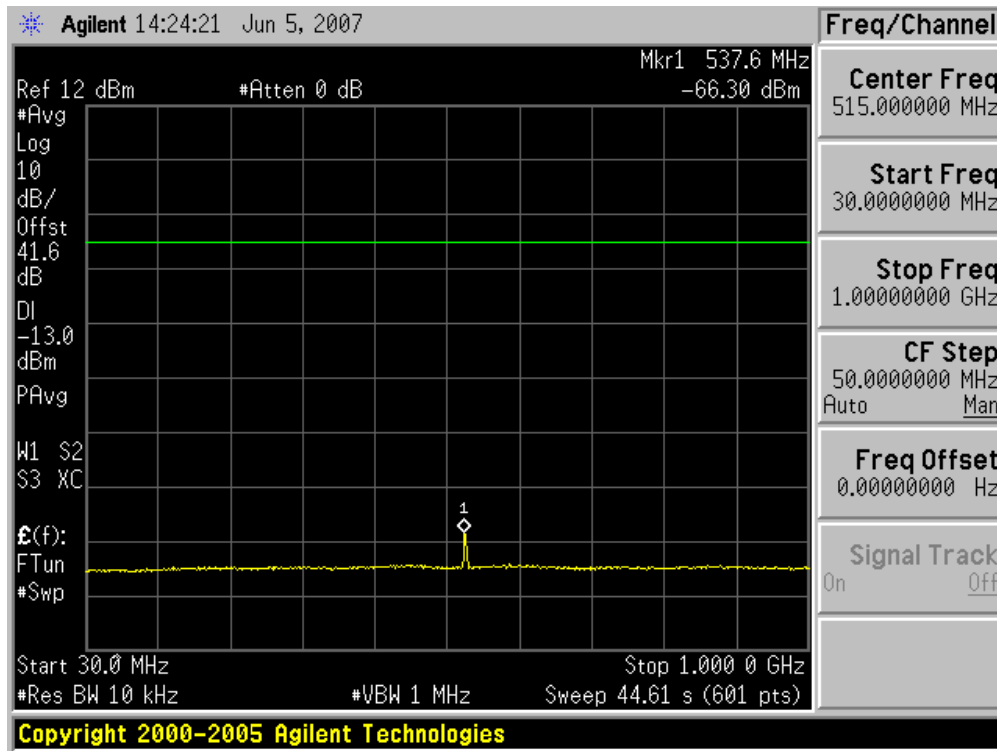

30 MHz – 1 GHz (2499 MHz, 6 MHz Channel)

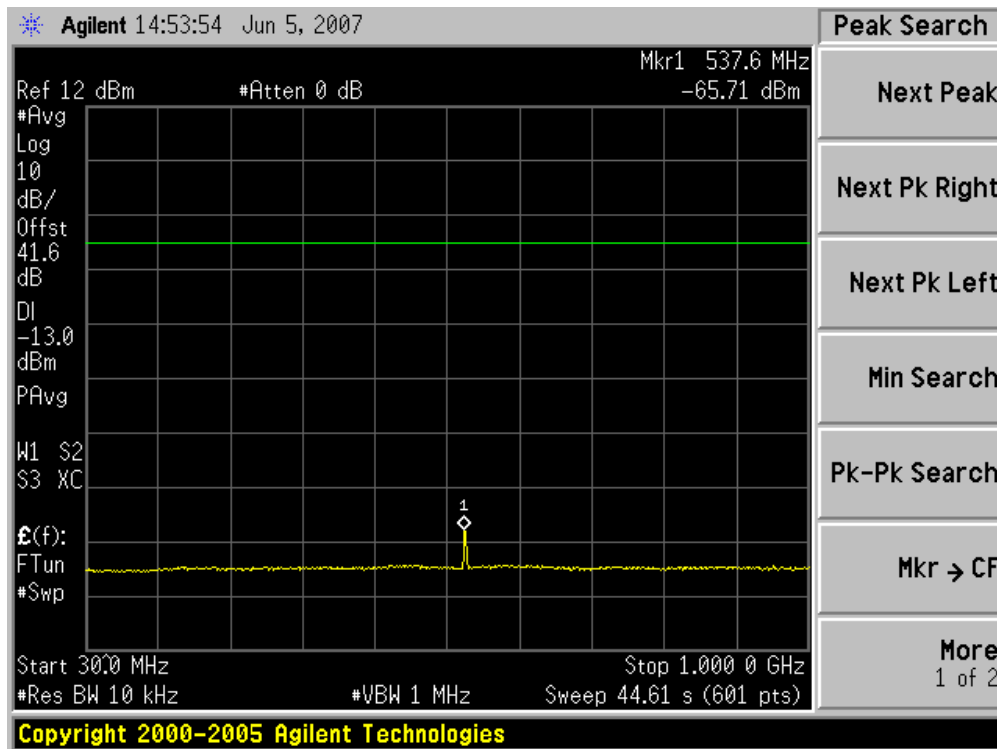

30 MHz – 1 GHz (2499 MHz, 5.5 MHz Channel)

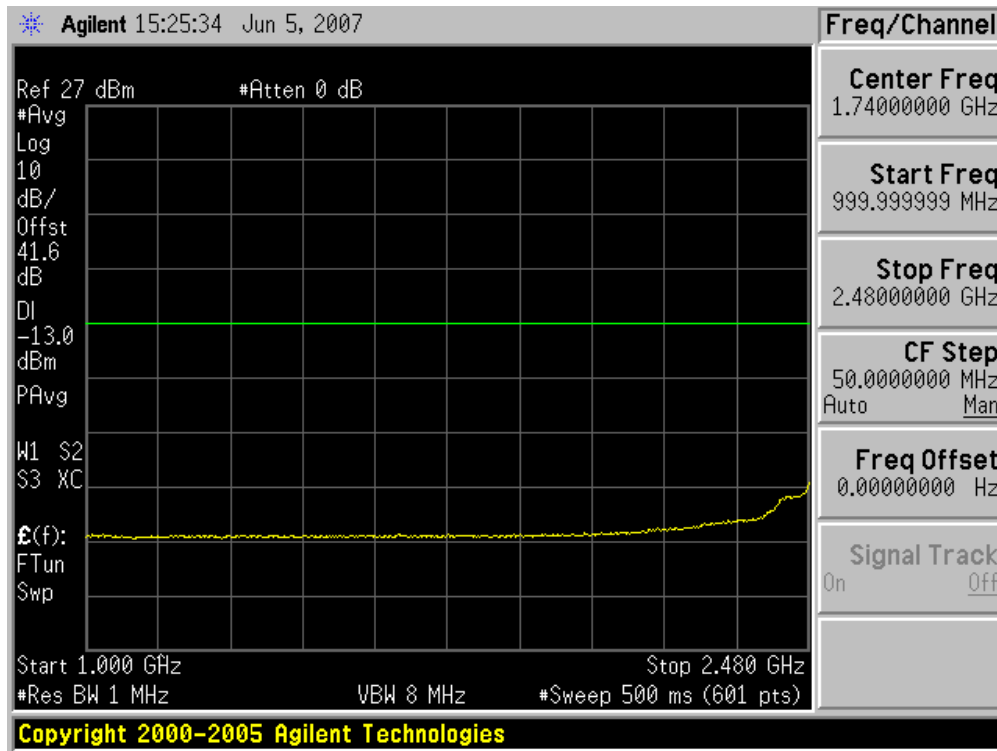

1 GHz – 2.48 GHz (2499 MHz, 6 MHz Channel)

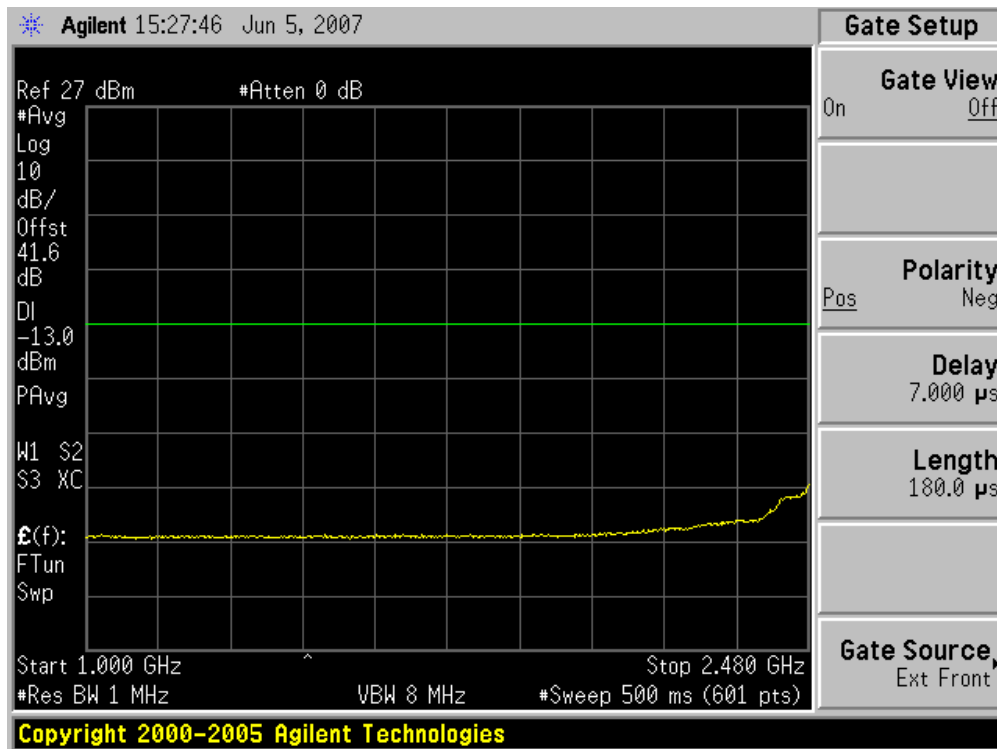

1 GHz – 2.48 GHz (2499 MHz, 5.5 MHz Channel)

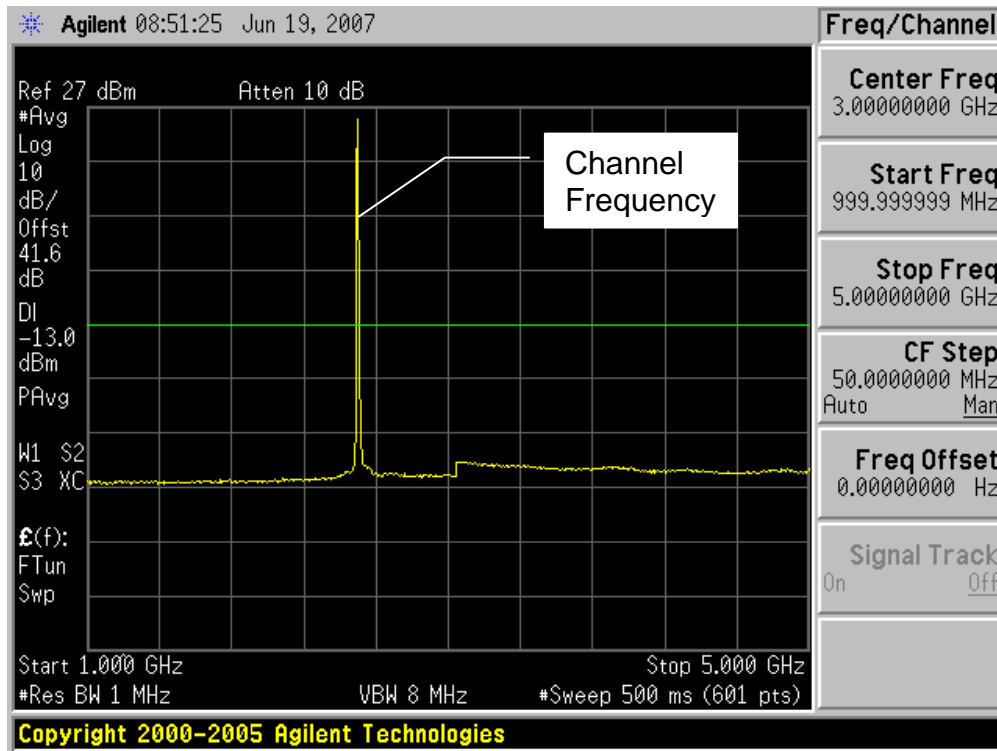

1 – 5 GHz (2499 MHz, 6 MHz Channel)

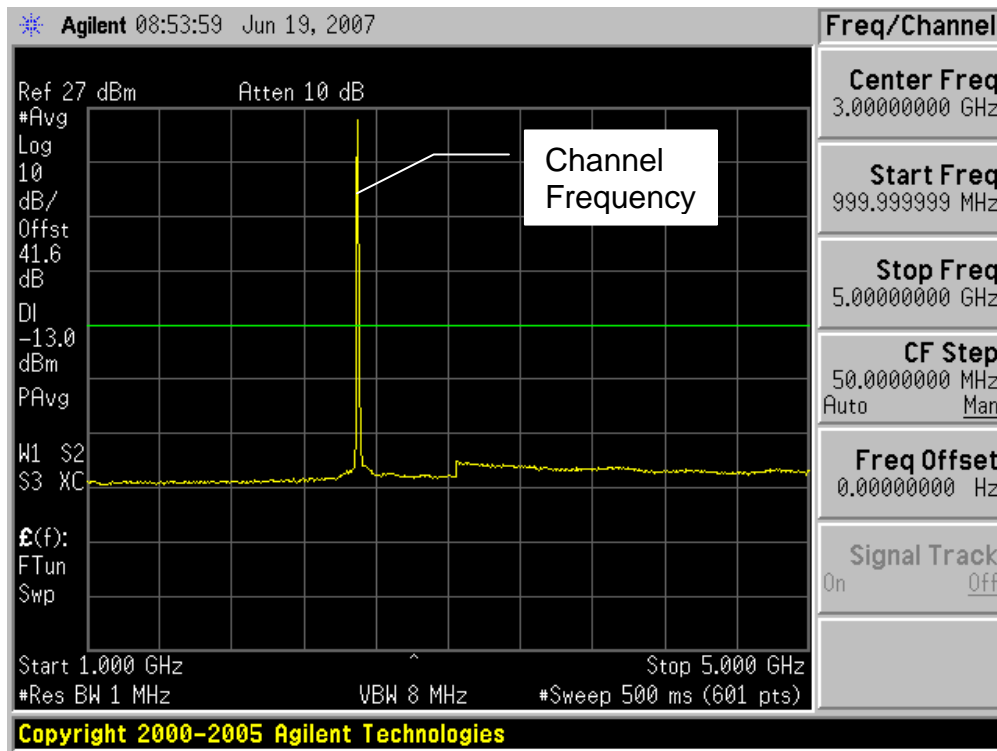

1 – 5 GHz (2499 MHz, 5.5 MHz Channel)

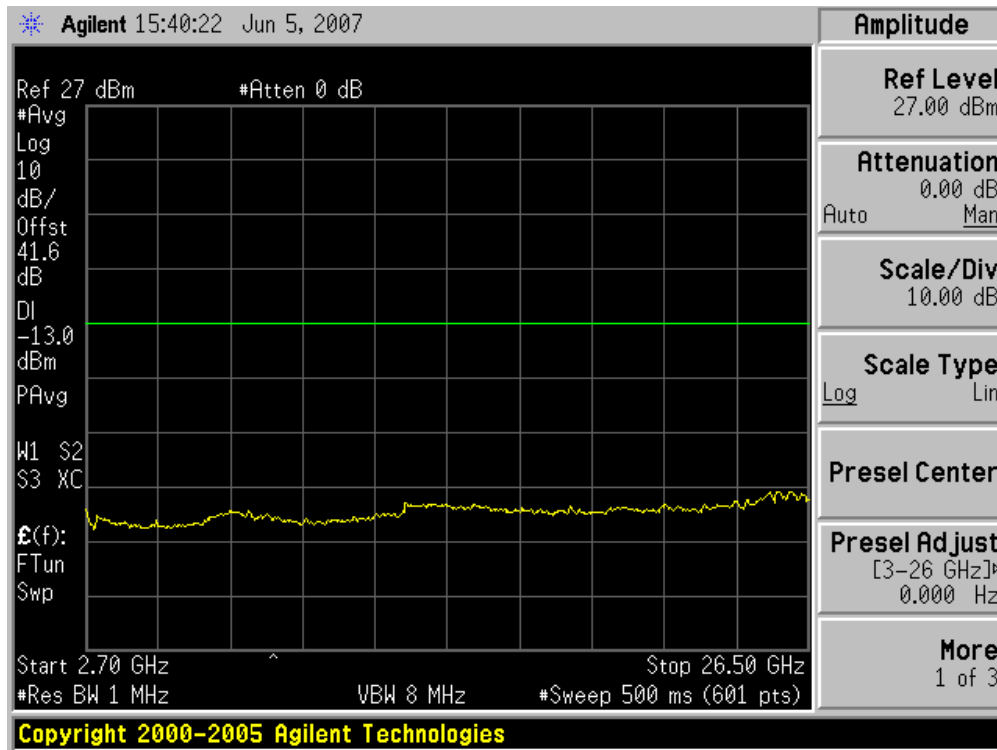

2.7 GHz – 26.5 GHz (2499 MHz, 6 MHz Channel)

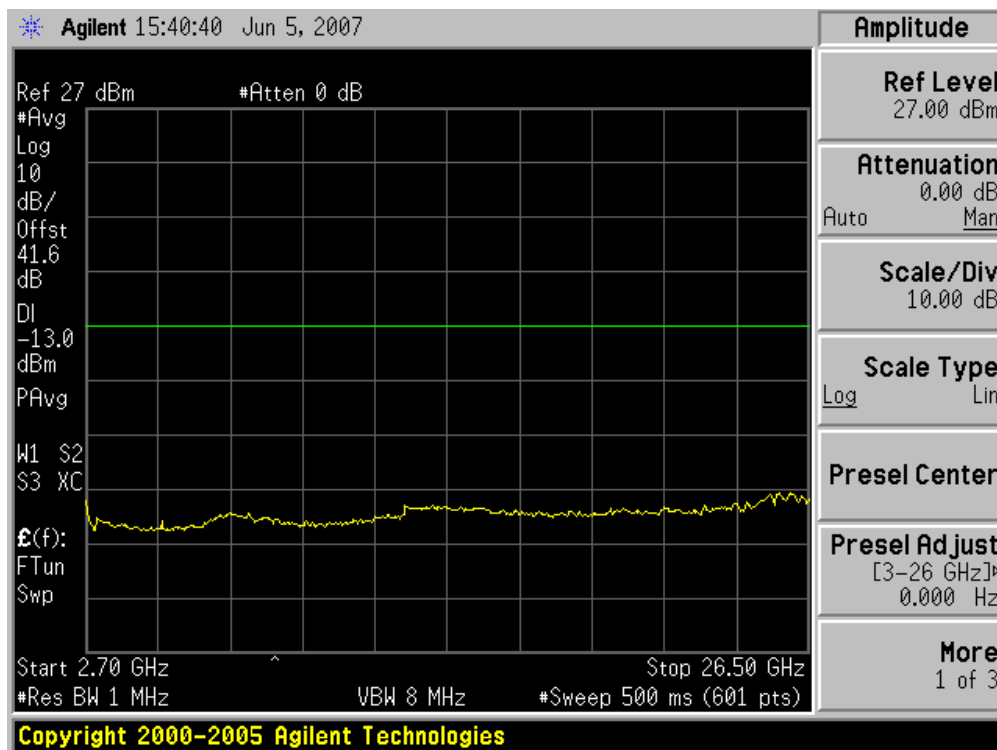

2.7 GHz – 26.5 GHz (2593 MHz, 6 MHz Channel)



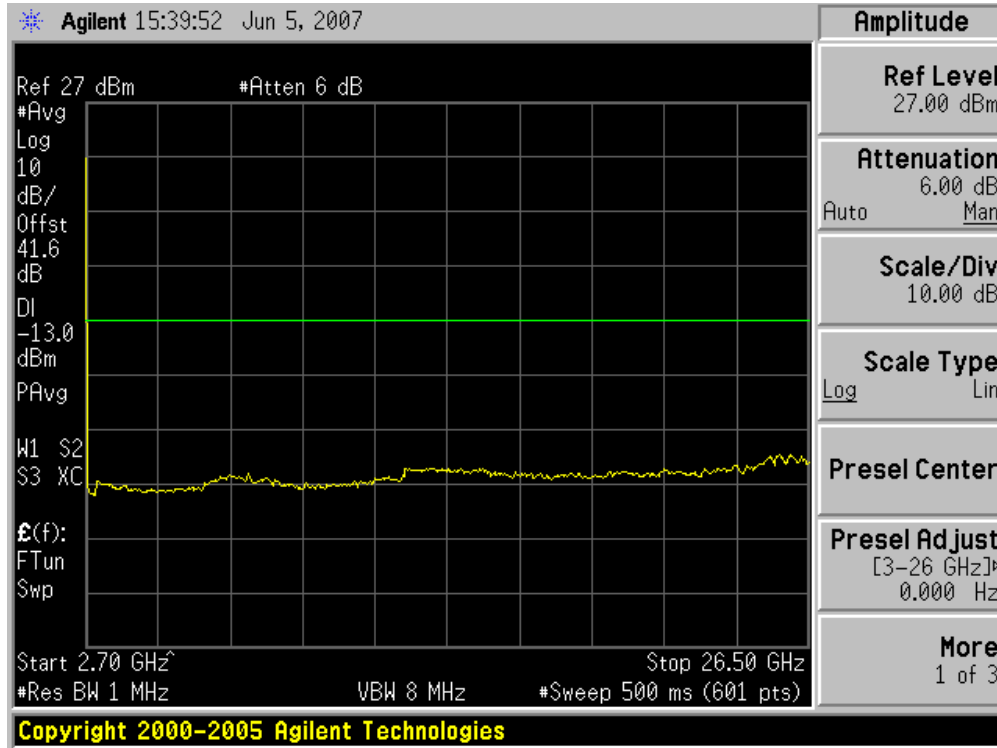

2.7 GHz – 26.5 GHz (2687 MHz, 6 MHz Channel)

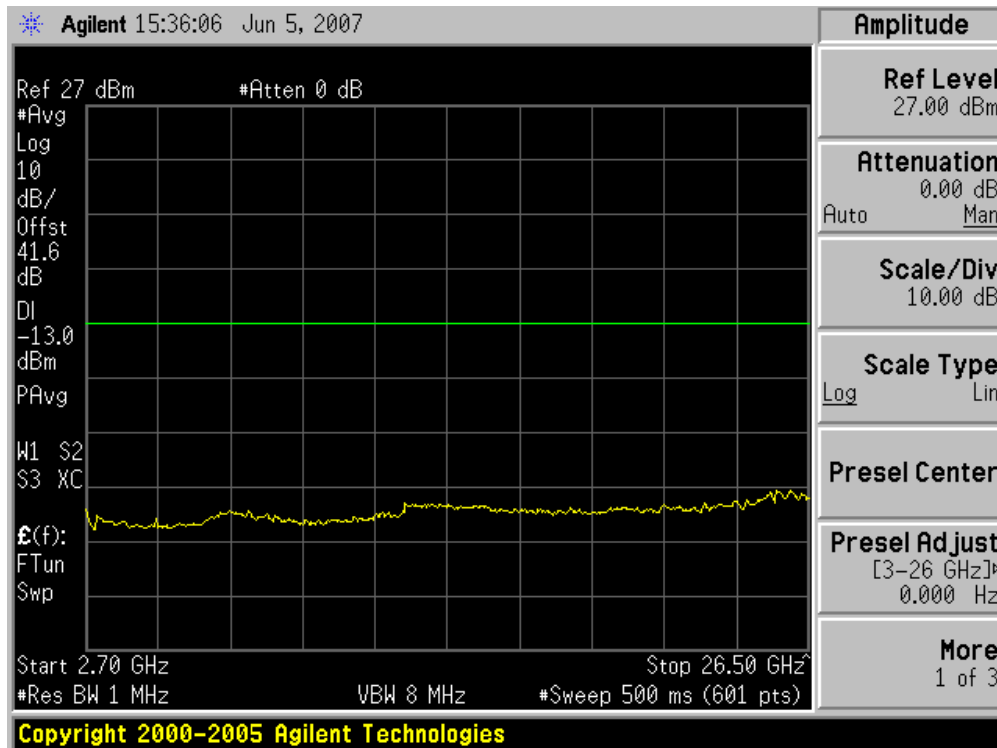

2.7 GHz – 26.5 GHz (2499 MHz, 5.5 MHz Channel)

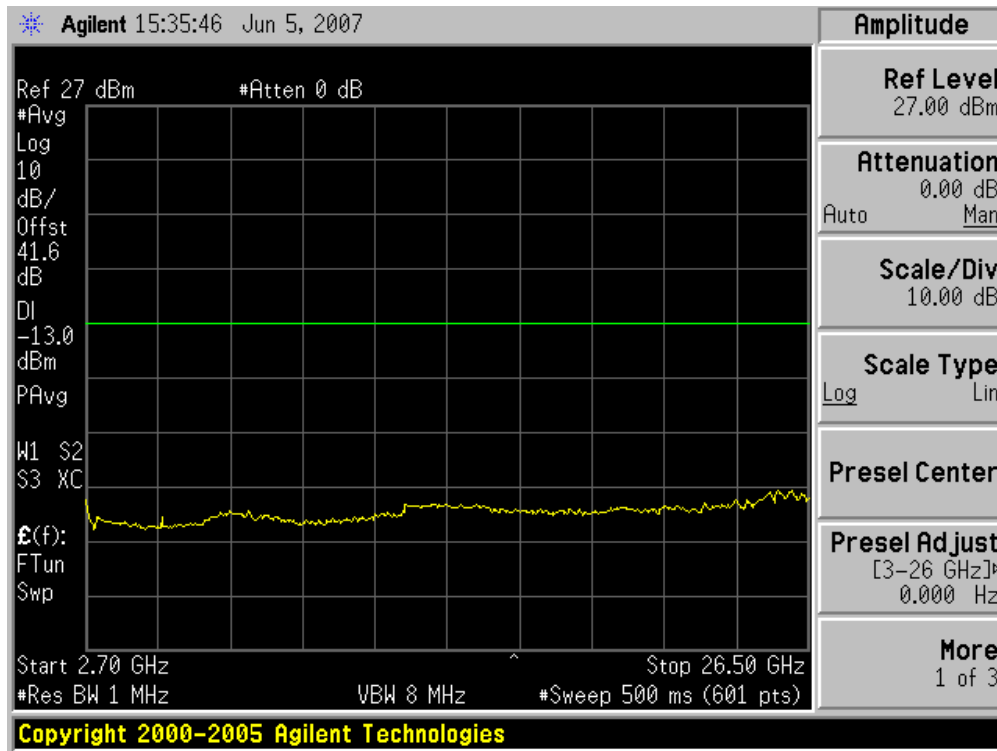

2.7 GHz – 26.5 GHz (2593 MHz, 5.5 MHz Channel)

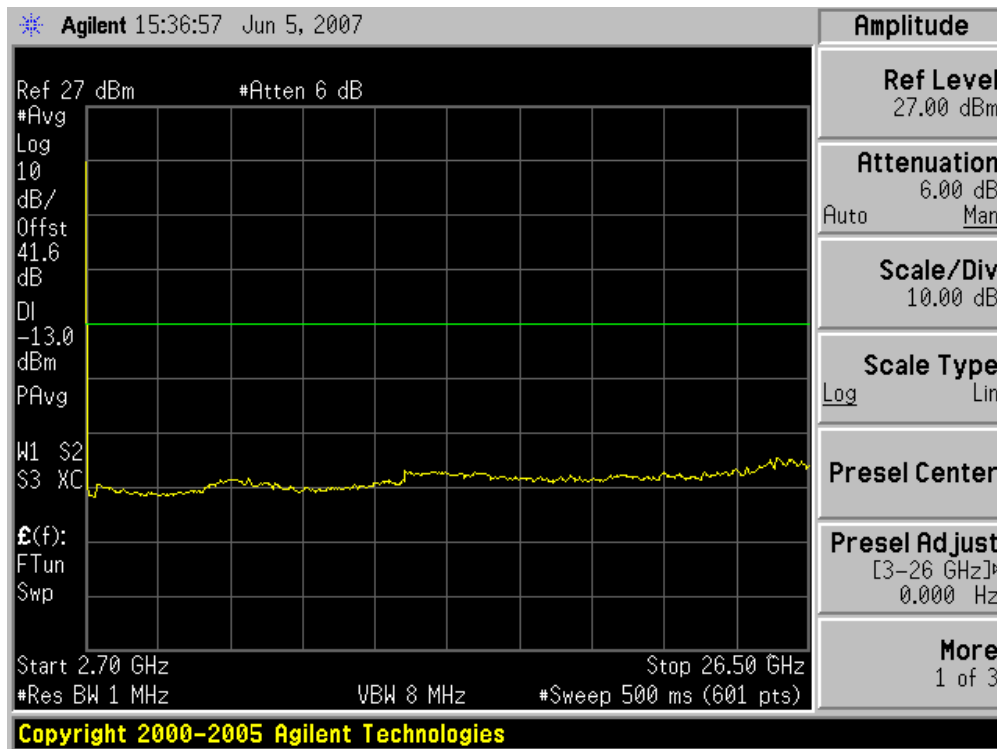

2.7 GHz – 26.5 GHz (2687 MHz, 5.5 MHz Channel)

5.6.2. Second Harmonic Emissions Plots

Plots are shown for the second harmonic of all test channels.

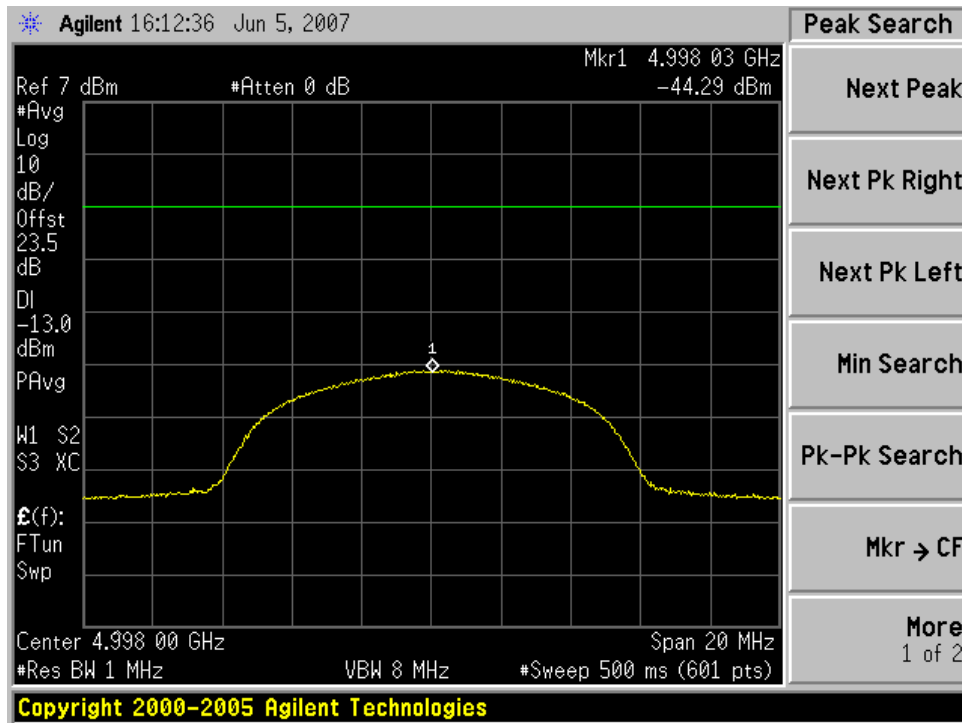

2<sup>nd</sup> Harmonic of 2499 MHz (6 MHz Channel)

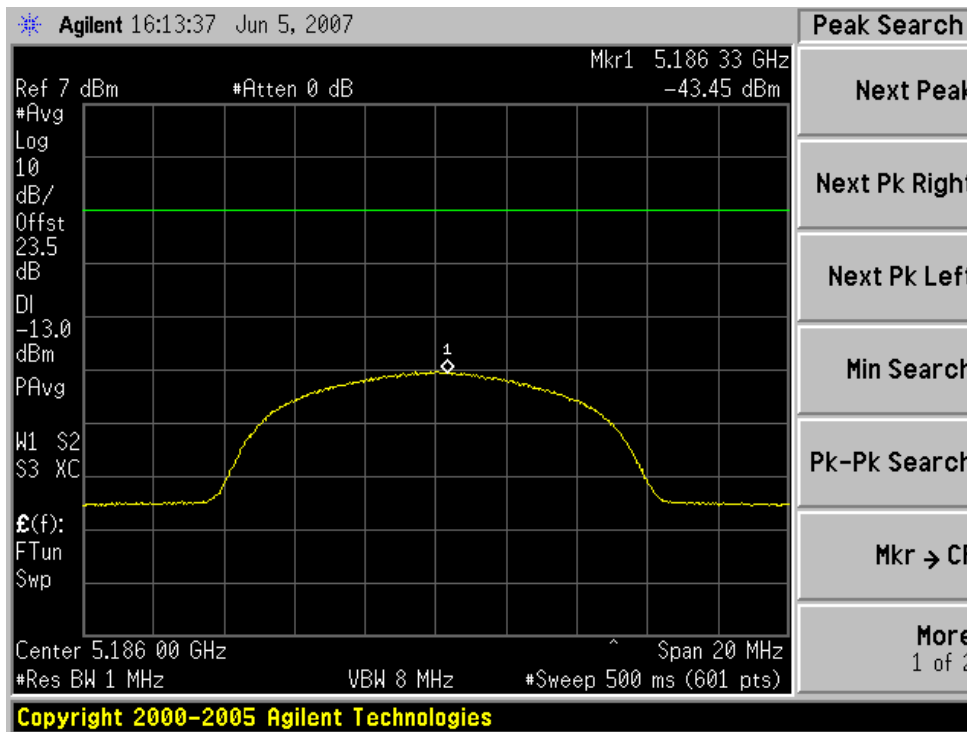

2<sup>nd</sup> Harmonic of 2593 MHz (6 MHz Channel)

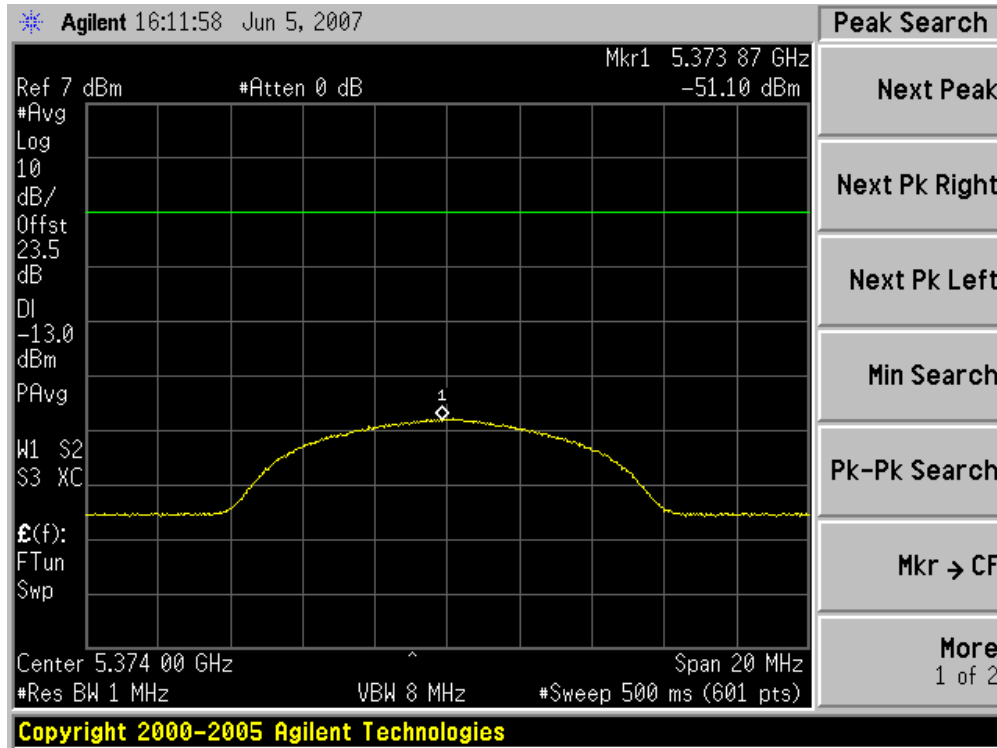

2<sup>nd</sup> Harmonic of 2687 MHz (6 MHz Channel)

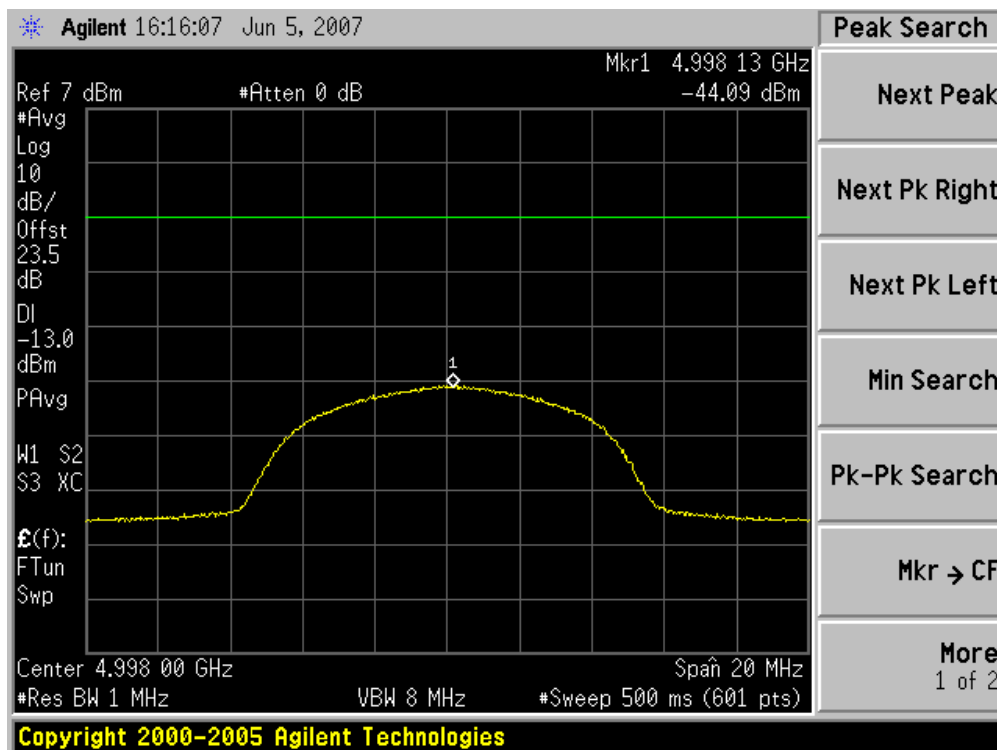

2<sup>nd</sup> Harmonic of 2499 MHz (5.5 MHz Channel)

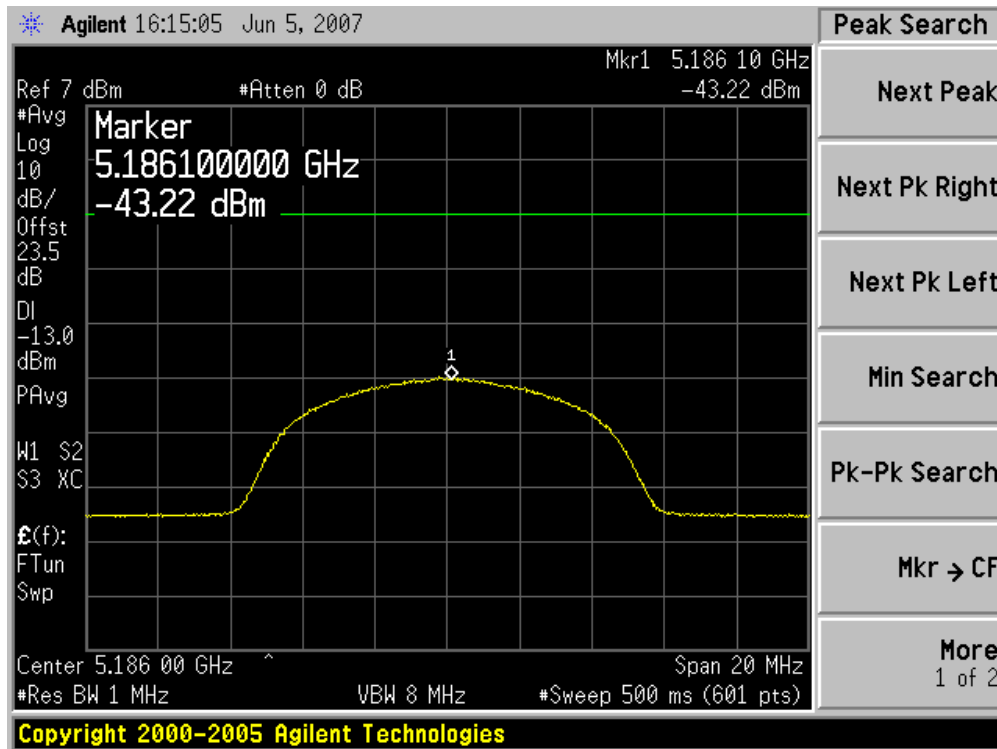

2<sup>nd</sup> Harmonic of 2593 MHz (5.5 MHz Channel)

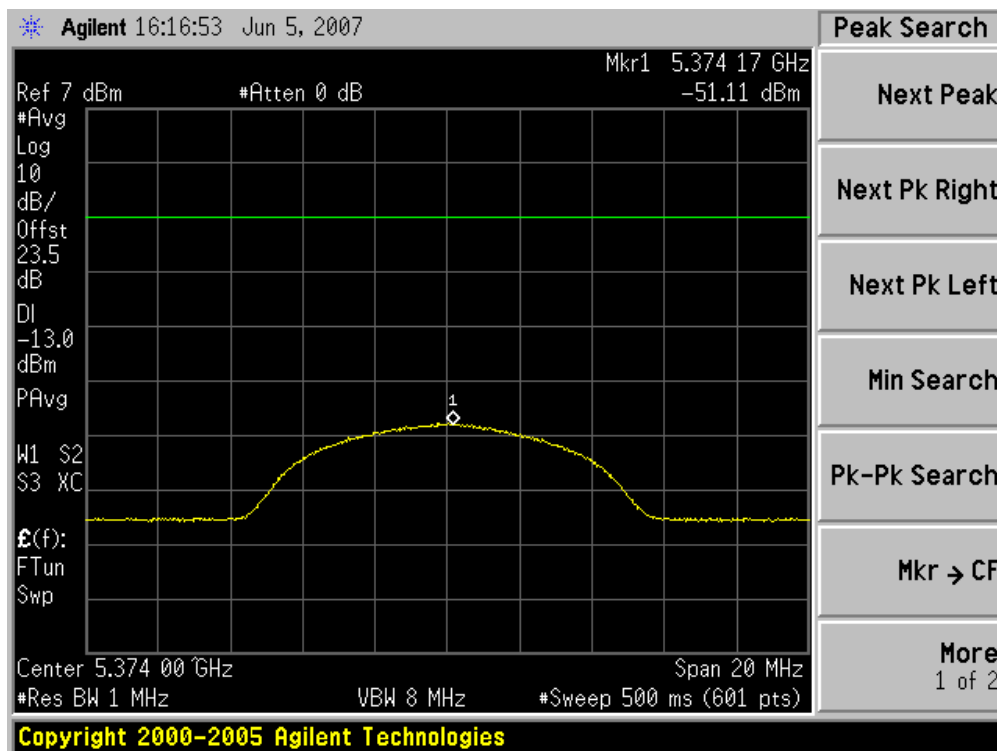

2<sup>nd</sup> Harmonic of 2687 MHz (5.5 MHz Channel)

5.6.3. Harmonic 3 Emissions Plots

Plots are shown for the third harmonic of all test channels.

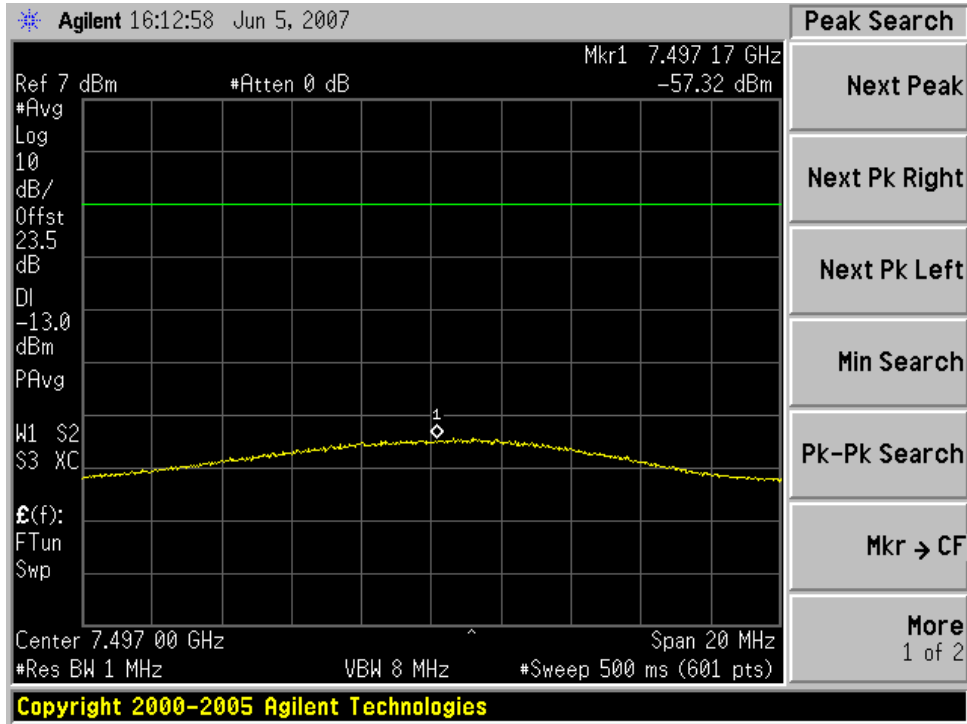

3<sup>rd</sup> Harmonic of 2499 MHz (6.0 MHz Channel)

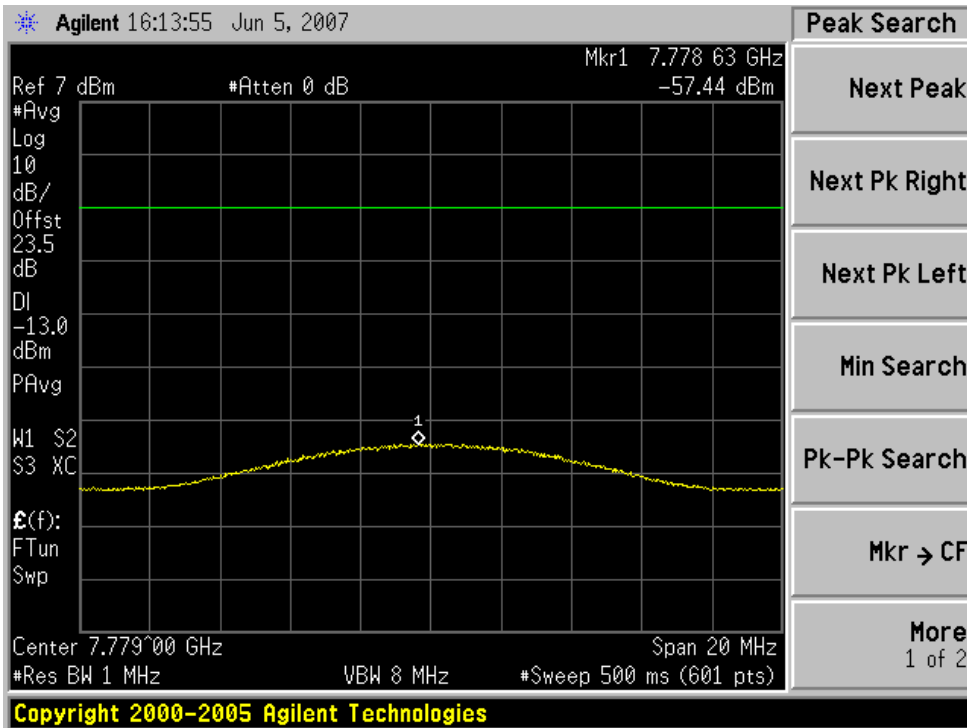

3<sup>rd</sup> Harmonic of 2593 MHz (6.0 MHz Channel)

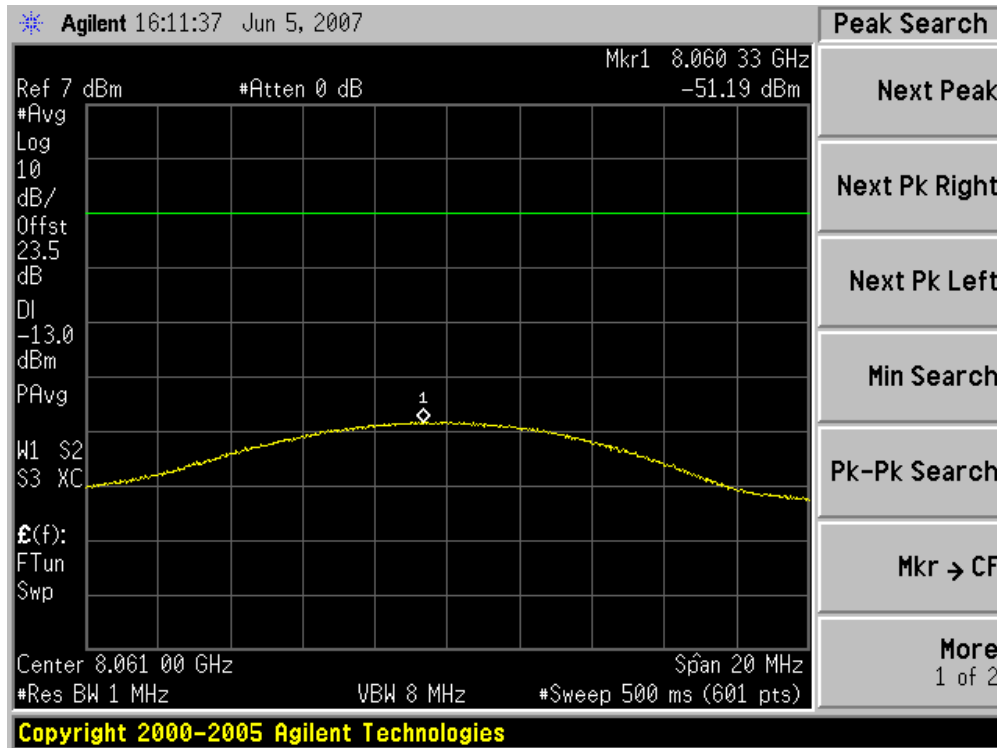

3<sup>rd</sup> Harmonic of 2687 MHz (6.0 MHz Channel)

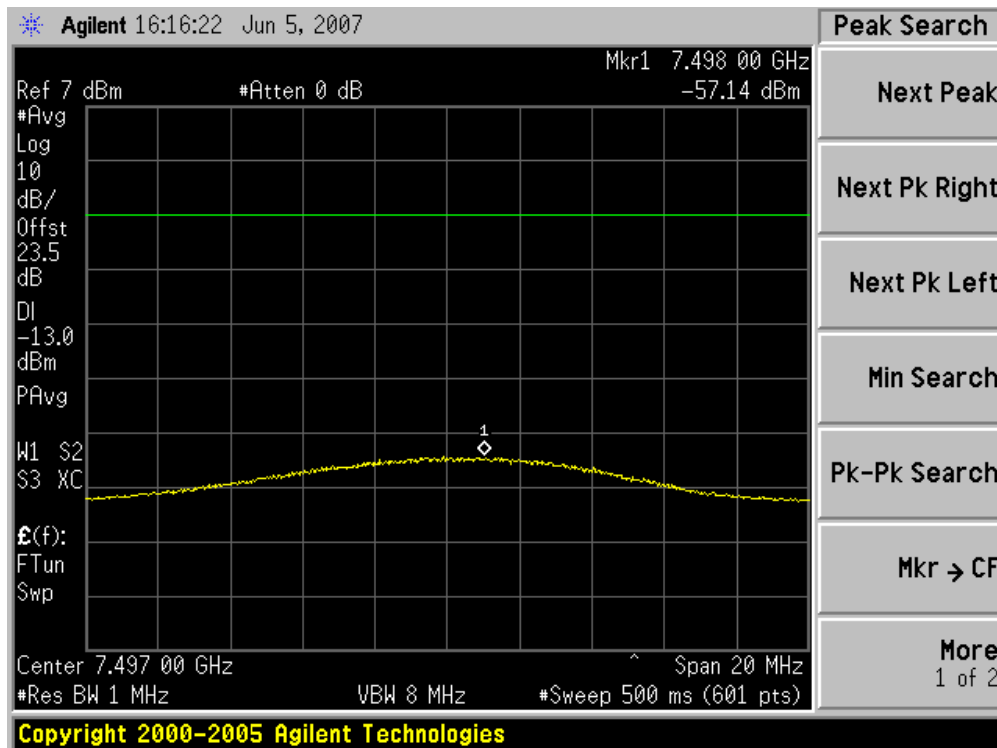

3<sup>rd</sup> Harmonic of 2499 MHz (5.5 MHz Channel)

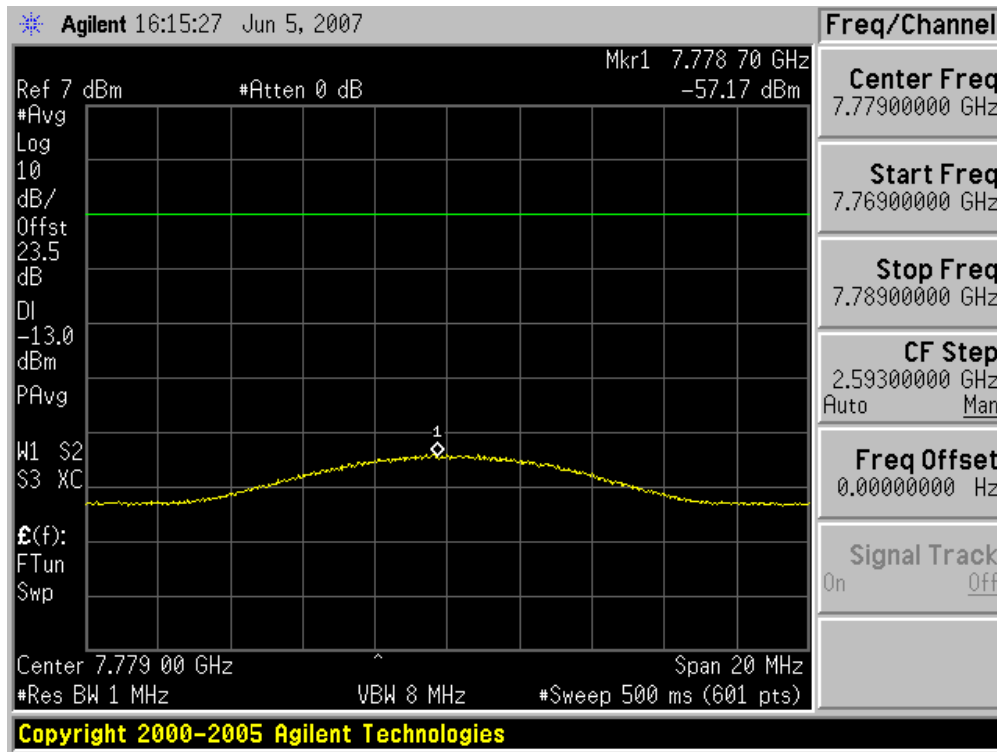

3rd Harmonic of 2593 MHz (5.5 MHz Channel)

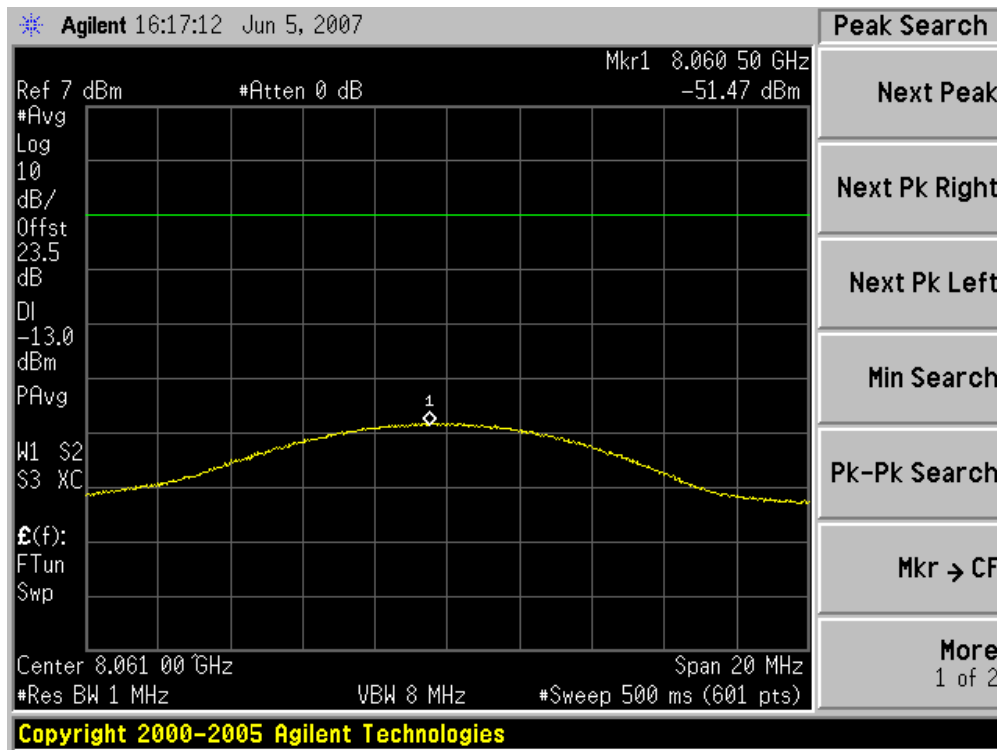

3rd Harmonic of 2687 MHz (5.5 MHz Channel)



## 5.7 Field Strength of Spurious Radiation

FCC Rules: 2.1053, 2.1049, 2.1057

FCC Requirement: Emissions to be  $43+10*\log(P)$  below the channel power or an absolute level of -13 dBm

Frequency Range = 30 MHz to 26.86 GHz

Case Radiation Attenuation =  $43+10\log P = -13$  dBm maximum

Standards: TIA-603-C  
TIA Standard, Land Mobile FM or PM Communications  
Equipment, Measurement and Performance Standards

ANSI C63.4-2001 clause 5.4 Radiated Emissions Tests.  
American National Standard for Methods of Measurement of  
Radio-Noise Emissions from Low-Voltage Electrical and  
Electronic Equipment in the Range of 9 kHz to 40 GHz.

Test Procedure: The field strength of spurious radiation was measured at an open area test site with the applicable measurement antennas, low noise amplifiers, and spectrum analyzers. This test was performed with the transmitter/receiver port terminated with its integral antenna. Measurements were performed by TUV America located in Taylors Falls, Minnesota on June 11<sup>th</sup>, 12<sup>th</sup>, 14<sup>th</sup>, 15<sup>th</sup>, 18<sup>th</sup>, and 22<sup>nd</sup>, 2007. Spurious signals were maximized for peak level by rotation of the test unit and elevation of the measurement antenna. Verification of compliance to the emissions limit was accomplished by antenna substitution as detailed in the TIA-603-C specification. TUV America-Product Service FCC registration number: 90983

Test Conditions: **Frequency:** 2499, 2593, 2687 MHz  
**Channel bandwidths:** 5.5 MHz and 6.0 MHz  
**Temperature:** 25°C  
**Supply Voltage:** 120 VAC / 60 Hz nominal to DUT power supply

Test Results: Passes Field Strength of Spurious Radiation  
Refer to attached TUV Test Report: 5C EMC Test Report.pdf

## 5.8 Frequency Stability Test

FCC Rules: 2.1055, 27.53(1)(4), 27.53(1)(6), 27.54

FCC Requirement: The frequency stability shall be sufficient to ensure that the fundamental emissions stay within the authorized bands of operation.

Standard: TIA-603-C

Test Procedure: The frequency stability of the Motorola, Inc. RDMi-25100 Expedience fundamental oscillator is derived from the on board 40 MHz TCXO. Since each radio channel operating frequency is synthesized and referenced to the 40 MHz TCXO, only one channel will be reported for frequency stability as all channels will have the same frequency characteristics.

The procedure used for “Modulation Characteristics”, section 5.4 of this document was repeated to show compliance to the Frequency Stability requirements for the Expedience transmitter of the RDMi-25100 product.

Test Set-Up:

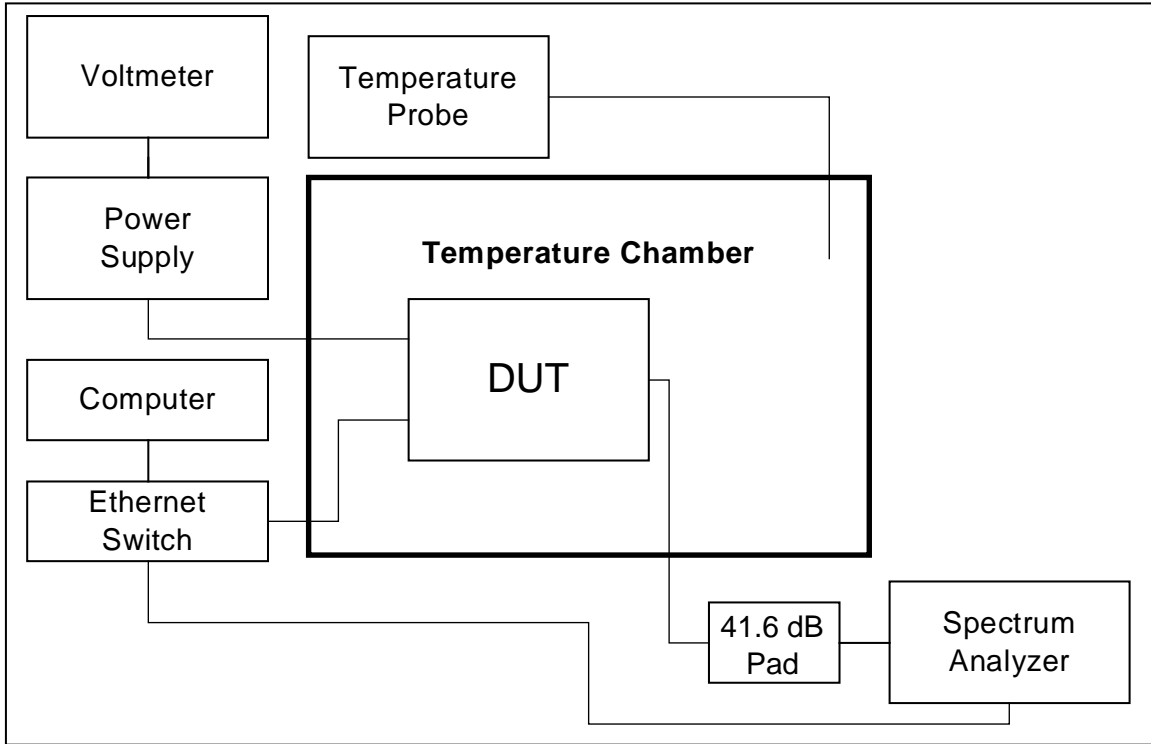

**Frequency Stability Test Setup**

### 5.8.1. Temperature Variation Test Results

Test Conditions: **Frequency:** 2593 MHz (5.5 and 6.0 MHz channel bandwidths)  
**Supply Voltage:** 120 VAC / 60 Hz nominal to DUT power supply  
**Temperature:** -30° C to +50° C in 10° C increments

Test Results: Pass Temperature Variation  
 The tables below summarize the information from the plots contained in this section and in the Appendix.

| Frequency Stability Emissions 2.593 GHz 6.0 MHz Bandwidth |      |        |        |                         |        |        |                         |
|---|------|--------|--------|-------------------------|--------|--------|-------------------------|
| Temp °C   | a/A  | b      | B      | Margin to -13 dBm limit | g      | G      | Margin to -25 dBm limit |
| -30   | Pass | -15.51 | -18.76 | 2.51                    | -28.05 | -31.21 | 3.05                    |
| -20   | Pass | -15.67 | -18.82 | 2.67                    | -28.21 | -30.97 | 3.21                    |
| -10   | Pass | -16.30 | -18.61 | 3.30                    | -28.31 | -30.24 | 3.31                    |
| 0   | Pass | -18.03 | -20.36 | 5.03                    | -30.90 | -32.1  | 5.90                    |
| 10  | Pass | -18.28 | -20.33 | 5.28                    | -30.38 | -31.15 | 5.38                    |
| 20  | Pass | -18.27 | -20.00 | 5.27                    | -28.76 | -30.16 | 3.76                    |
| 30  | Pass | -18.65 | -20.19 | 5.65                    | -28.31 | -28.99 | 3.31                    |
| 40  | Pass | -19.51 | -21.63 | 6.51                    | -29.80 | -30.81 | 4.80                    |
| 50  | Pass | -19.18 | -20.91 | 6.18                    | -27.57 | -28.58 | 2.57                    |

| Frequency Stability Emissions 2.593 GHz 5.5 MHz Bandwidth |      |        |        |                         |        |        |                         |
|---|------|--------|--------|-------------------------|--------|--------|-------------------------|
| Temp °C   | a/A  | b      | B      | Margin to -13 dBm limit | g      | G      | Margin to -25 dBm limit |
| -30   | Pass | -15.62 | -18.67 | 2.62                    | -28.84 | -31.58 | 3.84                    |
| -20   | Pass | -15.91 | -18.91 | 2.91                    | -29.19 | -31.93 | 4.19                    |
| -10   | Pass | -16.55 | -18.99 | 3.55                    | -28.86 | -30.98 | 3.86                    |
| 0   | Pass | -17.84 | -20.24 | 4.84                    | -31.46 | -33    | 6.46                    |
| 10  | Pass | -18.12 | -20.23 | 5.12                    | -30.51 | -31.77 | 5.51                    |
| 20  | Pass | -18.16 | -20.11 | 5.16                    | -29.66 | -30.85 | 4.66                    |
| 30  | Pass | -18.49 | -20.27 | 5.49                    | -29.05 | -29.92 | 4.05                    |
| 40  | Pass | -20.02 | -21.52 | 7.02                    | -30.56 | -30.95 | 5.56                    |
| 50  | Pass | -18.97 | -20.51 | 5.97                    | -28.70 | -29.38 | 3.70                    |

### 5.8.2. Temperature Variation Spectrum Analyzer Plots

Spectrum analyzer plots of the 6.0 MHz bandwidth measurements follow. The plots for the 5.5 MHz bandwidth channels are similar and are located in the Appendix.

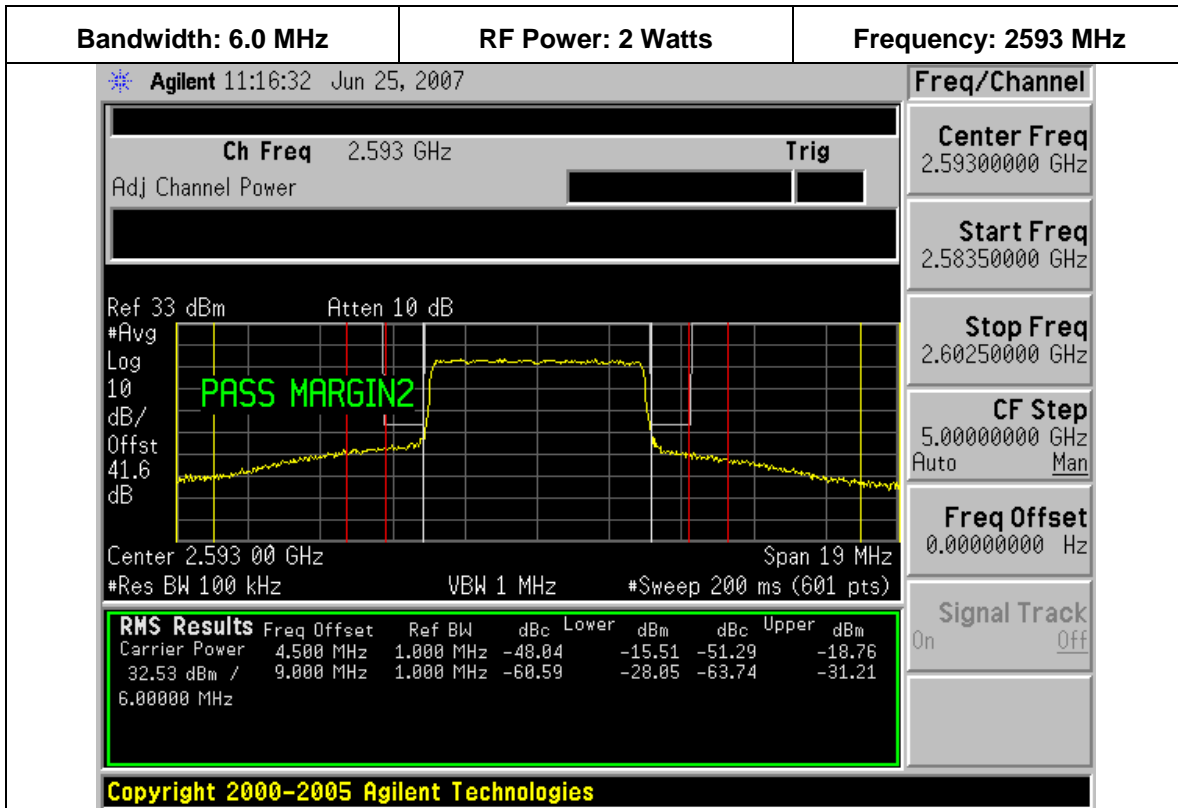

-30° C

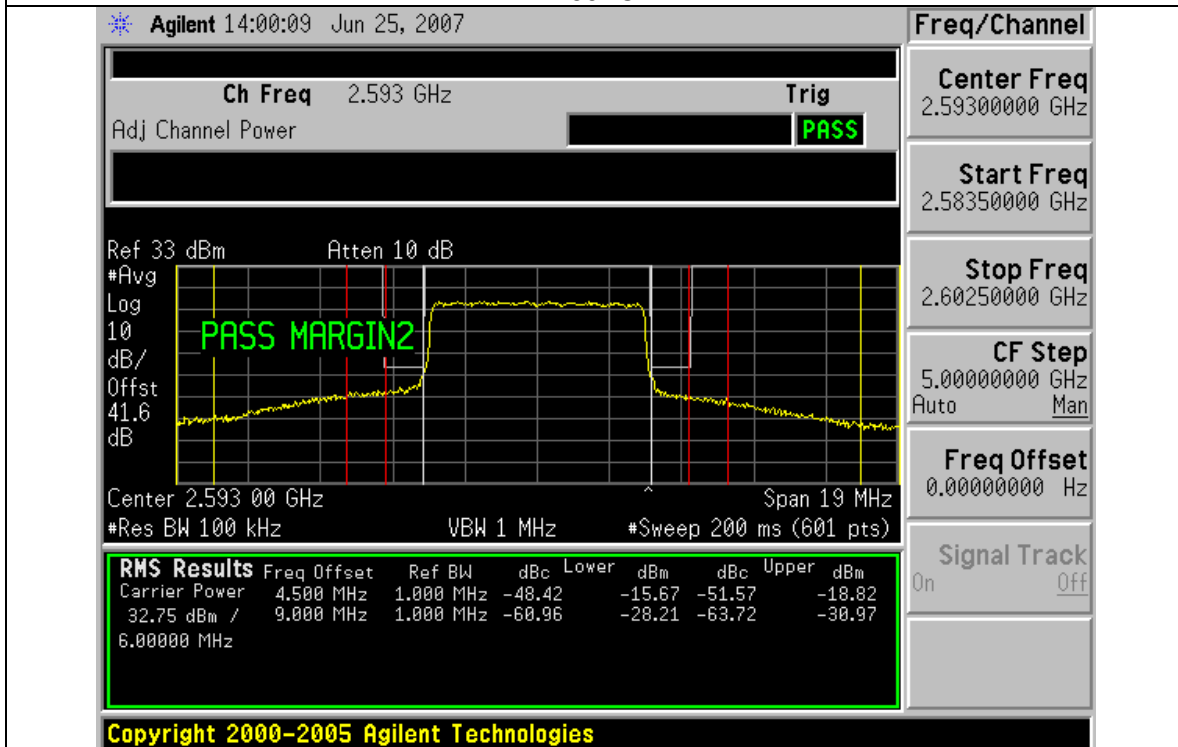

-20° C

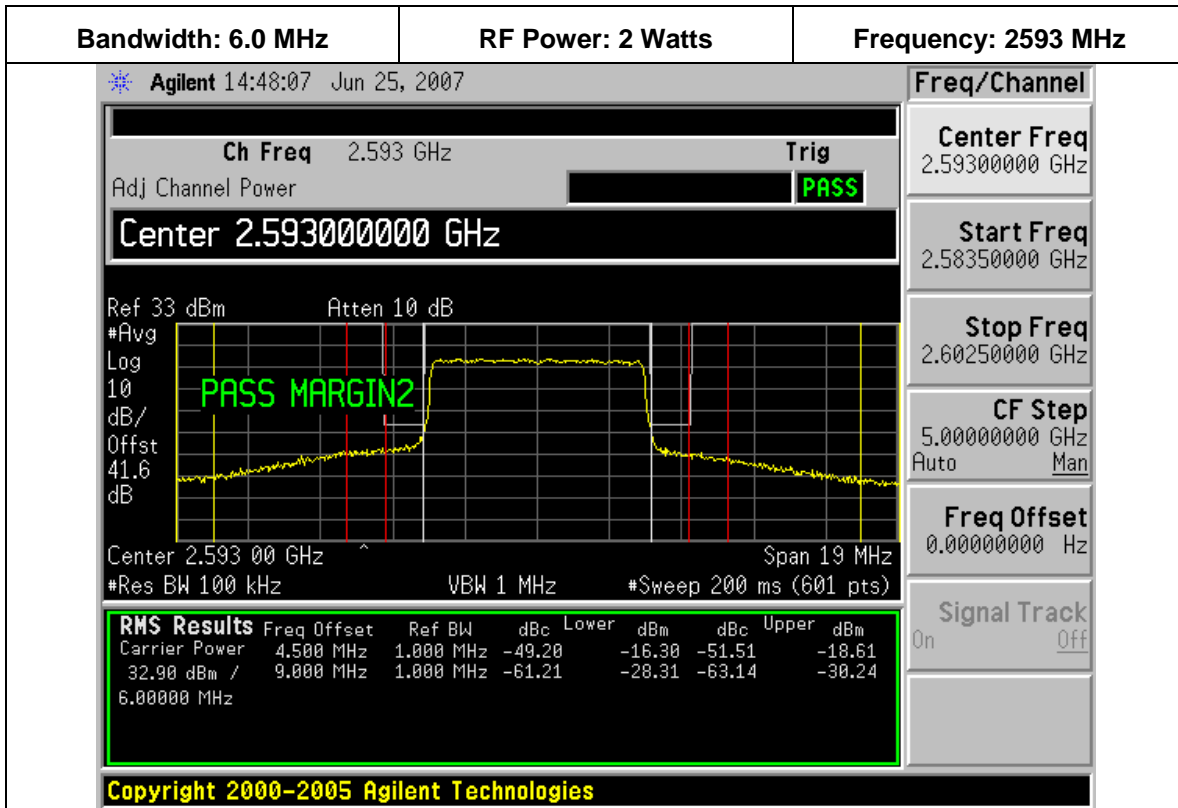

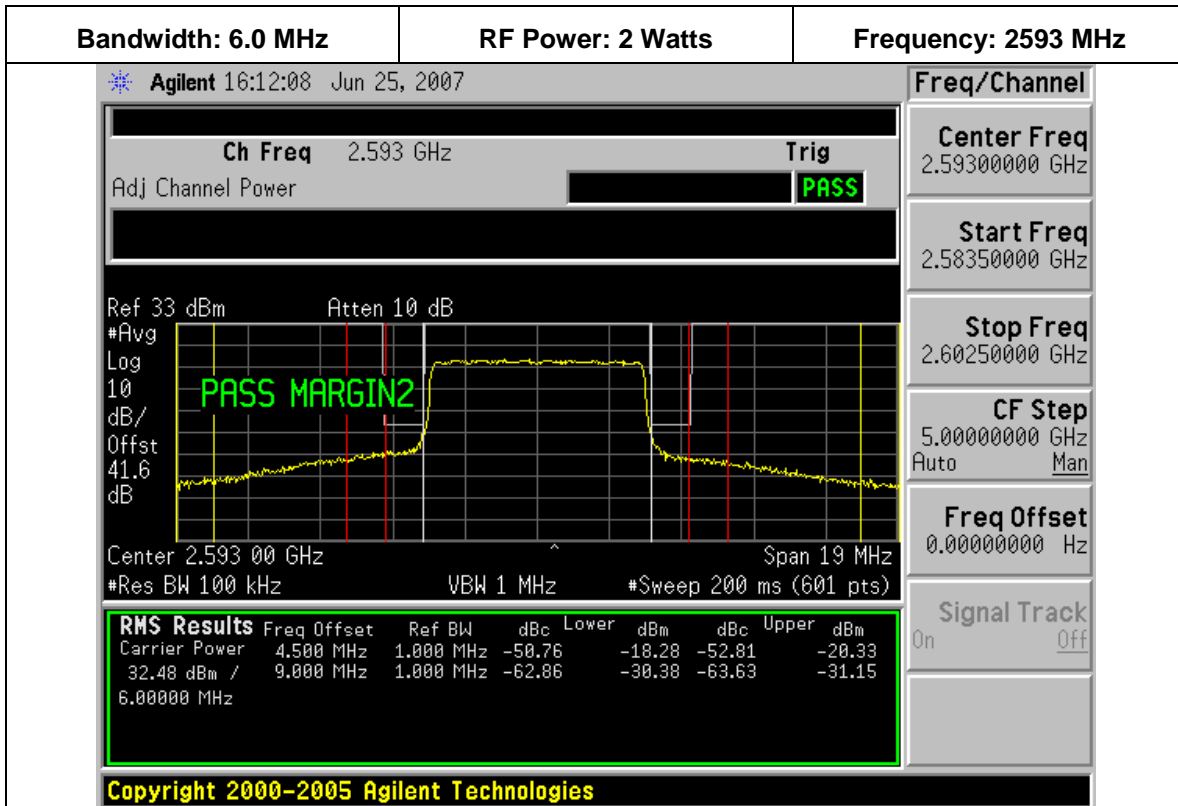

+10° C

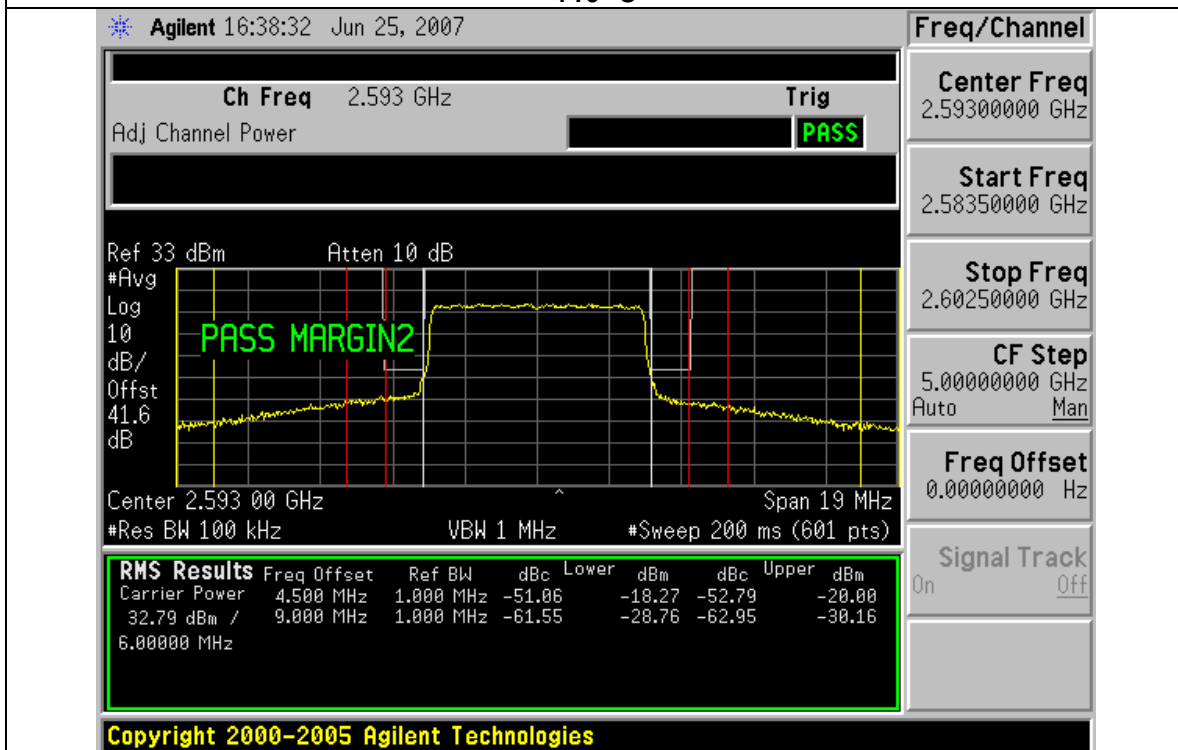

+20° C

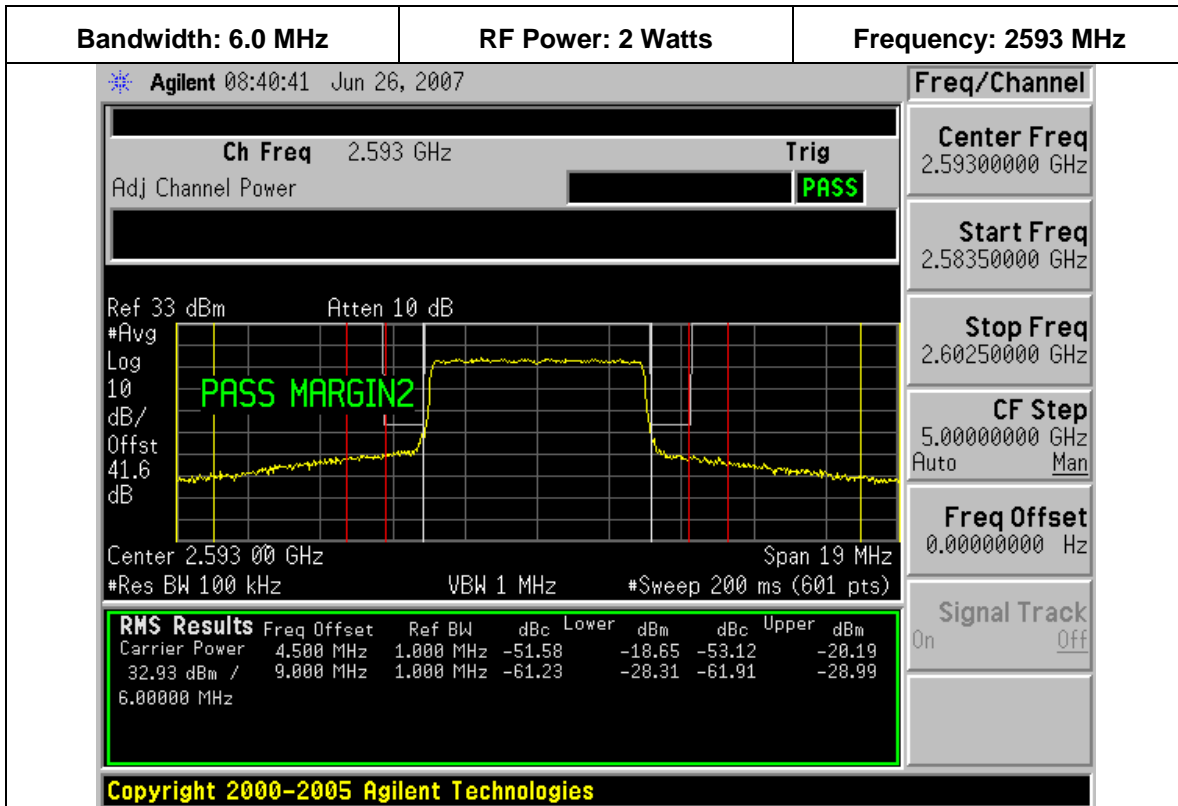

+30° C

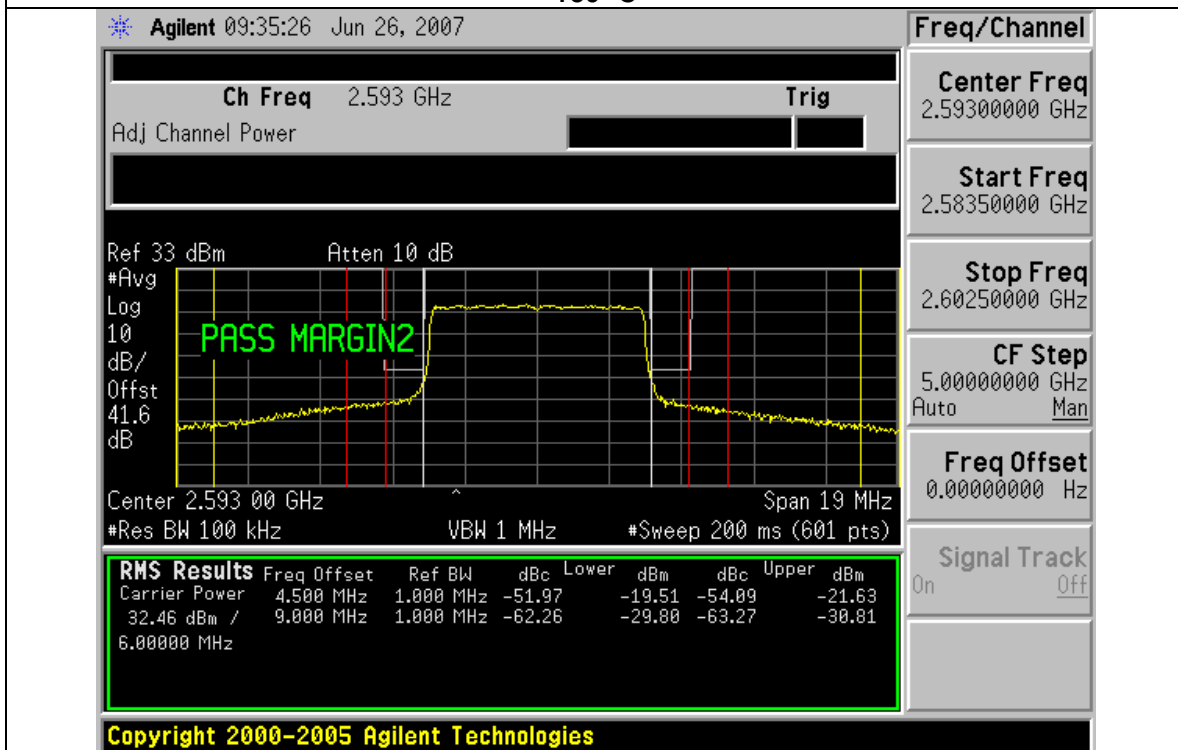

+40° C



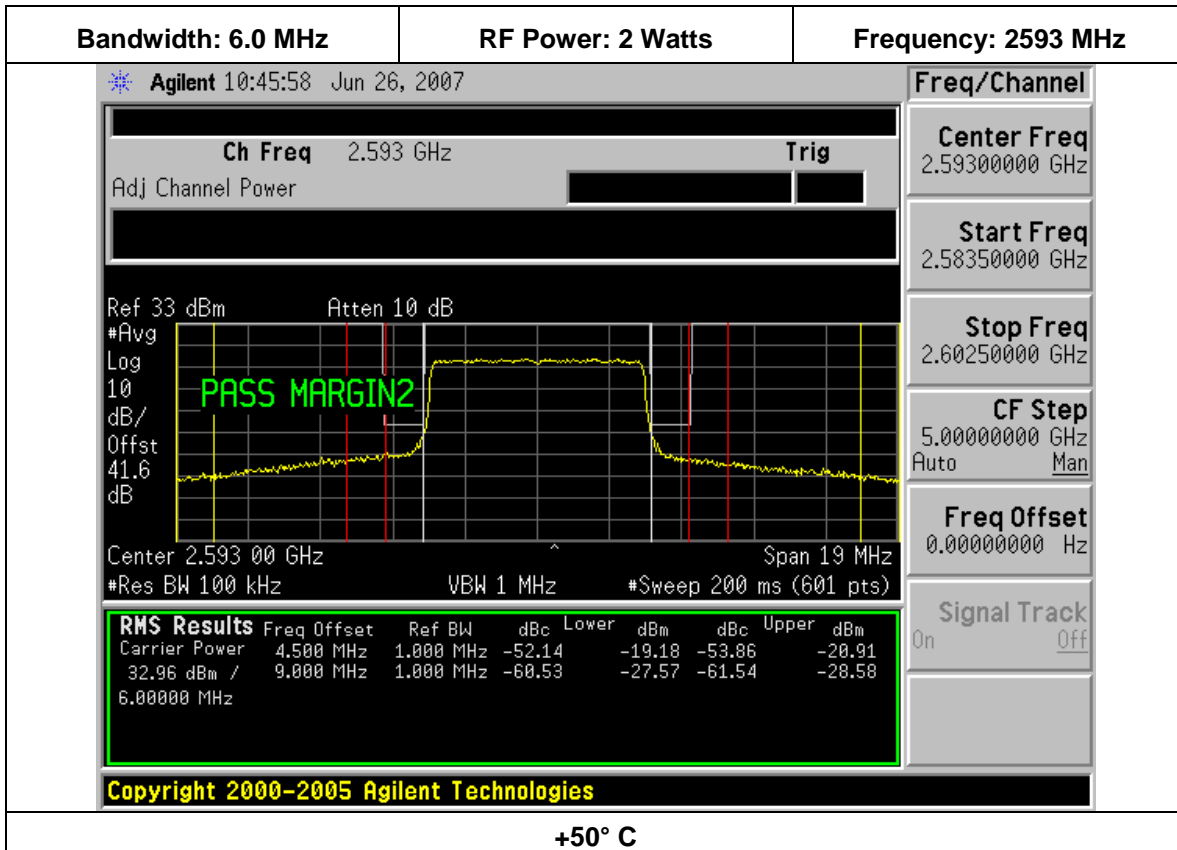

**5.8.3. Supply Voltage Variation Test Results**

Test Conditions: **Frequency:** 2593 MHz  
**Temperature:** 22°C  
**Source Input Voltage Specification:** 120.0 VAC / 60 Hz Nominal  
**Test Voltage Range:** 0.85 x 120 = 102 VAC / 60 Hz lower limit  
 1.15 x 120 = 138 VAC / 60 Hz upper limit

Test Results: Supply Voltage Variation  
 The tables below summarize the information from the plots contained in this section and in the Appendix.

| Frequency Stability Emissions 20°C 2.593 GHz 6.0 MHz Bandwidth |      |        |        |                         |        |        |                         |
|--|------|--------|--------|-------------------------|--------|--------|-------------------------|
| Source Voltage (Vdc)   | a/A  | b      | B      | Margin to -13 dBm limit | g      | G      | Margin to -25 dBm limit |
| 102  | Pass | -18.12 | -20.08 | 5.12                    | -29.08 | -30.09 | 4.08                    |
| 120  | Pass | -18.30 | -20.08 | 5.30                    | -28.95 | -30.09 | 3.95                    |
| 138  | Pass | -18.08 | -20.18 | 5.08                    | -29.20 | -30.32 | 4.20                    |

| Frequency Stability Emissions 20°C 2.593 GHz 5.5 MHz Bandwidth |      |        |        |                         |        |        |                         |
|--|------|--------|--------|-------------------------|--------|--------|-------------------------|
| Source Voltage (Vdc)   | a/A  | b      | B      | Margin to -13 dBm limit | g      | G      | Margin to -25 dBm limit |
| 102  | Pass | -18.24 | -19.95 | 5.24                    | -29.57 | -30.75 | 4.57                    |
| 120  | Pass | -18.34 | -20.20 | 5.34                    | -29.61 | -30.78 | 4.61                    |
| 138  | Pass | -18.35 | -19.93 | 5.35                    | -29.99 | -30.78 | 4.99                    |

**5.8.4. Supply Voltage Variation Spectrum Analyzer Plots**

Spectrum analyzer plots of the 6.0 MHz bandwidth measurements follow. The plots for the 5.5 MHz bandwidth channels are similar and are located in the Appendix.

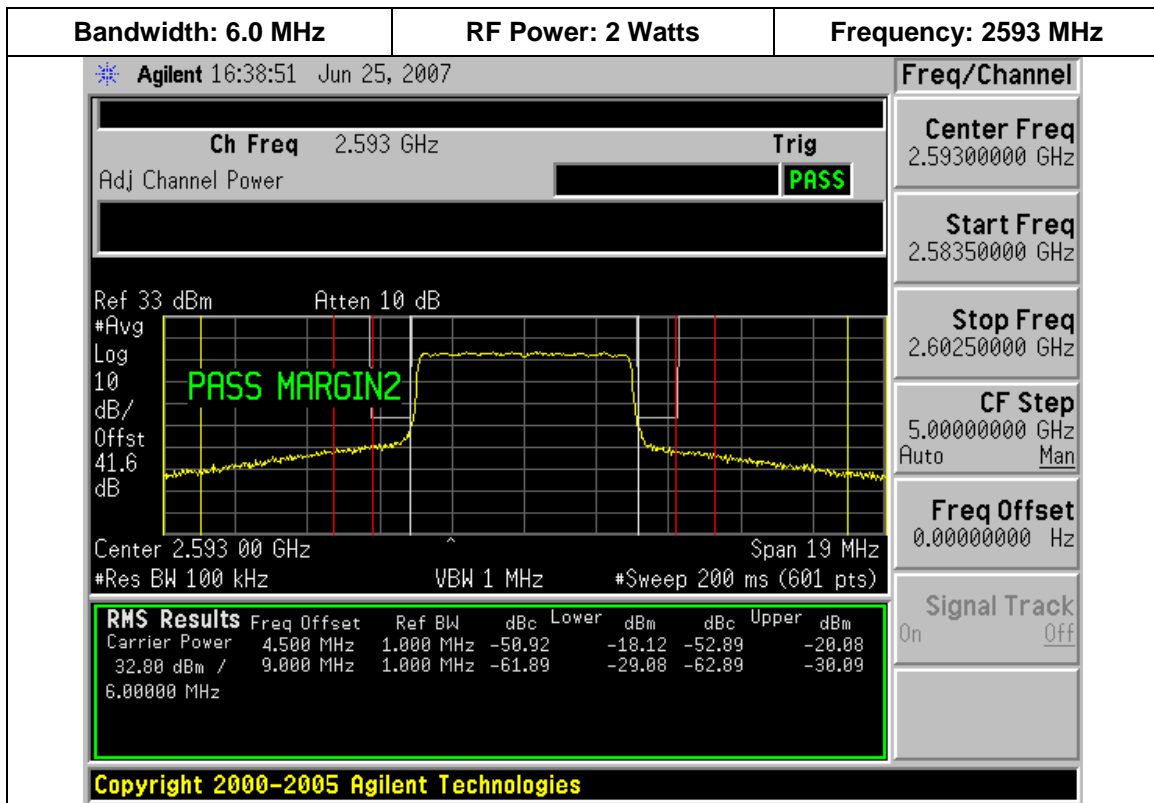

102 VDC / +20° C

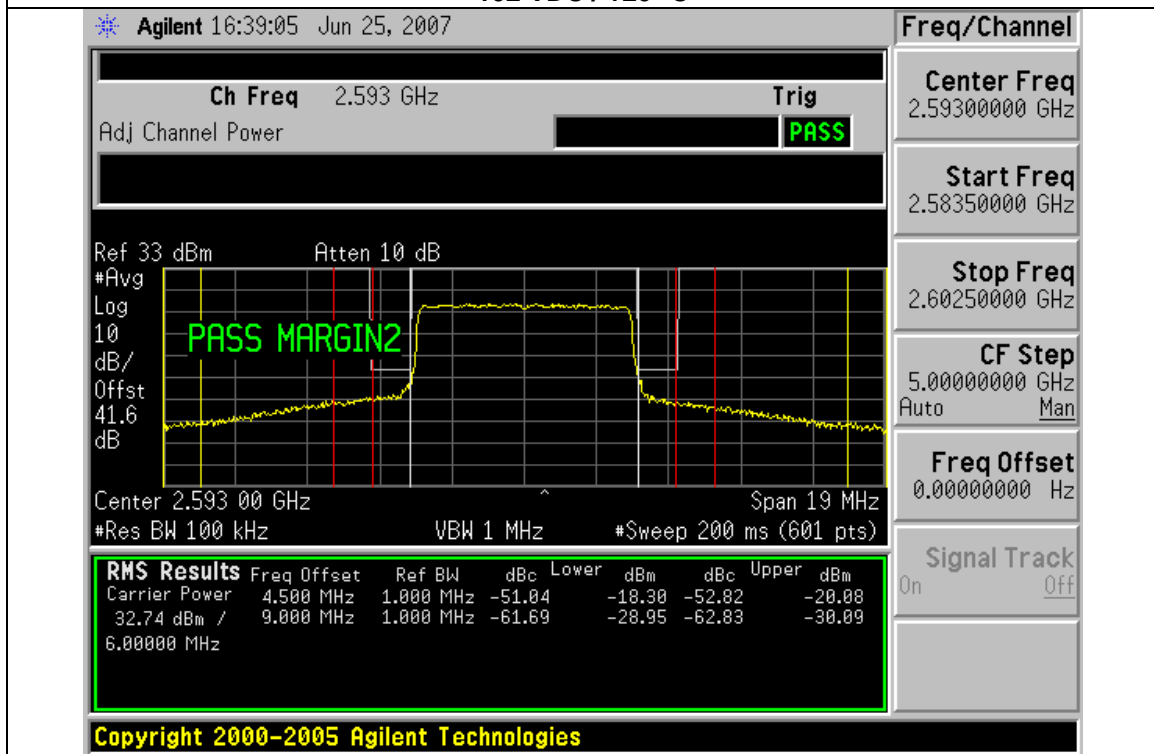

120 VDC / +20° C

