



SAR TEST REPORT

HCT CO., LTD



EUT Type:	PCS CDMA Fixed Wireless Cordless Phone		
FCC ID:	PH7PX430		
Model:	PX430, PX430R	Trade Name	AXESSTEL
Date of Issue:	Jun.17, 2009		
Test report No.:	HCT-IA0906-1101		
Test Laboratory:	HCT CO., LTD. SAN 136-1, AMI-RI, BUBAL-EUP, ICHEON-SI, KYOUNGKI-DO, 467-701, KOREA TEL: +82 31 639 8565 FAX: +82 31 639 8525		
Applicant :	AXESSTEL INC. 6815 Flanders Drive Ste.210, San Diego, CA 92121 Tel: 858- 625-2100 Fax: 858- 625- 2110 E-Mail: dskim@axesstel.com		
Testing has been carried out in accordance with:	47CFR §2.1093 FCC OET Bulletin 65(Edition 97-01), Supplement C (Edition 01-01) ANSI/ IEEE C95.1 – 2005 IEEE 1528-2003		
Test result:	The tested device complies with the requirements in respect of all parameters subject to the test. The test results and statements relate only to the items tested. The test report shall not be reproduced except in full, without written approval of the laboratory.		
Signature	<div style="display: flex; justify-content: space-around; align-items: flex-end;"> <div style="text-align: center;">  <hr style="width: 100%;"/> Report prepared by : Sun-Hee Kim Test Engineer of SAR Part </div> <div style="text-align: center;">  <hr style="width: 100%;"/> Approved by : Jae-Sang So Manager of SAR Part </div> </div>		

Table of Contents

1. INTRODUCTION	3
2. DESCRIPTION OF DEVICE	4
3. DESCRIPTION OF TEST EQUIPMENT	5
3.1 SAR MEASUREMENT SETUP	5
3.2 DASY E-FIELD PROBE SYSTEM	6
3.3 PROBE CALIBRATION PROCESS	7
3.4 SAM Phantom	9
3.5 Device Holder for Transmitters	9
3.6 Brain & Muscle Simulating Mixture Characterization	10
3.7 SAR TEST EQUIPMENT	11
4. SAR MEASUREMENT PROCEDURE	12
5. DESCRIPTION OF TEST POSITION	13
5.1 HEAD POSITION	13
6. MEASUREMENT UNCERTAINTY	14
7. ANSI/ IEEE C95.1 - 2005 RF EXPOSURE LIMITS	15
8. SYSTEM VERIFICATION	16
8.1 Tissue Verification	16
8.2 System Validation	16
9. 3G MEASUREMENT PROCEDURES	17
9.1 Procedures Used To Establish Test Signal	17
9.2 SAR Measurement Conditions for CDMA2000 1x	17
10. SAR TEST DATA SUMMARY	18
10.1 Measurement Results (PCS1900 Head SAR Touch)	18
10.2 Measurement Results (PCS1900 Head SAR Tilt)	19
11. CONCLUSION	20
12. REFERENCES	21
Attachment 1. – SAR Test Plots	22
Attachment 2. – Dipole Validation Plots	32
Attachment 3. – Probe Calibration Data	35
Attachment 4. – Dipole Calibration Data	45

1. INTRODUCTION

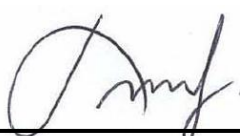
The FCC has adopted the guidelines for evaluating the environmental effects of radio frequency radiation in ET Docket 93-62 on Aug. 6, 1996 to protect the public and workers from the potential hazards of RF emissions due to FCC-regulated portable devices.

The safety limits used for the environmental evaluation measurements are based on the criteria published by the American National Standards Institute (ANSI) for localized specific absorption rate (SAR) in IEEE/ANSI C95.1-2005 Standard for Safety Levels with Respect to Human Exposure to Radio Frequency Electromagnetic Fields, 3 kHz to 300 GHz. 1992 by the Institute of Electrical and Electronics Engineers, Inc., New York, New York 10017. The measurement procedure described in IEEE/ANSI C95.3-1992 Recommended Practice for the Measurement of Potentially Hazardous Electromagnetic Fields - RF and Microwave is used for guidance in measuring SAR due to the RF radiation exposure from the Equipment Under Test (EUT). These criteria for SAR evaluation are similar to those recommended by the National Council on Radiation Protection and Measurements (NCRP) in Biological Effects and Exposure Criteria for Radio frequency Electromagnetic Fields," NCRP Report No. 86 NCRP, 1986, Bethesda, MD 20814. SAR is a measure of the rate of energy absorption due to exposure to an RF transmitting source. SAR values have been related to threshold levels for potential biological hazards.

SAR Definition

Specific Absorption Rate (SAR) is defined as the time derivative of the incremental electromagnetic energy (dW) absorbed by (dissipated in) an incremental mass (dm) contained in a volume element (dV) of a given density (r). It is also defined as the rate of RF energy absorption per unit mass at a point in an absorbing body.

$$SAR = \frac{d}{dt} \left(\frac{dU}{dm} \right) = \frac{d}{dt} \left(\frac{dU}{\rho dV} \right)$$

Figure 2. SAR Mathematical Equation

SAR is expressed in units of Watts per Kilogram (W/kg).

$$SAR = \sigma E^2 / \rho$$

where:

- σ = conductivity of the tissue-simulant material (S/m)
- ρ = mass density of the tissue-simulant material (kg/m³)
- E = Total RMS electric field strength (V/m)

NOTE: The primary factors that control rate of energy absorption were found to be the wavelength of the incident field in relations to the dimensions and geometry of the irradiated organism, the orientation of the organism in relation to the polarity of field vectors, the presence of reflecting surfaces, and whether conductive contact is made by the organism with a ground plane.

2. DESCRIPTION OF DEVICE

Environmental evaluation measurements of specific absorption rate (SAR) distributions in emulated human head and body tissues exposed to radio frequency (RF) radiation from wireless portable devices for compliance with the rules and regulations of the U.S. Federal Communications Commission (FCC).

EUT Type	PCS CDMA Fixed Wireless Cordless Phone
FCC ID	PH7PX430
Model(s)	PX430, PX430R
Trade Name	AXESSTEL
Serial Number(s)	#1
Application Type	Certification
Modulation(s)	PCS1900
Tx Frequency	1851.25 - 1908.75 MHz (PCS CDMA)
Rx Frequency	1931.25 - 1988.75 MHz (PCS CDMA)
FCC Classification	Licensed Portable Transmitter Held to Ear (PCE)
Production Unit or Identical Prototype	Prototype
Max SAR	1.23 W/kg PCS1900 Head SAR
Date(s) of Tests	Jun.14, 2009
Antenna Type	Intenna

3. DESCRIPTION OF TEST EQUIPMENT

3.1 SAR MEASUREMENT SETUP

These measurements are performed using the DASY4 automated dosimetric assessment system. It is made by Schmid & Partner Engineering AG (SPEAG) in Zurich, Switzerland. It consists of high precision robotics system (Staubli), robot controller, Pentium III computer, near-field probe, probe alignment sensor, and the generic twin phantom containing the brain equivalent material. The robot is a six-axis industrial robot performing precise movements to position the probe to the location (points) of maximum electromagnetic field (EMF) (see Figure.3.1).

A cell controller system contains the power supply, robot controller, teach pendant (Joystick), and remote control, is used to drive the robot motors. The PC consists of the HP Pentium IV 3.0 GHz computer with Windows XP system and SAR Measurement Software DASY4, A/D interface card, monitor, mouse, and keyboard. The Staubli Robot is connected to the cell controller to allow software manipulation of the robot. A data acquisition electronic (DAE) circuit performs the signal amplification, signal multiplexing, AD-conversion, offset measurements, mechanical surface detection, collision detection, etc. is connected to the Electro-optical coupler (EOC). The EOC performs the conversion from the optical into digital electric signal of the DAE and transfers data to the PC plug-in card.

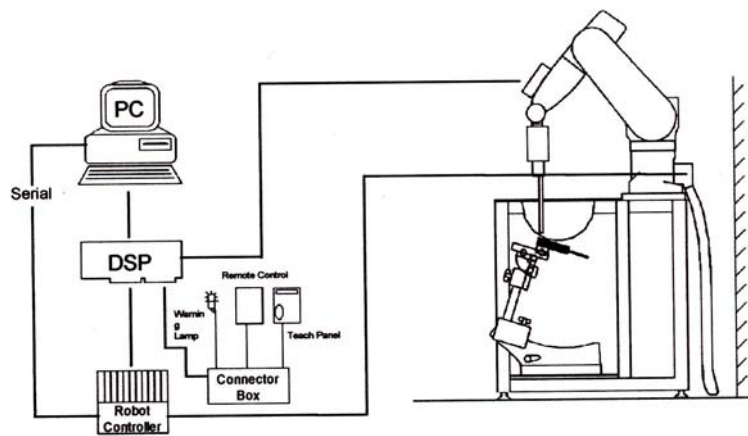

Figure 3.1 HCT SAR Lab. Test Measurement Set-up

The DAE4 consists of a highly sensitive electrometer-grade preamplifier with auto-zeroing, a channel and gain-switching multiplexer, a fast 16 bit AD-converter and a command decoder and control logic unit. Transmission to the PC-card is accomplished through an optical downlink for data and status information and an optical uplink for commands and clock lines. The mechanical probe mounting device includes two different sensor systems for frontal and sidewise probe contacts. They are also used for mechanical surface detection and probe collision detection. The robot uses its own controller with a built in VME-bus computer. The system is described in detail in.

3.2 DASY E-FIELD PROBE SYSTEM

3.2.1 ET3DV6 Probe Specification

Construction	Symmetrical design with triangular core Built-in optical fiber for surface detection System Built-in shielding against static charges
Calibration	In air from 10 MHz to 2.5 GHz In brain and muscle simulating tissue at Frequencies of 450 MHz, 900 MHz and 1.8 GHz (accuracy: 8 %)
Frequency	10 MHz to > 6 GHz; Linearity: ± 0.2 dB (30 MHz to 3 GHz)
Directivity	± 0.2 dB in brain tissue (rotation around probe axis) ± 0.4 dB in brain tissue (rotation normal probe axis)
Dynamic	5 μ W/g to > 100 mW/g;
Range Linearity:	± 0.2 dB
Surface Detection	± 0.2 mm repeatability in air and clear liquids over diffuse reflecting surfaces.
Dimensions	Overall length: 330 mm Tip length: 16 mm Body diameter: 12 mm Tip diameter: 6.8 mm Distance from probe tip to dipole centers: 2.7 mm
Application	General dissymmetry up to 3 GHz Compliance tests of mobile phones Fast automatic scanning in arbitrary phantoms



Figure 3.2 Photograph of the probe and the Phantom



Figure 3.3 ET3DV6 E-field Probe

The SAR measurements were conducted with the dosimetric probe ET3DV6, designed in the classical triangular configuration and optimized for dosimetric evaluation. The probe is constructed using the thick film technique; with printed resistive lines on ceramic substrates. The probe is equipped with an optical multifiber line ending at the front of the probe tip. It is connected to the EOC box on the robot arm and provides an automatic detection of the phantom surface. Half of the fibers are connected to a pulsed infrared transmitter, the other half to a synchronized receiver. As the probe approaches the surface, the reflection from the surface produces a coupling from the transmitting to the receiving fibers. This reflection increases first during the approach, reaches a maximum and then decreases. If the probe is flatly touching the surface, the coupling is zero. The distance of the coupling maximum to the surface is independent of the surface reflectivity and largely independent of the surface to probe angle. The DASY4 software reads the reflection during a software approach and looks for the maximum using a 2nd order fitting. The approach is stopped at reaching the maximum.

3.3 PROBE CALIBRATION PROCESS

3.3.1 E-Probe Calibration

Each probe is calibrated according to a dosimetric assessment procedure with an accuracy better than $\pm 10\%$. The spherical isotropy was evaluated with the proper procedure and found to be better than ± 0.25 dB. The sensitivity parameters (NormX, NormY, NormZ), the diode compression parameter (DCP) and the conversion factor (ConvF) of the probe is tested.

The free space E-field from amplified probe outputs is determined in a test chamber. This is performed in a TEM cell for frequencies below 1 GHz, and in a waveguide above 1 GHz for free space. For the free space calibration, the probe is placed in the volumetric center of the cavity and at the proper orientation with the field. The probe is then rotated 360 degrees.

E-field temperature correlation calibration is performed in a flat phantom filled with the appropriate simulated brain tissue. The measured free space E-field in the medium correlates to temperature rise in a dielectric medium. For temperature correlation calibration a RF transparent thermistor-based temperature probe is used in conjunction with the E-field probe.

$$SAR = C \frac{\Delta T}{\Delta t}$$

where:

- Δt = exposure time (30 seconds),
- C = heat capacity of tissue (brain or muscle),
- ΔT = temperature increase due to RF exposure.

SAR is proportional to $\Delta T / \Delta t$, the initial rate of tissue heating, before thermal diffusion takes place. Now it's possible to quantify the electric field in the simulated tissue by equating the thermally derived SAR to the E- field;

$$SAR = \frac{|E|^2 \cdot \sigma}{\rho}$$

where:

- σ = simulated tissue conductivity,
- ρ = Tissue density (1.25 g/cm³ for brain tissue)

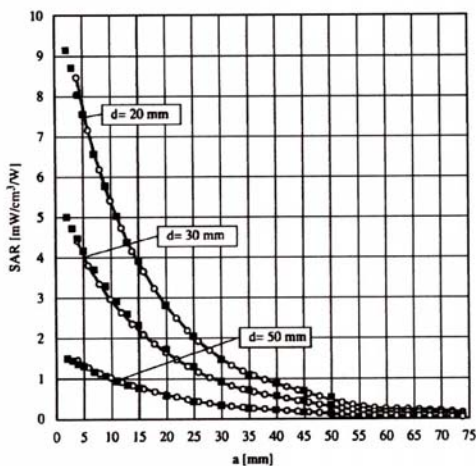

Figure 3.4 E-Field and Temperature measurements at 900 MHz

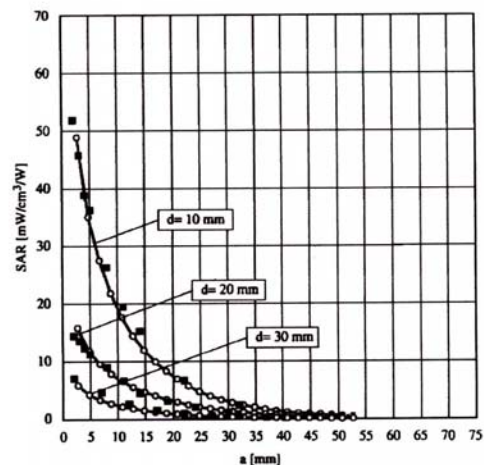

Figure 3.5 E-Field and temperature measurements at 1.8 GHz

3.3.2 Data Extrapolation

The DASY4 software automatically executes the following procedures to calculate the field units from the microvolt readings at the probe connector. The first step of the evaluation is a linearization of the filtered input signal to account for the compression characteristics of the detector diode. The compensation depends on the input signal, the diode type and the DC-transmission factor from the diode to the evaluation electronics. If the exciting field is pulsed, the crest factor of the signal must be known to correctly compensate for peak power. The formula for each channel can be given like below;

$$V_i = U_i + U_i^2 \cdot \frac{cf}{dcp_i}$$

with V_i = compensated signal of channel i (i=x,y,z)
 U_i = input signal of channel i (i=x,y,z)
 cf = crest factor of exciting field (DASY parameter)
 dcp_i = diode compression point (DASY parameter)

From the compensated input signals the primary field data for each channel can be evaluated:

E-field probes:

$$E_i = \sqrt{\frac{V_i}{Norm_i \cdot ConvF}}$$

with V_i = compensated signal of channel i (i = x,y,z)
 $Norm_i$ = sensor sensitivity of channel i (i = x,y,z)
 $\mu V/(V/m)^2$ for E-field probes
 $ConvF$ = sensitivity of enhancement in solution
 E_i = electric field strength of channel i in V/m

The RSS value of the field components gives the total field strength (Hermetian magnitude):

$$E_{tot} = \sqrt{E_x^2 + E_y^2 + E_z^2}$$

The primary field data are used to calculate the derived field units.

$$SAR = E_{tot}^2 \cdot \frac{\sigma}{\rho \cdot 1000}$$

with SAR = local specific absorption rate in W/g
 E_{tot} = total field strength in V/m
 σ = conductivity in [mho/m] or [Siemens/m]
 ρ = equivalent tissue density in g/cm³

The power flow density is calculated assuming the excitation field to be a free space field.

$$P_{pwe} = \frac{E_{tot}^2}{3770}$$

with P_{pwe} = equivalent power density of a plane wave in W/cm²
 E_{tot} = total electric field strength in V/m

3.4 SAM Phantom

The SAM Phantom is constructed of a fiberglass shell integrated in a wooden table. The shape of the shell is based on data from an anatomical study designed to determine the maximum exposure in at least 90 % of all users. It enables the dosimetric evaluation of left and right hand phone usage as well as body mounted usage at the flat phantom region. A cover prevents the evaporation of the liquid. Reference markings on the Phantom allow the complete setup of all predefined phantom positions and measurement grids by manually teaching three points in the robot.

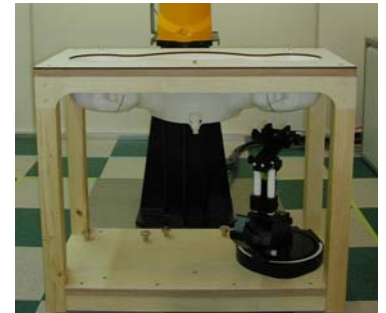

Figure 3.6 SAM Phantom

Shell Thickness	2.0 mm
Filling Volume	about 30 L
Dimensions	810 mm x 1 000 mm x 500 mm (H x L x W)

3.5 Device Holder for Transmitters

In combination with the SAM Phantom V 4.0, the Mounting Device (POM) enables the rotation of the mounted transmitter in spherical coordinates whereby the rotation points is the ear opening. The devices can be easily, accurately, and repeatably positioned according to the FCC and CENELEC specifications. The device holder can be locked at different phantom locations (left head, right head, flat phantom).

Note: A simulating human hand is not used due to the complex anatomical and geometrical structure of the hand that may produce an infinite number of configurations. To produce the Worst-case condition (the hand absorbs antenna output power), the hand is omitted during the tests.



Figure 3.7 Device Holder

3.6 Brain & Muscle Simulating Mixture Characterization

The brain and muscle mixtures consist of a viscous gel using hydrox-ethyl cellulose (HEC) gelling agent and saline solution (see Table 3.1). Preservation with a bactericide is added and visual inspection is made to make sure air bubbles are not trapped during the mixing process. The mixture is calibrated to obtain proper dielectric constant (permittivity) and conductivity of the desired tissue. The mixture characterizations used for the brain and muscle tissue simulating liquids are according to the data by C. Gabriel and G. Hartsgrove.

Ingredients (% by weight)	Frequency (MHz)									
	450		835		915		1 900		2 450	
Tissue Type	Head	Body	Head	Body	Head	Body	Head	Body	Head	Body
Water	38.56	51.16	41.45	52.4	41.05	56.0	54.9	40.4	62.7	73.2
Salt (NaCl)	3.95	1.49	1.45	1.4	1.35	0.76	0.18	0.5	0.5	0.04
Sugar	56.32	46.78	56.0	45.0	56.5	41.76	0.0	58.0	0.0	0.0
HEC	0.98	0.52	1.0	1.0	1.0	1.21	0.0	1.0	0.0	0.0
Bactericide	0.19	0.05	0.1	0.1	0.1	0.27	0.0	0.1	0.0	0.0
Triton X-100	0.0	0.0	0.0	0.0	0.0	0.0	0.0	0.0	36.8	0.0
DGBE	0.0	0.0	0.0	0.0	0.0	0.0	44.92	0.0	0.0	26.7

Salt:	99 % Pure Sodium Chloride	Sugar:	98 % Pure Sucrose
Water:	De-ionized, 16M resistivity	HEC:	Hydroxyethyl Cellulose
DGBE:	99 % Di(ethylene glycol) butyl ether,[2-(2-butoxyethoxy) ethanol]		
Triton X-100(ultra pure):	Polyethylene glycol mono[4-(1,1,3,3-tetramethylbutyl)phenyl] ether		

Table 3.1 Composition of the Tissue Equivalent Matter

3.7 SAR TEST EQUIPMENT

Manufacturer	Type / Model	S/N	Calib. Date	Calib.Interval	Calib.Due
SPEAG	SAM Phantom	-	N/A	N/A	N/A
Staubli	Robot RX90L	F01/5K09A1/A/01	N/A	N/A	N/A
Staubli	Robot ControllerCS7MB	F99/5A82A1/C/01	N/A	N/A	N/A
HP	Pavilion t000_puffer	KRJ51201TV	N/A	N/A	N/A
SPEAG	Light Alignment Sensor	265	N/A	N/A	N/A
Staubli	Teach Pendant (Joystick)	D221340.01	N/A	N/A	N/A
SPEAG	DAE4	869	Sept. 03, 2008	Annual	Sept. 03, 2009
SPEAG	DAE3	466	July 17, 2008	Annual	July 17, 2009
SPEAG	E-Field Probe ET3DV6	1630	Aug. 25, 2008	Annual	Aug. 25, 2009
SPEAG	E-Field Probe ET3DV6	1609	Mar. 17, 2009	Annual	Mar. 17, 2010
SPEAG	Validation Dipole D450V2	1007	July 15, 2008	Biennial	July 15, 2010
SPEAG	Validation Dipole D835V2	441	May 25, 2009	Annual	May 25, 2010
SPEAG	Validation Dipole D900V2	130	Aug. 25, 2008	Annual	Aug. 25, 2009
SPEAG	Validation Dipole D1800V2	2d007	May 20, 2008	Biennial	May 20, 2010
SPEAG	Validation Dipole D1900V2	5d032	July 22, 2008	Annual	July 22, 2009
SPEAG	Validation Dipole D2450V2	743	Aug. 27, 2008	Biennial	Aug. 27, 2010
Agilent	Power Meter(F) E4419B	MY41291386	Nov. 05, 2008	Annual	Nov. 05, 2009
Agilent	Power Sensor(G) 8481	MY41090870	Nov. 05, 2008	Annual	Nov. 05, 2009
HP	Dielectric Probe Kit 85070C	00721521	N/A	N/A	N/A
HP	Dual Directional Coupler	16072	Nov. 05, 2008	Annual	Nov. 05, 2009
R&S	Base Station CMU200	110740	July 26, 2008	Annual	July 26, 2009
Agilent	Base Station E5515C	GB44400269	Feb. 10, 2009	Annual	Feb. 10, 2010
HP	Signal Generator E4438C	MY42082646	Dec. 24, 2008	Annual	Dec. 24, 2009
HP	Network Analyzer 8753C	3310J01394	Dec. 04, 2008	Annual	Dec. 04, 2009
Tescom	TC-3000/ Bluetooth	3000A490112	Jan. 09, 2009	Annual	Jan. 09, 2010

NOTE:

The E-field probe was calibrated by SPEAG, by the waveguide technique procedure. Dipole Validation measurement is performed by HCT Lab. before each test. The brain simulating material is calibrated by HCT using the dielectric probe system and network analyzer to determine the conductivity and permittivity (dielectric constant) of the brain-equivalent material.

4. SAR MEASUREMENT PROCEDURE

The evaluation was performed with the following procedure:

1. The SAR value at a fixed location above the ear point was measured and was used as a reference value for assessing the power drop.
2. The SAR distribution at the exposed side of the head was measured at a distance of 3.9 mm from the inner surface of the shell. The area covered the entire dimension of the head and the horizontal grid spacing was 20 mm x 20 mm. Based on this data, the area of the maximum absorption was determined by spline interpolation.
3. Around this point, a volume of 32 mm x 32 mm x 30 mm was assessed by measuring 5 x 5 x 7 points. On this basis of this data set, the spatial peak SAR value was evaluated with the following procedure:
 - a. The data at the surface were extrapolated, since the center of the dipoles is 2.7 mm away from the tip of the probe and the distance between the surface and the lowest measuring point is 1.2 mm. The extrapolation was based on a least square algorithm. A polynomial of the fourth order was calculated through the points in z-axes. This polynomial was then used to evaluate the points between the surface and the probe tip.
 - b. The maximum interpolated value was searched with a straight-forward algorithm. Around this maximum the SAR values averaged over the spatial volumes (1 g or 10 g) were computed using the 3D-Spline interpolation algorithm. The 3D-spline is composed of three one-dimensional splines with the "Not a knot" condition (in x, y, and z directions. The volume was integrated with the trapezoidal algorithm. One thousand points (10 x 10 x 10) were interpolated to calculate the average.
 - c. All neighboring volumes were evaluated until no neighboring volume with a higher average value was found.
4. The SAR value, at the same location as procedure #1, was re-measured. If the value changed by more than 5 %, the evaluation is repeated.

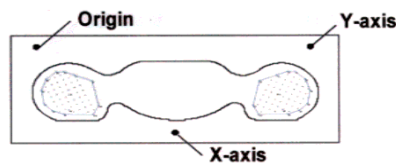

Figure 4.1 SAR Measurement Point in Area Scan

5. DESCRIPTION OF TEST POSITION

5.1 HEAD POSITION

The device was placed in a normal operating position with the Point A on the device, as illustrated in following drawing, aligned with the location of the RE(ERP) on the phantom. With the ear-piece pressed against the head, the vertical center line of the body of the handset was aligned with an imaginary plane consisting of the RE, LE and M. While maintaining these alignments, the body of the handset was gradually moved towards the cheek until any point on the mouth-piece or keypad contacted the cheek. This is a cheek/touch position. For ear/tilt position, while maintain the device aligned with the BM and FN lines, the device was pivot against ERP back for 15° or until the device antenna touch the phantom. Please refer to IEEE 1528-2003 illustration below.

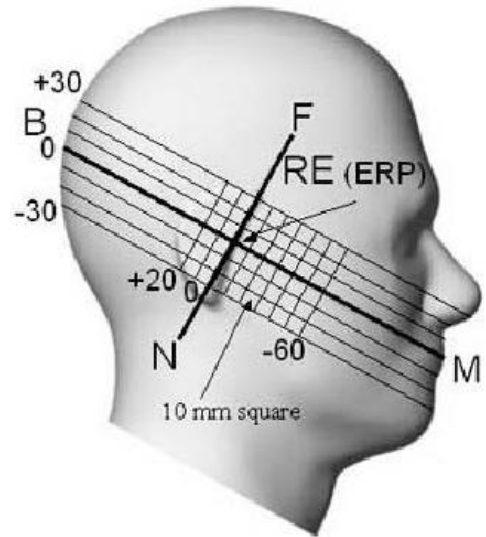

Figure 5.1 Side view of the phantom

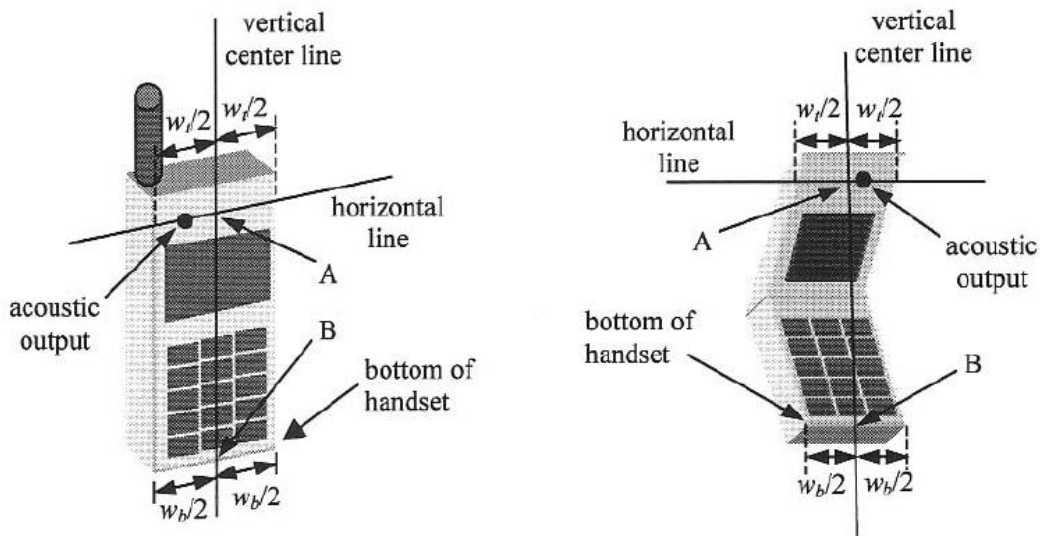

Figure 5.2 Handset vertical and horizontal reference lines

6. MEASUREMENT UNCERTAINTY

Measurement uncertainties in SAR measurements are difficult to quantify due to several variables including biological, physiological, and environmental. However, we estimate the measurement uncertainties in SAR to be less than 15 % - 25 %.

According to ANSI/IEEE C95.3, the overall uncertainties are difficult to assess and will vary with the type of meter and usage situation. However, accuracy's of 1 dB to ± 3 dB can be expected in practice, with greater uncertainties in near-field situations and at higher frequencies (shorter wavelengths), or areas where large reflecting objects are present. Under optimum measurement conditions, SAR measurement uncertainties of at least ± 2 dB can be expected.

According to CENELEC, typical worst-case uncertainty of field measurements is 5 dB. For well-defined modulation characteristics the uncertainty can be reduced to ± 3 dB.

Error Description	Uncertainty value [%]	Probability Distribution	Divisor	ci	ci ²	Standard Uncertainty [%]	Stand Uncert ²	(Stand Uncert ²) X (ci ²)	Vi & Ve//
1. Measurement System									
Probe Calibration	5.5	Normal	1.00	1	1	5.50	30.25	30.25	∞
Axial Isotropy	4.7	Rectangular	1.73	0.7	0.49	2.71	7.36	3.61	∞
Hemispherical Isotropy	9.6	Rectangular	1.73	0.7	0.49	5.54	30.72	15.05	∞
Linearity	4.7	Rectangular	1.73	1	1	2.71	7.36	7.36	∞
System Detection limits	1.0	Rectangular	1.73	1	1	0.58	0.33	0.33	∞
Boundary effect	1.0	Rectangular	1.73	1	1	0.58	0.33	0.33	∞
Response time	0.8	Rectangular	1.73	1	1	0.46	0.21	0.21	∞
RF Ambient conditions	3.0	Rectangular	1.73	1	1	1.73	3.00	3.00	∞
Readout Electronics	0.3	Normal	1.00	1	1	0.30	0.09	0.09	∞
Integration time	2.6	Rectangular	1.73	1	1	1.50	2.25	2.25	∞
Probe positioner	0.4	Rectangular	1.73	1	1	0.23	0.05	0.05	∞
Probe positioning	2.9	Rectangular	1.73	1	1	1.67	2.80	2.80	∞
Maximum SAR evaluation	1.0	Rectangular	1.73	1	1	0.58	0.33	0.33	∞
Sub Total								65.69	
2. Test Sample Related									
Device Positioning	1.8	Normal	1.00	1	1	1.81	3.28	3.28	9
Device Holder	3.6	Normal	1.00	1	1	3.60	12.96	12.96	∞
Power Drift	5.0	Rectangular	1.73	1	1	2.89	8.33	8.33	∞
Sub Total								24.57	
3. Phantom and Setup									
Phantom Uncertainty	4.0	Rectangular	1.73	1	1	2.31	5.33	5.33	∞
Liquid conductivity (target)	5.0	Rectangular	1.73	0.5	0.25	2.89	8.33	2.08	∞
Liquid conductivity (measurement error)	2.5	Normal	1.00	0.5	0.25	2.50	6.25	1.56	∞
Liquid permittivity (target)	5.0	Rectangular	1.73	0.5	0.25	2.89	8.33	2.08	∞
Liquid permittivity (measurement error)	2.5	Normal	1.00	0.5	0.25	2.50	6.25	1.56	∞
Sub Total								12.63	
Combined standard SAR uncertainty [%]						10.14		102.88	-
Expanded uncertainty [k=2, approximately confidence level 95 %]						± 20.28 %			

Table 6.1 Breakdown of Errors

7. ANSI/ IEEE C95.1 - 2005 RF EXPOSURE LIMITS

HUMAN EXPOSURE	UNCONTROLLED ENVIRONMENT General Population (W/kg) or (mW/g)	CONTROLLED ENVIRONMENT Occupational (W/kg) or (mW/g)
SPATIAL PEAK SAR * (Brain)	1.60	8.00
SPATIAL AVERAGE SAR ** (Whole Body)	0.08	0.40
SPATIAL PEAK SAR *** (Hands / Feet / Ankle / Wrist)	4.00	20.00

Table 7.1 Safety Limits for Partial Body Exposure

NOTES:

* The Spatial Peak value of the SAR averaged over any 1 g of tissue (defined as a tissue volume in the shape of a cube) and over the appropriate averaging time.

** The Spatial Average value of the SAR averaged over the whole-body.

*** The Spatial Peak value of the SAR averaged over any 10 g of tissue (defined as a tissue volume in the shape of a cube) and over the appropriate averaging time.

Uncontrolled Environments are defined as locations where there is the exposure of individuals who have no knowledge or control of their exposure.

Controlled Environments are defined as locations where there is exposure that may be incurred by persons who are aware of the potential for exposure, (i.e.as a result of employment or occupation).

8. SYSTEM VERIFICATION

8.1 Tissue Verification

Freq. [MHz]	Date	Liquid	Liquid Temp.[°C]	Parameters	Target Value	Measured Value	Deviation [%]	Limit [%]
1 900	Jun.14, 2009	Head	21.2	ϵr	40.0	38.3	- 4.25	± 5
				σ	1.40	1.46	+ 4.29	± 5

8.2 System Validation

Prior to assessment, the system is verified to the $\pm 10\%$ of the specifications at 1 900 MHz by using the system validation kit. (Graphic Plots Attached)

* Input Power: 100 mW

Freq. [MHz]	Date	Liquid	Liquid Temp. [°C]	SAR Average	Target Value (SPEAG) (mW/g)	* Measured Value (mW/g)	Deviation [%]	Limit [%]
1 900	Jun.14, 2009	Head	21.2	1 g	37.7	3.86	+ 2.39	± 10

9. 3G MEASUREMENT PROCEDURES

9.1 Procedures Used To Establish Test Signal

The handset was placed into a simulated call using a base station simulator in a shielded chamber. Such test signals offer a consistent means for testing SAR and are recommended for evaluating SAR. SAR measurements were taken with a fully charged battery. In order to verify that the device was tested and maintained at full power, this was configured with the base station simulator. The SAR measurement software calculates a reference power point at the start and end of the test to check for power drifts. If conducted power deviations of more than 5% occurred, the tests were repeated.

9.2 SAR Measurement Conditions for CDMA2000 1x

These procedures were followed according to FCC "SAR Measurement Procedures for 3G Devices", May 2006.

9.2.1 Output Power Verification

See 3GPP2 C.S0011/TIA-98-E as recommended by "SAR Measurement Procedures for 3G Devices", May 2006.

Maximum output power is verified on the High, Middle and Low channels according to procedures defined in section 4.4.5.2 of 3GPP2 C.S0011/TIA-98-E. SO55 tests were measured with power control bits in "All Up" condition.

1. If the mobile station supports Reverse TCH RC 1 and Forward TCH RC 1, set up a call using Fundamental Channel Test Mode 1 (RC=1/1) with 9 600 bps data rate only.
2. Under RC1, C.S0011 Table 4.4.5.2-1 (Table 9.1) parameters were applied.
3. If the MS supports the RC 3 Reverse FCH, RC3 Reverse SCH0 and demodulation of RC 3, 4, or 5, set up a call using Supplemental Channel Test Mode 3 (RC 3/3) with 9 600 bps Fundamental Channel and 9 600 bps SCH0 data rate Channel and 9 600 bps SCH0 data rate.
4. Under RC3, C.S0011 Table 4.4.5.2-2(Table 9.2) was applied.
5. FCHs were configured at full rate for maximum SAR with "All Up" power control bits.

Parameters for Max. Power for RC1

Parameter	Units	Value
I_{or}	dBm/1.23 MHz	-104
$\frac{Pilot E_c}{I_{or}}$	dB	-7
$\frac{Traffic E_c}{I_{or}}$	dB	-7.4

Table. 9.1

Parameters for Max. Power for RC3

Parameter	Units	Value
I_{or}	dBm/1.23 MHz	-86
$\frac{Pilot E_c}{I_{or}}$	dB	-7
$\frac{Traffic E_c}{I_{or}}$	dB	-7.4

Table. 9.2

9.2.2 Head SAR Measurement

SAR for head exposure configurations is measured in RC3 with the DUT configured to transmit at full rate using Loopback Service Option SO55. SAR for RC1 is not required when the maximum average output of each channel is less than ¼ dB higher than that measured in RC3. Otherwise, SAR is measured on the maximum output channel in RC1 using the exposure configuration that results in the highest SAR for that channel in RC3.

Average Output Power Measurement for FCC ID: PH7PX430

Band	Channel	SO2	SO2	SO55	SO55
		RC1/1	RC3/3	RC1/1	RC3/3
PCS	25	24.93	24.80	24.90	24.74
	600	25.00	24.85	24.98	24.80
	1175	24.55	24.45	24.51	24.47

10. SAR TEST DATA SUMMARY

10.1 Measurement Results (PCS1900 Head SAR Touch)

Frequency		Modulation	Conducted Power (dBm)		Battery	Phantom Position	Antenna Type	SAR(mW/g)
MHz	Channel		Begin	End				
1 851.25	25 (Low)	PCS1900	24.74	24.71	Standard	Left Ear	Intenna	1.22
1 880.00	600 (Mid)	PCS1900	24.80	24.79	Standard	Left Ear	Intenna	1.04
1 908.75	1175 (High)	PCS1900	24.47	24.33	Standard	Left Ear	Intenna	0.922
1 851.25	25 (Low)	PCS1900	24.74	24.83	Standard	Right Ear	Intenna	1.23
1 880.00	600 (Mid)	PCS1900	24.80	24.88	Standard	Right Ear	Intenna	1.03
1 908.75	1175 (High)	PCS1900	24.47	24.38	Standard	Right Ear	Intenna	0.893
ANSI/ IEEE C95.1 2005 – Safety Limit						Head		
Spatial Peak						1.6 W/kg (mW/g)		
Uncontrolled Exposure/ General Population						<small>Averaged over 1 gram</small>		

NOTES:

- The test data reported are the worst-case SAR value with the antenna-head position set in a typical configuration. Test procedures used are according to FCC/OET Bulletin 65, Supplement C [July 2001].
- All modes of operation were investigated and the worst-case are reported.
- Measured Depth of Simulating Tissue is 15.0 cm ± 0.2 cm.
- Tissue parameters and temperatures are listed on the SAR plot.
- Battery Type Standard Extended Slim
Batteries are fully charged for all readings.
- Test Signal Call Mode Manual Test cord Base Station Simulator
- Head SAR was tested under RC3/SO55.

10.2 Measurement Results (PCS1900 Head SAR Tilt)

Frequency		Modulation	Conducted Power (dBm)		Battery	Phantom Position	Antenna Type	SAR(mW/g)
MHz	Channel		Begin	End				
1 880.00	600 (Mid)	PCS1900	24.80	24.74	Standard	Left Tilt 15°	Intenna	0.678
1 880.00	600 (Mid)	PCS1900	24.80	24.76	Standard	Right Tilt 15°	Intenna	0.752
ANSI/ IEEE C95.1 2005 – Safety Limit						Head		
Spatial Peak						1.6 W/kg (mW/g)		
Uncontrolled Exposure/ General Population						<small>Averaged over 1 gram</small>		

NOTES:

- The test data reported are the worst-case SAR value with the antenna-head position set in a typical configuration. Test procedures used are according to FCC/OET Bulletin 65, Supplement C [July 2001].
- All modes of operation were investigated and the worst-case are reported.
- Measured Depth of Simulating Tissue is 15.0 cm ± 0.2 cm.
- Tissue parameters and temperatures are listed on the SAR plot.
- Battery Type Standard Extended Slim
Batteries are fully charged for all readings.
- Test Signal Call Mode Manual Test cord Base Station Simulator
- Head SAR was tested under RC3/SO55.
- Justification for reduced test configurations: per FCC/OET Supplement C (July, 2001), if the SAR measured at the middle channel for each test configuration (Left, right, cheek/touch, tilt/ear, extended and retracted) is at least 3.0 dB lower than the SAR limit, testing at the high and low channels is optional for such test configuration(s).

11. CONCLUSION

The SAR measurement indicates that the EUT complies with the RF radiation exposure limits of the ANSI/IEEE C95.1 2005.

These measurements are taken to simulate the RF effects exposure under worst-case conditions. Precise laboratory measures were taken to assure repeatability of the tests.

12. REFERENCES

- [1] Federal Communications Commission, OET Bulletin 65 (Edition 97-01), Supplement C (Edition 01-01), Evaluating Compliance with FCC Guidelines for Human Exposure to Radio frequency Electromagnetic Fields, July 2001.
- [2] IEEE Standards Coordinating Committee 34 – IEEE Std. 1528-2003, IEEE Recommended Practice for Determining the Peak Spatial-Average Specific Absorption Rate (SAR) in the Human Body from Wireless Communications Devices.
- [3] Federal Communications Commission, ET Docket 93-62, Guidelines for Evaluating the Environmental Effects of Radio frequency Radiation, Aug. 1996.
- [4] ANSI/IEEE C95.1 - 1991, American National Standard safety levels with respect to human exposure to radio frequency electromagnetic fields, 300 kHz to 100 GHz, New York: IEEE, Aug. 1992
- [5] ANSI/IEEE C95.3 - 1991, IEEE Recommended Practice for the Measurement of Potentially Hazardous Electromagnetic Fields - RF and Microwave, New York: IEEE, 1992.
- [6] NCRP, National Council on Radiation Protection and Measurements, Biological Effects and Exposure Criteria for Radio Frequency Electromagnetic Fields, NCRP Report No. 86, 1986. Reprinted Feb. 1995.
- [7] T. Schmid, O. Egger, N. Kuster, Automated E-field scanning system for dosimetric assessments, IEEE Transaction on Microwave Theory and Techniques, vol. 44, Jan. 1996, pp. 105-113.
- [8] K. Pokovic, T. Schmid, N. Kuster, Robust setup for precise calibration of E-field probes in tissue simulating liquids at mobile communications frequencies, ICECOM97, Oct. 1997, pp. 120-124.
- [9] K. Pokovic, T. Schmid, and N. Kuster, E-field Probe with improved isotropy in brain simulating liquids, Proceedings of the ELMAR, Zadar, Croatia, June 23-25, 1996, pp. 172-175.
- [10] Schmid & Partner Engineering AG, Application Note: Data Storage and Evaluation, June 1998, p2.
- [11] V. Hombach, K. Meier, M. Burkhardt, E. Kuhn, N. Kuster, The Dependence of EM Energy Absorption upon Human Head Modeling at 900 MHz, IEEE Transaction on Microwave Theory and Techniques, vol. 44 no. 10, Oct. 1996, pp. 1865-1873.
- [12] N. Kuster and Q. Balzano, Energy absorption mechanism by biological bodies in the near field of dipole antennas above 300 MHz, IEEE Transaction on Vehicular Technology, vol. 41, no. 1, Feb. 1992, pp. 17-23.
- [13] G. Hartsgrove, A. Kraszewski, A. Surowiec, Simulated Biological Materials for Electromagnetic Radiation Absorption Studies, University of Ottawa, Bioelectromagnetics, Canada: 1987, pp. 29-36.
- [14] Q. Balzano, O. Garay, T. Manning Jr., Electromagnetic Energy Exposure of Simulated Users of Portable Cellular Telephones, IEEE Transactions on Vehicular Technology, vol. 44, no.3, Aug. 1995.
- [15] W. Gander, Computer mathematic, Birkhaeuser, Basel, 1992.
- [16] W.H. Press, S.A. Teukolsky, W.T. Vetterling, and B.P. Flannery, Numerical Recipes in C, The Art of Scientific Computing, Second edition, Cambridge University Press, 1992.
- [17] Federal Communications Commission, OET Bulletin 65, Evaluating Compliance with FCC Guidelines for Human Exposure to Radiofrequency Electromagnetic Fields. Supplement C, Dec. 1997.
- [18] N. Kuster, R. Kastle, T. Schmid, Dosimetric evaluation of mobile communications equipment with known precision, IEEE Transaction on Communications, vol. E80-B, no. 5, May 1997, pp. 645-652.
- [19] CENELEC CLC/SC111B, European Prestandard (prENV 50166-2), Human Exposure to Electromagnetic Fields High-frequency: 10 kHz-300 GHz, Jan. 1995.
- [20] Prof. Dr. Niels Kuster, ETH, Eidgenössische Technische Hochschule Zürich, Dosimetric Evaluation of the Cellular Phone.

Attachment 1. – SAR Test Plots

Test Laboratory: HCT CO., LTD
EUT Type: PCS CDMA Fixed Wireless Cordless Phone
Liquid Temperature: 21.2 °C
Ambient Temperature: 21.4 °C
Test Date: Jun.14, 2009

DUT: PX430,PX430R; Type: bar; Serial: #1

Communication System: PCS 1900MHz FCC; Frequency: 1851.25 MHz;Duty Cycle: 1:1
Medium parameters used (interpolated): $f = 1851.25$ MHz; $\sigma = 1.41$ mho/m; $\epsilon_r = 38.4$; $\rho = 1000$ kg/m³
Phantom section: Left Section ; Measurement SW: DASY4, V4.7 Build 71; Postprocessing SW: SEMCAD, V1.8 Build 176

DASY4 Configuration:

- Probe: ET3DV6 - SN1609; ConvF(5.12, 5.12, 5.12); Calibrated: 2009-03-17
- Sensor-Surface: 4mm (Mechanical Surface Detection)
- Electronics: DAE4 Sn869; Calibrated: 2008-09-03
- Phantom: SAM 1800/1900 MHz; Type: SAM

Left touch 25/Area Scan (51x111x1): Measurement grid: dx=15mm, dy=15mm

[Info: Interpolated medium parameters used for SAR evaluation.](#)

Maximum value of SAR (interpolated) = 1.43 mW/g

Left touch 25/Zoom Scan (5x5x7)/Cube 0: Measurement grid: dx=8mm, dy=8mm, dz=5mm

Reference Value = 28.5 V/m; Power Drift = -0.029 dB

Peak SAR (extrapolated) = 1.83 W/kg

SAR(1 g) = 1.22 mW/g; SAR(10 g) = 0.772 mW/g

[Info: Interpolated medium parameters used for SAR evaluation.](#)

Maximum value of SAR (measured) = 1.32 mW/g

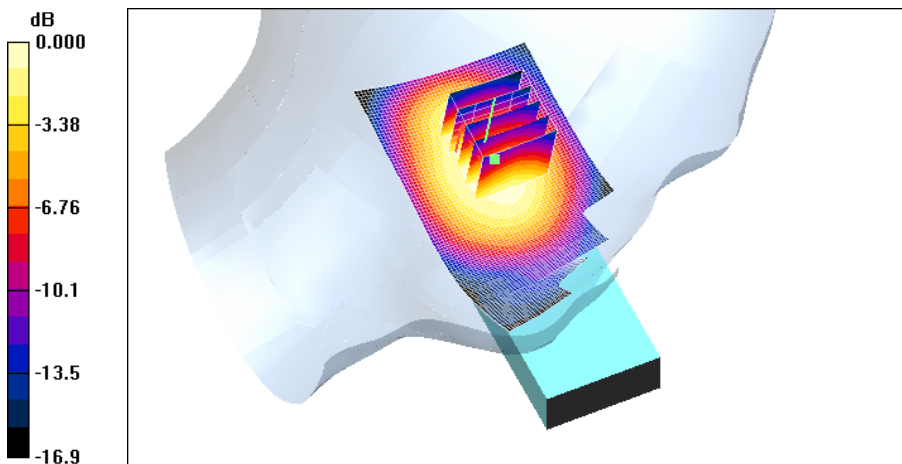

0 dB = 1.32mW/g

Test Laboratory: HCT CO., LTD
EUT Type: PCS CDMA Fixed Wireless Cordless Phone
Liquid Temperature: 21.2 °C
Ambient Temperature: 21.4 °C
Test Date: Jun.14, 2009

DUT: PX430,PX430R; Type: bar; Serial: #1

Communication System: PCS 1900MHz FCC; Frequency: 1880 MHz;Duty Cycle: 1:1
Medium parameters used: $f = 1880$ MHz; $\sigma = 1.44$ mho/m; $\epsilon_r = 38.3$; $\rho = 1000$ kg/m³
Phantom section: Left Section ; Measurement SW: DASY4, V4.7 Build 71; Postprocessing SW: SEMCAD, V1.8 Build 176

DASY4 Configuration:

- Probe: ET3DV6 - SN1609; ConvF(5.12, 5.12, 5.12); Calibrated: 2009-03-17
- Sensor-Surface: 4mm (Mechanical Surface Detection)
- Electronics: DAE4 Sn869; Calibrated: 2008-09-03
- Phantom: SAM 1800/1900 MHz; Type: SAM

Left touch 600/Area Scan (51x111x1): Measurement grid: dx=15mm, dy=15mm
Maximum value of SAR (interpolated) = 1.14 mW/g

Left touch 600/Zoom Scan (5x5x7)/Cube 0: Measurement grid: dx=8mm, dy=8mm, dz=5mm
Reference Value = 25.8 V/m; Power Drift = -0.008 dB
Peak SAR (extrapolated) = 1.56 W/kg
SAR(1 g) = 1.04 mW/g; SAR(10 g) = 0.653 mW/g
Maximum value of SAR (measured) = 1.13 mW/g

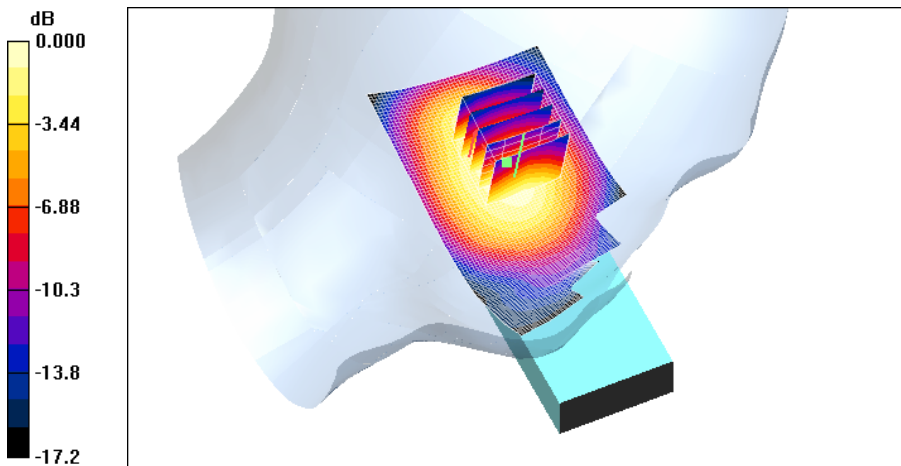

Test Laboratory: HCT CO., LTD
EUT Type: PCS CDMA Fixed Wireless Cordless Phone
Liquid Temperature: 21.2 °C
Ambient Temperature: 21.4 °C
Test Date: Jun.14, 2009

DUT: PX430,PX430R; Type: bar; Serial: #1

Communication System: PCS 1900MHz FCC; Frequency: 1908.75 MHz;Duty Cycle: 1:1
Medium parameters used (interpolated): $f = 1908.75$ MHz; $\sigma = 1.47$ mho/m; $\epsilon_r = 38.2$; $\rho = 1000$ kg/m³
Phantom section: Left Section ; Measurement SW: DASY4, V4.7 Build 71; Postprocessing SW: SEMCAD, V1.8 Build 176

DASY4 Configuration:

- Probe: ET3DV6 - SN1609; ConvF(5.12, 5.12, 5.12); Calibrated: 2009-03-17
- Sensor-Surface: 4mm (Mechanical Surface Detection)
- Electronics: DAE4 Sn869; Calibrated: 2008-09-03
- Phantom: SAM 1800/1900 MHz; Type: SAM

Left touch 1175/Area Scan (51x111x1): Measurement grid: dx=15mm, dy=15mm

[Info: Interpolated medium parameters used for SAR evaluation.](#)

Maximum value of SAR (interpolated) = 1.06 mW/g

Left touch 1175/Zoom Scan (5x5x7)/Cube 0: Measurement grid: dx=8mm, dy=8mm, dz=5mm

Reference Value = 25.0 V/m; Power Drift = -0.139 dB

Peak SAR (extrapolated) = 1.40 W/kg

SAR(1 g) = 0.922 mW/g; SAR(10 g) = 0.563 mW/g

[Info: Interpolated medium parameters used for SAR evaluation.](#)

Maximum value of SAR (measured) = 0.996 mW/g

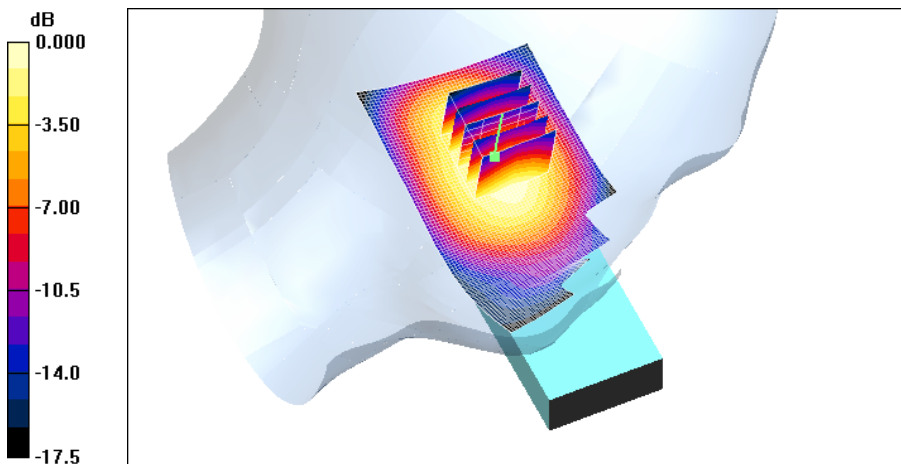

0 dB = 0.996mW/g

Test Laboratory: HCT CO., LTD
EUT Type: PCS CDMA Fixed Wireless Cordless Phone
Liquid Temperature: 21.2 °C
Ambient Temperature: 21.4 °C
Test Date: Jun.14, 2009

DUT: PX430,PX430R; Type: bar; Serial: #1

Communication System: PCS 1900MHz FCC; Frequency: 1851.25 MHz;Duty Cycle: 1:1
Medium parameters used (interpolated): $f = 1851.25$ MHz; $\sigma = 1.41$ mho/m; $\epsilon_r = 38.4$; $\rho = 1000$ kg/m³
Phantom section: Right Section ; Measurement SW: DASY4, V4.7 Build 71; Postprocessing SW: SEMCAD, V1.8 Build 176

DASY4 Configuration:

- Probe: ET3DV6 - SN1609; ConvF(5.12, 5.12, 5.12); Calibrated: 2009-03-17
- Sensor-Surface: 4mm (Mechanical Surface Detection)
- Electronics: DAE4 Sn869; Calibrated: 2008-09-03
- Phantom: SAM 1800/1900 MHz; Type: SAM

Right touch 25/Area Scan (51x111x1): Measurement grid: dx=15mm, dy=15mm

[Info: Interpolated medium parameters used for SAR evaluation.](#)

Maximum value of SAR (interpolated) = 1.44 mW/g

Right touch 25/Zoom Scan (5x5x7)/Cube 0: Measurement grid: dx=8mm, dy=8mm, dz=5mm

Reference Value = 25.1 V/m; Power Drift = 0.094 dB

Peak SAR (extrapolated) = 1.87 W/kg

SAR(1 g) = 1.23 mW/g; SAR(10 g) = 0.761 mW/g

[Info: Interpolated medium parameters used for SAR evaluation.](#)

Maximum value of SAR (measured) = 1.32 mW/g

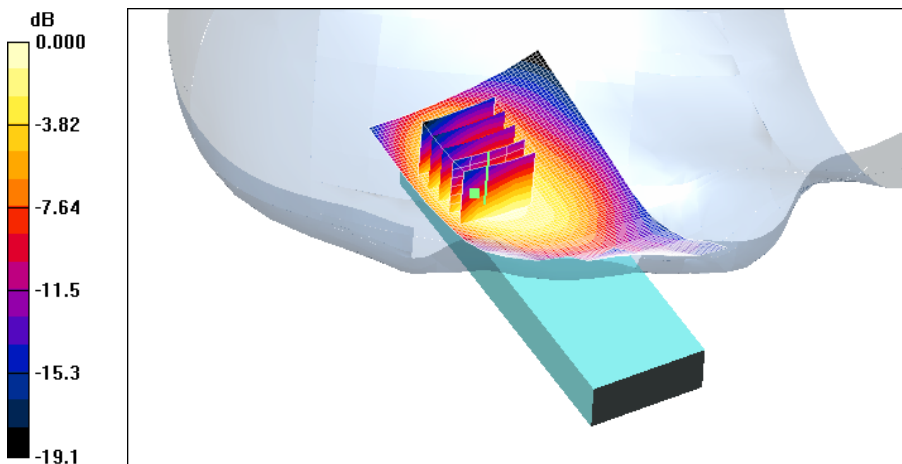

0 dB = 1.32mW/g

Test Laboratory: HCT CO., LTD
EUT Type: PCS CDMA Fixed Wireless Cordless Phone
Liquid Temperature: 21.2 °C
Ambient Temperature: 21.4 °C
Test Date: Jun.14, 2009

DUT: PX430,PX430R; Type: bar; Serial: #1

Communication System: PCS 1900MHz FCC; Frequency: 1880 MHz;Duty Cycle: 1:1
Medium parameters used: $f = 1880$ MHz; $\sigma = 1.44$ mho/m; $\epsilon_r = 38.3$; $\rho = 1000$ kg/m³
Phantom section: Right Section ; Measurement SW: DASY4, V4.7 Build 71; Postprocessing SW: SEMCAD, V1.8 Build 176

DASY4 Configuration:

- Probe: ET3DV6 - SN1609; ConvF(5.12, 5.12, 5.12); Calibrated: 2009-03-17
- Sensor-Surface: 4mm (Mechanical Surface Detection)
- Electronics: DAE4 Sn869; Calibrated: 2008-09-03
- Phantom: SAM 1800/1900 MHz; Type: SAM

Right touch 600/Area Scan (51x111x1): Measurement grid: dx=15mm, dy=15mm
Maximum value of SAR (interpolated) = 1.17 mW/g

Right touch 600/Zoom Scan (5x5x7)/Cube 0: Measurement grid: dx=8mm, dy=8mm, dz=5mm
Reference Value = 22.2 V/m; Power Drift = 0.083 dB
Peak SAR (extrapolated) = 1.57 W/kg
SAR(1 g) = 1.03 mW/g; SAR(10 g) = 0.642 mW/g
Maximum value of SAR (measured) = 1.09 mW/g

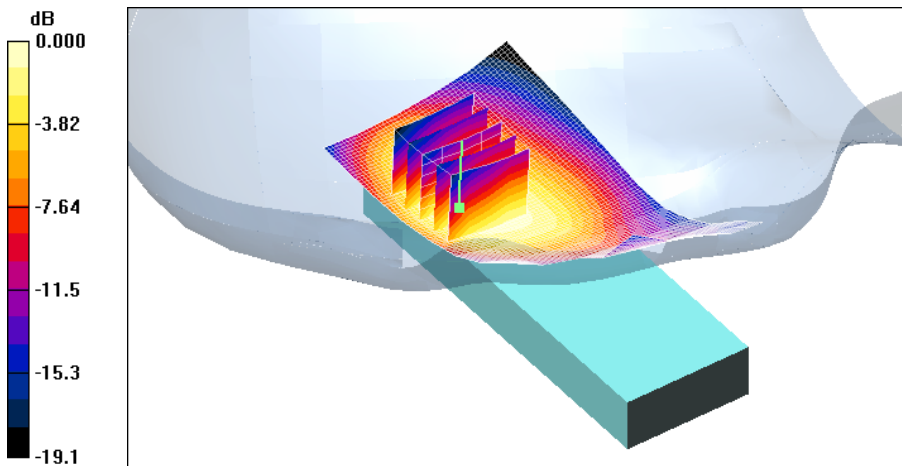

0 dB = 1.09mW/g

Test Laboratory: HCT CO., LTD
EUT Type: PCS CDMA Fixed Wireless Cordless Phone
Liquid Temperature: 21.2 °C
Ambient Temperature: 21.4 °C
Test Date: Jun.14, 2009

DUT: PX430,PX430R; Type: bar; Serial: #1

Communication System: PCS 1900MHz FCC; Frequency: 1908.75 MHz;Duty Cycle: 1:1
Medium parameters used (interpolated): $f = 1908.75$ MHz; $\sigma = 1.47$ mho/m; $\epsilon_r = 38.2$; $\rho = 1000$ kg/m³
Phantom section: Right Section ; Measurement SW: DASY4, V4.7 Build 71; Postprocessing SW: SEMCAD, V1.8 Build 176

DASY4 Configuration:

- Probe: ET3DV6 - SN1609; ConvF(5.12, 5.12, 5.12); Calibrated: 2009-03-17
- Sensor-Surface: 4mm (Mechanical Surface Detection)
- Electronics: DAE4 Sn869; Calibrated: 2008-09-03
- Phantom: SAM 1800/1900 MHz; Type: SAM

Right touch 1175/Area Scan (51x111x1): Measurement grid: dx=15mm, dy=15mm

[Info: Interpolated medium parameters used for SAR evaluation.](#)

Maximum value of SAR (interpolated) = 1.06 mW/g

Right touch 1175/Zoom Scan (5x5x7)/Cube 0: Measurement grid: dx=8mm, dy=8mm, dz=5mm

Reference Value = 21.6 V/m; Power Drift = -0.089 dB

Peak SAR (extrapolated) = 1.35 W/kg

SAR(1 g) = 0.893 mW/g; SAR(10 g) = 0.556 mW/g

[Info: Interpolated medium parameters used for SAR evaluation.](#)

Maximum value of SAR (measured) = 0.983 mW/g

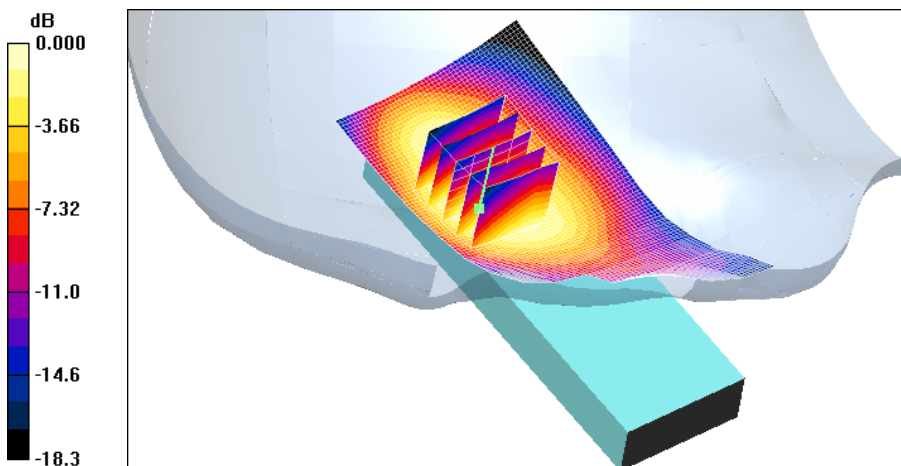

0 dB = 0.983mW/g

Test Laboratory: HCT CO., LTD
EUT Type: PCS CDMA Fixed Wireless Cordless Phone
Liquid Temperature: 21.2 °C
Ambient Temperature: 21.4 °C
Test Date: Jun.14, 2009

DUT: PX430,PX430R; Type: bar; Serial: #1

Communication System: PCS 1900MHz FCC; Frequency: 1880 MHz;Duty Cycle: 1:1
Medium parameters used: $f = 1880$ MHz; $\sigma = 1.44$ mho/m; $\epsilon_r = 38.3$; $\rho = 1000$ kg/m³
Phantom section: Left Section ; Measurement SW: DASY4, V4.7 Build 71; Postprocessing SW: SEMCAD, V1.8 Build 176

DASY4 Configuration:

- Probe: ET3DV6 - SN1609; ConvF(5.12, 5.12, 5.12); Calibrated: 2009-03-17
- Sensor-Surface: 4mm (Mechanical Surface Detection)
- Electronics: DAE4 Sn869; Calibrated: 2008-09-03
- Phantom: SAM 1800/1900 MHz; Type: SAM

Left tilt 600/Area Scan (51x111x1): Measurement grid: dx=15mm, dy=15mm
Maximum value of SAR (interpolated) = 0.789 mW/g

Left tilt 600/Zoom Scan (5x5x7)/Cube 0: Measurement grid: dx=8mm, dy=8mm, dz=5mm
Reference Value = 23.7 V/m; Power Drift = -0.065 dB
Peak SAR (extrapolated) = 1.07 W/kg
SAR(1 g) = 0.678 mW/g; SAR(10 g) = 0.401 mW/g
Maximum value of SAR (measured) = 0.743 mW/g

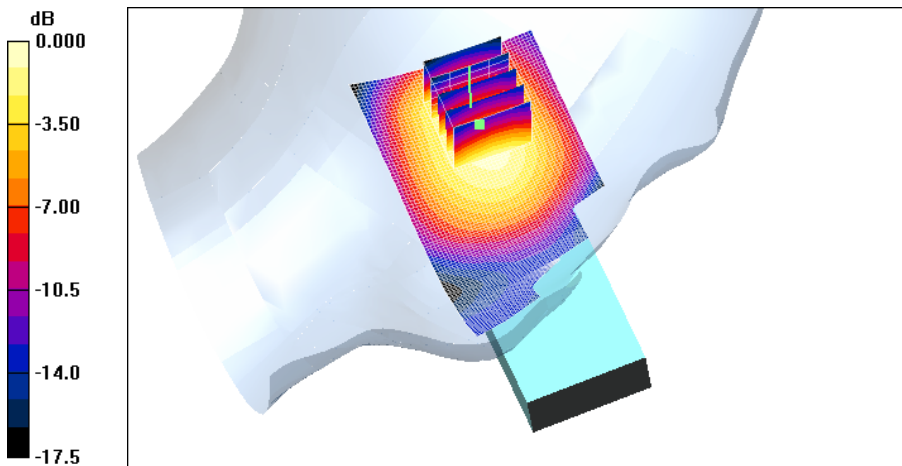

0 dB = 0.743mW/g

Test Laboratory: HCT CO., LTD
EUT Type: PCS CDMA Fixed Wireless Cordless Phone
Liquid Temperature: 21.2 °C
Ambient Temperature: 21.4 °C
Test Date: Jun.14, 2009

DUT: PX430,PX430R; Type: bar; Serial: #1

Communication System: PCS 1900MHz FCC; Frequency: 1880 MHz;Duty Cycle: 1:1
Medium parameters used: $f = 1880$ MHz; $\sigma = 1.44$ mho/m; $\epsilon_r = 38.3$; $\rho = 1000$ kg/m³
Phantom section: Right Section ; Measurement SW: DASY4, V4.7 Build 71; Postprocessing SW: SEMCAD, V1.8 Build 176

DASY4 Configuration:

- Probe: ET3DV6 - SN1609; ConvF(5.12, 5.12, 5.12); Calibrated: 2009-03-17
- Sensor-Surface: 4mm (Mechanical Surface Detection)
- Electronics: DAE4 Sn869; Calibrated: 2008-09-03
- Phantom: SAM 1800/1900 MHz; Type: SAM

Right tilt 600/Area Scan (51x111x1): Measurement grid: dx=15mm, dy=15mm
Maximum value of SAR (interpolated) = 0.870 mW/g

Right tilt 600/Zoom Scan (5x5x7)/Cube 0: Measurement grid: dx=8mm, dy=8mm, dz=5mm
Reference Value = 22.2 V/m; Power Drift = -0.040 dB
Peak SAR (extrapolated) = 1.20 W/kg
SAR(1 g) = 0.752 mW/g; SAR(10 g) = 0.445 mW/g
Maximum value of SAR (measured) = 0.824 mW/g

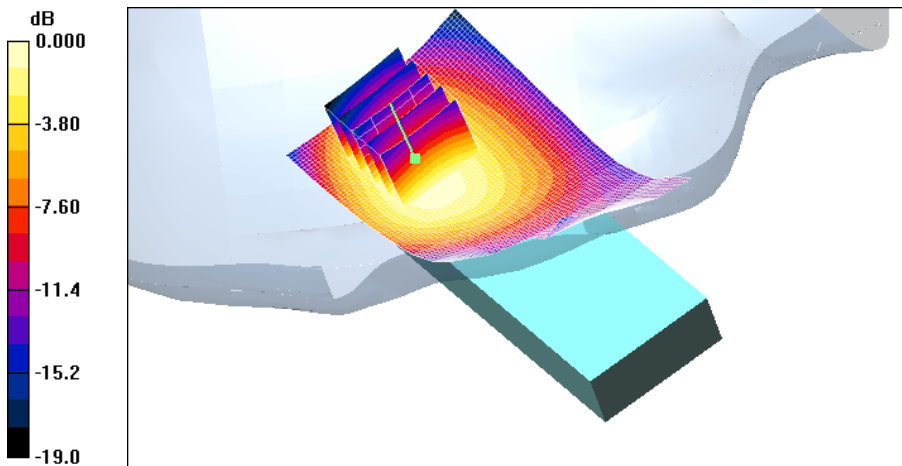

0 dB = 0.824mW/g

Test Laboratory: HCT CO., LTD
EUT Type: PCS CDMA Fixed Wireless Cordless Phone
Liquid Temperature: 21.2 °C
Ambient Temperature: 21.4 °C
Test Date: Jun.14, 2009

DUT: PX430,PX430R; Type: bar; Serial: #1

Communication System: PCS 1900MHz FCC; Frequency: 1851.25 MHz;Duty Cycle: 1:1
Medium parameters used (interpolated): $f = 1851.25$ MHz; $\sigma = 1.41$ mho/m; $\epsilon_r = 38.4$; $\rho = 1000$ kg/m³
Phantom section: Right Section ; Measurement SW: DASY4, V4.7 Build 71; Postprocessing SW: SEMCAD, V1.8 Build 176

DASY4 Configuration:

- Probe: ET3DV6 - SN1609; ConvF(5.12, 5.12, 5.12); Calibrated: 2009-03-17
- Sensor-Surface: 4mm (Mechanical Surface Detection)
- Electronics: DAE4 Sn869; Calibrated: 2008-09-03
- Phantom: SAM 1800/1900 MHz; Type: SAM

Right touch 25/Area Scan (51x111x1): Measurement grid: dx=15mm, dy=15mm

[Info: Interpolated medium parameters used for SAR evaluation.](#)

Maximum value of SAR (interpolated) = 1.44 mW/g

Right touch 25/Zoom Scan (5x5x7)/Cube 0: Measurement grid: dx=8mm, dy=8mm, dz=5mm

Reference Value = 25.1 V/m; Power Drift = 0.094 dB

Peak SAR (extrapolated) = 1.87 W/kg

SAR(1 g) = 1.23 mW/g; SAR(10 g) = 0.761 mW/g

[Info: Interpolated medium parameters used for SAR evaluation.](#)

Maximum value of SAR (measured) = 1.32 mW/g

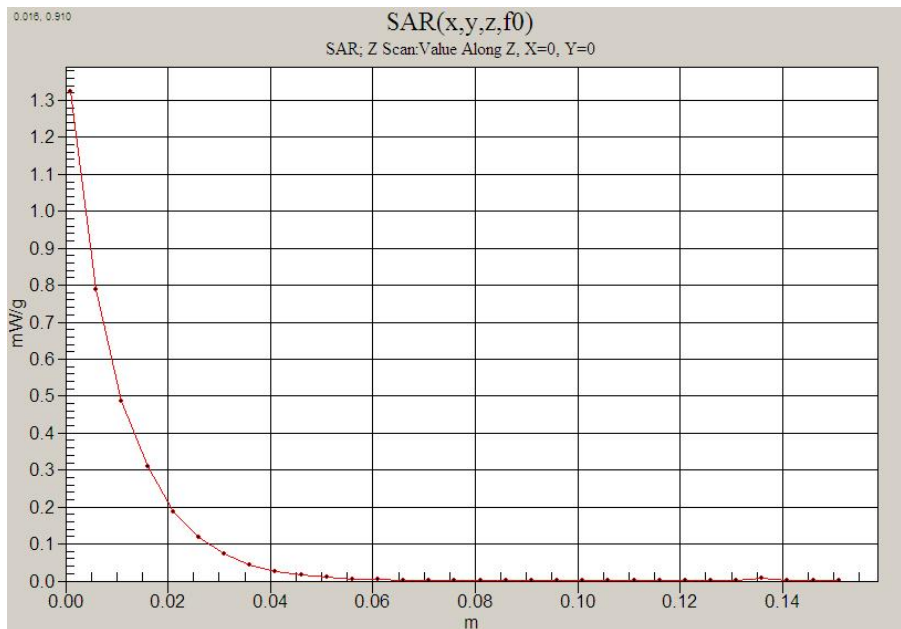

Attachment 2. – Dipole Validation Plots

■ Validation Data (1900 MHz Head)

Test Laboratory: HCT CO., LTD
Input Power 100 mW (20 dBm)
Liquid Temp: 21.2 °C
Test Date: Jun.14, 2009

DUT: Dipole 1900 MHz; Type: D1900V2; Serial: D1900V2 – SN:5d032

Communication System: CW; Frequency: 1900 MHz; Duty Cycle: 1:1
Medium parameters used: $f = 1900$ MHz; $\sigma = 1.46$ mho/m; $\epsilon_r = 38.3$; $\rho = 1000$ kg/m³
Phantom section: Flat Section ; Measurement SW: DASY4, V4.7 Build 71; Postprocessing SW: SEMCAD, V1.8 Build 176

DASY4 Configuration:

- Probe: ET3DV6 – SN1609; ConvF(5.12, 5.12, 5.12); Calibrated: 2009-03-17
- Sensor-Surface: 4mm (Mechanical Surface Detection)
- Electronics: DAE4 Sn869; Calibrated: 2008-09-03
- Phantom: SAM 1800/1900 MHz; Type: SAM

Dipole 1900MHz Validation/Area Scan (61x61x1): Measurement grid: dx=15mm, dy=15mm
Maximum value of SAR (interpolated) = 4.70 mW/g

Dipole 1900MHz Validation/Zoom Scan (5x5x7)/Cube 0: Measurement grid: dx=8mm, dy=8mm, dz=5mm
Reference Value = 57.9 V/m; Power Drift = -0.085 dB
Peak SAR (extrapolated) = 6.69 W/kg
SAR(1 g) = 3.86 mW/g; SAR(10 g) = 2.01 mW/g
Maximum value of SAR (measured) = 4.29 mW/g

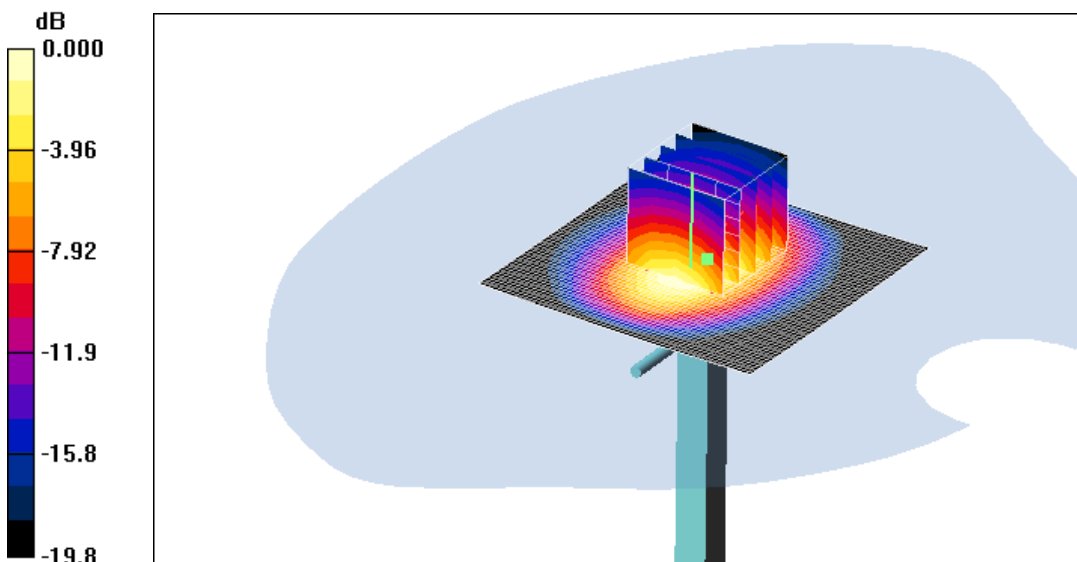

0 dB = 4.29mW/g

■ Dielectric Parameter (1900 MHz Head)

Title PX430,PX430R
SubTitle PCS1900(Head)
Test Date Jun.14, 2009

Frequency	e'	e''
1800000000	38.6089	13.6079
1810000000	38.5854	13.6167
1820000000	38.5807	13.6503
1830000000	38.5201	13.6990
1840000000	38.4687	13.7004
1850000000	38.4388	13.7310
1860000000	38.4050	13.7283
1870000000	38.3633	13.7601
1880000000	38.3062	13.7985
1890000000	38.2784	13.8103
1900000000	38.2534	13.8058
1910000000	38.2064	13.8356
1920000000	38.1477	13.8493
1930000000	38.1294	13.8557
1940000000	38.1047	13.8924
1950000000	38.0280	13.8861
1960000000	38.0054	13.8810
1970000000	37.9709	13.9475
1980000000	37.9247	13.9432
1990000000	37.9108	13.9792
2000000000	37.8802	14.0143

Attachment 3. – Probe Calibration Data

**Calibration Laboratory of
Schmid & Partner
Engineering AG**
Zeughausstrasse 43, 8004 Zurich, Switzerland



S Schweizerischer Kalibrierdienst
S Service suisse d'étalonnage
S Servizio svizzero di taratura
S Swiss Calibration Service

Accredited by the Swiss Accreditation Service (SAS)
The Swiss Accreditation Service is one of the signatories to the EA
Multilateral Agreement for the recognition of calibration certificates

Accreditation No.: **SCS 108**

Client **HCT (Dymstec)**

Certificate No: **ET3-1609_Mar09**

CALIBRATION CERTIFICATE

Object: **ET3DV6 - SN:1609**

Calibration procedure(s): **QA CAL-01.v6, QA CAL-12.v5 and QA CAL-23.v3
Calibration procedure for dosimetric E-field probes**

Calibration date: **March 17, 2009**

Condition of the calibrated item: **In Tolerance**

This calibration certificate documents the traceability to national standards, which realize the physical units of measurements (SI).
The measurements and the uncertainties with confidence probability are given on the following pages and are part of the certificate.

All calibrations have been conducted in the closed laboratory facility: environment temperature (22 ± 3)*°C and humidity < 70%.

Calibration Equipment used (M&TE critical for calibration)

Primary Standards	ID #	Cal Date (Certificate No.)	Scheduled Calibration
Power meter E4419B	GB41293874	1-Apr-08 (No. 217-00788)	Apr-09
Power sensor E4412A	MY41495277	1-Apr-08 (No. 217-00788)	Apr-09
Power sensor E4412A	MY41498087	1-Apr-08 (No. 217-00788)	Apr-09
Reference 3 dB Attenuator	SN: S5054 (3c)	1-Jul-08 (No. 217-00865)	Jul-09
Reference 20 dB Attenuator	SN: S5086 (20b)	31-Mar-08 (No. 217-00787)	Apr-09
Reference 30 dB Attenuator	SN: S5129 (30b)	1-Jul-08 (No. 217-00866)	Jul-09
Reference Probe ES3DV2	SN: 3013	2-Jan-09 (No. ES3-3013_Jan09)	Jan-10
DAE4	SN: 660	9-Sep-08 (No. DAE4-660_Sep08)	Sep-09

Secondary Standards	ID #	Check Date (in house)	Scheduled Check
RF generator HP 8848C	US3642U01700	4-Aug-99 (in house check Oct-07)	In house check: Oct-08
Network Analyzer HP 8753E	US37390585	18-Oct-01 (in house check Oct-08)	In house check: Oct-08

	Name	Function	Signature
Calibrated by:	Marcel Fehr	Laboratory Technician	
Approved by:	Katja Pokovic	Technical Manager	

Issued: March 17, 2009

This calibration certificate shall not be reproduced except in full without written approval of the laboratory.

**Calibration Laboratory of
Schmid & Partner
Engineering AG**
Zeughausstrasse 43, 8004 Zurich, Switzerland



S Schweizerischer Kalibrierdienst
S Service suisse d'étalonnage
C Servizio svizzero di taratura
S Swiss Calibration Service

Accredited by the Swiss Accreditation Service (SAS)
The Swiss Accreditation Service is one of the signatories to the EA
Multilateral Agreement for the recognition of calibration certificates

Accreditation No.: **SCS 108**

Glossary:

TSL	tissue simulating liquid
NORM _{x,y,z}	sensitivity in free space
ConvF	sensitivity in TSL / NORM _{x,y,z}
DCP	diode compression point
Polarization φ	φ rotation around probe axis
Polarization ϑ	ϑ rotation around an axis that is in the plane normal to probe axis (at measurement center), i.e., $\vartheta = 0$ is normal to probe axis

Calibration is Performed According to the Following Standards:

- IEEE Std 1528-2003, "IEEE Recommended Practice for Determining the Peak Spatial-Averaged Specific Absorption Rate (SAR) in the Human Head from Wireless Communications Devices: Measurement Techniques", December 2003
- IEC 62209-1, "Procedure to measure the Specific Absorption Rate (SAR) for hand-held devices used in close proximity to the ear (frequency range of 300 MHz to 3 GHz)", February 2005

Methods Applied and Interpretation of Parameters:

- NORM_{x,y,z}:** Assessed for E-field polarization $\vartheta = 0$ ($f \leq 900$ MHz in TEM-cell; $f > 1800$ MHz: R22 waveguide). NORM_{x,y,z} are only intermediate values, i.e., the uncertainties of NORM_{x,y,z} does not effect the E²-field uncertainty inside TSL (see below ConvF).
- NORM(f)_{x,y,z} = NORM_{x,y,z} * frequency_response** (see Frequency Response Chart). This linearization is implemented in DASY4 software versions later than 4.2. The uncertainty of the frequency response is included in the stated uncertainty of ConvF.
- DCP_{x,y,z}:** DCP are numerical linearization parameters assessed based on the data of power sweep (no uncertainty required). DCP does not depend on frequency nor media.
- ConvF and Boundary Effect Parameters:** Assessed in flat phantom using E-field (or Temperature Transfer Standard for $f \leq 800$ MHz) and inside waveguide using analytical field distributions based on power measurements for $f > 800$ MHz. The same setups are used for assessment of the parameters applied for boundary compensation (alpha, depth) of which typical uncertainty values are given. These parameters are used in DASY4 software to improve probe accuracy close to the boundary. The sensitivity in TSL corresponds to NORM_{x,y,z} * ConvF whereby the uncertainty corresponds to that given for ConvF. A frequency dependent ConvF is used in DASY version 4.4 and higher which allows extending the validity from ± 50 MHz to ± 100 MHz.
- Spherical isotropy (3D deviation from isotropy):** in a field of low gradients realized using a flat phantom exposed by a patch antenna.
- Sensor Offset:** The sensor offset corresponds to the offset of virtual measurement center from the probe tip (on probe axis). No tolerance required.

ET3DV6 SN:1609

March 17, 2009

Probe ET3DV6

SN:1609

Manufactured:	July 21, 2001
Last calibrated:	August 30, 2007
Recalibrated:	March 17, 2009

Calibrated for DASY Systems

(Note: non-compatible with DASY2 system!)

ET3DV6 SN:1609

March 17, 2009

DASY - Parameters of Probe: ET3DV6 SN:1609

Sensitivity in Free Space ^A			Diode Compression ^B	
NormX	1.97 ± 10.1%	$\mu V/(V/m)^2$	DCP X	93 mV
NormY	1.87 ± 10.1%	$\mu V/(V/m)^2$	DCP Y	90 mV
NormZ	1.82 ± 10.1%	$\mu V/(V/m)^2$	DCP Z	93 mV

Sensitivity in Tissue Simulating Liquid (Conversion Factors)

Please see Page 8.

Boundary Effect

TSL 900 MHz Typical SAR gradient: 5 % per mm

Sensor Center to Phantom Surface Distance		3.7 mm	4.7 mm
SAR _{be} [%]	Without Correction Algorithm	11.4	7.0
SAR _{be} [%]	With Correction Algorithm	0.9	0.5

TSL 1750 MHz Typical SAR gradient: 10 % per mm

Sensor Center to Phantom Surface Distance		3.7 mm	4.7 mm
SAR _{be} [%]	Without Correction Algorithm	13.8	9.5
SAR _{be} [%]	With Correction Algorithm	0.9	0.6

Sensor Offset

Probe Tip to Sensor Center **2.7 mm**

The reported uncertainty of measurement is stated as the standard uncertainty of measurement multiplied by the coverage factor k=2, which for a normal distribution corresponds to a coverage probability of approximately 95%.

^A The uncertainties of NormX,Y,Z do not affect the E²-field uncertainty inside TSL (see Page 8).

^B Numerical linearization parameter: uncertainty not required

ET3DV6 SN:1609

March 17, 2009

Frequency Response of E-Field

(TEM-Cell:ifi110 EXX, Waveguide: R22)

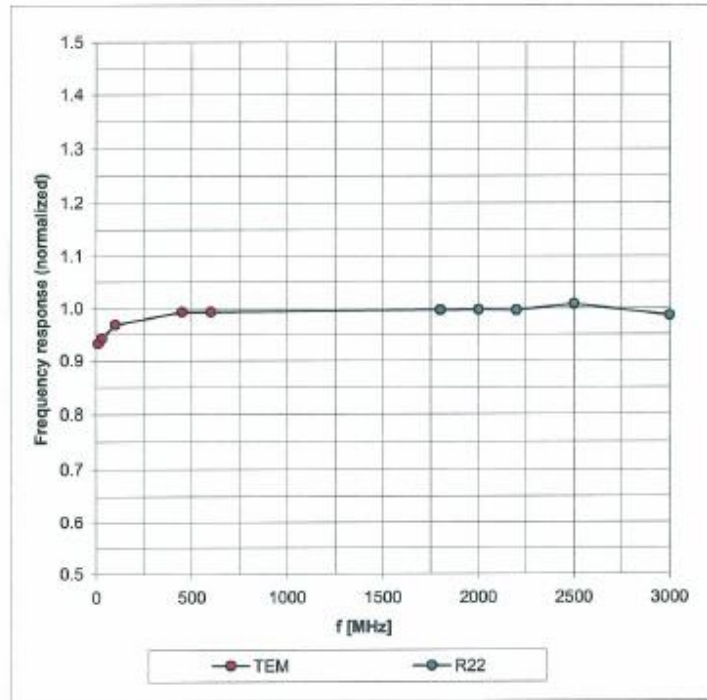

Uncertainty of Frequency Response of E-field: $\pm 6.3\%$ (k=2)

ET3DV6 SN:1609

March 17, 2009

Receiving Pattern (ϕ), $\theta = 0^\circ$

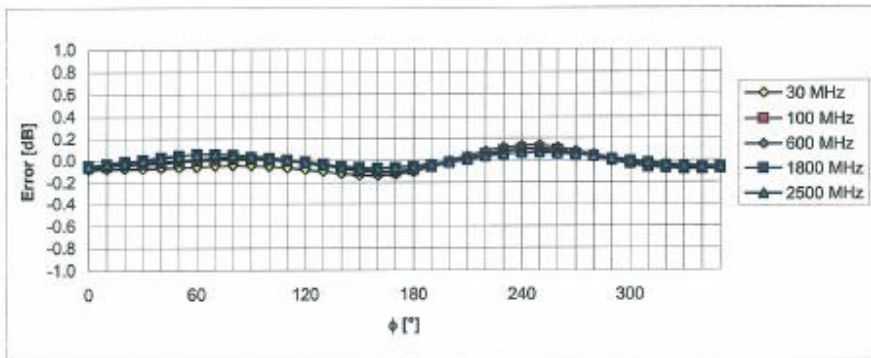
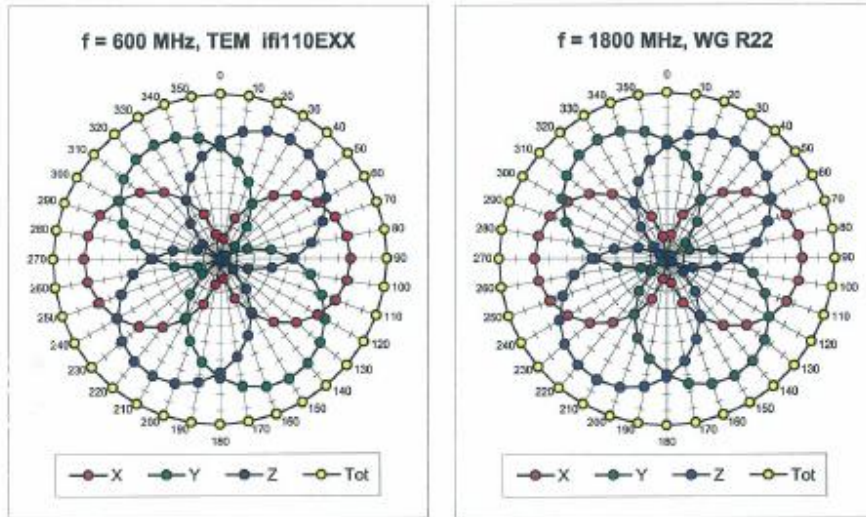

Uncertainty of Axial Isotropy Assessment: $\pm 0.5\%$ ($k=2$)

ET3DV6 SN:1609

March 17, 2009

Dynamic Range f(SAR_{head})
(Waveguide R22, f = 1800 MHz)

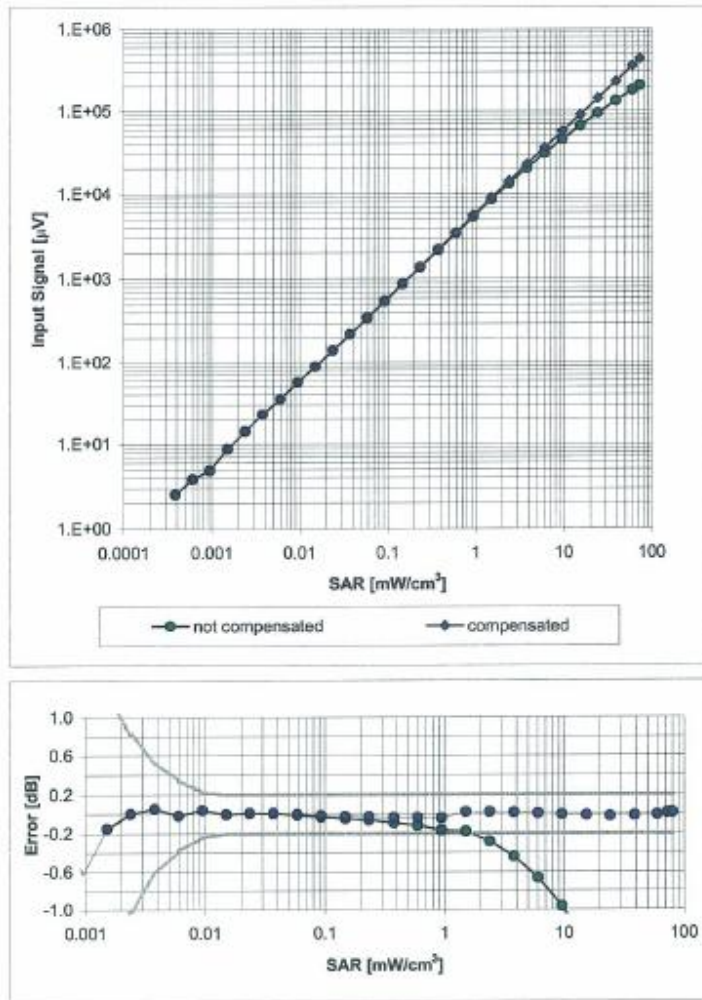

Uncertainty of Linearity Assessment: ± 0.6% (k=2)

ET3DV6 SN:1609

March 17, 2009

Conversion Factor Assessment

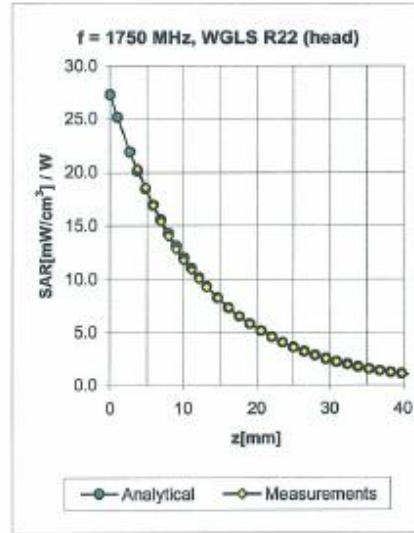
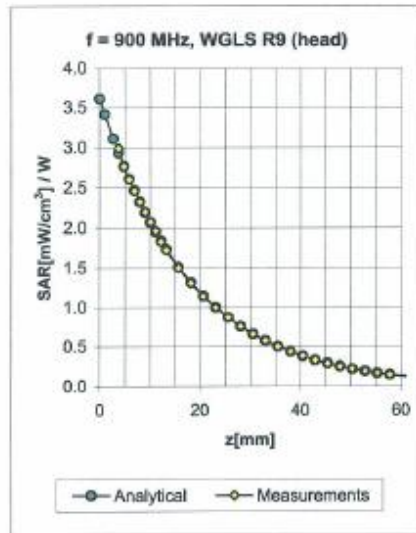

f [MHz]	Validity [MHz] ^c	TSL	Permittivity	Conductivity	Alpha	Depth	ConvF Uncertainty
450	± 50 / ± 100	Head	43.5 ± 5%	0.87 ± 5%	0.38	1.91	6.91 ± 13.3% (k=2)
835	± 50 / ± 100	Head	41.5 ± 5%	0.90 ± 5%	0.25	2.80	6.25 ± 11.0% (k=2)
900	± 50 / ± 100	Head	41.5 ± 5%	0.97 ± 5%	0.25	2.80	6.11 ± 11.0% (k=2)
1750	± 50 / ± 100	Head	40.1 ± 5%	1.37 ± 5%	0.39	3.57	5.39 ± 11.0% (k=2)
1900	± 50 / ± 100	Head	40.0 ± 5%	1.40 ± 5%	0.50	2.75	5.12 ± 11.0% (k=2)
1950	± 50 / ± 100	Head	40.0 ± 5%	1.40 ± 5%	0.55	2.52	5.01 ± 11.0% (k=2)
2450	± 50 / ± 100	Head	39.2 ± 5%	1.80 ± 5%	0.99	1.76	4.54 ± 11.0% (k=2)
450	± 50 / ± 100	Body	56.7 ± 5%	0.94 ± 5%	0.30	1.92	7.48 ± 13.3% (k=2)
835	± 50 / ± 100	Body	55.2 ± 5%	0.97 ± 5%	0.25	2.85	6.08 ± 11.0% (k=2)
1750	± 50 / ± 100	Body	53.4 ± 5%	1.49 ± 5%	0.77	3.05	4.89 ± 11.0% (k=2)
1900	± 50 / ± 100	Body	53.3 ± 5%	1.52 ± 5%	0.99	2.60	4.61 ± 11.0% (k=2)
2450	± 50 / ± 100	Body	52.7 ± 5%	1.95 ± 5%	0.99	1.78	4.00 ± 11.0% (k=2)

^c The validity of ± 100 MHz only applies for DASY v4.4 and higher (see Page 2). The uncertainty is the RSS of the ConvF uncertainty at calibration frequency and the uncertainty for the indicated frequency band.

ET3DV6 SN:1609

March 17, 2009

Deviation from Isotropy in HSL

Error (ϕ, θ), $f = 900$ MHz

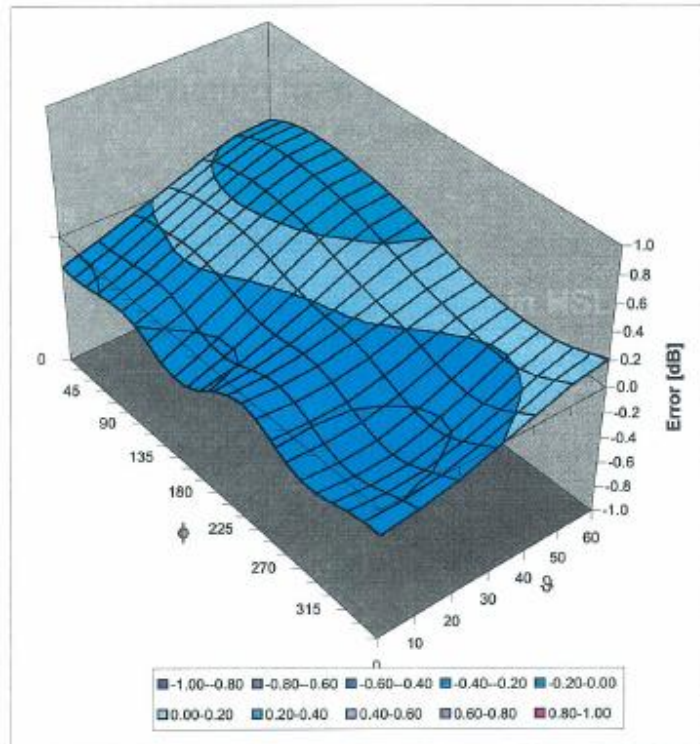

Uncertainty of Spherical Isotropy Assessment: $\pm 2.6\%$ ($k=2$)

Attachment 4. – Dipole Calibration Data

**Calibration Laboratory of
Schmid & Partner
Engineering AG**
Zeughausstrasse 43, 8004 Zurich, Switzerland



S Schweizerischer Kalibrierdienst
C Service suisse d'étalonnage
S Servizio svizzero di taratura
S Swiss Calibration Service

Accredited by the Swiss Accreditation Service (SAS)
The Swiss Accreditation Service is one of the signatories to the EA
Multilateral Agreement for the recognition of calibration certificates

Accreditation No.: **SCS 108**

Client **H-CT (Dymstec)**

Certificate No: **D1900V2-5d032-Jul08**

CALIBRATION CERTIFICATE

Object **D1900V2 - SN: 5d032**

Calibration procedure(s) **QA CAL-05.v7
Calibration procedure for dipole validation kits**

Calibration date: **July 22, 2008**

Condition of the calibrated item **In Tolerance**

This calibration certificate documents the traceability to national standards, which realize the physical units of measurements (SI).
The measurements and the uncertainties with confidence probability are given on the following pages and are part of the certificate.

All calibrations have been conducted in the closed laboratory facility; environment temperature (22 ± 3)°C and humidity < 70%.

Calibration Equipment used (M&TE critical for calibration)

Primary Standards	ID #	Cal Date (Calibrated by, Certificate No.)	Scheduled Calibration
Power meter EPM-442A	GB37480704	04-Oct-07 (No. 217-00736)	Oct-08
Power sensor HP 8481A	US37292783	04-Oct-07 (No. 217-00736)	Oct-08
Reference 20 dB Attenuator	SN: 5086 (20g)	01-Jul-08 (No. 217-00864)	Jul-09
Type-N mismatch combination	SN: 5047.2 / 06327	01-Jul-08 (No. 217-00867)	Jul-09
Reference Probe ES3DV2	SN: 3025	28-Apr-08 (No. ES3-3025_Apr08)	Apr-09
DAE4	SN: 601	14-Mar-08 (No. DAE4-601_Mar08)	Mar-09

Secondary Standards	ID #	Check Date (in house)	Scheduled Check
Power sensor HP 8481A	MY41092317	18-Oct-02 (in house check Oct-07)	In house check: Oct-09
RF generator R&S SMT-06	100005	4-Aug-99 (in house check Oct-07)	In house check: Oct-09
Network Analyzer HP 8753E	US37390585 S4206	18-Oct-01 (in house check Oct-07)	In house check: Oct-08

	Name	Function	Signature
Calibrated by:	Jeton Kastrati	Laboratory Technician	
Approved by:	Katja Pokovic	Technical Manager	

Issued: July 22, 2008

This calibration certificate shall not be reproduced except in full without written approval of the laboratory.

Calibration Laboratory of
Schmid & Partner
Engineering AG
Zeughausstrasse 43, 8004 Zurich, Switzerland



S Schweizerischer Kalibrierdienst
C Service suisse d'étalonnage
S Servizio svizzero di taratura
S Swiss Calibration Service

Accredited by the Swiss Accreditation Service (SAS)
The Swiss Accreditation Service is one of the signatories to the EA
Multilateral Agreement for the recognition of calibration certificates

Accreditation No.: **SCS 108**

Glossary:

TSL tissue simulating liquid
ConvF sensitivity in TSL / NORM x,y,z
N/A not applicable or not measured

Calibration is Performed According to the Following Standards:

- a) IEEE Std 1528-2003, "IEEE Recommended Practice for Determining the Peak Spatial-Averaged Specific Absorption Rate (SAR) in the Human Head from Wireless Communications Devices: Measurement Techniques", December 2003
- b) CENELEC EN 50361, "Basic standard for the measurement of Specific Absorption Rate related to human exposure to electromagnetic fields from mobile phones (300 MHz - 3 GHz), July 2001
- c) Federal Communications Commission Office of Engineering & Technology (FCC OET), "Evaluating Compliance with FCC Guidelines for Human Exposure to Radiofrequency Electromagnetic Fields; Additional Information for Evaluating Compliance of Mobile and Portable Devices with FCC Limits for Human Exposure to Radiofrequency Emissions", Supplement C (Edition 01-01) to Bulletin 65

Additional Documentation:

- d) DASY4/5 System Handbook

Methods Applied and Interpretation of Parameters:

- *Measurement Conditions:* Further details are available from the Validation Report at the end of the certificate. All figures stated in the certificate are valid at the frequency indicated.
- *Antenna Parameters with TSL:* The dipole is mounted with the spacer to position its feed point exactly below the center marking of the flat phantom section, with the arms oriented parallel to the body axis.
- *Feed Point Impedance and Return Loss:* These parameters are measured with the dipole positioned under the liquid filled phantom. The impedance stated is transformed from the measurement at the SMA connector to the feed point. The Return Loss ensures low reflected power. No uncertainty required.
- *Electrical Delay:* One-way delay between the SMA connector and the antenna feed point. No uncertainty required.
- *SAR measured:* SAR measured at the stated antenna input power.
- *SAR normalized:* SAR as measured, normalized to an input power of 1 W at the antenna connector.
- *SAR for nominal TSL parameters:* The measured TSL parameters are used to calculate the nominal SAR result.

Measurement Conditions

DASY system configuration, as far as not given on page 1.

DASY Version	DASY4	V4.7
Extrapolation	Advanced Extrapolation	
Phantom	Modular Flat Phantom V5.0	
Distance Dipole Center - TSL	10 mm	with Spacer
Zoom Scan Resolution	dx, dy, dz = 5 mm	
Frequency	1900 MHz \pm 1 MHz	

Head TSL parameters

The following parameters and calculations were applied.

	Temperature	Permittivity	Conductivity
Nominal Head TSL parameters	22.0 °C	40.0	1.40 mho/m
Measured Head TSL parameters	(22.0 \pm 0.2) °C	38.8 \pm 6 %	1.47 mho/m \pm 6 %
Head TSL temperature during test	(22.0 \pm 0.2) °C	---	---

SAR result with Head TSL

SAR averaged over 1 cm³ (1 g) of Head TSL	condition	
SAR measured	250 mW input power	9.82 mW / g
SAR normalized	normalized to 1W	39.3 mW / g
SAR for nominal Head TSL parameters ¹	normalized to 1W	37.7 mW / g \pm 17.0 % (k=2)

SAR averaged over 10 cm³ (10 g) of Head TSL	Condition	
SAR measured	250 mW input power	5.05 mW / g
SAR normalized	normalized to 1W	20.2 mW / g
SAR for nominal Head TSL parameters ¹	normalized to 1W	19.7 mW / g \pm 16.5 % (k=2)

¹ Correction to nominal TSL parameters according to d), chapter "SAR Sensitivities"

Appendix**Antenna Parameters with Head TSL**

Impedance, transformed to feed point	53.5 Ω + 4.9 j Ω
Return Loss	- 24.8 dB

General Antenna Parameters and Design

Electrical Delay (one direction)	1.185 ns
----------------------------------	----------

After long term use with 100W radiated power, only a slight warming of the dipole near the feedpoint can be measured.

The dipole is made of standard semirigid coaxial cable. The center conductor of the feeding line is directly connected to the second arm of the dipole. The antenna is therefore short-circuited for DC-signals.

No excessive force must be applied to the dipole arms, because they might bend or the soldered connections near the feedpoint may be damaged.

Additional EUT Data

Manufactured by	SPEAG
Manufactured on	March 17, 2003

DASY4 Validation Report for Head TSL

Date/Time: 22.07.2008 10:06:43

Test Laboratory: SPEAG, Zurich, Switzerland

DUT: Dipole 1900 MHz; Type: D1900V2; Serial: D1900V2 - SN:5d032

Communication System: CW; Frequency: 1900 MHz; Duty Cycle: 1:1

Medium: HSL U10 BB;

Medium parameters used: $f = 1900$ MHz; $\sigma = 1.47$ mho/m; $\epsilon_r = 38.8$; $\rho = 1000$ kg/m³

Phantom section: Flat Section

Measurement Standard: DASY4 (High Precision Assessment)

DASY4 Configuration:

- Probe: ES3DV2 - SN3025; ConvF(4.9, 4.9, 4.9); Calibrated: 28.04.2008
- Sensor-Surface: 3.4mm (Mechanical Surface Detection)
- Electronics: DAE4 Sn601; Calibrated: 14.03.2008
- Phantom: Flat Phantom 5.0 (front); Type: QD000P50AA; ;
- Measurement SW: DASY4, V4.7 Build 71; Postprocessing SW: SEMCAD, V1.8 Build 184

Pin = 250 mW; dip = 10 mm, scan at 3.4mm/Zoom Scan (dist=3.4mm, probe 0deg)**(7x7x7)/Cube 0: Measurement grid: dx=5mm, dy=5mm, dz=5mm**

Reference Value = 92.2 V/m; Power Drift = 0.010 dB

Peak SAR (extrapolated) = 18.2 W/kg

SAR(1 g) = 9.82 mW/g; SAR(10 g) = 5.05 mW/g

Maximum value of SAR (measured) = 11.9 mW/g

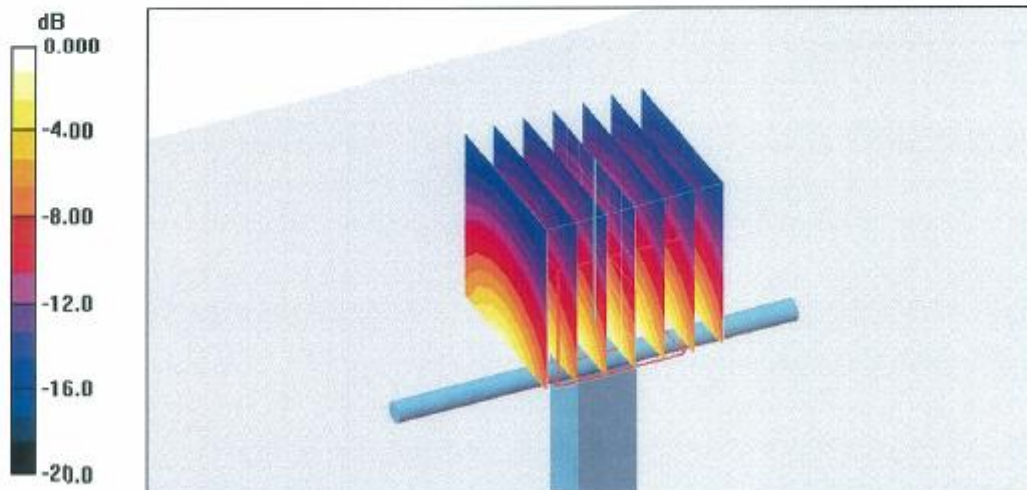

0 dB = 11.9mW/g

Impedance Measurement Plot for Head TSL

