



HAC

# TEST REPORT

of

**Fixed Wireless Phone on CDMA800/1900/1575MHz**

Model Name: PX340G  
Trade Name: Axesstel Inc  
Report No.: SZ10070008H01  
FCC ID: PH7PX340G

prepared for

**Axesstel Inc**

6815 Flanders Drive, #210, San Diego, CA 92121, USA

prepared by

**Shenzhen Electronic Product Quality Testing Center**

**Morlab Laboratory**

3/F, Electronic Testing Building, Shahe Road, Xili,  
Nanshan District, Shenzhen, 518055 P. R. China

Tel: +86 755 86130398

Fax: +86 755 86130218



**PC63.19 HAC Rated Category: M3 (RF EMISSIONS)**

*NOTE: This test report can be duplicated completely for the legal use with the approval of the applicant, it shall not be reproduced except in full, without the written approval of Shenzhen Electronic Product Quality Testing Center Morlab Laboratory. Any objections should be raised to us within thirty workdays since the date of issue.*



## Contents

1.1. Notes .....	3
1.2. Organization item.....	3
1.3. Conclusion.....	3
2. TEST SITE DESCRIPTION .....	4
2.1. Identification of the Responsible Testing Laboratory.....	4
2.2. Identification of the Responsible Testing Location .....	4
2.3. Accreditation Certificate .....	4
2.4. List of Test Equipments .....	4
3. TECHNICAL INFORMATION .....	6
3.1. Identification of Applicant.....	6
3.2. Identification of Manufacturer .....	6
3.3. Description of EUT .....	6
3.3.1. Photographs of the EUT .....	7
3.3.2. Identification of all used EUTs.....	7
4. TEST RESULTS.....	7
4.1. Applied Reference Documents .....	7
4.2. Test Environment/Conditions .....	8
4.3. Operational Conditions During Test .....	9
4.3.1. INTRODUCTION.....	9
4.3.2. ANSI/IEEE PC 63.19 PERFORMANCE CATEGORIES .....	10
4.3.3. Description of Test System.....	11
4.3.4. TEST PROCEDURE .....	15
4.3.5. SYSTEM CHECK.....	17
4.3.6. Uncertainty Estimation Table .....	19
4.3.7. OVERALL MEASUREMENT SUMMARY .....	20
4.3.8. TEST DATA .....	21
ANNEX A ACCREDITATION CERTIFICATE.....	46
ANNEX B PHOTOGRAPHS OF THE EUT .....	47

## General Information

### 1.1. Notes

The test results of this test report relate exclusively to the information specified in section. Shenzhen Electronic Product Quality Testing Center Morlab Laboratory does not assume responsibility for any conclusions and generalizations drawn from the test results with regard to other specimens or samples of the type of the equipment represented by the identification. The test report may only be reproduced or published in full. Reproduction or publications of extracts from the test report requires the prior written approval of Shenzhen Electronic Product Quality Testing Center Morlab Laboratory. The test report shall be invalid without all the signatures of testing the Project Manager, the Deputy Project Manager and the Test Lab Manager. Any objections must be raised to Morlab within 30 days since the date when the report is received. It will not be taken into consideration beyond this limit.

### 1.2. Organization item

Report No.:	SZ10070008H01
Date of Issue:	Aug. 12, 2010
Date of Tests:	Aug. 10, 2010 –Aug. 10, 2010
Responsible for Accreditation:	Shu Luan
Project Manager:	Li Lei
Deputy Project Manager:	Chen Chao

### 1.3. Conclusion

Shenzhen Electronic Product Quality Testing Center Morlab Laboratory has verified that all tests as listed in the section of this report haven been performed successfully with the tested equipment.

 Chen Chao <b>Tested by</b> (Responsible for the Test Report)	 Shu Luan <b>Approved by</b> (Responsible Test Lab Manager)	 Li Lei <b>Reviewed by</b> (Verification of the Test Report)
---	---	--



## 2. Test Site Description

### 2.1. Identification of the Responsible Testing Laboratory

Company Name: Shenzhen Electronic Product Quality Testing Center  
Address: 3/F, Electronic Testing Building, Shahe Road, Nanshan District, Shenzhen, 518055 P. R. China  
Responsible Test Lab Manager: Mr. Shu Luan  
Telephone: +86 755 86130268  
Facsimile: +86 755 86130218

### 2.2. Identification of the Responsible Testing Location

Name: Shenzhen Electronic Product Quality Testing Center Morlab Laboratory  
Address: 3/F, Electronic Testing Building, Shahe Road, Nanshan District, Shenzhen, 518055 P. R. China

All measurement facilities used to collect the measurement data are located at Electronic Testing Building, Shahe Road, Xili, Nanshan District, Shenzhen 518055 CHINA. The test site is constructed in conformance with the requirements of ANSI C63.7, ANSI C63.4 and CISPR Publication 22; the FCC registration number is 741109.

### 2.3. Accreditation Certificate

Accredited Testing Laboratory: No. CNAS L1659

### 2.4. List of Test Equipments

No.	Instrument	Type
1	PC	Dell (Pentium IV 2.4GHz, SN:X10-23533)
2	Network Emulator	Rohde&Schwarz (CMU200, SN:105894)
3	Voltmeter	Keithley (2000, SN:1000572)
4	Synthetizer	Rohde&Schwarz (SML_03, SN:101868)
5	Amplifier	Nucl udes (ALB216, SN:10800)
6	Power Meter	Rohde&Schwarz (NRVD, SN:101066)
7	Audio DAQ	NI (MonDAQ, SN:MonNumero)
8	E-FIELD PROBE	SN: SN 41/08 EPH17
9	H-FIELD PROBE	SN: SN 41/08 HPH18



10	T-COIL PROBE	SN: SN 39/08 TCP11
11	800-950 MHZ DIPOLE	SN: SN 36/08 DHA16
12	1700-2000 MHZ DIPOLE	SN: SN 36/08 DHB16
13	HAC holder	SN02_EPH02 (SN:SN_3608_SUPH16)



### 3. Technical Information

Note: the following data is based on the information by the applicant.

#### 3.1. Identification of Applicant

Company Name: Axesstel Inc  
Address: 6815 Flanders Drive, #210, San Diego, CA 92121, USA

#### 3.2. Identification of Manufacturer

Company Name: Asiatelco Technologies Co.  
Address: #289 Bisheng Rd, Bld-8, 3F, Zhangjiang Hi-Tech Park, Pudong, Shanghai, China

#### 3.3. Description of EUT

Brand Name: Axesstel Inc  
Type Name: Axesstel Inc  
Marking Name: PX340G  
Hardware Version: P2  
Software Version: PX340G\_C1.1C.US\_46\_4T  
Frequency Bands: CDMA 800MHz (channel 1013:824.70MHz, channel 384:836.50MHz, Channel 848.30MHz)  
CDMA 1900MHz (channel 25:1851.2MHz, channel 600:1880.00MHz, Channel 1175:1908.8MHz)  
Antenna type: Build inside  
Accessories: Charger; Battery  
Battery Model: PX340G  
Battery specification: 1200mAh 3.7V  
Development Stage: Identical prototype  
Classification: Licensed Transmitter Held to Ear

### 3.3.1. Photographs of the EUT

Please see for photographs of the EUT.

### 3.3.2. Identification of all used EUTs

The EUT Identity consists of numerical and letter characters (see the table below), the first five numerical characters indicates the Type of the EUT defined by Morlab, the next letter character indicates the test sample, and the following two numerical characters indicates the software version of the test sample.

EUT Identity	Hardware Version	Software Version
1#	P2	PX340G_C1.1C.US_46_4T

## 4. Test Results

### 4.1. Applied Reference Documents

Leading reference documents for testing:

No.	Identity	Document Title
1	ANSI C 63.19: 2007	American National Standard Methods of Measurement of Compatibility between Wireless Communications Devices and Hearing Aids

**Note:** Test report, reference KDB 285076 documents.

## 4.2. Test Environment/Conditions

Normal Temperature (NT):	20 ... 25 °C
Relative Humidity:	30 ... 75 %
Air Pressure:	980 ... 1020 hPa
Details of Power Supply:	220V/50Hz AC
Extreme Temperature:	Low Temperature (LT) = -10°C
	High Temperature (HT) = 55°C
Extreme Voltage of the EUT:	Normal Voltage (NV) = 3.70V
	Low Voltage (LV) = 3.60V
	High Voltage (HV) = 4.20V
Test frequency:	GSM 900MHz
	PCS 1800MHz
Operation mode:	Call established
Power Level:	GSM 850 MHz Maximum output power(level 5)
	PCS 1900 MHz Maximum output power(level 0)

During SAR test, EUT is in Traffic Mode (Channel Allocated) at Normal Voltage Condition. A communication link is set up with a System Simulator (SS) by air link, and a call is established. The Absolute Radio Frequency Channel Number (ARFCN) is allocated to 1013, 384 and 777 respectively in the case of CDMA 800MHz or is allocated to 25, 600 and 1175 respectively in the case of CDMA 1900MHz, The EUT is commanded to operate at maximum transmitting power.



### 4.3. Operational Conditions During Test

#### 4.3.1. INTRODUCTION

On July 10, 2003, the Federal Communications Commission (FCC) adopted new rules requiring wireless manufacturers and service providers to provide digital wireless phones that are compatible with hearing aids. The FCC has modified the exemption for wireless phones under the Hearing Aid Compatibility Act of 1998 (HAC Act) in WT Docket 01-309 RM-8658 to extend the benefits of wireless telecommunications to individuals with hearing disabilities. These benefits encompass business, social and emergency communications, which increase the value of the wireless network for everyone. An estimated more than 10% of the population in the United States show signs of hearing impairment and of that fraction, almost 80% use hearing aids. Approximately 500 million people worldwide suffer from hearing loss.

Compatibility Tests involved:

The standard calls for wireless communications devices to be measured for:

- RF Electric-field emissions.
- RF Magnetic- field emissions.
- T-coil mode, magnetic-signal strength in the audio band.
- T-coil mode, magnetic-signal frequency response through the audio band.
- T-coil mode, magnetic-signal and noise articulation index.

The hearing aid must be measured for:

- RF immunity in microphone mode
- RF immunity in T-coil mode

In the following tests and results, this report includes the evaluation for a wireless communications device

### 4.3.2. ANSI/IEEE PC 63.19 PERFORMANCE CATEGORIES

#### 4.3.2.1. RF EMISSIONS

The ANSI Standard presents performance requirements for acceptable interoperability of hearing with wireless communications devices. When these parameters are met, a hearing aid operates acceptably in close proximity to a wireless communications device.

Category	AWF (dB)	Limits for E-Field Emission (V/m)	Limits for H-Field Emission (A/m)
M1	0	631.0 - 1122.0	1.91 - 3.39
	-5	473.2 - 841.4	1.43 - 2.54
M2	0	354.8 - 631.0	1.07 - 1.91
	-5	266.1 - 473.2	0.80 - 1.43
M3	0	199.5 - 354.8	0.6 - 1.07
	-5	149.6 - 266.1	0.45 - 0.80
M4	0	<199.5	<0.60
	-5	<149.6	<0.45

Hearing aid and WD near-field categories as defined in ANSI PC 63.19. During testing, the hearing aid must maintain an input-referenced interference level of less than 55dB a gain compression of less than 6dB.

#### 4.3.2.2. Articulation Weighing Factor (AWF)

Standard	Technology	AWF
T1/T1P1/3GPP	UMTS(WCDMA)	0
IS-95	CDMA	0
iden	GSM(22and 11Hz)	0
J-STD-007	GSM(217Hz)	-5

AWF has been developed from information presented to the committee regarding the interference potential of the various modulation types according to ANSI PC 63.19

### 4.3.3. Description of Test System

#### 4.3.3.1. COMO HAC E-FIELD PROBE



Serial Number:	SN 41/08 EPH17
Frequency:	100MHz – 3GHz
Probe length:	330mm
Length of one dipole:	3.3mm
Maximum external diameter:	8mm
Probe extremity diameter:	6mm
Distance between dipoles/probe extremity:	3mm
Resistance of the three dipole (at the connector) :	Dipole 1:R1=2.1807 MΩ Dipole 2:R1=2.0612 MΩ Dipole 3:R3=2.1892 MΩ
Connector (HIROSE series SR30)	6 wire male (Hirose SR30series)

### CALIBRATION TEST EQUIPMENT

TYPE	IDENTIFICATION
Calibration bench	SATIMO AIR CALIBRATION SOFTWARE
Multimeter	Keithley 2000

### MEASUREMENT PROCEDURE

Probe calibration is realized by using the waveguide method. The probe was inserted in a waveguide loading by a 50 load. By controlling the input power in the waveguide, we are able to create a know EField value in the waveguide. ,

Keithley configuration:

Rate = Medium; Filter =ON; RDGS=10; FILTER TYPE =MOVING AVERAGE; RANGE AUTO

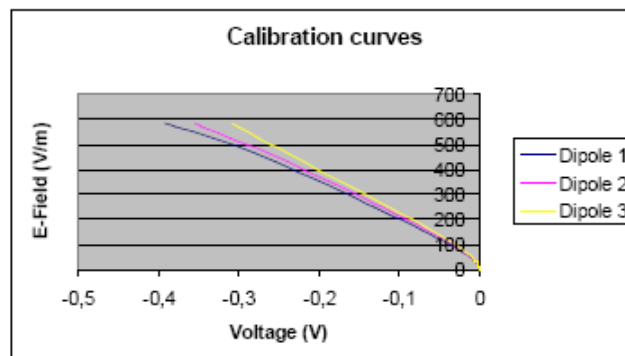

The following tables represent the calibration curves linearization by curve segment in CW signal.

### 4.3.3.2. COMO HAC H-FIELD PROBE



Serial Number:	SN 41/08 HPH18
Frequency:	100MHz – 3GHz
Probe length:	330mm
Length of one dipole:	3.3mm
Maximum external diameter:	8mm
Probe extremity diameter:	6mm
Distance between dipoles/probe extremity:	3mm
Resistance of the three dipole (at the connector ):	Dipole 1:R1=2.1650 MΩ Dipole 2:R1=2.2176 MΩ Dipole 3:R3=2.4084 MΩ
Connector (HIROSE series SR30)	6 wire male (Hirose SR30series)

### CALIBRATION TEST EQUIPMENT

TYPE	IDENTIFICATION
Calibration bench	SATIMO AIR CALIBRATION SOFTWARE
Multimeter	Keithley 2000

### MEASUREMENT PROCEDURE

Probe calibration is realized by using the waveguide method. The probe was inserted in a waveguide loading by a 50 load. By controlling the input power in the waveguide, we are able to create a know HField value in the waveguide.

Keithley configuration:

Rate = Medium; Filter =ON; RDGS=10; FILTER TYPE =MOVING AVERAGE; RANGE AUTO

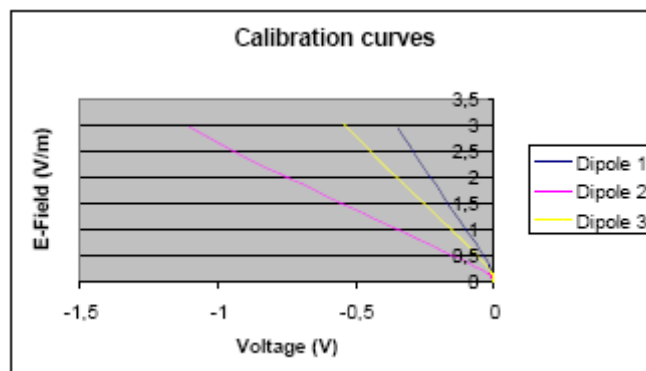

The following tables represent the calibration curves linearization by curve segment in CW signal.

### 4.3.3.3. COMO HAC T-COIL PROBE



Serial Number:	SN 39/08 TCP11
Dimensions:	6.55mm length*2.29mm diameter
DC resistance:	860.6Ω
Wire size:	51 AWG
Inductance:	132.1 mH at 1kHz
Sensitivity:	-60.22 dB (V/A/m) at 1kHz

### SENSITIVITY

Probe coil sensitivity relative to sensitivity at 1000 Hz

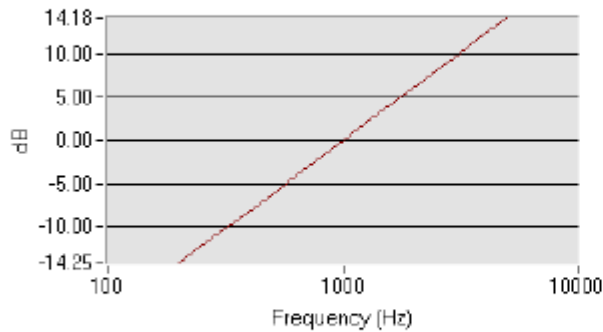

T-Coil probe sensitivity (dB V/(A/m))

Frequency (Hz)	H (dB (V/(A/m)))
200	-73.92940009
250	-72.01119983
315	-70.06378892
400	-67.88880017
500	-66.00059991
630	-64.07318901
800	-62.00820026
1000	-60.22
1250	-58.29179974
1600	-56.20760035
2000	-54.31940009
2500	-52.36119983
3150	-50.38378892
4000	-48.50880017
5000	-46.44059991

### LINEARITY

Linearity = 0.27 dB

Power (dB) relative to 1 A/m	0	-10	-20	-30	-40	-50
H (dB (V/(A/m)))	0	-9.95	-19.95	-30	-39.9	-49.73

#### 4.3.3.4. System Hardware

The HAC positioning ruler is used to position the phone properly with the regard to the position of the probe during a measurement. The positioning system is made of a dedicated frame that can be fixed on the table. The tip of the probe is positioned on a reference point located on the top of the positioning ruler. The distance between this reference point and the cross located on the ruler being known, the speaker of the phone is positioned on this cross in order to make sure both probe and phone are positioned properly.

During the measurement, the HAC ruler has to be removed so that it does not interfere with the measurement.

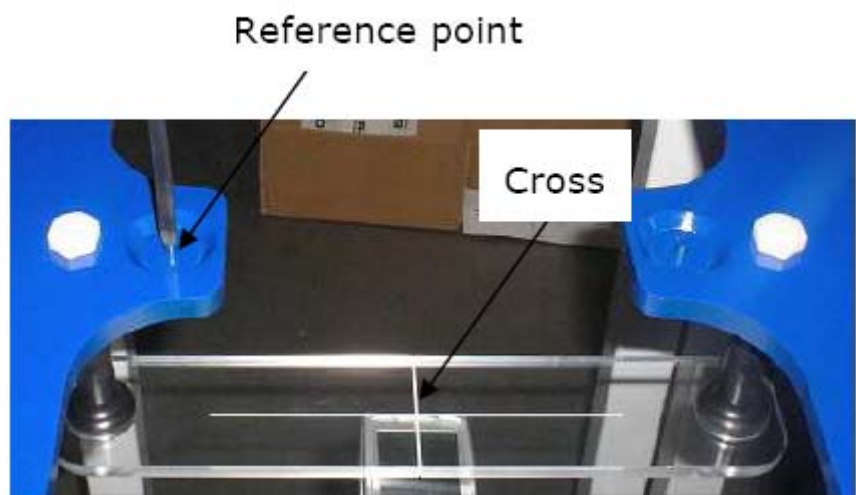

HAC positioning ruler

### 4.3.4. TEST PROCEDURE

#### 4.3.4.1. RF EMISSIONS

Per ANSI C 63.19 2007:

#### Test Instructions

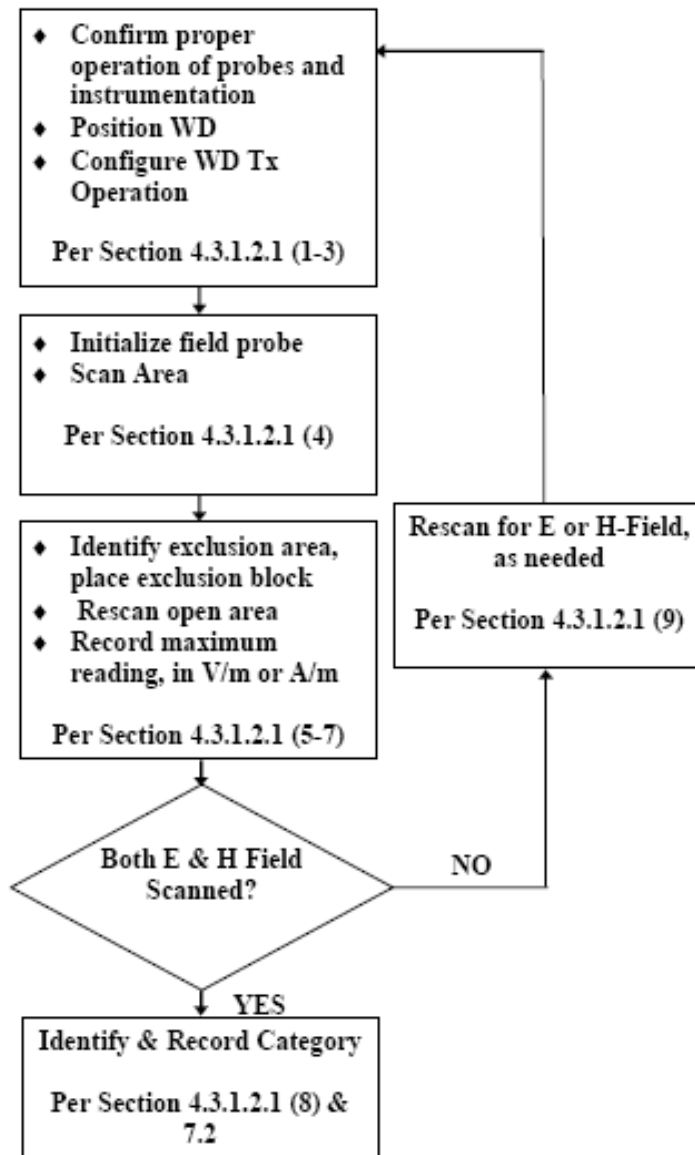

#### 4.3.4.2. TEST Setup



WD reference and plane for RF emission measurements

#### 4.3.4.3. RF Emission Test Procedure

The following illustrate a typical RF emissions test scan over a wireless communications device:

1. Proper operation of the field probe, probe measurement system, other instrumentation, and the positioning system was confirmed.
2. WD is positioned in its intended test position, acoustic output point of the device perpendicular to the field probe.
3. The WD operation for maximum rated RF output power was configured and confirmed with the base station simulator, at the test channel and other normal operating parameters as intended for the test. The battery was ensured to be fully charged before each test.
4. The center sub-grid was centered over the center of the acoustic output (also audio band magnetic output, if applicable). The WD audio output was positioned tangent (as physically possible) to the measurement plane.
5. A surface calibration was performed before each setup change to ensure repeatable spacing and proper maintenance of the measurement plane using the HAC Phantom.
6. The measurement system measured the field strength at the reference location.



### 4.3.5. SYSTEM CHECK

#### 4.3.5.1. System Check Parameters

The input signal was an unmodulated continuous wave. The following points were taken into consideration in performing this check:

- Average Input Power  $P = 100\text{mW RMS}$  ( $20\text{dBm RMS}$ ) after adjustment for return loss
- The test fixture must meet the 2 wavelength separation criterion
- The proper measurement of the 1 cm probe to dipole separation, which is measured from top surface of the dipole to the calibration reference point of the sensor, defined by the probe manufacturer is shown in the following diagram:

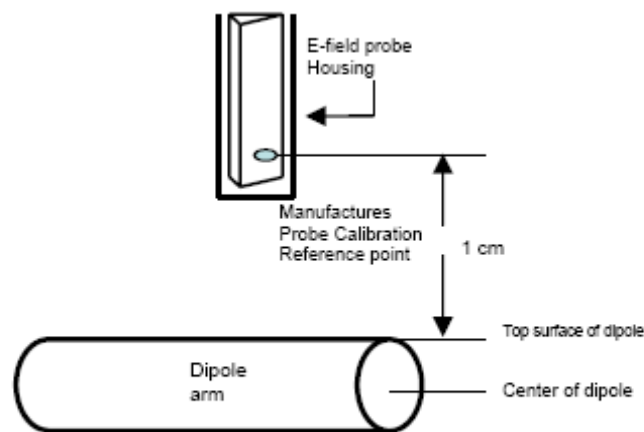

**Figure 15**  
Separation Distance from Dipole to Field Probe

RF power was recorded using both an average reading meter and a peak reading meter. Readings of the probe are provided by the measurement system.

To assure proper operation of the near-field measurement probe the input power to the dipole shall be commensurate with the full rated output power of the wireless device (e.g. - for a cellular phone wireless device the average peak antenna input power will be on the order of  $100\text{mW}$  (i.e. -  $20\text{dBm}$ ) RMS after adjustment for any mismatch.

#### 4.3.5.2 Validation Procedure

A dipole antenna meeting the requirements given in PC63.19 was placed in the position normally occupied by the WD.

The length of the dipole was scanned with both E-field and H-field probes and the maximum values for each were recorded

Using the near-field measurement system, scan the antenna over the radiating dipole and record the greatest field reading observed. Due to the nature of E-fields about free-space dipoles, the two E-field peaks measured over the dipole are averaged to compensate for non-parallelity of the setup see manufacturer

method on dipole calibration certificates, Field strength measurements shall be made only when the probe is stationary.

RF power was recorded using both an average and a peak power reading meter.

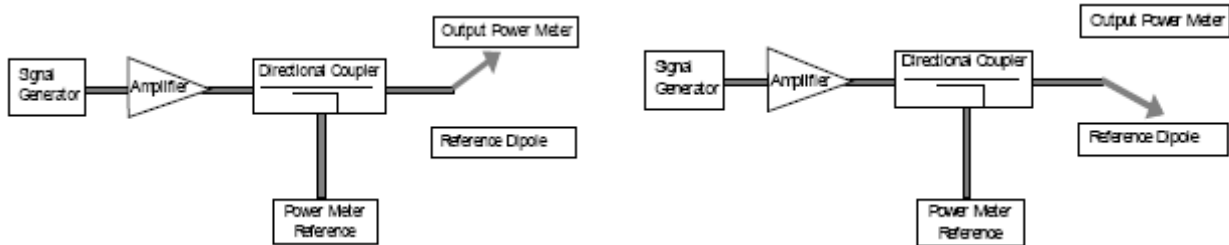

Setup for Desired Output Power to Dipole

Setup to Dipole

Using this setup configuration, the signal generator was adjusted for the desired output power (100mW) at a specified frequency. The reference power from the coupled port of the directional coupler is recorded. Next, the output cable is connected to the reference dipole,

### 4.3.5.3. Test System Validation

Validation Results (1W forward input power), System checks the specific test data please see page 48-55

Frequency	Input Power (dBm)	E-field Result (V/m)	Target Field (V/m)
900 MHz	20.0	205	207
1880MHz	20.0	145.3	141.2
Frequency	Input Power (dBm)	H-field Result (A/m)	Target Field (A/m)
900 MHz	20.0	0.448	0.442
1880MHz	20.0	0.433	0.429

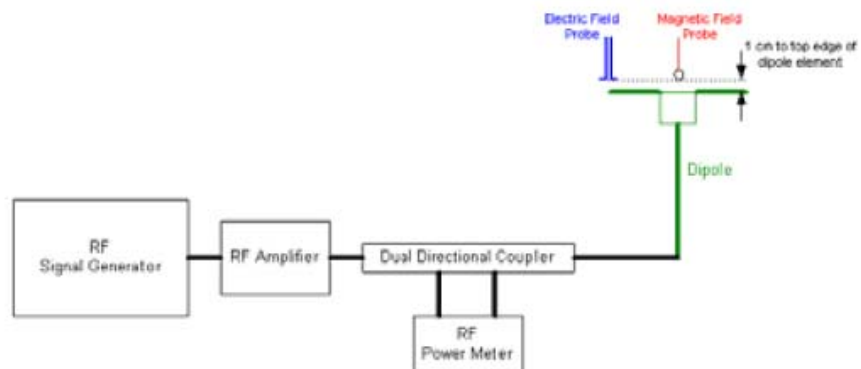

System Check Setup

### 4.3.6. Uncertainty Estimation Table

a	b	c	d	e= f(d,k)	f	g	h= c*f/e	i= c*g/e	k
Uncertainty Component	Sec.	Tol (+- %)	Prob. Dist.	Div.	Ci (1g)	Ci (10g)	1g Ui (+-%)	10g Ui (+-%)	V i
<b>Measurement System</b>									
Probe calibration	E.2.1	7.0	N	1	1	1	7.00	7.00	
Axial Isotropy	E.2.2	2.5	R				1.02	1.02	
Hemispherical Isotropy	E.2.2	4.0	R				1.63	1.63	
Boundary effect	E.2.3	1.0	R		1	1	0.58	0.58	
Linearity	E.2.4	5.0	R		1	1	2.89	2.89	
System detection limits	E.2.5	1.0	R		1	1	0.58	0.58	
Readout Electronics	E.2.6	0.02	N	1	1	1	0.02	0.02	
Reponse Time	E.2.7	3.0	R		1	1	1.73	1.73	
Integration Time	E.2.8	2.0	R		1	1	1.15	1.15	
RF ambient Conditions	E.6.1	3.0	R		1	1	1.73	1.73	
Probe positioner Mechanical Tolerance	E.6.2	2.0	R		1	1	1.15	1.15	
Probe positioning with respect to Phantom Shell	E.6.3	0.05	R		1	1	0.03	0.03	
Extrapolation, interpolation and integration Algorithms for Max. SAR Evaluation	E.5.2	5.0	R		1	1	2.89	2.89	
<b>Test sample Related</b>									
Test sample positioning	E.4.2.1	0.03	N	1	1	1	0.03	0.03	N - 1
Device Holder Uncertainty	E.4.1.1	5.00	N	1	1	1	5.00	5.00	
Output power Variation - SAR drift measurement	6.6.2	5.78	R		1	1	3.34	3.34	

### 4.3.7. OVERALL MEASUREMENT SUMMARY

#### 4.3.7.1 E-FIELD EMISSIONS

Band	Mode	Channel	Peak E Field (V/m)	M Rating	Output power (dBm)
E-FIELD EMISSIONS					
CDMA800	CDMA	1013	128.95	M4	24.26
CDMA800	CDMA	384	111.94	M4	23.23
CDMA800	CDMA	777	108.28	M4	24.18
CDMA1900	CDMA	25	48.05	M3	24.54
CDMA1900	CDMA	600	34.56	M3	24.30
CDMA1900	CDMA	1172	34.13	M3	23.02

#### 4.3.7.2 H-FIELD EMISSIONS

Band	Mode	Channel	Peak E Field (A/m)	M Rating	Output power (dBm)
H-FIELD EMISSIONS					
CDMA800	CDMA	1013	0.29	M4	24.26
CDMA800	CDMA	384	0.28	M4	23.23
CDMA800	CDMA	777	0.29	M4	24.18
CDMA1900	CDMA	25	0.20	M4	24.54
CDMA1900	CDMA	600	0.15	M4	24.30
CDMA1900	CDMA	1172	0.11	M4	23.02

#### 4.3.8. TEST DATA

<u>FREQUENCY</u>	<u>PARAMETERS</u>
<b><u>CDMA800</u></b>	<p><u>Measurement 1:</u> Efield on Low Channel</p> <p><u>Measurement 2:</u> Hfield on Low Channel</p> <p><u>Measurement 3:</u> Efield on Middle Channel</p> <p><u>Measurement 4:</u> Hfield on Middle Channel</p> <p><u>Measurement 5:</u> Efield on High Channel</p> <p><u>Measurement 6:</u> Hfield on High Channel</p>
<b><u>CDMA1900</u></b>	<p><u>Measurement 7:</u> Efield on Low Channel</p> <p><u>Measurement 8:</u> Hfield on Low Channel</p> <p><u>Measurement 9:</u> Efield on Middle Channel</p> <p><u>Measurement 10:</u> Hfield on Middle Channel</p> <p><u>Measurement 11:</u> Efield on High Channel</p> <p><u>Measurement 12:</u> Hfield on High Channel</p>

# MEASUREMENT 1

## A. Experimental conditions.

<b>Grid size (mm x mm)</b>	50.0, 50.0
<b>Step (mm)</b>	5
<b>Band</b>	CDMA850
<b>Channel</b>	Low
<b>Signal</b>	CDMA
<b>Date of measurement</b>	10/8/2010

## B. HAC Measurement Results

Lower Band (Channel 1013):

Frequency (MHz): 824.700012

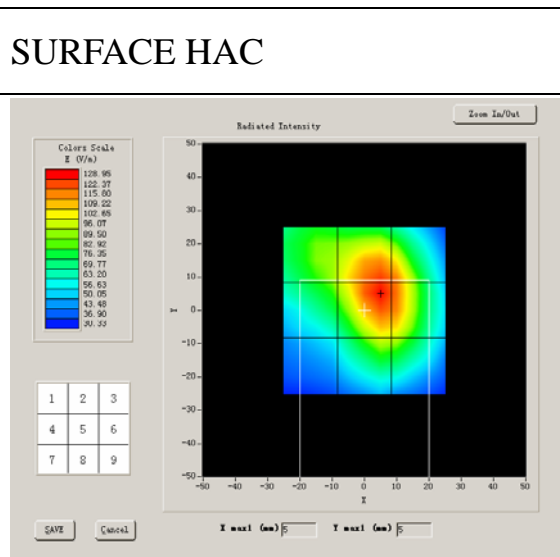



Probe Modulation Factor = 2.820000

Maximum value of total field = 128.95 V/m

**Hearing Aid Near-Field Category: M4 (AWF 0 dB)**

Grid 1: 95.56	Grid 2: 123.28	Grid 3: 115.84
Grid 4: 94.44	Grid 5: 128.95	Grid 6: 117.89
Grid 7: 61.72	Grid 8: 100.06	Grid 9: 95.92

# MEASUREMENT 2

## A. Experimental conditions.

<b>Grid size (mm x mm)</b>	50.0, 50.0
<b>Step (mm)</b>	5
<b>Band</b>	CDMA850
<b>Channel</b>	Low
<b>Signal</b>	CDMA
<b>Date of measurement</b>	10/8/2010

## B. HAC Measurement Results

Lower Band (Channel 1013):

Frequency (MHz): 824.700012

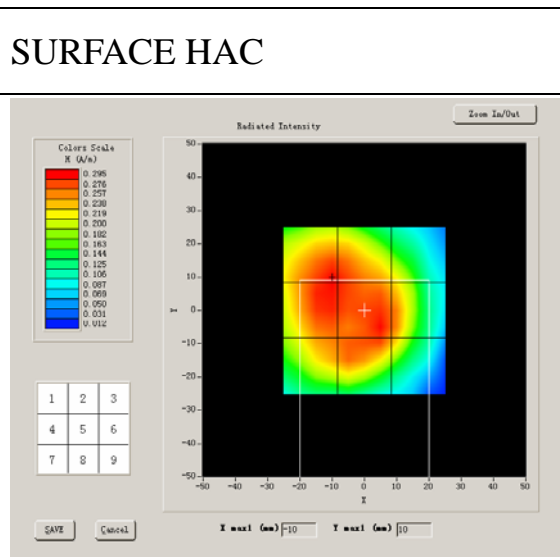





Probe Modulation Factor = 2.800000

Maximum value of total field = 0.29 A/m

**Hearing Aid Near-Field Category: M4 (AWF 0 dB)**

Grid 1: 0.29	Grid 2: 0.29	Grid 3: 0.22
Grid 4: 0.29	Grid 5: 0.29	Grid 6: 0.26
Grid 7: 0.26	Grid 8: 0.29	Grid 9: 0.24

# MEASUREMENT 3

## A. Experimental conditions.

<b>Grid size (mm x mm)</b>	50.0, 50.0
<b>Step (mm)</b>	5
<b>Band</b>	CDMA850
<b>Channel</b>	Middle
<b>Signal</b>	CDMA
<b>Date of measurement</b>	10/8/2010

## B. HAC Measurement Results

Middle Band (Channel 384):

Frequency (MHz): 836.520020

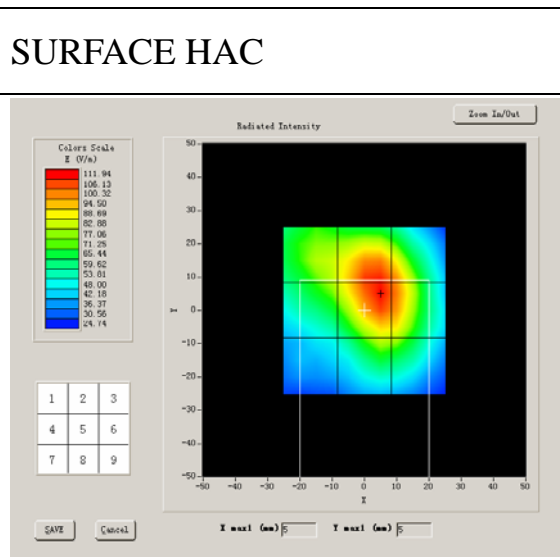

Probe Modulation Factor = 2.820000

Maximum value of total field = 111.94 V/m

**Hearing Aid Near-Field Category: M4 (AWF 0 dB)**

Grid 1: 85.80	Grid 2: 110.26	Grid 3: 98.59
Grid 4: 84.37	Grid 5: 111.94	Grid 6: 101.20
Grid 7: 53.22	Grid 8: 85.00	Grid 9: 81.75

# MEASUREMENT 4

## A. Experimental conditions.

<b>Grid size (mm x mm)</b>	50.0, 50.0
<b>Step (mm)</b>	5
<b>Band</b>	CDMA850
<b>Channel</b>	Middle
<b>Signal</b>	CDMA
<b>Date of measurement</b>	10/8/2010

## B. HAC Measurement Results

Middle Band (Channel 384):

Frequency (MHz): 836.520020

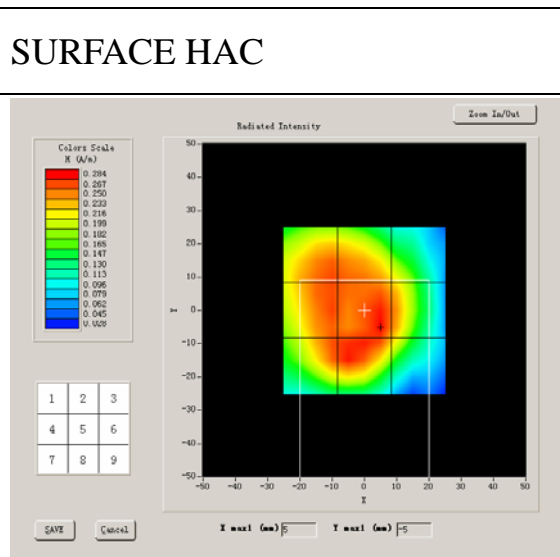



Probe Modulation Factor = 2.800000

Maximum value of total field = 0.28 A/m

**Hearing Aid Near-Field Category: M4 (AWF 0dB)**

Grid 1: 0.27	Grid 2: 0.26	Grid 3: 0.21
Grid 4: 0.27	Grid 5: 0.28	Grid 6: 0.25
Grid 7: 0.28	Grid 8: 0.28	Grid 9: 0.22

# MEASUREMENT 5

## A. Experimental conditions.

<b>Grid size (mm x mm)</b>	50.0, 50.0
<b>Step (mm)</b>	5
<b>Band</b>	CDMA850
<b>Channel</b>	High
<b>Signal</b>	CDMA
<b>Date of measurement</b>	10/8/2010

## B. HAC Measurement Results

Higher Band (Channel 777):

Frequency (MHz): 848.309998

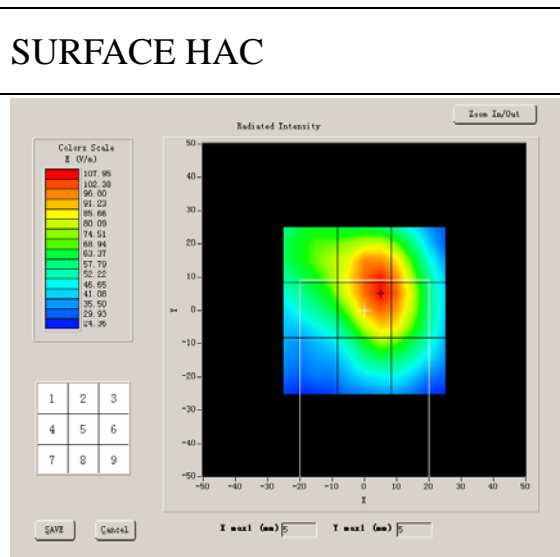

Probe Modulation Factor = 2.820000

Maximum value of total field = 108.28 V/m

**Hearing Aid Near-Field Category: M4 (AWF 0 dB)**

Grid 1: 80.29	Grid 2: 106.04	Grid 3: 96.56
Grid 4: 79.17	Grid 5: 108.28	Grid 6: 99.51
Grid 7: 48.36	Grid 8: 81.39	Grid 9: 77.14

# MEASUREMENT 6

## A. Experimental conditions.

<b>Grid size (mm x mm)</b>	50.0, 50.0
<b>Step (mm)</b>	5
<b>Band</b>	CDMA850
<b>Channel</b>	High
<b>Signal</b>	CDMA
<b>Date of measurement</b>	10/8/2010

## B. HAC Measurement Results

Higher Band (Channel 777):

Frequency (MHz): 848.309998

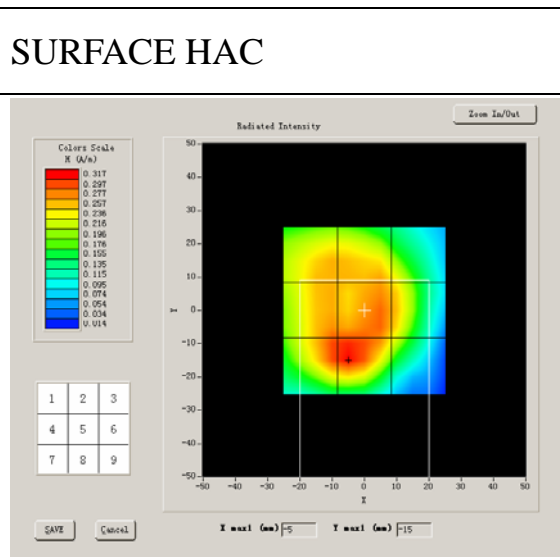





Probe Modulation Factor = 2.800000

Maximum value of total field = 0.29 A/m

**Hearing Aid Near-Field Category: M4 (AWF 0 dB)**

Grid 1: 0.26	Grid 2: 0.27	Grid 3: 0.23
Grid 4: 0.28	Grid 5: 0.29	Grid 6: 0.26
Grid 7: 0.32	Grid 8: 0.32	Grid 9: 0.23

# MEASUREMENT 7

## A. Experimental conditions.

<b>Grid size (mm x mm)</b>	50.0, 50.0
<b>Step (mm)</b>	5
<b>Band</b>	US_PCS
<b>Channel</b>	Low
<b>Signal</b>	CDMA
<b>Date of measurement</b>	10/8/2010

## B. HAC Measurement Results

Lower Band (Channel 25):

Frequency (MHz): 1851.250000

### SURFACE HAC

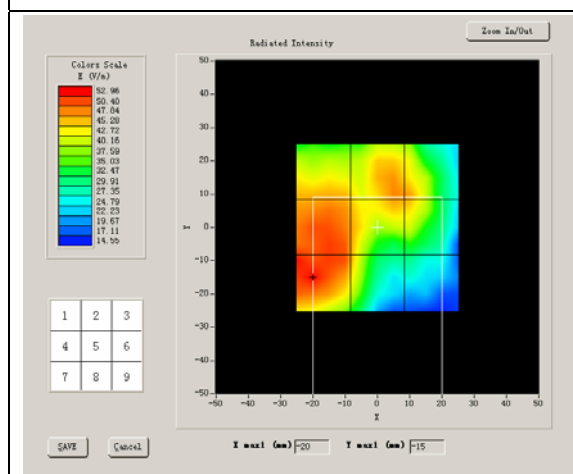



Probe Modulation Factor = 2.820000

Maximum value of total field = 48.05 V/m

**Hearing Aid Near-Field Category: M3 (AWF 0 dB)**

Grid 1: 46.16	Grid 2: 48.05	Grid 3: 46.71
Grid 4: 51.45	Grid 5: 47.68	Grid 6: 46.48
Grid 7: 52.96	Grid 8: 44.30	Grid 9: 30.83

# MEASUREMENT 8

## A. Experimental conditions.

<b>Grid size (mm x mm)</b>	50.0, 50.0
<b>Step (mm)</b>	5
<b>Band</b>	US_PCS
<b>Channel</b>	Low
<b>Signal</b>	CDMA
<b>Date of measurement</b>	10/8/2010

## B. HAC Measurement Results

Lower Band (Channel 25):

Frequency (MHz): 1851.250000

### SURFACE HAC

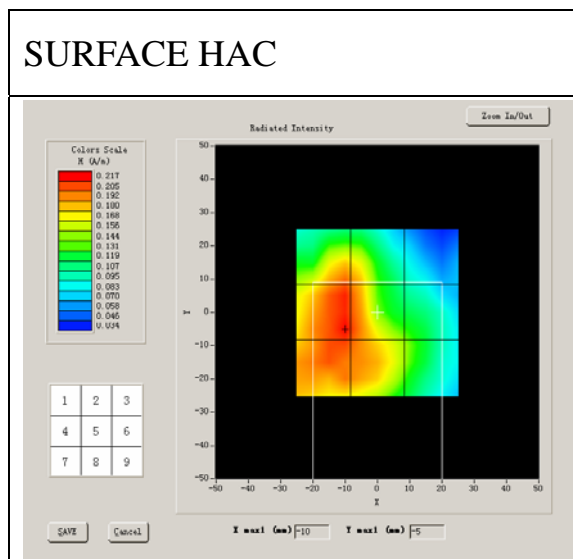



Probe Modulation Factor = 2.800000

Maximum value of total field = 0.20 A/m

**Hearing Aid Near-Field Category: M3 (AWF 0 dB)**

Grid 1: 0.20	Grid 2: 0.19	Grid 3: 0.09
Grid 4: 0.22	Grid 5: 0.20	Grid 6: 0.13
Grid 7: 0.21	Grid 8: 0.20	Grid 9: 0.14

# MEASUREMENT 9

## A. Experimental conditions.

<b>Grid size (mm x mm)</b>	50.0, 50.0
<b>Step (mm)</b>	5
<b>Band</b>	US_PCS
<b>Channel</b>	Middle
<b>Signal</b>	CDMA
<b>Date of measurement</b>	10/8/2010

## B. HAC Measurement Results

Middle Band (Channel 600):

Frequency (MHz): 1880.000000

### SURFACE HAC

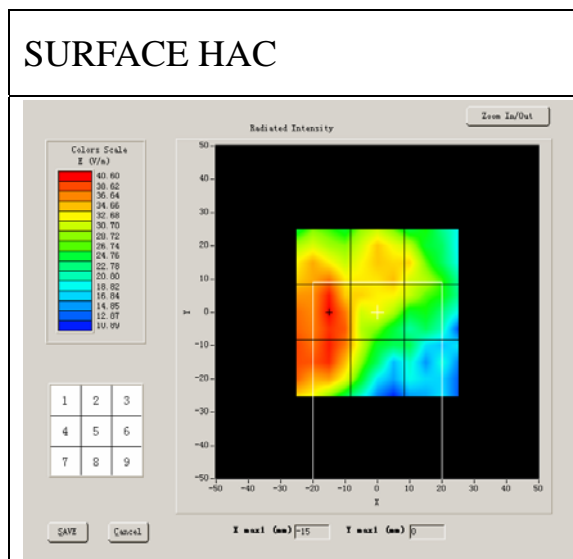



Probe Modulation Factor = 2.820000

Maximum value of total field = 34.56 V/m

**Hearing Aid Near-Field Category: M4 (AWF 0 dB)**

Grid 1: 37.21	Grid 2: 34.56	Grid 3: 33.79
Grid 4: 40.60	Grid 5: 34.30	Grid 6: 31.18
Grid 7: 39.94	Grid 8: 33.32	Grid 9: 24.27

# MEASUREMENT 10

## A. Experimental conditions.

<b>Grid size (mm x mm)</b>	50.0, 50.0
<b>Step (mm)</b>	5
<b>Band</b>	US_PCS
<b>Channel</b>	Middle
<b>Signal</b>	CDMA
<b>Date of measurement</b>	10/8/2010

## B. HAC Measurement Results

Middle Band (Channel 600):

Frequency (MHz): 1880.000000

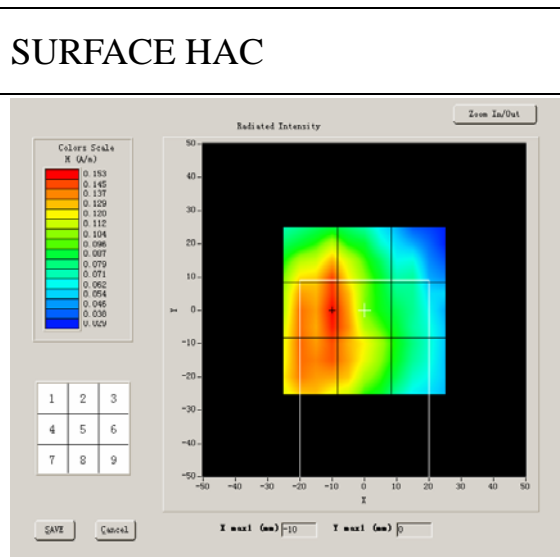





Probe Modulation Factor = 2.800000

Maximum value of total field = 0.15 A/m

**Hearing Aid Near-Field Category: M4 (AWF 0 dB)**

Grid 1: 0.15	Grid 2: 0.13	Grid 3: 0.07
Grid 4: 0.15	Grid 5: 0.15	Grid 6: 0.09
Grid 7: 0.15	Grid 8: 0.14	Grid 9: 0.09

# MEASUREMENT 11

## A. Experimental conditions.

<b>Grid size (mm x mm)</b>	50.0, 50.0
<b>Step (mm)</b>	5
<b>Band</b>	US_PCS
<b>Channel</b>	High
<b>Signal</b>	CDMA
<b>Date of measurement</b>	10/8/2010

## B. HAC Measurement Results

Higher Band (Channel 1175):

Frequency (MHz): 1908.750000

### SURFACE HAC

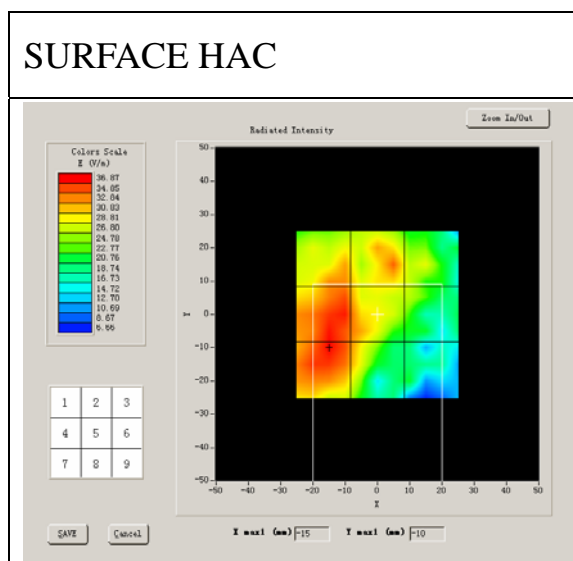

Probe Modulation Factor = 2.820000

Maximum value of total field = 34.13 V/m

**Hearing Aid Near-Field Category: M4 (AWF 0 dB)**

Grid 1: 33.39	Grid 2: 34.13	Grid 3: 27.97
Grid 4: 36.65	Grid 5: 32.80	Grid 6: 26.54
Grid 7: 36.87	Grid 8: 31.60	Grid 9: 21.72

# MEASUREMENT 12

## A. Experimental conditions.

<b>Grid size (mm x mm)</b>	50.0, 50.0
<b>Step (mm)</b>	5
<b>Band</b>	US_PCS
<b>Channel</b>	High
<b>Signal</b>	CDMA
<b>Date of measurement</b>	10/8/2010

## B. HAC Measurement Results

Higher Band (Channel 1175):

Frequency (MHz): 1908.750000

### SURFACE HAC

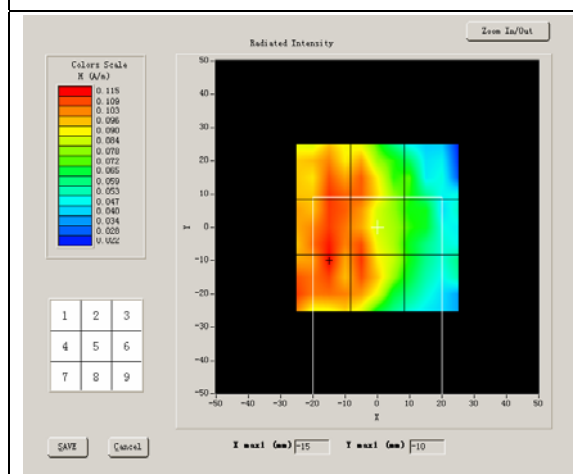

Probe Modulation Factor = 2.800000

Maximum value of total field = 0.11 A/m

**Hearing Aid Near-Field Category: M4 (AWF 0 dB)**

Grid 1: 0.11	Grid 2: 0.11	Grid 3: 0.07
Grid 4: 0.11	Grid 5: 0.11	Grid 6: 0.07
Grid 7: 0.12	Grid 8: 0.11	Grid 9: 0.07

**Annex A Accreditation Certificate**

**China National Accreditation Service for Conformity Assessment**

**LABORATORY ACCREDITATION CERTIFICATE**

(No. CNAS L1659 )

*China National Accreditation Service for Conformity Assessment has accredited*

**Shenzhen Electronic Product Quality Testing Center**  
Electronic Testing Building, Shahe Road, Xili, Nanshan District,  
Shenzhen, Guangdong, China

*to ISO/IEC 17025:2005 General Requirements for the Competence of Testing and Calibration Laboratories(CNAS-CL01 Accreditation Criteria for the Competence of Testing and Calibration Laboratories) for the competence in the field of testing and calibration.*

*The scope of accreditation is detailed in the attached schedule bearing the same accreditation number as above. The schedule forms an integral part of this certificate.*

Date of Issue: 2009-09-29  
Date of Expiry: 2012-09-28  
Date of Initial Accreditation: 1999-08-03



Signed on behalf of China National Accreditation Service  
for Conformity Assessment

China National Accreditation Service for Conformity Assessment(CNAS) is authorized by Certification and Accreditation Administration of the People's Republic of China (CNCA) to operate the national accreditation systems for conformity assessment. CNAS is the signatory to International Laboratory Accreditation Cooperation Multilateral Recognition Arrangement (ILAC MRA), and the signatory to Asia Pacific Laboratory Accreditation Cooperation Multilateral Recognition Arrangement (APLAC MRA).

## Annex B Photographs of the EUT

### E-FIELD EMISSIONS



### H-FIELD EMISSIONS

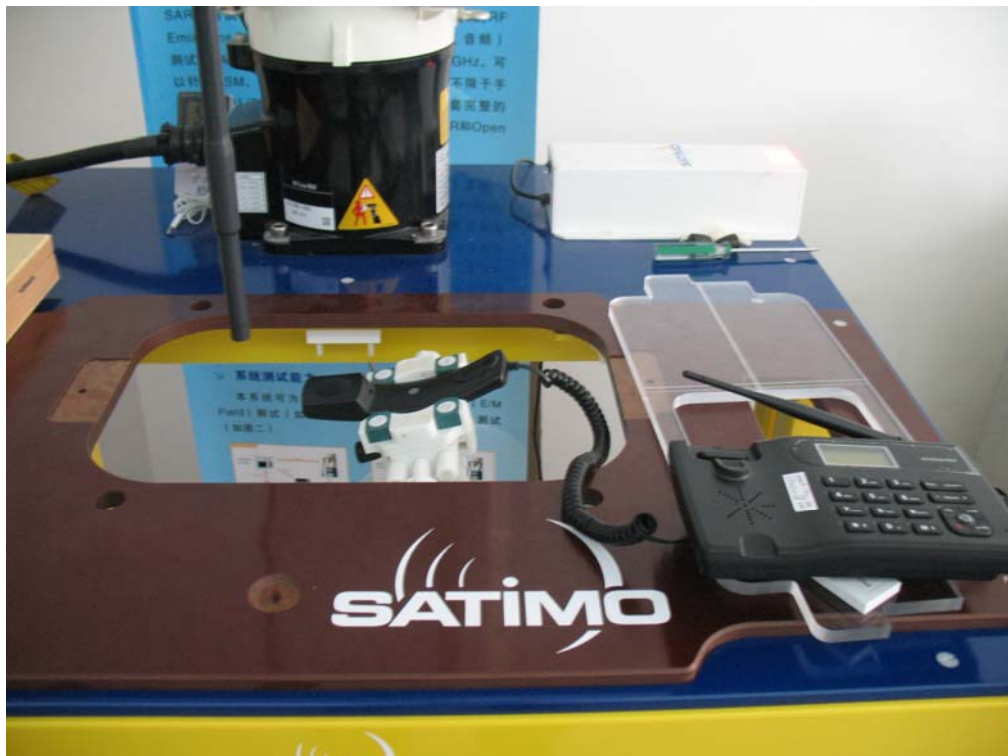

## System Performance Check (E-field)

### A. Experimental conditions.

<b>Grid size (mm x mm)</b>	50.0, 50.0
<b>Step (mm)</b>	5
<b>Band</b>	850 MHz
<b>Channel</b>	
<b>Signal</b>	CW
<b>Date of measurement</b>	10/8/2010

### B. HAC Measurement Results

Frequency (MHz): 850.000000

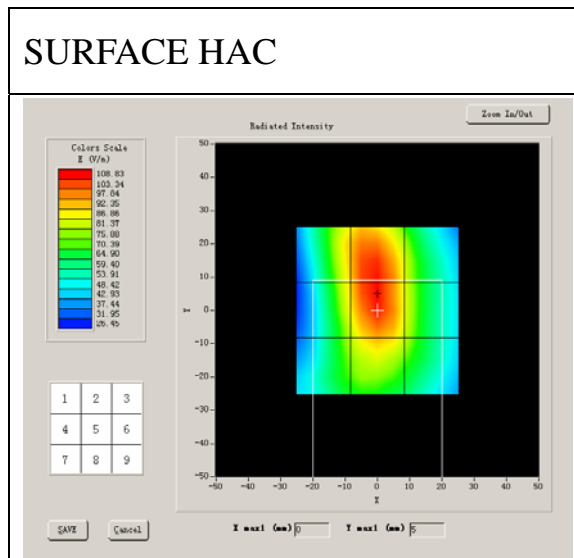



Probe Modulation Factor = 2.820000

Maximum value of total field = 205 V/m

E in V/m

Grid 1: 194.51	Grid 2: 198.12	Grid 3: 177.56
Grid 4: 192.69	Grid 5: 205.00	Grid 6: 178.98
Grid 7: 181.13	Grid 8: 194.18	Grid 9: 176.51

## System Performance Check (H-field)

### A. Experimental conditions.

<b>Grid size (mm x mm)</b>	50.0, 50.0
<b>Step (mm)</b>	5
<b>Band</b>	850 MHz
<b>Channel</b>	
<b>Signal</b>	CW
<b>Date of measurement</b>	10/8/2010

### B. HAC Measurement Results

Frequency (MHz): 850.000000

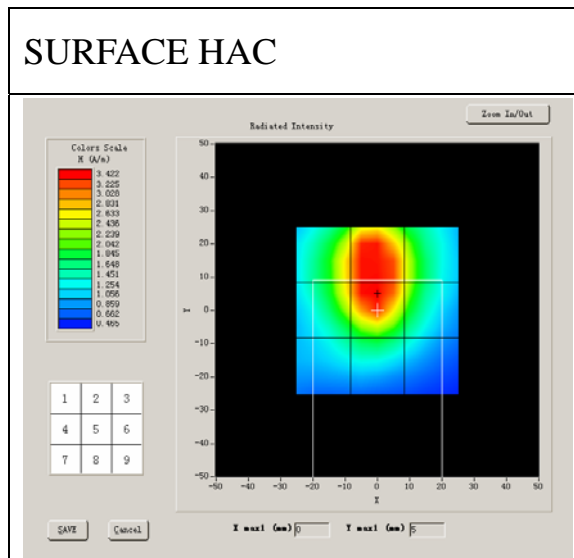



Probe Modulation Factor = 2.800000

Maximum value of total field = 0.448 A/m

H in A/m

Grid 1: 0.302	Grid 2: 0.421	Grid 3: 0.336
Grid 4: 0.381	Grid 5: 0.449	Grid 6: 0.332
Grid 7: 0.370	Grid 8: 0.400	Grid 9: 0.239

## System Performance Check (E-field)

### A. Experimental conditions.

<b>Grid size (mm x mm)</b>	50.0, 50.0
<b>Step (mm)</b>	5
<b>Band</b>	1900 MHz
<b>Channel</b>	
<b>Signal</b>	CW
<b>Date of measurement</b>	10/8/2010

### B. HAC Measurement Results

Frequency (MHz): 1900.000000

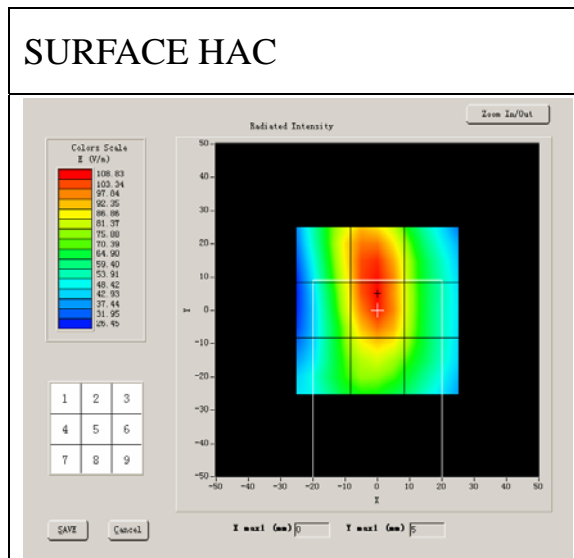



Probe Modulation Factor = 2.820000

Maximum value of total field = 145.3 V/m

E in V/m

Grid 1: 134.51	Grid 2: 138.12	Grid 3: 127.56
Grid 4: 132.69	Grid 5: 145.28	Grid 6: 118.98
Grid 7: 121.13	Grid 8: 124.18	Grid 9: 116.51

## System Performance Check (H-field)

### A. Experimental conditions.

<b>Grid size (mm x mm)</b>	50.0, 50.0
<b>Step (mm)</b>	5
<b>Band</b>	1900 MHz
<b>Channel</b>	
<b>Signal</b>	CW
<b>Date of measurement</b>	10/8/2010

### B. HAC Measurement Results

Frequency (MHz): 1900.000000

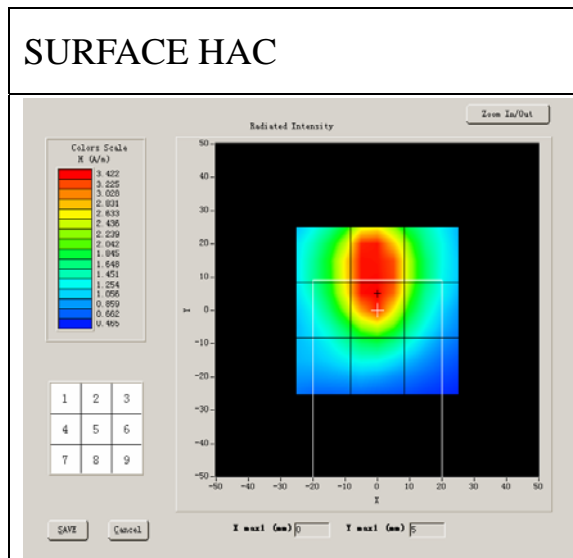



Probe Modulation Factor = 2.800000

Maximum value of total field = 0.433 A/m

H in A/m

Grid 1: 0.402	Grid 2: 0.428	Grid 3: 0.346
Grid 4: 0.419	Grid 5: 0.433	Grid 6: 0.344
Grid 7: 0.409	Grid 8: 0.400	Grid 9: 0.320