



HCT CO., LTD.

Product Compliance Division

TEL : +82 31 639 8518 FAX : +82 31 639 8525

CERTIFICATE OF COMPLIANCE FCC Part 24 & 22 Certification

Applicant Name: AXESSTEL INC.

Date of Testing:

July 15, 2008

Address:

6815 Flanders Drive Ste.210 San Diego,
CA 92121, U.S.A

Test Site/Location:

HCT.CO., LTD., San 136-1 Ami-ri, Bubal-eup, Icheon-si,
Kyungki-do, Korea

Test Report No.: HCT-R08-094

HCT FRN: 0005866421

FCC ID : PH7MV430A

APPLICANT : AXESSTEL INC.

Application Type: Certification

FCC Classification: Non-Broadcast Base Station Transmitter

FCC Rule Part(s): §24, §2

EUT Type: PCS Wireless Gateway with WLAN

Model(s): MV430A

Tx Frequency: 1 851.25 — 1 908.75 MHz (PCS CDMA)

Rx Frequency: 1 931.25 — 1 988.75 MHz (PCS CDMA)

Max. RF Output Power: 0.290 W ERP PCS CDMA (24.63 dBm)
0.293 W ERP PCS CDMA EVDO (24.67 dBm)

Emission Designator(s): 1M28F9W (PCS CDMA), 1M28F9W (PCS CDMA EVDO)

The measurements shown in this report were made in accordance with the procedures specified in §2.947. I assume full responsibility for the accuracy and completeness of these measurements, and for the qualifications of all persons taking them.

HCT.CO., LTD. Certifies that no party to this application has been denied FCC benefits pursuant to section 5301 of the Anti-Drug Abuse Act of 1998, 21 U.S.C. 853(a)

Report prepared by

: Youn Seok Jung

Test engineer of RF Part

Approved by

: Sang Jun Lee

Manager of RF Part

This report only responds to the tested sample and may not be reproduced, except in full, without written approval of the HCT Co., Ltd.

FCC Part24 Permissive Change Class II				www.hct.co.kr
Test Report No. HCT-R08-094	Test Dates: July 15, 2008	EUT Type: PCS Wireless Gateway with WLAN	FCC ID: PH7MV430A	Page 1 of 22



Table of Contents

1. GENERAL INFORMATION.....	3
2. INTRODUCTION	4
2.1. EUT DESCRIPTION.....	4
2.2. MEASURING INSTRUMENT CALIBRATION.....	4
2.3. TEST FACILITY	4
3. DESCRIPTION OF TESTS	5
3.1 Effective Radiated Power/Equivalent Isotropic Radiated Power.....	5
3.2 Occupied bandwidth.	6
3.3 Spurious and Harmonic Emissions at Antenna Terminal.....	6
3.4 Radiated Spurious and Harmonic Emissions	7
3.5 Frequency stability / variation of ambient temperature	8
5. SUMMARY OF TEST RESULTS	10
6. SAMPLE CALCULATION	11
7. TEST DATA	12
7.1 Conducted Output Power	12
7.2 Equivalent Isotropic Radiated Power (E.I.R.P.) (PCS CDMA)	13
7.3 Radiated Spurious Emissions(PCS CDMA Mode)	14
7.4 Frequency stability / variation of ambient temperature	15
7.4.1 FREQUENCY STABILITY (PCS CDMA)	15
8. TEST PLOTS.....	16



MEASUREMENT REPORT

1. GENERAL INFORMATION

Applicant Name: AXESSTEL INC.

Address: 6815 Flanders Drive Ste.210 San Diego,
CA 92121, U.S.A

Contact: Tel: 858- 625-2100 Fax: 858- 625- 2110
E-Mail: dskim@axesstel.com

FCC ID: PH7MV430A

Application Type: FCC Part24 Permissive Change Class II

FCC Classification: Non-Broadcast Base Station Transmitter

FCC Rule Part(s): §24, §2

EUT Type: PCS Wireless Gateway with WLAN

Model(s): MV430A

Tx Frequency: 1 851.25 — 1 908.75 MHz (PCS CDMA)

Rx Frequency: 1 931.25 — 1 988.75 MHz (PCS CDMA)

Max. RF Output Power: 0.290 W ERP PCS CDMA (24.63 dBm)
0.293 W ERP PCS CDMA EVDO (24.67 dBm)

Emission Designator(s): 1M28F9W (PCS CDMA), 1M28F9W (PCS CDMA EVDO)

Antenna Specification Manufacturer: Hankook Antenna Co.,LTD
Antenna type: sleeve dipole antenna
Peak Gain: 0 dBi

Date(s) of Tests: July 15. 2008

Place of Tests: HCT.CO., LTD.
San 136-1 Ami-ri, Bubal-eup, Icheon-si,

Report Serial No HCT-R08-094

FCC Part24 Permissive Change Class II				www.hct.co.kr
Test Report No. HCT-R08-094	Test Dates: July 15. 2008	EUT Type: PCS Wireless Gateway with WLAN	FCC ID: PH7MV430A	Page 3 of 22



2. INTRODUCTION

2.1. EUT DESCRIPTION

AXESSTEL INC. PCS Wireless Gateway with WLAN consists of PCS CDMA and Wireless LAN(802.11b/g)

2.2. MEASURING INSTRUMENT CALIBRATION

The measuring equipment, which was utilized in performing the tests documented herein, has been calibrated in accordance with the manufacturer's recommendations for utilizing calibration equipment, which is traceable to recognized national standards.

2.3. TEST FACILITY

The open area test site and conducted measurement facility used to collect the radiated data are located at the 254-1, Maekok-Ri, Hobup-Myun, Ichon-Si, Kyoungki-Do, 467-701, KOREA. The site is constructed in conformance with the requirements of ANSI C63.4 and CISPR Publication 22. Detailed description of test facility was submitted to the Commission and accepted dated July 6, 2006(Registration Number: 90661)

FCC Part24 Permissive Change Class II				www.hct.co.kr
Test Report No. HCT-R08-094	Test Dates: July 15. 2008	EUT Type: PCS Wireless Gateway with WLAN	FCC ID: PH7MV430A	Page 4 of 22

3. DESCRIPTION OF TESTS

3.1 Effective Radiated Power/Equivalent Isotropic Radiated Power

Test Set-up

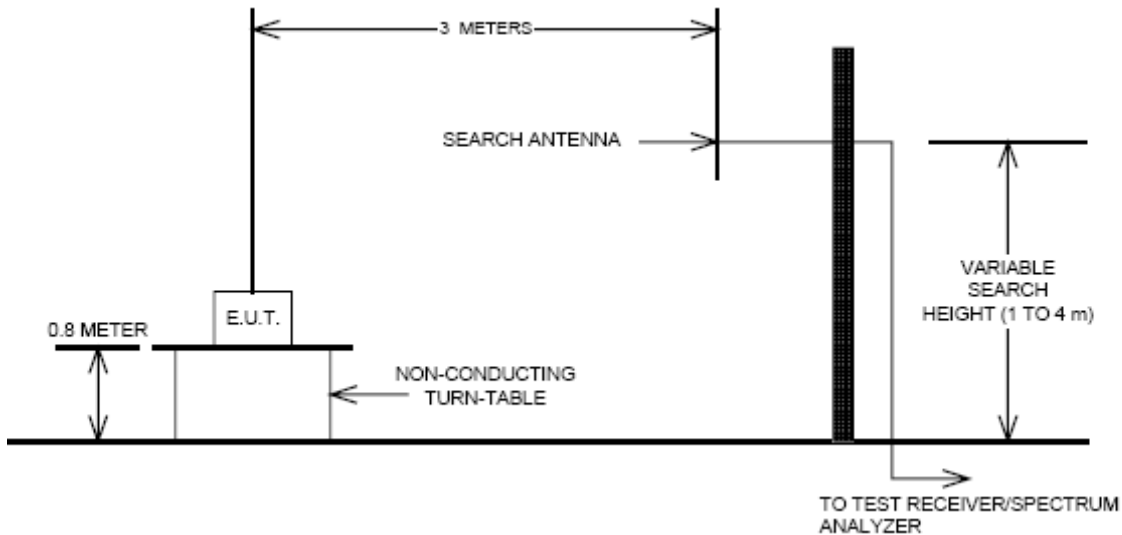

Test Procedure

Radiated emission measurements were performed at an open Site.

The equipment under test is placed on a wooden turntable 3-meters from the receive antenna.

A wooden turntable was rotated 360° and the receiving antenna scanned from 1-4m in order to capture the maximum emission. A half wave dipole was substituted in place of the EUT. This dipole antenna was driven by a signal generator and the previously recorded signal was duplicated.

The maximum EIRP was calculated by adding the forward power to the calibrated source plus its appropriate gain value. These steps were carried out with the receiving antenna in both vertical and horizontal polarization. For readings above 1GHz, the above procedure is repeated using horn antennas and the difference between the gain of the horn and an isotropic antenna are taken into consideration.

3.2 Occupied bandwidth.

Test set-up

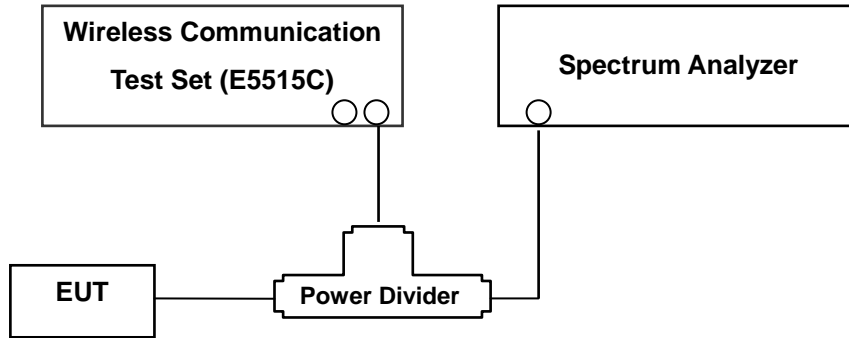

(Configuration of conducted Emission measurement)
Test Procedure

The EUT was setup to maximum output power at its lowest channel. The occupied bandwidth was measured using a spectrum analyzer. The measurements are repeated for the highest and a middle channel. The EUT's occupied bandwidth is measured as the width of the signal between two points, one below the carrier center frequency and one above the carrier frequency, outside of which all emissions are attenuated at least 26 dB below the transmitter power. Plots of the EUT's occupied bandwidth are shown herein.

3.3 Spurious and Harmonic Emissions at Antenna Terminal.

Test Procedure

The level of the carrier and the various conducted spurious and harmonic frequencies is measured by means of a calibrated spectrum analyzer.

The EUT was setup to maximum output power at its lowest channel. The Resolution BW of the analyzer is set to 1 % of the emission bandwidth to show compliance with the – 13 dBm limit, in the 1 MHz bands immediately outside and adjacent to the edge of the frequency block. The 1 MHz RBW was used to scan from 30 MHz to 10 GHz. A display line was placed at – 13 dBm to show compliance. The high, lowest and a middle channel were tested for out of band measurements.

3.4 Radiated Spurious and Harmonic Emissions

Test Set-up

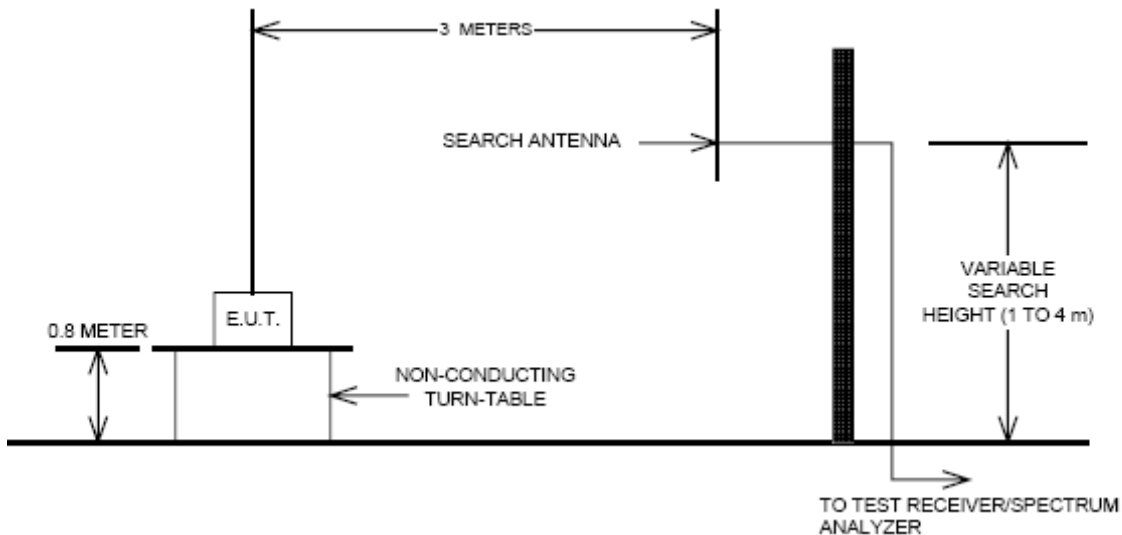

The measurement facilities used for this test have been documented in previous filings with the commission pursuant to section § 2.948. The open field test site is situated in open field with ground screen whose site attenuation characteristics meet ANSI C63.4 –2003. A mast capable of lifting the receiving antenna from a height of one to four meters is used together with a rotatable wooden platform mounted at three from the antenna mast.

- 1) The unit mounted on a wooden table 1.5 m × 1.0 m × 0.80 m is 0.8 meter above test site ground level.
- 2) During the emission test, the turntable is rotated and the EUT is manipulated to find the configuration resulting in maximum emission under normal condition of installation and operation.
- 3) The antenna height and polarization are also varied from 1 to 4 meters until the maximum signal is found.
- 4) The spectrum shall be scanned up to the 10th harmonic of the fundamental frequency.

Test Procedure

The equipment under test is placed on a wooden turntable 3-meters from the receive antenna.

A wooden turntable was rotated 360° and the receiving antenna scanned from 1-4m in order to capture the maximum emission. A half wave dipole was substituted in place of the EUT. This dipole antenna was driven by a signal generator and the previously recorded signal was duplicated.

The maximum EIRP was calculated by adding the forward power to the calibrated source plus its appropriate gain value. These steps were carried out with the receiving antenna in both vertical and horizontal polarization. For readings above 1GHz, the above procedure is repeated using horn antennas and the difference between the gain of the horn and an isotropic antenna are taken into consideration.

3.5 Frequency stability / variation of ambient temperature

Test Set-up

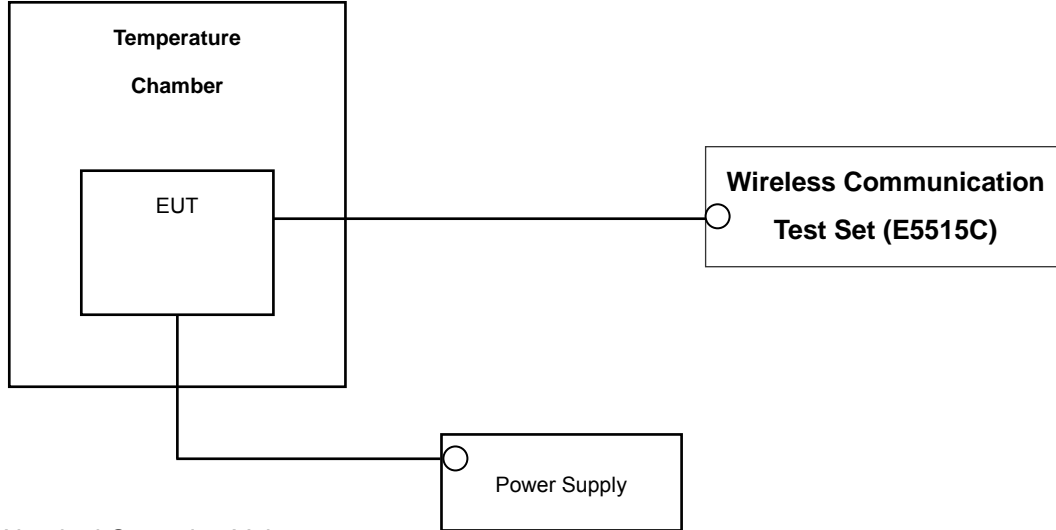

* Nominal Operating Voltage

Test Procedure

The frequency stability of the transmitter is measured by:

a.) **Temperature:** The temperature is varied from - 30 °C to + 50 °C using an environmental chamber.

b.) **Primary Supply Voltage:** The primary supply voltage is varied from battery end point to 115 % of the voltage normally at the input to the device or at the power supply terminals if cables are not normally supplied.

Specification — the frequency stability shall be sufficient to ensure that the fundamental emission stays within the authorized frequency block. The frequency stability of the transmitter shall be maintained within $\pm 0.00025\%$ (± 2.5 ppm) of the center frequency.

Time Period and Procedure:

The carrier frequency of the transmitter is measured at room temperature (20°C to provide a reference).

1. The equipment is turned on in a “standby” condition for one minute before applying power to the transmitter. Measurement of the carrier frequency of the transmitter is made within one minute after applying power to the transmitter.

2. Frequency measurements are made at 10°C intervals ranging from -30°C to +50°C. A period of at least one half-hour is provided to allow stabilization of the equipment at each temperature level.

NOTE: The EUT is tested down to the battery endpoint.



4. LIST OF TEST EQUIPMENT

Manufacture	Model/ Equipment	Serial Number	Calibration Interval	Calibration Due
R&S	ESI40/ Spectrum Analyzer	831564/003	Annual	11/06/2008
Agilent	E4419B/ Power Meter	MY41291386	Annual	11/05/2008
Agilent	8481A/ Power Sensor	MY41090870	Annual	11/05/2008
Agilent	HP8901B/ Modulation Analyzer	3438A05231	Annual	08/04/2008
Agilent	8903A/ Audio Analyzer	2433A04322	Annual	08/04/2008
R&S	CMU200/ Base Station	110740	Annual	07/26/2008
Agilent	8960 (E5515C)/ Base Station	GB444400269	Annual	02/11/2009
Tescom	TC-3000/ Bluetooth Simulator	3000A4900112	Annual	01/11/2009
MITEQ	AMF-6D-01180-35-20P/ AMP	990893	Annual	01/15/2009
Wainwright	WHK1.2/15G-10EF/H.P.F	2	Annual	06/28/2009
Wainwright	WHK3.3/18G-10EF/H.P.F	1	Annual	06/28/2009
Agilent	778D/ Dual Directional Coupler	16072	Annual	11/09/2008
Agilent	1506A/ Power Divider	99441	Annual	11/10/2008
Digital	EP-3010/ Power Supply	3110117	Annual	12/29/2008
Schwarzbeck	UHAP/ Dipole Antenna	630	Annual	11/13/2008
Schwarzbeck	UHAP/ Dipole Antenna	605	Annual	11/13/2008
R&S	HFH2-Z2/ Loop Antenna	881056/070	Annual	12/11/2008
Korea Engineering	KR-1005L / Chamber	KRAB07063-2CH	Annual	01/05/2009
Schwarzbeck	VULB9160/ TRILOG Antenna	3150	Biennial	04/20/2009
Schwarzbeck	VULB9160/ TRILOG Antenna	3125	Biennial	05/16/2009
Schwarzbeck	BBHA 9120D/ Horn Antenna	147	Biennial	03/26/2010
Schwarzbeck	BBHA 9120D/ Horn Antenna	1201	Biennial	05/02/2009
Agilent	E4440A/Spectrum Analyzer	US45303008	Annual	01/08/2009



5. SUMMARY OF TEST RESULTS

FCC Part Section(s)	Test Description	Test Limit	Test Condition	Test Result
2.1049, 24.238(a)	Occupied Bandwidth	N/A	CONDUCTED	PASS
2.1051, 24.238(a)	Band Edge / Spurious and Harmonic Emissions at Antenna Terminal.	$< 43 + \log_{10}(P[\text{Watts}])$ at Band Edge and for all out-of-band emissions		PASS
2.1046	Conducted Output Power	N/A		PASS
2.1055, 24.235	Frequency stability / variation of ambient temperature	$< 2.5 \text{ ppm}$		PASS
24.232(c)	Effective Radiated Power	$< 7 \text{ Watts max. ERP}$	RADIATED	PASS
	Equivalent Isotropic Radiated Power	$< 2 \text{ Watts max. EIRP}$		PASS
2.1053, 24.238(a)	Radiated Spurious and Harmonic Emissions	$< 43 + \log_{10}(P[\text{Watts}])$ for all out-of band emissions		PASS



6. SAMPLE CALCULATION

A. EIRP Sample Calculation

Mode	Ch./ Freq.		Measured Level(dBm)	Substitute LEVEL(dBm)	Ant. Gain	C.L	Pol.	EIRP	
	channel	Freq.(MHz)						W	dBm
PCS	600	1880	-13.03	22.74	2.50	1.19	H	0.25	24.05

EIRP = SubstituteLEVEL(dBm) + Ant. Gain – CL(Cable Loss)

- 1) The EUT mounted on a wooden tripod is 0.8 meter above test site ground level.
- 2) During the test , the turn table is rotated and the antenna height is also varied from 1 to 4 meters until the maximum signal is found.
- 3) Record the field strength meter's level.
- 4) Replace the EUT with dipole/Horn antenna that is connected to a calibrated signal generator.
- 5) Increase the signal generator output till the field strength meter's level is equal to the item (3).
- 6) The signal generator output level with Ant. Gain and cable loss are the rating of effective isotropic radiated power (EIRP).

B. Emission Designator

PCS CDMA Emission Designator

Emission Designator = 1M29F9W

PCS CDMA BW = 1.29 MHz

F = Frequency Modulation

9 = Composite Digital Info

W = Combination (Audio/Data)

(Measured at the 99% power bandwidth)

7. TEST DATA

7.1 Conducted Output Power

A base station simulator was used to establish communication with the EUT. The base station simulator parameters were set to produce the maximum power from the EUT. This device was tested under all configurations and the highest power is reported. Conducted Output Powers of EUT are reported below.

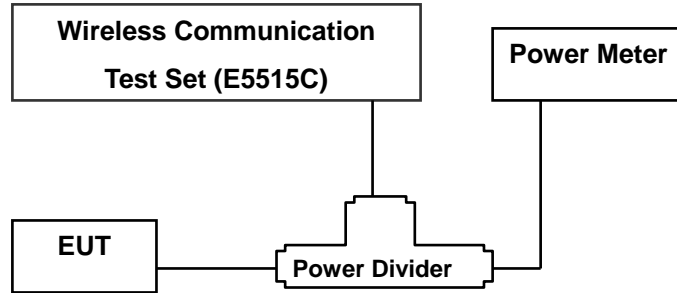

Band	CH.No	SO2	SO2	SO55	SO55	TDSO	1xEVDO	1xEVDO	1xEVDO	1xEVDO
		RC1/1 (dBm)	RC3/3 (dBm)	RC1/1 (dBm)	RC3/3 (dBm)	SO32 (dBm)	Rev.0 (FTAP) (dBm)	Rev.0 (RTAP) (dBm)	Rev.1 (FETAP) (dBm)	Rev.1 (RETAP) (dBm)
PCS	25	23.02	22.97	23.04	22.97	22.97	23.58	23.56	23.50	23.40
	600	23.79	23.75	23.79	23.75	23.70	24.34	24.35	24.40	24.24
	1175	23.43	23.43	23.44	23.42	23.38	24.45	24.37	24.38	24.10

(Maximum Conducted Output Powers)



7.2 Equivalent Isotropic Radiated Power (E.I.R.P.) (PCS CDMA)

(PCS CDMA Mode)

Mode	Ch./ Freq.		Measured Level(dBm)	Substitute LEVEL (dBm)	Ant. Gain	C.L	Pol.	EIRP	
	channel	Freq.(MHz)						W	dBm
PCS	25	1,851.25	-15.39	16.22	10.05	1.91	H	0.27	24.35
	600	1,880.00	-15.29	16.53	10.05	1.95	H	0.29	24.63
	1175	1,908.75	-15.69	16.21	10.06	1.97	H	0.27	24.30
EVDO	600	1,880.00	-15.25	16.57	10.05	1.95	H	0.29	24.67

Note: Standard batteries are the only options for this phone

NOTES:

Effective Radiated Power Output Measurements by Substitution Method

according to ANSI/TIA/EIA-603-C-2004, Aug. 17, 2004:

The EUT was placed on a wooden turn table 3-meters from the receive antenna. The receive antenna height and turntable rotation was adjusted for the highest reading on the receive spectrum analyzer. For CDMA signals, a peak detector is used, with RBW = VBW = 3 MHz. For WCDMA signals, a peak detector is used, with RBW = VBW = 5MHz. For AMPS, GSM, and NADC TDMA signals, a peak detector is used, with RBW = VBW = 1 MHz. A half-wave dipole was substituted in place of the EUT. This dipole antenna was driven by a signal generator and the level of the signal generator was adjusted to obtain the same receive spectrum analyzer reading. The conducted power at the terminals of the dipole is measured. The ERP is recorded.

This device was tested under all configurations and the highest power is reported.



7.3 Radiated Spurious Emissions(PCS CDMA Mode)

- MEASURED OUTPUT POWER: 24.63 dBm = 0.290 W
- MODULATION SIGNAL: PCS CDMA
- DISTANCE: 3 meters
- LIMIT: - (43 + 10 log₁₀ (W)) = -37.63 dBc

Ch.	Freq.(MHz)	Measured Level [dBm]	Ant. Gain	Substitute Level [dBm]	C.L	Pol.	ERP (dBm)	dBc
25	3,702.50	-49.03	10.31	-55.30	2.73	H	-47.72	-72.35
	5,553.75	-46.26	10.55	-47.84	3.60	H	-40.89	-65.52
	7,405.00	-54.05	9.21	-45.17	3.88	H	-39.84	-64.47
600	3,760.00	-48.54	10.32	-54.51	2.73	H	-46.92	-71.55
	5,640.00	-44.87	10.60	-46.52	3.60	H	-39.52	-64.15
	7,520.00	-52.88	9.18	-43.78	3.88	H	-38.48	-63.11
1175	3,817.50	-47.85	10.34	-53.73	2.73	H	-46.12	-70.75
	5,726.25	-44.51	10.65	-45.82	3.60	H	-38.77	-63.40
	7,635.00	-53.99	9.15	-44.66	3.88	H	-39.39	-64.02

NOTES: Radiated Spurious Emission Measurements at 3 meters by Substitution Method
according to ANSI/TIA/EIA-603-C-2004, Aug. 17, 2004:



7.4 Frequency stability / variation of ambient temperature

7.4.1 FREQUENCY STABILITY (PCS CDMA)

OPERATING FREQUENCY: 1880,000,000 Hz
 CHANNEL: 600
 REFERENCE VOLTAGE: 7.4 VDC
 DEVIATION LIM IT: ± 0.000 25 % or 2.5 ppm

Voltage (%)	Power (VDC)	Temp. (°C)	Frequency (Hz)	Frequency Error (Hz)	Deviation (%)	ppm
100%	7.400	+20(Ref)	1879 999 995	-5	0.000 000	-0.003
100%		-30	1879 999 991	-9	0.000 000	-0.005
100%		-20	1879 999 979	-21	-0.000 001	-0.011
100%		-10	1880 000 014	14	0.000 001	0.007
100%		0	1880 000 031	31	0.000 002	0.016
100%		+10	1879 999 975	-25	-0.000 001	-0.013
100%		+20	1880 000 017	17	0.000 001	0.009
100%		+30	1879 999 994	-6	0.000 000	-0.003
100%		+40	1879 999 981	-19	-0.000 001	-0.010
100%		+50	1880 000 028	28	0.000 001	0.015
115%	8.510	+20	1880 000 034	34	0.000 002	0.018
Batt. Endpoint	6.290	+20	1880 000 016	16	0.000 001	0.009

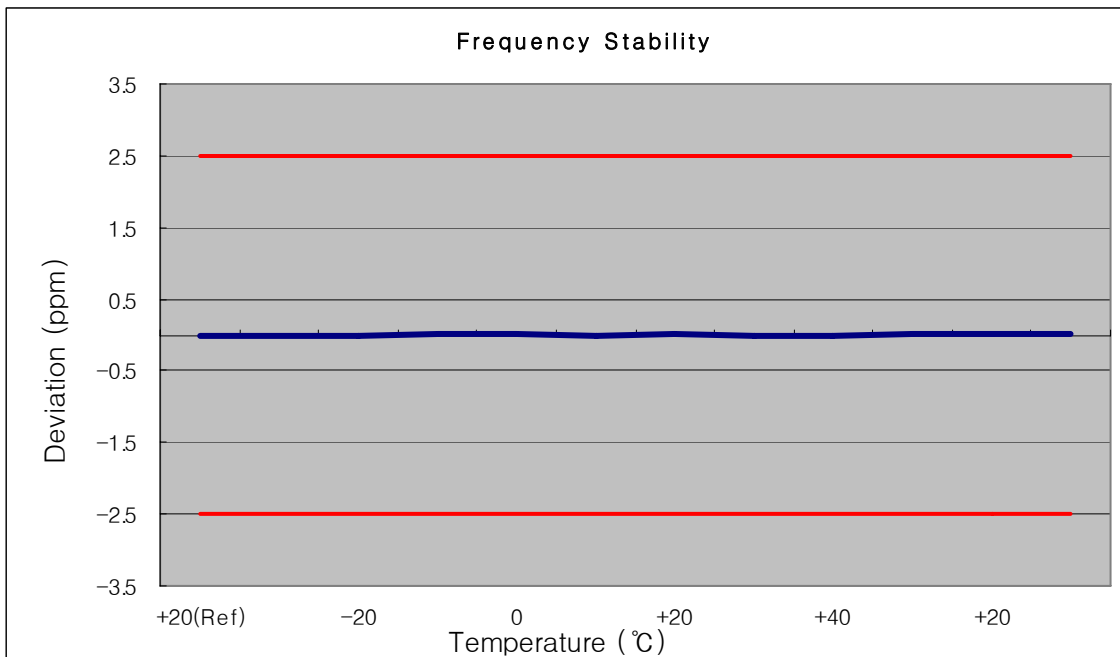



8. TEST PLOTS

FCC Part24 Permissive Change Class II			www.hct.co.kr
Test Report No. HCT-R08-094	Test Dates: July 15, 2008	EUT Type: PCS Wireless Gateway with WLAN	FCC ID: PH7MV430A



■ PCS CDMA MODE (25CH.)Occupied Bandwidth

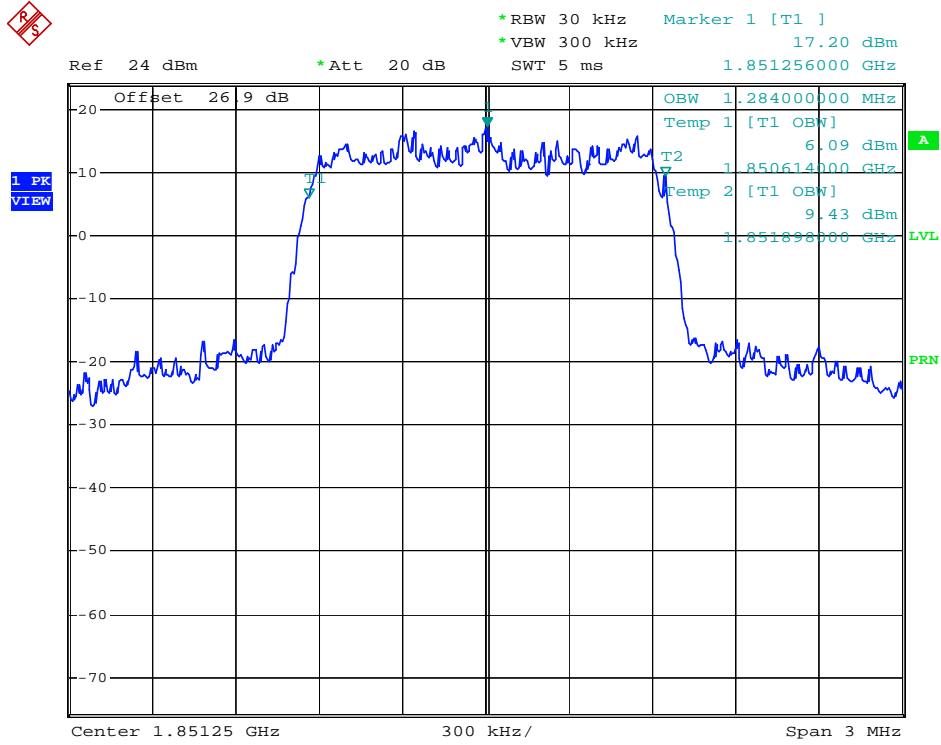

Date: 20.JUN.2008 17:17:49

■ PCS CDMA MODE (600CH.)Occupied Bandwidth

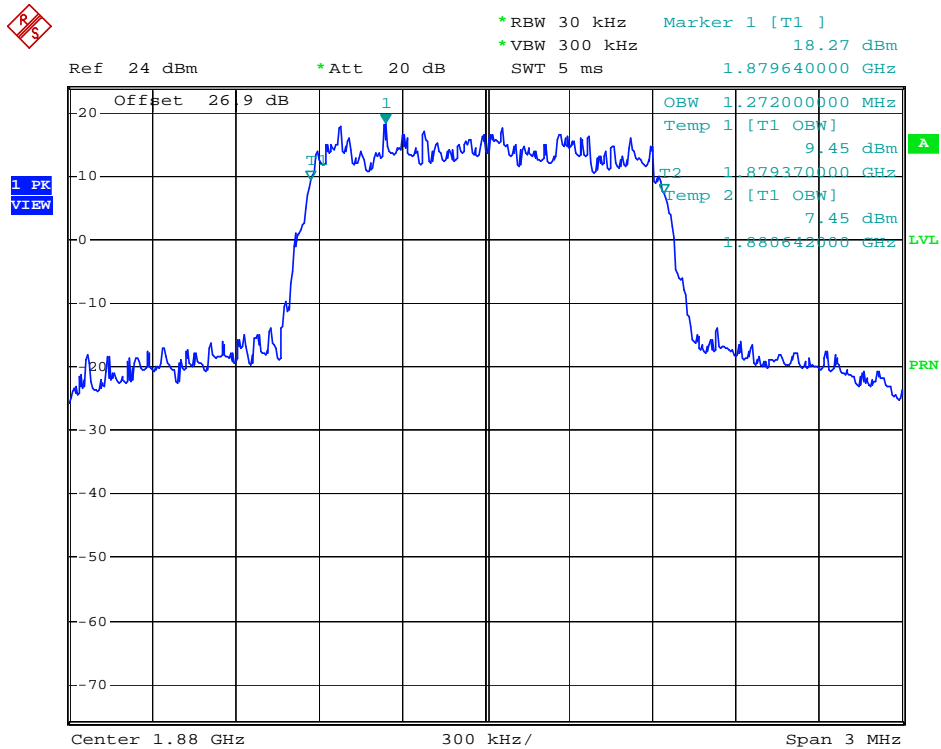

Date: 20.JUN.2008 17:19:16

FCC Part24 Permissive Change Class II				www.hct.co.kr
Test Report No. HCT-R08-094	Test Dates: July 15, 2008	EUT Type: PCS Wireless Gateway with WLAN	FCC ID: PH7MV430A	Page 17 of 22



■ PCS CDMA MODE (1175CH.)Occupied Bandwidth

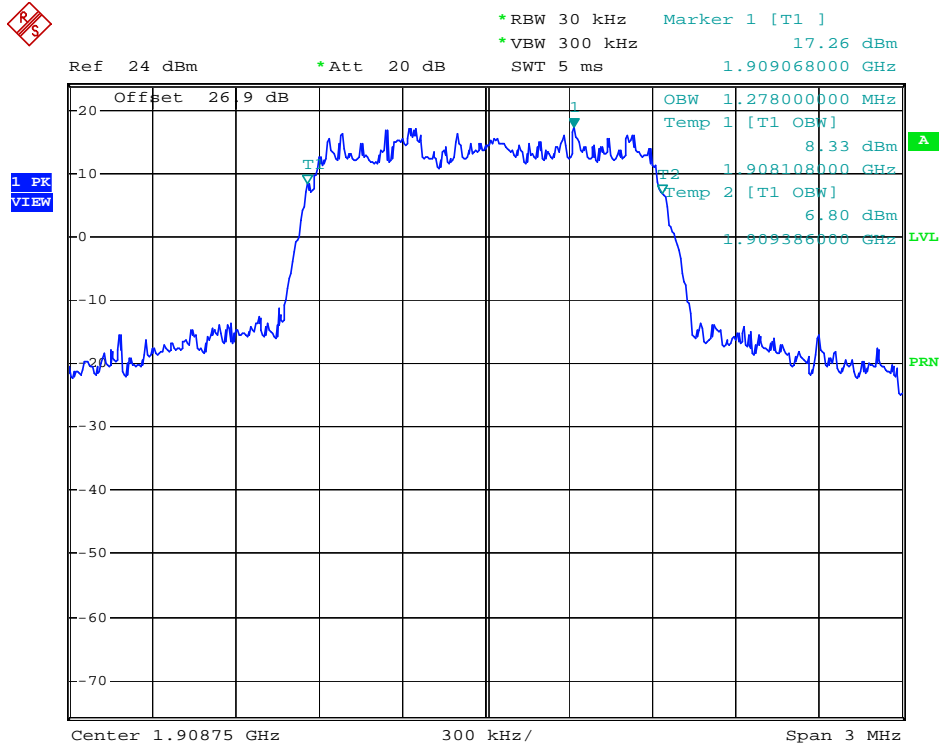

Date: 20.JUN.2008 17:20:41

■ PCS CDMA EVAO MODE (600CH.)Occupied Bandwidth

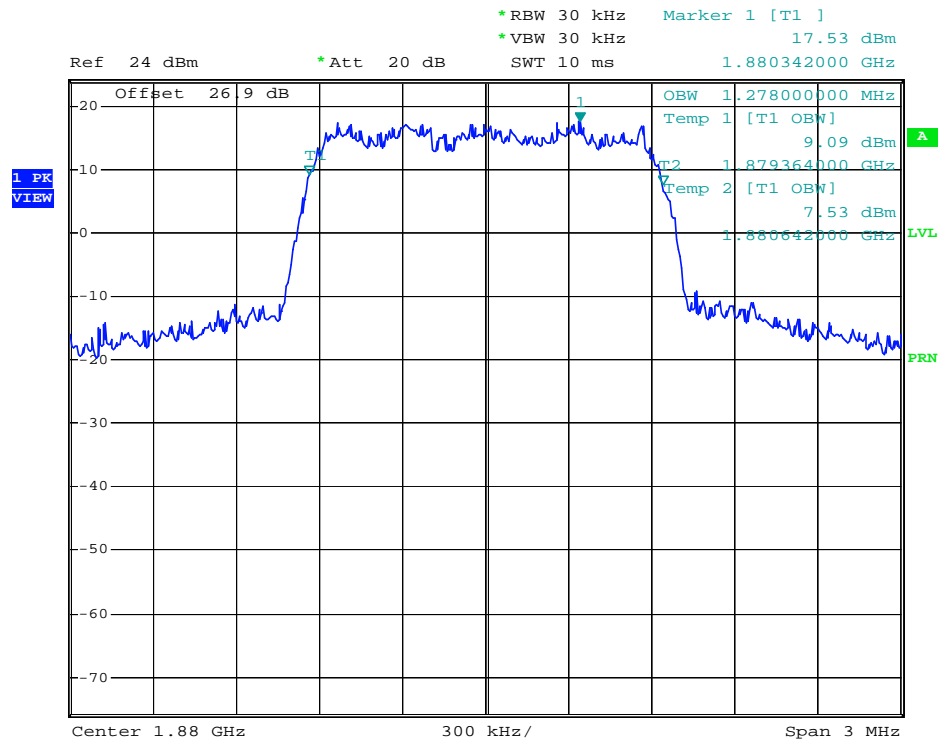

Date: 14.JUL.2008 18:07:33

FCC Part24 Permissive Change Class II				www.hct.co.kr
Test Report No. HCT-R08-094	Test Dates: July 15, 2008	EUT Type: PCS Wireless Gateway with WLAN	FCC ID: PH7MV430A	Page 18 of 22



■ PCS CDMA MODE (25CH.) Block Edge

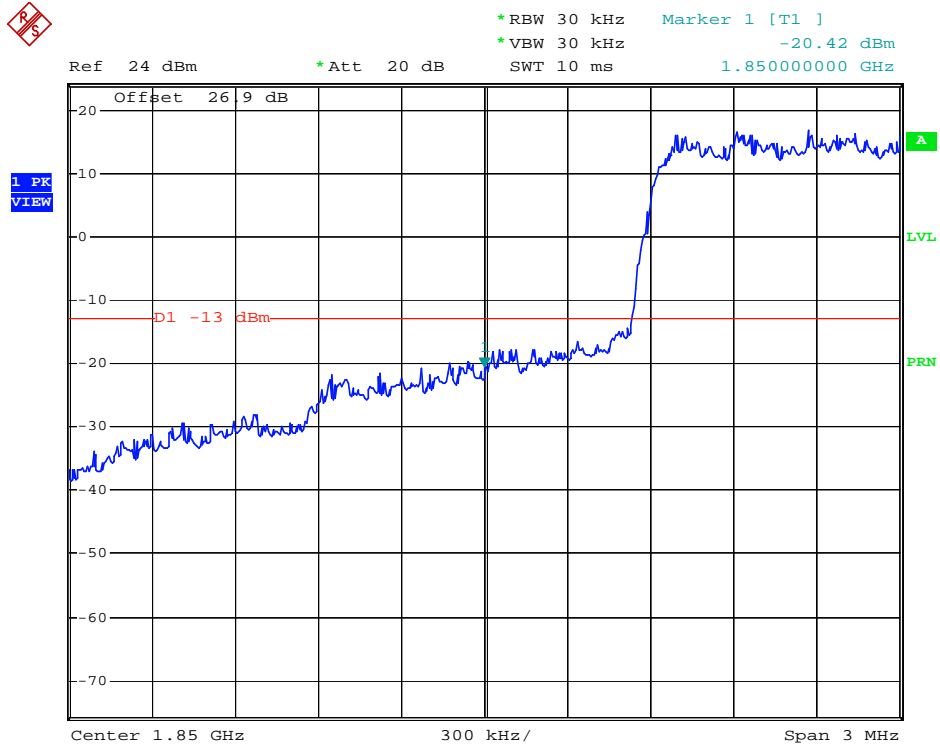

Date: 20.JUN.2008 17:23:12

■ PCS CDMA MODE (1175CH.) Block Edge

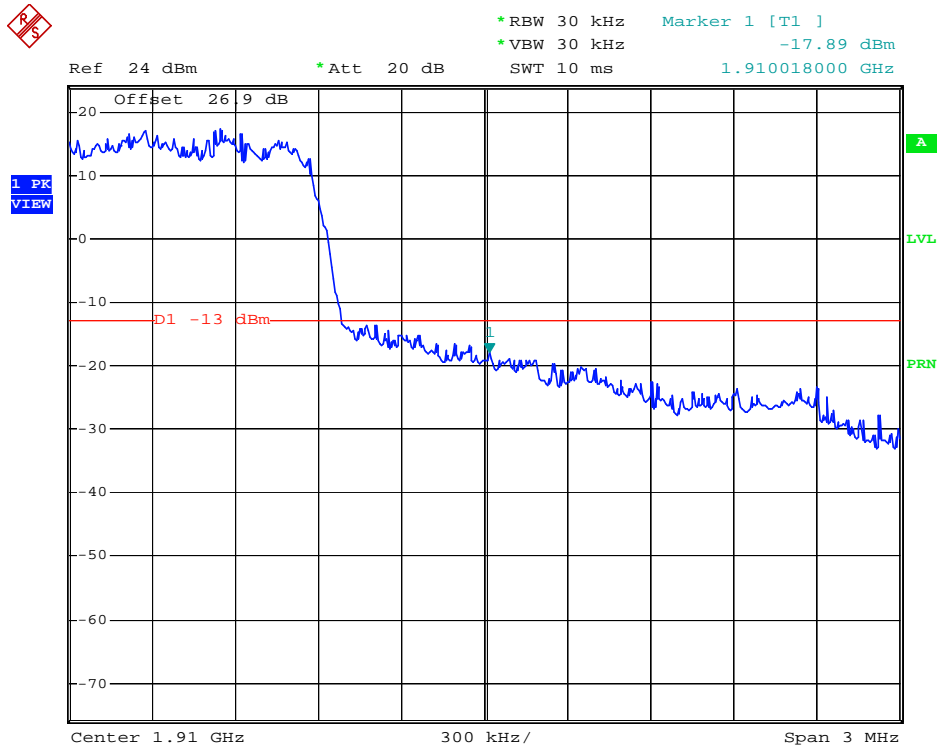

Date: 20.JUN.2008 17:22:21

FCC Part24 Permissive Change Class II				www.hct.co.kr
Test Report No. HCT-R08-094	Test Dates: July 15, 2008	EUT Type: PCS Wireless Gateway with WLAN	FCC ID: PH7MV430A	Page 19 of 22



■ PCS CDMA MODE (25CH.) Conducted Spurious Emissions

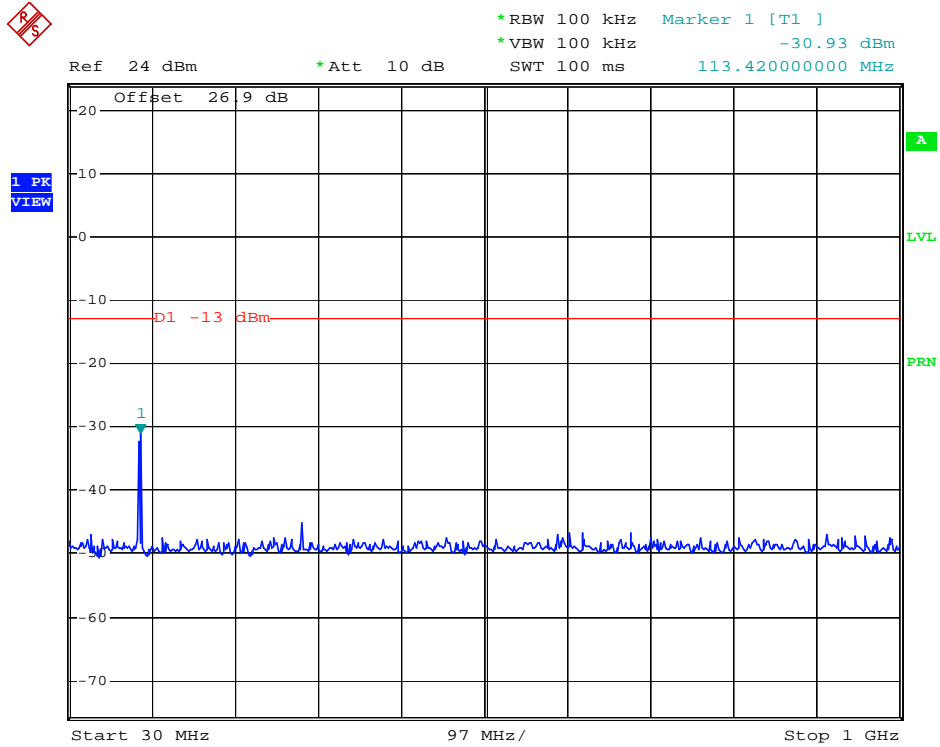

Date: 20.JUN.2008 17:37:10

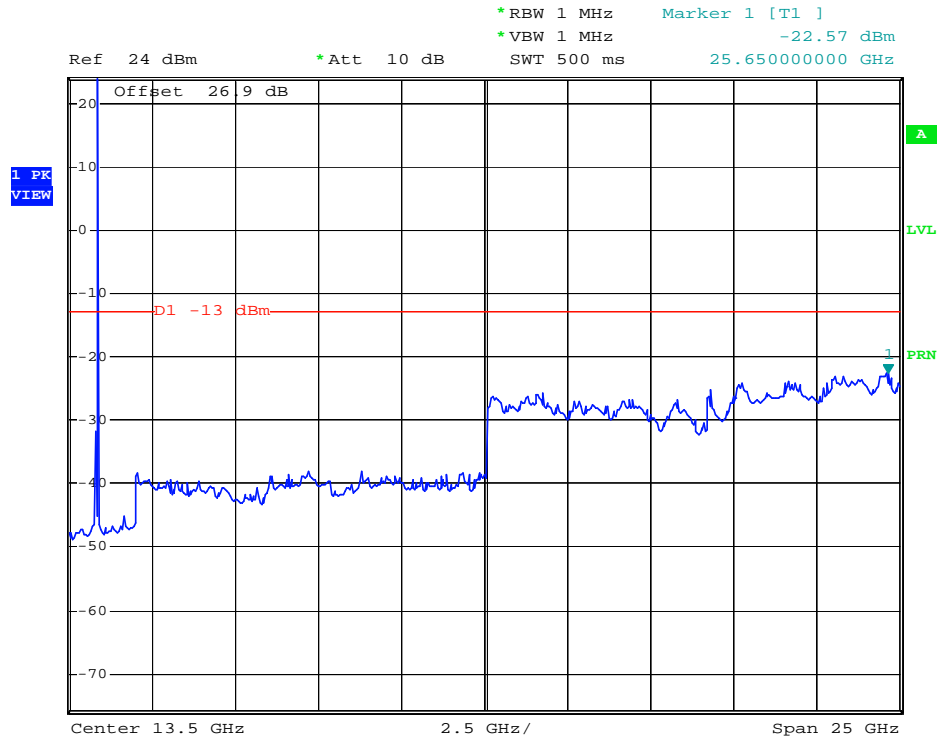

Date: 20.JUN.2008 17:58:49

FCC Part24 Permissive Change Class II				www.hct.co.kr
Test Report No. HCT-R08-094	Test Dates: July 15, 2008	EUT Type: PCS Wireless Gateway with WLAN	FCC ID: PH7MV430A	Page 20 of 22



■ PCS CDMA MODE (600CH.) Conducted Spurious Emissions

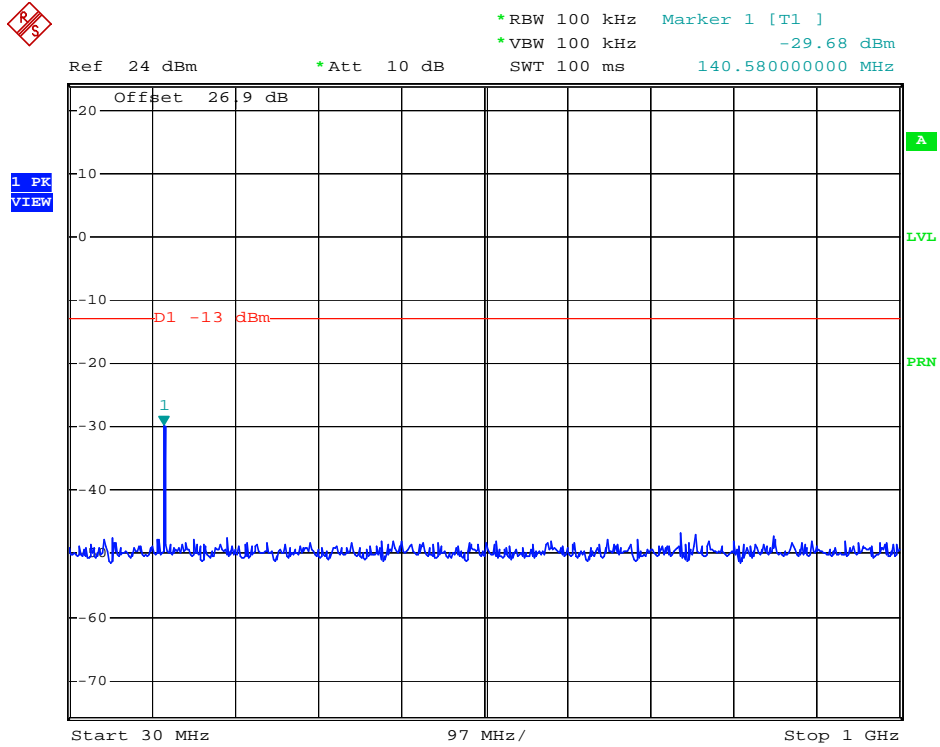

Date: 20.JUN.2008 17:38:10

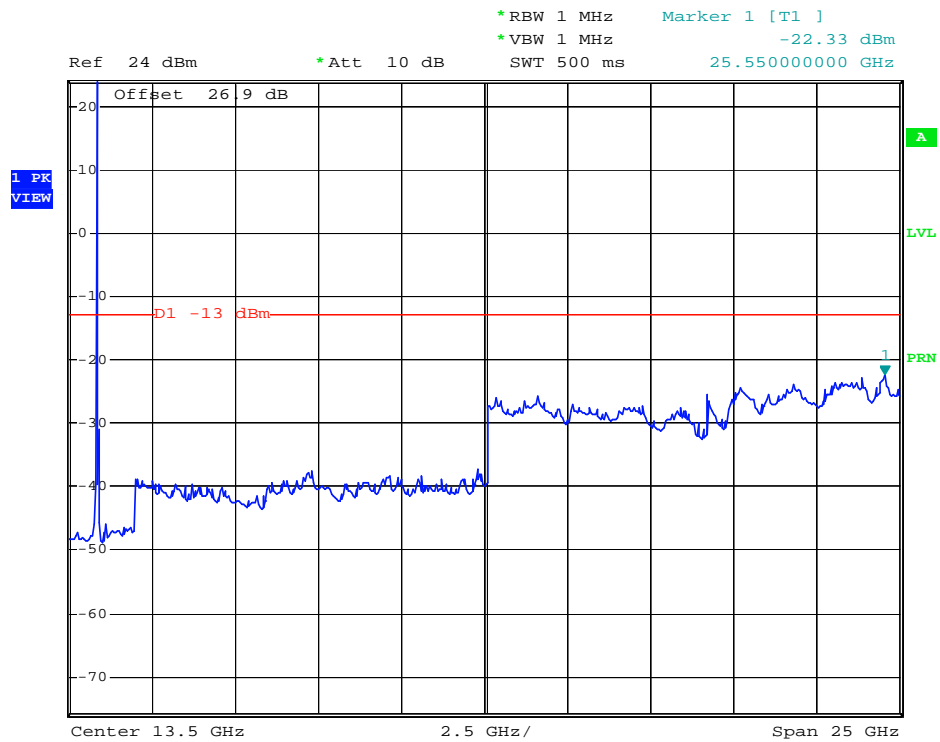

Date: 20.JUN.2008 17:57:40

FCC Part24 Permissive Change Class II				www.hct.co.kr
Test Report No. HCT-R08-094	Test Dates: July 15, 2008	EUT Type: PCS Wireless Gateway with WLAN	FCC ID: PH7MV430A	Page 21 of 22



■ PCS CDMA MODE (1175CH.) Conducted Spurious Emissions

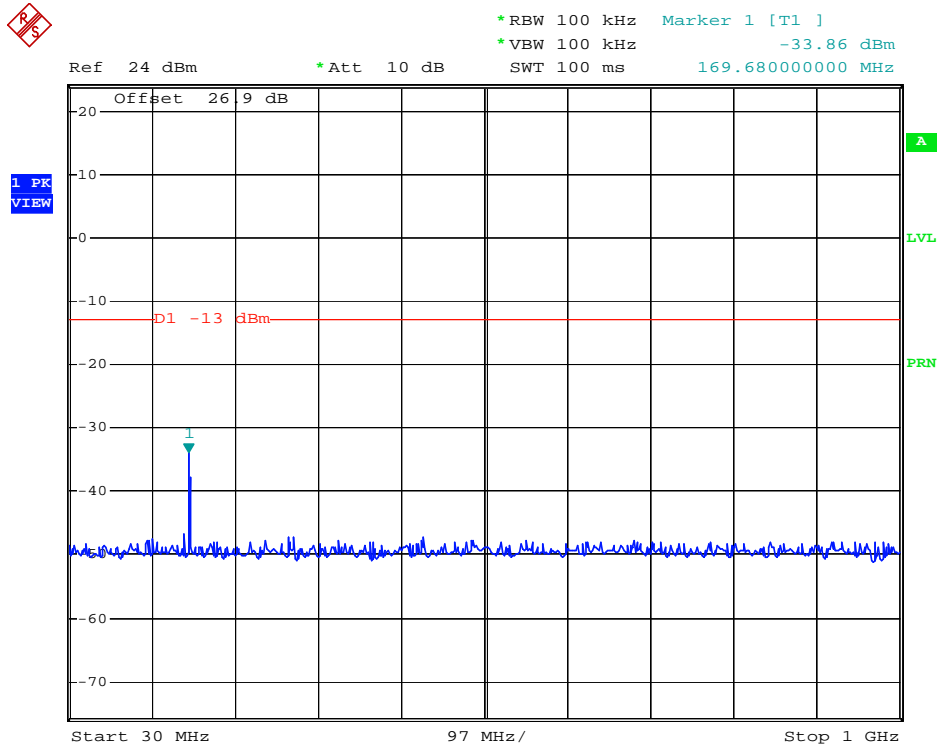

Date: 20.JUN.2008 17:38:35

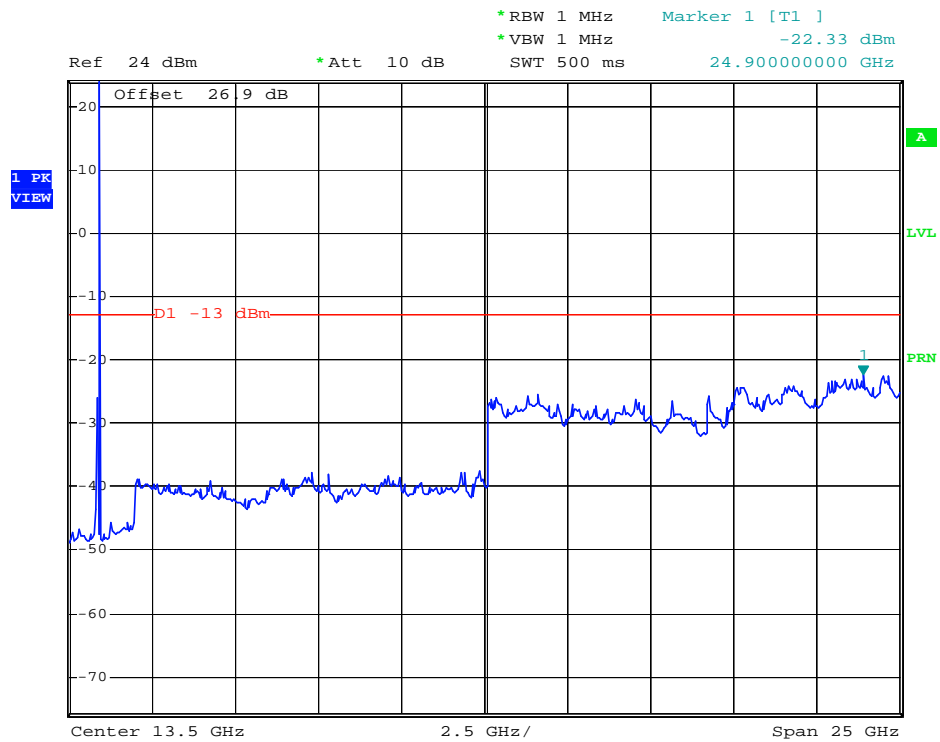

Date: 20.JUN.2008 17:56:55

FCC Part24 Permissive Change Class II				www.hct.co.kr
Test Report No. HCT-R08-094	Test Dates: July 15, 2008	EUT Type: PCS Wireless Gateway with WLAN	FCC ID: PH7MV430A	Page 22 of 22