

Important Notice

Due to the nature of wireless communications, transmission and reception of data can never be guaranteed. Data may be delayed, corrupted (i.e., have errors) or be totally lost. Although significant delays or losses of data are rare when wireless devices are used in a normal manner with a well-constructed network, the device should not be used in situations where failure to transmit or receive data could result in damage of any kind to the user or any other party, including but not limited to personal injury, death or loss of property. Axesstel accepts no responsibility for damages of any kind resulting from delays or errors in data transmitted or received using the Axesstel device or for failure of the Axesstel device to transmit or receive such data.

Safety Precautions

- Only use the supplied power adaptor, and do not use the power adaptor in temperatures over 40°C, and only use in a dry location
- Only use 9V batteries in the main unit and the motion sensors, as there is a risk of explosion if an incorrect battery type is used
- Please dispose of any used 9V batteries at a proper facility
- Do not operate the device:
 - In areas where blasting is in progress
 - Where explosive atmospheres may be present
 - Near medical equipment
 - Near life support equipment or any equipment that may be susceptible to any form of radio interference. In such areas, the device **MUST BE POWERED OFF**. The Axesstel device can transmit signals that could interfere with this equipment.

AXESSTEL ALERT PRODUCTS

CONSUMER WARRANTY AND LIMITATION OF LIABILITY

THE AXESSTEL ALERT PRODUCT THAT YOU HAVE PURCHASED, WHEN PROPERLY INSTALLED, CAN BE USED TO DETECT MOTION IN A SPECIFIED AREA AND PROVIDE AN ALERT TO TELEPHONES OR PERSONAL DIGITAL ASSISTANTS THAT YOU SPECIFY. THE PRODUCT IS DESIGNED SOLELY TO PROVIDE AN ALERT. IT DOES NOT PROVIDE SECURITY, OR PREVENT INTRUSION, THEFT OR CRIME.

THE PRODUCT IS NOT A SECURITY SERVICE, ALERTS ARE SENT ONLY TO THE DEVICES YOU SPECIFY. THEY ARE NOT MONITORED BY AXESSTEL, THE TELEPHONE COMPANY, LAW ENFORCEMENT OR OTHER AGENCIES. ALERTS ARE SENT OVER THE PUBLIC WIRELESS TELEPHONE NETWORK. INTERRUPTION OF TELEPHONE SERVICE WILL PREVENT TRANSMISSION OF ALERTS.

LIMITED WARRANTY. FOR PERIOD OF **[APPLICABLE WARRANTY PERIOD]**, AXESSTEL WARRANTS THAT THE ALERT PRODUCT SHALL (I) BE FREE FROM DEFECTS IN DESIGN, MATERIALS OR WORKMANSHIP, (II) CONFORM TO ITS PRODUCT SPECIFICATIONS AND (III) BE COMPLIANT WITH ITS WIRELESS COMMUNICATION STANDARD (CDMA 1X, EVDO, GSM, GPRS AND EDGE, AS APPLICABLE). FOR ANY PRODUCTS THAT FAIL TO MEET THE FOREGOING WARRANTY, AXESSTEL, SHALL REPAIR OR REPLACE SUCH PRODUCTS, IN ITS DISCRETION, SO THAT ANY DEFECTIVE PRODUCT OR ANY REPLACEMENT PRODUCT SHALL CONFORM TO THE WARRANTY. IF AXESSTEL CANNOT CURE ANY DEFECT ON COMMERCIALY REASONABLE TERMS, AXESSTEL SHALL REFUND THE VALUE OF THE NON-CONFORMING PRODUCT WITHIN FORTY- FIVE (45) DAYS. EXCEPT FOR THE FOREGOING WARRANTY,

AXESSTEL MAKES NO WARRANTIES, EXPRESS OR IMPLIED, WITH RESPECT TO THE ALERT PRODUCT, AND SPECIFICALLY DISCLAIMS ANY WARRANTIES INCLUDING BUT NOT LIMITED TO ANY WARRANTY OF MERCHANTABILITY OR FITNESS FOR A PARTICULAR PURPOSE OR AGAINST INFRINGEMENT, OR ANY EXPRESS OR IMPLIED WARRANTY ARISING OUT OF TRADE USAGE OR OUT OF A COURSE OF DEALING OR COURSE OF PERFORMANCE

AXESSTEL DOES NOT REPRESENT OR WARRANT THAT THE PRODUCT WILL OPERATE ERROR FREE, OR THAT THE PRODUCT WILL NOT BE DISABLED, COMPRISED OR CIRCUMVENTED (BY DISABLING TELEPHONE SERVICE OR IN SOME OTHER WAY). AXESSTEL DOES NOT WARRANT THAT THE PRODUCT WILL DETECT OR PREVENT ALL INTRUSION, LOSS OF PROPERTY OR PERSONAL INJURY OR BURGLARY, HOLD-UP, FIRE, OR MEDICAL PROBLEM; OR THAT THE PRODUCT WILL IN ALL CASES PROVIDE THE PROTECTION FOR WHICH IT IS INTENDED.

LIMITATION OF LIABILITY. AXESSTEL NOT BE LIABLE TO YOU UNDER ANY CIRCUMSTANCE FOR INCIDENTAL, CONSEQUENTIAL OR SPECIAL DAMAGES, ARISING OUT OF THE USE OR INABILITY TO USE, ANY OF THE ALERT PRODUCTS OR COMPONENTS. AXESSTEL WILL NOT BE RESPONSIBLE FOR ANY LOSS OF PROPERTY, DAMAGE TO PROPERTY, PERSONAL INJURY, DEATH OR OTHER INCIDENTAL DAMAGES, HOWEVER CAUSED, ARISING OUT OF THE USE OR INABILITY TO USE, ANY OF THE ALERT PRODUCTS OR COMPONENTS. ANY LIABILITY OF AXESSTEL TO YOU, AND YOUR SOLE AND EXCLUSIVE REMEDY, FOR ANY CLAIM ARISING OUT OF THE USE OR PURCHASE OF THE PRODUCT (WHETHER IN CONTRACT, TORT, OR OTHERWISE) WILL NOT EXCEED THE PURCHASE PRICE PAID FOR THE PRODUCT WHICH IS THE SUBJECT OF SUCH CLAIM OR CAUSE OF ACTION.

NOT INSURANCE. AXESSTEL IS NOT AN INSURER AND IS NOT RESPONSIBLE FOR ACTS OR OMISSIONS OF OTHERS OR FOR EVENTS BEYOND ITS CONTROL. THE PURCHASE PRICE FOR THE PRODUCT HAS NO RELATIONSHIP TO THE VALUE, IN WHOLE OR IN ANY PART, ANY LOSS, DAMAGE, INJURY OR DEATH WHICH MIGHT RESULT TO YOU OR YOUR PROPERTY FROM ANY HAZARD OR EVENT OR CONSEQUENCE WHICH THE PRODUCT IS INTENDED TO DETECT. YOU HAVE THE SOLE RESPONSIBILITY TO OBTAIN WHATEVER INSURANCE YOU WANT TO HAVE IN ORDER TO COVER RISK, LOSSES, DAMAGES, INJURIES, DEATH AND OTHER EFFECTS OF BURGLARY, FIRE, PHYSICAL DANGERS OR MEDICAL PROBLEMS AFFECTING, YOU, YOUR FAMILY OR ANY OTHER PERSONS WHO MAY BE IN OR NEAR YOUR LOCATION. YOU WILL LOOK SOLELY TO THE PROCEEDS OF SUCH INSURANCE FOR ANY LOSS, LIABILITY, DAMAGE OR CLAIM.

USE AT OWN RISK. YOU ACCEPT THE ENTIRE RISK OF THE USE OF THE PRODUCT. YOU HEREBY AGREE TO RELEASE, DEFEND, INDEMNIFY AND HOLD AXESSTEL HARMLESS FROM AND AGAINST CLAIM OR LIABILITY FOR ANY RISK, LOSS, PROPERTY DAMAGE, PERSONAL INJURY, DEATH AND OTHER EFFECTS MENTIONED ABOVE AT YOUR SOLE COST AND EXPENSE INCLUDING ATTORNEY'S FEES.

Important Notice.....	1
Safety Precautions	2
Introduction	9
Product Overview.....	9
1. Features.....	9
2. Benefits.....	10
Using your AX140	12
1. Package Contents.....	12
2. Knowing your Main Unit.....	12
2.1 LEDs	14
2.2 Battery Installation into Main Unit	16
2.3 Battery Installation into Motion Sensor	16
2.4 Connecting the Power Adaptor.....	17
2.5 Placement of Main Unit.....	18
2.6 Placement of Motion Sensor	18
3. Using your Main Unit.....	18
3.1 Changing the Default Password	18
3.2 Adding / Removing Motion Sensors.....	19
3.3 Adding / Removing SMS Numbers	22
3.4 Adding / Removing Call Numbers.....	25

3.5	Arming the AX140	27
3.5.1	Arm away Mode	27
3.5.2	Stay Mode.....	29
3.5.3	Remote Arming	30
3.6	Disarming the AX140	30
3.6.1	Normal Disarming	30
3.6.2	Duress Disarming.....	31
3.6.3	Remote Disarming	31
3.7	Entry / Exit Delay	31
3.7.1	Entry Delay	32
3.7.2	Exit Delay.....	32
3.8	Panic Button	33
3.9	Factory Reset	34
3.10	Test Mode.....	34
3.11	Pet Immunity.....	34
3.12	Accessories	35
4.	AX140 Smartphone Application	36
4.1	AX140 App for Android	36
	The AX140 App for android is available from Google Play.	36
4.2	AX140 App for iPhone.....	37

4.3	AX140 App creating user account (Android/iOS)	38
4.4	Manage Call Numbers (Android/iOS)	39
4.5	Manage SMS Numbers (Android/iOS)	40
4.6	Delay Time (Entry/Exit)	41
4.7	Remote Arming/Disarming	42
4.8	Account Info/Device Status (Android/iOS)	44
4.9	Event Log	46
5.	Z-Wave	47
6.	Operating Specifications	52
6.1	Main Unit AX140	52
6.2	Motion Sensor (AZ100)	54
7.	Safety Information	55

Introduction

This user manual will help you place, configure and use your AX140 Alert System.

Product Overview

The AX140 is an easy to install, use and maintain alert system, which can provide peace of mind and security without the need for an expensive security contract.

Some features described in this manual may not be supported by your service provider or may not be available with your network account. For details of the services and accounts available, contact your service provider.

1. Features

- ***Android and iOS Applications for AX140 Management***
- ***10 Multiple LED indicators - Power, Battery, CDMA, Setting/Register, Arming/Disarming, Zone Status Indicator 1 – 4, Account status***
- ***Loud Audible Siren***
- ***Z-Wave support***
- ***Call Alerting Numbers - Stores 5 pre-assigned numbers***

- ***SMS Alerting Numbers - Stores 3 pre-assigned number***
- ***Remote Arm / Disarm Capabilities via Smartphone application***
- ***Audible Beeper for Programming Configuration***
- ***Panic Button for Emergency Situations***
- ***9 Volt Battery for Emergency Backup***
- ***Low battery warning LED***
- ***Tamper Prevention on Controller***

2. Benefits

SMS / Call Alerts if the Motion Sensor is Triggered

Notify up to 8 friends and neighbors via call and SMS when motion is detected to increase chances of a close-by responder. You can program up to 3 SMS numbers and 5 call numbers.

Emergency Backup Battery

An AC adaptor with a 9V backup battery provides continued functionality in the event of a power outage.

Remote Control Convenience

The arming and disarming of the AX140 Alert System can be triggered by keypad input or by using the smartphone App (Android/iOS) from one of your registered numbers. A smartphone app may also be used from your Android or iOS smartphone.

Affordable, Easy to Setup, Configure, and Use

A basic prepaid / postpaid subscription provides increased peace of mind. To setup the device, you will simply need to contact your service provider. You are then ready to start using your AX140 Alert system.

Easy to use Main Unit

10 LED indicators represent the product status. The unit is also very easy to program and to modify the list of SMS / Call contacts.

Using your AX140

1. Package Contents

- 1x Main Unit
- 1x Motion Sensor with bracket
- 1x Power Adaptor

2. Knowing your Main Unit

Your AX140 is designed to be wall mounted, or it can simply be placed on a shelf. All the LEDs are easily visible while the power cord will connect at the back.

Power LED

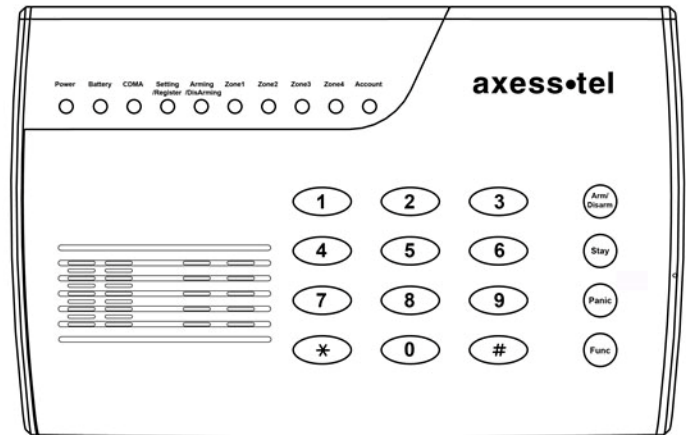

2.1 LEDs

The AX140 has 10 LEDs to determine status of the device. The functionality of the LEDs can be found in the table below.

LED description

LED	Color		Function
Power	Green	●	Device is powered on
	OFF	○	The device is powered off
Battery	Green	●	Battery is good/ powered by battery
	Red	●	Battery is low/ powered by battery
	OFF	○	No battery in use
Signal	Green	●	registered to the network, strong signal, 5 bars
	Blink Green	⦿	registered to the network, very good signal, 4 bars
	Orange	●	registered to the network, good signal, 3 bars
	Blink Orange	⦿	registered to the network, low signal, 2 bars
	Red	●	registered to the network, weak signal, 1 bar
	Blink Red	⦿	not registered to the network
Setting /Register	Green	●	In setting status
	Blinking	⦿	In registration status, push button in sensor to add
	OFF	○	Not in the setting mode



Arming /Disarming	Red	●	Device is armed
	OFF	○	Device is disarmed
Zone1	Green	●	Sensor is Armed
	Red	●	Sensor Alarm detected
	OFF	○	Sensor is Disarmed
	Blink Red	●	Sensor Low battery warning, blink each 2 seconds
Zone2	Green	●	Sensor is Armed
	Red	●	Sensor Alarm detected
	OFF	○	Sensor is Disarmed
	Blink Red	●	Sensor Low battery warning, blink each 2 seconds
Zone3	Green	●	Sensor is Armed
	Red	●	Sensor Alarm detected
	OFF	○	Sensor is Disarmed
	Blink Red	●	Sensor Low battery warning, blink each 2 seconds
Zone4	Green	●	Sensor is Armed
	Red	●	Sensor Alarm detected
	OFF	○	Sensor is Disarmed
	Blink Red	●	Sensor Low battery warning, blink each 2 seconds
Account	OFF	○	Optional use by Network

2.2 Battery Installation into Main Unit

Your AX140 provides battery backup support. Please see figure1 below to install the 9V battery.

2.3 Battery Installation into Motion Sensor

To install the battery into the Motion Sensor please see figure1 below.

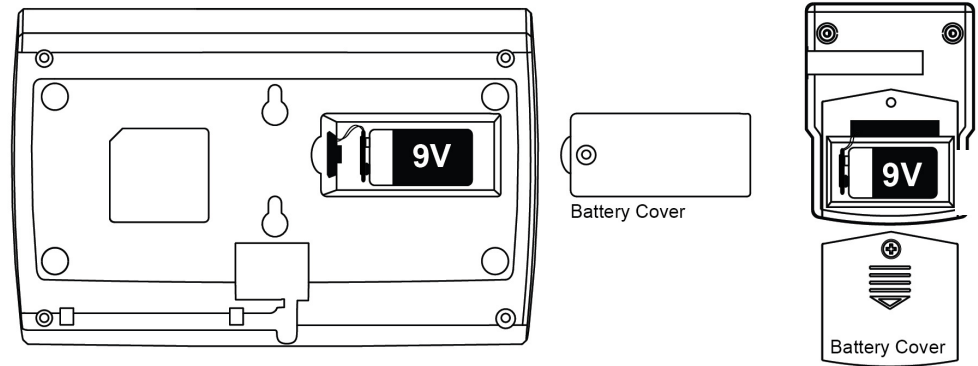

Figure 1

2.4 Connecting the Power Adaptor

To connect the power adaptor, please see figure2 below.

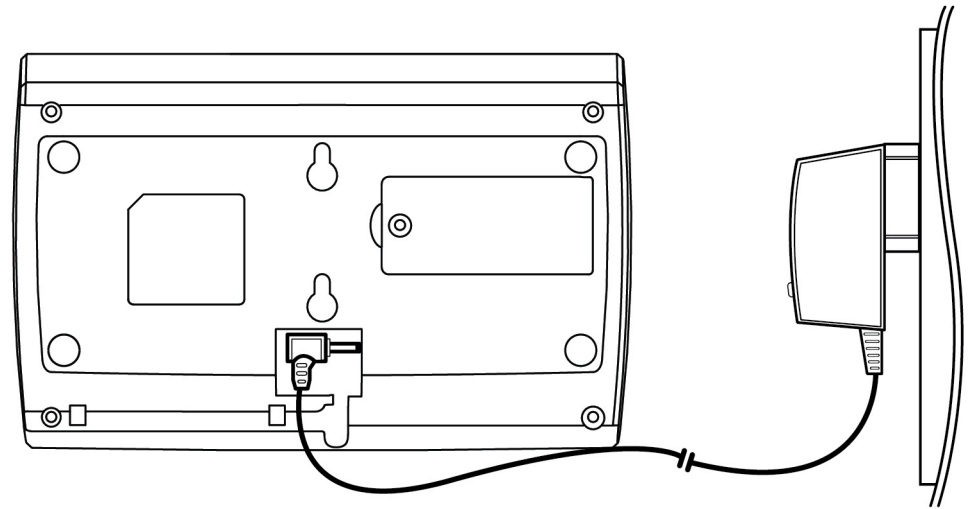

Figure 2

2.5 Placement of Main Unit

The keypad should be placed near the entry / exit point of the house.

2.6 Placement of Motion Sensor

The motion sensor should be placed on shelves or walls and can detect motion within 50 meters, great for rooms with lots of windows.

3. Using your Main Unit

3.1 Changing the Default Password

Now that the battery is installed and the power adaptor connected you are ready to use some of the more advanced features of the AX140.

To change the default password please follow the instructions below.
Using your keypad please enter the following

#→password→ 00 →new password→new password→Func Key

NOTE: IT IS ADVISABLE TO CHANGE YOUR PASSWORD AS SOON AS YOU CONNECT THE UNIT

*Default password is 1234. So if you wanted to change your password to 4897, then you would enter the following:

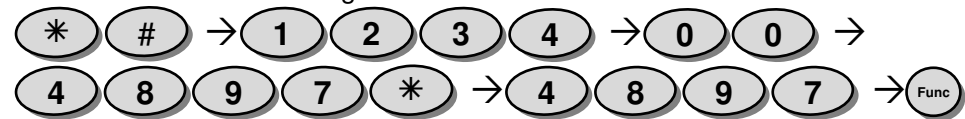

3.2 Adding / Removing Motion Sensors

To add motion sensors (AZ100) to the AX140 please follow the instructions below. Up to 200 Motion sensors can be added across 4 zones. In the rear housing, there is a small push button switch which is used for adding the sensor (inclusion) and remove (exclusion) of the sensor. The following will add the AZ100 sensors (inclusion/association) to the AX140 (see illustration below).

You will have 30 seconds to push the add button once the "Setting/Register" Led is lit.

NOTE: You will need to (**Remove motion sensor battery cover in order to register your sensor, see figure3**)

*#→password→71 (zone-1)→Func-Key	Press the sensor button.	Setting/Register LED Blinks few times then OFF
*#→password→72 (zone-2)→Func-Key	Press the sensor button.	Setting/Register LED Blinks few times then OFF
*#→password→73 (zone-3)→Func-Key	Press the sensor button.	Setting/Register LED Blinks few times then OFF
*#→password→74 (zone-4)→Func-Key	Press the sensor button.	Setting/Register LED Blinks few times then OFF

Please note: that you need to press the button of the desired sensor within 30 seconds to register correctly.

To add additional sensors in your desired zone please repeat the above instructions.

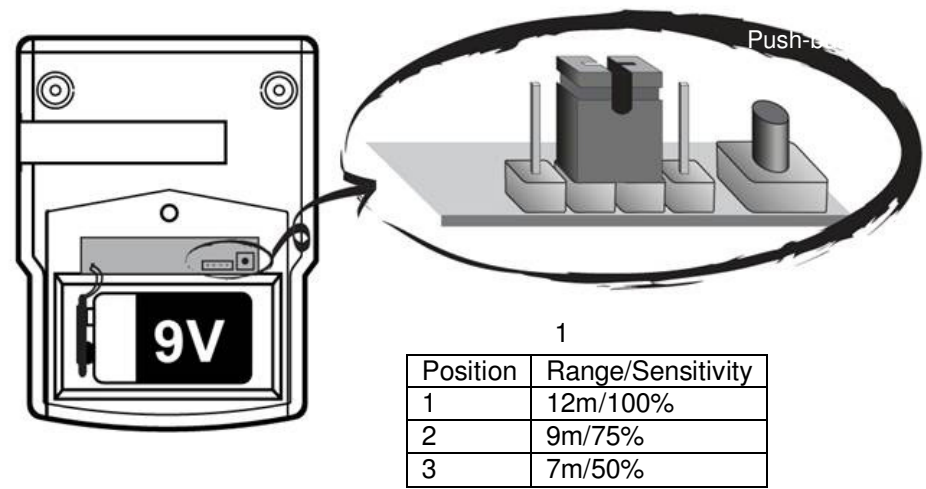

Figure 3

To remove/delete (exclusion) any motion sensors please follow the instructions below.

*#→password→70→Func-Key	Remove motion sensor battery cover and press the sensor button.	Setting/Register LED Blinks few times then OFF
-------------------------	-----------------------------------------------------------------	------------------------------------------------

Please note: that you need to press the button on the desired sensor within 30 seconds for de-registration.

3.3 Adding / Removing SMS Numbers

When your alarm is triggered in any zone, you can choose to send an SMS to up to 3 numbers. To add the SMS numbers into your AX140 please follow the instructions below.

#→password→11→SMS Num.1→SMS Num.1→Func Key
#→password→12→SMS Num.2→SMS Num.2→Func Key
#→password→13→SMS Num.3→SMS Num.3→Func Key

Example:

Adding the first SMS number:

#→password→11→1234567890→1234567890→ Func Key

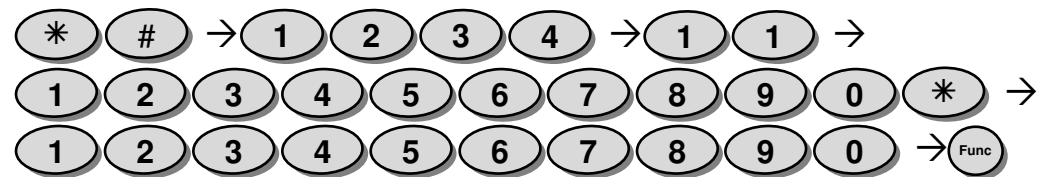

Please note: that you have to enter the desired number twice. The number that you entered will need to match. If the numbers entered **do not** match then the unit will beep **3** times. If the numbers match then you will hear 2 beeps.

To remove the SMS numbers please enter the details below.

*#→password→20→Func Key Delete all SMS telephone numbers

*#→password→21→Func Key Delete number 1
*#→password→22→Func Key Delete number 2
*#→password→23→Func Key Delete number 3

3.4 Adding / Removing Call Numbers

When your alarm is triggered as well as sending SMS, the AX140 will also dial 5 numbers of your choice.

To add numbers please follow the instructions below.

#→password→31→Tel Num.1→Tel Num.1→Func Key
#→password→32→Tel Num.2→Tel Num.2→Func Key
#→password→33→Tel Num.3→Tel Num.3→Func Key
#→password→34→Tel Num.4→Tel Num.4→Func Key
#→password→35→Tel Num.5→Tel Num.5→Func Key

Example:

Adding the first telephone number: *#→password→31→1234567890*→1234567890→Func Key

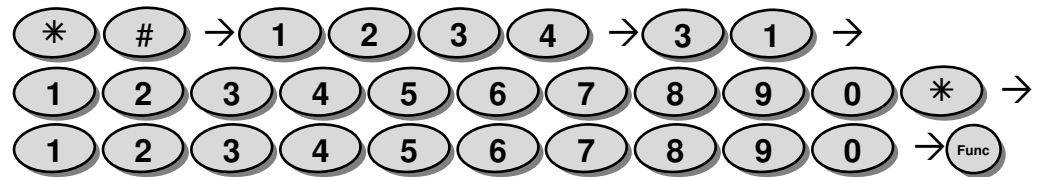

Please note: that you have to enter the desired number twice. The number that you entered will need to match. If the numbers **do not** match, then the unit will beep **3** times. If the numbers match then you will hear 2 beeps.

To remove the phone numbers please follow the instructions below.

*#→password→40→Func Key	Delete all telephone numbers
*#→password→41→Func Key	Delete number 1
*#→password→42→Func Key	Delete number 2
*#→password→43→Func Key	Delete number 3
*#→password→44→Func Key	Delete number 4

*#→password→45→Func Key Delete number 5

Example:

Removing the first telephone number:

*#→password→41→Func Key



3.5 Arming the AX140

Now that the AX140 is installed, the motion sensors have been added, and the SMS / Call numbers have been inputted, you can now start using your AX140 as an alert system.

There are two arming modes within the AX140, Arm away Mode and Stay Mode. In both modes SMS / Calls will automatically be sent.

3.5.1 Arm away Mode

In the “arm away” mode, when the motion sensors are triggered, it will emit a high pitched continuous siren for 4mins, then re-arm or until the unit is disarmed. You can also choose the

silent setting when the alarm is triggered. The intruder will be unaware that the alarm has been triggered, although SMS / Calls will be sent.

To activate "Arm away" mode enter the following:

*#→password→01→Arming Key;	Alarm siren audible
*#→password→02→Arming Key;	Alarm siren silent

Example:



3.5.2 Stay Mode

Occasionally you may want to alarm only a certain part of your house, and this can be achieved by using Stay mode. Please note that zones one, two or three will be excluded when using stay mode.

In Stay mode, you can activate your alarm so that any motion in zone four will trigger the alarm, but if there is any movement in zones one, two or three then the alarm will not be triggered. In Stay mode you can choose whether the device emits a beep or stays silent when the alarm is triggered. To activate Stay mode enter the following:

*#→password→01→Stay Key	Stay siren audible
*#→password→02→Stay Key	Stay siren silent

Example:



3.5.3 Remote Arming

You can also arm the AX140 remotely via AX140 smartphone (Android/iOS) App. Please refer to App section.

3.6 Disarming the AX140

When disarming the AX140, you can disarm in multiple ways, and these are described below.

3.6.1 Normal Disarming

To disarm the AX140 in a normal manner enter the following:

*#→password→05→(Arm/Disarm) Key Normal disarming

Example:



3.6.2 Duress Disarming

If you are forced to disarm the unit under duress, then SMS / Calls will still be made to the numbers that are stored in your device. Disarm under duress by entering the following:
*#→password→03→(Arm/Disarm) Key

Example:



3.6.3 Remote Disarming

You can also disarm the AX140 remotely via AX140 smartphone (Android/iOS) App. Please refer to App section.

3.7 Entry / Exit Delay

You can modify the entry / exit delay to suit your needs.

3.7.1 Entry Delay

No Entry Delay	*#→password→50→Func Key
15 Seconds -	*#→password→51→Func Key
30 Seconds -	*#→password→52→Func Key
45 Seconds -	*#→password→53→Func Key

Example:



3.7.2 Exit Delay

No Exit Delay	*#→password→60→Func Key
30 Seconds -	*#→password→61→Func Key
60 Seconds -	*#→password→62→Func Key
90 Seconds -	*#→password→63→Func Key
120 Seconds -	*#→password→64→Func Key

Example:



3.8 Panic Button

Your AX140 features a panic button, that when pressed will immediately activate the siren, as well as alerting your friends and neighbors via SMS and Calls.

To activate the panic button simply press the 'PANIC' button which is located on your main unit. Disable PANIC by *#→password→05→Arm/Disarm Key for normal disable.

All Disarming procedures will work for Panic also.

Please note: Once the panic button has been activated it can be disabled by the Keypad only, not remotely by SMS application.

3.9 Factory Reset

If your unit malfunctions or develops any form of software fault then it may be necessary to perform a factory reset. To perform a factory reset, please enter the following:

*#→password→90→Func Key

3.10 Test Mode

“Test mode” - *#→password→91→XXX-XXX-XXXX→Func Key

This allows the AX140 to make a phone call to any phone number.

3.11 Pet Immunity

The passive infrared (PIR) motion detector can be adjusted to provide pet immunity.

Remove the back cover of the PIR motion sensor (see figure 3) to adjust the range/sensitivity setting. Moving the jumper to the number 3 position will adjust for minimum sensitivity. You can also adjust the angle of the sensor slightly upwards to allow for your pet immunity.

3.12 Accessories

Additional accessories can be added to your AX140:

- Door/Window Sensor (same as adding a sensor)
- Key Fob (*#→password→76→Func Key)

4. AX140 Smartphone Application

The below sections define the AX140 Smartphone Application. For the first time setting up the device, a phone number must be entered into the AX140 manually in order for it to be recognized from the app. This can be done by entering the following:

#→password→11→ SMS Number 1 → SMS Number 1→ Func Key

The default password is 1234 and a SMS Number needs to be 10 digits.

4.1 AX140 App for Android

The AX140 App for android is available from Google Play.

Preconditions	Phone is powered on and registered in the network and is able to launch Google Play
Procedure	<ol style="list-style-type: none">1. Open Google Play2. Search for AX140 App3. Download the application to the device

4.2 AX140 App for iPhone

The AX140 app for iPhone is available from the Apple App Store

Preconditions	<ol style="list-style-type: none">1. Phone is powered on2. Launch App Store
Procedure	<ol style="list-style-type: none">1. Open App Store2. Search for AX140 App3. Download the application to the device

4.3 AX140 App creating user account (Android/iOS)

Preconditions	1. Phone is powered on The AX140 application has been downloaded and open
---------------	------------------------------------------------------------------------------

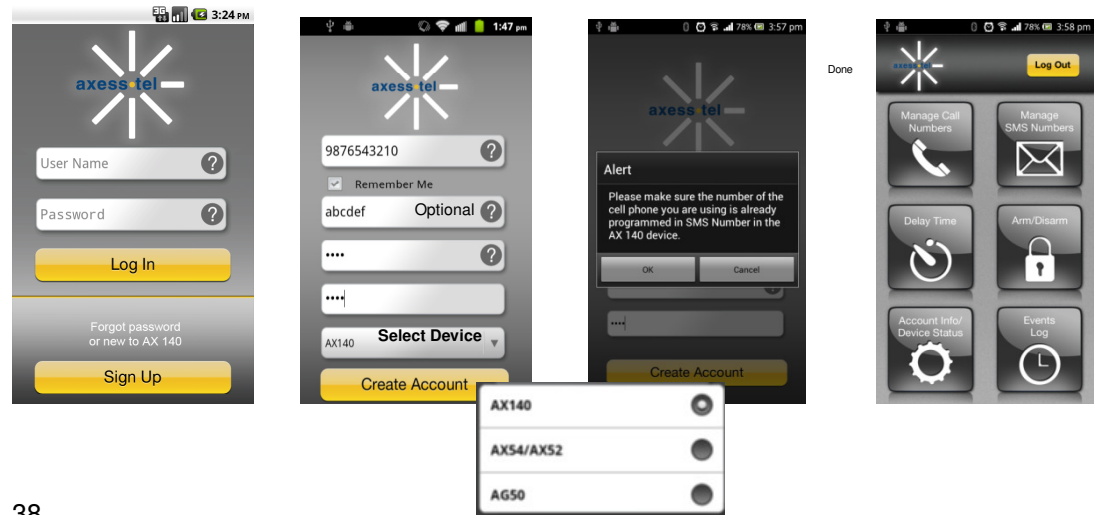

4.4 Manage Call Numbers (Android/iOS)

Preconditions	<ol style="list-style-type: none"> 1. Phone is powered on 2. The AX140 application has been downloaded 3. The SMS number (of the phone using this App) has already been added in the AX140
---------------	-----------------------------------------------------------------------------------------------------------------------------------------------------------------------------------------------------------------------------

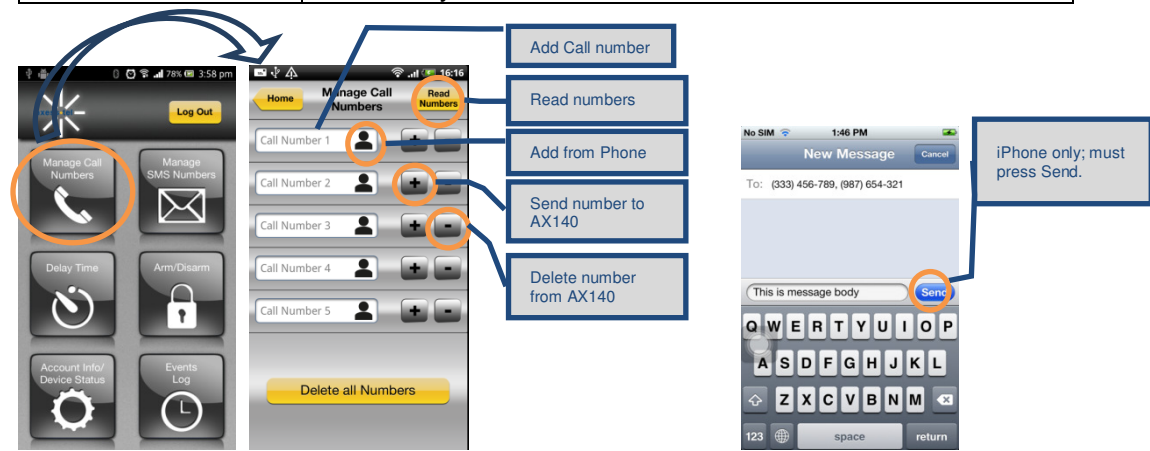

4.5 Manage SMS Numbers (Android/iOS)

Preconditions	<ol style="list-style-type: none"> 1. Phone is powered on 2. The AX140 application has been downloaded 3. The SMS number (of the phone using this App) has already been added in the AX140
---------------	-----------------------------------------------------------------------------------------------------------------------------------------------------------------------------------------------------------------------------

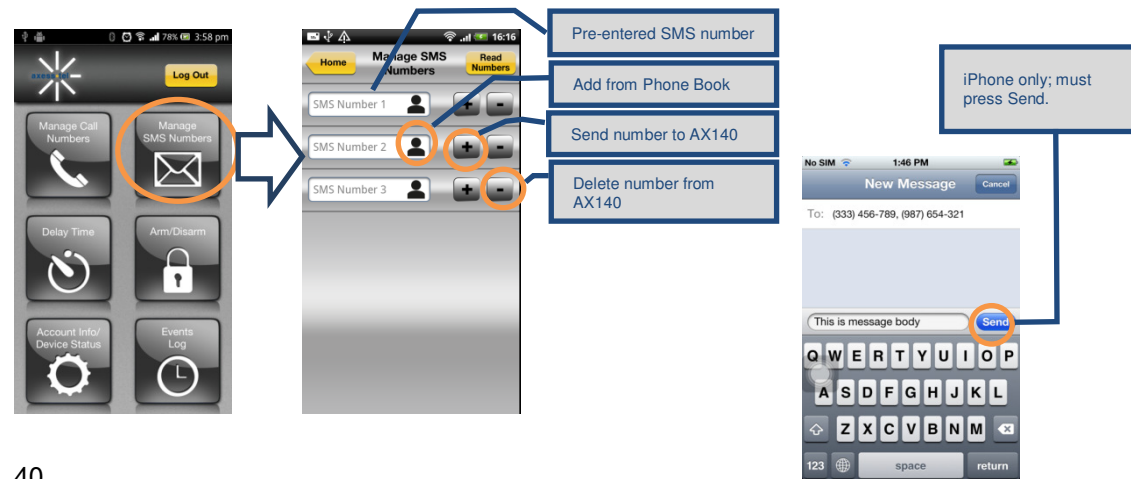

4.6 Delay Time (Entry/Exit)

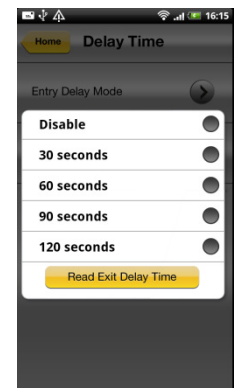
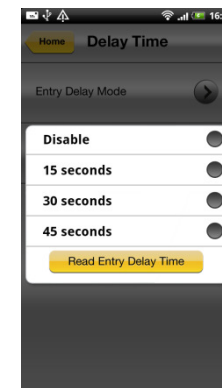
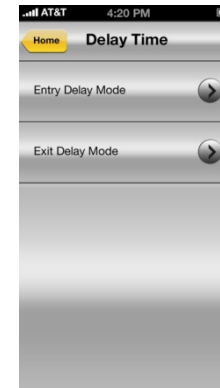
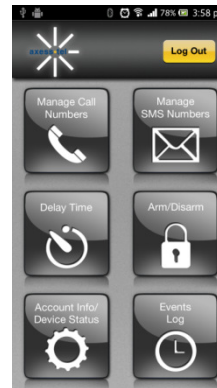



4.7 Remote Arming/Disarming

Preconditions	<ol style="list-style-type: none">1. Phone is powered on2. The AX140 application has been downloaded3. The SMS number (of the phone using this App) has already been added in the AX140
---------------	-------------------------------------------------------------------------------------------------------------------------------------------------------------------------------------------------------------------------

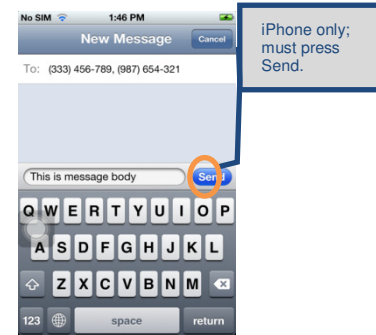

4.8 Account Info/Device Status (Android/iOS)

Preconditions	<ol style="list-style-type: none">4. Phone is powered on5. The AX140 application has been downloaded6. The SMS number (of the phone using this App) has already been added in the AX140
---------------	-------------------------------------------------------------------------------------------------------------------------------------------------------------------------------------------------------------------------

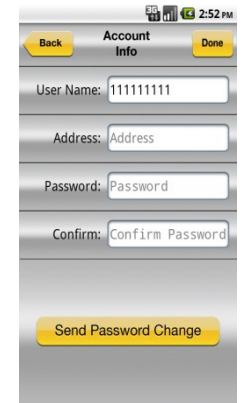
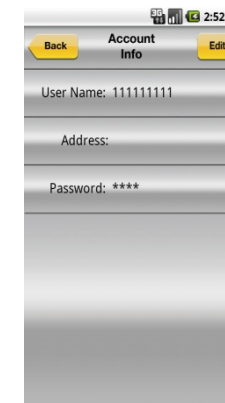
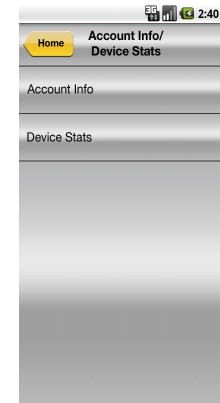
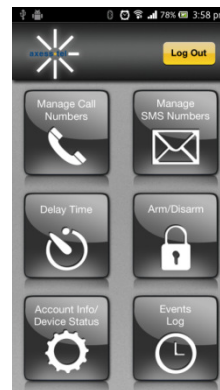

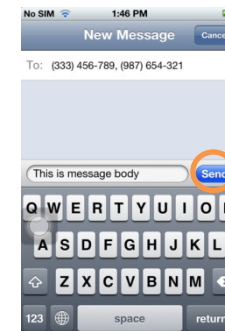
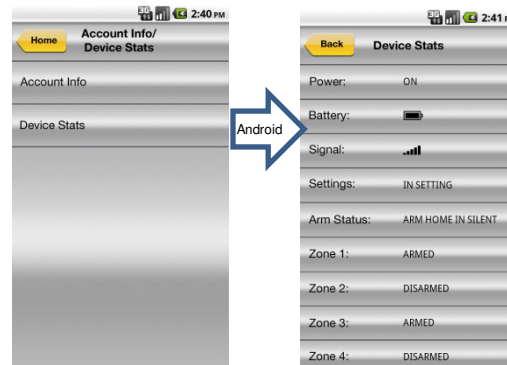

iPhone only; must press Send. Status Displayed in SMS Message box.

4.9 Event Log

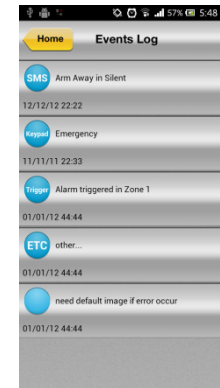
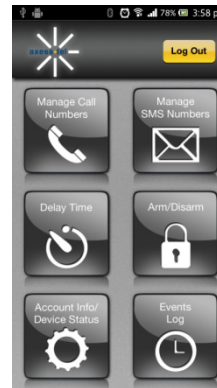

5. Z-Wave

Interoperability with Z-Wave Devices:

Every Z-Wave certified device is designed to work with all other Z-Wave certified devices. The Z-Wave network can integrate devices of various classes, and these devices can be made by different manufacturers. The AX140 is a dedicated controller; since it uses the Basic Command Class, it can provide limited control of other Z-Wave devices using this command class.

Wireless range:

This device has an open air line of sight transmission distance of 100 feet which complies with the Z-Wave standards. Performance can vary depending on the amount of objects between Z-Wave devices such as walls and furniture. Every installed Z-Wave device will act as a signal repeater allowing devices to talk to each other and will find alternate routes/paths, in the case of a reception dead spot.

Radio frequency limitations:

1. Each wall or object (i.e.: refrigerator, bookshelf, large TV, etc) can reduce the maximum range of 65 feet by up to 25 to 30%.

2. Plasterboard and wooden walls block less of the radio signal than concrete, brick or tile walls which will have more of an effect on signal strength.
3. Wall mounted Z-Wave devices will also suffer a loss of range as they are housed in metal junction boxes which could reduce the range by up to 25 to 30%.

Z-Wave basic terminology:

Include /Exclude: Include and exclude are the Z-Wave terms used to describe adding, removing or deleting devices to or from the control network.

Replicate: This is the Z-Wave term for copying or transferring the Z-Wave network data (all devices) to a new controller. This process is also used to update secondary controllers after changes have been made to the control network with the primary controller.

Functional Overview:

This device is based on the Z-Wave Controller Library and works with devices that support the following Z-Wave Device/Command Classes:

Z-Wave device type:

Basic Device Class: BASIC_TYPE_CONTROLLER

Generic Device Class: GENERIC_TYPE_STATIC_CONTROLLER

Specific Device Class: SPECIFIC_TYPE_NOT_USED

Z-Wave Command Class	Controlled	Supported
COMMAND_CLASS_BASIC	NO	YES
COMMAND_CLASS_SENSOR_BINARY	YES	NO
COMMAND_CLASS_VERSION	YES	YES
COMMAND_CLASS_MANUFACTURER_SPECIFIC	YES	YES
COMMAND_CLASS_WAKE_UP	YES	NO
COMMAND_CLASS_ALARM	YES	NO
COMMAND_CLASS_CONTROLLER_REPLICATION	NO	YES

Compatible Devices:

Z-Wave devices may vary; follow the instructions in the *User's Guide* for your specific device when adding and deleting devices into the Z-Wave network. Not all features are supported for off-the-shelf Z-Wave devices.

Basic Z-Wave Functions:

Adding 3rd party vendor Z-Wave device; please refer to the instructions for the Z-Wave device that you are installing.

- Inclusion: Add a Z-Wave enabled device
On AX140 enter the command [*#→password→75 →Func-Key]; on other Z-Wave device [Press switch to enter inclusion mode (see manufactures instructions for device)]
- Exclusion: Remove a Z-Wave enabled device.
On AX140 enter the command [*#→password→70 →Func-Key]; on other Z-Wave device [Press switch to enter inclusion mode (see manufactures instructions for device)]
- Association: After inclusion, define the relationship between devices (primary/secondary), by specifying one as primary to control the other secondary device.
On AX140 enter the command [*#→password→81 →Group ID→Func-Key]; on the other Z-Wave sensor [Click the button in secondary sensor first then in the primary sensor; this will add the primary sensor to secondary sensor association group (see manufactures instructions for device)] If no Group ID is found, user can specify (example "1").

To Remove the Association (primary sensor from secondary sensor):

On AX140 enter the command [*#→password→82→Group ID→Func-Key].

- Manual Association to the AX140 Controller:
On AX140 enter the command [*#→password→83→Group ID→Func-Key]; Click the Z-Wave button on the primary sensor will add it to Controller Association Group.

To Remove the primary sensor Association Group:

On AX140 enter the command [*#→password→84→Group ID→Func-Key]

- Learn Mode: How to make the AX140 become a secondary controller. On AX140 enter the command [*#→password→85 →Func-Key]. Click Z-Wave button on the primary controller.
- Controller Shift: How to go back/shift back to primary controller. On AX140 enter the command [*#→password→86 →Func-Key]. Click Z-Wave button on the secondary controller.

6. Operating Specifications

For 908.42MHz, the Main Unit is only for RX function without TX function, and Motion Sensor (AZ100) is only for TX function without RX function

6.1 Main Unit AX140

<u>Item</u>	<u>Description</u>
CDMA 2000/1XRTT	800/1900 MHz
Alert Panel size(mm) and weight	7.8*4.9*1.5 inches (198*126*38 mm)
	12 ounces (340g)
Antenna	CDMA Dual Band antenna
Z-Wave 908.42MHz	Up to 100 feet line of sight
LED	10
Key	16
SMS number	3 sets phone number
CALL number	5 sets phone number
Zone number	4 zones

Power adapter	5V/2A
Battery	9V
Z-Wave 908.42MHz	
Band Frequency	908.42MHz
RSSI	-102dBm
Operating Temperature	14~122 °F (-10~+50°C)
Storage Temperature	-4~158 °F (-20~+70°C)
Humidity	0% to 95%

6.2 Motion Sensor (AZ100)

AZ100	
Detection mode	Passive infrared signal (PIR)
Dimensions: Size(mm) and Weight	3.3*2.5*1.8 inches (85*65*45 mm) 2.8 ounces (80g)
Antenna	Build in Z-Wave antenna
Transmit distance	Up to 100 feet line of sight
Detection range	23-39.4 ft. (7-12m)
LED	Red & Green
Motion sensitivity adjust	3 level
Tamper switch	Support
Battery	9V
Z-Wave 908.42MHz	
Band Frequency	908.42MHz

RSSI	-102dBm
Working Temperature	32~122 °F (0~+50°C)
Storage Temperature	14~176 °F (-10~+80°C)
Humidity	0% to 95%

7. **Safety Information**

This device complies with Part 15 of the FCC Rules. Its operation is subject to the following two conditions:

- (1) This device may not cause harmful interference, and
- (2) this device must accept any interference received, including interference that may cause undesired operation.

Note: This product has been tested and found to comply with the limits for a Class B digital device, pursuant to Part 15 of the FCC Rules. These limits are designed to provide reasonable protection against harmful interference in a residential installation. This product generates, uses, and can radiate radio frequency energy and, if not installed and used in accordance with

the instructions, may cause harmful interference to radio communications. However, there is no guarantee that interference will not occur in a particular installation. If this product does cause harmful interference to radio or television reception, which can be determined by turning the equipment off and on, the user is encouraged to try to correct the interference by one or more of the following measures:

- Reorient or relocate the receiving antenna.
- Increase the separation between the equipment and receiver.
- Connect the equipment into an outlet on a circuit different from that to which the receiver is connected.
- Consult the dealer or an experienced radio/TV technician for help.