



Test Report No.: RF130726N045-2



FCC TEST REPORT (PART 24)

REPORT NO.: RF130726N045-2
MODEL NO.: AX240
FCC ID: PH7AX240
RECEIVED: Jul. 26, 2013
TESTED: Jul. 26, 2013 ~ Aug. 15, 2013
ISSUED: Aug. 15, 2013

APPLICANT: Axesstel, Inc.

ADDRESS: 6815 Flanders Drive, Suite 210, San Diego, CA92121, USA

ISSUED BY: Bureau Veritas Shenzhen Co., Ltd. Dongguan Branch

LAB ADDRESS: No. 34, Chenwulu Section, Guantai Road, Houjie Town, Dongguan City, Guangdong 523942, China

TEST LOCATION: No. 34, Chenwulu Section, Guantai Road, Houjie Town, Dongguan City, Guangdong 523942, China

This report should not be used by the client to claim product certification, approval, or endorsement by A2LA or any government agencies.

This report is for your exclusive use. Any copying or replication of this report to or for any other person or entity, or use of our name or trademark, is permitted only with our prior written permission. This report sets forth our findings solely with respect to the test samples identified herein. The results set forth in this report are not indicative or representative of the quality or characteristics of the lot from which a test sample was taken or any similar or identical product unless specifically and expressly noted. Our report includes all of the tests requested by you and the results thereof based upon the information that you provided to us. You have 60 days from date of issuance of this report to notify us of any material error or omission caused by our negligence, provided, however, that such notice shall be in writing and shall specifically address the issue you wish to raise. A failure to raise such issue within the prescribed time shall constitute your unqualified acceptance of the completeness of this report, the tests conducted and the correctness of the report contents. Unless specific mention, the uncertainty of measurement has been explicitly taken into account to declare the compliance or non-compliance to the specification.

Bureau Veritas Shenzhen Co., Ltd.
Dongguan Branch

No. 34, Chenwulu Section, Guantai Rd.,
Houjie Town, Dongguan City,
Guangdong 523942, China

Tel: +86 769 8593 5656
Fax: +86 769 8593 1080
Email: customerservice.dg@cn.bureauveritas.com



TABLE OF CONTENTS

RELEASE CONTROL RECORD 4

1 CERTIFICATION..... 5

2 SUMMARY OF TEST RESULTS..... 6

2.1 MEASUREMENT UNCERTAINTY 6

3 GENERAL INFORMATION 8

3.1 GENERAL DESCRIPTION OF EUT 8

3.2 CONFIGURATION OF SYSTEM UNDER TEST 9

3.3 DESCRIPTION OF SUPPORT UNITS..... 9

3.4 TEST ITEM AND TEST CONFIGURATION 9

3.5 EUT OPERATING CONDITIONS..... 11

3.6 GENERAL DESCRIPTION OF APPLIED STANDARDS..... 11

4 TEST TYPES AND RESULTS..... 12

4.1 OUTPUT POWER MEASUREMENT 12

4.1.1 LIMITS OF OUTPUT POWER MEASUREMENT 12

4.1.2 TEST PROCEDURES..... 12

4.1.3 TEST SETUP 13

4.1.4 TEST RESULTS..... 14

4.2 FREQUENCY STABILITY MEASUREMENT 15

4.2.1 LIMITS OF FREQUENCY STABILITY MEASUREMENT 15

4.2.2 TEST PROCEDURE 15

4.2.3 TEST SETUP..... 15

4.2.4 TEST RESULTS..... 16

4.3 OCCUPIED BANDWIDTH MEASUREMENT..... 17

4.3.1 TEST PROCEDURES..... 17

4.3.2 TEST SETUP 17

4.4 BAND EDGE MEASUREMENT 19

4.4.1 LIMITS OF BAND EDGE MEASUREMENT..... 19

4.4.2 TEST SETUP 19

4.4.3 TEST PROCEDURES..... 19

4.4.4 TEST RESULTS..... 20

4.5 CONDUCTED SPURIOUS EMISSIONS..... 21

4.5.1 LIMITS OF CONDUCTED SPURIOUS EMISSIONS MEASUREMENT 21

4.5.2 TEST PROCEDURE 21

4.5.3 TEST SETUP 21

4.6 RADIATED EMISSION MEASUREMENT 23

4.6.1 LIMITS OF RADIATED EMISSION MEASUREMENT 23

4.6.2 TEST PROCEDURES..... 23

4.6.3 DEVIATION FROM TEST STANDARD 23



4.6.4	TEST SETUP	24
4.6.5	TEST RESULTS.....	25
4.7	PEAK TO AVERAGE RATIO	26
4.7.1	LIMITS OF PEAK TO AVERAGE RATIO MEASUREMENT	26
4.7.2	TEST SETUP	26
4.7.3	TEST PROCEDURES.....	26
4.7.4	TEST RESULTS.....	27
5	PHOTOGRAPHS OF THE TEST CONFIGURATION	28
6	INFORMATION ON THE TESTING LABORATORIES.....	29
7	APPENDIX A – MODIFICATIONS RECORDERS FOR ENGINEERING CHANGES TO THE EUT BY THE LAB.....	30



**BUREAU
VERITAS**

Test Report No.: RF130726N045-2

RELEASE CONTROL RECORD

ISSUE NO.	REASON FOR CHANGE	DATE ISSUED
RF130726N045-2	Original release	Aug. 15, 2013



1 CERTIFICATION

PRODUCT: CDMA Fixed Wireless Terminal With Smart Security Alert
MODEL: AX240
BRAND: Axesstel
APPLICANT: Axesstel, Inc.
TESTED: Jul. 26, 2013 ~ Aug. 15, 2013
TEST SAMPLE: Production Unit
STANDARDS: **FCC Part 24, Subpart E**

The above equipment (model: AX240) has been tested by **Bureau Veritas Shenzhen Co., Ltd. Dongguan Branch**, and found compliance with the requirement of the above standards. The test record, data evaluation & Equipment Under Test (EUT) configurations represented herein are true and accurate accounts of the measurements of the sample's EMC characteristics under the conditions specified in this report.

TESTED BY :  , **DATE** : Aug. 15, 2013
Glyn He/ Project Engineer

APPROVED BY :  , **DATE** : Aug. 15, 2013
Sam Tung / Technical Manager



2 SUMMARY OF TEST RESULTS

The EUT has been tested according to the following specifications:

APPLIED STANDARD: FCC Part 24 & Part 2			
STANDARD SECTION	TEST TYPE	RESULT	REMARK
2.1046 24.232	Equivalent Isotropic Radiated Power	PASS	Meet the requirement of limit.
2.1055 24.235	Frequency Stability	PASS	Meet the requirement of limit.
2.1049 24.238(b)	Occupied Bandwidth	PASS	Meet the requirement of limit.
24.238(b)	Band Edge Measurements	PASS	Meet the requirement of limit.
2.1051 24.238	Conducted Spurious Emissions	PASS	Meet the requirement of limit.
2.1053 24.238	Radiated Spurious Emissions	PASS	Meet the requirement of limit.

2.1 MEASUREMENT UNCERTAINTY

Where relevant, the following measurement uncertainty levels have been estimated for tests performed on the EUT as specified in CISPR 16-4-2:

MEASUREMENT	FREQUENCY	UNCERTAINTY
Conducted emissions	9kHz~30MHz	2.67dB
Radiated emissions	30MHz ~ 1GHz	4.81dB
	1GHz ~ 18GHz	4.3dB
	18GHz ~ 40GHz	1.94dB

This uncertainty represents an expanded uncertainty expressed at approximately the 95% confidence level using a coverage factor of k=2.



2.2 TEST SITE AND INSTRUMENTS

Equipment	Manufacturer	Model No.	Serial No.	Last Cal.	Next Cal.
Spectrum Analyzer	Agilent	E4446A	MY46180622	Apr. 24,13	Apr. 23,14
EMI Test Receiver	Rohde&Schwarz	ESVD	847398/003	May 14,13	May 13,14
Bilog Antenna (25MHz-2GHz)	Teseq	CBL 6111D	27089	Nov. 22,12	Nov. 21,13
Bilog Antenna	Teseq	CBL 6111D	25757	Nov. 22,12	Nov. 21,13
Horn Antenna (1GHz -18GHz)	EMCO	3117	00062558	Oct.18,12	Oct.17,13
Pre-Amplifier (20MHz-3GHz)	EMCI	EMC 330	980095	Nov. 02,12	Nov.01,13
Pre-Amplifier (100MHz-26.5GHz)	Agilent	8449B	3008A00409	May 14,13	May 13,14
10m Semi-anechoic Chamber	CHANGLING	21.4m*12.1m*8 .8m	NSEMC006	Mar. 24,13	Mar. 23,14
Digital Multimeter	FLUKE	15B	A1220010D G	Oct. 31,12	Oct. 30,13
Test Software	ADT	ADT_Radiated _V7.6.15	N/A	N/A	N/A

- NOTE:**
1. The calibration interval of the above test instruments is 12 months and the calibrations are traceable to CEPREI/CHINA and NIM/CHINA.
 2. The test was performed in Chamber 10m.
 3. The horn antenna are used only for the measurement of emission frequency above 1GHz if tested.
 4. The FCC Site Registration No. is 502831.



3 GENERAL INFORMATION

3.1 GENERAL DESCRIPTION OF EUT

PRODUCT	CDMA Fixed Wireless Terminal With Smart Security Alert
MODEL NO.	AX240
POWER SUPPLY	DC 3.7V from battery or DC 5V from adapter
MODULATION TYPE	CDMA: QPSK, OQPSK, HPSK
FREQUENCY RANGE	CDMA: 1851.25MHz ~ 1908.75MHz
MAX. EIRP POWER	0.27 Watts
ANTENNA TYPE	external antenna with 3 dBi gain
I/O PORTS	Refer to user's manual
CABLE SUPPLIED	N/A
ACCESSORY DEVICES	Adapter

NOTE:

1. CDMA technology is used for the EUT.
2. The EUT was powered by the following adapters:

ADAPTER 1	
BRAND:	STH
MODEL:	P6050100 US
INPUT:	AC 100-240V,50/60Hz,0.2A
OUTPUT:	DC 5V, 1000mA
DC Line:	Unshielded,Undetachable,1.8M

ADAPTER 2	
BRAND:	STH
MODEL:	TA31-0502000
INPUT:	AC 100-240V,50/60Hz,0.4A
OUTPUT:	DC 5V, 2000mA
DC Line:	Unshielded,Undetachable,1.8M

3. The above EUT information was declared by manufacturer and for more detailed feature description, please refer to the manufacturer's specifications or user's manual.



3.2 CONFIGURATION OF SYSTEM UNDER TEST FOR RADIATION EMISSION TEST

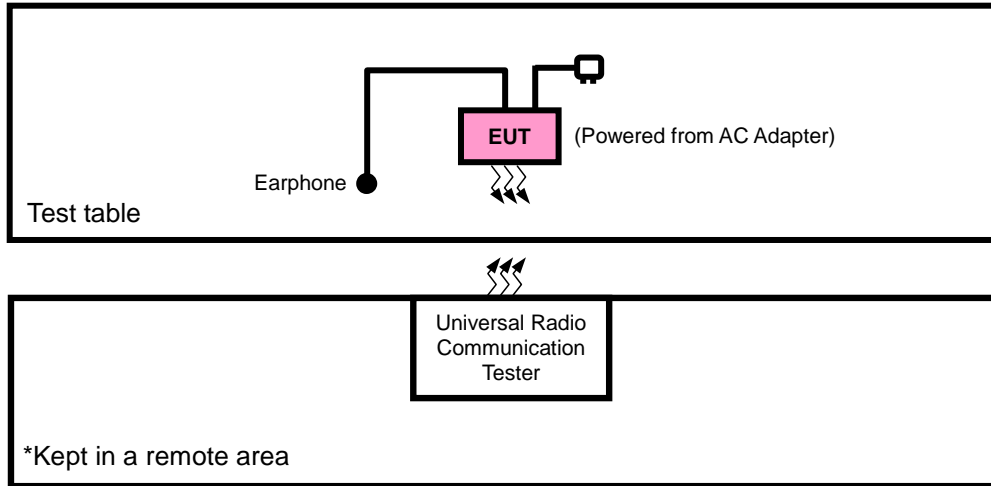

3.3 DESCRIPTION OF SUPPORT UNITS

The EUT has been tested as an independent unit together with other necessary accessories or support units. The following support units or accessories were used to form a representative test configuration during the tests.

NO.	PRODUCT	BRAND	MODEL NO.	SERIAL NO.	FCC ID
1	Universal Radio Communication Tester	R&S	CMU200	123259	N/A
2	Telephone	CHINO-E	HCD6138(20) P	N/A	N/A
3	Telephone	MSQ	HCD2968	N/A	N/A

NO.	SIGNAL CABLE DESCRIPTION OF THE ABOVE SUPPORT UNITS
1	AC cable: Unshielded, Detachable, 1.8M
2	RJ11 cable: Unshielded, Detachable, 1M
3	RJ11 cable: Unshielded, Detachable, 1M



3.4 TEST ITEM AND TEST CONFIGURATION

Following mode and channels were selected for the final test as listed below:

EUT CONFIGURE MODE	DESCRIPTION
A	CDMA link

CDMA MODE

EUT CONFIGURE MODE	TEST ITEM	AVAILABLE CHANNEL	TESTED CHANNEL	MODE
A	EIRP	25 to 1175	25, 600, 1175	RC3+SO32(+ F-SCH)
A	FREQUENCY STABILITY	25 to 1175	600	RC3+SO32(+ F-SCH)
A	OCCUPIED BANDWIDTH	25 to 1175	25, 600, 1175	RC3+SO32(+ F-SCH)
A	BAND EDGE	25 to 1175	25, 1175	RC3+SO32(+ F-SCH)
A	CONDCUDED EMISSION	25 to 1175	600	RC3+SO32(+ F-SCH)
A	RADIATED EMISSION	25 to 1175	600	RC3+SO32(+ F-SCH)

TEST CONDITION:

TEST ITEM	ENVIRONMENTAL CONDITIONS	INPUT POWER	TESTED BY
ERP	25deg. C, 60%RH	5Vdc from adapter	Venless Long
FREQUENCY STABILITY	25deg. C, 60%RH	5Vdc from adapter	Venless Long
OCCUPIED BANDWIDTH	25deg. C, 60%RH	5Vdc from adapter	Venless Long
BAND EDGE	25deg. C, 60%RH	5Vdc from adapter	Venless Long
CONDCUDED EMISSION	25deg. C, 60%RH	5Vdc from adapter	Venless Long
RADIATED EMISSION	24deg. C, 56%RH	5Vdc from adapter	Venless Long



3.5 EUT OPERATING CONDITIONS

The EUT makes a call to the communication simulator. The communication simulator station system controlled a EUT to export maximum output power under transmission mode and specific channel frequency

3.6 GENERAL DESCRIPTION OF APPLIED STANDARDS

The EUT is a RF product. According to the specifications of the manufacturer, it must comply with the requirements of the following standards:

FCC 47 CFR Part 2

FCC 47 CFR Part 24

ANSI/TIA/EIA-603-C 2004

NOTE: All test items have been performed and recorded as per the above standards.

4 TEST TYPES AND RESULTS

4.1 OUTPUT POWER MEASUREMENT

4.1.1 LIMITS OF OUTPUT POWER MEASUREMENT

Mobile and portable stations are limited to 2 watts EIRP

4.1.2 TEST PROCEDURES

EIRP MEASUREMENT:

- a. All measurements were done at low, middle and high operational frequency range. RBW and VBW is 5MHz for CDMA mode.
- b. Substitution method is used for E.I.R.P measurement. In the semi-anechoic chamber, EUT placed on the 0.8m height of Turn Table, rotated the table around 360 degrees to search the maximum radiation power and receiver antenna shall be rotated vertical and horizontal polarization and moved height from 1m to 4m to find the maximum polar radiated power. The “Read Value” is the spectrum reading the maximum power value.
- c. The substitution horn antenna is substituted for EUT at the same position and signals generator export the CW signal to the substitution antenna via a tx cable. Rotated the Turn Table and moved receiving antenna to find the maximum radiation power. Adjust output power level of S.G to get a Value of spectrum reading equal to “Read Value “ of step b. Record the power level of S.G
- d. $EIRP = \text{Output power level of S.G} - \text{TX cable loss} + \text{Antenna gain of substitution horn.}$

CONDUCTED POWER MEASUREMENT:

The EUT was set up for the maximum power with CDMA link data modulation and link up with simulator. Set the EUT to transmit under low, middle and high channel and record the power level shown on simulator.



4.1.3 TEST SETUP

EIRP MEASUREMENT:

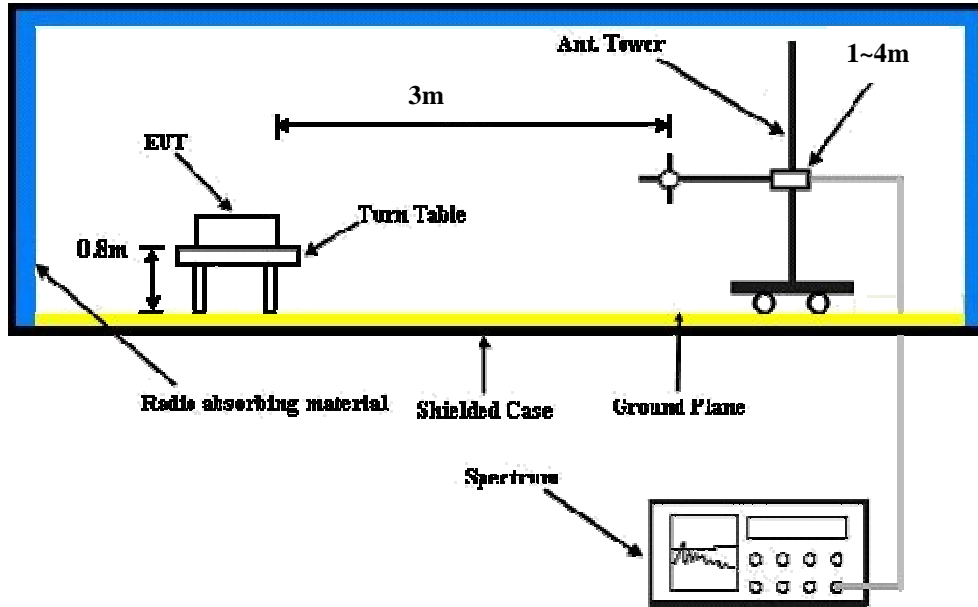

For the actual test configuration, please refer to the attached file (Test Setup Photo).

CONDUCTED POWER MEASUREMENT:

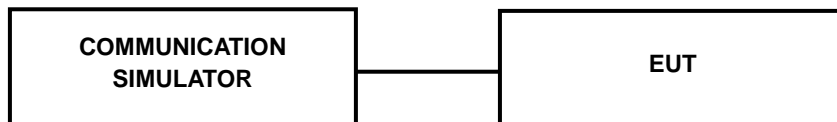

For the actual test configuration, please refer to the attached file (Test Setup Photo).



4.1.4 TEST RESULTS

CONDUCTED OUTPUT POWER (dBm)

Band	CDMA2000 BC0		
Channel	25	600	1175
Frequency (MHz)	1851.25	1880	1908.75
RC1+SO55	24.34	24.01	23.77
RC3+SO55	24.41	24.13	23.92
RC3+SO32(+ F-SCH)	24.38	24.09	23.89
RC3+SO32(+SCH)	24.31	24.08	23.86
RTAP 153.6	24.40	24.15	24.21
RETAP 4096	24.26	24.21	24.14

EIRP POWER (dBm)

FOR 1xRTT RC3+SO32(+ F-SCH) MODE

Channel	Frequency (MHz)	LVL (dBm)	Correction Factor(dB)	EIRP(dBm)	EIRP(W)	Polarization (H/V)
25	1851.25	-25.55	44.03	18.48	0.07	H
600	1880	-25.80	44.37	18.57	0.07	H
1175	1908.75	-26.14	43.25	17.11	0.05	H
25	1851.25	-22.14	46.45	24.31	0.27	V
600	1880	-22.45	45.72	23.27	0.21	V
1175	1908.75	-23.15	45.03	21.88	0.15	V

- REMARKS:** 1. EIRP Output Power (dBm) = SPA Reading (dBm) + Correction Factor (dB).
 2. Correction factor (dB) = Free Space Loss + Antenna Factor + Cable Loss

4.2 FREQUENCY STABILITY MEASUREMENT

4.2.1 LIMITS OF FREQUENCY STABILITY MEASUREMENT

The frequency stability shall be sufficient to ensure that the fundamental emission stays within the authorized frequency block.

4.2.2 TEST PROCEDURE

- Device is placed at the oven room. The oven room could control the temperatures and humidity. Power warm up is at least 15 min and power applied should perform before recording frequency error.
- EUT is connected the external power supply to control the DC input power. The test voltage range is from minimum to maximum working voltage. Each step shall be record the frequency error rate.
- The temperature range step is 10 degrees in this test items. All temperature levels shall be hold the $\pm 0.5^{\circ}\text{C}$ during the measurement testing. The each temperature step shall be at least 0.5 hours, consider the EUT could be test under the stability condition.

NOTE: The frequency error was recorded frequency error from the communication simulator.

4.2.3 TEST SETUP

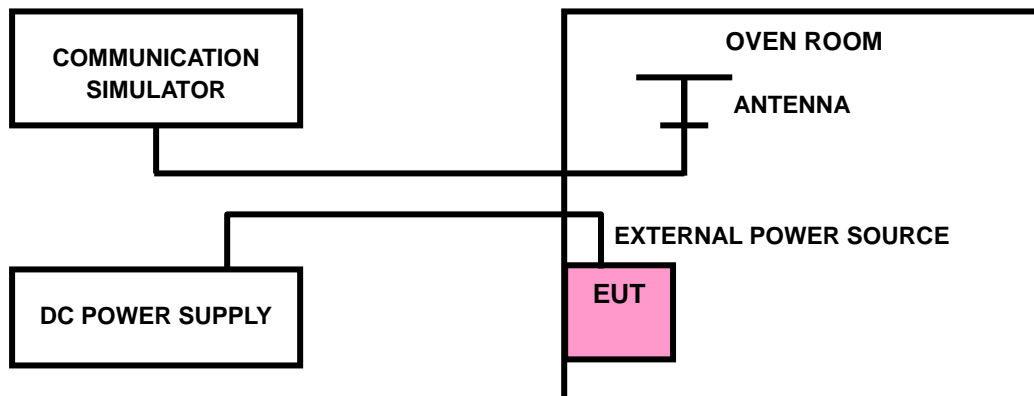



4.2.4 TEST RESULTS

1xRTT RC3+SO32(+ F-SCH) MODE

FREQUENCY ERROR VS. VOLTAGE

VOLTAGE (Volts)	FREQUENCY ERROR (ppm)	LIMIT (ppm)
4.2	-0.0017	2.5
3.7	-0.0019	2.5
3.4	-0.0016	2.5

NOTE: The applicant defined the normal working voltage of the battery is from 3.4Vdc to 4.2Vdc.

FREQUENCY ERROR vs. TEMPERATURE.

TEMP. (°C)	FREQUENCY ERROR (ppm)	LIMIT (ppm)
-20	-0.0015	2.5
-10	-0.0014	2.5
0	-0.0018	2.5
10	-0.0017	2.5
20	-0.0019	2.5
30	-0.0012	2.5
40	-0.0018	2.5
50	-0.0016	2.5
55	-0.0013	2.5

4.3 OCCUPIED BANDWIDTH MEASUREMENT

4.3.1 TEST PROCEDURES

The EUT makes a call to the communication simulator. All measurements were done at low, middle and high operational frequency range. The communication simulator station system controlled a EUT to export maximum output power under transmission mode and specific channel frequency. Use OBW measurement function of Spectrum analyzer to measure 99 % occupied bandwidth.

4.3.2 TEST SETUP

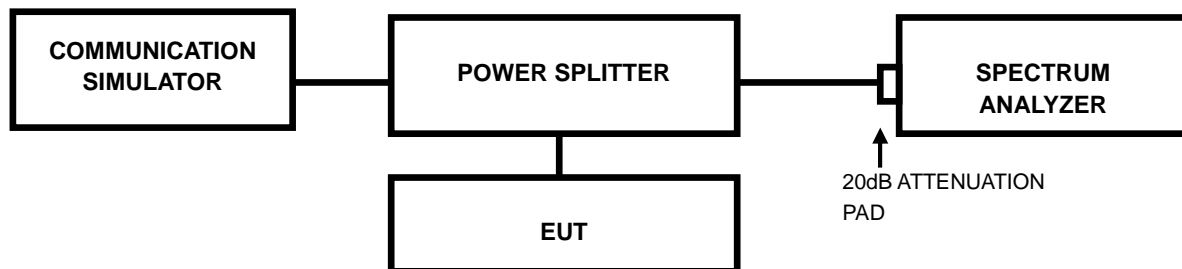



4.3.3 TEST RESULTS

1xRTT RC3+SO32(+ F-SCH) MODE

CHANNEL	FREQUENCY (MHz)	99% OCCUPIED BANDWIDTH (MHz)
25	1851.25	1.28
600	1880	1.27
1175	1908.75	1.27

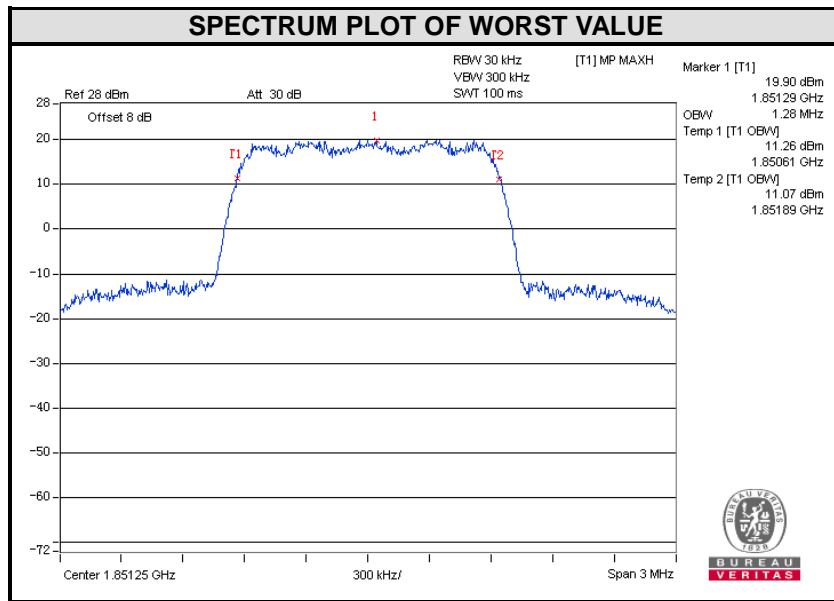

4.4 BAND EDGE MEASUREMENT

4.4.1 LIMITS OF BAND EDGE MEASUREMENT

Power of any emission outside of the authorized operating frequency ranges must be attenuated below the transmitting power (P) by a factor of at least $43 + 10 \log(P)$ dB. In the 1 MHz bands immediately outside and adjacent to the frequency block a resolution bandwidth of at least one percent of the emission bandwidth of the fundamental emission of the transmitter may be employed.

4.4.2 TEST SETUP

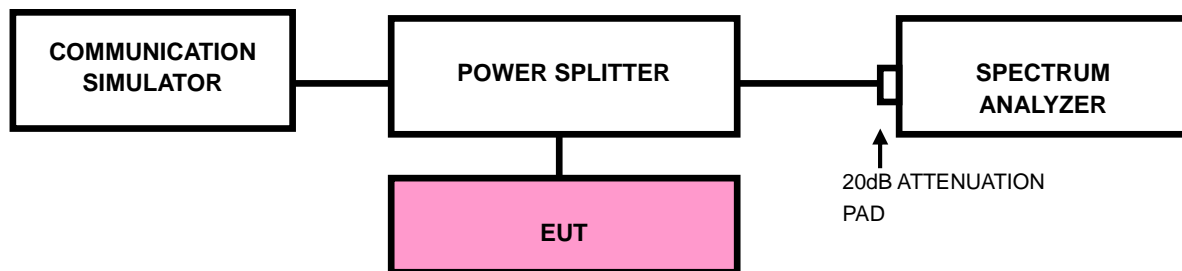

4.4.3 TEST PROCEDURES

- All measurements were done at low and high operational frequency range.
- The center frequency of spectrum is the band edge frequency and span is 2 MHz. RB of the spectrum is 13kHz and VB of the spectrum is 51kHz.
- Record the max trace plot into the test report.



4.4.4 TEST RESULTS

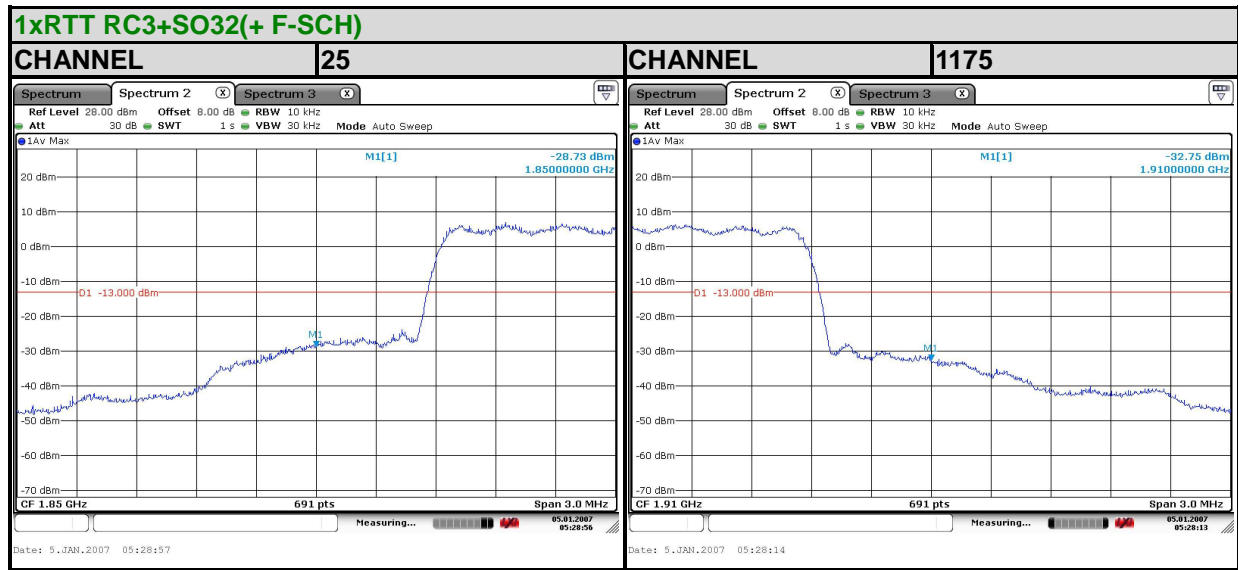



4.5 CONDUCTED SPURIOUS EMISSIONS

4.5.1 LIMITS OF CONDUCTED SPURIOUS EMISSIONS MEASUREMENT

The power of any emission outside of the authorized operating frequency ranges must be attenuated below the transmitting power (P) by a factor of at least $43 + 10 \log(P)$ dB. The emission limit equal to -13dBm .

4.5.2 TEST PROCEDURE

- The EUT makes a phone call to the communication simulator. All measurements were done at low, middle and high operational frequency range.
- Measuring frequency range is from 9 kHz to 19.1GHz. 20dB attenuation pad is connected with spectrum. RBW=1MHz and VBW=3MHz is used for conducted emission measurement.

4.5.3 TEST SETUP

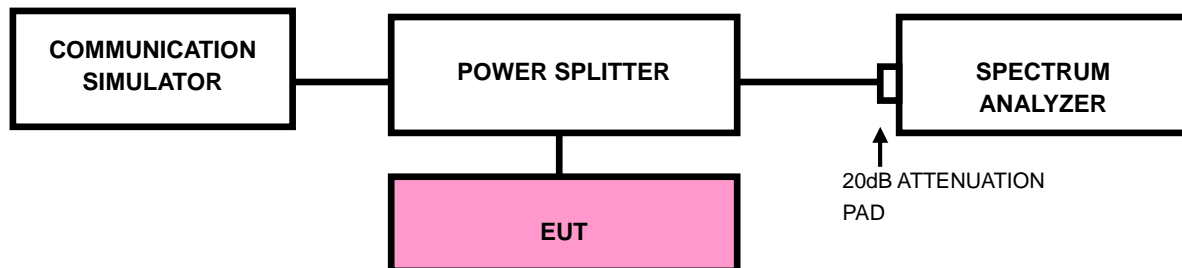



BUREAU VERITAS

Test Report No.: RF130726N045-2

4.5.4 TEST RESULTS

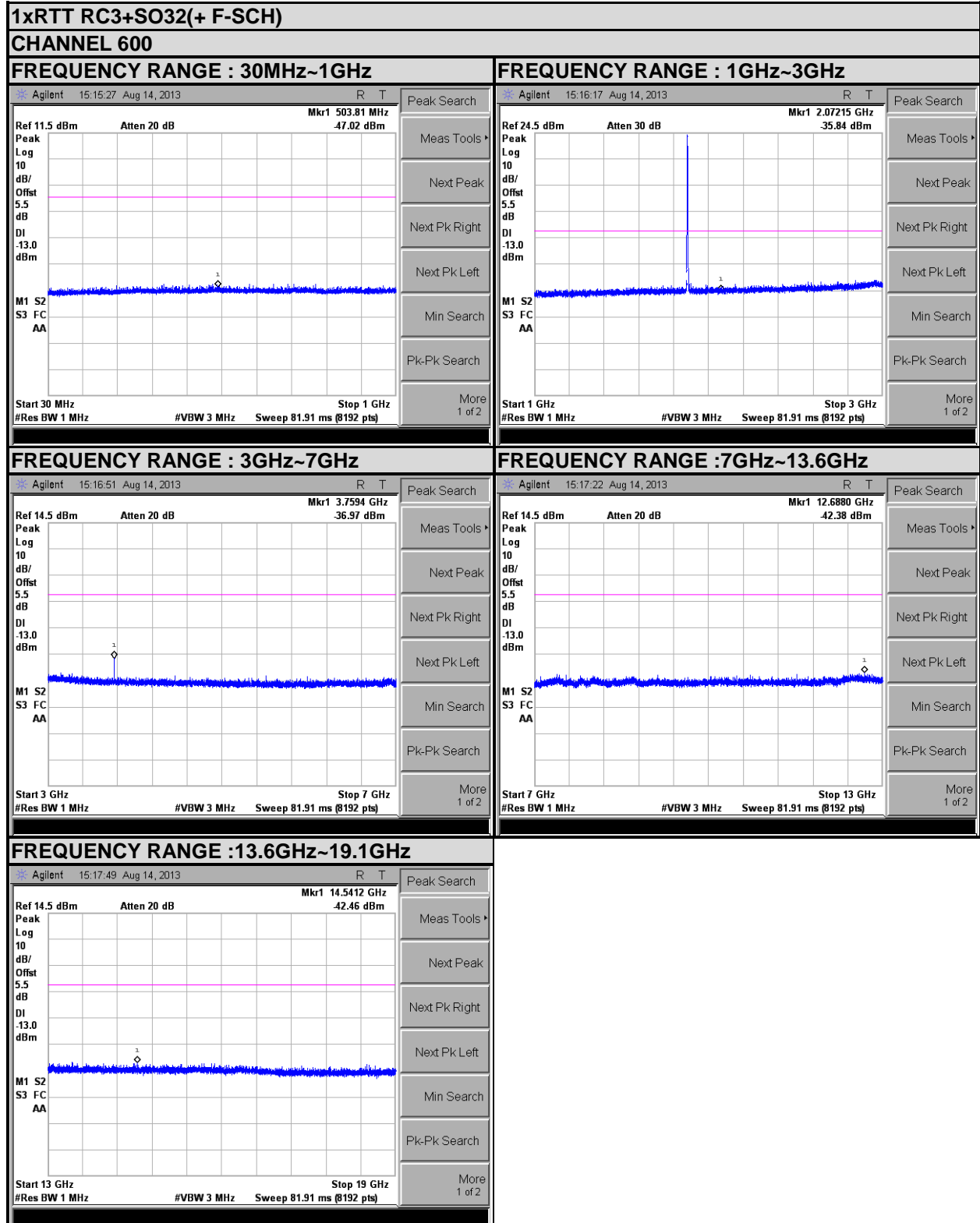

Bureau Veritas Shenzhen Co., Ltd.
Dongguan Branch

No. 34, Chenwulu Section, Guantai Rd.,
Houjie Town, Dongguan City,
Guangdong 523942, China

Tel: +86 769 8593 5656
Fax: +86 769 8593 1080
Email: customerservice.dg@cn.bureauveritas.com



4.6 RADIATED EMISSION MEASUREMENT

4.6.1 LIMITS OF RADIATED EMISSION MEASUREMENT

The power of any emission outside of the authorized operating frequency ranges must be attenuated below the transmitting power (P) by a factor of at least $43 + 10 \log(P)$ dB. The emission limit equal to -13dBm .

4.6.2 TEST PROCEDURES

- a. Substitution method is used for E.I.R.P measurement. In the semi-anechoic chamber, EUT placed on the 0.8m height of Turn Table, rotated the table around 360 degrees to search the maximum radiation power and receiver antenna shall be rotated vertical and horizontal polarization and moved height from 1m to 4m to find the maximum polar radiated power. The “Read Value” is the spectrum reading the maximum power value.
- b. The substitution horn antenna is substituted for EUT at the same position and signals generator export the CW signal to the substitution antenna via a TX cable. Rotated the Turn Table and moved receiving antenna to find the maximum radiation power. Adjust output power level of S.G to get a Value of spectrum reading equal to “Read Value “ of step a. Record the power level of S.G
- c. $\text{EIRP} = \text{Output power level of S.G} - \text{TX cable loss} + \text{Antenna gain of substitution horn.}$

NOTE: The resolution bandwidth and video bandwidth of test receiver/spectrum analyzer is 1MHz/3MHz.

4.6.3 DEVIATION FROM TEST STANDARD

No deviation



4.6.4 TEST SETUP

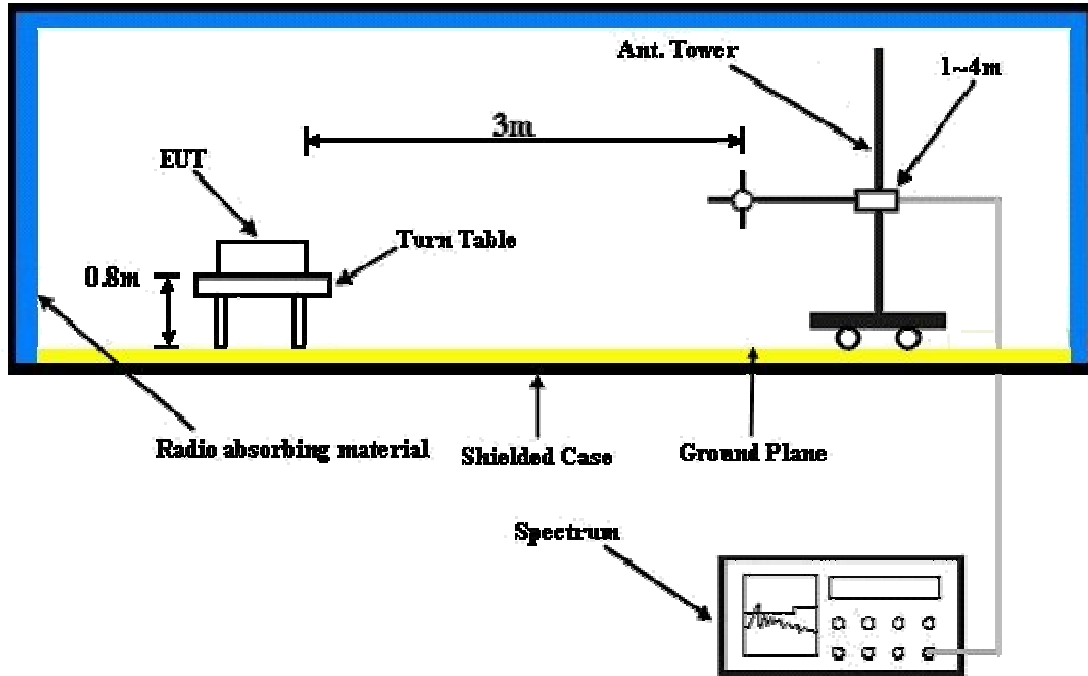

For the actual test configuration, please refer to the attached file (Test Setup Photo).



4.6.5 TEST RESULTS

1xRTT RC3+SO32(+ F-SCH)

FREQUENCY RANGE	Above 1000MHz	INPUT POWER	120Vac, 60 Hz
ENVIRONMENTAL CONDITIONS	24deg. C, 56%RH	TESTED BY	Venless Long

ANTENNA POLARITY & TEST DISTANCE: HORIZONTAL AT 3 M						
No.	Freq. (MHz)	SPA READING (dBm)	Limit (dBm)	S.G Power Value (dBm)	Correction Factor (dB)	EIRP (dBm)
1	3760	-51.32	-13	-38.89	4.07	-34.82
2	5640	-53.84	-13	-37.10	4.81	-32.29
ANTENNA POLARITY & TEST DISTANCE: VERTICAL AT 3 M						
No.	Freq. (MHz)	SPA READING (dBm)	Limit (dBm)	S.G Power Value (dBm)	Correction Factor (dB)	EIRP (dBm)
1	3760	-53.7	-13	-40.62	4.07	-36.55
2	5640	-55.46	-13	-40.32	4.81	-35.51

REMARKS:

1. EIRP(dBm) = S.G Power Value (dBm) + Correction Factor (dB).
2. Correction Factor (dB) = Substitution Antenna Gain (dB) + Cable Loss (dB)



4.7 PEAK TO AVERAGE RATIO

4.7.1 LIMITS OF PEAK TO AVERAGE RATIO MEASUREMENT

In measuring transmissions in this band using an average power technique, the peak to-average ratio (PAR) of the transmission may not exceed 13 dB.

4.7.2 TEST SETUP

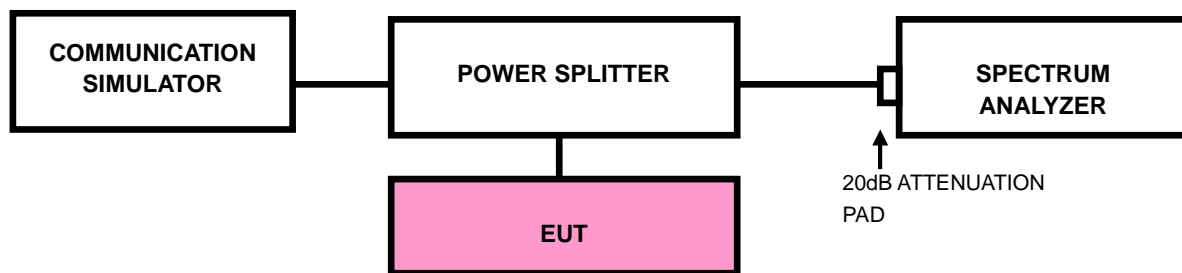

4.7.3 TEST PROCEDURES

1. Set resolution/measurement bandwidth \geq signal's occupied bandwidth;
2. Set the number of counts to a value that stabilizes the measured CCDF curve;
3. Record the maximum PAPR level associated with a probability of 0.1%.



4.7.4 TEST RESULTS

1xRTT RC3+SO32(+ F-SCH) MODE

CHANNEL	FREQUENCY (MHz)	PEAK TO AVERAGE RATIO (dB)
1175	1908	8.61

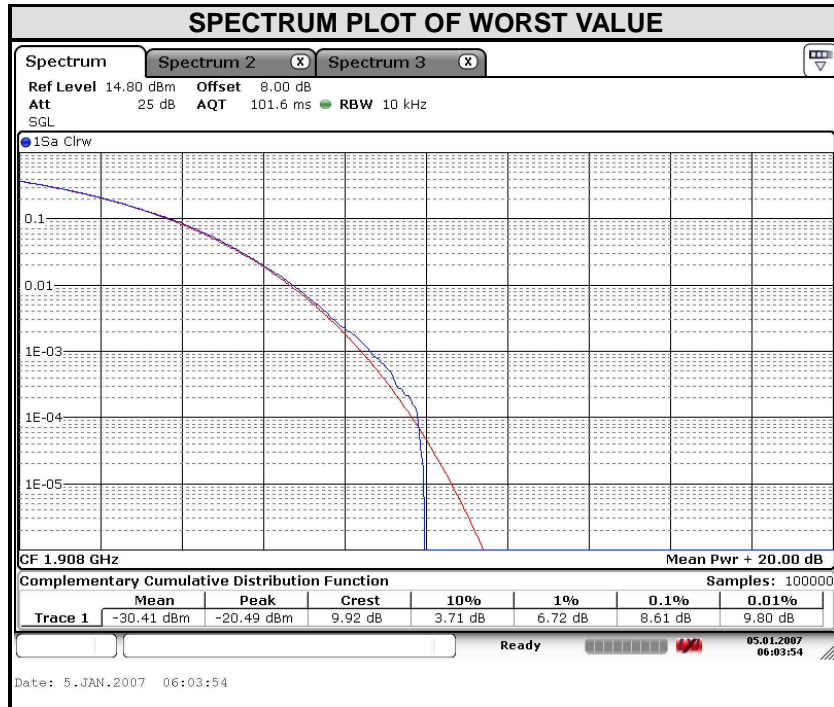



**BUREAU
VERITAS**

Test Report No.: RF130726N045-2

5 PHOTOGRAPHS OF THE TEST CONFIGURATION

Please refer to the attached file (Test Setup Photo).



**BUREAU
VERITAS**

Test Report No.: RF130726N045-2

6 INFORMATION ON THE TESTING LABORATORIES

We, Bureau Veritas Shenzhen Co., Ltd. Dongguan Branch, were founded in 2002 to provide our best service in EMC, Radio, Telecom and Safety consultation. Our laboratories are accredited and approved according to ISO/IEC 17025.

If you have any comments, please feel free to contact us at the following:

Dongguan EMC/RF Lab:

Tel: +86-769-85935656

Fax: +86-769-85931080

Email: customerservice.dg@cn.bureauveritas.com

Web Site: www.adt.com.tw

The address and road map of all our labs can be found in our web site also.



**BUREAU
VERITAS**

Test Report No.: RF130726N045-2

7 APPENDIX A – MODIFICATIONS RECORDERS FOR ENGINEERING CHANGES TO THE EUT BY THE LAB

No any modifications are made to the EUT by the lab during the test.

---END---