

SAR Test Report

Report No.: AGC01284180603FH01

FCC ID : PH3DJ-MD5

PRODUCT DESIGNATION : VHF/UHF DUAL BAND TRANSCEIVER

BRAND NAME : ALINCO

MODEL NAME : DJ-MD5, DJ-MD5T, DJ-MD5TGP

CLIENT : Alinco Incorporated, Electronics Division

DATE OF ISSUE : Aug. 13,2018

STANDARD(S) : IEEE Std. 1528:2013
FCC 47CFR § 2.1093
IEEE/ANSI C95.1:2005

REPORT VERSION : V1.1

Attestation of Global Compliance(Shenzhen) Co., Ltd.

CAUTION:

This report shall not be reproduced except in full without the written permission of the test laboratory and shall not be quoted out of context.



The results shown in this test report refer only to the sample(s) tested unless otherwise stated and the sample(s) are retained for 30 days only. The document is issued by AGC, this document cannot be reproduced except in full with our prior written permission. The more details and the authenticity of the report will be confirmed at <http://www.agc-cert.com>.

Report Revise Record

Report Version	Revise Time	Issued Date	Valid Version	Notes
V1.0	/	July 25,2018	Invalid	Initial Release
V1.1	1st	Aug. 13,2018	Valid	Update the calibration date of DAE

The results shown in this test report refer only to the sample(s) tested unless otherwise stated and the sample(s) are retained for 30 days only. The document is issued by AGC, this document cannot be reproduced except in full with our prior written permission. The more details and the authenticity of the report will be confirmed at <http://www.agc-cert.com>.

Test Report Certification

Applicant Name	Alinco Incorporated, Electronics Division
Applicant Address	Yodoyabashi Dai-Bldg 13F, 4-4-9 Koraibashi, Chuo-Ku, Osaka 541-0043, Japan
Manufacturer Name	Alinco Incorporated, Electronics Division
Manufacturer Address	Yodoyabashi Dai-Bldg 13F, 4-4-9 Koraibashi, Chuo-Ku, Osaka 541-0043, Japan
Product Designation	VHF/UHF DUAL BAND TRANSCEIVER
Brand Name	ALINCO
Model Name	DJ-MD5, DJ-MD5T, DJ-MD5TGP
Different Description	All the same, except for the model name. The test name is DJ-MD5.
EUT Voltage	DC7.4 V
Applicable Standard	IEEE Std. 1528:2013 FCC 47CFR § 2.1093 IEEE/ANSI C95.1:2005
Test Date	July 04, 2018 to July 07,2018
Report Template	AGCRT- US -PTT/SAR (2018-02-02)

Note: The results of testing in this report apply to the product/system which was tested only.

Owen Xiao

Tested By _____

Qwen Xiao(Xiao Qi)

July 07,2018

Angela Li

Checked By _____

Angela Li(Li Jiao)

Aug. 13,2018

Forrest Lei

Authorized By _____

Forrest Lei(Lei Yonggang)

Aug. 13,2018

Authorized Officer

The results shown in this test report refer only to the sample(s) tested unless otherwise stated and the sample(s) are retained for 30 days only. The document is issued by AGC, this document cannot be reproduced except in full with our prior written permission. The more details and the authenticity of the report will be confirmed at <http://www.agc-cert.com>.

TABLE OF CONTENTS

1. SUMMARY OF MAXIMUM SAR VALUE 5

2. GENERAL INFORMATION..... 6

 2.1. EUT DESCRIPTION..... 6

3. SAR MEASUREMENT SYSTEM..... 7

 3.1. THE DASY5 SYSTEM USED FOR PERFORMING COMPLIANCE TESTS CONSISTS OF FOLLOWING ITEMS 7

 3.2. DASY5 E-FIELD PROBE..... 8

 3.3. DATA ACQUISITION ELECTRONICS DESCRIPTION 8

 3.4. ROBOT..... 9

 3.5. LIGHT BEAM UNIT 9

 3.6. DEVICE HOLDER..... 10

 3.7. MEASUREMENT SERVER..... 10

 3.8. PHANTOM..... 11

4. SAR MEASUREMENT PROCEDURE 12

 4.1. SPECIFIC ABSORPTION RATE (SAR)..... 12

 4.2. SAR MEASUREMENT PROCEDURE 13

5. TISSUE SIMULATING LIQUID 15

 5.1. THE COMPOSITION OF THE TISSUE SIMULATING LIQUID..... 15

 5.2. TISSUE DIELECTRIC PARAMETERS FOR HEAD AND BODY PHANTOMS 15

 5.3. TISSUE CALIBRATION RESULT 16

6. SAR SYSTEM CHECK PROCEDURE 18

 6.1. SAR SYSTEM CHECK PROCEDURES 18

 6.2. SAR SYSTEM CHECK..... 19

7. EUT TEST POSITION..... 20

 7.1. BODY WORN POSITION 20

8. SAR EXPOSURE LIMITS 21

9. TEST FACILITY 22

10. TEST EQUIPMENT LIST 23

11. MEASUREMENT UNCERTAINTY 24

12. POWER MEASUREMENT 28

13. TEST RESULTS 34

 13.1. SAR TEST RESULTS SUMMARY 34

APPENDIX A. SAR SYSTEM CHECK DATA 38

APPENDIX B. SAR MEASUREMENT DATA..... 42

APPENDIX C. TEST SETUP PHOTOGRAPHS..... 52

APPENDIX D. CALIBRATION DATA 54

The results shown in this test report refer only to the sample(s) tested unless otherwise stated and the sample(s) are retained for 30 days only. The document is issued by AGC, this document cannot be reproduced except in full with our prior written permission. The more details and the authenticity of the report will be confirmed at <http://www.agc-cert.com>.

1. SUMMARY OF MAXIMUM SAR VALUE

The maximum results of Specific Absorption Rate (SAR) found during testing for EUT are as follows:

Highest Report standalone SAR Summary (50% duty cycle)

Frequency Band	Type of signal	Separation	Highest Reported 1g-SAR(W/Kg)	
			Face Up (with 25mm separation)	Back Touch
450	Analog	12.5KHz	1.574	3.393
	Digital	12.5KHz	0.784	1.578
150	Analog	12.5KHz	0.170	0.901
	Digital	12.5KHz	0.082	0.371

This device is compliance with Specific Absorption Rate (SAR) for Occupational / Controlled Exposure Environment limits (8.0W/Kg) specified in 47 CFR part 2 (2.1093) and ANSI/IEEE C95.1, and had been tested in accordance with measurement methods and procedures specified in IEEE 1528-2013 and the following specific FCC Test Procedures:

KDB447498 D01 General RF Exposure Guidance v06

KDB 865664 D01 SAR Measurement 100MHz to 6GHz v01r04

KDB 643646 D01 SAR Test for PTT Radios v01r03

The results shown in this test report refer only to the sample(s) tested unless otherwise stated and the sample(s) are retained for 30 days only. The document is issued by AGC, this document cannot be reproduced except in full with our prior written permission. The more details and the authenticity of the report will be confirmed at <http://www.agc-cert.com>.

2. GENERAL INFORMATION

2.1. EUT Description

General Information	
Product Name	VHF/UHF DUAL BAND TRANSCEIVER
Test Model	DJ-MD5
Hardware Version	V1.00
Software Version	V2.02
Exposure Category:	Occupational/Controlled Exposure
Device Category	UHF & VHF Portable Transceiver
Modulation Type	FM & 4FSK
TX Frequency Range	400-480MHz/136-174MHz
Rated Power	5W/2.5W/1W/0.2W (It was fixed by the manufacturer, any individual can't arbitrarily change it)
Max. Average Power	UHF:36.83dBm, VHF:36.87dBm
Channel Spacing	12.5 KHz
Antenna Type	Detachable
Antenna Gain	2.15dBi
Body-Worn Accessories:	Belt Clip with headset
Face-Head Accessories:	None
Battery Type (s) Tested:	DC7.4V,1700mAh (by battery)

Note: The sample used for testing is end product.

Product	Type
	<input checked="" type="checkbox"/> Production unit <input type="checkbox"/> Identical Prototype

The results shown in this test report refer only to the sample(s) tested unless otherwise stated and the sample(s) are retained for 30 days only. The document is issued by AGC, this document cannot be reproduced except in full with our prior written permission. The more details and the authenticity of the report will be confirmed at <http://www.agc-cert.com>.

3. SAR MEASUREMENT SYSTEM

3.1. The DASY5 system used for performing compliance tests consists of following items

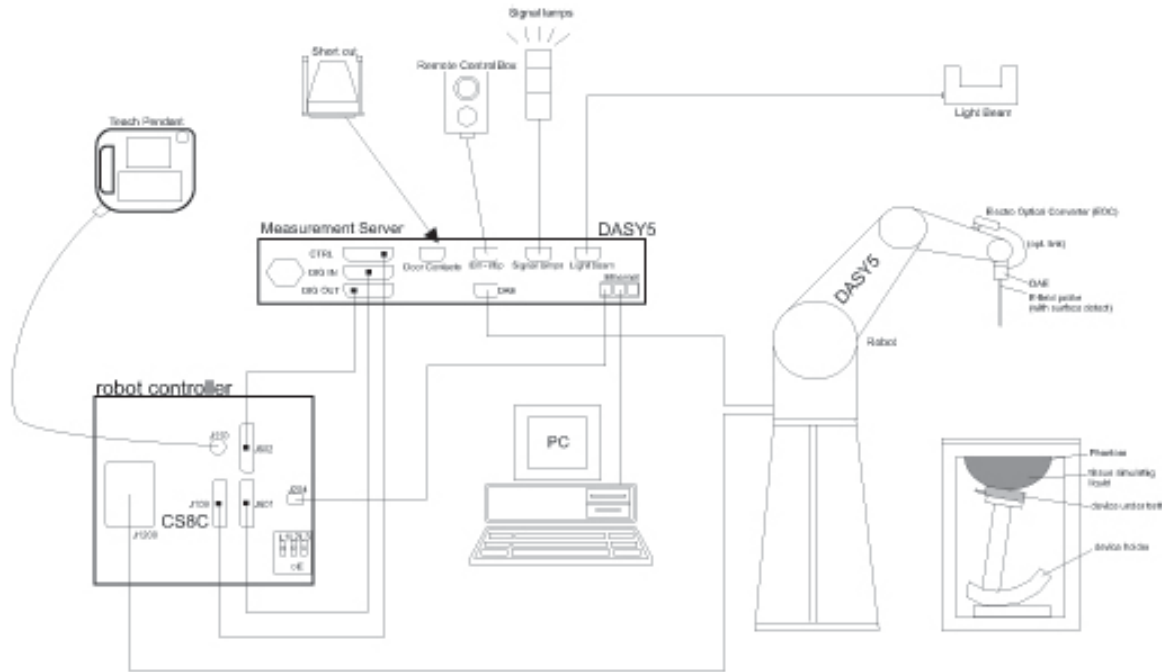

- A standard high precision 6-axis robot with controller, teach pendant and software.
- Data acquisition electronics (DAE) which attached to the robot arm extension. The DAE consist of a highly sensitive electrometer-grade preamplifier with auto-zeroing, a channel and gain-switching multiplexer, a fast 16 bit AD-converter and a command decoder with a control logic unit. Transmission to the measurement server is accomplished through an optical downlink for data and status information, as well as an optical uplink for commands and the clock
- A dosimetric probe equipped with an optical surface detector system.
- The Electro-optical converter (EOC) performs the conversion from optical to electrical signals for the digital Communication to the DAE. To use optical surface detection, a special version of the EOC is required. The EOC signal is transmitted to the measurement server.
- A Light Beam used is for probe alignment. This improves the (absolute) accuracy of the probe positioning.
- A computer running WinXP and the DASY5 software.
- Remote control and teach pendant as well as additional circuitry for robot safety such as warning lamps, etc.
- Phantoms, device holders and other accessories according to the targeted measurement.

The results shown in this test report refer only to the sample(s) tested unless otherwise stated and the sample(s) are retained for 30 days only. The document is issued by AGC, this document cannot be reproduced except in full with our prior written permission. The more details and the authenticity of the report will be confirmed at <http://www.agc-cert.com>.

3.2. DASY5 E-Field Probe

The SAR measurement is conducted with the dosimetric probe manufactured by SPEAG. The probe is specially designed and calibrated for use in liquid with high permittivity. The dosimetric probe has special calibration in liquid at different frequency. SPEAG conducts the probe calibration in compliance with international and national standards (e.g. IEEE 1528 and relevant KDB files, etc.) Under ISO17025. The calibration data are in Appendix D.

Isotropic E-Field Probe Specification

Model	ES3DV3	
Manufacture	SPEAG	
frequency	0.15GHz-3 GHz Linearity:±0.2dB(150MHz-3 GHz)	
Dynamic Range	0.01W/Kg-100W/Kg Linearity:±0.2dB	
Dimensions	Overall length:337mm Tip diameter:4mm Typical distance from probe tip to dipole centers:2mm	
Application	High precision dosimetric measurements in any exposure scenario (e.g., very strong gradient fields). Only probe which enables compliance testing for frequencies up to 3 GHz with precision of better 30%.	

3.3. Data Acquisition Electronics description

The data acquisition electronics (DAE) consist if a highly sensitive electrometer-grade preamplifier with auto-zeroing, a channel and gain-switching multiplexer, a fast 16 bit AD-converte and a command decoder with a control logic unit. Transmission to the measurement sever is accomplished through an optical downlink fir data and status information, as well as an optical uplink for commands and the clock.

The mechanical probe mounting device includes two different sensor systems for frontal and sideways probe contacts. They are used for mechanical surface detection and probe collision detection.

DAE4

Input Impedance	200MOhm	
The Inputs	Symmetrical and floating	
Common mode rejection	above 80 dB	

The results shown in this test report refer only to the sample(s) tested unless otherwise stated and the sample(s) are retained for 30 days only. The document is issued by AGC, this document cannot be reproduced except in full with our prior written permission. The more details and the authenticity of the report will be confirmed at <http://www.agc-cert.com>.

3.4. Robot

The DASY system uses the high precision robots (DASY5:TX60) type from Stäubli SA (France). For the 6-axis controller system, the robot controller version from is used.

The XL robot series have many features that are important for our application:

- High precision (repeatability 0.02 mm)
- High reliability (industrial design)
- Jerk-free straight movements
- Low ELF interference (the closed metallic construction shields against motor control fields)
- 6-axis controller



3.5. Light Beam Unit

The light beam switch allows automatic “tooling” of the probe. During the process, the actual position of the probe tip with respect to the robot arm is measured, as well as the probe length and the horizontal probe offset. The software then corrects all movements, such that the robot coordinates are valid for the probe tip.

The repeatability of this process is better than 0.1 mm. If a position has been taught with an aligned prob.1 mm, even if the other probe has different dimensions. During probe rotations, the probe tip will keep its actual position. e, the same position will be reached with another aligned probe within 0



The results shown in this test report refer only to the sample(s) tested unless otherwise stated and the sample(s) are retained for 30 days only. The document is issued by AGC, this document cannot be reproduced except in full with our prior written permission. The more details and the authenticity of the report will be confirmed at <http://www.agc-cert.com>.

3.6. Device Holder

The DASY device holder is designed to cope with different positions given in the standard. It has two scales for the device rotation (with respect to the body axis) and the device inclination (with respect to the line between the ear reference points). The rotation center for both scales is the ear reference point (EPR).

Thus the device needs no repositioning when changing the angles.

The DASY device holder has been made out of low-loss POM material having the following dielectric parameters: relative permittivity $\epsilon=3$ and loss tangent $\delta = 0.02$. The amount of dielectric material has been reduced in the closest vicinity of the device, since measurements have suggested that the influence of the clamp on the test results could thus be lowered.



3.7. Measurement Server

The measurement server is based on a PC/104 CPU board with CPU (DASY5: 400 MHz, Intel Celeron), chip-disk (DASY5: 128MB), RAM (DASY5: 128MB). The necessary circuits for communication with the DAE electronic box, as well as the 16 bit AD converter system for optical detection and digital I/O interface are contained on the DAYS I/O board, which is directly connected to the PC/104 bus of the CPU board.

The measurement server performs all the real-time data evaluation for field measurements and surface detection, controls robot movements and handles safety operations.



The results shown in this test report refer only to the sample(s) tested unless otherwise stated and the sample(s) are retained for 30 days only. The document is issued by AGC, this document cannot be reproduced except in full with our prior written permission. The more details and the authenticity of the report will be confirmed at <http://www.agc-cert.com>.

3.8. PHANTOM SAM Twin Phantom

The SAM twin phantom is a fiberglass shell phantom with 2mm shell thickness (except the ear region where shell thickness increases to 6mm). It has three measurement areas:

- Left head
- Right head
- Flat phantom



The bottom plate contains three pair of bolts for locking the device holder. The device holder positions are adjusted to the standard measurement positions in the three sections. A white cover is provided to tap the phantom during off-periods to prevent water evaporation and changes in the liquid parameters. On the phantom top, three reference markers are provided to identify the phantom position with respect to the robot.

ELI4 Phantom

Flat phantom a fiberglass shell flat phantom with 2mm \pm 0.2 mm shell thickness. It has only one measurement area for Flat phantom

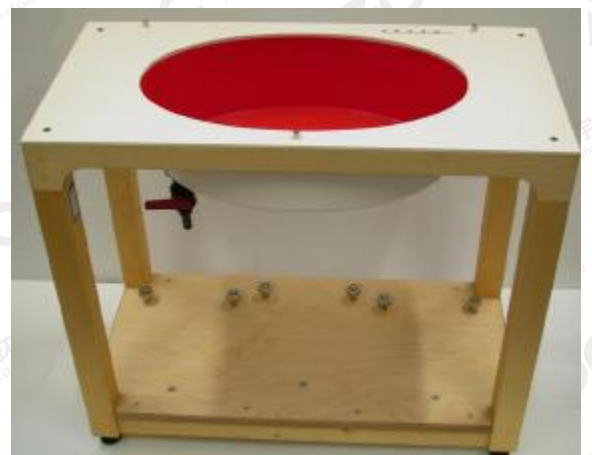

The results shown in this test report refer only to the sample(s) tested unless otherwise stated and the sample(s) are retained for 30 days only. The document is issued by AGC, this document cannot be reproduced except in full with our prior written permission. The more details and the authenticity of the report will be confirmed at <http://www.agc-cert.com>.

4. SAR MEASUREMENT PROCEDURE

4.1. Specific Absorption Rate (SAR)

SAR is related to the rate at which energy is absorbed per unit mass in object exposed to a radio field. The SAR distribution in a biological body is complicated and is usually carried out by experimental techniques or numerical modeling. The standard recommends limits for two tiers of groups, occupational/controlled and occupational/uncontrolled, based on a person's awareness and ability to exercise control over his or her exposure. In general, occupational/controlled exposure limits are higher than the limits for general population/uncontrolled.

The SAR definition is the time derivative (rate) of the incremental energy (dW) absorbed by (dissipated in) an incremental mass (dm) contained in a volume element (dv) of given mass density (ρ). The equation description is as below:

$$SAR = \frac{d}{dt} \left(\frac{dW}{dm} \right) = \frac{d}{dt} \left(\frac{dW}{\rho dV} \right)$$

SAR is expressed in units of Watts per kilogram (W/Kg)

SAR can be obtained using either of the following equations:

$$SAR = \frac{\sigma E^2}{\rho}$$

$$SAR = c_h \left. \frac{dT}{dt} \right|_{t=0}$$

Where

SAR	is the specific absorption rate in watts per kilogram;
E	is the r.m.s. value of the electric field strength in the tissue in volts per meter;
σ	is the conductivity of the tissue in siemens per metre;
ρ	is the density of the tissue in kilograms per cubic metre;
c_h	is the heat capacity of the tissue in joules per kilogram and Kelvin;
$\left. \frac{dT}{dt} \right _{t=0}$	is the initial time derivative of temperature in the tissue in kelvins per second

The results shown in this test report refer only to the sample(s) tested unless otherwise stated and the sample(s) are retained for 30 days only. The document is issued by AGC, this document cannot be reproduced except in full with our prior written permission. The more details and the authenticity of the report will be confirmed at <http://www.agc-cert.com>.

4.2. SAR Measurement Procedure

Step 1: Power Reference Measurement

The Power Reference Measurement and Power Drift Measurement are for monitoring the power drift of the device under test in the batch process. The minimum distance of probe sensors to surface is 2.7mm This distance cannot be smaller than the distance os sensor calibration points to probe tip as `defined in the probe properties,

Step 2: Area Scan

The Area Scan is used as a fast scan in two dimensions to find the area of high field values, before doing a fine measurement around the hot spot. The sophisticated interpolation routines implemented in SATIMO software can find the maximum locations even in relatively coarse grids. When an Area Scan has measured all reachable points, it computes the field maximal found in the scanned area, within a range of the global maximum. The range (in db) is specified in the standards for compliance testing. For example, a 2db range is required in IEEE Standard 1528 and IEC62209 standards, whereby 3db is a requirement when compliance is assessed in accordance with the ARIB standard (Japan) If one Zoom Scan follows the Area Scan, then only the absolute maximum will be taken as reference. For cases where multiple maximum are detected, the number of Zoom Scan has to be increased accordingly.

Area Scan Parameters extracted from KDB 865664 D01 SAR Measurement 100MHz to 6GHz

	≤ 3 GHz	> 3 GHz
Maximum distance from closest measurement point (geometric center of probe sensors) to phantom surface	5 ± 1 mm	$\frac{1}{2} \cdot \delta \cdot \ln(2) \pm 0.5$ mm
Maximum probe angle from probe axis to phantom surface normal at the measurement location	30° ± 1°	20° ± 1°
Maximum area scan spatial resolution: Δx_{Area} , Δy_{Area}	≤ 2 GHz: ≤ 15 mm 2 – 3 GHz: ≤ 12 mm	3 – 4 GHz: ≤ 12 mm 4 – 6 GHz: ≤ 10 mm
	When the x or y dimension of the test device, in the measurement plane orientation, is smaller than the above, the measurement resolution must be ≤ the corresponding x or y dimension of the test device with at least one measurement point on the test device.	

Step 3: Zoom Scan

Zoom Scan are used to assess the peak spatial SAR value within a cubic average volume containing 1g abd 10g of simulated tissue. The Zoom Scan measures points(refer to table below) within a cube whose base faces are centered on the maxima found in a preceding area scan job within the same procedure. When the measurement is done, the Zoom Scan evaluates the averaged SAR for 1g and 10g and displays these values next to the job's label.

The results shown in this test report refer only to the sample(s) tested unless otherwise stated and the sample(s) are retained for 30 days only. The document is issued by AGC, this document cannot be reproduced except in full with our prior written permission. The more details and the authenticity of the report will be confirmed at <http://www.agc-cert.com>.

Zoom Scan Parameters extracted from KDB865664 D01 SAR Measurement 100MHz to 6GHz

Maximum zoom scan spatial resolution: Δx_{Zoom} , Δy_{Zoom}		≤ 2 GHz: ≤ 8 mm 2 – 3 GHz: ≤ 5 mm*	3 – 4 GHz: ≤ 5 mm* 4 – 6 GHz: ≤ 4 mm*
Maximum zoom scan spatial resolution, normal to phantom surface	uniform grid: $\Delta z_{Zoom}(n)$	≤ 5 mm	3 – 4 GHz: ≤ 4 mm 4 – 5 GHz: ≤ 3 mm 5 – 6 GHz: ≤ 2 mm
	graded grid	$\Delta z_{Zoom}(1)$: between 1 st two points closest to phantom surface	≤ 4 mm
		$\Delta z_{Zoom}(n>1)$: between subsequent points	$\leq 1.5 \cdot \Delta z_{Zoom}(n-1)$
Minimum zoom scan volume	x, y, z	≥ 30 mm	3 – 4 GHz: ≥ 28 mm 4 – 5 GHz: ≥ 25 mm 5 – 6 GHz: ≥ 22 mm
<p>Note: δ is the penetration depth of a plane-wave at normal incidence to the tissue medium; see draft standard IEEE P1528-2011 for details.</p> <p>* When zoom scan is required and the <i>reported</i> SAR from the <i>area scan based 1-g SAR estimation</i> procedures of KDB 447498 is ≤ 1.4 W/kg, ≤ 8 mm, ≤ 7 mm and ≤ 5 mm zoom scan resolution may be applied, respectively, for 2 GHz to 3 GHz, 3 GHz to 4 GHz and 4 GHz to 6 GHz.</p>			

Step 4: Power Drift Measurement

The Power Drift Measurement measures the field at the same location as the most recent power reference measurement within the same procedure, and with the same settings. The Power Drift Measurement gives the field difference in dB from the reading conducted within the same settings. This allows a user to monitor the power drift of the device under test within a batch process. The measurement procedure is the same as Step 1.

The results shown in this test report refer only to the sample(s) tested unless otherwise stated and the sample(s) are retained for 30 days only. The document is issued by AGC, this document cannot be reproduced except in full with our prior written permission. The more details and the authenticity of the report will be confirmed at <http://www.agc-cert.com>.

5. TISSUE SIMULATING LIQUID

For SAR measurement of the field distribution inside the phantom, the phantom must be filled with homogeneous tissue simulating liquid to a depth of at least 15cm. For head SAR testing the liquid height from the ear reference point (ERP) of the phantom to the liquid top surface is larger than 15cm For body SAR testing, the liquid height from the center of the flat phantom to the liquid top surface is larger than 15cm. The nominal dielectric values of the tissue simulating liquids in the phantom and the tolerance of 5% are listed in 5.2

5.1. The composition of the tissue simulating liquid

Ingredient (% Weight) Frequency (MHz)	Water	Nacl	Sugar	HEC	Bactericide	DGBE	1,2- Propanediol	Triton X-100
450 Head (100%)	38.56	3.95	56.32	0.98	0.19	0.0	0.0	0.0
450 Body (100%)	51.16	1.49	46.78	0.52	0.05	0.0	0.0	0.0

The 150MHz liquid has been provided by SPEAG and they do not provide the composition as it is a secret issue.

5.2. Tissue Dielectric Parameters for Head and Body Phantoms

The head tissue dielectric parameters recommended by the IEEE 1528 have been incorporated in the following table. These head parameters are derived from planar layer models simulating the highest expected SAR for the dielectric properties and tissue thickness variations in a human head. Other head and body tissue parameters that have not been specified in IEEE 1528 are derived from the tissue dielectric parameters computed from the 4-Cole-Cole equations described in Reference [12] and extrapolated according to the head parameters specified in IEEE 1528.

Target Frequency (MHz)	head		body	
	ϵ_r	σ (S/m)	ϵ_r	σ (S/m)
150	52.3	0.76	61.9	0.80
300	45.3	0.87	58.2	0.92
450	43.5	0.87	56.7	0.94
835	41.5	0.90	55.2	0.97
900	41.5	0.97	55.0	1.05
915	41.5	0.98	55.0	1.06
1450	40.5	1.20	54.0	1.30
1610	40.3	1.29	53.8	1.40
1800 – 2000	40.0	1.40	53.3	1.52
2450	39.2	1.80	52.7	1.95
3000	38.5	2.40	51.6	2.73

(ϵ_r = relative permittivity, σ = conductivity and $\rho = 1000 \text{ kg/m}^3$)

The results shown in this test report refer only to the sample(s) tested unless otherwise stated and the sample(s) are retained for 30 days only. The document is issued by AGC, this document cannot be reproduced except in full with our prior written permission. The more details and the authenticity of the report will be confirmed at <http://www.agc-cert.com>.

5.3. Tissue Calibration Result

The dielectric parameters of the liquids were verified prior to the SAR evaluation using DASY5 Dielectric Probe Kit and R&S Network Analyzer ZVL6.

Tissue Stimulant Measurement for 150MHz				
Fr. (MHz)	Dielectric Parameters ($\pm 5\%$)		Tissue Temp [°C]	Test time
	Head			
	ϵ_r 52.30(49.685 – 54.915)	δ [s/m] 0.76(0.722 - 0.798)		
136.025	54.44	0.73	21.5	July 07,2018
145.525	52.93	0.75		
150.000	52.11	0.77		
155.025	51.67	0.77		
164.500	50.56	0.78		
173.975	50.25	0.78		
Fr. (MHz)	Dielectric Parameters ($\pm 5\%$)			
	Body			
	ϵ_r 61.9(58.805 -64.995)	δ [s/m] 0.80(0.76 - 0.84)		
136.025	64.27	0.77	21.6	July 07,2018
145.525	62.91	0.78		
150.000	62.02	0.80		
155.025	61.38	0.81		
164.500	60.21	0.82		
173.975	59.89	0.82		

The results shown in this test report refer only to the sample(s) tested unless otherwise stated and the sample(s) are retained for 30 days only. The document is issued by AGC, this document cannot be reproduced except in full with our prior written permission. The more details and the authenticity of the report will be confirmed at <http://www.agc-cert.com>.

Tissue Stimulant Measurement for 450MHz				
Fr. (MHz)	Dielectric Parameters ($\pm 5\%$)		Tissue Temp [°C]	Test time
	Head			
	ϵ_r 43.50(41.325 - 45.675)	δ [s/m]0.87(0.8265 - 0.9135)		
400.025	45.06	0.84	21.3	July 04,2018
416.025	44.63	0.85		
432.025	43.50	0.86		
448.025	43.02	0.87		
450.000	42.75	0.87		
464.025	41.98	0.89		
479.975	41.60	0.90		
Fr. (MHz)	Dielectric Parameters ($\pm 5\%$)			
	Body			
	ϵ_r 56.7(53.865 to 59.535)	δ [s/m] 0.94(0.893 to 0.987)		
400.025	58.75	0.90	21.5	July 04,2018
416.025	57.98	0.91		
432.025	56.85	0.92		
448.025	56.42	0.93		
450.000	56.05	0.93		
464.025	54.85	0.95		
479.975	54.29	0.96		

The results shown in this test report refer only to the sample(s) tested unless otherwise stated and the sample(s) are retained for 30 days only. The document is issued by AGC, this document cannot be reproduced except in full with our prior written permission. The more details and the authenticity of the report will be confirmed at <http://www.agc-cert.com>.

6. SAR SYSTEM CHECK PROCEDURE

6.1. SAR System Check Procedures

SAR system check is required to confirm measurement accuracy, according to the tissue dielectric media, probe calibration points and other system operating parameters required for measuring the SAR of a test device. The system verification must be performed for each frequency band and within the valid range of each probe calibration point required for testing the device. The same SAR probe(s) and tissue-equivalent media combinations used with each specific SAR system for system verification must be used for device testing. When multiple probe calibration points are required to cover substantially large transmission bands, independent system verifications are required for each probe calibration point. A system verification must be performed before each series of SAR measurements using the same probe calibration point and tissue-equivalent medium. Additional system verification should be considered according to the conditions of the tissue-equivalent medium and measured tissue dielectric parameters, typically every three to four days when the liquid parameters are remeasured or sooner when marginal liquid parameters are used at the beginning of a series of measurements.

Each DASY system is equipped with one or more system check kits. These units, together with the predefined measurement procedures within the DASY software, enable the user to conduct the system check and system validation. System kit includes a dipole, and dipole device holder.

The system check verifies that the system operates within its specifications. It's performed daily or before every SAR measurement. The system check uses normal SAR measurement in the flat section of the phantom with a matched dipole at a specified distance. The system check setup is shown as below.

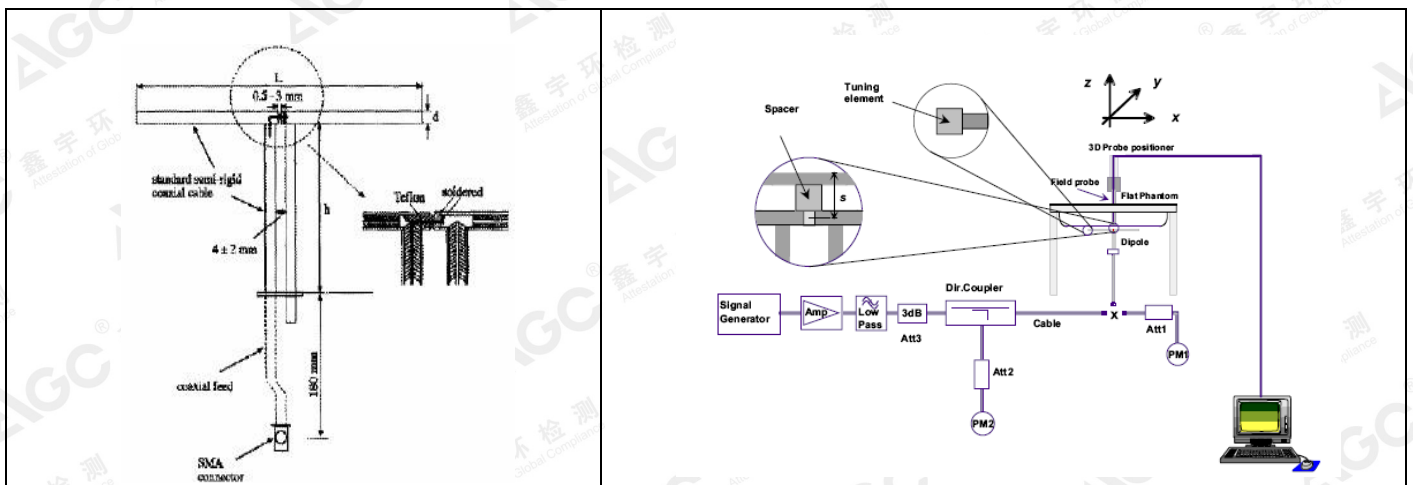

The results shown in this test report refer only to the sample(s) tested unless otherwise stated and the sample(s) are retained for 30 days only. The document is issued by AGC, this document cannot be reproduced except in full with our prior written permission. The more details and the authenticity of the report will be confirmed at <http://www.agc-cert.com>.

6.2. SAR System Check

6.2.1. Dipoles

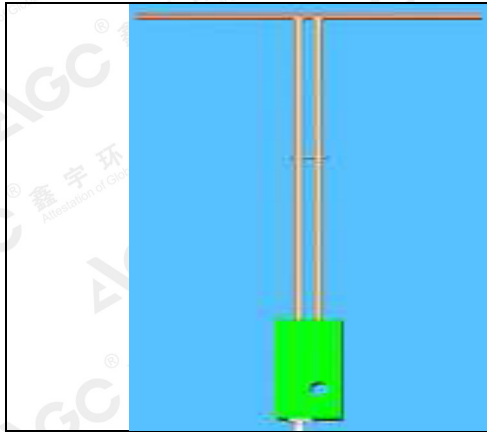

The dipoles used is based on the IEEE-1528 standard, and is complied with mechanical and electrical specifications in line with the requirements of IEEE. the table below provides details for the mechanical and electrical specifications for the dipoles



The Loop Antenna used is based on the IEEE-1528 standard, the table below provides details for the mechanical and electrical. Specifications for the Loop Antenna.

Frequency	R/L (mm)	R/h (mm)	d (mm)
450MHz	290	166.7	6.35
150MHz	222	222	97

6.2.2. System Check Result

System Performance Check at 150MHz & 450MHz

Validation Kit: CLA150 SN 4008& SN 46/11DIP 0G450-184

Frequency [MHz]	Target Value(W/Kg)		Reference Result (± 10%)		Normalized to 1W(W/Kg)		Tissue Temp. [°C]	Test time
	1g	10g	1g	10g	1g	10g		
150 head	3.89	2.59	3.501-4.279	2.331-2.849	3.86	2.70	21.5	July 07,2018
150 body	4.03	2.67	3.627-4.433	2.403-2.937	3.94	2.74	21.6	July 07,2018
450 head	4.74	3.12	4.266-5.214	2.808-3.432	4.44	3.06	21.3	July 04,2018
450 body	4.78	3.19	4.302-5.258	2.871-3.509	4.68	3.25	21.5	July 04,2018

Note:

(1) We use a CW signal of 23dBm(150MHz),18dBm(450MHz)for system check, and then all SAR value are normalized to 1W forward power. The result must be within ±10% of target value.

The results shown in this test report refer only to the sample(s) tested unless otherwise stated and the sample(s) are retained for 30 days only. The document is issued by AGC, this document cannot be reproduced except in full with our prior written permission. The more details and the authenticity of the report will be confirmed at <http://www.agc-cert.com>.

7. EUT TEST POSITION

This EUT was tested in **Front Face and Rear Face**.

7.1. Body Worn Position

- (1) To position the EUT parallel to the phantom surface.
- (2) To adjust the EUT parallel to the flat phantom.
- (3) To adjust the distance between the EUT surface and the flat phantom to **25mm** while used in front of face, and body back touch with belt clip.

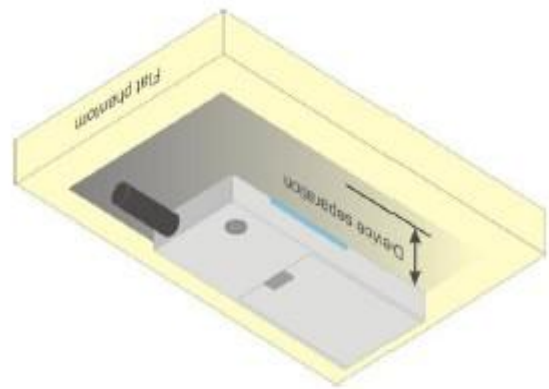
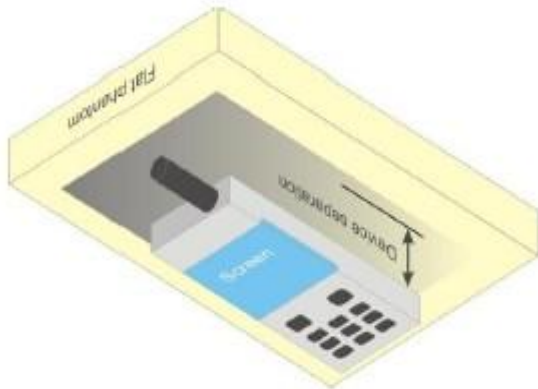

The results shown in this test report refer only to the sample(s) tested unless otherwise stated and the sample(s) are retained for 30 days only. The document is issued by AGC, this document cannot be reproduced except in full with our prior written permission. The more details and the authenticity of the report will be confirmed at <http://www.agc-cert.com>.

8. SAR EXPOSURE LIMITS

Limits for Occupational / Controlled Exposure Environment

Type Exposure Limits	Occupational / Controlled Exposure Environment(W/Kg)
Spatial Average SAR (whole body)	8.0

The results shown in this test report refer only to the sample(s) tested unless otherwise stated and the sample(s) are retained for 30 days only. The document is issued by AGC, this document cannot be reproduced except in full with our prior written permission. The more details and the authenticity of the report will be confirmed at <http://www.agc-cert.com>.

9. TEST FACILITY

Test Site	Attestation of Global Compliance (Shenzhen) Co., Ltd
Location	1-2F., Bldg.2, No.1-4, Chaxi Sanwei Technical Industrial Park, Gushu, Xixiang, Bao'an District B112-B113, Shenzhen 518012
NVLAP Lab Code	600153-0
Designation Number	CN5028
Test Firm Registration Number	682566
Description	Attestation of Global Compliance(Shenzhen) Co., Ltd is accredited by National Voluntary Laboratory Accreditation program, NVLAP Code 600153-0

The results shown in this test report refer only to the sample(s) tested unless otherwise stated and the sample(s) are retained for 30 days only. The document is issued by AGC, this document cannot be reproduced except in full with our prior written permission. The more details and the authenticity of the report will be confirmed at <http://www.agc-cert.com>.

10. TEST EQUIPMENT LIST

Equipment description	Manufacturer/ Model	Identification No.	Current calibration date	Next calibration date
Stäubli Robot	Stäubli-TX60	F13/5Q2UD1/A/01	N/A	N/A
Robot Controller	Stäubli-CS8	139522	N/A	N/A
E-Field Probe	Speag- ES3DV3	SN:3337	Nov. 23,2017	Nov. 22,2018
SAM Twin Phantom	Speag-SAM	1790	N/A	N/A
ELI4 Phantom	ELI V5.0	1210	N/A	N/A
Device Holder	Speag-SD 000 H01 KA	SD 000 H01 KA	N/A	N/A
DAE4	Speag-SD 000 D04 BM	1398	Feb. 08,2018	Feb. 07,2019
SAR Software	Speag-DASY5	DASY52.8	N/A	N/A
Liquid	SATIMO	-	N/A	N/A
Loop Antenna	Speag-CLA150	SN 4008	Jan. 19,2017	Jan. 18,2020
Dipole	SATIMO SID450	SN46/11 DIP OG450-184	Mar. 10,2017	Mar. 09,2020
Signal Generator	Agilent-E4438C	US41461365	Mar. 01,2018	Feb. 28,2019
Vector Analyzer	Agilent / E4440A	US41421290	Mar. 01,2018	Feb. 28,2019
Network Analyzer	Rhode & Schwarz ZVL6	SN100132	Mar. 01,2018	Feb. 28,2019
Attenuator	Warison /WATT-6SR1211	N/A	N/A	N/A
Amplifier	EM30180	SN060552	Mar. 01,2018	Feb. 28,2019
Directional Couple	Werlatone/ C5571-10	SN99463	Jun. 12,2018	Jun. 11,2019
Power Sensor	NRP-Z21	1137.6000.02	Oct. 12,2017	Oct. 11,2018
Power Sensor	NRP-Z23	US38261498	Mar. 01,2018	Feb. 28,2019
Power Viewer	R&S	V2.3.1.0	N/A	N/A

Note: Per KDB 865664 Dipole SAR Validation, AGC Lab has adopted 3 years calibration intervals. On annual basis, every measurement dipole has been evaluated and is in compliance with the following criteria:

1. There is no physical damage on the dipole;
2. System validation with specific dipole is within 10% of calibrated value;
3. Return-loss is within 20% of calibrated measurement;
4. Impedance is within 5Ω of calibrated measurement.

The results shown in this test report refer only to the sample(s) tested unless otherwise stated and the sample(s) are retained for 30 days only. The document is issued by AGC, this document cannot be reproduced except in full with our prior written permission. The more details and the authenticity of the report will be confirmed at <http://www.agc-cert.com>.

11. MEASUREMENT UNCERTAINTY

The component of uncertainty may generally be categorized according to the methods used to evaluate them. The evaluation of uncertainty by the statistical analysis of a series of observations is termed a Type A evaluation of uncertainty. The evaluation of uncertainty by means other than the statistical analysis of a series of observation is termed a Type B evaluation of uncertainty. Each component of uncertainty, however evaluated, is represented by an estimated standard deviation, termed standard uncertainty, which is determined by the positive square root of the estimated variance.

A Type A evaluation of standard uncertainty may be based on any valid statistical method for treating data. This includes calculating the standard deviation of the mean of a series of independent observations; using the method of least squares to fit a curve to the data in order to estimate the parameter of the curve and their standard deviations; or carrying out an analysis of variance in order to identify and quantify random effects in certain kinds of measurement.

A type B evaluation of standard uncertainty is typically based on scientific judgment using all of the relevant information available. These may include previous measurement data, experience, and knowledge of the behavior and properties of relevant materials and instruments, manufacture's specification, data provided in calibration reports and uncertainties assigned to reference data taken from handbooks. Broadly speaking, the uncertainty is either obtained from an outdoor source or obtained from an assumed distribution, such as the normal distribution, rectangular or triangular distributions indicated in Table as follow.

Uncertainty Distributions	Normal	Rectangular	Triangular	U-Shape
Multi-plying Factor(a)	$1/k(b)$	$1/\sqrt{3}$	$1/\sqrt{6}$	$1/\sqrt{2}$

(a) Standard uncertainty is determined as the product of the multiplying factor and the estimated range of variations in the measured quantity

(b) κ is the coverage factor

Table 13.1 Standard Uncertainty for Assumed Distribution (above table)

The combined standard uncertainty of the measurement result represents the estimated standard deviation of the result. It is obtained by combining the individual standard uncertainties of both Type A and Type B evaluation using the usual "root-sum-squares" (RSS) methods of combining standard deviations by taking the positive square root of the estimated variances.

Expanded uncertainty is a measure of uncertainty that defines an interval about the measurement result within which the measured value is confidently believed to lie. It is obtained by multiplying the combined standard uncertainty by a coverage factor. Typically, the coverage factor ranges from 2 to 3. Using a coverage factor allows the true value of a measured quantity to be specified with a defined probability within the specified uncertainty range. For purpose of this document, a coverage factor two is used, which corresponds to confidence interval of about 95 %. The DASY uncertainty Budget is shown in the following tables.

DASY5 Uncertainty									
Measurement uncertainty for 150 MHz to 3GHz averaged over 1 gram / 10 gram.									
Uncertainty Component	Sec.	Tol (+-%)	Prob. Dist.	Div.	Ci (1g)	Ci (10g)	1g Ui (+-%)	10g Ui (+-%)	Vi
Measurement System									
Probe calibration	E.2.1	6.65	N	1	1	1	6.65	6.65	∞
Axial Isotropy	E.2.2	0.25	R	$\sqrt{3}$	1	1	0.14	0.14	∞
Hemispherical Isotropy	E.2.2	1.3	R	$\sqrt{3}$	1	1	0.75	0.75	∞
Linearity	E.2.4	0.3	R	$\sqrt{3}$	1	1	0.17	0.17	∞
Probe modulation	E.2.5	1.65	R	$\sqrt{3}$	1	1	0.95	0.95	∞
Detection limits	E.2.4	0.9	R	$\sqrt{3}$	1	1	0.52	0.52	∞
Boundary effect	E.2.3	0.9	R	$\sqrt{3}$	1	1	0.52	0.52	∞
Readout Electronics	E.2.6	0.2	N	1	1	1	0.20	0.20	∞
Response Time	E.2.7	0.0	R	$\sqrt{3}$	1	1	0.00	0.00	∞
Integration Time	E.2.8	0.0	R	$\sqrt{3}$	1	1	0.00	0.00	∞
RF ambient Conditions-noise	E.6.1	0.9	R	$\sqrt{3}$	1	1	0.52	0.52	∞
RF ambient Conditions-reflections	E.6.1	0.9	R	$\sqrt{3}$	1	1	0.52	0.52	∞
Probe positioned mech. restrictions	E.6.2	0.7	R	$\sqrt{3}$	1	1	0.40	0.40	∞
Probe positioning with respect to phantom shell	E.6.3	6.5	R	$\sqrt{3}$	1	1	3.75	3.75	∞
Post-processing	E.5	3.8	R	$\sqrt{3}$	1	1	2.19	2.19	∞
Test sample related									
Device holder uncertainty	E.4.1	3.6	N	1	1	1	3.60	3.60	M-1
Test sample positioning	E.4.2	3.2	N	1	1	1	3.20	3.20	M-1
SAR scaling	E.6.5	0	R	$\sqrt{3}$	1	1	0.00	0.00	∞
Drift of output power(measured SAR drift)	E.2.9	5.0	R	$\sqrt{3}$	1	1	2.89	2.89	∞
Phantom and set-up									
Phantom Uncertainty (Shape and thickness tolerances)	E.3.1	0.05	R	$\sqrt{3}$	1	1	0.03	0.03	∞
Algorithm for correcting SAR for deviations in permittivity and conductivity	E.3.2	1.9	N	1	1	0.84	1.90	1.60	∞
Liquid conductivity (meas.)	E.3.3	5	N	1	0.78	0.71	3.90	3.55	M-1
Liquid permittivity (meas.)	E.3.3	5	N	1	0.23	0.26	1.15	1.30	M
Liquid permittivity – temperature uncertainty	E.3.4	5	R	$\sqrt{3}$	0.78	0.71	2.25	2.05	∞
Liquid conductivity – temperature uncertainty	E.3.4	5	R	$\sqrt{3}$	0.23	0.26	0.66	0.75	∞
Combined Standard Uncertainty			RSS				10.65	10.39	
Expanded Uncertainty (95% Confidence interval)			k				21.30	20.78	

The results shown in this test report refer only to the sample(s) tested unless otherwise stated and the sample(s) are retained for 30 days only. The document is issued by AGC, this document cannot be reproduced except in full with our prior written permission. The more details and the authenticity of the report will be confirmed at <http://www.agc-cert.com>.

System validation for 150 MHz to 3GHz averaged over 1 gram / 10 gram.									
Uncertainty Component	Sec.	Tol (+-%)	Prob. Dist.	Div.	Ci (1g)	Ci (10g)	1g Ui (+-%)	10g Ui (+-%)	Vi
Measurement System									
Probe calibration	E.2.1	6.65	N	1	1	1	6.65	6.65	∞
Axial Isotropy	E.2.2	0.25	R	$\sqrt{3}$	1	1	0.14	0.14	∞
Hemispherical Isotropy	E.2.2	1.3	R	$\sqrt{3}$	1	1	0.75	0.75	
Linearity	E.2.4	0.3	R	$\sqrt{3}$	1	1	0.17	0.17	∞
Probe modulation	E.2.5	1.65	R	$\sqrt{3}$	1	1	0.95	0.95	∞
Detection limits	E.2.4	0.9	R	$\sqrt{3}$	1	1	0.52	0.52	∞
Boundary effect	E.2.3	0.9	R	$\sqrt{3}$	1	1	0.52	0.52	∞
Readout Electronics	E.2.6	0.2	N	1	1	1	0.20	0.20	∞
Response Time	E.2.7	0.0	R	$\sqrt{3}$	1	1	0.00	0.00	∞
Integration Time	E.2.8	0.0	R	$\sqrt{3}$	1	1	0.00	0.00	∞
RF ambient Conditions-noise	E.6.1	0.9	R	$\sqrt{3}$	1	1	0.52	0.52	∞
RF ambient Conditions-reflections	E.6.1	0.9	R	$\sqrt{3}$	1	1	0.52	0.52	∞
Probe positioned mech. restrictions	E.6.1	0.7	R	$\sqrt{3}$	1	1	0.40	0.40	∞
Probe positioning with respect to phantom shell	E.6.2	6.5	R	$\sqrt{3}$	1	1	3.75	3.75	∞
Post-processing	E.6.3	3.8	R	$\sqrt{3}$	1	1	2.19	2.19	∞
System validation source(dipole)									
Deviation of the experimental source from numerical source	E6.4	5.3	N	1	1	1	5.30	5.30	∞
Source to liquid distance	8,E.6.6	1.0	R	$\sqrt{3}$	1	1	0.58	0.58	∞
Drift of output power(measured SAR drift)	8,6.6.4	5.0	R	$\sqrt{3}$	1	1	2.89	2.89	∞
Phantom and set-up									
Phantom Uncertainty (Shape and thickness tolerances)	E.3.1	0.05	R	$\sqrt{3}$	1	1	0.03	0.03	∞
Algorithm for correcting SAR for deviations in permittivity and conductivity	E.3.2	1.9	N	1	1	0.84	1.90	1.60	∞
Liquid conductivity (meas.)	E.3.3	5	N	1	0.78	0.71	3.90	3.55	M
Liquid permittivity (meas.)	E.3.3	5	N	1	0.23	0.26	1.15	1.30	M
Liquid permittivity – temperature uncertainty	E.3.4	5	R	$\sqrt{3}$	0.78	0.71	2.25	2.05	∞
Liquid conductivity – temperature uncertainty	E.3.4	5	R	$\sqrt{3}$	0.23	0.26	0.66	0.75	∞
Combined Standard Uncertainty			RSS				10.90	10.635	
Expanded Uncertainty (95% Confidence interval)			k				21.79	21.270	

The results shown in this test report refer only to the sample(s) tested unless otherwise stated and the sample(s) are retained for 30 days only. The document is issued by AGC, this document cannot be reproduced except in full with our prior written permission. The more details and the authenticity of the report will be confirmed at <http://www.agc-cert.com>.

System check for 150 MHz to 3GHz averaged over 1 gram / 10 gram.									
Uncertainty Component	Sec.	Tol (+-%)	Prob. Dist.	Div.	Ci (1g)	Ci (10g)	1g Ui (+-%)	10g Ui (+-%)	Vi
Measurement System									
Probe calibration drift	E.2.1.3	2.0	N	1	1	1	6.00	6.00	∞
Axial Isotropy	E.2.2	0.25	R	$\sqrt{3}$	0	0	0	0	∞
Hemispherical Isotropy	E.2.2	1.3	R	$\sqrt{3}$	0	0	0	0	
Linearity	E.2.4	0.3	R	$\sqrt{3}$	0	0	0	0	∞
Probe modulation	E.2.5	1.65	R	$\sqrt{3}$	0	0	0	0	∞
Detection limits	E.2.4	0.9	R	$\sqrt{3}$	0	0	0	0	∞
Boundary effect	E.2.3	0.9	R	$\sqrt{3}$	0	0	0	0	∞
Readout Electronics	E.2.6	0.2	N	1	0	0	0	0	∞
Response Time	E.2.7	0	R	$\sqrt{3}$	0	0	0	0	∞
Integration Time	E.2.8	0	R	$\sqrt{3}$	0	0	0	0	∞
RF ambient Conditions-noise	E.6.1	0.9	R	$\sqrt{3}$	0	0	0	0	∞
RF ambient Conditions-reflections	E.6.1	0.9	R	$\sqrt{3}$	0	0	0	0	∞
Probe positioned mech. restrictions	E.6.2	0.7	R	$\sqrt{3}$	1	1	0.40	0.40	∞
Probe positioning with respect to phantom shell	E.6.3	6.5	R	$\sqrt{3}$	1	1	3.75	3.75	∞
Post-processing	E.5	3.8	R	$\sqrt{3}$	0	0	0	0	∞
System check source(dipole)									
Deviation of the experimental source from numerical source	E6.4	5.3	N	1	1	1	5.30	5.30	∞
Source to liquid distance	8,E.6.6	1.0	R	$\sqrt{3}$	1	1	0.58	0.58	∞
Drift of output power(measured SAR drift)	8,6.6.4	5.0	R	$\sqrt{3}$	1	1	2.89	2.89	∞
Phantom and set-up									
Phantom Uncertainty (Shape and thickness tolerances)	E.3.1	0.05	R	$\sqrt{3}$	1	1	0.03	0.03	∞
Algorithm for correcting SAR for deviations in permittivity and conductivity	E.3.2	1.9	N	1	1	0.84	1.90	1.60	∞
Liquid conductivity (meas.)	E.3.3	5	N	1	0.78	0.71	3.90	3.55	M
Liquid permittivity (meas.)	E.3.3	5	N	1	0.23	0.26	1.15	1.30	M
Liquid permittivity – temperature uncertainty	E.3.4	5	R	$\sqrt{3}$	0.78	0.71	2.25	2.05	∞
Liquid conductivity – temperature uncertainty	E.3.4	5	R	$\sqrt{3}$	0.23	0.26	0.66	0.75	∞
Combined Standard Uncertainty			RSS				8.11	7.86	
Expanded Uncertainty (95% Confidence interval)			k				16.22	15.52	

The results shown in this test report refer only to the sample(s) tested unless otherwise stated and the sample(s) are retained for 30 days only. The document is issued by AGC, this document cannot be reproduced except in full with our prior written permission. The more details and the authenticity of the report will be confirmed at <http://www.agc-cert.com>.

12. POWER MEASUREMENT

UHF: Analog

Frequency (MHz)	Channel Spacing	Max. Output Power (dBm)
5W		
400.025	12.5KHz	36.74
416.025		36.71
432.025		36.76
448.025		36.75
464.025		36.69
479.975		36.77
2.5W		
400.025	12.5KHz	33.74
416.025		33.71
432.025		33.69
448.025		33.72
464.025		33.75
479.975		33.77
1W		
400.025	12.5KHz	29.78
416.025		29.72
432.025		29.68
448.025		29.70
464.025		29.81
479.975		29.82
0.2W		
400.025	12.5KHz	22.84
416.025		22.76
432.025		22.70
448.025		22.74
464.025		22.81
479.975		22.71

The results shown in this test report refer only to the sample(s) tested unless otherwise stated and the sample(s) are retained for 30 days only. The document is issued by AGC, this document cannot be reproduced except in full with our prior written permission. The more details and the authenticity of the report will be confirmed at <http://www.agc-cert.com>.

UHF: Digital

Frequency (MHz)	Channel Spacing	Max. Output Power (dBm)
(Data + voice):5W		
400.025	12.5KHz	36.83
416.025		36.80
432.025		36.79
448.025		36.68
464.025		36.73
479.975		36.72
(Data):5W		
400.025	12.5KHz	36.74
416.025		36.71
432.025		36.68
448.025		36.72
464.025		36.73
479.975		36.79
(Data + voice):2.5W		
400.025	12.5KHz	33.88
416.025		33.86
432.025		33.82
448.025		33.79
464.025		33.76
479.975		33.78
(Data):2.5W		
400.025	12.5KHz	33.83
416.025		33.82
432.025		33.72
448.025		33.71
464.025		33.65
479.975		33.76
(Data + voice):1W		
400.025	12.5KHz	29.83
416.025		29.80
432.025		29.77
448.025		29.65
464.025		29.73
479.975		29.79
(Data):1W		
400.025	12.5KHz	29.84
416.025		29.81
432.025		29.79
448.025		29.75
464.025		29.70
479.975		29.79

The results shown in this test report refer only to the sample(s) tested unless otherwise stated and the sample(s) are retained for 30 days only. The document is issued by AGC, this document cannot be reproduced except in full with our prior written permission. The more details and the authenticity of the report will be confirmed at <http://www.agc-cert.com>.

UHF: Digital- Continue

Frequency (MHz)	Channel Spacing	Max. Output Power (dBm)
(Data + voice):0.2W		
400.025	12.5KHz	22.84
416.025		22.81
432.025		22.79
448.025		22.85
464.025		22.80
479.975		22.87
(Data):0.2W		
400.025	12.5KHz	22.84
416.025		22.81
432.025		22.75
448.025		22.73
464.025		22.70
479.975		22.73

The results shown in this test report refer only to the sample(s) tested unless otherwise stated and the sample(s) are retained for 30 days only. The document is issued by AGC, this document cannot be reproduced except in full with our prior written permission. The more details and the authenticity of the report will be confirmed at <http://www.agc-cert.com>.

VHF: Analog

Frequency (MHz)	Channel Spacing	Max. Output Power (dBm)
5W		
136.025	12.5KHz	36.82
145.500		36.77
155.025		36.85
165.500		36.81
173.975		36.75
2.5W		
136.025	12.5KHz	33.79
145.500		33.75
155.025		33.88
165.500		33.85
173.975		33.71
1W		
136.025	12.5KHz	29.83
145.500		29.81
155.025		29.72
165.500		29.76
173.975		29.84
0.2W		
136.025	12.5KHz	22.89
145.500		22.85
155.025		22.91
165.500		22.88
173.975		22.86

The results shown in this test report refer only to the sample(s) tested unless otherwise stated and the sample(s) are retained for 30 days only. The document is issued by AGC, this document cannot be reproduced except in full with our prior written permission. The more details and the authenticity of the report will be confirmed at <http://www.agc-cert.com>.

VHF: Digital

Frequency (MHz)	Channel Spacing	Max. Output Power (dBm)
(Data + voice):5W		
136.025	12.5KHz	36.83
145.500		36.81
155.025		36.87
165.500		36.75
173.975		36.71
(Data):5W		
136.025	12.5KHz	36.74
145.500		36.79
155.025		36.86
165.500		36.70
173.975		36.72
(Data + voice):2.5W		
136.025	12.5KHz	33.78
145.500		33.75
155.025		33.89
165.500		33.85
173.975		33.73
(Data):2.5W		
136.025	12.5KHz	33.85
145.500		33.82
155.025		33.79
165.500		33.77
173.975		33.82
(Data + voice):1W		
136.025	12.5KHz	29.84
145.500		29.81
155.025		29.85
165.500		29.80
173.975		29.75
(Data):1W		
136.025	12.5KHz	29.77
145.500		29.72
155.025		29.89
165.500		29.83
173.975		29.76

The results shown in this test report refer only to the sample(s) tested unless otherwise stated and the sample(s) are retained for 30 days only. The document is issued by AGC, this document cannot be reproduced except in full with our prior written permission. The more details and the authenticity of the report will be confirmed at <http://www.agc-cert.com>.

VHF: Digital- Continue

Frequency (MHz)	Channel Spacing	Max. Output Power (dBm)
(Data + voice):0.2W		
136.025	12.5KHz	22.79
145.500		22.75
155.025		22.88
165.500		22.86
173.975		22.71
(Data):0.2W		
136.025	12.5KHz	22.75
145.500		22.73
155.025		22.79
165.500		22.65
173.975		22.82

The results shown in this test report refer only to the sample(s) tested unless otherwise stated and the sample(s) are retained for 30 days only. The document is issued by AGC, this document cannot be reproduced except in full with our prior written permission. The more details and the authenticity of the report will be confirmed at <http://www.agc-cert.com>.

13. TEST RESULTS

13.1. SAR Test Results Summary

13.1.1. Test position and configuration

Face up SAR was performed with the device configured in the positions according to KDB 643646 and Body SAR was performed with the device configured with all accessories close to the Flat Phantom.

13.1.2. Operation Mode

- Set the EUT to maximum output power level and transmit on lower, middle and top channel with 100% duty cycle individually during SAR measurement.
- Per KDB 447498D01 v06 (Chapter 4.1 6) For UHF the number of channels to be assessed is 6. For VHF the number of channels to be assessed is 5.
- Per KDB 643646 D01, Passive body-worn and audio accessories generally do not apply to the head SAR of PTT radios. Head SAR is measured with the front surface of the radio positioned at 2.5 cm parallel to a flat phantom.

When testing antennas with the default battery:

- a. When the SAR ≤ 3.5 W/kg, testing of all other required channels is not necessary for that antenna;
 - b. When the SAR > 3.5 W/kg and ≤ 4.0 W/kg, testing of the required immediately channel(s) is not necessary; testing of the other required channels may still be required.
 - c. When the SAR > 4.0 W/kg and ≤ 6.0 W/kg, SAR should be measured for that antenna on the all required channels;
 - d. When the highest scaled SAR is ≤ 6.0 W/kg, PBA is not required
- Per KDB 643646 D01, Body SAR is measured with the radio placed in a body-worn accessory, positioned against a flat phantom, representative of the normal operating conditions expected by users and typically with a standard default audio accessory supplied with the radio.

When testing antennas with the default battery: the same test measurement with head part.

- The EUT only contains the Testing antenna, Standard battery and default body-worn accessory specified by customer. The earphone is only for testing

The results shown in this test report refer only to the sample(s) tested unless otherwise stated and the sample(s) are retained for 30 days only. The document is issued by AGC, this document cannot be reproduced except in full with our prior written permission. The more details and the authenticity of the report will be confirmed at <http://www.agc-cert.com>.

13.1.3. Antenna Location: (back view)

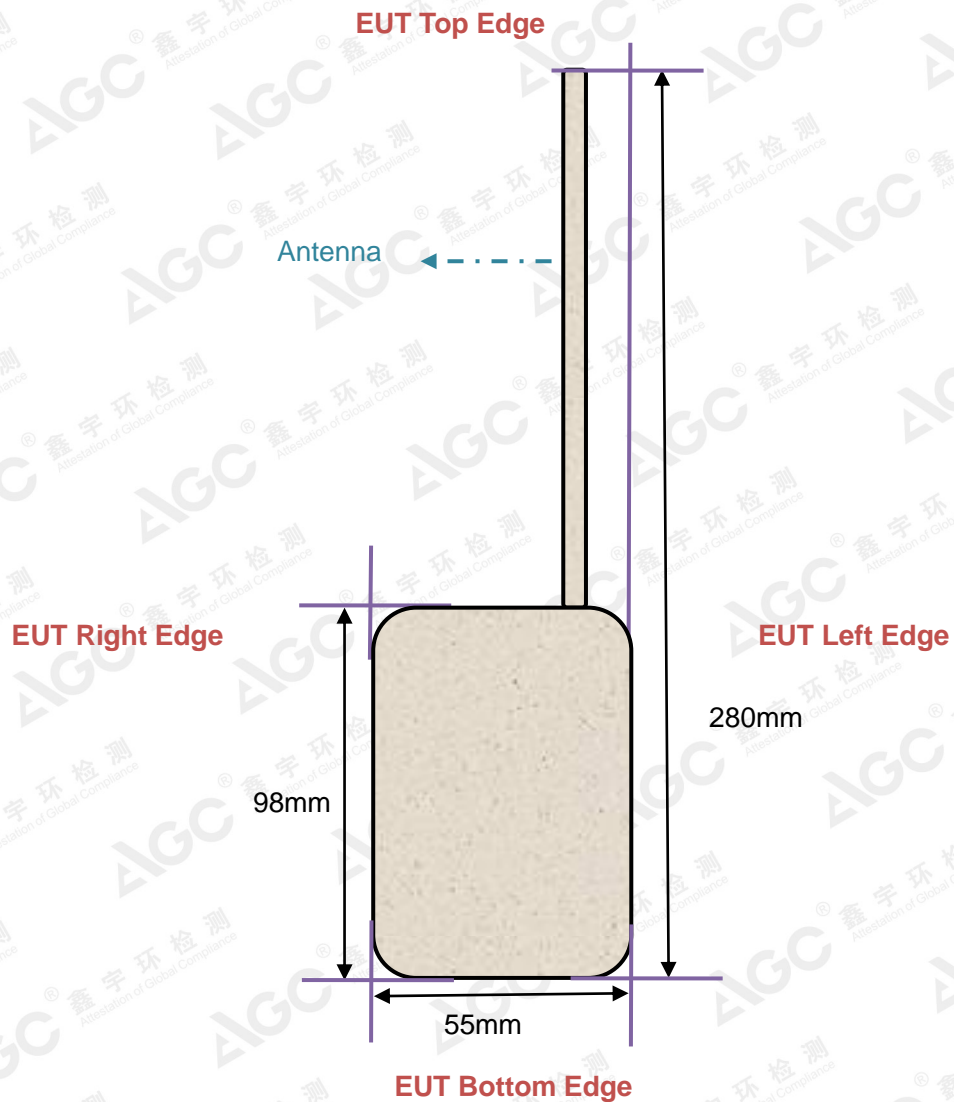

The results shown in this test report refer only to the sample(s) tested unless otherwise stated and the sample(s) are retained for 30 days only. The document is issued by AGC, this document cannot be reproduced except in full with our prior written permission. The more details and the authenticity of the report will be confirmed at <http://www.agc-cert.com>.

13.1.4. SAR Test Results Summary
UHF

SAR MEASUREMENT									
Depth of Liquid (cm):>15					Relative Humidity (%): 49.9				
Product: VHF/UHF DUAL BAND TRANSCEIVER									
Test Mode: Hold to Face with 2.5 cm separation & body back touch with clip									
Position	Freq. (MHz)	Separation (KHz)	Power Drift (±0.2dB)	SAR 1g with 100% duty Cycle (W/kg)	SAR 1g with 50% duty cycle (W/Kg)	Max. Tune-up Power (dBm)	Meas. output Power (dBm)	Scaled SAR (W/Kg)	Limit W/kg
Analog									
Face Up	479.975	12.5	-0.96	2.4	1.2	36.99	36.77	1.574	8.0
Back Touch +Belt Clip + headset	479.975		-0.33	5.98	2.99	36.99	36.77	3.393	8.0
Digital									
Face Up	400.025	12.5	-0.49	1.35	0.675	36.99	36.83	0.784	8.0
Back Touch +Belt Clip + headset	400.025		-0.03	3.02	1.51	36.99	36.83	1.578	8.0

Note:

1. During the test, EUT power is 5 W with 100% duty cycle;
2. There is just default battery and antenna in this project;

$$3. \text{Max_ Scaled} = \text{SAR_ meas} * 10^{\frac{-\text{Drift}}{10}} * \frac{P_{\text{max}}}{P_{\text{int}}} * DC$$

 P_{max} = Maximum Power(W)

 P_{int} = Initial Power(W)

Drift = DASY drift results(dB)

 SAR_{meas} = Measured 10-g Avg. SAR

DC = Transmission mode duty cycle in % where applicable 50% duty cycle is applied for PTT operation.

For conservative results, the following are applied:

 If P_{int} > P_{max}, then P_{max}/P_{int} = 1. Drift = 1 for positive drift

The results shown in this test report refer only to the sample(s) tested unless otherwise stated and the sample(s) are retained for 30 days only. The document is issued by AGC, this document cannot be reproduced except in full with our prior written permission. The more details and the authenticity of the report will be confirmed at <http://www.agc-cert.com>.

VHF
SAR MEASUREMENT

Depth of Liquid (cm):>15				Relative Humidity (%): 56.4					
Product: VHF/UHF DUAL BAND TRANSCEIVER									
Test Mode: Hold to Face with 2.5 cm separation & body back touch with clip									
Position	Freq. (MHz)	Separation (KHz)	Power Drift (±0.2dB)	SAR 1g with 100% duty Cycle (W/kg)	SAR 1g with 50% duty cycle (W/Kg)	Max. Tune-up Power (dBm)	Meas. output Power (dBm)	Scaled SAR (W/Kg)	Limit W/kg
Analog									
Face Up	155.025	12.5	-0.28	0.307	0.1535	36.99	36.85	0.170	8.0
Back Touch +Belt Clip + headset	155.025		-0.43	1.58	0.79	36.99	36.85	0.901	8.0
Digital									
Face Up	155.025	12.5	-0.12	0.155	0.0775	36.99	36.87	0.082	8.0
Back Touch +Belt Clip + headset	155.025		-0.02	0.718	0.359	36.99	36.87	0.371	8.0

Note:

1. During the test, EUT power is 5 W with 100% duty cycle;
2. There is just default battery and antenna in this project;

$$3. \text{Max_ Scaled} = \text{SAR_ meas} * 10^{\frac{-\text{Drift}}{10}} * \frac{P_ \text{max}}{P_ \text{int}} * DC$$

P_ max = Maximum Power(W)

P_ int = Initial Power(W)

Drift = DASY drift results(dB)

SAR_ meas=Measured 10-g Avg.SAR

DC = Transmission mode duty cycle in % where applicable 50% duty cycle is applied for PTT operation.

For conservative results, the following are applied:

If P_ int > P_ max, then P_ max/P_ int =1. Drift = 1 for positive drift

The results shown in this test report refer only to the sample(s) tested unless otherwise stated and the sample(s) are retained for 30 days only. The document is issued by AGC, this document cannot be reproduced except in full with our prior written permission. The more details and the authenticity of the report will be confirmed at <http://www.agc-cert.com>.

APPENDIX A. SAR SYSTEM CHECK DATA

Test Laboratory: AGC Lab

System Check Head 150MHz

DUT: Dipole 150 MHz Type: SID 150

Communication System: CW; Communication System Band: CW; Duty Cycle: 1:1;

Frequency: 150MHz; Medium parameters used: $f = 150\text{MHz}$; $\sigma = 0.77 \text{ mho/m}$; $\epsilon_r = 52.11$; $\rho = 1000 \text{ kg/m}^3$;

Phantom Type: Elliptical Phantom; Input Power=23dBm

Ambient temperature (°C): 22.1, Liquid temperature (°C): 21.5

DASY Configuration:

- Probe: ES3DV3 – SN3337; ConvF(7.88, 7.88, 7.88); Calibrated: Nov. 23,2017;
- Sensor-Surface: 3mm (Mechanical Surface Detection), $z = 1.0$,
- Electronics: DAE4 SN1398; Calibrated: Feb. 08,2018
- Phantom: ELI v5.0; Type: QDOVA002AA; Serial: TP:1108
- DASY52 52.8.7(1137); SEMCAD X 14.6.10(7164)

Test date: July 07,2018

Configuration/System Check 150MHz Head /Area Scan (10x10x1): Measurement grid: $dx=15\text{mm}$, $dy=15\text{mm}$ Maximum value of SAR (measured) = 0.849 W/kg

Configuration/System Check 150MHz Head /Zoom Scan (5x5x7)/Cube 0: Measurement grid: $dx=8\text{mm}$, $dy=8\text{mm}$, $dz=5\text{mm}$

Reference Value = 32.506 V/m; Power Drift = -0.07 dB

Peak SAR (extrapolated) = 1.30 W/kg

SAR(1 g) = 0.770 W/kg; SAR(10 g) = 0.539 W/kg

Maximum value of SAR (measured) = 0.891 W/kg

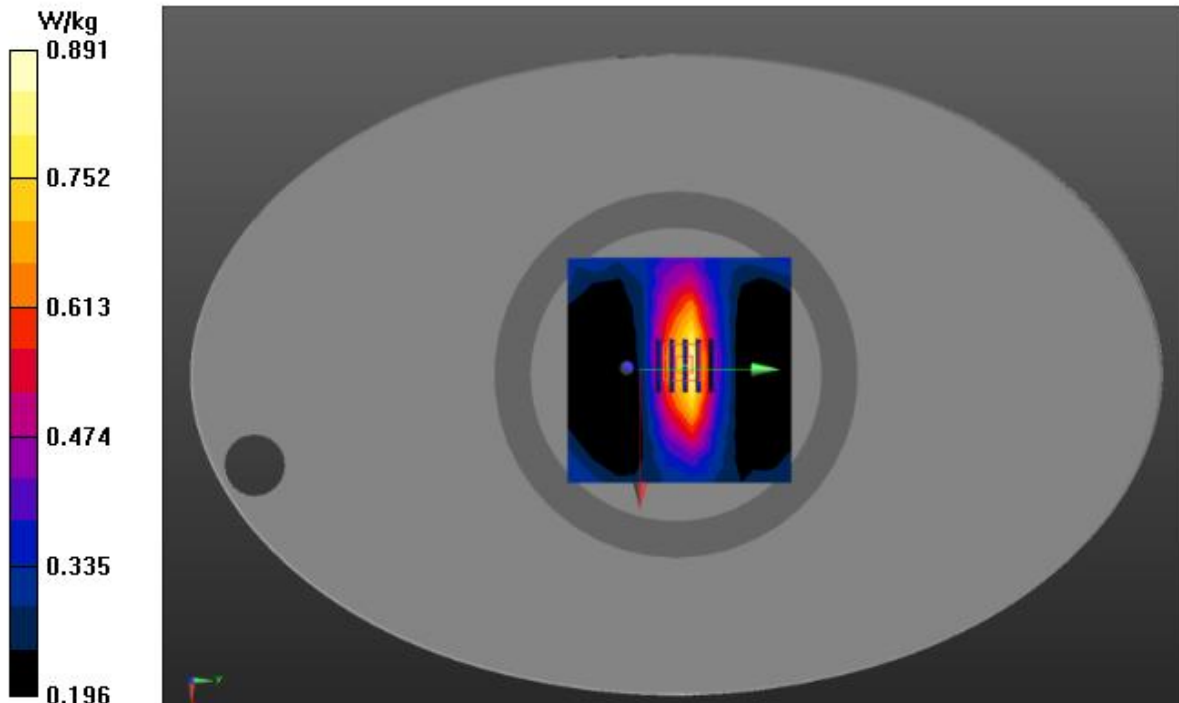

The results shown in this test report refer only to the sample(s) tested unless otherwise stated and the sample(s) are retained for 30 days only. The document is issued by AGC, this document cannot be reproduced except in full with our prior written permission. The more details and the authenticity of the report will be confirmed at <http://www.agc-cert.com>.

Test Laboratory: AGC Lab
System Check Body 150MHz
DUT: Dipole 150 MHz Type: SID 150

Test date: July 07,2018

Communication System: CW; Communication System Band: CW; Duty Cycle: 1:1;
Frequency: 150MHz; Medium parameters used: $f = 150\text{MHz}$; $\sigma = 0.80 \text{ mho/m}$; $\epsilon_r = 62.02$; $\rho = 1000 \text{ kg/m}^3$;
Phantom Type: Elliptical Phantom; Input Power=23dBm
Ambient temperature (°C): 22.1, Liquid temperature (°C): 21.6

DASY Configuration:

- Probe: ES3DV3 – SN3337; ConvF(7.37, 7.37, 7.37); Calibrated: Nov. 23,2017;
- Sensor-Surface: 3mm (Mechanical Surface Detection), $z = 1.0$,
- Electronics: DAE4 SN1398; Calibrated: Feb. 08,2018
- Phantom: ELI v5.0; Type: QDOVA002AA; Serial: TP:1108
- DASY52 52.8.7(1137); SEMCAD X 14.6.10(7164)

Configuration/System Check 150MHz Body /Area Scan (10x10x1): Measurement grid: $dx=15\text{mm}$, $dy=15\text{mm}$ Maximum value of SAR (measured) = 0.884 W/kg

Configuration/System Check 150MHz Body /Zoom Scan (5x5x7)/Cube 0: Measurement grid: $dx=8\text{mm}$, $dy=8\text{mm}$, $dz=5\text{mm}$

Reference Value = 32.839 V/m; Power Drift = -0.09 dB

Peak SAR (extrapolated) = 1.38 W/kg

SAR(1 g) = 0.786 W/kg; SAR(10 g) = 0.547 W/kg

Maximum value of SAR (measured) = 0.904 W/kg

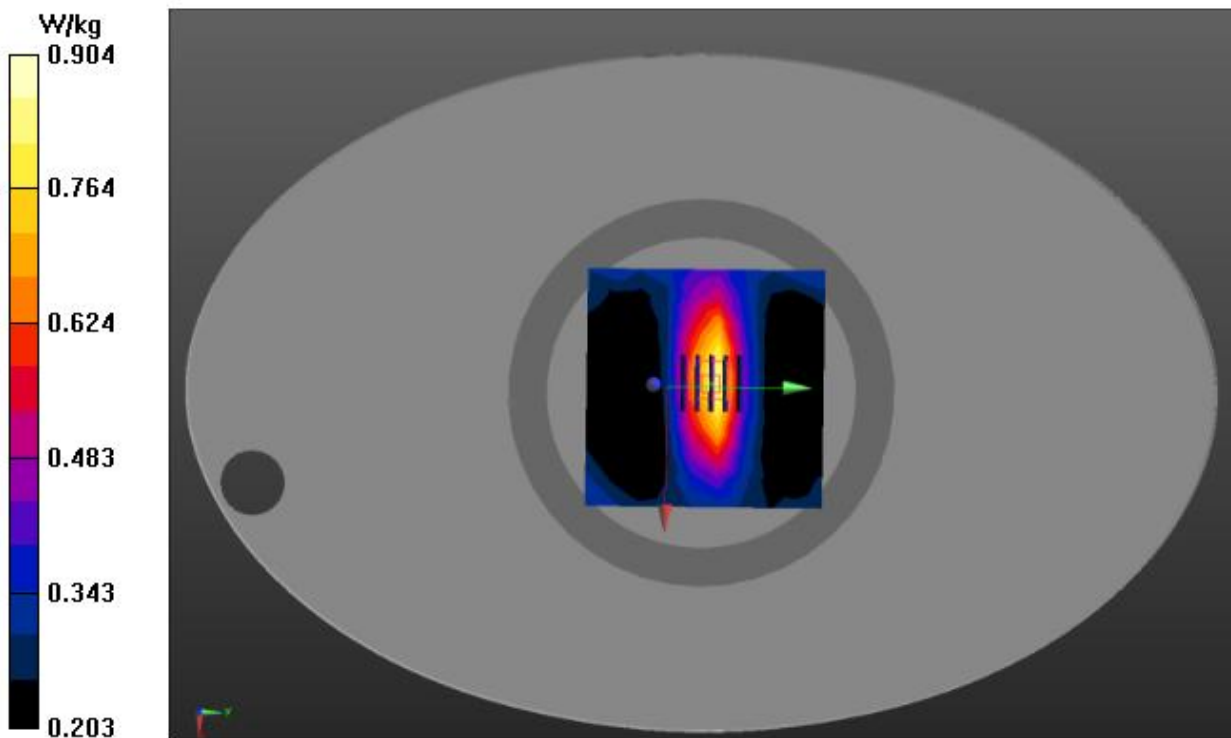

The results shown in this test report refer only to the sample(s) tested unless otherwise stated and the sample(s) are retained for 30 days only. The document is issued by AGC, this document cannot be reproduced except in full with our prior written permission. The more details and the authenticity of the report will be confirmed at <http://www.agc-cert.com>.

Test Laboratory: AGC Lab

Test date: July 04,2018

System Check Head 450MHz

DUT: Dipole 450 MHz Type: SID 450

Communication System: CW; Communication System Band: CW; Duty Cycle: 1:1;

Frequency: 450MHz; Medium parameters used: $f = 450\text{MHz}$; $\sigma = 0.87 \text{ mho/m}$; $\epsilon_r = 42.75$; $\rho = 1000 \text{ kg/m}^3$;

Phantom Type: Elliptical Phantom; Input Power=18dBm

Ambient temperature (°C): 21.8, Liquid temperature (°C): 21.3

DASY Configuration:

- Probe: ES3DV3 – SN3337; ConvF(7.06, 7.06, 7.06); Calibrated: Nov. 23,2017;
- Sensor-Surface: 3mm (Mechanical Surface Detection), $z = 1.0$,
- Electronics: DAE4 SN1398; Calibrated: Feb. 08,2018
- Phantom: ELI v5.0; Type: QDOVA002AA; Serial: TP:1108
- DASY52 52.8.7(1137); SEMCAD X 14.6.10(7164)

Configuration/System Check 450MHz Head/Area Scan (8x21x1): Measurement grid: $dx=15\text{mm}$, $dy=15\text{mm}$
Maximum value of SAR (measured) = 0.315 W/kg

Configuration/System Check 450MHz Head/Zoom Scan (5x5x7)/Cube 0: Measurement grid: $dx=8\text{mm}$, $dy=8\text{mm}$, $dz=5\text{mm}$

Reference Value = 19.162 V/m; Power Drift = 0.00 dB

Peak SAR (extrapolated) = 0.437 W/kg

SAR(1 g) = 0.280 W/kg; SAR(10 g) = 0.193 W/kg

Maximum value of SAR (measured) = 0.326 W/kg

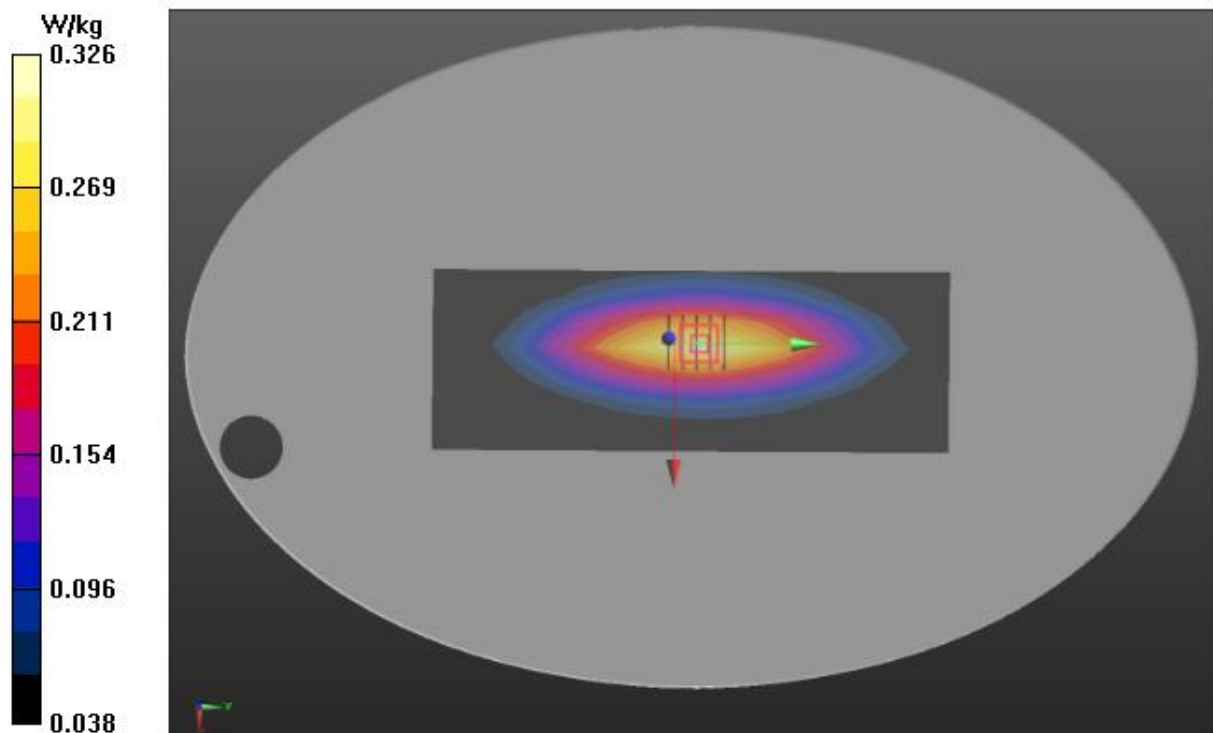

The results shown in this test report refer only to the sample(s) tested unless otherwise stated and the sample(s) are retained for 30 days only. The document is issued by AGC, this document cannot be reproduced except in full with our prior written permission. The more details and the authenticity of the report will be confirmed at <http://www.agc-cert.com>.

Test Laboratory: AGC Lab

Test date: July 04,2018

System Check Body 450MHz

DUT: Dipole 450 MHz Type: SID 450

Communication System: CW; Communication System Band: CW; Duty Cycle: 1:1;

Frequency: 450MHz; Medium parameters used: $f = 450\text{MHz}$; $\sigma = 0.93 \text{ mho/m}$; $\epsilon_r = 56.05$; $\rho = 1000 \text{ kg/m}^3$;

Phantom Type: Elliptical Phantom; Input Power=18dBm

Ambient temperature (°C): 21.8, Liquid temperature (°C): 21.5

DASY Configuration:

- Probe: ES3DV3 – SN3337; ConvF(7.27, 7.27, 7.27); Calibrated: Nov. 23,2017;
- Sensor-Surface: 3mm (Mechanical Surface Detection), $z = 1.0$,
- Electronics: DAE4 SN1398; Calibrated: Feb. 08,2018
- Phantom: ELI v5.0; Type: QDOVA002AA; Serial: TP:1108
- DASY52 52.8.7(1137); SEMCAD X 14.6.10(7164)

Configuration/System Check 450MHz Body/Area Scan (8x21x1): Measurement grid: $dx=15\text{mm}$, $dy=15\text{mm}$
Maximum value of SAR (measured) = 0.336 W/kg

Configuration/System Check 450MHz Body/Zoom Scan (5x5x7)/Cube 0: Measurement grid: $dx=8\text{mm}$,
 $dy=8\text{mm}$, $dz=5\text{mm}$

Reference Value = 19.075 V/m; Power Drift = 0.10 dB

Peak SAR (extrapolated) = 0.463 W/kg

SAR(1 g) = 0.295 W/kg; SAR(10 g) = 0.205 W/kg

Maximum value of SAR (measured) = 0.344 W/kg

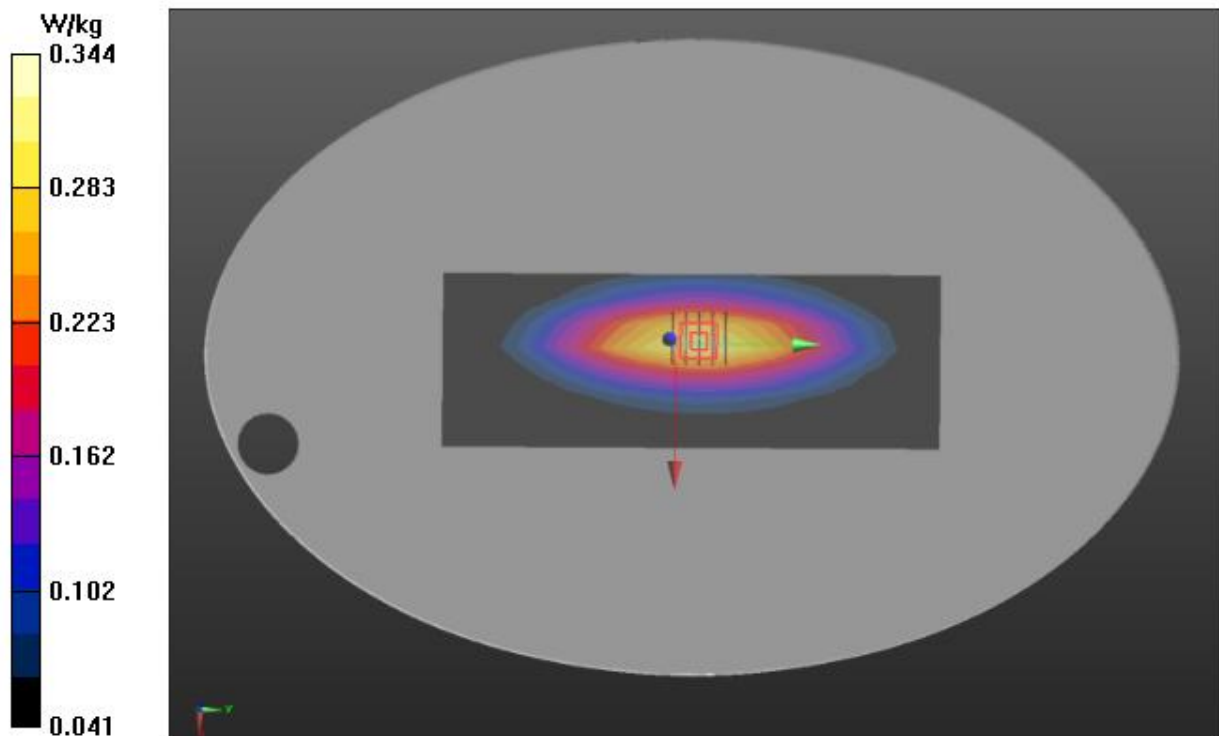

The results shown in this test report refer only to the sample(s) tested unless otherwise stated and the sample(s) are retained for 30 days only. The document is issued by AGC, this document cannot be reproduced except in full with our prior written permission. The more details and the authenticity of the report will be confirmed at <http://www.agc-cert.com>.

APPENDIX B. SAR MEASUREMENT DATA

UHF

Analog

Test Laboratory: AGC Lab

Date: July 04,2018

450 High- face up 2.5cm (12.5 KHz)

DUT: VHF/UHF DUAL BAND TRANSCEIVER; Type: DJ-MD5

Communication System: 450; Communication System Band: D450 (450.0 MHz); Duty Cycle: 1:1;
Frequency:479.975 MHz; Medium parameters used: $f = 450\text{MHz}$; $\sigma = 0.90 \text{ mho/m}$; $\epsilon_r = 41.60$; $\rho = 1000 \text{ kg/m}^3$;
Phantom Type: Elliptical Phantom
Ambient temperature (°C): 21.8, Liquid temperature (°C): 21.3

DASY Configuration:

- Probe: ES3DV3 – SN3337; ConvF(7.06, 7.06, 7.06); Calibrated: Nov. 23,2017;
- Sensor-Surface: 3mm (Mechanical Surface Detection), $z = 1.0$,
- Electronics: DAE4 SN1398; Calibrated: Feb. 08,2018
- Phantom: ELI v5.0; Type: QDOVA002AA; Serial: TP:1108
- DASY52 52.8.7(1137); SEMCAD X 14.6.10(7164)

A-12.5K-FACE UP /3/Area Scan (7x19x1): Measurement grid: $dx=15\text{mm}$, $dy=15\text{mm}$
Maximum value of SAR (measured) = 2.91 W/kg

A-12.5K-FACE UP /3/Zoom Scan (5x5x7)/Cube 0: Measurement grid: $dx=8\text{mm}$, $dy=8\text{mm}$, $dz=5\text{mm}$
Reference Value = 55.918 V/m; Power Drift = -0.96 dB

Peak SAR (extrapolated) = 3.17 W/kg

SAR(1 g) = 2.4 W/kg; SAR(10 g) = 1.8 W/kg

Maximum value of SAR (measured) = 2.67 W/kg

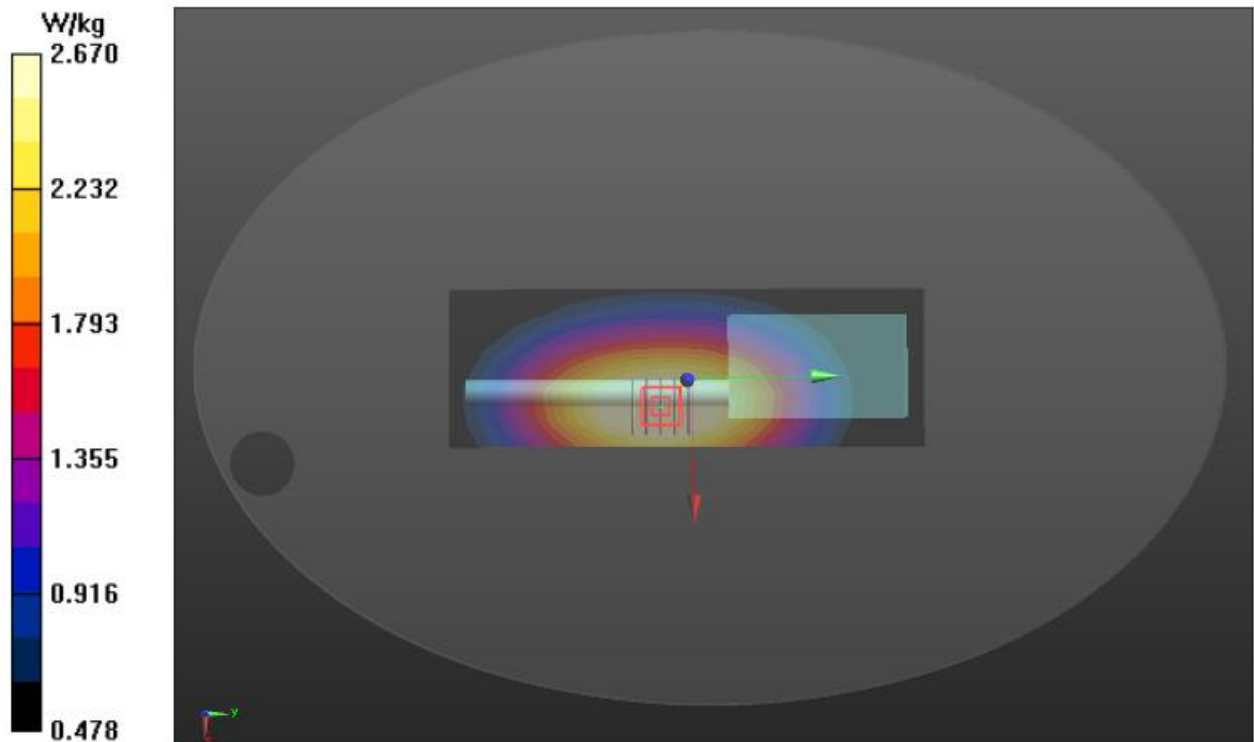

The results shown in this test report refer only to the sample(s) tested unless otherwise stated and the sample(s) are retained for 30 days only. The document is issued by AGC, this document cannot be reproduced except in full with our prior written permission. The more details and the authenticity of the report will be confirmed at <http://www.agc-cert.com>.

Test Laboratory: AGC Lab
450 High-Body –Touch (12.5 KHz)
DUT: VHF/UHF DUAL BAND TRANSCEIVER; Type: DJ-MD5

Date: July 04,2018

Communication System: 450; Communication System Band: D450 (450.0 MHz); Duty Cycle: 1:1;
Frequency:479.975 MHz; Medium parameters used: $f = 450$ MHz; $\sigma = 0.96$ mho/m; $\epsilon_r = 54.29$; $\rho = 1000$ kg/m ;
Phantom Type: Elliptical Phantom
Ambient temperature (°C): 21.8, Liquid temperature (°C): 21.5

DASY Configuration:

- Probe: ES3DV3 – SN3337; ConvF(7.27, 7.27, 7.27); Calibrated: Nov. 23,2017;
- Sensor-Surface: 3mm (Mechanical Surface Detection), $z = 1.0$,
- Electronics: DAE4 SN1398; Calibrated: Feb. 08,2018
- Phantom: ELI v5.0; Type: QDOVA002AA; Serial: TP:1108
- DASY52 52.8.7(1137); SEMCAD X 14.6.10(7164)

A-12.5K-BACK/3/Area Scan (7x19x1): Measurement grid: $dx=15$ mm, $dy=15$ mm
Maximum value of SAR (measured) = 7.58 W/kg

A-12.5K-BACK/3/Zoom Scan (5x5x7)/Cube 0: Measurement grid: $dx=8$ mm, $dy=8$ mm, $dz=5$ mm
Reference Value = 94.921 V/m; Power Drift = -0.33 dB
Peak SAR (extrapolated) = 8.58 W/kg

SAR(1 g) = 5.98 W/kg; SAR(10 g) = 4.32 W/kg
Maximum value of SAR (measured) = 6.74 W/kg

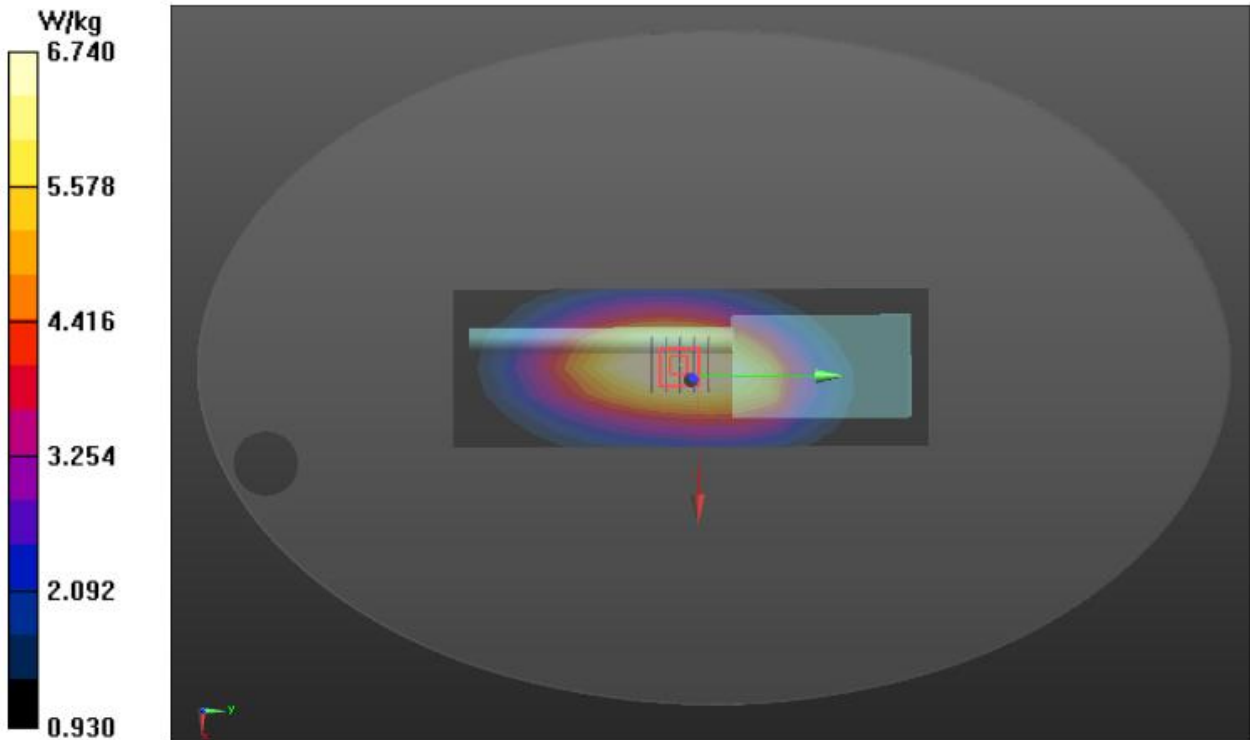

The results shown in this test report refer only to the sample(s) tested unless otherwise stated and the sample(s) are retained for 30 days only. The document is issued by AGC, this document cannot be reproduced except in full with our prior written permission. The more details and the authenticity of the report will be confirmed at <http://www.agc-cert.com>.

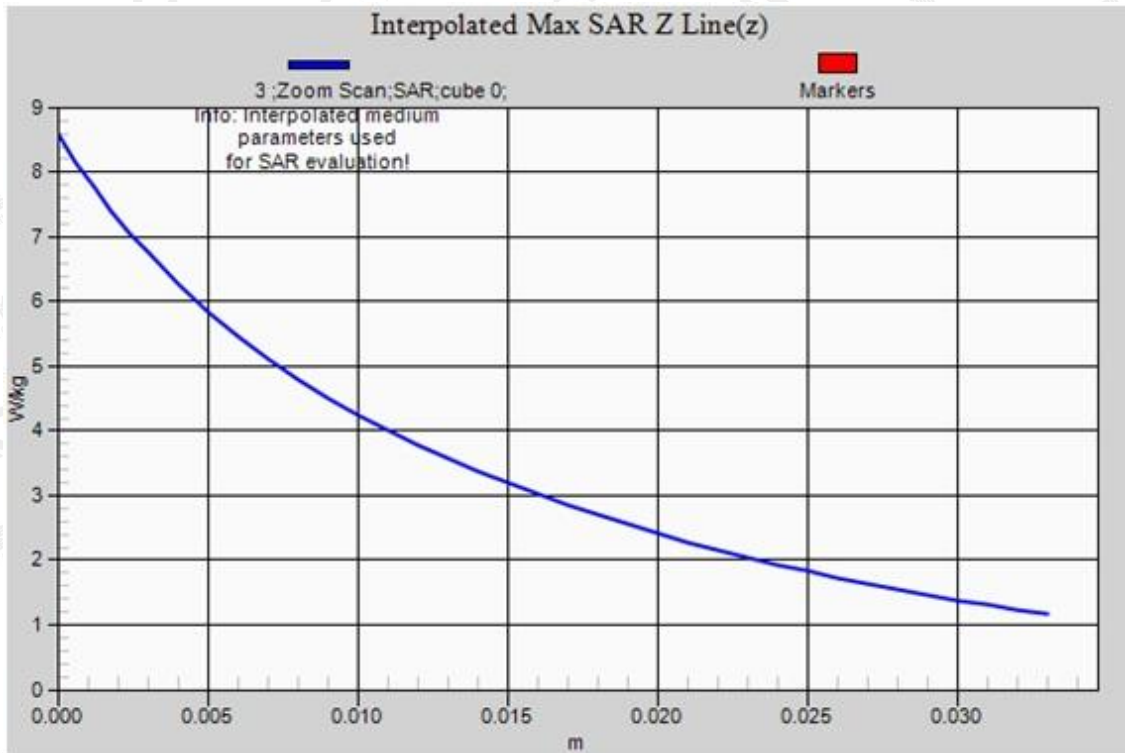

The results shown in this test report refer only to the sample(s) tested unless otherwise stated and the sample(s) are retained for 30 days only. The document is issued by AGC, this document cannot be reproduced except in full with our prior written permission. The more details and the authenticity of the report will be confirmed at <http://www.agc-cert.com>.

Digital

Test Laboratory: AGC Lab

450 Low- face up 2.5cm (12.5 KHz)

DUT: VHF/UHF DUAL BAND TRANSCEIVER; Type: DJ-MD5

Date: July 04,2018

Communication System: 450; Communication System Band: D450 (450.0 MHz); Duty Cycle: 1:1;
Frequency:400.025 MHz; Medium parameters used: $f = 450\text{MHz}$; $\sigma = 0.84 \text{ mho/m}$; $\epsilon_r = 45.06$; $\rho = 1000 \text{ kg/m}^3$;
Phantom Type: Elliptical Phantom
Ambient temperature ($^{\circ}\text{C}$): 21.8, Liquid temperature ($^{\circ}\text{C}$): 21.3

DASY Configuration:

- Probe: ES3DV3 – SN3337; ConvF(7.06, 7.06, 7.06); Calibrated: Nov. 23,2017;
- Sensor-Surface: 3mm (Mechanical Surface Detection), $z = 1.0$,
- Electronics: DAE4 SN1398; Calibrated: Feb. 08,2018
- Phantom: ELI v5.0; Type: QDOVA002AA; Serial: TP:1108
- DASY52 52.8.7(1137); SEMCAD X 14.6.10(7164)

D-12.5K FACE UP/4/Area Scan (7x19x1): Measurement grid: $dx=15\text{mm}$, $dy=15\text{mm}$

Maximum value of SAR (measured) = 1.51 W/kg

D-12.5K FACE UP/4/Zoom Scan (5x5x7)/Cube 0: Measurement grid: $dx=8\text{mm}$, $dy=8\text{mm}$, $dz=5\text{mm}$

Reference Value = 39.877 V/m; Power Drift = -0.49 dB

Peak SAR (extrapolated) = 1.77 W/kg

SAR(1 g) = 1.35 W/kg; SAR(10 g) = 1.01 W/kg

Maximum value of SAR (measured) = 1.52 W/kg

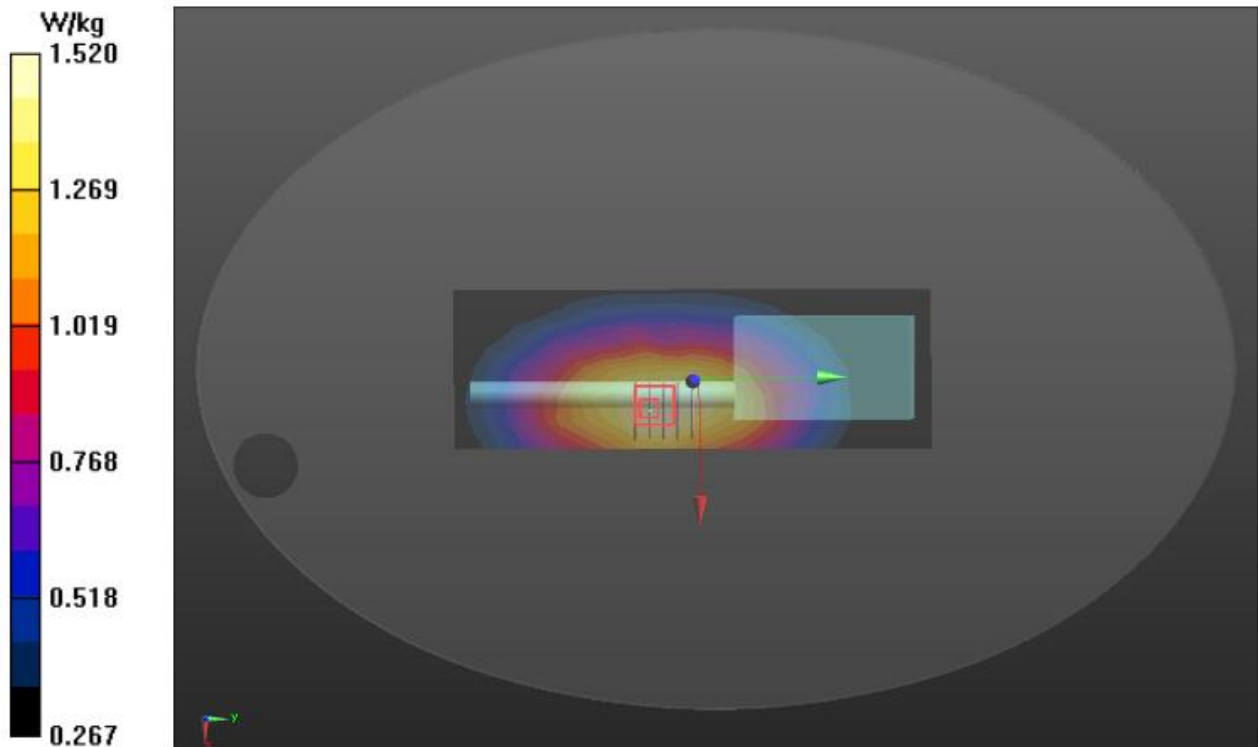

The results shown in this test report refer only to the sample(s) tested unless otherwise stated and the sample(s) are retained for 30 days only. The document is issued by AGC, this document cannot be reproduced except in full with our prior written permission. The more details and the authenticity of the report will be confirmed at <http://www.agc-cert.com>.

Test Laboratory: AGC Lab
450 Low -Body -Touch (12.5 KHz)
DUT: VHF/UHF DUAL BAND TRANSCEIVER; Type: DJ-MD5

Date: July 04,2018

Communication System: 450; Communication System Band: D450 (450.0 MHz); Duty Cycle: 1:1;
Frequency:400.025 MHz; Medium parameters used: $f = 450$ MHz; $\sigma = 0.90$ mho/m; $\epsilon_r = 58.75$; $\rho = 1000$ kg/m ;
Phantom Type: Elliptical Phantom
Ambient temperature ($^{\circ}\text{C}$): 21.8, Liquid temperature ($^{\circ}\text{C}$): 21.5

DASY Configuration:

- Probe: ES3DV3 – SN3337; ConvF(7.27, 7.27, 7.27); Calibrated: Nov. 23,2017;
- Sensor-Surface: 3mm (Mechanical Surface Detection), $z = 1.0$,
- Electronics: DAE4 SN1398; Calibrated: Feb. 08,2018
- Phantom: ELI v5.0; Type: QDOVA002AA; Serial: TP:1108
- DASY52 52.8.7(1137); SEMCAD X 14.6.10(7164)

D-12.5K-BACK/4/Area Scan (7x19x1): Measurement grid: $dx=15\text{mm}$, $dy=15\text{mm}$
Maximum value of SAR (measured) = 3.39 W/kg

D-12.5K-BACK/4/Zoom Scan (5x5x7)/Cube 0: Measurement grid: $dx=8\text{mm}$, $dy=8\text{mm}$, $dz=5\text{mm}$

Reference Value = 59.096 V/m; Power Drift = -0.03 dB

Peak SAR (extrapolated) = 4.26 W/kg

SAR(1 g) = 3.02 W/kg; SAR(10 g) = 2.22 W/kg

Maximum value of SAR (measured) = 3.44 W/kg

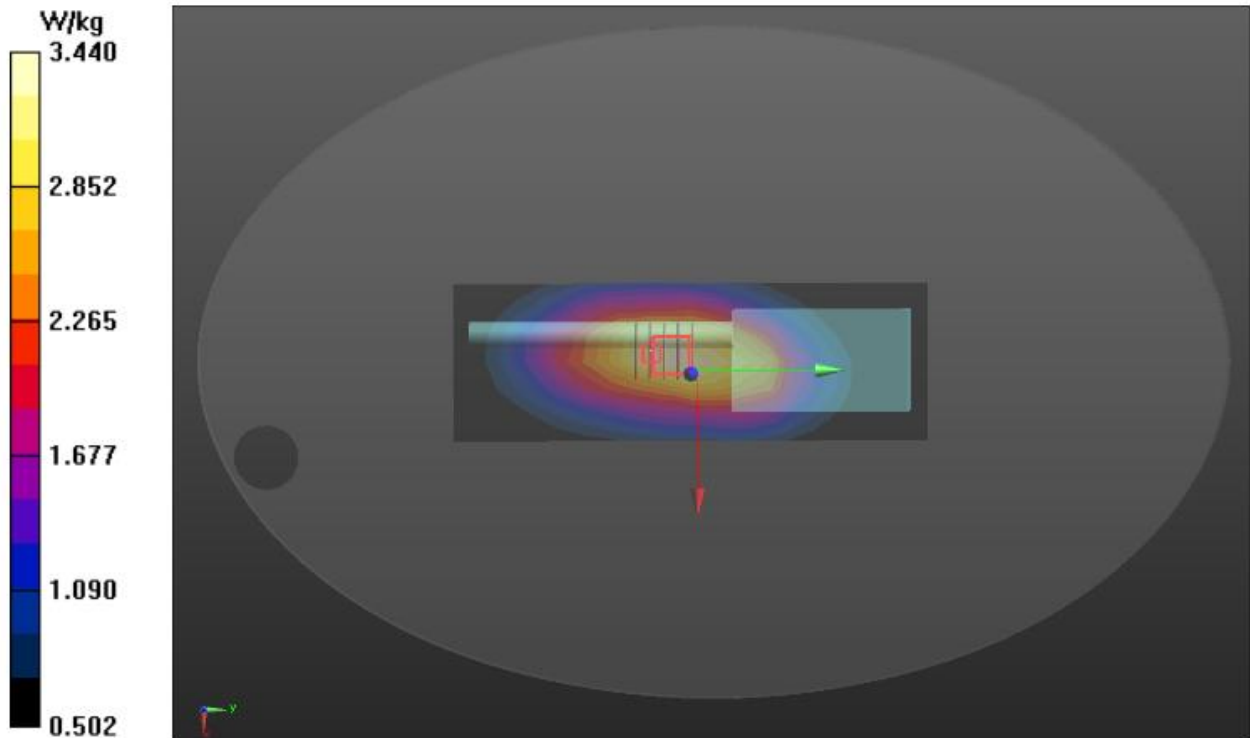

The results shown in this test report refer only to the sample(s) tested unless otherwise stated and the sample(s) are retained for 30 days only. The document is issued by AGC, this document cannot be reproduced except in full with our prior written permission. The more details and the authenticity of the report will be confirmed at <http://www.agc-cert.com>.

VHF
Analog

Test Laboratory: AGC Lab

150 Mid- face up 2.5cm (12.5 KHz)

DUT: VHF/UHF DUAL BAND TRANSCEIVER; Type: DJ-MD5

Date: July 07,2018

Communication System: 150; Communication System Band: D150 (150.0 MHz); Duty Cycle: 1:1;
Frequency: 155.025 MHz; Medium parameters used: $f = 150\text{MHz}$; $\sigma = 0.77\text{ mho/m}$; $\epsilon_r = 51.67$; $\rho = 1000\text{ kg/m}^3$;
Phantom Type: Elliptical Phantom
Ambient temperature ($^{\circ}\text{C}$): 22.1, Liquid temperature ($^{\circ}\text{C}$): 21.5

DASY Configuration:

- Probe: ES3DV3 – SN3337; ConvF(7.88, 7.88, 7.88); Calibrated: Nov. 23,2017;
- Sensor-Surface: 3mm (Mechanical Surface Detection), $z = 1.0$,
- Electronics: DAE4 SN1398; Calibrated: Feb. 08,2018
- Phantom: ELI v5.0; Type: QDOVA002AA; Serial: TP:1108
- DASY52 52.8.7(1137); SEMCAD X 14.6.10(7164)

A-12.5K-FACE UP /2/Area Scan (7x19x1): Measurement grid: $dx=15\text{mm}$, $dy=15\text{mm}$
Maximum value of SAR (measured) = 0.361 W/kg

A-12.5K-FACE UP /2/Zoom Scan (5x5x7)/Cube 0: Measurement grid: $dx=8\text{mm}$, $dy=8\text{mm}$, $dz=5\text{mm}$
Reference Value = 20.161 V/m; Power Drift = -0.28 dB

Peak SAR (extrapolated) = 0.449 W/kg

SAR(1 g) = 0.307 W/kg; SAR(10 g) = 0.233 W/kg

Maximum value of SAR (measured) = 0.342 W/kg

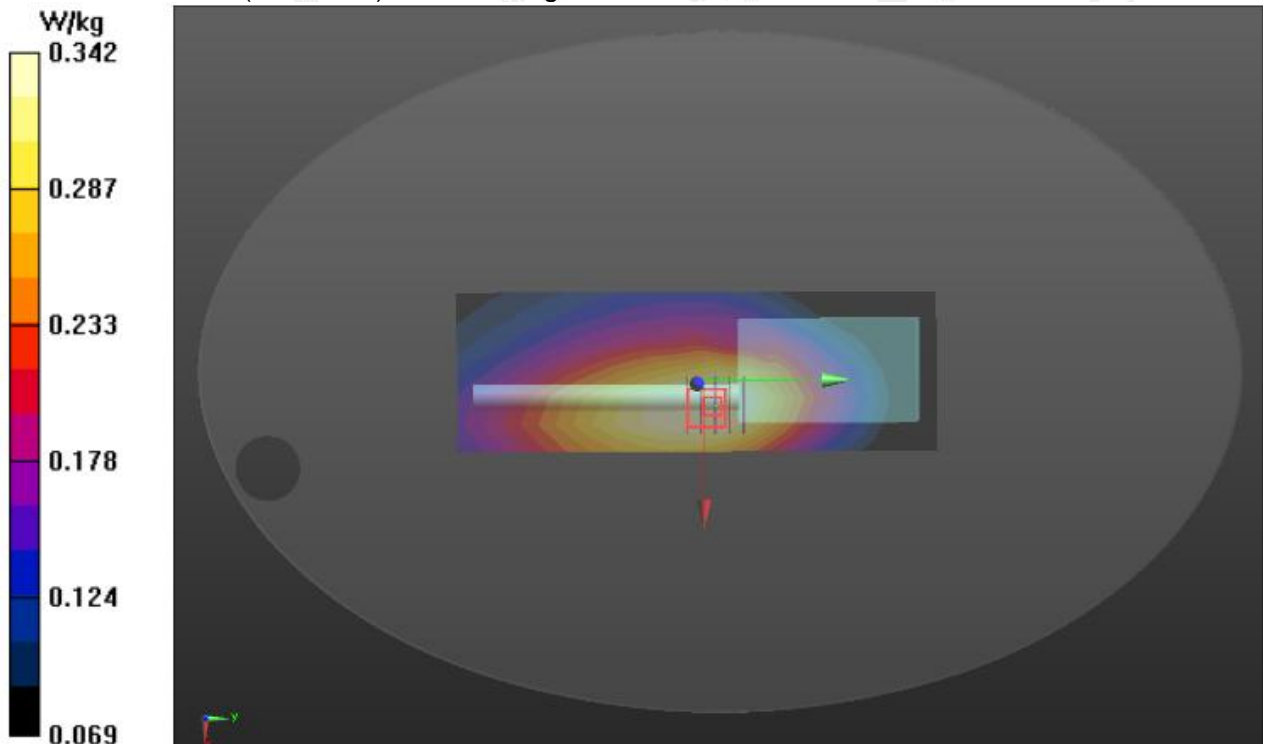

The results shown in this test report refer only to the sample(s) tested unless otherwise stated and the sample(s) are retained for 30 days only. The document is issued by AGC, this document cannot be reproduced except in full with our prior written permission. The more details and the authenticity of the report will be confirmed at <http://www.agc-cert.com>.

Test Laboratory: AGC Lab
150 Mid -Body –Touch (12.5 KHz)
DUT: VHF/UHF DUAL BAND TRANSCEIVER; Type: DJ-MD5

Date: July 07,2018

Communication System: 150; Communication System Band: D150 (150.0 MHz); Duty Cycle: 1:1;
Frequency: 155.025 MHz; Medium parameters used: $f = 150$ MHz; $\sigma = 0.81$ mho/m; $\epsilon_r = 61.38$; $\rho = 1000$ kg/m ;
Phantom Type: Elliptical Phantom
Ambient temperature (°C): 22.1, Liquid temperature (°C): 21.6

DASY Configuration:

- Probe: ES3DV3 – SN3337; ConvF(7.37, 7.37, 7.37); Calibrated: Nov. 23,2017;
- Sensor-Surface: 3mm (Mechanical Surface Detection), $z = 1.0$,
- Electronics: DAE4 SN1398; Calibrated: Feb. 08,2018
- Phantom: ELI v5.0; Type: QDOVA002AA; Serial: TP:1108
- DASY52 52.8.7(1137); SEMCAD X 14.6.10(7164)

A-12.5K-BACK/2/Area Scan (7x19x1): Measurement grid: $dx=15$ mm, $dy=15$ mm
Maximum value of SAR (measured) = 1.78 W/kg

A-12.5K-BACK/2/Zoom Scan (5x5x7)/Cube 0: Measurement grid: $dx=8$ mm, $dy=8$ mm, $dz=5$ mm
Reference Value = 45.054 V/m; Power Drift = -0.43 dB
Peak SAR (extrapolated) = 4.25 W/kg

SAR(1 g) = 1.58 W/kg; SAR(10 g) = 0.818 W/kg
Maximum value of SAR (measured) = 2.02 W/kg

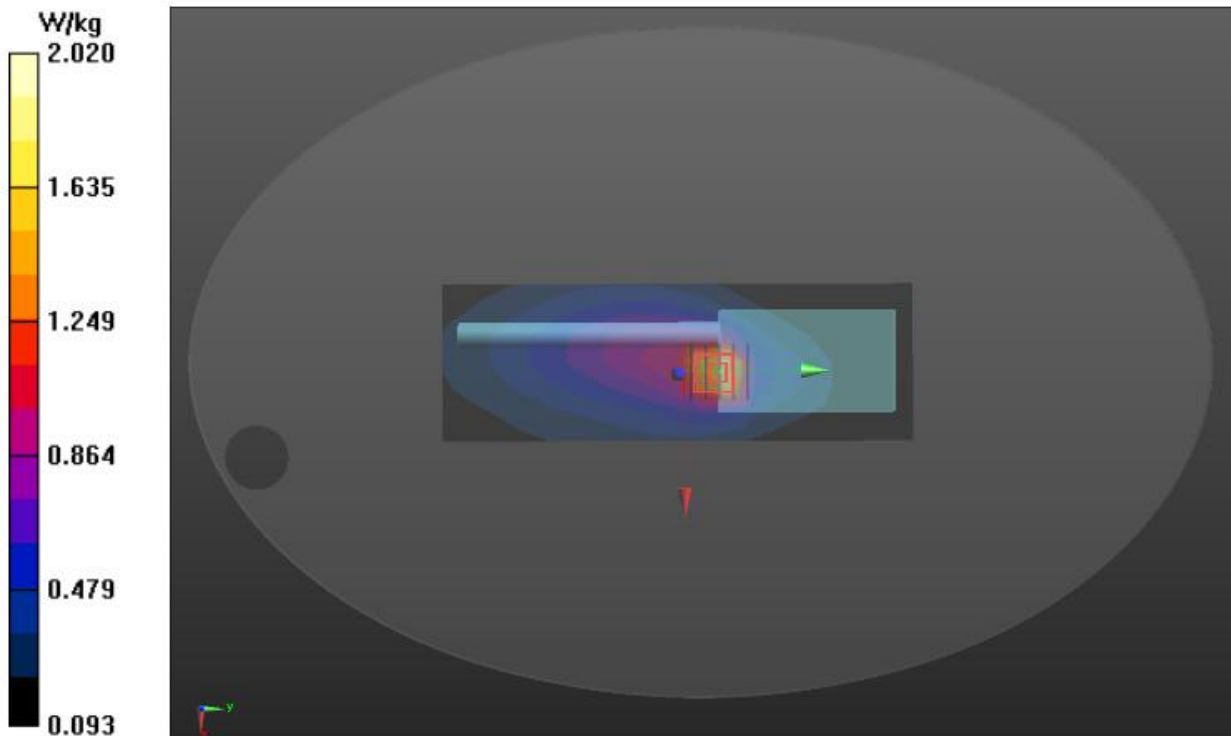

The results shown in this test report refer only to the sample(s) tested unless otherwise stated and the sample(s) are retained for 30 days only. The document is issued by AGC, this document cannot be reproduced except in full with our prior written permission. The more details and the authenticity of the report will be confirmed at <http://www.agc-cert.com>.

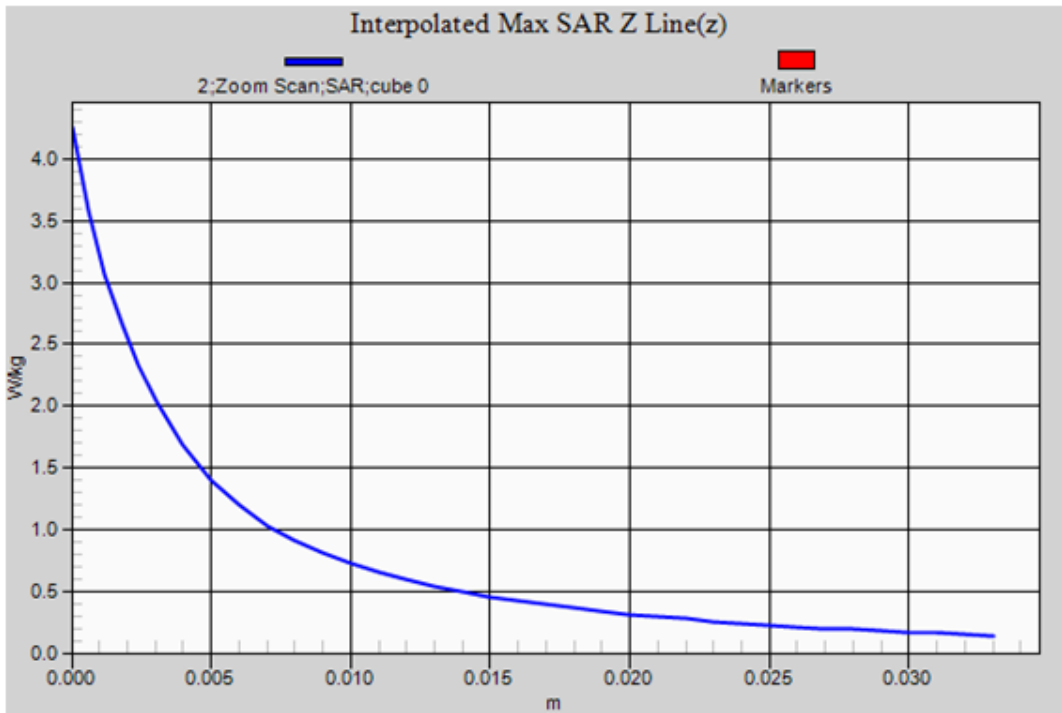

The results shown in this test report refer only to the sample(s) tested unless otherwise stated and the sample(s) are retained for 30 days only. The document is issued by AGC, this document cannot be reproduced except in full with our prior written permission. The more details and the authenticity of the report will be confirmed at <http://www.agc-cert.com>.

Digital

Test Laboratory: AGC Lab

150 Mid- face up 2.5cm (12.5 KHz)

DUT: VHF/UHF DUAL BAND TRANSCEIVER; Type: DJ-MD5

Date: July 07,2018

Communication System: 150; Communication System Band: D150 (150.0 MHz); Duty Cycle: 1:1;
Frequency: 155.025 MHz; Medium parameters used: $f = 150\text{MHz}$; $\sigma = 0.77\text{ mho/m}$; $\epsilon_r = 51.67$; $\rho = 1000\text{ kg/m}^3$;
Phantom Type: Elliptical Phantom
Ambient temperature (°C): 22.1, Liquid temperature (°C): 21.5

DASY Configuration:

- Probe: ES3DV3 – SN3337; ConvF(7.88, 7.88, 7.88); Calibrated: Nov. 23,2017;
- Sensor-Surface: 3mm (Mechanical Surface Detection), $z = 1.0$,
- Electronics: DAE4 SN1398; Calibrated: Feb. 08,2018
- Phantom: ELI v5.0; Type: QDOVA002AA; Serial: TP:1108
- DASY52 52.8.7(1137); SEMCAD X 14.6.10(7164)

D-12.5K-FACE UP/5/Area Scan (7x19x1): Measurement grid: $dx=15\text{mm}$, $dy=15\text{mm}$

Maximum value of SAR (measured) = 0.174 W/kg

D-12.5K-FACE UP/5/Zoom Scan (5x5x7)/Cube 0: Measurement grid: $dx=8\text{mm}$, $dy=8\text{mm}$, $dz=5\text{mm}$

Reference Value = 13.869 V/m; Power Drift = -0.12 dB

Peak SAR (extrapolated) = 0.234 W/kg

SAR(1 g) = 0.155 W/kg; SAR(10 g) = 0.117 W/kg

Maximum value of SAR (measured) = 0.174 W/kg

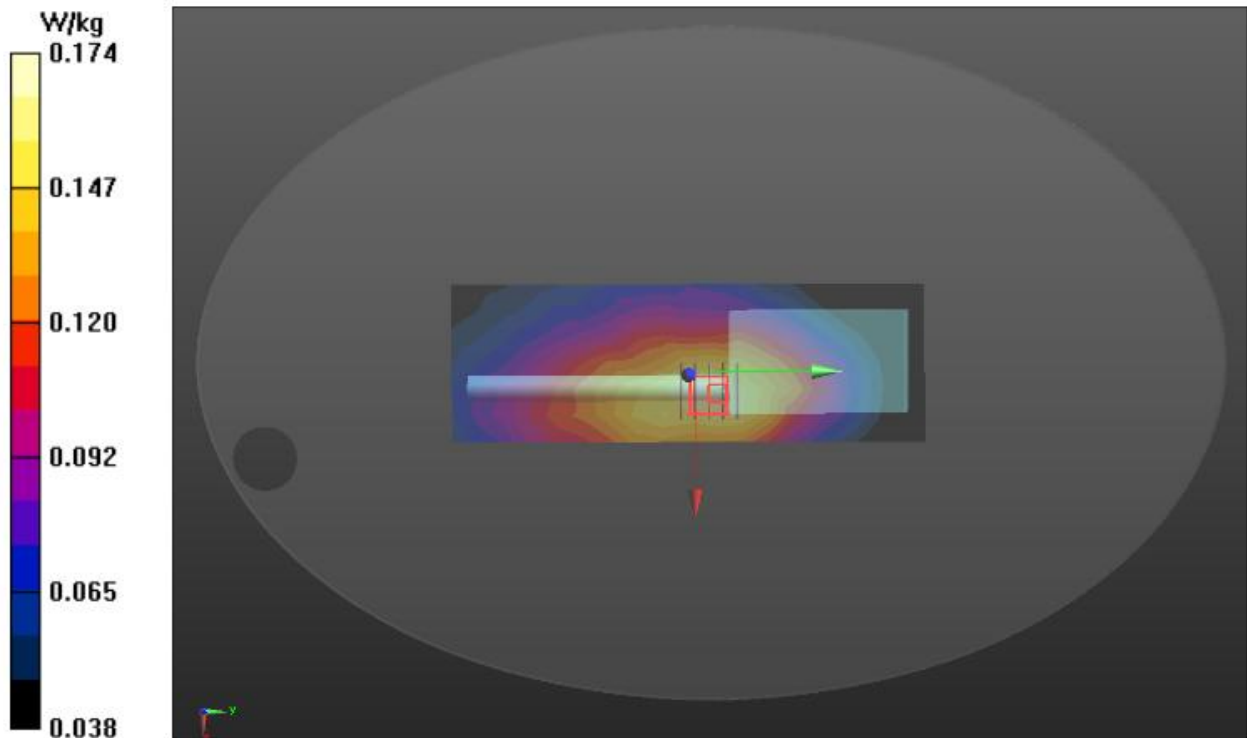

The results shown in this test report refer only to the sample(s) tested unless otherwise stated and the sample(s) are retained for 30 days only. The document is issued by AGC, this document cannot be reproduced except in full with our prior written permission. The more details and the authenticity of the report will be confirmed at <http://www.agc-cert.com>.

Test Laboratory: AGC Lab
150 Mid -Body –Touch (12.5 KHz)
DUT: VHF/UHF DUAL BAND TRANSCEIVER; Type: DJ-MD5

Date: July 07,2018

Communication System: 150; Communication System Band: D150 (150.0 MHz); Duty Cycle: 1:1;
Frequency: 155.025 MHz; Medium parameters used: $f = 150$ MHz; $\sigma = 0.81$ mho/m; $\epsilon_r = 61.38$; $\rho = 1000$ kg/m ;
Phantom Type: Elliptical Phantom
Ambient temperature (°C): 22.1, Liquid temperature (°C): 21.6

DASY Configuration:

- Probe: ES3DV3 – SN3337; ConvF(7.37, 7.37, 7.37); Calibrated: Nov. 23,2017;
- Sensor-Surface: 3mm (Mechanical Surface Detection), $z = 1.0$,
- Electronics: DAE4 SN1398; Calibrated: Feb. 08,2018
- Phantom: ELI v5.0; Type: QDOVA002AA; Serial: TP:1108
- DASY52 52.8.7(1137); SEMCAD X 14.6.10(7164)

D-12.5K-BACK/5/Area Scan (7x19x1): Measurement grid: $dx=15$ mm, $dy=15$ mm
Maximum value of SAR (measured) = 0.658 W/kg

D-12.5K-BACK/5/Zoom Scan (5x5x7)/Cube 0: Measurement grid: $dx=8$ mm, $dy=8$ mm, $dz=5$ mm
Reference Value = 28.032 V/m; Power Drift = -0.02 dB
Peak SAR (extrapolated) = 1.77 W/kg

SAR(1 g) = 0.718 W/kg; SAR(10 g) = 0.386 W/kg
Maximum value of SAR (measured) = 0.906 W/kg

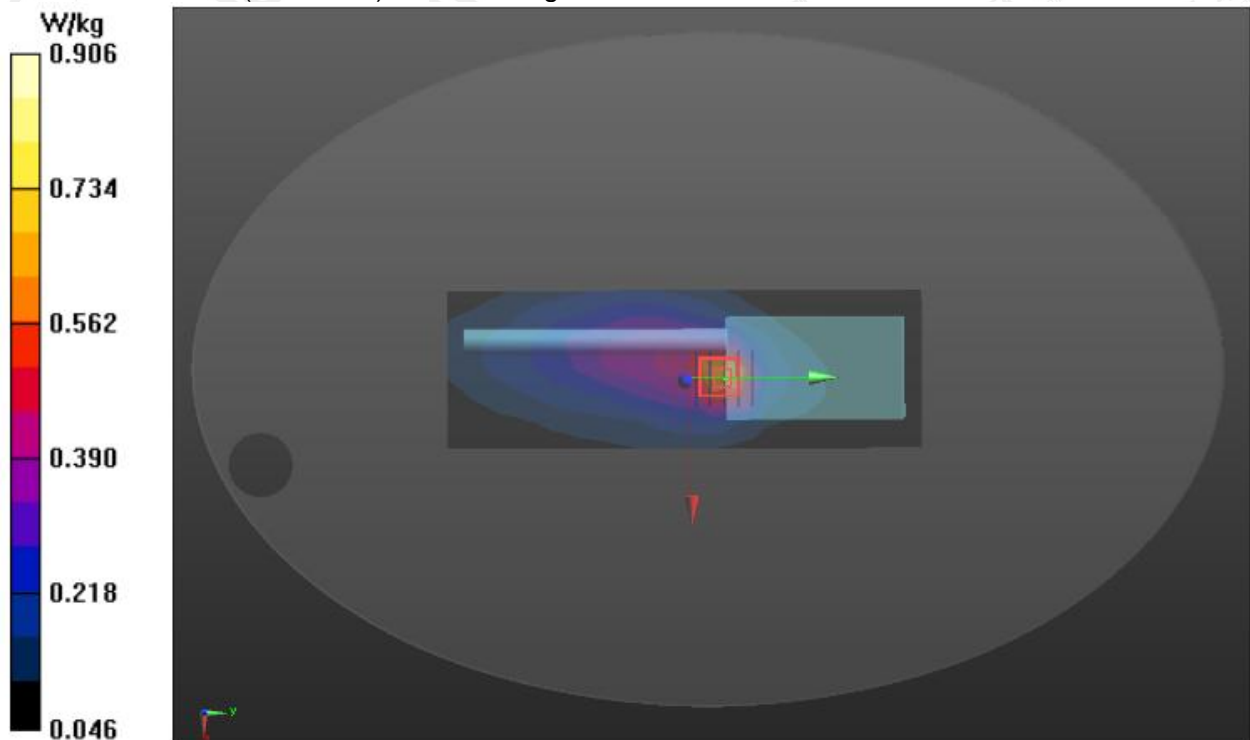

The results shown in this test report refer only to the sample(s) tested unless otherwise stated and the sample(s) are retained for 30 days only. The document is issued by AGC, this document cannot be reproduced except in full with our prior written permission. The more details and the authenticity of the report will be confirmed at <http://www.agc-cert.com>.

APPENDIX C. TEST SETUP PHOTOGRAPHS

Face Up with 2.5 cm Separation Distance.



Body Back Touch with all accessories







The thickness of EUT is 3.5cm

The results shown in this test report refer only to the sample(s) tested unless otherwise stated and the sample(s) are retained for 30 days only. The document is issued by AGC, this document cannot be reproduced except in full with our prior written permission. The more details and the authenticity of the report will be confirmed at <http://www.agc-cert.com>.

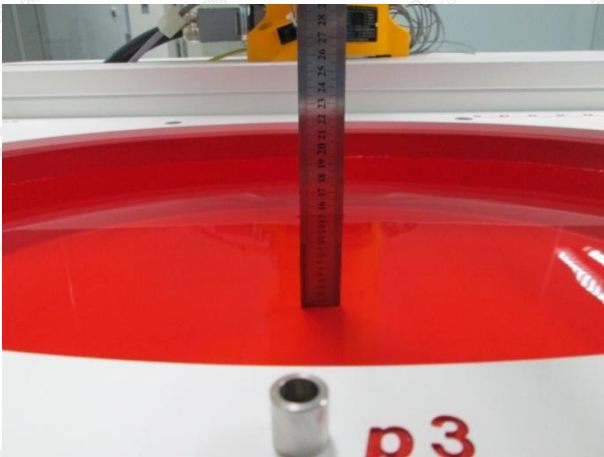
DEPTH OF THE LIQUID IN THE PHANTOM—ZOOM IN

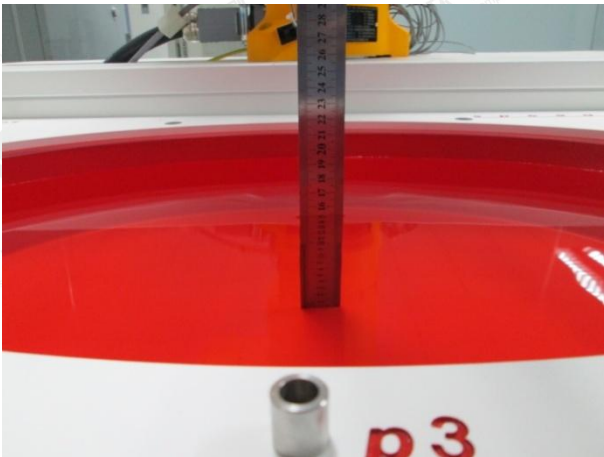
Note: The position used in the measurement were according to IEEE 1528-2013

150MHz Head	150MHz Body
 <p>A photograph showing the top view of a red liquid phantom. A vertical metal scale is placed in the center of the phantom. A small cylindrical port labeled 'p3' is visible at the bottom center of the phantom's white base.</p>	 <p>A photograph showing the side view of the red liquid phantom. A vertical metal scale is placed in the center. The port labeled 'p3' is visible on the white base.</p>
450MHz Head	450MHz Body
 <p>A photograph showing the top view of a red liquid phantom. A vertical metal scale is placed in the center of the phantom. A small cylindrical port labeled 'p3' is visible at the bottom center of the phantom's white base.</p>	 <p>A photograph showing the side view of the red liquid phantom. A vertical metal scale is placed in the center. The port labeled 'p3' is visible on the white base.</p>

The results shown in this test report refer only to the sample(s) tested unless otherwise stated and the sample(s) are retained for 30 days only. The document is issued by AGC, this document cannot be reproduced except in full with our prior written permission. The more details and the authenticity of the report will be confirmed at <http://www.agc-cert.com>.

APPENDIX D. CALIBRATION DATA

Refer to Attached files.

The results shown in this test report refer only to the sample(s) tested unless otherwise stated and the sample(s) are retained for 30 days only. The document is issued by AGC, this document cannot be reproduced except in full with our prior written permission. The more details and the authenticity of the report will be confirmed at <http://www.agc-cert.com>.