



中认信通
CHINA CERTIFICATION ICT CO., LTD (DONGGUAN)



TEST REPORT

Applicant: Alinco Incorporated, Electronics Division

Address: Yodoyabashi Dai Building 13F, 4-4-9 Koraibashi, Chuo-Ku, Osaka,
541-0043, Japan

FCC ID: PH3DJ-G46T

Product Name: UHF FM TRANSCEIVER

**Standard(s): 47 CFR Part 95 Subpart E
ANSI C63.26-2015
ANSI/TIA 603-E-2016**

The above equipment has been tested and found compliant with the requirement of the relative standards by China Certification ICT Co., Ltd (Dongguan)

Report Number: CR230743394-00A

Date Of Issue: 2023/8/22

Reviewed By: Calvin Chen

Title: RF Engineer

Approved By: Sun Zhong

Title: Manager

Test Laboratory: China Certification ICT Co., Ltd (Dongguan)

No. 113, Pingkang Road, Dalang Town, Dongguan,
Guangdong, China
Tel: +86-769-82016888

Test Facility

The Test site used by China Certification ICT Co., Ltd (Dongguan) to collect test data is located on the No. 113, Pingkang Road, Dalang Town, Dongguan, Guangdong, China.

The lab has been recognized as the FCC accredited lab under the KDB 974614 D01 and is listed in the FCC Public Access Link (PAL) database, FCC Registration No. : 442868, the FCC Designation No. : CN1314.

The lab has been recognized by Innovation, Science and Economic Development Canada to test to Canadian radio equipment requirements, the CAB identifier: CN0123.

Declarations

China Certification ICT Co., Ltd (Dongguan) is not responsible for the authenticity of any test data provided by the applicant. Data included from the applicant that may affect test results are marked with a triangle symbol “▲”. Customer model name, addresses, names, trademarks etc. are not considered data.

Unless otherwise stated the results shown in this test report refer only to the sample(s) tested.

This report cannot be reproduced except in full, without prior written approval of the Company.

This report is valid only with a valid digital signature. The digital signature may be available only under the Adobe software above version 7.0.

This report may contain data that are not covered by the accreditation scope and shall be marked with an asterisk “★”.

CONTENTS

TEST FACILITY	2
DECLARATIONS.....	2
DOCUMENT REVISION HISTORY	5
1. GENERAL INFORMATION	6
1.1 PRODUCT DESCRIPTION FOR EQUIPMENT UNDER TEST (EUT)	6
1.2 DESCRIPTION OF TEST CONFIGURATION.....	7
1.2.1 EUT Operation Condition:.....	7
1.2.2 Support Equipment List and Details	7
1.2.3 Support Cable List and Details	7
1.2.4 Block Diagram of Test Setup.....	7
1.3 MEASUREMENT UNCERTAINTY	8
2. SUMMARY OF TEST RESULTS	9
3. REQUIREMENTS AND TEST PROCEDURES	10
3.1 GMRS Frequency Accuracy	10
3.1.1 Applicable Standard.....	10
3.1.2 EUT Setup Block Diagram	10
3.1.3 Test Procedure	10
3.2 RF Output Power	12
3.2.1 Applicable Standard.....	12
3.2.2 EUT Setup Block Diagram	12
3.2.2 Test Procedure	12
3.3 GMRS Emission Types.....	13
3.3.1 Applicable Standard.....	13
3.3.2 Judgment.....	13
3.4 GMRS Authorized Bandwidth.....	14
3.4.1 Applicable Standard.....	14
3.4.2 EUT Setup Block Diagram	14
3.4.2 Test Procedure	14
3.5 GMRS Modulation Requirements	15
3.5.1 Applicable Standard.....	15
3.5.2 Test Procedure	15
3.6 GMRS Unwanted Emissions Limits	17
3.6.1 Applicable Standard.....	17
3.6.2.1 EUT Setup Block Diagram	18
3.6.2.2 Test Procedure	18
4. TEST DATA AND RESULTS	21
4.1 GMRS FREQUENCY ACCURACY.....	21
4.2 RF OUTPUT POWER.....	24
4.3 GMRS AUTHORIZED BANDWIDTH AND EMISSION MASK.....	26
4.4 GMRS MODULATION REQUIREMENT.....	29
4.5 GMRS UNWANTED EMISSIONS LIMITS	42
4.6 RADIATED EMISSION	45

5. EUT PHOTOGRAPHS	48
6. TEST SETUP PHOTOGRAPHS	49

DOCUMENT REVISION HISTORY

Revision Number	Report Number	Description of Revision	Date of Revision
1.0	CR230743394-00A	Original Report	2023/8/22

1. GENERAL INFORMATION

1.1 Product Description for Equipment under Test (EUT)

EUT Name:	UHF FM TRANSCEIVER
EUT Model:	DJ-G46T
Modulation Mode:	FM
ERP:	462 MHz Main Channels: 34.51 dBm 462 MHz interstitial channels: 34.19 dBm 467 MHz Main Channels: 34.24 dBm 467 MHz interstitial channels: 26.3 dBm
Rated Input Voltage:	DC7.4V from battery
Serial Number:	28XI-1(For radiated spurious emission test) 28XI-2(For RF conducted test)
EUT Received Date:	2023/7/28
EUT Received Status:	Good

Operation Frequency Detail:

Channel Type	Channel Number	Frequency (MHz)	Channel Type	Channel Number	Frequency (MHz)
462 MHz Main Channels	1	462.5500	467 MHz Main Channels	1	467.5500
	2	462.5750		2	467.5750
	3	462.6000		3	467.6000
	4	462.6250		4	467.6250
	5	462.6500		5	467.6500
	6	462.6750		6	467.6750
	7	462.7000		7	467.7000
	8	462.7250		8	467.7250
462 MHz interstitial channels	1	462.5625	467 MHz interstitial channels	1	467.5625
	2	462.5875		2	467.5875
	3	462.6125		3	467.6125
	4	462.6375		4	467.6375
	5	462.6625		5	467.6625
	6	462.6875		6	467.6875
	7	462.7125		7	467.7125

Per C63.26-2015, section 5.1, the above frequencies in bold were performed the test.

Antenna Information Detail ▲ :

Antenna Type	input impedance (Ohm)	Frequency Range	Antenna Gain
Monopole	50	400-480MHz	0 dBi(-2.15dBd)

Accessory Information:

Accessory Description	Manufacturer	Model	Parameters
Adapter	ALINCO	SAW06F-120-0500UD	Input: 100-240V 50/60Hz 0.25A Output: 12V 0.5A
Charger Base	ALINCO	EDC-314	Input: DC 12-15V 450mA Output: DC 8.4V 500mA

1.2 Description of Test Configuration

1.2.1 EUT Operation Condition:

EUT Operation Mode:	The system was configured for testing in Engineering Mode, which was provided by the manufacturer.
Equipment Modifications:	No
EUT Exercise Software:	No

1.2.2 Support Equipment List and Details

Manufacturer	Description	Model	Serial Number
Fenfei	Coaxial Load	N-J-10W	21113006001

1.2.3 Support Cable List and Details

Cable Description	Shielding Type	Ferrite Core	Length (m)	From Port	To
/	/	/	/	/	/

1.2.4 Block Diagram of Test Setup

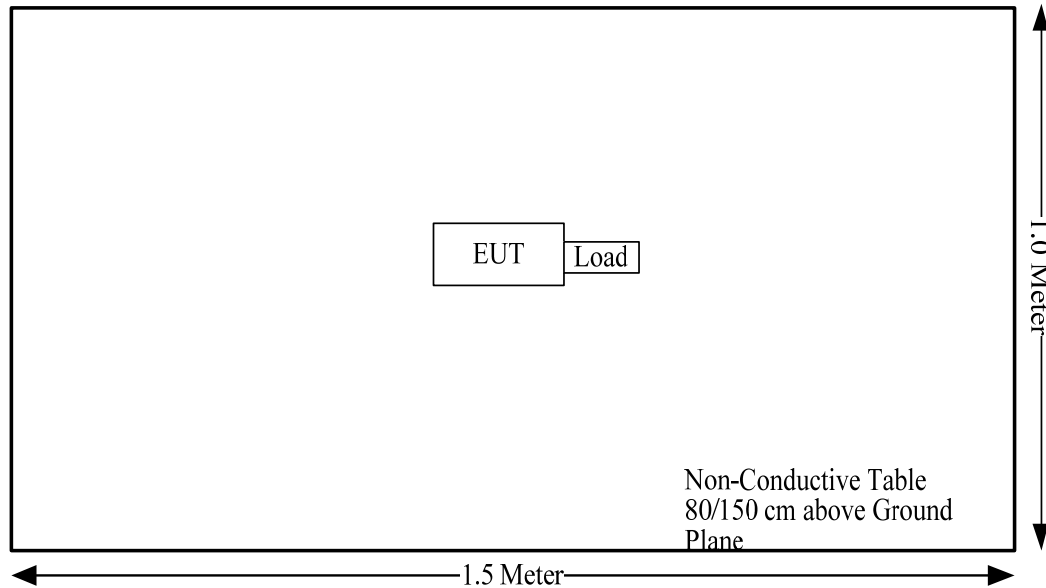

1.3 Measurement Uncertainty

Otherwise required by the applicant or Product Regulations, Decision Rule in this report did not consider the uncertainty. The extended uncertainty given in this report is obtained by combining the standard uncertainty times the coverage factor K with the 95% confidence interval.

Parameter	Measurement Uncertainty
Occupied Channel Bandwidth	±5 %
RF output power, conducted	±0.61dB
Power Spectral Density, conducted	±0.61 dB
Unwanted Emissions, radiated	30M~200MHz: 4.15 dB,200M~1GHz: 5.61 dB,1G~6GHz: 5.14 dB, 6G~18GHz: 5.93 dB,18G~26.5G:5.47 dB,26.5G~40G:5.63 dB
Unwanted Emissions, conducted	±1.26 dB
Temperature	±1 °C
Humidity	±5%
DC and low frequency voltages	±0.4%
Duty Cycle	1%
RF Frequency	±0.082×10 ⁻⁶
Audio Frequency/Low Pass Filter Response	4.02%
Modulation Limiting	1.19%

2. SUMMARY OF TEST RESULTS

Standard/Rule(s)	Description of Test	Results
§2.1055(d), §95.1765	GMRS Frequency Accuracy	Compliant
§2.1046, §95.1767	RF Output Power	Compliant
§95.1771	GMRS Emission Types	Compliant
§2.1049, §95.1773	GMRS Authorized Bandwidth	Compliant
§95.1779	Emission Mask	Compliant
§2.1047, §95.1775	GMRS Modulation Requirements	Compliant
§2.1051, §95.1779	GMRS Unwanted Emissions Limits- Spurious Emissions At Antenna Terminals	Compliant
§2.1053, §95.1779	GMRS Unwanted Emissions Limits- Radiated Spurious Emissions	Compliant

3. REQUIREMENTS AND TEST PROCEDURES

3.1 GMRS Frequency Accuracy

3.1.1 Applicable Standard

FCC §95.1765

Each GMRS transmitter type must be designed to comply with the frequency accuracy requirements in this section under normal operating conditions. Operators of GMRS stations must also ensure compliance with these requirements.

(a) The carrier frequency of each GMRS transmitter transmitting an emission with an occupied bandwidth greater than 12.5 kHz must remain within 5 parts-per-million (ppm) of the channel center frequencies listed in §95.1763 under normal operating conditions.

(b) The carrier frequency of each GMRS transmitter transmitting an emission with an occupied bandwidth of 12.5 kHz or less must remain within 2.5 ppm of the channel center frequencies listed in §95.1763 under normal operating conditions.

3.1.2 EUT Setup Block Diagram

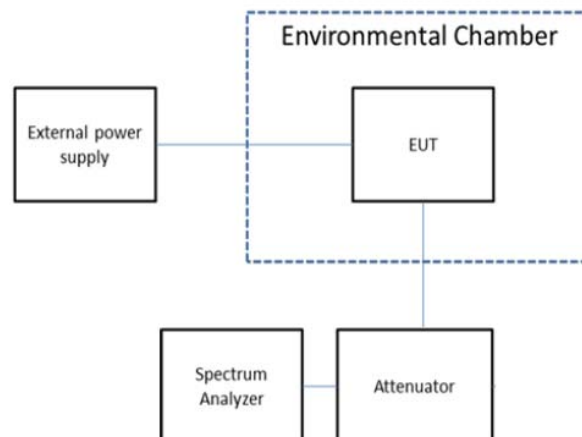

3.1.3 Test Procedure

C63.26-2015, Clause 5.6

Frequency stability is a measure of the frequency drift due to temperature and supply voltage variations, with reference to the frequency measured at +20 °C and rated supply voltage. The operating carrier frequency shall be set up in accordance with the manufacturer's published operation and instruction manual prior to the commencement of these tests. No adjustment of any frequency determining circuit element shall be made subsequent to this initial set-up. Frequency stability is tested:

- At 10 °C intervals of temperatures between -30 °C and +50 °C at the manufacturer's rated supply voltage, and
- At +20 °C temperature and ±15% supply voltage variations. If a product is specified to operate over a range of input voltage then the -15% variation is applied to the lowermost voltage and the +15% is applied to the uppermost voltage. During the test all necessary settings, adjustments and control of the EUT have to be performed without disturbing the test environment, i.e., without opening the environmental chamber. The frequency stabilities can be maintained to a lesser temperature range provided that the transmitter is automatically inhibited from operating outside the lesser temperature range. For handheld equipment that is only capable of operating from internal batteries and the supply voltage cannot be varied, the frequency

stability tests shall be performed at the nominal battery voltage and the battery end point voltage specified by the manufacturer. An external supply voltage can be used and set at the internal battery nominal voltage, and again at the battery operating end point voltage which shall be specified by the equipment manufacturer.

If an unmodulated carrier is not available, the mean frequency of a modulated carrier can be obtained by using a frequency counter with gating time set to an appropriately large multiple of bit periods (gating time depending on the required accuracy). Full details on the choice of values shall be included in the test report.

3.2 RF Output Power

3.2.1 Applicable Standard

FCC §95.1767

This section contains transmitting power limits for GMRS stations. The maximum transmitting power depends on which channels are being used and the type of station.

(a) 462/467 MHz main channels. The limits in this paragraph apply to stations transmitting on any of the 462 MHz main channels or any of the 467 MHz main channels. Each GMRS transmitter type must be capable of operating within the allowable power range. GMRS licensees are responsible for ensuring that their GMRS stations operate in compliance with these limits.

(1) The transmitter output power of mobile, repeater and base stations must not exceed 50 Watts.

(2) The transmitter output power of fixed stations must not exceed 15 Watts.

(b) 462 MHz interstitial channels. The effective radiated power (ERP) of mobile, hand-held portable and base stations transmitting on the 462 MHz interstitial channels must not exceed 5 Watts.

(c) 467 MHz interstitial channels. The effective radiated power (ERP) of hand-held portable units transmitting on the 467 MHz interstitial channels must not exceed 0.5 Watt. Each GMRS transmitter type capable of transmitting on these channels must be designed such that the ERP does not exceed 0.5 Watt.

3.2.2 EUT Setup Block Diagram



3.2.2 Test Procedure

C63.26-2015, Clause 5.2.3.3

This procedure can be used to measure the peak power in either a CW-like or noise-like narrowband RF signal. The measurement instrument must have a RBW that is greater than or equal to the OBW of the signal to be measured and a VBW $\geq 3 \times$ RBW.

- a) Set the RBW \geq OBW.
- b) Set VBW $\geq 3 \times$ RBW.
- c) Set span $\geq 2 \times$ OBW.
- d) Sweep time $\geq 10 \times$ (number of points in sweep) \times (transmission symbol period).
- e) Detector = peak.
- f) Trace mode = max hold.
- g) Allow trace to fully stabilize.
- h) Use the peak marker function to determine the peak amplitude level

3.3 GMRS Emission Types

3.3.1 Applicable Standard

FCC §95.1771

Each GMRS transmitter type must be designed to satisfy the emission capability rules in this section. Operation of GMRS stations must also be in compliance with these rules.

- (a) Each GMRS transmitter type must have the capability to transmit F3E or G3E emissions.
- (b) Only emission types A1D, F1D, G1D, H1D, J1D, R1D, A3E, F3E, G3E, H3E, J3E, R3E, F2D, and G2D are authorized for use in the GMRS. Equipment for which certification is sought under this subpart may have capabilities to transmit other emission types intended for use in other services, provided that these emission types can be deactivated when the equipment is used in the GMRS.

3.3.2 Judgment

Emission type is F3E.

3.4 GMRS Authorized Bandwidth

3.4.1 Applicable Standard

FCC §95.1773

Each GMRS transmitter type must be designed such that the occupied bandwidth does not exceed the authorized bandwidth for the channels used. Operation of GMRS stations must also be in compliance with these requirements.

(a) Main channels. The authorized bandwidth is 20 kHz for GMRS transmitters operating on any of the 462 MHz main channels (see §95.1763(a)) or any of the 467 MHz main channels (see §95.1763(c)).

(b) Interstitial channels. The authorized bandwidth is 20 kHz for GMRS transmitters operating on any of the 462 MHz interstitial channels (see §95.1763(b)) and is 12.5 kHz for GMRS transmitters operating on any of the 467 MHz interstitial channels (see §95.1763(d)).

(c) Digital data transmissions. Digital data transmissions are limited to the 462 MHz main channels and interstitial channels in the 462 MHz and 467 MHz bands.

3.4.2 EUT Setup Block Diagram

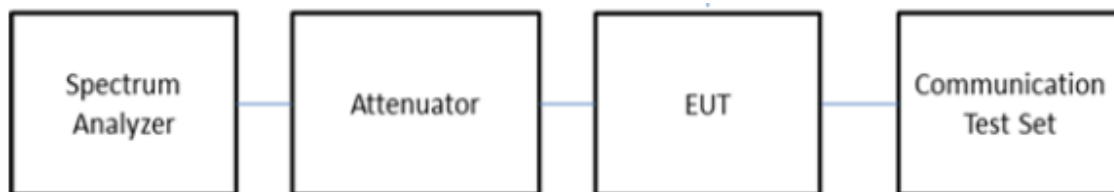

3.4.2 Test Procedure

C63.26-2015, Clause 5.4.4

The OBW is the frequency bandwidth such that, below its lower and above its upper frequency limits, the mean powers are each equal to 0.5% of the total mean power of the given emission.

The following procedure shall be used for measuring (99%) power bandwidth:

a) The spectrum analyzer center frequency is set to the nominal EUT channel center frequency. The frequency span for the spectrum analyzer shall be set wide enough to capture all modulation products including the emission skirts (typically a span of $1.5 \times \text{OBW}$ is sufficient).

b) The nominal IF filter 3 dB bandwidth (RBW) shall be in the range of 1% to 5% of the anticipated OBW, and the VBW shall be set $\geq 3 \times \text{RBW}$.

c) Set the reference level of the instrument as required to prevent the signal amplitude from exceeding the maximum spectrum analyzer input mixer level for linear operation. See guidance provided in 4.2.3. NOTE—Step a), step b), and step c) may require iteration to adjust within the specified tolerances.

d) Set the detection mode to peak, and the trace mode to max-hold.

e) If the instrument does not have a 99% OBW function, recover the trace data points and sum directly in linear power terms. Place the recovered amplitude data points, beginning at the lowest frequency, in a running sum until 0.5% of the total is reached. Record that frequency as the lower OBW frequency. Repeat the process until 99.5% of the total is reached and record that frequency as the upper OBW frequency. The 99% power OBW can be determined by computing the difference these two frequencies.

f) The OBW shall be reported and plot(s) of the measuring instrument display shall be provided with the test report. The frequency and amplitude axis and scale shall be clearly labeled. Tabular data can be reported in addition to the plot(s).

3.5 GMRS Modulation Requirements

3.5.1 Applicable Standard

FCC §95.1775

Each GMRS transmitter type must be designed to satisfy the modulation requirements in this section. Operation of GMRS stations must also be in compliance with these requirements.

(a) Main channels. The peak frequency deviation for emissions to be transmitted on the main channels must not exceed ± 5 kHz.

(b) 462 MHz interstitial channels. The peak frequency deviation for emissions to be transmitted on the 462 MHz interstitial channels must not exceed ± 5 kHz.

(c) 467 MHz interstitial channels. The peak frequency deviation for emissions to be transmitted on the 467 MHz interstitial channels must not exceed ± 2.5 kHz, and the highest audio frequency contributing substantially to modulation must not exceed 3.125 kHz.

(d) Overmodulation. Each GMRS transmitter type, except for a mobile station transmitter type with a transmitter power output of 2.5 W or less, must automatically prevent a higher than normal audio level from causing overmodulation.

(e) Audio filter. Each GMRS transmitter type must include audio frequency low pass filtering, unless it complies with the applicable paragraphs of §95.1779 (without filtering).

(1) The filter must be between the modulation limiter and the modulated stage of the transmitter.

(2) At any frequency (f in kHz) between 3 and 20 kHz, the filter must have an attenuation of at least 60 log ($f/3$) dB more than the attenuation at 1 kHz. Above 20 kHz, it must have an attenuation of at least 50 dB more than the attenuation at 1 kHz.

3.5.2 Test Procedure

According to ANSI C63.26-2015 Section 5.3.2: Modulation limiting test methodology

Modulation limiting is the ability of a transmitter circuit to limit the transmitter from producing deviations in excess of a rated system deviation.

- a) Connect the equipment as illustrated in Figure 1.
- b) Adjust the transmitter per the manufacturer's procedure for full rated system deviation.
- c) Set the test receiver to measure peak positive deviation. Set the audio bandwidth for ≤ 0.25 Hz to ≥ 15000 Hz. Turn the de-emphasis function off.
- d) Apply a 1000 Hz modulating signal to the transmitter from the audio frequency generator, and adjust the level to obtain 60% of full rated system deviation. This is the 0 dB reference level.
- e) Increase the level from the audio generator by 20 dB in 5 dB increments recording the deviation as measured from the test receiver in each step. Verify that the audio level used to make the OBW measurement is included in the sweep.
- f) Repeat for step e) at 300 Hz, 2500 Hz and 3000 Hz at a minimum using the 0 dB reference level obtained in step d).
- g) Set the test receiver to measure peak negative deviation and repeat step d) through step f).
- h) The values recorded in step f) and step g) are the modulation limiting.
- i) Plot the data set as a percentage of deviation relative to the 0 dB reference point versus input voltage.

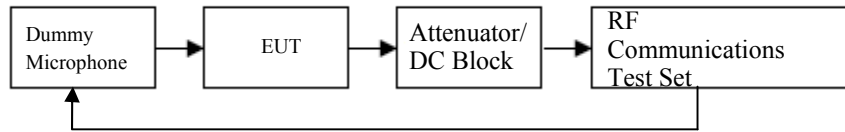

According to ANSI C63.26-2015 Section 5.3.3: Audio frequency response test methodology—Constant Input

- Connect the equipment as illustrated in Figure 3.
- Set the test receiver to measure peak positive deviation. Set the audio bandwidth for ≤ 50 Hz to $\geq 15\ 000$ Hz. Turn the de-emphasis function off.
- Adjust the transmitter per the manufacturer's procedure for full rated system deviation.
- Apply a 1000 Hz tone and adjust the audio frequency generator to produce 20% of the rated system deviation.
- Set the test receiver to measure rms deviation and record the deviation reading as DEV_{REF} .
- Set the audio frequency generator to the desired test frequency between 300 Hz and 3000 Hz.

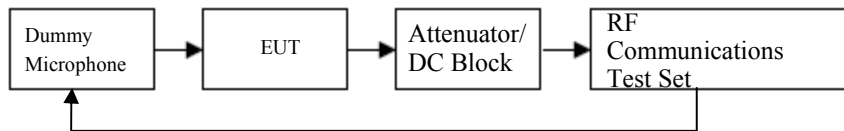

According to ANSI/TIA 603-E-2016 Section 2.2.15: Audio Low Pass Filter Response

- Connect the equipment as illustrated.
- Connect the Audio Generator as close as possible the input of the post limiter low pass filter within the transmitter under test.
- Connect the RF Communications Test Set to the output of the post limiter low pass filter within the transmitter under test.
- Apply a 1000 Hz tone from the audio frequency generator and adjust the level per manufacturer's specifications.
- Record the dB level of the 1000 Hz spectral line on the RF Communications Test Set as LEV_{REF} .
- Set the audio frequency generator to the desired test frequency between 3000 Hz and the upper low pass filter limit.
- Record RF Communications Test Set levels, at the test frequency in step f).
- Record the dB level on the RF Communications Test Set as LEV_{FREQ} .

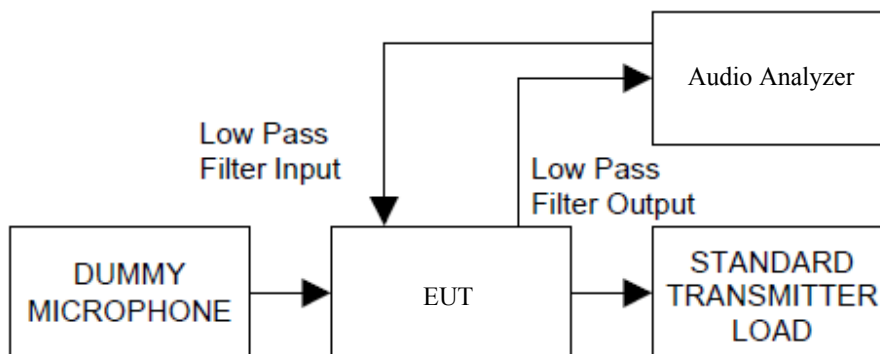

3.6 GMRS Unwanted Emissions Limits

3.6.1 Applicable Standard

FCC §95.1779

Each GMRS transmitter type must be designed to comply with the applicable unwanted emissions limits in this section.

(a) Emission masks. Emission masks applicable to transmitting equipment in the GMRS are defined by the requirements in the following table. The numbers in the attenuation requirements column refer to rule paragraph numbers under paragraph (b) of this section.

Emission types filter	Attenuation requirements
A1D, A3E, F1D, G1D, F2D, F3E, G3E with audio filter	(1), (2), (7)
A1D, A3E, F1D, G1D, F3E, G3E without audio filter	(3), (4), (7)
H1D, J1D, R1D, H3E, J3E, R2E	(5), (6), (7)

(1) Filtering noted for GMRS transmitters refers to the requirement in §95.1775(e).

(2) Unwanted emission power may be measured as either mean power or peak envelope power, provided that the transmitter output power is measured the same way.

(b) Attenuation requirements. The power of unwanted emissions must be attenuated below the transmitter output power in Watts (P) by at least:

(1) 25 dB (decibels) on any frequency removed from the center of the authorized bandwidth by more than 50% up to and including 100% of the authorized bandwidth.

(2) 35 dB on any frequency removed from the center of the authorized bandwidth by more than 100% up to and including 250% of the authorized bandwidth.

(3) $83 \log (fd \div 5)$ dB on any frequency removed from the center of the authorized bandwidth by a displacement frequency (fd in kHz) of more than 5 kHz up to and including 10 kHz.

(4) $116 \log (fd \div 6.1)$ dB or $50 + 10 \log (P)$ dB, whichever is the lesser attenuation, on any frequency removed from the center of the authorized bandwidth by a displacement frequency (fd in kHz), of more than 10 kHz up to and including 250% of the authorized bandwidth.

(5) 25 dB on any frequency removed from the center of the authorized bandwidth by more than 50% up to and including 150% of the authorized bandwidth.

(6) 35 dB on any frequency removed from the center of the authorized bandwidth by more than 150% up to and including 250% of the authorized bandwidth.

(7) $43 + 10 \log (P)$ dB on any frequency removed from the center of the authorized bandwidth by more than 250%.

(c) Measurement bandwidths. The power of unwanted emissions in the frequency bands specified in paragraphs (b)(1) through(4) of this section is measured with a reference bandwidth of 300 Hz. The power of unwanted emissions in the frequency range specified in paragraph (b)(5) of this section is measured with a reference bandwidth of at least 30 kHz.

(d) Measurement conditions. The requirements in this section apply to each GMRS transmitter type both with and without the connection of permitted attachments, such as an external speaker, microphone, power cord and/or antenna.

3.6.2 Spurious Emissions At Antenna Terminals.

3.6.2.1 EUT Setup Block Diagram

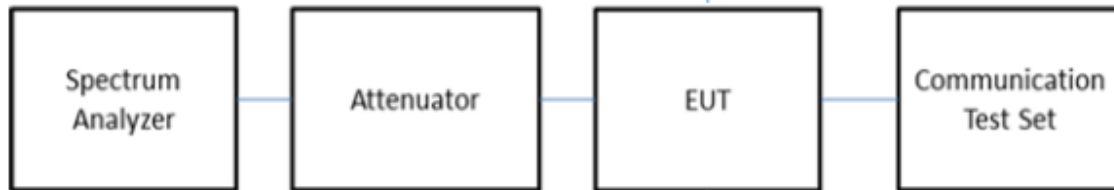

3.6.2.2 Test Procedure

C63.26-2015, Clause 5.7.4

- a) Set the spectrum analyzer start frequency to the lowest frequency generated by the EUT, without going below 9 kHz, and the stop frequency to the lower frequency covered by the measurements previously performed in 5.7.3. As an alternative, the stop frequency can be set to the value specified in 5.1.1, depending on the EUT operating range, if the resulting plot can clearly demonstrate compliance for all frequencies not addressed by the out-of-band emissions measurements performed as per 5.7.3.
- b) When using an average power (rms) detector, ensure that the number of points in the sweep $\geq 2 \times (\text{span} / \text{RBW})$. This may require that the measurement range defined by the start and stop frequencies be subdivided, depending on the spectrum analyzer capabilities. This requirement does not apply to peak-detected power measurements. When average power is specified by the applicable regulation, a peak-detector can be utilized for preliminary measurements to accommodate wider frequency spans. Any emissions found in the preliminary measurement to exceed the applicable limit(s) shall be further examined using a power averaging (rms) detector with the minimum number of measurement points as defined above.
- c) The sweep time should be set to auto-couple for performing peak-detector measurements. For measurements that use a power averaging (rms) detector, the sweep time shall be set as described for out-of-band emissions measurements in item d) of 5.7.3.
- d) Identify and measure the highest spurious emission levels in each frequency range. It is not necessary to re-measure the out-of-band emissions as a part of this test. Record the frequencies and amplitudes corresponding to the measured emissions and capture the data plots.
- e) Repeat step b) through step d) for the upper spurious emission frequency range if not already captured by a wide span measurement performed as per the alternative provided in step a). The upper frequency for this measurement is defined in 5.1.1 as a function of the EUT operating range.
- f) Compare the results with the corresponding limit in the applicable regulation.
- g) The test report shall include the data plots of the measuring instrument display and the measured data.

3.6.3 Radiated Spurious Emissions

Test setup:

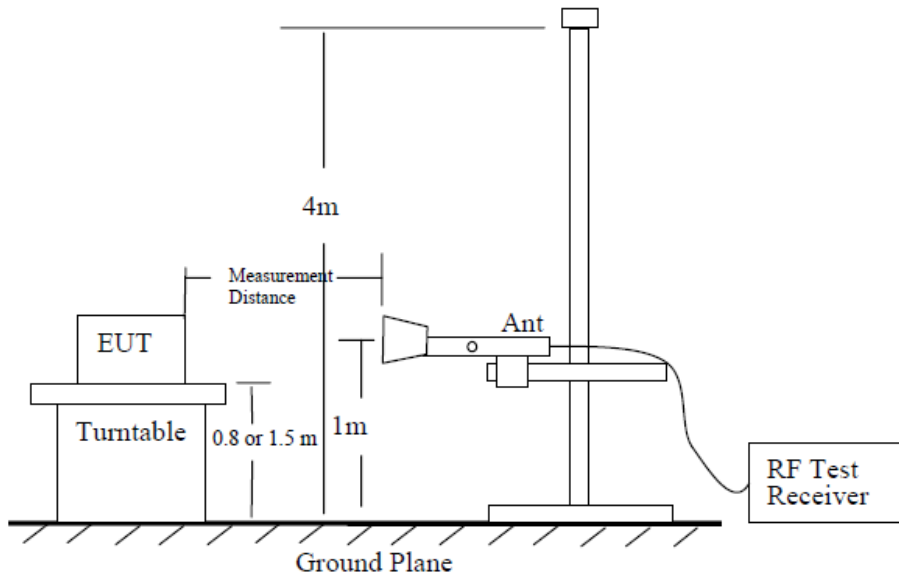

Figure 6—Test site-up for radiated ERP and/or EIRP measurements

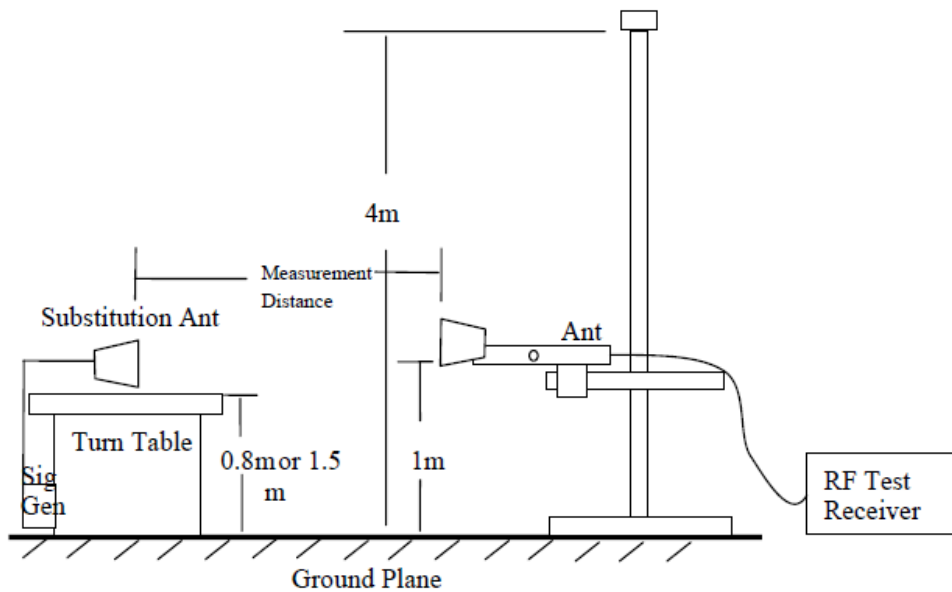

Figure 7—Substitution method set-up for radiated emission

Test Procedure:

ANSI C63.26-2015 Section 5.5.3

- a) Place the EUT in the center of the turntable. The EUT shall be configured to transmit into the standard non-radiating load (for measuring radiated spurious emissions), connected with cables of minimal length unless specified otherwise. If the EUT uses an adjustable antenna, the antenna shall be positioned to the length that produces the worst case emission at the fundamental operating frequency.
- b) Each emission under consideration shall be evaluated:
 - 1) Raise and lower the measurement antenna in accordance 5.5.2, as necessary to enable detection of the maximum emission amplitude relative to measurement antenna height.
 - 2) Rotate the EUT through 360° to determine the maximum emission level relative to the axial position.
 - 3) Return the turntable to the azimuth where the highest emission amplitude level was observed.
 - 4) Vary the measurement antenna height again through 1 m to 4 m again to find the height associated with the maximum emission amplitude.
 - 5) Record the measured emission amplitude level and frequency using the appropriate RBW.
- c) Repeat step b) for each emission frequency with the measurement antenna oriented in both the horizontal and vertical polarizations to determine the orientation that gives the maximum emissions amplitude.
- d) Set-up the substitution measurement with the reference point of the substitution antenna located as near as possible to where the center of the EUT radiating element was located during the initial EUT measurement.
- e) Maintain the previous measurement instrument settings and test set-up, with the exception that the EUT is removed and replaced by the substitution antenna.
- f) Connect a signal generator to the substitution antenna; locate the signal generator so as to minimize any potential influences on the measurement results. Set the signal generator to the frequency where emissions are detected, and set an output power level such that the radiated signal can be detected by the measurement instrument, with sufficient dynamic range relative to the noise floor.
- g) For each emission that was detected and measured in the initial test [i.e., in step b) and step c)]:
 - 1) Vary the measurement antenna height between 1 m to 4 m to maximize the received (measured) signal amplitude.
 - 2) Adjust the signal generator output power level until the amplitude detected by the measurement instrument equals the amplitude level of the emission previously measured directly in step b) and step c).
 - 3) Record the output power level of the signal generator when equivalence is achieved in step 2).
- h) Repeat step e) through step g) with the measurement antenna oriented in the opposite polarization.
- i) Calculate the emission power in dBm referenced to a half-wave dipole using the following equation:

$$P_e = P_s(\text{dBm}) - \text{cable loss (dB)} + \text{antenna gain (dBd)}$$
 where
 - P_e = equivalent emission power in dBm
 - P_s = source (signal generator) power in dBm
 NOTE—dBd refers to the measured antenna gain in decibels relative to a half-wave dipole.
- j) Correct the antenna gain of the substitution antenna if necessary to reference the emission power to a half-wave dipole. When using measurement antennas with the gain specified in dBi, the equivalent dipole-referenced gain can be determined from: $\text{gain (dBd)} = \text{gain (dBi)} - 2.15 \text{ dB}$. If necessary, the antenna gain can be calculated from calibrated antenna factor information
- k) Provide the complete measurement results as a part of the test report.

4. TEST DATA AND RESULTS

4.1 GMRS Frequency Accuracy

Serial Number:	28XI-2	Test Date:	2023/08/09
Test Site:	RF	Test Mode:	Transmitting
Tester:	Morpheus Shi	Test Result:	Pass

Environmental Conditions:

Temperature: (°C)	26.8	Relative Humidity: (%)	49	ATM Pressure: (kPa)	99.9
----------------------	------	------------------------------	----	------------------------	------

Test Equipment List and Details:

Manufacturer	Description	Model	Serial Number	Calibration Date	Calibration Due Date
R&S	Spectrum Analyzer	FSV40	101943	2023/03/31	2024/03/30
zhuoxiang	Coaxial Cable	SMA-178	211001	Each time	N/A
Mini-Circuits	DC Block	BLK-18-S+	1554403	Each time	N/A
eastsheep	Coaxial Attenuator	2W-SMA-JK-18G	21060301	Each time	N/A
Weinschel	Coaxial Attenuator	53-20-34	LN751	Each time	N/A
BACL	TEMP&HUMI Test Chamber	BTH-150-40	30174	2023/03/31	2024/03/30
UNI-T	Multimeter	UT39A+	C210582554	2022/09/29	2023/09/28
ZHAOXIN	DC Power Supply	RXN-6010D	21R6010D0912386	N/A	N/A

* Statement of Traceability: China Certification ICT Co., Ltd (Dongguan) attests that all calibrations have been performed, traceable to National Primary Standards and International System of Units (SI).

Test Data:

Test Frequency (MHz)	Temperature (°C)	Voltage (Vdc)	Measured Frequency (MHz)	Frequency Error (ppm)	limit (ppm)
462.625	-30	7.4	462.625322	0.70	≤5.0
	-20	7.4	462.625283	0.61	≤5.0
	-10	7.4	462.625245	0.53	≤5.0
	0	7.4	462.625208	0.45	≤5.0
	10	7.4	462.625171	0.37	≤5.0
	20	7.4	462.625140	0.30	≤5.0
	30	7.4	462.625109	0.24	≤5.0
	40	7.4	462.625076	0.16	≤5.0
	50	7.4	462.625047	0.10	≤5.0
	20	6.7	462.625195	0.42	≤5.0
	20	8.3	462.625094	0.20	≤5.0

Test Frequency (MHz)	Temperature (°C)	Voltage (Vdc)	Measured Frequency (MHz)	Frequency Error (ppm)	limit (ppm)
462.6375	-30	7.4	462.637857	0.77	≤5.0
	-20	7.4	462.637811	0.67	≤5.0
	-10	7.4	462.637769	0.58	≤5.0
	0	7.4	462.637722	0.48	≤5.0
	10	7.4	462.637683	0.40	≤5.0
	20	7.4	462.637640	0.30	≤5.0
	30	7.4	462.637601	0.22	≤5.0
	40	7.4	462.637557	0.12	≤5.0
	50	7.4	462.637518	0.04	≤5.0
	20	6.7	462.637697	0.43	≤5.0
	20	8.3	462.637582	0.18	≤5.0

Test Frequency (MHz)	Temperature (°C)	Voltage (Vdc)	Measured Frequency (MHz)	Frequency Error (ppm)	limit (ppm)
467.625	-30	7.4	467.625382	0.82	≤5.0
	-20	7.4	467.625346	0.74	≤5.0
	-10	7.4	467.625299	0.64	≤5.0
	0	7.4	467.625244	0.52	≤5.0
	10	7.4	467.625191	0.41	≤5.0
	20	7.4	467.625140	0.30	≤5.0
	30	7.4	467.625103	0.22	≤5.0
	40	7.4	467.625059	0.13	≤5.0
	50	7.4	467.625017	0.04	≤5.0
	20	6.7	467.625197	0.42	≤5.0
	20	8.3	467.625092	0.20	≤5.0

Test Frequency (MHz)	Temperature (°C)	Voltage (Vdc)	Measured Frequency (MHz)	Frequency Error (ppm)	limit (ppm)
467.6375	-30	7.4	467.637783	0.61	≤2.5
	-20	7.4	467.637748	0.53	≤2.5
	-10	7.4	467.637726	0.48	≤2.5
	0	7.4	467.637691	0.41	≤2.5
	10	7.4	467.637665	0.35	≤2.5
	20	7.4	467.637640	0.30	≤2.5
	30	7.4	467.637614	0.24	≤2.5
	40	7.4	467.637591	0.19	≤2.5
	50	7.4	467.637562	0.13	≤2.5
	20	6.7	467.637675	0.37	≤2.5
	20	8.3	467.637603	0.22	≤2.5

4.2 RF Output Power

Serial Number:	28XI-2	Test Date:	2023/08/09
Test Site:	RF	Test Mode:	Transmitting
Tester:	Morpheus Shi	Test Result:	Pass

Environmental Conditions:

Temperature: (°C)	26.8	Relative Humidity: (%)	49	ATM Pressure: (kPa)	99.9
----------------------	------	------------------------------	----	------------------------	------

Test Equipment List and Details:

Manufacturer	Description	Model	Serial Number	Calibration Date	Calibration Due Date
R&S	Spectrum Analyzer	FSV40	101943	2023/03/31	2024/03/30
zhuoxiang	Coaxial Cable	SMA-178	211002	Each time	N/A
HuiXunDa	DC Block	SMA-JK 18G	DCB181108043	Each time	N/A
eastsheep	Coaxial Attenuator	2W-SMA-JK-18G	21060301	Each time	N/A
Weinschel	Coaxial Attenuator	53-20-34	LN751	Each time	N/A
HP	RF Communications Test Set	8920A	3438A05209	2023/03/31	2024/03/30

* Statement of Traceability: China Certification ICT Co., Ltd (Dongguan) attests that all calibrations have been performed, traceable to National Primary Standards and International System of Units (SI).

Test Data:

Test Bands	Test Frequency (MHz)	Conducted Output power (dBm)	Conducted Output Power Limit (dBm)	ERP (dBm)	ERP Limit (dBm)
462 MHz Main	462.625	36.66	≤47.00	34.51	/
462 MHz interstitial	462.6375	36.34	/	34.19	≤37.00
467 MHz Main	467.625	36.39	≤47.00	34.24	/
467 MHz interstitial	467.6375	28.45	/	26.30	≤27.00

ERP=Conducted Output Power+ Antenna Gain(dBd)

Note:

The 31.2 dB is the Insertion loss of the RF cable, DC Block, Coaxial Attenuators, which was offset into the Spectrum Analyzer.

Conducted Output power

462.6250 MHz

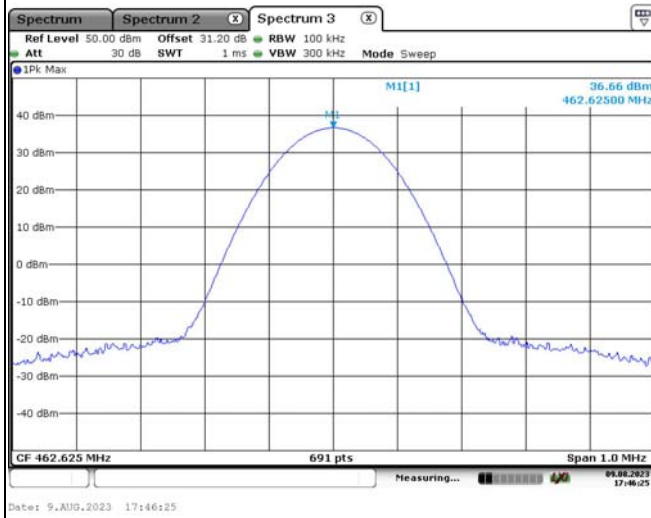

462.6375 MHz

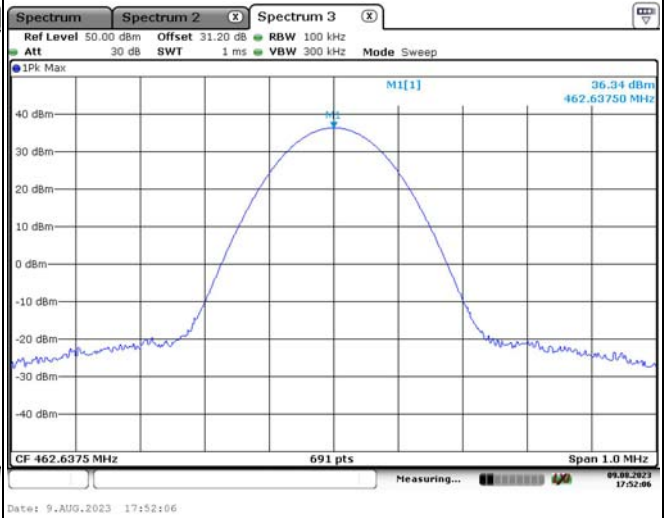

467.6250 MHz

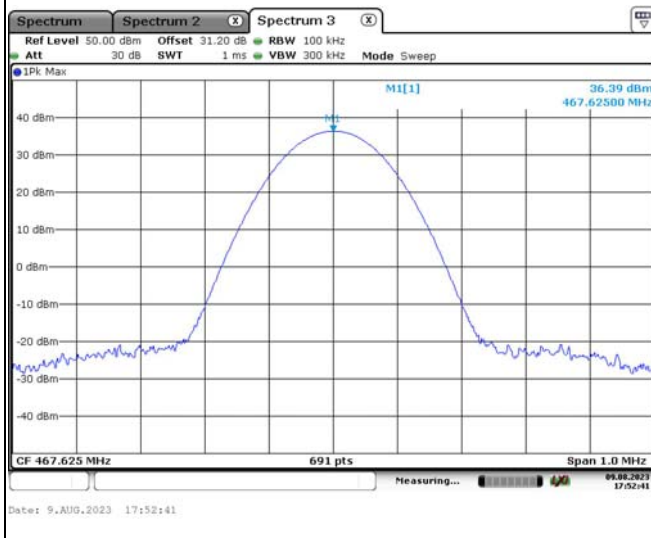

467.6375 MHz

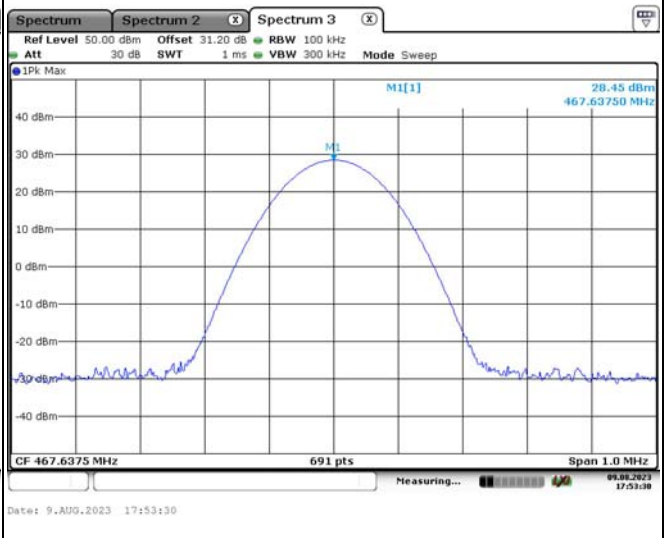

4.3 GMRS Authorized Bandwidth And Emission Mask

Serial Number:	28XI-2	Test Date:	2023/08/09
Test Site:	RF	Test Mode:	Transmitting
Tester:	Morpheus Shi	Test Result:	Pass

Environmental Conditions:

Temperature: (°C)	26.8	Relative Humidity: (%)	49	ATM Pressure: (kPa)	99.9
----------------------	------	---------------------------	----	------------------------	------

Test Equipment List and Details:

Manufacturer	Description	Model	Serial Number	Calibration Date	Calibration Due Date
R&S	Spectrum Analyzer	FSV40	101943	2023/03/31	2024/03/30
zhuoxiang	Coaxial Cable	SMA-178	211002	Each time	N/A
HuiXunDa	DC Block	SMA-JK 18G	DCB181108043	Each time	N/A
eastsheep	Coaxial Attenuator	2W-SMA-JK-18G	21060301	Each time	N/A
Weinschel	Coaxial Attenuator	53-20-34	LN751	Each time	N/A
HP	RF Communications Test Set	8920A	3438A05209	2023/03/31	2024/03/30

* Statement of Traceability: China Certification ICT Co., Ltd (Dongguan) attests that all calibrations have been performed, traceable to National Primary Standards and International System of Units (SI).

Test Data:

Test Bands	Test Frequency (MHz)	99% Occupied Bandwidth (kHz)	Limit (kHz)
462 MHz Main	462.625	14.761	≤20
462 MHz interstitial	462.6375	14.761	≤20
467 MHz Main	467.625	14.761	≤20
467 MHz interstitial	467.6375	9.696	≤12.5

Note:

The 31.2 dB is the Insertion loss of the RF cable, DC Block, Coaxial Attenuators, which was offset into the Spectrum Analyzer.

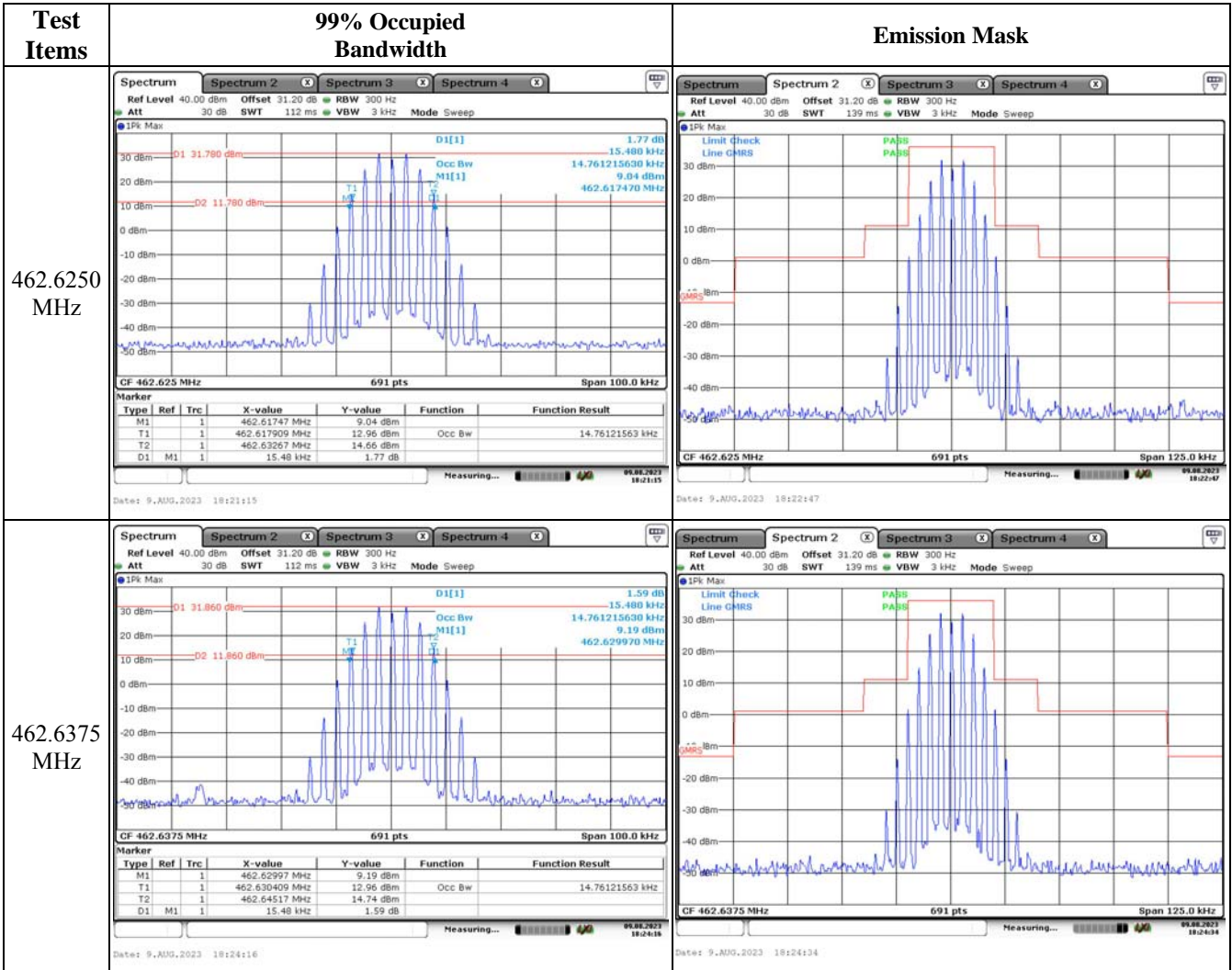

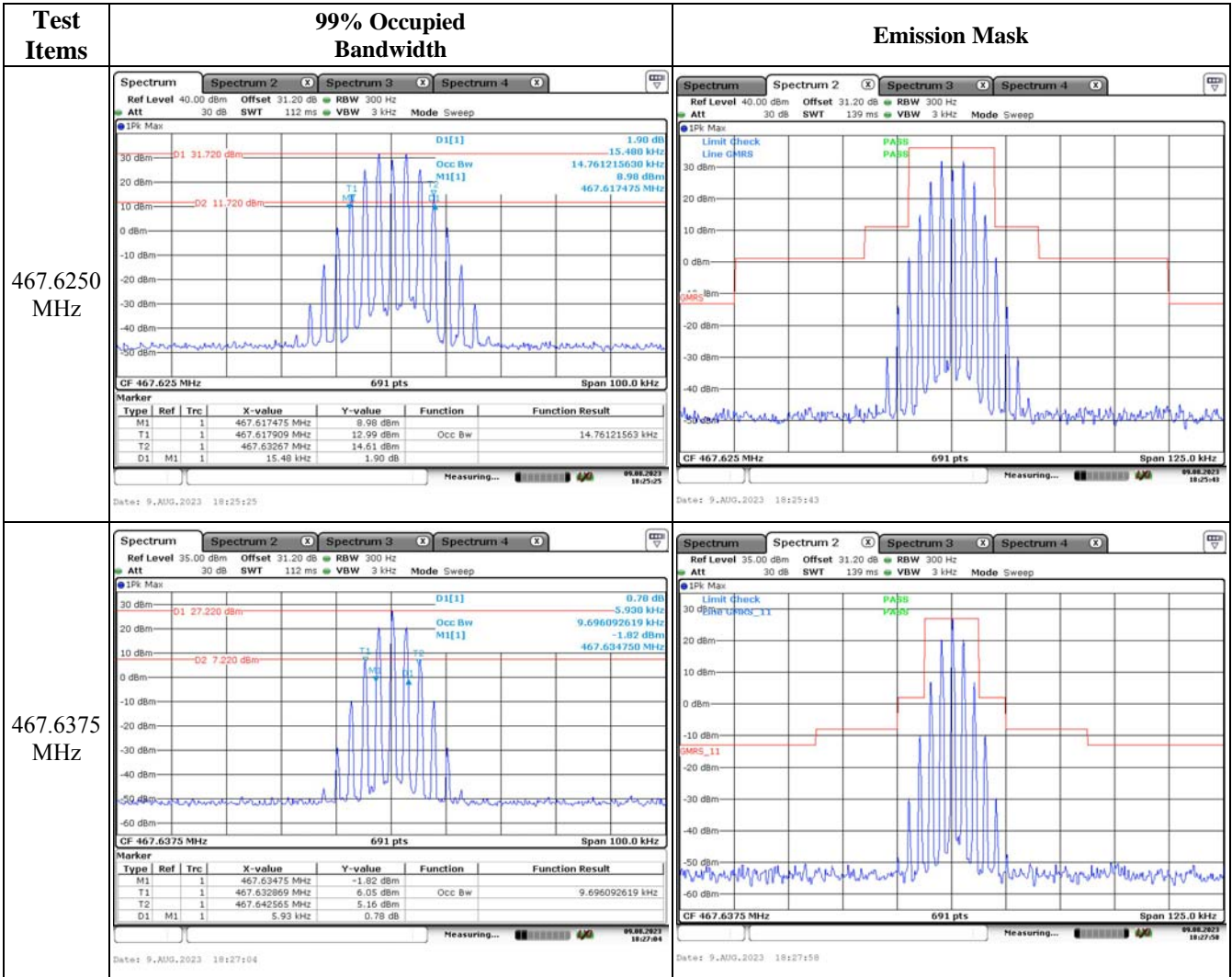

4.4 GMRS Modulation Requirement

Serial Number:	28XI-2	Test Date:	2023/08/11
Test Site:	RF	Test Mode:	Transmitting
Tester:	Morpheus Shi	Test Result:	Pass

Environmental Conditions:

Temperature: (°C)	26.2	Relative Humidity: (%)	56	ATM Pressure: (kPa)	99.7
----------------------	------	------------------------------	----	------------------------	------

Test Equipment List and Details:

Manufacturer	Description	Model	Serial Number	Calibration Date	Calibration Due Date
HP	RF Communications Test Set	8920A	3438A05209	2023/03/31	2024/03/30
R&S	Audio Analyzer	UPV	103447	2022/11/16	2023/11/15
zhuoxiang	Coaxial Cable	SMA-178	211002	Each time	N/A
HuiXunDa	DC Block	SMA-JK 18G	DCB181108043	Each time	N/A
eastsheep	Coaxial Attenuator	2W-SMA-JK-18G	21060301	Each time	N/A
Weinschel	Coaxial Attenuator	53-20-34	LN751	Each time	N/A

* Statement of Traceability: China Certification ICT Co., Ltd (Dongguan) attests that all calibrations have been performed, traceable to National Primary Standards and International System of Units (SI).

Test Data:

MODULATION LIMITING

Carrier Frequency: 462.6250 MHz

Audio Frequency (Hz)	Instantaneous		Steady-state		Limit [kHz]
	Deviation (@+20dB) [kHz]	Deviation (@-20dB) [kHz]	Deviation (@+20dB) [kHz]	Deviation (@-20dB) [kHz]	
300	2.378	0.030	2.263	0.015	5.00
400	3.323	0.148	3.215	0.054	5.00
500	3.859	0.189	3.742	0.098	5.00
600	3.783	0.224	3.677	0.107	5.00
700	3.621	0.251	3.518	0.163	5.00
800	3.718	0.280	3.604	0.195	5.00
900	3.809	0.312	3.693	0.226	5.00
1000	3.854	0.339	3.746	0.241	5.00
1200	3.765	0.399	3.659	0.304	5.00
1400	3.719	0.462	3.601	0.375	5.00
1600	3.851	0.516	3.745	0.423	5.00
1800	3.892	0.573	3.784	0.488	5.00
2000	3.889	0.618	3.778	0.527	5.00
2200	3.851	0.661	3.743	0.574	5.00
2400	3.852	0.692	3.745	0.601	5.00
2600	3.945	0.723	3.866	0.632	5.00
2800	4.054	0.766	3.962	0.676	5.00
3000	4.129	0.787	4.057	0.695	5.00

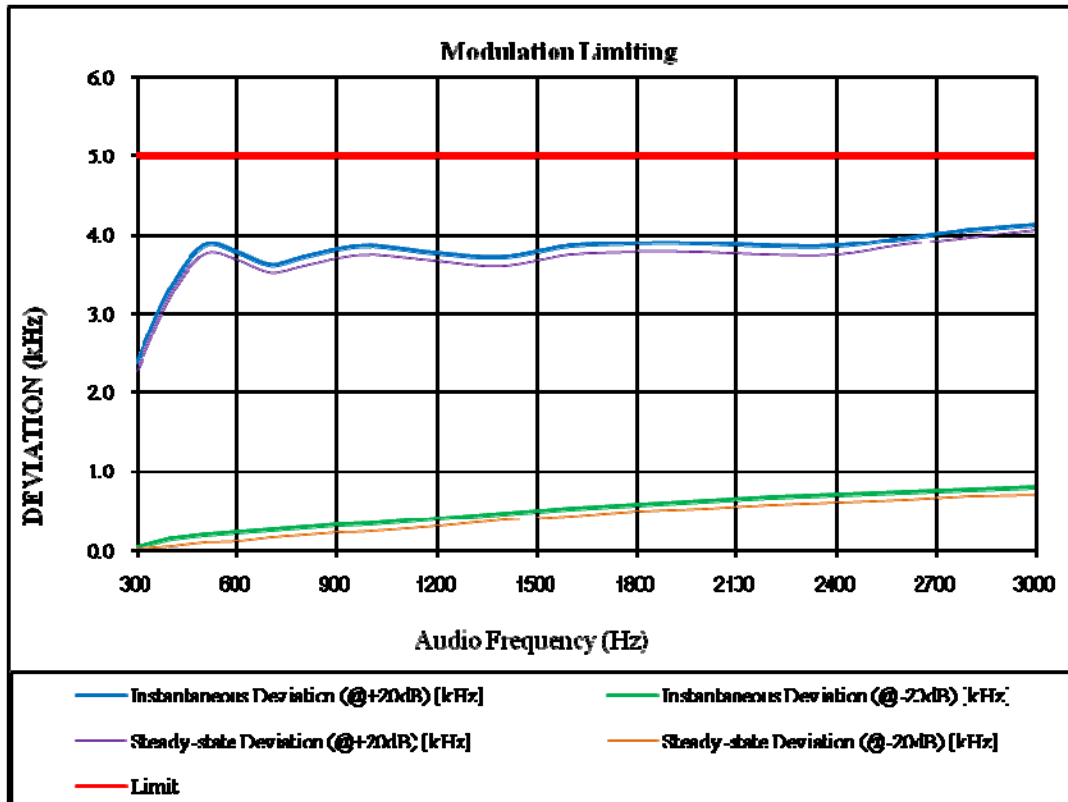

Carrier Frequency: 462.6375 MHz

Audio Frequency (Hz)	Instantaneous		Steady-state		Limit [kHz]
	Deviation (@+20dB) [kHz]	Deviation (@-20dB) [kHz]	Deviation (@+20dB) [kHz]	Deviation (@-20dB) [kHz]	
300	2.491	0.032	2.354	0.012	5.00
400	3.306	0.144	3.177	0.058	5.00
500	3.841	0.185	3.732	0.094	5.00
600	3.783	0.219	3.675	0.123	5.00
700	3.614	0.248	3.501	0.155	5.00
800	3.721	0.275	3.616	0.181	5.00
900	3.813	0.303	3.708	0.216	5.00
1000	3.853	0.332	3.740	0.245	5.00
1200	3.765	0.393	3.659	0.302	5.00
1400	3.720	0.454	3.612	0.367	5.00
1600	3.851	0.508	3.755	0.413	5.00
1800	3.892	0.557	3.787	0.468	5.00
2000	3.889	0.605	3.773	0.512	5.00
2200	3.852	0.648	3.744	0.556	5.00
2400	3.851	0.677	3.747	0.584	5.00
2600	3.943	0.708	3.839	0.611	5.00
2800	4.055	0.750	3.946	0.658	5.00
3000	4.129	0.765	4.015	0.672	5.00

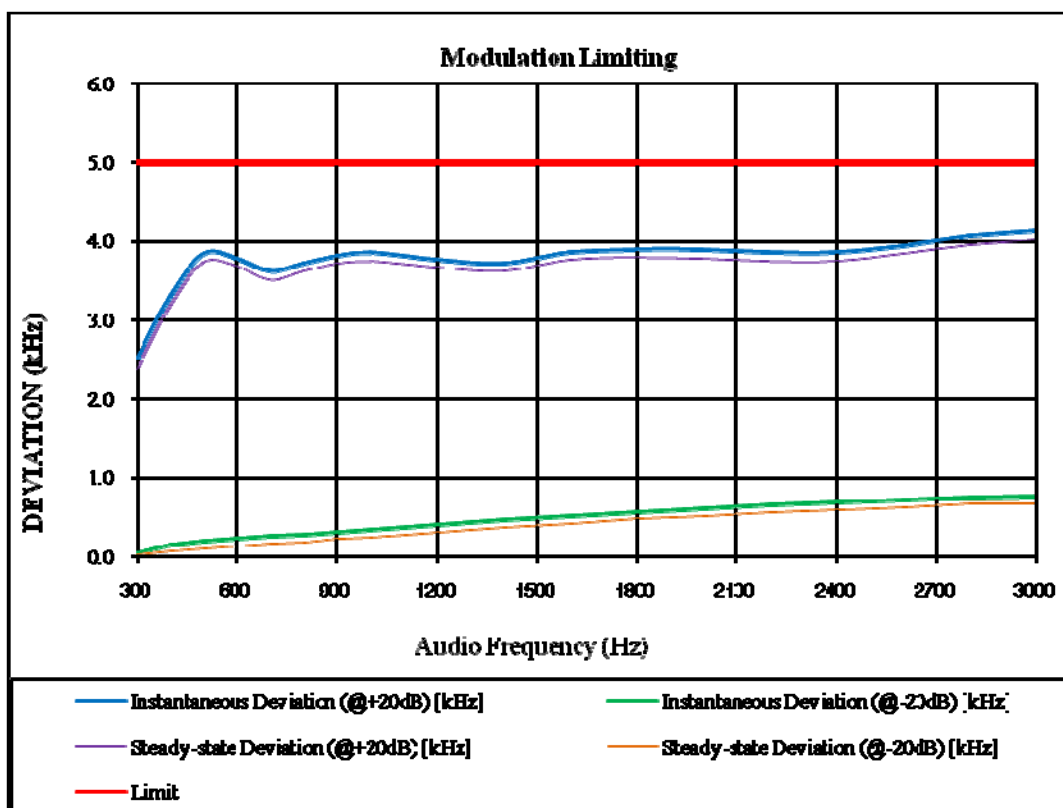

Carrier Frequency: 467.6250 MHz

Audio Frequency (Hz)	Instantaneous		Steady-state		Limit [kHz]
	Deviation (@+20dB) [kHz]	Deviation (@-20dB) [kHz]	Deviation (@+20dB) [kHz]	Deviation (@-20dB) [kHz]	
300	2.503	0.033	2.395	0.010	5.00
400	3.319	0.144	3.207	0.055	5.00
500	3.858	0.187	3.742	0.098	5.00
600	3.782	0.218	3.671	0.127	5.00
700	3.613	0.245	3.500	0.152	5.00
800	3.718	0.274	3.603	0.181	5.00
900	3.812	0.304	3.708	0.216	5.00
1000	3.853	0.333	3.746	0.248	5.00
1200	3.764	0.394	3.659	0.300	5.00
1400	3.719	0.455	3.604	0.367	5.00
1600	3.852	0.510	3.743	0.405	5.00
1800	3.891	0.559	3.787	0.463	5.00
2000	3.888	0.608	3.772	0.511	5.00
2200	3.849	0.651	3.735	0.564	5.00
2400	3.847	0.680	3.731	0.596	5.00
2600	3.940	0.709	3.833	0.618	5.00
2800	4.052	0.751	3.948	0.653	5.00
3000	4.126	0.768	4.019	0.679	5.00

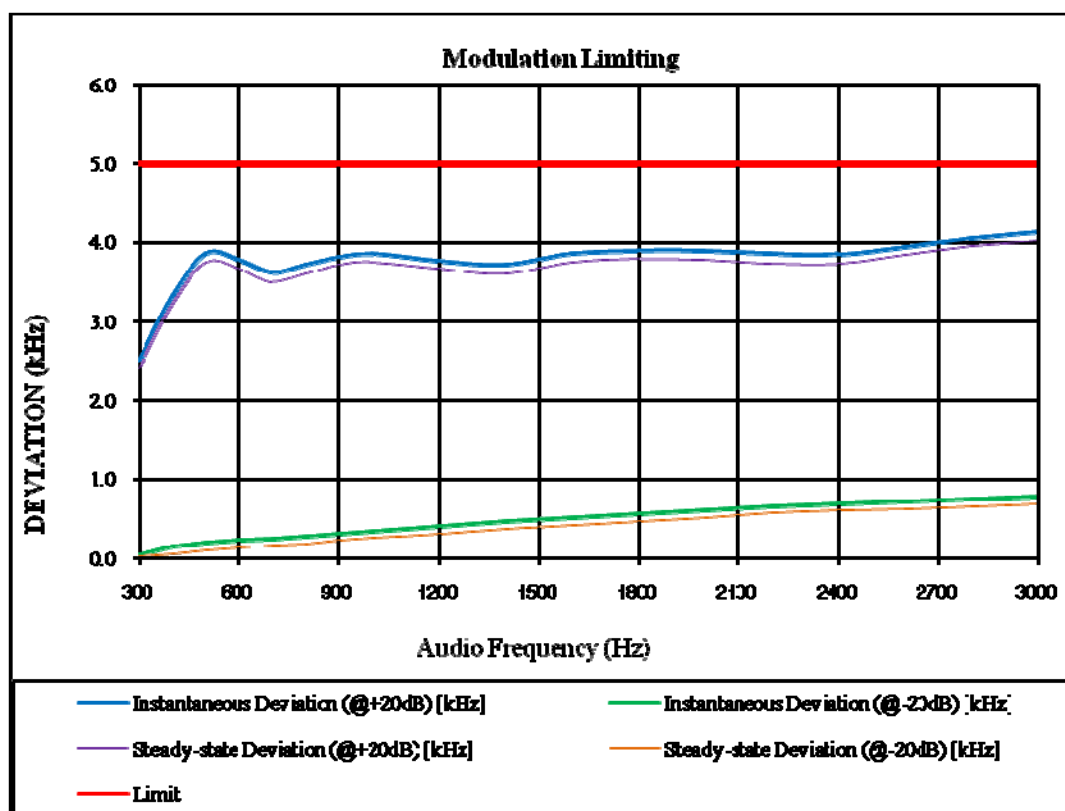

Carrier Frequency: 467.6375 MHz

Audio Frequency (Hz)	Instantaneous		Steady-state		Limit [kHz]
	Deviation (@+20dB) [kHz]	Deviation (@-20dB) [kHz]	Deviation (@+20dB) [kHz]	Deviation (@-20dB) [kHz]	
300	1.255	0.032	1.198	0.008	2.5
400	1.663	0.084	1.601	0.041	2.5
500	1.937	0.101	1.873	0.057	2.5
600	1.902	0.119	1.842	0.072	2.5
700	1.821	0.131	1.760	0.086	2.5
800	1.872	0.145	1.815	0.093	2.5
900	1.926	0.160	1.864	0.108	2.5
1000	1.951	0.176	1.897	0.125	2.5
1200	1.912	0.205	1.853	0.142	2.5
1400	1.884	0.234	1.826	0.170	2.5
1600	1.956	0.264	1.892	0.201	2.5
1800	1.988	0.287	1.925	0.223	2.5
2000	2.005	0.311	1.941	0.257	2.5
2200	2.018	0.331	1.959	0.288	2.5
2400	2.026	0.344	1.966	0.294	2.5
2600	2.040	0.359	1.983	0.306	2.5
2800	2.059	0.379	2.007	0.325	2.5
3000	2.069	0.388	2.015	0.344	2.5

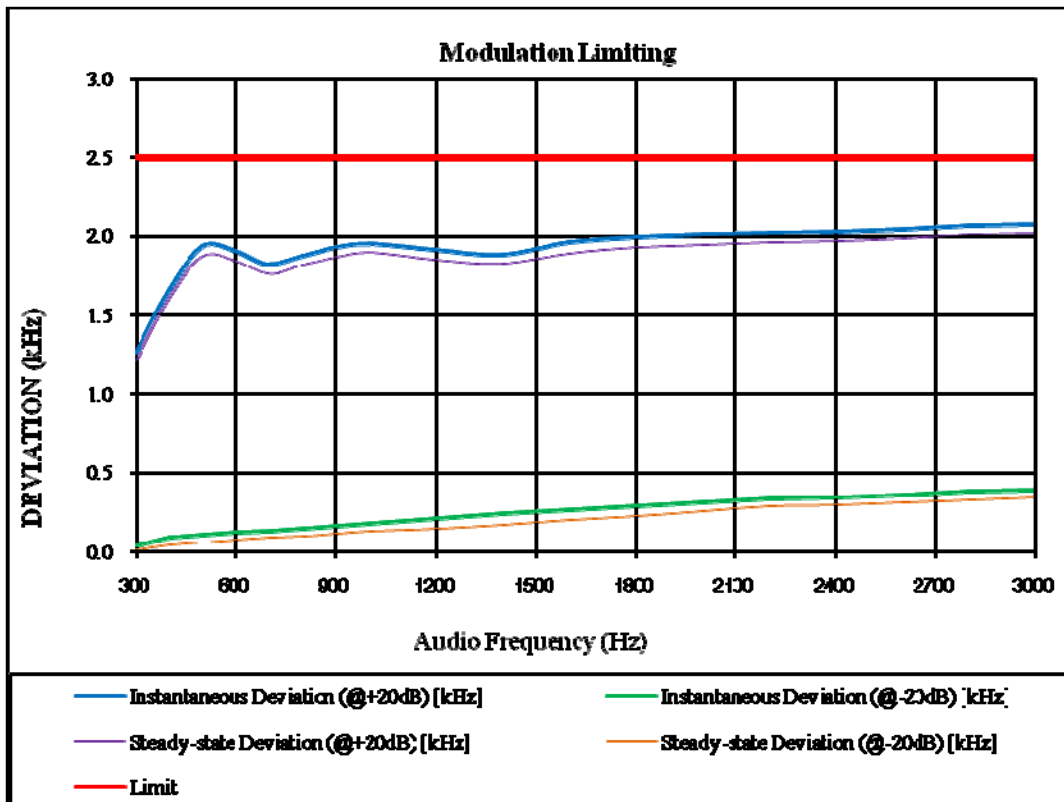

Audio Frequency Response

Carrier Frequency: 462.6250 MHz

Audio Frequency (Hz)	Response Attenuation (dB)
300	-11.17
400	-8.28
500	-5.62
600	-3.99
700	-2.84
800	-1.74
900	-0.77
1000	0.00
1200	1.72
1400	3.02
1600	4.11
1800	4.99
2000	5.71
2200	6.26
2400	6.68
2600	7.05
2800	7.47
3000	7.61
3125	7.09

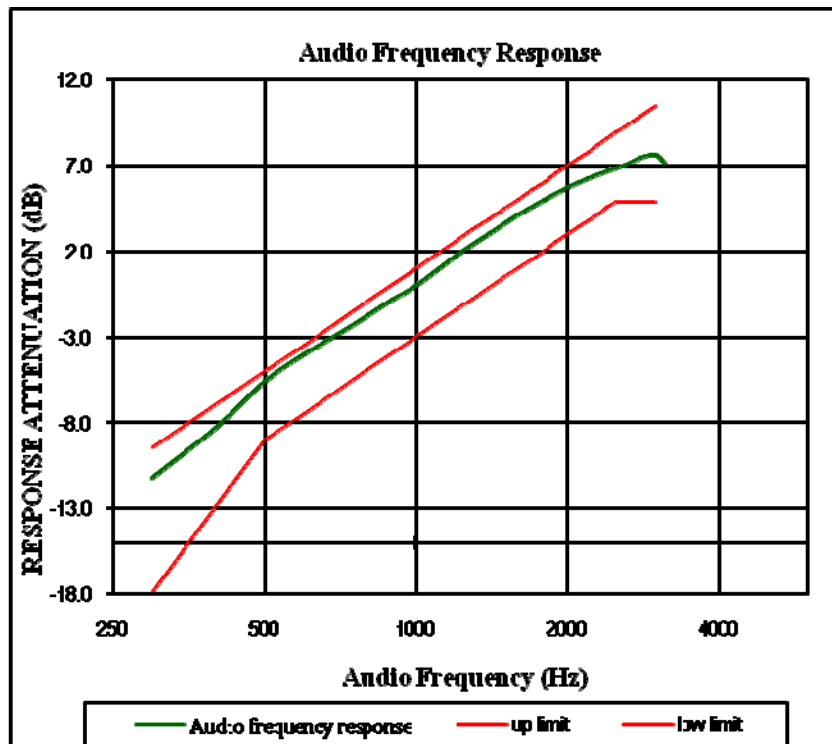

Carrier Frequency: 462.6375 MHz

Audio Frequency (Hz)	Response Attenuation (dB)
300	-11.19
400	-8.28
500	-5.62
600	-4.01
700	-2.85
800	-1.79
900	-0.83
1000	0.00
1200	1.65
1400	2.97
1600	4.04
1800	4.93
2000	5.64
2200	6.20
2400	6.61
2600	6.98
2800	7.41
3000	7.55
3125	7.03

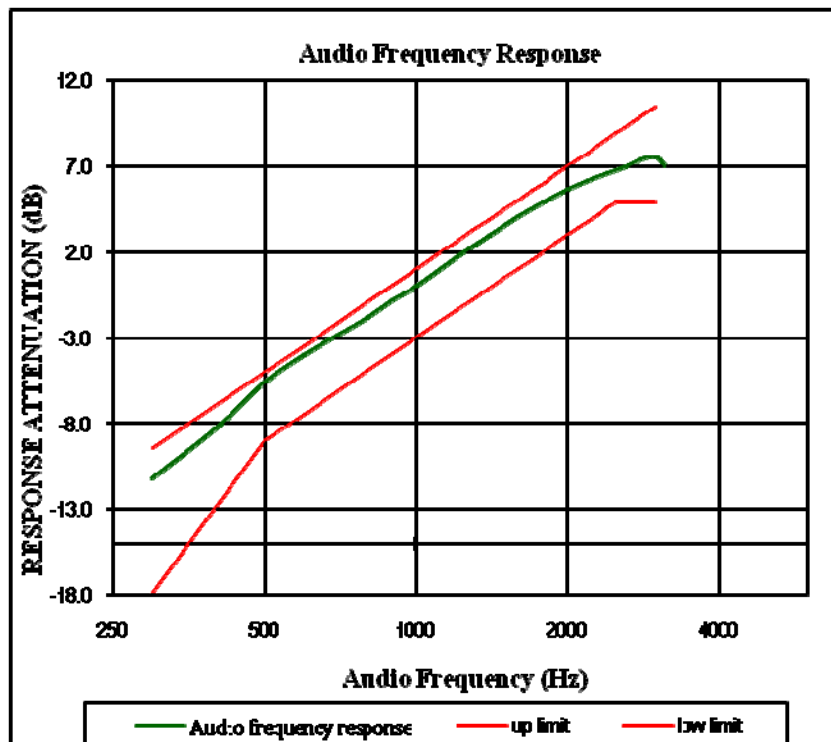

Carrier Frequency: 467.6250 MHz

Audio Frequency (Hz)	Response Attenuation (dB)
300	-11.22
400	-8.31
500	-5.64
600	-4.01
700	-2.86
800	-1.80
900	-0.83
1000	0.00
1200	1.65
1400	2.96
1600	4.04
1800	4.92
2000	5.64
2200	6.19
2400	6.60
2600	6.97
2800	7.40
3000	7.55
3125	7.02

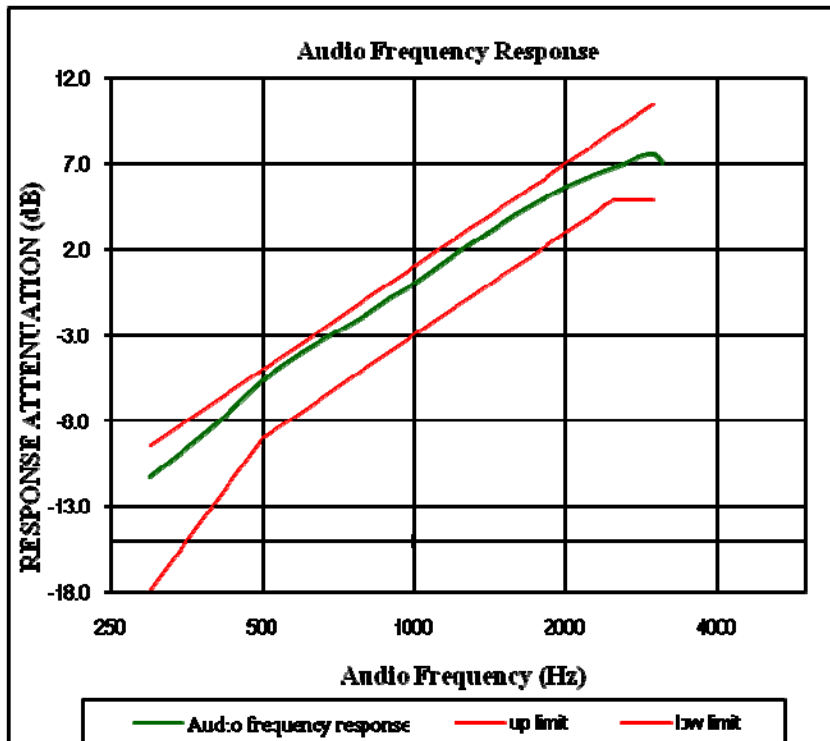

Carrier Frequency: 467.6375 MHz

Audio Frequency (Hz)	Response Attenuation (dB)
300	-11.26
400	-8.35
500	-5.67
600	-4.06
700	-2.88
800	-1.84
900	-0.89
1000	0.00
1200	1.54
1400	2.87
1600	3.92
1800	4.80
2000	5.53
2200	6.11
2400	6.52
2600	6.88
2800	7.34
3000	7.51
3125	6.99

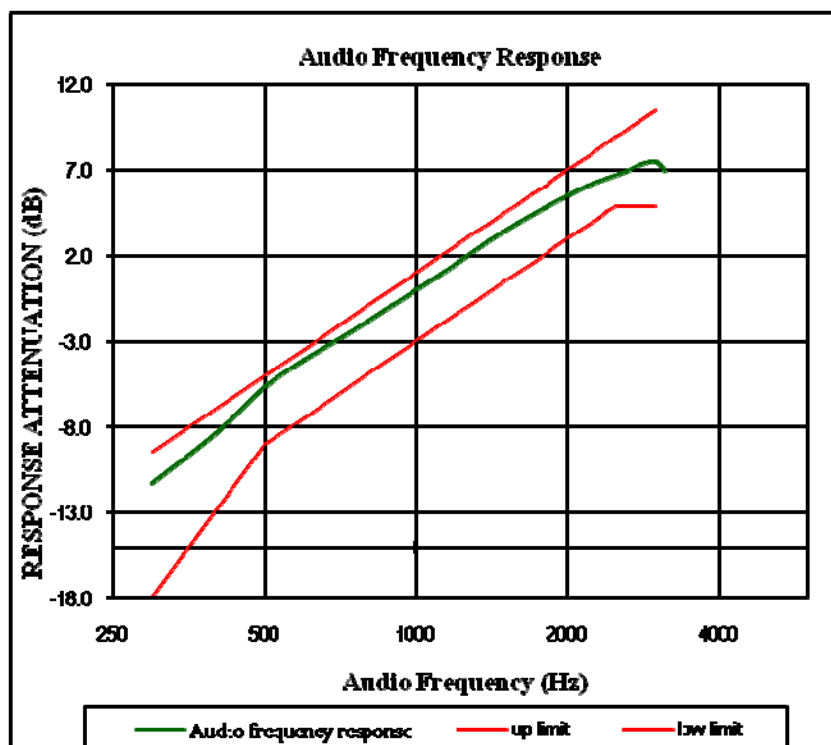

Audio Low Pass Filter Response

Carrier Frequency: 462.6250 MHz

Audio Frequency	Response Attenuation	Limit
kHz	dB	dB
3.0	-5.0	0
3.5	-67.2	-4.0
4.0	-69.5	-7.5
5.0	-71.3	-13.3
7.0	-73.7	-22.1
10.0	-76.4	-31.4
15.0	-78.8	-41.9
20.0	-80.6	-50.0
30.0	-83.1	-50.0
50.0	-85.5	-50.0
70.0	-87.9	-50.0

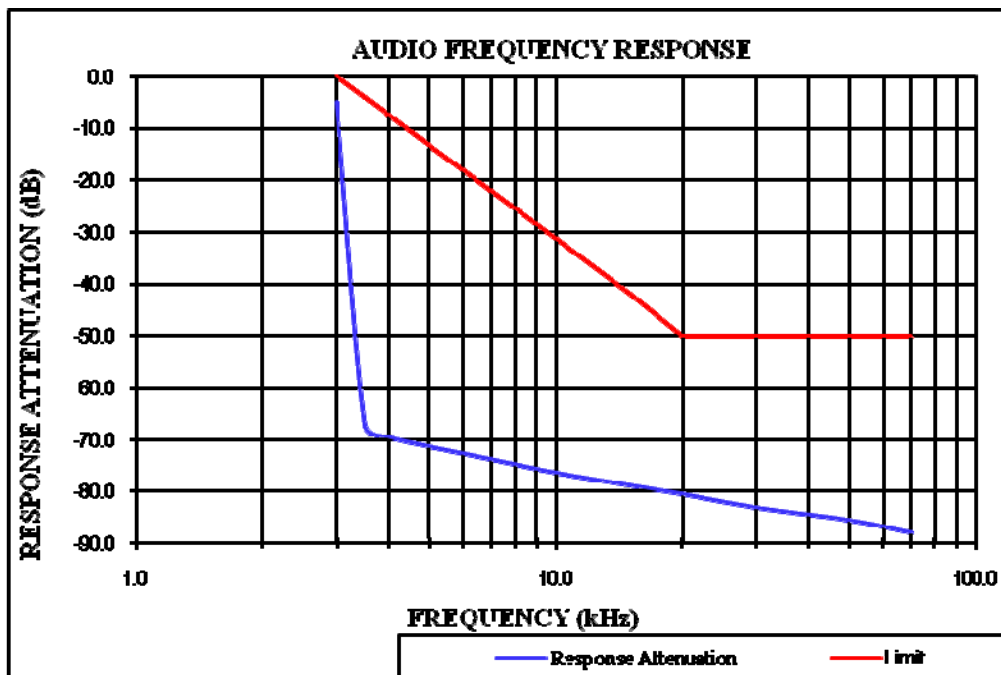

Carrier Frequency: 462.6375 MHz

Audio Frequency	Response Attenuation	Limit
kHz	dB	dB
3.0	-5.1	0
3.5	-66.4	-4.0
4.0	-69.0	-7.5
5.0	-70.7	-13.3
7.0	-72.9	-22.1
10.0	-75.6	-31.4
15.0	-78.2	-41.9
20.0	-80.1	-50.0
30.0	-82.3	-50.0
50.0	-85.5	-50.0
70.0	-87.6	-50.0

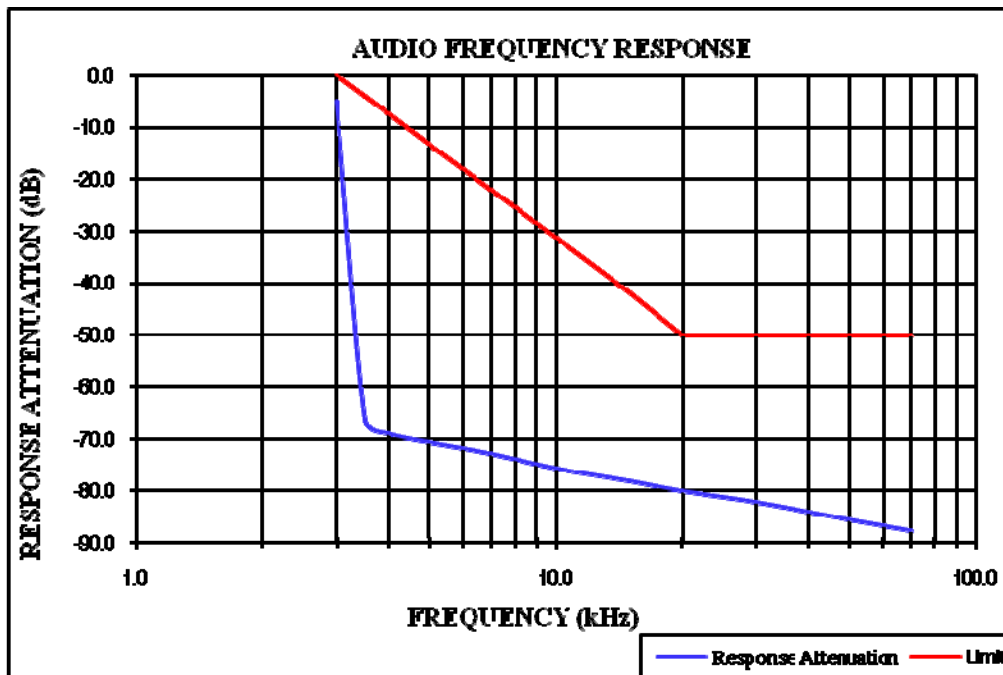

Carrier Frequency: 467.6250 MHz

Audio Frequency	Response Attenuation	Limit
kHz	dB	dB
3.0	-5.3	0
3.5	-68.0	-4.0
4.0	-70.7	-7.5
5.0	-72.4	-13.3
7.0	-74.9	-22.1
10.0	-77.5	-31.4
15.0	-80.4	-41.9
20.0	-82.0	-50.0
30.0	-84.3	-50.0
50.0	-86.9	-50.0
70.0	-88.4	-50.0

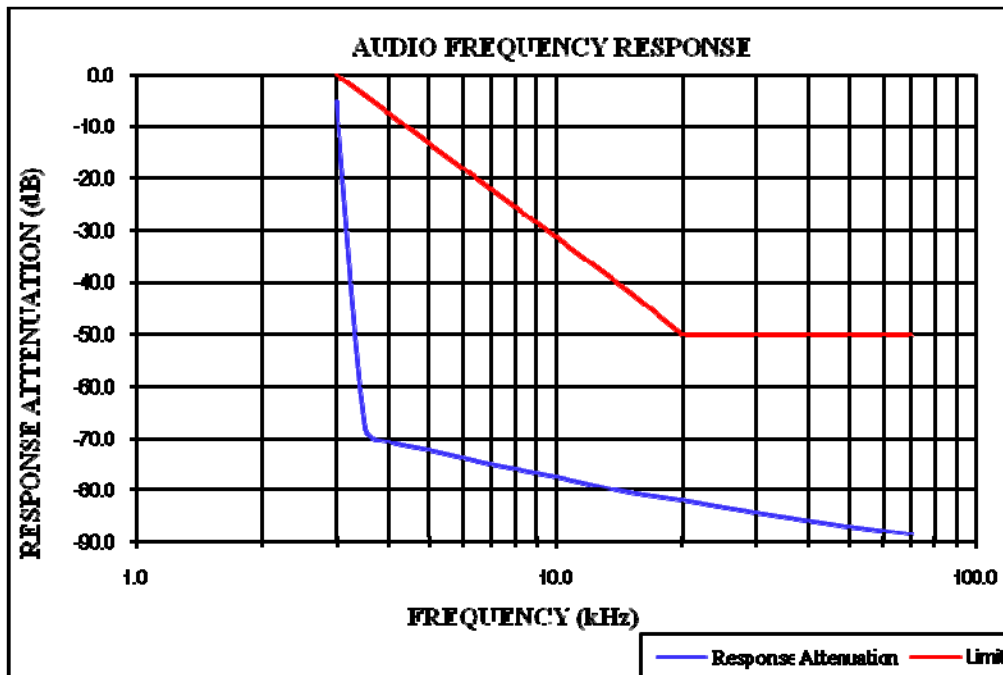

Carrier Frequency: 467.6375 MHz

Audio Frequency	Response Attenuation	Limit
kHz	dB	dB
3.0	-5.6	0
3.5	-66.8	-4.0
4.0	-69.5	-7.5
5.0	-71.3	-13.3
7.0	-74.1	-22.1
10.0	-76.4	-31.4
15.0	-79.2	-41.9
20.0	-81.3	-50.0
30.0	-83.5	-50.0
50.0	-86.2	-50.0
70.0	-88.0	-50.0

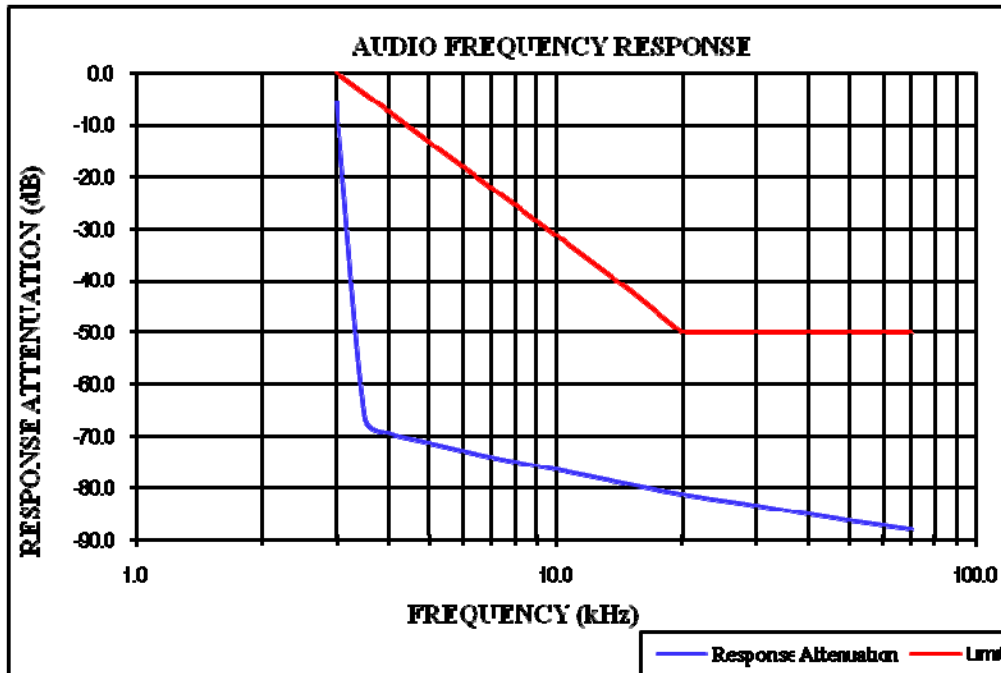

4.5 GMRS Unwanted Emissions Limits

Serial Number:	28XI-2	Test Date:	2023/08/09
Test Site:	RF	Test Mode:	Transmitting
Tester:	Morpheus Shi	Test Result:	Pass

Environmental Conditions:

Temperature: (°C)	26.8	Relative Humidity: (%)	49	ATM Pressure: (kPa)	99.9
----------------------	------	------------------------------	----	------------------------	------

Test Equipment List and Details:

Manufacturer	Description	Model	Serial Number	Calibration Date	Calibration Due Date
R&S	Spectrum Analyzer	FSV40	101943	2023/03/31	2024/03/30
zhuoxiang	Coaxial Cable	SMA-178	211002	Each time	N/A
HuiXunDa	DC Block	SMA-JK 18G	DCB181108043	Each time	N/A
eastsheep	Coaxial Attenuator	2W-SMA-JK-18G	21060301	Each time	N/A
Weinschel	Coaxial Attenuator	53-20-34	LN751	Each time	N/A
HP	RF Communications Test Set	8920A	3438A05209	2023/03/31	2024/03/30

* Statement of Traceability: China Certification ICT Co., Ltd (Dongguan) attests that all calibrations have been performed, traceable to National Primary Standards and International System of Units (SI).

Test Data:

Modes	GMRS Unwanted Emissions Limits			
462.6250 MHz				
462.6375 MHz				
467.6250 MHz				

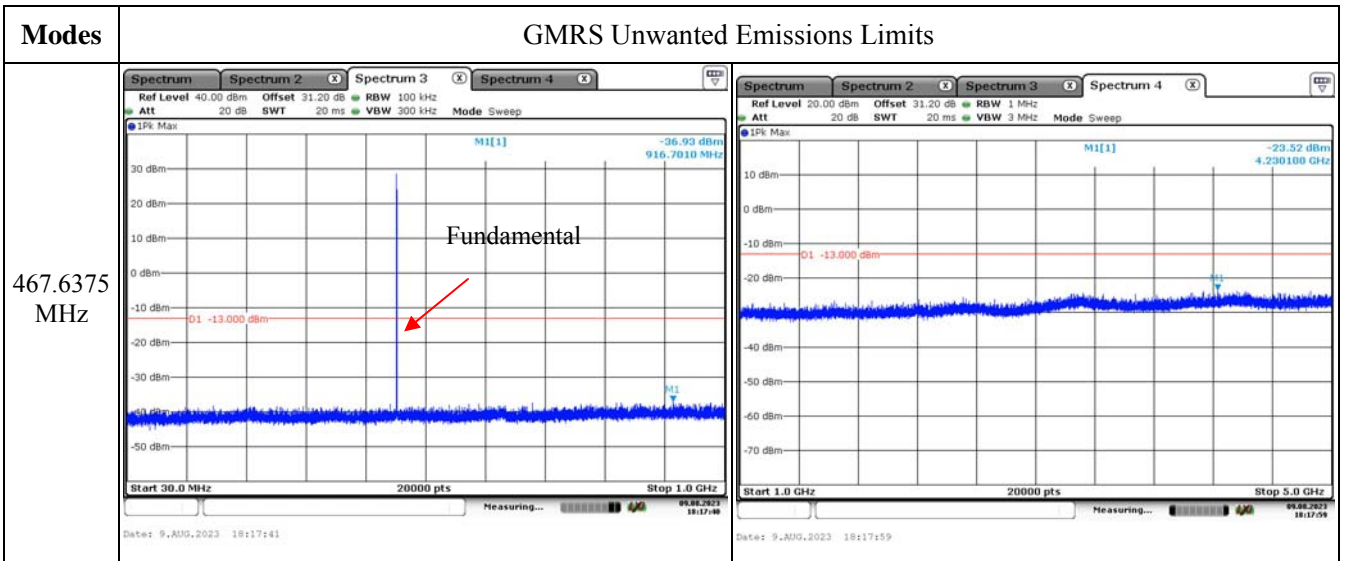

4.6 Radiated Emission

Serial Number:	28XI-1	Test Date:	2023/08/15
Test Site:	966-1/966-2	Test Mode:	Transmitting
Tester:	Carl Xue, Coco Tian	Test Result:	Pass

Environmental Conditions:

Temperature: (°C)	26.4~27.8	Relative Humidity: (%)	62~64	ATM Pressure: (kPa)	100.1
----------------------	-----------	---------------------------	-------	---------------------------	-------

Test Equipment List and Details:

Manufacturer	Description	Model	Serial Number	Calibration Date	Calibration Due Date
Sunol Sciences	Antenna	JB6	A082520-5	2020/10/19	2023/10/18
R&S	EMI Test Receiver	ESR3	102724	2023/03/31	2024/03/30
TIMES MICROWAVE	Coaxial Cable	LMR-600-UltraFlex	C-0470-02	2023/07/16	2024/07/15
TIMES MICROWAVE	Coaxial Cable	LMR-600-UltraFlex	C-0780-01	2023/07/16	2024/07/15
EMCO	Adjustable Dipole Antenna	3121C	9109-756	N/A	N/A
MICRO-COAX	Coaxial Cable	UFA210B-0-0720- 300300	99G1448	2022/07/16	2024/07/15
ETS-Lindgren	Horn Antenna	3115	9912-5985	2020/10/13	2023/10/12
R&S	Spectrum Analyzer	FSV40	101591	2023/03/31	2024/03/30
MICRO-COAX	Coaxial Cable	UFA210A-1-1200- 70U300	217423-008	2023/08/06	2024/08/05
MICRO-COAX	Coaxial Cable	UFA210A-1-2362- 300300	235780-001	2023/08/06	2024/08/05
Mini	Pre-amplifier	ZVA-183-S+	5969001149	2022/11/09	2023/11/08
AH	Double Ridge Guide Horn Antenna	SAS-571	1396	2021/10/18	2024/10/17
Agilent	Signal Generator	E8247C	MY43321352	2022/11/18	2023/11/17

* **Statement of Traceability:** China Certification ICT Co., Ltd (Dongguan) attests that all calibrations have been performed, traceable to National Primary Standards and International System of Units (SI).

Test Data:

Note:

The device can be mounted in multiple orientations, after pre-scan in the X, Y and Z axes of orientation, the worst case is below:

30MHz-5GHz:

Frequency (MHz)	Polar (H/V)	Receiver Reading (dB μ V)	Substituted Method			Absolute Level (dBm)	Limit (dBm)	Margin (dB)
			Substituted Level (dBm)	Antenna Gain (dBd/dBi)	Cable Loss (dB)			
frequency:462.6250MHz								
925.250	H	60.53	-38.01	0.00	0.62	-38.63	-13.00	25.63
925.250	V	55.23	-40.65	0.00	0.62	-41.27	-13.00	28.27
1387.875	H	48.79	-54.80	8.19	0.73	-47.34	-13.00	34.34
1387.875	V	52.64	-51.04	8.19	0.73	-43.58	-13.00	30.58
1850.500	H	40.32	-62.91	8.92	0.89	-54.88	-13.00	41.88
1850.500	V	45.39	-57.76	8.92	0.89	-49.73	-13.00	36.73
2313.125	H	58.46	-43.35	9.29	0.98	-35.04	-13.00	22.04
2313.125	V	47.35	-54.24	9.29	0.98	-45.93	-13.00	32.93
2775.750	H	58.08	-41.86	9.84	1.05	-33.07	-13.00	20.07
2775.750	V	65.66	-34.17	9.84	1.05	-25.38	-13.00	12.38
3238.375	H	45.67	-51.28	10.30	1.16	-42.14	-13.00	29.14
3238.375	V	49.84	-46.86	10.30	1.16	-37.72	-13.00	24.72
3701.000	H	40.46	-56.85	10.60	1.25	-47.50	-13.00	34.50
3701.000	V	45.22	-52.07	10.60	1.25	-42.72	-13.00	29.72
4163.625	H	39.25	-56.72	10.80	1.30	-47.22	-13.00	34.22
4163.625	V	38.12	-57.82	10.80	1.30	-48.32	-13.00	35.32
4626.250	H	37.42	-57.86	10.75	1.41	-48.52	-13.00	35.52
4626.250	V	36.40	-58.77	10.75	1.41	-49.43	-13.00	36.43
frequency:462.6375MHz								
925.275	H	60.06	-38.48	0.00	0.62	-39.10	-13.00	26.10
925.275	V	55.17	-40.71	0.00	0.62	-41.33	-13.00	28.33
1387.913	H	46.66	-56.93	8.19	0.73	-49.47	-13.00	36.47
1387.913	V	51.91	-51.77	8.19	0.73	-44.31	-13.00	31.31
1850.550	H	40.13	-63.10	8.92	0.89	-55.07	-13.00	42.07
1850.550	V	40.16	-62.99	8.92	0.89	-54.96	-13.00	41.96
2313.188	H	58.23	-43.58	9.29	0.98	-35.27	-13.00	22.27
2313.188	V	47.43	-54.16	9.29	0.98	-45.85	-13.00	32.85
2775.825	H	58.99	-40.95	9.84	1.05	-32.16	-13.00	19.16
2775.825	V	64.79	-35.04	9.84	1.05	-26.25	-13.00	13.25
3238.463	H	45.03	-51.92	10.30	1.16	-42.78	-13.00	29.78
3238.463	V	48.85	-47.85	10.30	1.16	-38.71	-13.00	25.71
3701.100	H	43.58	-53.73	10.60	1.25	-44.38	-13.00	31.38
3701.100	V	43.95	-53.34	10.60	1.25	-43.99	-13.00	30.99
4163.738	H	35.79	-60.18	10.80	1.30	-50.68	-13.00	37.68
4163.738	V	35.47	-60.47	10.80	1.30	-50.97	-13.00	37.97
4626.375	H	36.43	-58.85	10.75	1.41	-49.51	-13.00	36.51
4626.375	V	36.25	-58.92	10.75	1.41	-49.58	-13.00	36.58

Frequency (MHz)	Polar (H/V)	Receiver Reading (dBμV)	Substituted Method			Absolute Level (dBm)	Limit (dBm)	Margin (dB)
			Substituted Level (dBm)	Antenna Gain (dBd/dBi)	Cable Loss (dB)			
frequency:467.6250MHz								
935.250	H	61.40	-36.84	0.00	0.66	-37.50	-13.00	24.50
935.250	V	53.81	-41.85	0.00	0.66	-42.51	-13.00	29.51
1402.875	H	45.87	-57.83	8.23	0.71	-50.31	-13.00	37.31
1402.875	V	51.68	-52.06	8.23	0.71	-44.54	-13.00	31.54
1870.500	H	43.52	-59.61	8.94	0.89	-51.56	-13.00	38.56
1870.500	V	41.52	-61.42	8.94	0.89	-53.37	-13.00	40.37
2338.125	H	57.00	-44.59	9.30	0.97	-36.26	-13.00	23.26
2338.125	V	48.12	-53.24	9.30	0.97	-44.91	-13.00	31.91
2805.750	H	58.23	-41.67	9.89	1.04	-32.82	-13.00	19.82
2805.750	V	62.78	-37.01	9.89	1.04	-28.16	-13.00	15.16
3273.375	H	44.13	-52.66	10.31	1.16	-43.51	-13.00	30.51
3273.375	V	49.06	-47.49	10.31	1.16	-38.34	-13.00	25.34
3741.000	H	42.85	-53.85	10.64	1.23	-44.44	-13.00	31.44
3741.000	V	43.77	-52.84	10.64	1.23	-43.43	-13.00	30.43
4208.625	H	38.64	-57.33	10.77	1.33	-47.89	-13.00	34.89
4208.625	V	35.42	-60.51	10.77	1.33	-51.07	-13.00	38.07
4676.250	H	35.17	-59.80	10.81	1.41	-50.40	-13.00	37.40
4676.250	V	36.29	-58.66	10.81	1.41	-49.26	-13.00	36.26
frequency:467.6375MHz								
935.275	H	50.69	-47.54	0.00	0.66	-48.20	-13.00	35.20
935.275	V	54.22	-41.44	0.00	0.66	-42.10	-13.00	29.10
1402.913	H	48.18	-55.52	8.23	0.71	-48.00	-13.00	35.00
1402.913	V	46.79	-56.95	8.23	0.71	-49.43	-13.00	36.43
1870.550	H	35.67	-67.46	8.94	0.89	-59.41	-13.00	46.41
1870.550	V	34.58	-68.36	8.94	0.89	-60.31	-13.00	47.31
2338.188	H	45.13	-56.46	9.30	0.97	-48.13	-13.00	35.13
2338.188	V	40.32	-61.04	9.30	0.97	-52.71	-13.00	39.71
2805.825	H	46.77	-53.13	9.89	1.04	-44.28	-13.00	31.28
2805.825	V	52.17	-47.62	9.89	1.04	-38.77	-13.00	25.77
3273.463	H	37.64	-59.15	10.31	1.16	-50.00	-13.00	37.00
3273.463	V	35.49	-61.06	10.31	1.16	-51.91	-13.00	38.91
3741.100	H	36.58	-60.12	10.64	1.23	-50.71	-13.00	37.71
3741.100	V	37.15	-59.46	10.64	1.23	-50.05	-13.00	37.05
4208.738	H	35.23	-60.74	10.77	1.33	-51.30	-13.00	38.30
4208.738	V	34.72	-61.21	10.77	1.33	-51.77	-13.00	38.77
4676.375	H	34.13	-60.84	10.81	1.41	-51.44	-13.00	38.44
4676.375	V	33.97	-60.98	10.81	1.41	-51.58	-13.00	38.58

Note 1: The unit of antenna gain is dBd for frequency below 1GHz and is dBi for frequency above 1GHz.

Note 2:

Absolute Level = Substituted Level - Cable loss + Antenna Gain

Margin = Limit - Absolute Level

5. EUT PHOTOGRAPHS

Please refer to the attachment CR230743394-EXP EUT EXTERNAL PHOTOGRAPHS and CR230743394-INP EUT INTERNAL PHOTOGRAPHS

6. TEST SETUP PHOTOGRAPHS

Please refer to the attachment CR230743394-00A-TSP TEST SETUP PHOTOGRAPHS.

******* END OF REPORT *******