

SAR TEST REPORT

Report Reference No...... : **MTE/TAC/B17020136**
FCC ID..... : **PH3DJ-AXD4**
 Compiled by File administrators Chloe Cai
 (position+printed name+signature)..:

Supervised by
 (position+printed name+signature)..: Project Engineer Henry Cai

Approved by
 (position+printed name+signature)..: RF Manager Yvette Zhou

Date of issue.....: January ,15, 2017

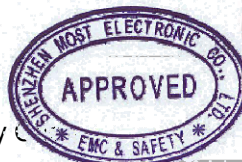

chloe
Henry
Yvette

Representative Laboratory Name : **Most Technology Service Co., Ltd.**
 Address.....: No.5, 2nd Langshan Road, North District, Hi-tech Industrial Park, Nanshan, Shenzhen, Guangdong, China

Testing Laboratory Name : **The Testing and Technology Center for Industrial Products of Shenzhen Entry-Exit Inspection and Quarantine Bureau**
 Address.....: No.149,Gongye 7th Rd. Nanshan District, Shenzhen, China

Applicant's name.....: **Alinco Incorporated, Electronics Division**
 Address.....: Yodoyabashi Dai Building 13F, 4-4-9 Koraibashi, Chuo-Ku, Osaka 541-0043, Japan

Test specification :
 Standard: **IEEE 1528:2013**
 : **47CFR §2.1093**
 TRF Originator.....: Most Technology Service Co., Ltd.

Most Technology Service Co., Ltd. All rights reserved.
 This publication may be reproduced in whole or in part for non-commercial purposes as long as the Most Technology Service Co., Ltd. as copyright owner and source of the material. Most Technology Service Co., Ltd. takes no responsibility for and will not assume liability for damages resulting from the reader's interpretation of the reproduced material due to its placement and context.

Test item description: **UHF DIGITAL TRANSCEIVER**
 Trade Mark: ALINCO
 Manufacturer: **Alinco Incorporated, Electronics Division**
 Model/Type reference.....: DJ-AXD4
 Listed Models: /
 Ratings.....: DC 7.40V
 EUT Type: Production Unit
 Exposure category.....: Occupational /Controlled environment
 Result.....: **PASS**

TEST REPORT

Test Report No. :	MTE/TAC/B17020136	January 15, 2017
		Date of issue

Equipment under Test : **UHF DIGITAL TRANSCEIVER**

Model /Type : DJ-AXD4

Listed Models : /

Applicant : **Alinco Incorporated, Electronics Division**

Address : Yodoyabashi Dai Building 13F, 4-4-9 Koraibashi, Chuo-Ku, Osaka 541-0043, Japan

Manufacturer : **Alinco Incorporated, Electronics Division**

Address : Yodoyabashi Dai Building 13F, 4-4-9 Koraibashi, Chuo-Ku, Osaka 541-0043, Japan

Test Result:	PASS
---------------------	-------------

The test report merely corresponds to the test sample.
It is not permitted to copy extracts of these test result without the written permission of the test laboratory.

**** Modified History ****

Revision	Description	Issued Data	Remark
Revision 1.0	Initial Test Report Release	2017-01-15	Yvette Zhou

Contents

1.	<u>TEST STANDARDS</u>	5
2.	<u>SUMMARY</u>	6
2.1.	General Remarks	6
2.2.	Product Description	6
2.3.	Summary SAR Results	6
2.4.	Equipment under Test	6
2.5.	EUT operation mode	6
2.6.	TEST Configuration	7
2.7.	EUT configuration	7
3.	<u>TEST ENVIRONMENT</u>	8
3.1.	Address of the test laboratory	8
3.2.	Test Facility	8
3.3.	Environmental conditions	8
3.4.	SAR Limits	8
3.5.	Equipments Used during the Test	9
4.	<u>SAR MEASUREMENTS SYSTEM CONFIGURATION</u>	10
4.1.	SAR Measurement Set-up	10
4.2.	DASY5 E-field Probe System	11
4.3.	Phantoms	11
4.4.	Device Holder	12
4.5.	Scanning Procedure	12
4.6.	Data Storage and Evaluation	13
4.7.	SAR Measurement System	14
4.8.	Dielectric Performance	15
4.9.	System Check	16
4.10.	Measurement Procedures	17
5.	<u>TEST CONDITIONS AND RESULTS</u>	22
5.1.	Conducted Power Results	22
5.2.	Test reduction procedure	22
5.3.	SAR Measurement Results	22
5.4.	SAR Measurement Variability	23
5.5.	Measurement Uncertainty (300-3GHz)	24
5.6.	System Check Results	28
5.7.	SAR Test Graph Results	30
6.	<u>CALIBRATION CERTIFICATE</u>	37
6.1.	Probe Calibration Certificate	37
6.2.	D450V3 Dipole Calibration Certificate	48
6.3.	DAE4 Calibration Certificate	56
7.	<u>TEST SETUP PHOTOS</u>	60

1. TEST STANDARDS

The tests were performed according to following standards:

[IEEE 1528-2013 \(2014-06\)](#): Recommended Practice for Determining the Peak Spatial-Average Specific Absorption Rate (SAR) in the Human Head from Wireless Communications Devices: Measurement Techniques

[IEEE Std. C95-3 \(2002\)](#): IEEE Recommended Practice for the Measurement of Potentially Hazardous Electromagnetic Fields – RF and Microwave

[IEEE Std. C95-1 \(1992\)](#): IEEE Standard for Safety Levels with Respect to Human Exposure to Radio Frequency Electromagnetic Fields, 3 kHz to 300 GHz.

[IEC 62209-2 \(2010\)](#): Human exposure to radio frequency fields from hand-held and bodymounted wireless communication devices. Human models, instrumentation, and procedures. Procedure to determine the specific absorption rate (SAR) for wireless communication devices used in close proximity to the human body (frequency range of 30 MHz to 6 GHz)

[KDB 865664D01v01r04 \(August 7, 2015\)](#): SAR Measurement Requirements for 100 MHz to 6 GHz

[KDB 865664D02v01r02 \(October 23, 2015\)](#): RF Exposure Compliance Reporting and Documentation Considerations

[KDB 643646 D01 SAR Test for PTT Radios v01r03 \(October 23, 2015\)](#): SAR Test Reduction Considerations for Occupational PTT Radios

[KDB 447498 D01 General RF Exposure Guidance v06 \(October 23, 2015\)](#): Mobile and Portable Devices RF Exposure Procedures and Equipment Authorization Policies

[2015 October TCB Workshop](#): SAR may be scaled if radio is tested at lower power without overheating as invalid SAR results cannot be scaled to compensate for power droop

2. SUMMARY

2.1. General Remarks

Date of receipt of test sample	:	December 18, 2016
Testing commenced on	:	January ,14, 2017
Testing concluded on	:	January ,15, 2017

2.2. Product Description

EUT Name	:	UHF DIGITAL TRANSCEIVER
Model Number	:	DJ-AXD4
Trade Mark	:	ALINCO
EUT function description	:	Please reference user manual of this device
Power supply	:	DC 7.40V from battery
Operation frequency range	:	400MHz – 470 MHz
Modulation type	:	4FSK(Digital)
RF Rated Output power	:	5W/1W
Emission type	:	F1W/F1D(Digital)
Antenna Type	:	External
Date of Receipt	:	2016/12/18
Device Type	:	Portable
Sample Type	:	Prototype Unit
Exposure category:	:	Occupational exposure / Controlled environment
Test Frequency:	:	406.15 MHz – 422.50MHz – 435.00MHz –450.50MHz-459.5MHz-469.95MHz

2.3. Summary SAR Results

FCC				
Mode	Channel Separation	Frequency (MHz)	Position	Maximum Report SAR Results (W/Kg)
				50% duty cycle
UHF	12.5KHz	406.15	Face-held	1.25
UHF	12.5KHz	406.15	Body-Worn	3.87

2.4. Equipment under Test

Power supply system utilised

Power supply voltage	:	<input type="radio"/> 120V / 60 Hz	<input type="radio"/> 115V / 60Hz
		<input type="radio"/> 12 V DC	<input type="radio"/> 24 V DC
		<input checked="" type="radio"/> Other (specified in blank below)	

DC 7.40 V

2.5. EUT operation mode

The spatial peak SAR values were assessed for UHF systems. Battery and accessories shall be specified by the manufacturer. The EUT battery must be fully charged and checked periodically during the test to ascertain uniform power output.

2.6. TEST Configuration

Face-Held Configuration

Face-held Configuration- per FCC KDB447498 page 22: "A test separation distance of 25 mm must be applied for in-front-of the face SAR test exclusion and SAR measurements."

Per FCC KDB643646 Appendix Head SAR Test Considerations: "Passive body-worn and audio accessories generally do not apply to the head SAR of PTT radios. Head SAR is measured with the front surface of the radio positioned at 2.5cm parallel to a flat phantom. A phantom shell thickness of 2mm is required. When the front of the radio has a contour or non-uniform surface with a variation of 1.0cm or more, the average distance of such variations is used to establish the 2.5cm test separation from the phantom.

Body-worn Configuration

Body-worn measurements-per FCC KDB447498 page 22 "When body-worn accessory SAR testing is required, the body-worn accessory requirements in section 4.2.2 should be applied. PTT two-way radios that support held-to-ear operating mode must also be tested according to the exposure configurations required for handsets. This generally does not apply to cellphones with PTT options that have already been tested in more conservative configurations in applicable wireless modes for SAR compliance at 100% duty factor." According to KDB643646 D01 for Body SAR Test Considerations for Body-worn Accessories: Body SAR is measured with the radio placed in a body-worn accessory, positioned against a flat phantom, representative of the normal operating conditions expected by users and typically with a standard default audio accessory supplied with the radio, may be designed to operate with a subset of the combinations of antennas, batteries and body-worn accessories, when a default audio accessory does not fully support all accessory must be selected to be the default audio accessory for body-worn accessories testing. If an alternative audio accessory cannot be identified, body-worn accessories should be tested without any body accessories should be tested without any audio. In general, all sides of the radio that may be positioned facing the user when using a body-worn accessory must be considered for SAR compliance.

2.7. EUT configuration

The following peripheral devices and interface cables were connected during the measurement:

Accessory name	Internal Identification	Model	Description	Remark
Antenna	A1	N/A	External Antenna	performed
Battery	B1	N/A	Intrinsically Safe Li-ion Battery	performed
Belt clip	BC1	N/A	Belt Clip	performed
Screws	S1	N/A	Screws	performed
Audio Accessories	C1	N/A	Ex earset with On-Mic PTT	performed

AE ID: is used to identify the test sample in the lab internally.

3. TEST ENVIRONMENT

3.1. Address of the test laboratory

The Testing and Technology Center for Industrial Products of Shenzhen Entry-Exit Inspection and Quarantine Bureau

No.149,Gongye 7th Rd. Nanshan District, Shenzhen, China

3.2. Test Facility

The test facility is recognized, certified, or accredited by the following organizations:

CNAS-Lab Code: L2872

3.3. Environmental conditions

During the measurement the environmental conditions were within the listed ranges:

Temperature:	18-25 ° C
Humidity:	40-65 %
Atmospheric pressure:	950-1050mbar

3.4. SAR Limits

Exposure Limits	FCC Limit (1g Tissue)	
	SAR (W/kg)	
	(General Population / Uncontrolled Exposure Environment)	(Occupational / Controlled Exposure Environment)
Spatial Average (averaged over the whole body)	0.08	0.4
Spatial Peak (averaged over any 1 g of tissue)	1.60	8.0
Spatial Peak (hands/wrists/feet/ankles averaged over 10 g)	4.0	20.0

Population/Uncontrolled Environments are defined as locations where there is the exposure of individual who have no knowledge or control of their exposure.

Occupational/Controlled Environments are defined as locations where there is exposure that may be incurred by people who are aware of the potential for exposure (i.e. as a result of employment or occupation).

3.5. Equipments Used during the Test

Test Equipment	Manufacturer	Type/Model	Serial Number	Calibration	
				Last Calibration	Calibration Interval
Data Acquisition Electronics DAEx	SPEAG	DAE4	1315	2016/07/26	1
E-field Probe	SPEAG	ES3DV3	3292	2016/09/02	1
System Validation Dipole D450V3	SPEAG	D450V3	1079	2016/08/29	3
Network analyzer	Agilent	8753E	US37390562	2016/03/05	1
Dielectric Probe Kit	Agilent	85070E	US44020288	/	/
Power meter	Agilent	E4417A	GB41292254	2016/12/14	1
Power sensor	Agilent	8481H	MY41095360	2016/12/14	1
Power sensor	Agilent	8481H	MY41095361	2016/12/14	1
Signal generator	IFR	2032	203002/100	2016/12/14	1
Amplifier	AR	75A250	302205	2016/12/14	1

Note:

- 1) Per KDB865664D01 requirements for dipole calibration, the test laboratory has adopted three year extended calibration interval. Each measured dipole is expected to evaluate with following criteria at least on annual interval.
 - a) There is no physical damage on the dipole;
 - b) System check with specific dipole is within 10% of calibrated values;
 - c) The most recent return-loss results, measured at least annually, deviates by no more than 20% from the previous measurement;
 - d) The most recent measurement of the real or imaginary parts of the impedance, measured at least annually is within 50 Ω from the previous measurement.
- 2) Network analyzer probe calibration against air, distilled water and a shorting block performed before measuring liquid parameters.

4. SAR Measurements System configuration

4.1. SAR Measurement Set-up

The DASY5 system for performing compliance tests consists of the following items:

A standard high precision 6-axis robot (Stäubli RX family) with controller and software. An arm extension for accommodating the data acquisition electronics (DAE).

A dosimetric probe, i.e. an isotropic E-field probe optimized and calibrated for usage in tissue simulating liquid. The probe is equipped with an optical surface detector system.

A data acquisition electronic (DAE) which performs the signal amplification, signal multiplexing, AD-conversion, offset measurements, mechanical surface detection, collision detection, etc. The unit is battery powered with standard or rechargeable batteries. The signal is optically transmitted to the EOC.

A unit to operate the optical surface detector which is connected to the EOC.

The Electro-Optical Coupler (EOC) performs the conversion from the optical into a digital electric signal of the DAE. The EOC is connected to the DASY5 measurement server.

The DASY5 measurement server, which performs all real-time data evaluation for field measurements and surface detection, controls robot movements and handles safety operation. A computer operating Windows 2003.

DASY5 software and SEMCAD data evaluation software.

Remote control with teach panel and additional circuitry for robot safety such as warning lamps, etc.

The generic twin phantom enabling the testing of left-hand and right-hand usage.

The device holder for handheld Mobile Phones.

Tissue simulating liquid mixed according to the given recipes.

System validation dipoles allowing to validate the proper functioning of the system.

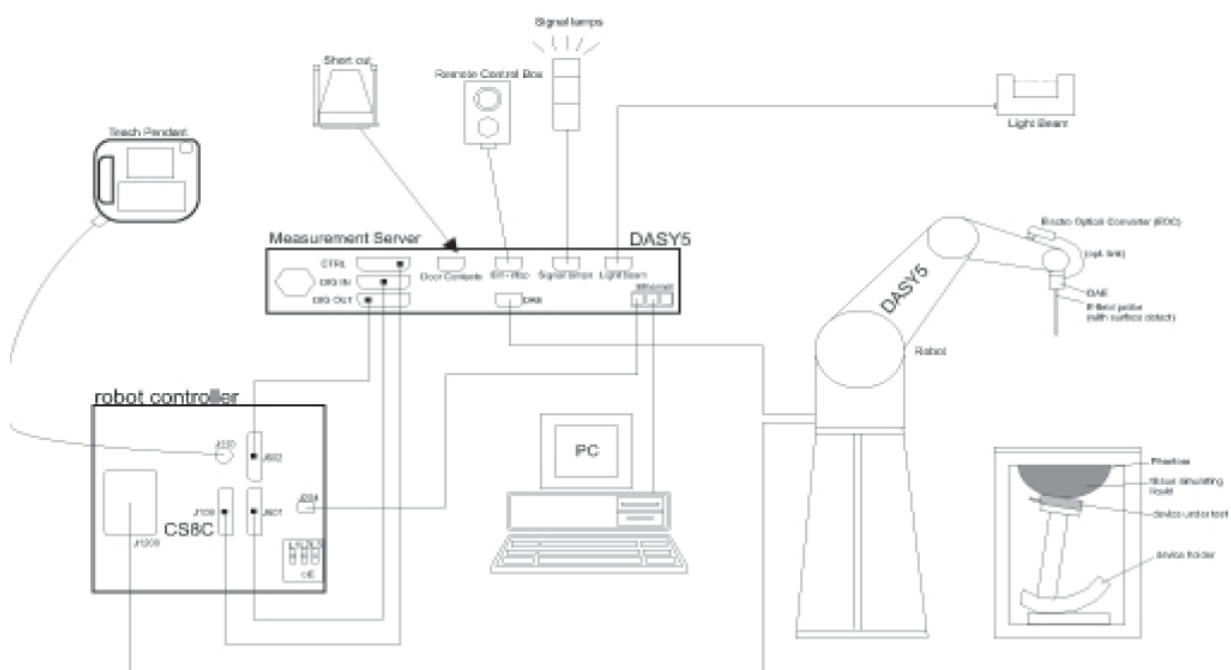

4.2. DASY5 E-field Probe System

The SAR measurements were conducted with the dosimetric probe ES3DV3 (manufactured by SPEAG), designed in the classical triangular configuration and optimized for dosimetric evaluation.

Probe Specification

Construction	Symmetrical design with triangular core Interleaved sensors Built-in shielding against static charges PEEK enclosure material (resistant to organic solvents, e.g., DGBE)
Calibration	ISO/IEC 17025 calibration service available.
Frequency	10 MHz to 4 GHz; Linearity: ± 0.2 dB (30 MHz to 4 GHz)
Directivity	± 0.2 dB in HSL (rotation around probe axis) ± 0.3 dB in tissue material (rotation normal to probe axis)
Dynamic Range	5 μ W/g to > 100 mW/g; Linearity: ± 0.2 dB
Dimensions	Overall length: 337 mm (Tip: 20 mm) Tip diameter: 3.9 mm (Body: 12 mm) Distance from probe tip to dipole centers: 2.0 mm
Application	General dosimetry up to 4 GHz Dosimetry in strong gradient fields Compliance tests of Mobile Phones
Compatibility	DASY3, DASY4, DASY52 SAR and higher, EASY4/MRI



Isotropic E-Field Probe

The isotropic E-Field probe has been fully calibrated and assessed for isotropicity, and boundary effect within a controlled environment. Depending on the frequency for which the probe is calibrated the method utilized for calibration will change.

The E-Field probe utilizes a triangular sensor arrangement as detailed in the diagram below:

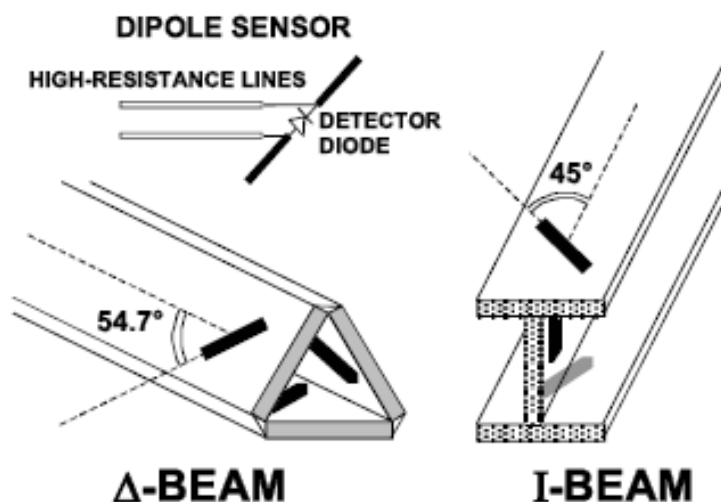

4.3. Phantoms

Phantom for compliance testing of handheld and body-mounted wireless devices in the frequency range of 30 MHz to 6 GHz. ELI is fully compatible with the IEC 62209-2 standard and all known tissue-simulating liquids. ELI has been optimized regarding its performance and can be integrated into our standard phantom tables. A cover prevents evaporation of the liquid. Reference markings on the phantom allow installation of the complete setup, including all predefined phantom positions and measurement grids, by teaching three points. The

phantom is compatible with all SPEAGdosimetric probes and dipoles.



ELI Phantom

4.4. Device Holder

The device was placed in the device holder (illustrated below) that is supplied by SPEAG as an integral part of the DASY system.

The DASY device holder is designed to cope with the different positions given in the standard. It has two scales for device rotation (with respect to the body axis) and device inclination (with respect to the line between the ear reference points). The rotation centers for both scales is the ear reference point (ERP). Thus the device needs no repositioning when changing the angles.

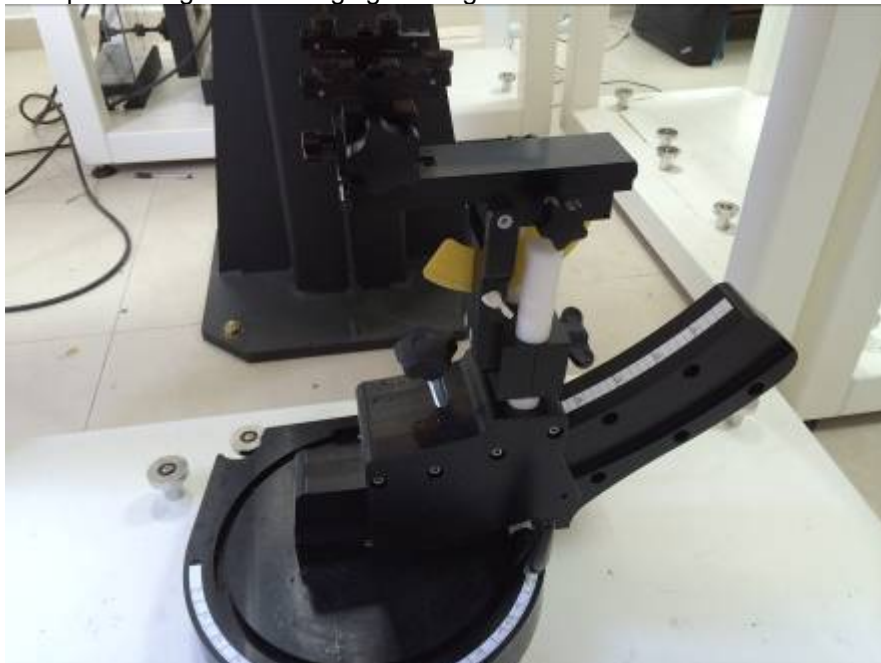

Device holder supplied by SPEAG

4.5. Scanning Procedure

The DASY5 installation includes predefined files with recommended procedures for measurements and validation. They are read-only document files and destined as fully defined but unmeasured masks. All test positions (head or body-worn) are tested with the same configuration of test steps differing only in the grid definition for the different test positions.

The “reference” and “drift” measurements are located at the beginning and end of the batch process. They measure the field drift at one single point in the liquid over the complete procedure. The indicated drift is

mainly the variation of the DUT's output power and should vary max. $\pm 5\%$.

The "surface check" measurement tests the optical surface detection system of the DASY5 system by repeatedly detecting the surface with the optical and mechanical surface detector and comparing the results. The output gives the detecting heights of both systems, the difference between the two systems and the standard deviation of the detection repeatability. Air bubbles or refraction in the liquid due to separation of the sugar-water mixture gives poor repeatability (above $\pm 0.1\text{mm}$). To prevent wrong results tests are only executed when the liquid is free of air bubbles. The difference between the optical surface detection and the actual surface depends on the probe and is specified with each probe (It does not depend on the surface reflectivity or the probe angle to the surface within $\pm 30^\circ$.)

Area Scan

The Area Scan is used as a fast scan in two dimensions to find the area of high field values before running a detailed measurement around the hot spot. Before starting the area scan a grid spacing of 15 mm x 15 mm is set. During the scan the distance of the probe to the phantom remains unchanged. After finishing area scan, the field maxima within a range of 2 dB will be ascertained.

Zoom Scan

Zoom Scans are used to estimate the peak spatial SAR values within a cubic averaging volume containing 1 g and 10 g of simulated tissue. The default Zoom Scan is done by 7x7x7 points within a cube whose base is centered around the maxima found in the preceding area scan.

Spatial Peak Detection

The procedure for spatial peak SAR evaluation has been implemented and can determine values of masses of 1g and 10g, as well as for user-specific masses. The DASY5 system allows evaluations that combine measured data and robot positions, such as: • maximum search • extrapolation • boundary correction • peak search for averaged SAR. During a maximum search, global and local maxima searches are automatically performed in 2-D after each Area Scan measurement with at least 6 measurement points. It is based on the evaluation of the local SAR gradient calculated by the Quadratic Shepard's method. The algorithm will find the global maximum and all local maxima within -2 dB of the global maxima for all SAR distributions.

Extrapolation routines are used to obtain SAR values between the lowest measurement points and the inner phantom surface. The extrapolation distance is determined by the surface detection distance and the probe sensor offset. Several measurements at different distances are necessary for the extrapolation. Extrapolation routines require at least 10 measurement points in 3-D space. They are used in the Zoom Scan to obtain SAR values between the lowest measurement points and the inner phantom surface. The routine uses the modified Quadratic Shepard's method for extrapolation. For a grid using 7x7x7 measurement points with 5mm resolution amounting to 343 measurement points, the uncertainty of the extrapolation routines is less than 1% for 1g and 10g cubes.

A Z-axis scan measures the total SAR value at the x- and y-position of the maximum SAR value found during the cube 7x7x7 scan. The probe is moved away in z-direction from the bottom of the SAM phantom in 5mm steps.

4.6. Data Storage and Evaluation

Data Storage

The DASY5 software stores the acquired data from the data acquisition electronics as raw data (in microvolt readings from the probe sensors), together with all necessary software parameters for the data evaluation (probe calibration data, liquid parameters and device frequency and modulation data) in measurement files with the extension ".DA4". The software evaluates the desired unit and format for output each time the data is visualized or exported. This allows verification of the complete software setup even after the measurement and allows correction of incorrect parameter settings. For example, if a measurement has been performed with a wrong crest factor parameter in the device setup, the parameter can be corrected afterwards and the data can be re-evaluated.

The measured data can be visualized or exported in different units or formats, depending on the selected probe type ([V/m], [A/m], [°C], [mW/g], [mW/cm²], [dBrel], etc.). Some of these units are not available in certain situations or show meaningless results, e.g., a SAR output in a lossless media will always be zero. Raw data can also be exported to perform the evaluation with other software packages.

Data Evaluation

The SEMCAD software automatically executes the following procedures to calculate the field units from the microvolt readings at the probe connector. The parameters used in the evaluation are stored in the configuration modules of the software:

Probe parameters:	- Sensitivity	Normi, ai0, ai1, ai2
	- Conversion factor	ConvFi
	- Diode compression point	Dcpi
Device parameters:	- Frequency	f
	- Crest factor	cf
Media parameters:	- Conductivity	σ
	- Density	ρ

These parameters must be set correctly in the software. They can be found in the component documents or they can be imported into the software from the configuration files issued for the DASY5 components. In the direct measuring mode of the multimeter option, the parameters of the actual system setup are used. In the scan visualization and export modes, the parameters stored in the corresponding document files are used.

The first step of the evaluation is a linearization of the filtered input signal to account for the compression characteristics of the detector diode. The compensation depends on the input signal, the diode type and the DC-transmission factor from the diode to the evaluation electronics. If the exciting field is pulsed, the crest factor of the signal must be known to correctly compensate for peak power. The formula for each channel can be given as:

$$V_i = U_i + U_i^2 \cdot \frac{cf}{dcp_i}$$

With	V_i	= compensated signal of channel i	(i = x, y, z)
	U_i	= input signal of channel i	(i = x, y, z)
	cf	= crest factor of exciting field	(DASY parameter)
	dcp _i	= diode compression point	(DASY parameter)

From the compensated input signals the primary field data for each channel can be evaluated:

$$\text{E - fieldprobes : } E_i = \sqrt{\frac{V_i}{Norm_i \cdot ConvF}}$$

$$\text{H - fieldprobes : } H_i = \sqrt{V_i} \cdot \frac{a_{i0} + a_{i1}f + a_{i2}f^2}{f}$$

With	V_i	= compensated signal of channel i	(i = x, y, z)
	Norm _i	= sensor sensitivity of channel i	(i = x, y, z)
		[mV/(V/m) ²] for E-field Probes	
	ConvF	= sensitivity enhancement in solution	
	a _{ij}	= sensor sensitivity factors for H-field probes	
	f	= carrier frequency [GHz]	
	E_i	= electric field strength of channel i in V/m	
	H_i	= magnetic field strength of channel i in A/m	

The RSS value of the field components gives the total field strength (Hermitian magnitude):

$$E_{tot} = \sqrt{E_x^2 + E_y^2 + E_z^2}$$

The primary field data are used to calculate the derived field units.

$$SAR = E_{tot}^2 \cdot \frac{\sigma}{\rho \cdot 1'000}$$

with	SAR	= local specific absorption rate in mW/g
	E_{tot}	= total field strength in V/m
	σ	= conductivity in [mho/m] or [Siemens/m]
	ρ	= equivalent tissue density in g/cm ³

Note that the density is normally set to 1 (or 1.06), to account for actual brain density rather than the density of the simulation liquid.

4.7. SAR Measurement System

The SAR measurement system being used is the DASY5 system, the system is controlled remotely from a PC, which contains the software to control the robot and data acquisition equipment. The software also displays the data obtained from test scans.

In operation, the system first does an area (2D) scan at a fixed depth within the liquid from the inside wall of the phantom. When the maximum SAR point has been found, the system will then carry out a 3D scan centred at that point to determine volume averaged SAR level.

4.7.1 Tissue Dielectric Parameters for Head and Body Phantoms

The liquid is consisted of water,salt,Glycol,Sugar,Preventol and Cellulose.The liquid has previously been proven to be suited for worst-case. It's satisfying the latest tissue dielectric parameters requirements proposed by the KDB865664.

Target Frequency (MHz)	Head		Body	
	ϵ_r	σ (S/m)	ϵ_r	σ (S/m)
150	52.3	0.76	61.9	0.80
300	45.3	0.87	58.2	0.92
450	43.5	0.87	56.7	0.94
835	41.5	0.90	55.2	0.97
900	41.5	0.97	55.0	1.05
915	41.5	0.98	55.0	1.06
1450	40.5	1.20	54.0	1.30
1610	40.3	1.29	53.8	1.40
1800-2000	40.0	1.40	53.3	1.52
2450	39.2	1.80	52.7	1.95
3000	38.5	2.40	52.0	2.73
5800	35.3	5.27	48.2	6.00

(ϵ_r = relative permittivity, σ = conductivity and $\rho = 1000 \text{ kg/m}^3$)

4.8. Dielectric Performance

Dielectric performance of Head and Body tissue simulating liquid.

Composition of the Head Tissue Equivalent Matter

Mixture %	Frequency (Brain) 450MHz
Water	38.56
Sugar	56.32
Salt	3.95
Preventol	0.10
Cellulose	1.07
Dielectric Parameters Target Value	f=450MHz $\epsilon_r=43.5$ $\sigma=0.87$

Composition of the Body Tissue Equivalent Matter

Mixture %	Frequency (Brain) 450MHz
Water	56.16
Sugar	46.78
Salt	1.49
Preventol	0.10
Cellulose	0.47
Dielectric Parameters Target Value	f=450MHz $\epsilon_r=56.7$ $\sigma=0.94$

Tissue Type	Measured Frequency (MHz)	Target Tissue		Measured Tissue				Liquid Temp.	Test Data
		ϵ_r	σ	ϵ_r	Dev. %	σ	Dev. %		
450H	450	43.5	0.87	44.1	1.38	0.89	2.30	22.2 degree	2017-01-14
450B	450	56.7	0.94	57.2	0.88	0.96	2.13	22.2 degree	2017-01-14

4.9. System Check

The purpose of the system check is to verify that the system operates within its specifications at the device test frequency. The system check is simple check of repeatability to make sure that the system works correctly at the time of the compliance test;

System check results have to be equal or near the values determined during dipole calibration with the relevant liquids and test system ($\pm 10\%$).

System check is performed regularly on all frequency bands where tests are performed with the DASY5 system.

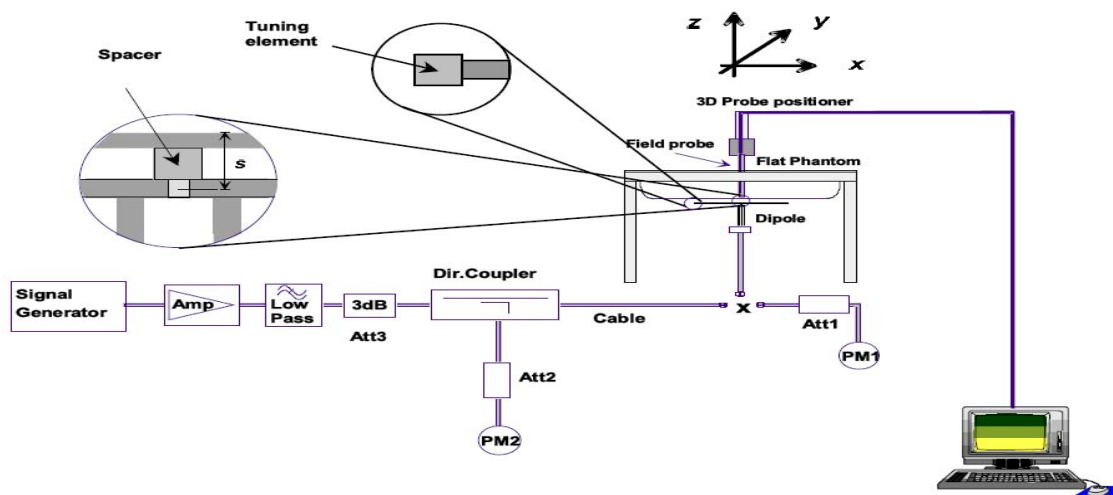

The output power on dipole port must be calibrated to 24 dBm (250mW) before dipole is connected.

Justification for Extended SAR Dipole Calibrations

Referring to KDB 865664D01V01r04, if dipoles are verified in return loss ($< -20\text{dB}$, within 20% of prior calibration), and in impedance (within 5 ohm of prior calibration), the annual calibration is not necessary and the calibration interval can be extended. While calibration intervals not exceed 3 years.

System Check in Head Tissue Simulating Liquid

Freq	Test Date	Dielectric Parameters		Temp	250mW Measured		1W Normalized		1W Target		Limit ($\pm 10\%$ Deviation)	
		ϵ_r	$\sigma(\text{s/m})$		SAR _{1g}	SAR _{10g}	SAR _{1g}	SAR _{10g}	SAR _{1g}	SAR _{10g}	SAR _{1g}	SAR _{10g}
450MHz	2017/01/14	44.1	0.89	22.2	1.18	0.786	4.72	3.14	4.58	3.06	3.06%	2.75%

System Check in Body Tissue Simulating Liquid

Freq	Test Date	Dielectric Parameters		Temp	250mW Measured		1W Normalized		1W Target		Limit ($\pm 10\%$ Deviation)	
		ϵ_r	$\sigma(\text{s/m})$		SAR _{1g}	SAR _{10g}	SAR _{1g}	SAR _{10g}	SAR _{1g}	SAR _{10g}	SAR _{1g}	SAR _{10g}
450MHz	2017/01/14	57.2	0.96	22.2	1.13	0.757	4.52	3.03	4.60	3.03	-1.74%	-0.00%

4.10. Measurement Procedures

Tests to be performed

In order to determine the highest value of the peak spatial-average SAR of a handset, all device positions, configurations and operational modes shall be tested for each frequency band according to steps 1 to 3 below. A flowchart of the test process is shown in Picture 11

Step 1: The tests described in 11.2 shall be performed at the channel that is closest to the centre of the transmit frequency band (f_c) for:

- a) all device positions (cheek and tilt, for both left and right sides of the SAM phantom, as described in Chapter 8),
- b) all configurations for each device position in a), e.g., antenna extended and retracted, and
- c) all operational modes, e.g., analogue and digital, for each device position in a) and configuration in b) in each frequency band.
- d) If more than three frequencies need to be tested according to 11.1 (i.e., $N_c > 3$), then all frequencies, configurations and modes shall be tested for all of the above test conditions.

Step 2: For the condition providing highest peak spatial-average SAR determined in Step 1, perform all tests described in 11.2 at all other test frequencies, i.e., lowest and highest frequencies. In addition, for all other conditions (device position, configuration and operational mode) where the peak spatial-average SAR value determined in Step 1 is within 3 dB of the applicable SAR limit, it is recommended that all other test frequencies shall be tested as well.

Step 3: Examine all data to determine the highest value of the peak spatial-average SAR found in Steps 1 to 2.

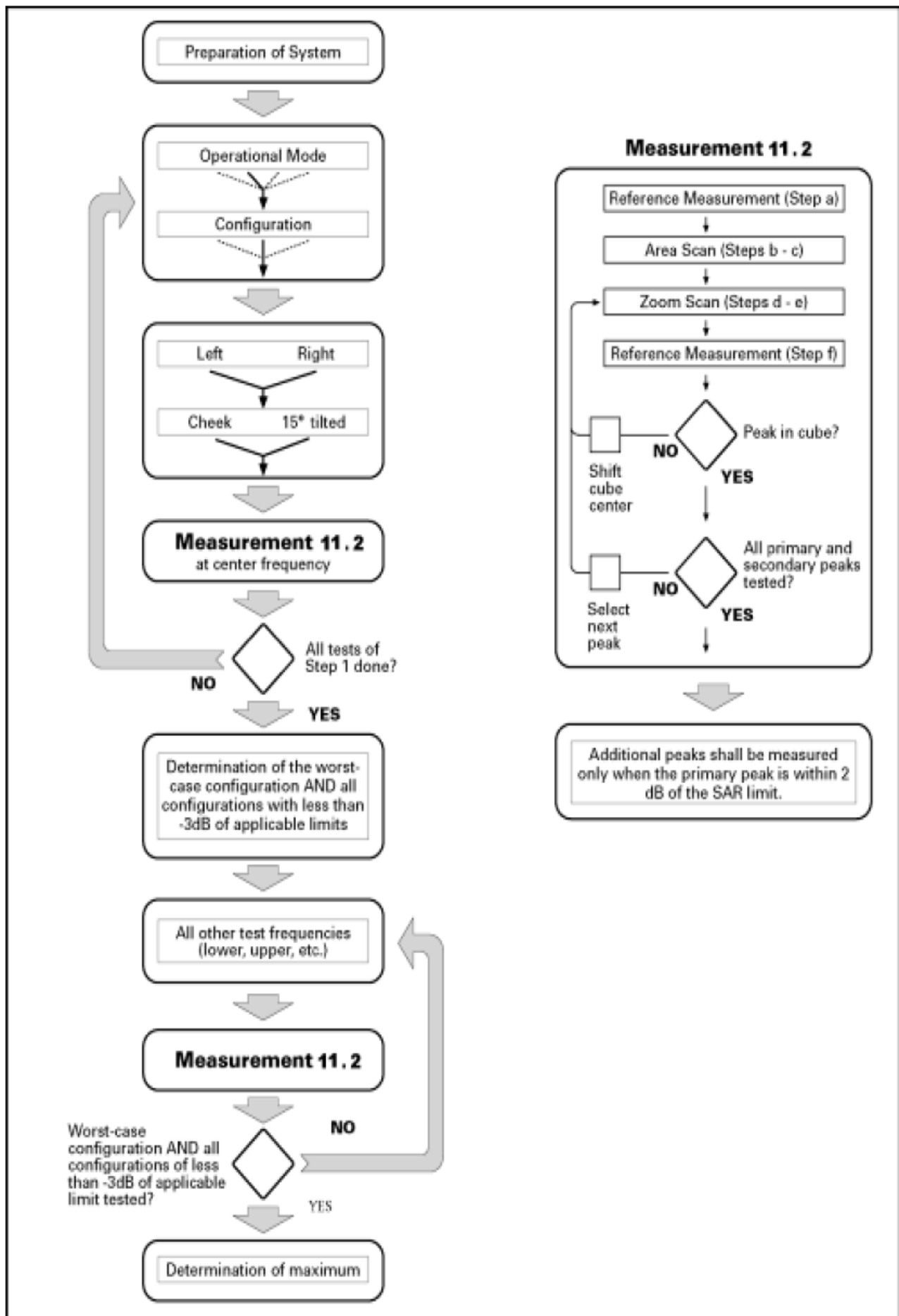

Picture 11 Block diagram of the tests to be performed

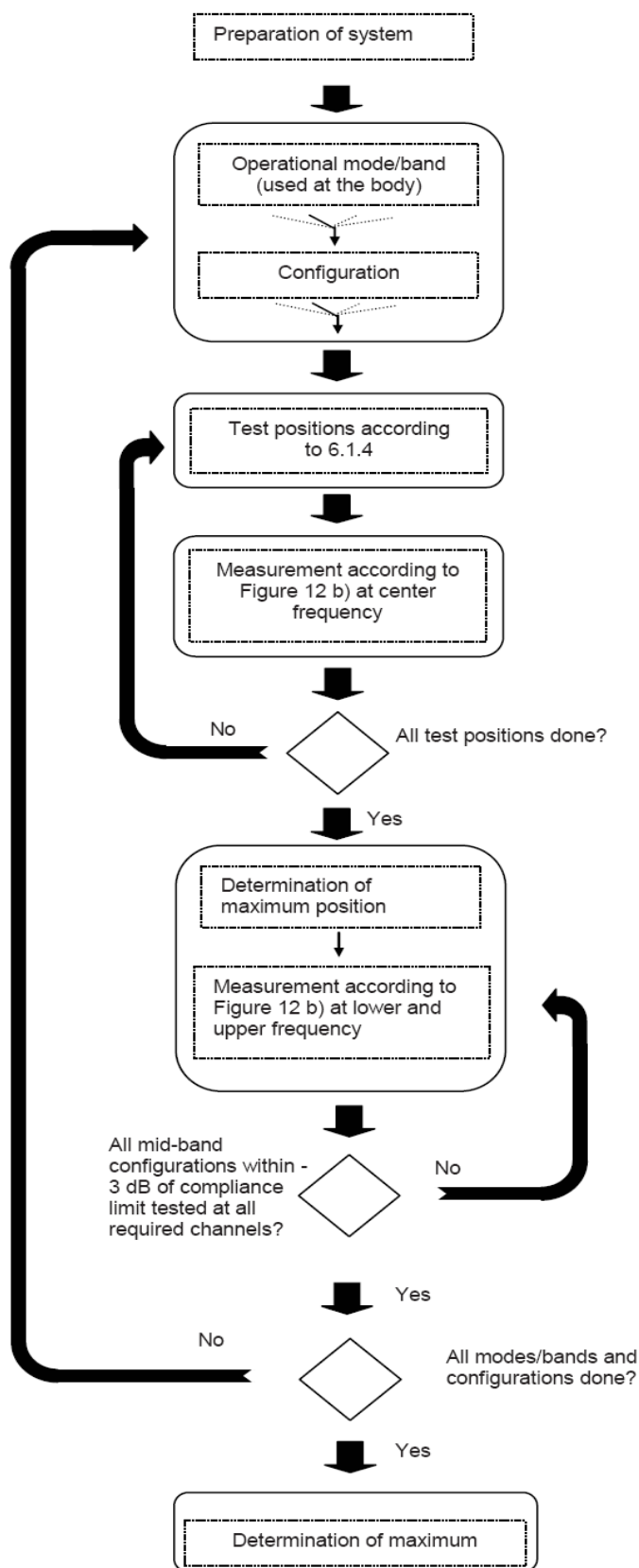

Figure 12a – Tests to be performed

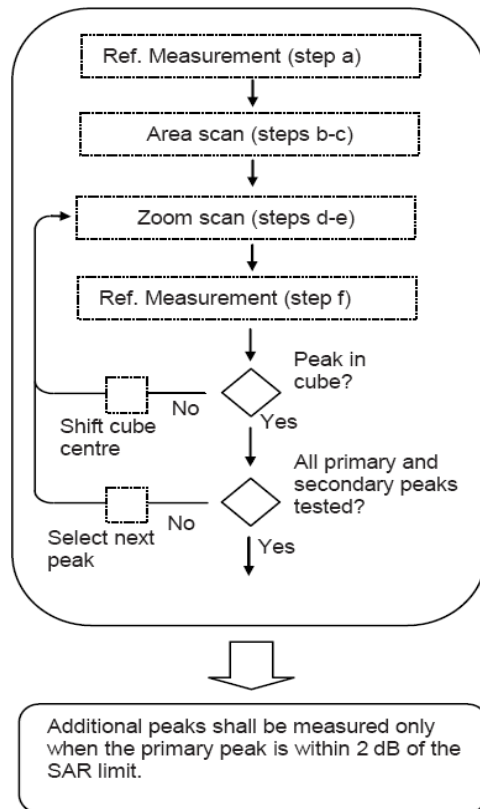

Figure 12b – General procedure

Picture 12 Block diagram of the tests to be performed

Measurement procedure

The following procedure shall be performed for each of the test conditions (see Picture 11) described in 11.1:

- a) Measure the local SAR at a test point within 8 mm or less in the normal direction from the inner surface of the phantom.
- b) Measure the two-dimensional SAR distribution within the phantom (area scan procedure). The boundary of the measurement area shall not be closer than 20 mm from the phantom side walls. The distance between the measurement points should enable the detection of the location of local maximum with an

accuracy of better than half the linear dimension of the tissue cube after interpolation. A maximum grip spacing of 20 mm for frequencies below 3 GHz and $(60/f \text{ [GHz]})$ mm for frequencies of 3GHz and greater is recommended. The maximum distance between the geometrical centre of the probe detectors and the inner surface of the phantom shall be 5 mm for frequencies below 3 GHz and $\delta \ln(2)/2$ mm for frequencies of 3 GHz and greater, where δ is the plane wave skin depth and $\ln(x)$ is the natural logarithm. The maximum variation of the sensor-phantom surface shall be ± 1 mm for frequencies below 3 GHz and ± 0.5 mm for frequencies of 3 GHz and greater. At all measurement points the angle of the probe with respect to the line normal to the surface should be less than 5° . If this cannot be achieved for a measurement distance to the phantom inner surface shorter than the probe diameter, additional measurement distance to the phantom inner surface shorter than the probe diameter, additional

- c) From the scanned SAR distribution, identify the position of the maximum SAR value, in addition identify the positions of any local maxima with SAR values within 2 dB of the maximum value that are not within the zoom-scan volume; additional peaks shall be measured only when the primary peak is within 2 dB of the SAR limit. This is consistent with the 2 dB threshold already stated;
- d) Measure the three-dimensional SAR distribution at the local maxima locations identified in step
- e) The horizontal grid step shall be $(24 / f[\text{GHz}])$ mm or less but not more than 8 mm. The minimum zoom size of 30 mm by 30 mm and 30 mm for frequencies below 3 GHz. For higher frequencies, the minimum zoom size of 22 mm by 22 mm and 22 mm. The grip step in the vertical direction shall be $(8-f[\text{GHz}])$ mm or less but not more than 5 mm, if uniform spacing is used. If variable spacing is used in the vertical direction, the maximum spacing between the two closest measured points to the phantom shell shall be $(12 / f[\text{GHz}])$ mm or less but not more than 4 mm, and the spacing between father points shall increase by an incremental factor not exceeding 1.5. When variable spacing is used, extrapolation routines shall be tested with the same spacing as used in measurements. The maximum distance between the geometrical centre of the probe detectors and the inner surface of the phantom shall be 5 mm for frequencies below 3 GHz and $\delta \ln(2)/2$ mm for frequencies of 3 GHz and greater, where δ is the plane wave skin depth and $\ln(x)$ is the natural logarithm. Separate grids shall be centered on each of the local SAR maxima found in step c). Uncertainties due to field distortion between the media boundary and the dielectric enclosure of the probe should also be minimized, which is achieved is the distance between the phantom surface and physical tip of the probe is larger than probe tip diameter. Other methods may utilize correction procedures for these boundary effects that enable high precision measurements closer than half the probe diameter. For all measurement points, the angle of the probe with respect to the flat phantom surface shall be less than 5° . If this cannot be achieved an additional uncertainty evaluation is needed.
- f) Use post processing(e.g. interpolation and extrapolation) procedures to determine the local SAR values at the spatial resolution needed for mass averaging.

Measurement procedure

The following procedure shall be performed for each of the test conditions (see Picture 11) described in 11.1:

- g) Measure the local SAR at a test point within 8 mm or less in the normal direction from the inner surface of the phantom.
- h) Measure the two-dimensional SAR distribution within the phantom (area scan procedure). The boundary of the measurement area shall not be closer than 20 mm from the phantom side walls. The distance between the measurement points should enable the detection of the location of local maximum with an accuracy of better than half the linear dimension of the tissue cube after interpolation. A maximum grip spacing of 20 mm for frequencies below 3 GHz and $(60/f \text{ [GHz]})$ mm for frequencies of 3GHz and greater is recommended. The maximum distance between the geometrical centre of the probe detectors and the inner surface of the phantom shall be 5 mm for frequencies below 3 GHz and $\delta \ln(2)/2$ mm for frequencies of 3 GHz and greater, where δ is the plane wave skin depth and $\ln(x)$ is the natural logarithm. The maximum variation of the sensor-phantom surface shall be ± 1 mm for frequencies below 3 GHz and ± 0.5 mm for frequencies of 3 GHz and greater. At all measurement points the angle of the probe with respect to the line normal to the surface should be less than 5° . If this cannot be achieved for a measurement distance to the phantom inner surface shorter than the probe diameter, additional measurement distance to the phantom inner surface shorter than the probe diameter, additional
- i) From the scanned SAR distribution, identify the position of the maximum SAR value, in addition identify the positions of any local maxima with SAR values within 2 dB of the maximum value that are not within the zoom-scan volume; additional peaks shall be measured only when the primary peak is within 2 dB of the SAR limit. This is consistent with the 2 dB threshold already stated;
- j) Measure the three-dimensional SAR distribution at the local maxima locations identified in step
- k) The horizontal grid step shall be $(24 / f[\text{GHz}])$ mm or less but not more than 8 mm. The minimum zoom size of 30 mm by 30 mm and 30 mm for frequencies below 3 GHz. For higher frequencies, the minimum zoom size of 22 mm by 22 mm and 22 mm. The grip step in the vertical direction shall be $(8-f[\text{GHz}])$ mm or less but not more than 5 mm, if uniform spacing is used. If variable spacing is used in the vertical direction, the maximum spacing between the two closest measured points to the phantom shell shall be $(12 / f[\text{GHz}])$ mm or less but not more than 4 mm, and the spacing between father points shall increase by an incremental factor not exceeding 1.5. When variable spacing is used, extrapolation routines shall be tested with the same spacing as used in measurements. The maximum distance between the geometrical

centre of the probe detectors and the inner surface of the phantom shall be 5 mm for frequencies below 3 GHz and $\delta \ln(2)/2$ mm for frequencies of 3 GHz and greater, where δ is the plane wave skin depth and $\ln(x)$ is the natural logarithm. Separate grids shall be centered on each of the local SAR maxima found in step c). Uncertainties due to field distortion between the media boundary and the dielectric enclosure of the probe should also be minimized, which is achieved if the distance between the phantom surface and physical tip of the probe is larger than probe tip diameter. Other methods may utilize correction procedures for these boundary effects that enable high precision measurements closer than half the probe diameter. For all measurement points, the angle of the probe with respect to the flat phantom surface shall be less than 5°. If this cannot be achieved an additional uncertainty evaluation is needed.

- l) Use post processing (e.g. interpolation and extrapolation) procedures to determine the local SAR values at the spatial resolution needed for mass averaging.

Power Drift

To control the output power stability during the SAR test, DASY5 system calculates the power drift by measuring the E-field at the same location at the beginning and at the end of the measurement for each test position. These drift values can be found in Table 2 to Table 6 labeled as: (Power Drift [dB]). This ensures that the power drift during one measurement is within 5%.

5. TEST CONDITIONS AND RESULTS

5.1. Conducted Power Results

According KDB 447498 D01 General RF Exposure Guidance v05r01Section 4.1 2) states that “Unless it is specified differently in the published RF exposure KDB procedures, these requirements also apply to test reduction and test exclusion considerations. Time-averaged maximum conducted output power applies to SAR and, as required by § 2.1091(c), time-averaged ERP applies to MPE. When an antenna port is not available on the device to support conducted power measurement, such as FRS and certain Part 15 transmitters with built-in integral antennas, the maximum output power allowed for production units should be used to determine RF exposure test exclusion and compliance.”

SAR may be scaled if radio is tested at lower power without overheating as invalid SAR results cannot be scaled to compensate for power droop according to October 2015 TCB Workshop.

Modulation Type	Channel Separation	Test Channel	Test Frequency	Transmitter Power			
				Rated High power level		Rated Lower power level	
				(dBm)	(Watts)	(dBm)	(Watts)
Digital/4FSK	12.5KHz	Ch1	406.15	36.72	4.70	30.50	1.12
		Ch2	422.50	36.68	4.66	30.36	1.09
		Ch3	435.00	36.59	4.56	30.20	1.05
		Ch4	450.50	36.55	4.52	30.27	1.06
		Ch5	459.50	36.48	4.45	30.35	1.08
		Ch6	469.95	36.37	4.34	30.40	1.10

5.2. Test reduction procedure

The maximum power level, $P_{max,m}$, that can be transmitted by a device before the SAR averaged over a mass, m , exceeds a given limit, SAR_{lim} , can be defined. Any device transmitting at power levels below $P_{max,m}$ can then be excluded from SAR testing. The lowest possible value for $P_{max,m}$ is: $P_{max,m} = SAR_{lim} * m$.

5.3. SAR Measurement Results

Test Frequency		Mode	Maximum Allowed Power (dBm)	Conducted Power (dBm)	Test Configuration	Measurement SAR _{1-g} (W/Kg)		Power drift	Scaling Factor	Reported SAR _{1-g} (W/kg)		SAR limit 1g (W/kg)	Ref. Plot
Channel	MHz					100% Duty Cycle	50% Duty Cycle			100% Duty Cycle	50% Duty Cycle		
The EUT display towards ground for 12.5 KHz (Digital, face held)													
Ch1	406.15	PTT	37.00	36.72	Face Held	2.34	1.17	-0.10	1.07	2.50	1.25	8.00	1
The EUT display towards ground for 12.5 KHz with A1, B1,BC1,S1 and C1 (Digital, Body-Worn)													
Ch1	406.15	PTT	37.00	36.72	Body Worn	7.26	3.63	-0.12	1.07	7.74	3.87	8.00	2
Ch2	422.50	PTT	37.00	36.68	Body Worn	6.38	3.19	-0.13	1.08	6.87	3.44	8.00	3
Ch3	435.00	PTT	37.00	36.59	Body Worn	6.62	3.31	-0.02	1.10	7.28	3.64	8.00	4
Ch4	450.50	PTT	37.00	36.55	Body Worn	6.24	3.12	-0.13	1.11	6.92	3.46	8.00	5
Ch5	459.50	PTT	37.00	36.48	Body Worn	6.36	3.18	-0.16	1.13	7.17	3.59	8.00	6
Ch6	469.95	PTT	37.00	36.37	Body Worn	6.45	3.23	-0.16	1.16	7.46	3.73	8.00	6

Note:

1. When devices that are designed to operate on the body of users using lanyards and straps, or without requiring additional body-worn accessories, must be tested for SAR compliance using a conservative minimum test separation distance ≤ 5 mm to support compliance refer to KDB447498.
2. Except when area scan based 1-g SAR estimation applies, a zoom scan measurement is required at the highest peak SAR location determined in the area scan to determine the 1-g SAR. When the 1-g SAR of the highest peak is within 2 dB of the SAR limit, additional zoom scans are required for other peaks within 2 dB of the highest peak that have not been included in any zoom scan to ensure there is no increase in SAR refer to KDB865664D01v01r04.
3. When the highest reported SAR is <6.0 W/Kg (based on 50% Duty Cycle), PBA is not required according to KDB643646 and KDB388624 D02;
4. Testing antennas with the default battery: Starting by testing a PTT radio with a standard battery (default battery) that is supplied with the radio to measure the head SAR of each antenna on the highest output power channel, according to test channels required by KDB447498 and in the frequency range covered by each antenna within the operating frequency bands of the radio. When multiple standard batteries are supplied with a radio, the battery with the highest capacity is considered the default battery for making head SAR measurements:
When the head SAR of antenna tested in above description is:
 - a. ≤ 3.5 W/Kg. testing of all other required channels is not necessary for that antenna;
 - b. >3.5 W/Kg and ≤ 4.0 W/Kg, testing of the required immediately adjacent channel(s) is not necessary, testing of the other required channels maybe still be required.
 - c. >4.0 W/Kg and ≤ 6.0 W/Kg, Head SAR should be measured for that antenna on the required immediately adjacent channel(s) is not necessary, testing of the other required channels still needs consideration.
 - d. >6.0 W/Kg, test all required channels for that antenna.
 - e. For the remaining channels that cannot be excluded in b) and c), which still require consideration, the 3.5 W/Kg exclusion in a) and 4.0 W/Kg exclusion in b) may be applied recursively with respect to the highest output power channel among the remaining channels; measure the SAR for the remaining channels that cannot be excluded.
 - i) If an immediately adjacent channel measured in c) or a remaining channel measured in e) is >6.0 W/Kg, test all required channels for that antenna.
5. Testing antennas with the default battery: Starting by testing a PTT radio with the thinnest battery and standard (default) body-worn accessory that are both supplied with the radio and if applicable, a default audio accessory, to measure the body SAR of each antenna on the highest output power channel, according to test channels required by KDB447498 and in the frequency range covered by each antenna within the operating frequency bands of the radio. When multiple standard body-worn accessories are supplied with a radio, the standard body-worn accessory expected to result in the highest SAR based on its construction and exposure conditions is considered the default body-worn accessory for making body-worn SAR measurements:
When the head SAR of antenna tested in above description is:
 - a. ≤ 3.5 W/Kg. testing of all other required channels is not necessary for that antenna;
 - b. >3.5 W/Kg and ≤ 4.0 W/Kg, testing of the required immediately adjacent channel(s) is not necessary, testing of the other required channels maybe still be required.
 - c. >4.0 W/Kg and ≤ 6.0 W/Kg, Head SAR should be measured for that antenna on the required immediately adjacent channel(s) is not necessary, testing of the other required channels still needs consideration.
 - d. >6.0 W/Kg, test all required channels for that antenna.
 - e. For the remaining channels that cannot be excluded in b) and c), which still require consideration, the 3.5 W/Kg exclusion in a) and 4.0 W/Kg exclusion in b) may be applied recursively with respect to the highest output power channel among the remaining channels; measure the SAR for the remaining channels that cannot be excluded.
 - ii) If an immediately adjacent channel measured in c) or a remaining channel measured in e) is >6.0 W/Kg, test all required channels for that antenna.

5.4. SAR Measurement Variability

SAR measurement variability must be assessed for each frequency band, which is determined by the SAR probe calibration point and tissue-equivalent medium used for the device measurements. When both head and body tissue-equivalent media are required for SAR measurements in a frequency band, the variability measurement procedures should be applied to the tissue medium with the highest measured SAR, using the highest measured SAR configuration for that tissue-equivalent medium. The following procedures are applied to determine if repeated measurements are required.

- 1) Repeated measurement is not required when the original highest measured SAR is < 0.80 W/kg; steps 2) through 4) do not apply.
- 2) When the original highest measured SAR is ≥ 0.80 W/kg, repeat that measurement once.

- 3) Perform a second repeated measurement only if the ratio of largest to smallest SAR for the original and first repeated measurements is > 1.20 or when the original or repeated measurement is ≥ 1.45 W/kg (~ 10% from the 1-g SAR limit).
- 4) Perform a third repeated measurement only if the original, first or second repeated measurement is ≥ 1.5 W/kg and the ratio of largest to smallest SAR for the original, first and second repeated measurements is > 1.20.

The same procedures should be adapted for measurements according to extremity and occupational exposure limits by applying a factor of 2.5 for extremity exposure and a factor of 5 for occupational exposure to the corresponding SAR thresholds.

Thus the following procedures are applied to determine if repeated measurements are required for occupational exposure.

- 5) Repeated measurement is not required when the original highest measured SAR is < 4.00 W/kg; steps 6) through 8) do not apply.
- 6) When the original highest measured SAR is ≥ 4.00 W/kg, repeat that measurement once.
- 7) Perform a second repeated measurement only if the ratio of largest to smallest SAR for the original and first repeated measurements is > 6.00 or when the original or repeated measurement is ≥ 7.25 W/kg (~ 10% from the 1-g SAR limit).
- 8) Perform a third repeated measurement only if the original, first or second repeated measurement is ≥ 7.5 W/kg and the ratio of largest to smallest SAR for the original, first and second repeated measurements is > 1.20.

5.5. Measurement Uncertainty (300-3GHz)

According to IEC62209-1/IEEE 1528:2013										
No.	Error Description	Type	Uncertainty Value	Probably Distribution	Div.	(Ci) 1g	(Ci) 10g	Std. Unc. (1g)	Std. Unc. (10g)	Degree of freedom
Measurement System										
1	Probe calibration	B	5.50%	N	1	1	1	5.50%	5.50%	∞
2	Axial isotropy	B	4.70%	R	$\sqrt{3}$	0.7	0.7	1.90%	1.90%	∞
3	Hemispherical isotropy	B	9.60%	R	$\sqrt{3}$	0.7	0.7	3.90%	3.90%	∞
4	Boundary Effects	B	1.00%	R	$\sqrt{3}$	1	1	0.60%	0.60%	∞
5	Probe Linearity	B	4.70%	R	$\sqrt{3}$	1	1	2.70%	2.70%	∞
6	Detection limit	B	1.00%	R	$\sqrt{3}$	1	1	0.60%	0.60%	∞
7	RF ambient conditions-noise	B	0.00%	R	$\sqrt{3}$	1	1	0.00%	0.00%	∞
8	RF ambient conditions-reflection	B	0.00%	R	$\sqrt{3}$	1	1	0.00%	0.00%	∞
9	Response time	B	0.80%	R	$\sqrt{3}$	1	1	0.50%	0.50%	∞
10	Integration time	B	5.00%	R	$\sqrt{3}$	1	1	2.90%	2.90%	∞
11	RF ambient	B	3.00%	R	$\sqrt{3}$	1	1	1.70%	1.70%	∞
12	Probe positioned mech. restrictions	B	0.40%	R	$\sqrt{3}$	1	1	0.20%	0.20%	∞
13	Probe positioning with respect to phantom shell	B	2.90%	R	$\sqrt{3}$	1	1	1.70%	1.70%	∞
14	Max.SAR evaluation	B	3.90%	R	$\sqrt{3}$	1	1	2.30%	2.30%	∞
Test Sample Related										

15	Test sample positioning	A	1.86%	N	1	1	1	1.86%	1.86%	∞
16	Device holder uncertainty	A	1.70%	N	1	1	1	1.70%	1.70%	∞
17	Drift of output power	B	5.00%	R	$\sqrt{3}$	1	1	2.90%	2.90%	∞
Phantom and Set-up										
18	Phantom uncertainty	B	4.00%	R	$\sqrt{3}$	1	1	2.30%	2.30%	∞
19	Liquid conductivity (target)	B	5.00%	R	$\sqrt{3}$	0.64	0.43	1.80%	1.20%	∞
20	Liquid conductivity (meas.)	A	0.50%	N	1	0.64	0.43	0.32%	0.26%	∞
21	Liquid permittivity (target)	B	5.00%	R	$\sqrt{3}$	0.64	0.43	1.80%	1.20%	∞
22	Liquid permittivity (meas.)	A	0.16%	N	1	0.64	0.43	0.10%	0.07%	∞
Combined standard uncertainty	$u_c = \sqrt{\sum_{i=1}^{22} c_i^2 u_i^2}$		/	/	/	/	/	10.20%	10.00%	∞
Expanded uncertainty (confidence interval of 95 %)	$u_e = 2u_c$		/	R	K=2	/	/	20.40%	20.00%	∞

According to IEC62209-2/2010

No.	Error Description	Type	Uncertainty Value	Probably Distribution	Div.	(Ci) 1g	(Ci) 10g	Std. Unc. (1g)	Std. Unc. (10g)	Degree of freedom
Measurement System										
1	Probe calibration	B	6.20%	N	1	1	1	6.20%	6.20%	∞
2	Axial isotropy	B	4.70%	R	$\sqrt{3}$	0.7	0.7	1.90%	1.90%	∞
3	Hemispherical isotropy	B	9.60%	R	$\sqrt{3}$	0.7	0.7	3.90%	3.90%	∞
4	Boundary Effects	B	2.00%	R	$\sqrt{3}$	1	1	1.20%	1.20%	∞
5	Probe Linearity	B	4.70%	R	$\sqrt{3}$	1	1	2.70%	2.70%	∞
6	Detection limit	B	1.00%	R	$\sqrt{3}$	1	1	0.60%	0.60%	∞
7	RF ambient conditions-noise	B	0.00%	R	$\sqrt{3}$	1	1	0.00%	0.00%	∞
8	RF ambient conditions-reflection	B	0.00%	R	$\sqrt{3}$	1	1	0.00%	0.00%	∞
9	Response time	B	0.80%	R	$\sqrt{3}$	1	1	0.50%	0.50%	∞
10	Integration time	B	5.00%	R	$\sqrt{3}$	1	1	2.90%	2.90%	∞
11	RF Ambient	B	3.00%	R	$\sqrt{3}$	1	1	1.70%	1.70%	∞
12	Probe positioned mech. restrictions	B	0.80%	R	$\sqrt{3}$	1	1	0.50%	0.50%	∞

13	Probe positioning with respect to phantom shell	B	6.70%	R	$\sqrt{3}$	1	1	3.90%	3.90%	∞
14	Max.SAR Evalation	B	3.90%	R	$\sqrt{3}$	1	1	2.30%	2.30%	∞
15	Modulation Response	B	2.40%	R	$\sqrt{3}$	1	1	1.40%	1.40%	∞
Test Sample Related										
16	Test sample positioning	A	1.86%	N	1	1	1	1.86%	1.86%	∞
17	Device holder uncertainty	A	1.70%	N	1	1	1	1.70%	1.70%	∞
18	Drift of output power	B	5.00%	R	$\sqrt{3}$	1	1	2.90%	2.90%	∞
Phantom and Set-up										
19	Phantom uncertainty	B	6.10%	R	$\sqrt{3}$	1	1	3.50%	3.50%	∞
20	SAR correction	B	1.90%	R	$\sqrt{3}$	1	0.84	1.11%	0.90%	∞
21	Liquid conductivity (target)	B	5.00%	R	$\sqrt{3}$	0.64	0.43	1.80%	1.20%	∞
22	Liquid conductivity (meas.)	A	0.50%	N	1	0.64	0.43	0.32%	0.26%	∞
23	Liquid permittivity (target)	B	5.00%	R	$\sqrt{3}$	0.64	0.43	1.80%	1.20%	∞
24	Liquid cpermittivity (meas.)	A	0.16%	N	1	0.64	0.43	0.10%	0.07%	∞
25	Temp.Unc.- Conductivity	B	3.40%	R	$\sqrt{3}$	0.78	0.71	1.50%	1.40%	∞
26	Temp.Unc.- Permittivity	B	0.40%	R	$\sqrt{3}$	0.23	0.26	0.10%	0.10%	∞
Combined standard uncertainty	$u_c = \sqrt{\sum_{i=1}^{22} c_i^2 u_i^2}$		/	/	/	/	/	12.90%	12.70%	∞
Expanded uncertainty (confidence interval of 95 %)	$u_e = 2u_c$		/	R	K=2	/	/	25.80%	25.40%	∞

Uncertainty of a System Performance Check with DASY5 System

According to IEC62209-2/2010

No.	Error Description	Type	Uncertainty Value	Probably Distribution	Div.	(Ci) 1g	(Ci) 10g	Std. Unc. (1g)	Std. Unc. (10g)	Degree of freedom
Measurement System										
1	Probe calibration	B	6.00%	N	1	1	1	6.00%	6.00%	∞
2	Axial isotropy	B	4.70%	R	$\sqrt{3}$	0.7	0.7	1.90%	1.90%	∞
3	Hemispherical isotropy	B	0.00%	R	$\sqrt{3}$	0.7	0.7	0.00%	0.00%	∞
4	Boundary Effects	B	1.00%	R	$\sqrt{3}$	1	1	0.60%	0.60%	∞
5	Probe Linearity	B	4.70%	R	$\sqrt{3}$	1	1	2.70%	2.70%	∞

6	Detection limit	B	1.00%	R	$\sqrt{3}$	1	1	0.60%	0.60%	∞
7	RF ambient conditions-noise	B	0.00%	R	$\sqrt{3}$	1	1	0.00%	0.00%	∞
8	RF ambient conditions-reflection	B	0.00%	R	$\sqrt{3}$	1	1	0.00%	0.00%	∞
9	Response time	B	0.80%	R	$\sqrt{3}$	1	1	0.50%	0.50%	∞
10	Integration time	B	5.00%	R	$\sqrt{3}$	1	1	2.90%	2.90%	∞
11	RF Ambient	B	3.00%	R	$\sqrt{3}$	1	1	1.70%	1.70%	∞
12	Probe positioned mech. restrictions	B	0.80%	R	$\sqrt{3}$	1	1	0.50%	0.50%	∞
13	Probe positioning with respect to phantom shell	B	6.70%	R	$\sqrt{3}$	1	1	3.90%	3.90%	∞
14	Max.SAR Evalation	B	3.90%	R	$\sqrt{3}$	1	1	2.30%	2.30%	∞
15	Modulation Response	B	2.40%	R	$\sqrt{3}$	1	1	1.40%	1.40%	∞
Test Sample Related										
16	Test sample positioning	A	0.00%	N	1	1	1	0.00%	0.00%	∞
17	Device holder uncertainty	A	2.00%	N	1	1	1	2.00%	2.00%	∞
18	Drift of output power	B	3.40%	R	$\sqrt{3}$	1	1	2.00%	2.00%	∞
Phantom and Set-up										
19	Phantom uncertainty	B	4.00%	R	$\sqrt{3}$	1	1	2.30%	2.30%	∞
20	SAR correction	B	1.90%	R	$\sqrt{3}$	1	0.84	1.11%	0.90%	∞
21	Liquid conductivity (meas.)	A	0.50%	N	1	0.64	0.43	0.32%	0.26%	∞
22	Liquid cpermittivity (meas.)	A	0.16%	N	1	0.64	0.43	0.10%	0.07%	∞
23	Temp.Unc.-Conductivity	B	1.70%	R	$\sqrt{3}$	0.78	0.71	0.80%	0.80%	∞
24	Temp.Unc.-Permittivity	B	0.40%	R	$\sqrt{3}$	0.23	0.26	0.10%	0.10%	∞
Combined standard uncertainty	$u_c = \sqrt{\sum_{i=1}^{22} c_i^2 u_i^2}$		/	/	/	/	/	12.90%	12.70%	∞
Expanded uncertainty (confidence interval of 95 %)	$u_e = 2u_c$		/	R	K=2	/	/	18.80%	18.40%	∞

5.6. System Check Results

System Performance Check at 450 MHz Head TSL

DUT: Dipole450 MHz; Type: D450V3; Serial: 1079

Date/Time: 01/14/2017

Communication System: DuiJiangJi; Frequency: 450 MHz; Duty Cycle: 1:1

Medium parameters used (interpolated): $f = 450$ MHz; $\sigma = 0.89$ S/m; $\epsilon_r = 44.1$; $\rho = 1000$ kg/m³

Phantom section: Flat Section

DASY5 Configuration:

Probe: ES3DV3 - SN3292; ConvF(7.12, 7.12, 7.12); Calibrated: 09/02/2016;

Sensor-Surface: 2mm (Mechanical Surface Detection)

Electronics: DAE4 Sn1315; Calibrated: 07/26/2016

Phantom: ELI 4.0; Type: QDOVA001BA;

Measurement SW: DASY52, Version 52.8 (2); SEMCAD X Version 14.6.6 (6824)

System Performance Check at 450MHz/Area Scan (61x201x1): Interpolated grid: $dx=1.500$ mm, $dy=1.50$ mm

Maximum value of SAR (interpolated) = 1.48 W/Kg

System Performance Check at 450MHz/Zoom Scan (7x7x7)/Cube 0: Measurement grid: $dx=5$ mm, $dy=5$ mm, $dz=5$ mm

Reference Value = 42.3 V/m; Power Drift = -0.10 dB

Peak SAR (extrapolated) = 1.74 W/Kg

SAR(1 g) = 1.18 W/Kg; SAR(10 g) = 0.786 W/Kg

Maximum value of SAR (measured) = 1.47 W/Kg

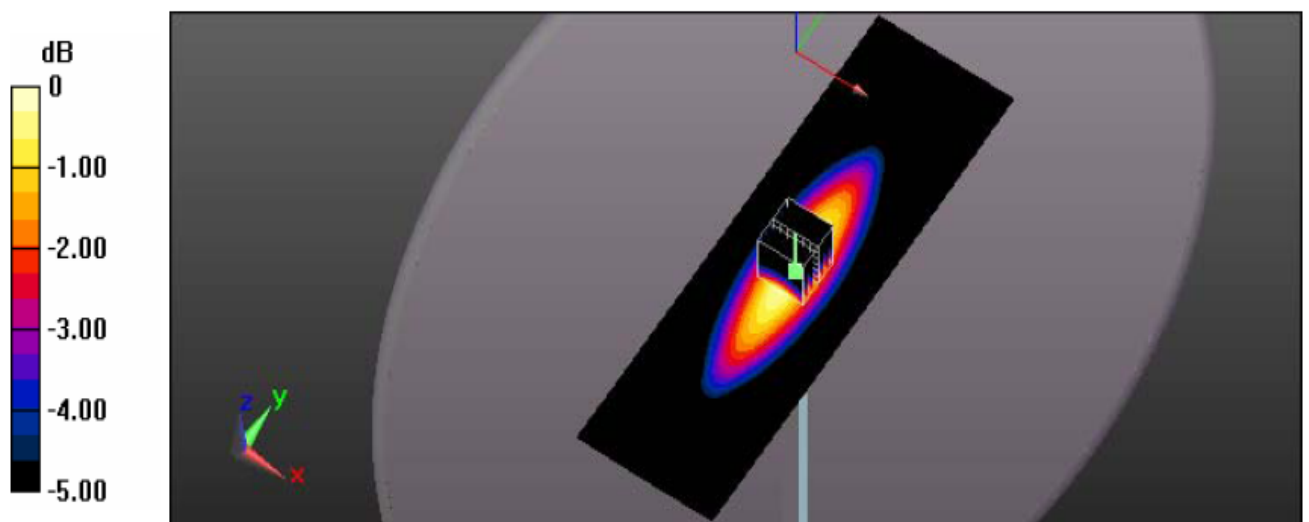

System Performance Check 450MHz Head 250mW

System Performance Check at 450 MHz Body TSL

DUT: Dipole450 MHz; Type: D450V3; Serial: 1079

Date/Time: 01/14/2017

Communication System: DuiJiangJi; Frequency: 450 MHz; Duty Cycle: 1:1

Medium parameters used (interpolated): $f = 450$ MHz; $\sigma = 0.96$ S/m; $\epsilon_r = 57.2$; $\rho = 1000$ kg/m³

Phantom section: Flat Section

DASY5 Configuration:

Probe: ES3DV3 - SN3292; ConvF(7.33, 7.33, 7.33); Calibrated: 09/02/2016;

Sensor-Surface: 2mm (Mechanical Surface Detection)

Electronics: DAE4 Sn1315; Calibrated: 07/26/2016

Phantom: ELI 4.0; Type: QDOVA001BA;

Measurement SW: DASY52, Version 52.8 (2); SEMCAD X Version 14.6.6 (6824)

System Performance Check at 450MHz/Area Scan (61x201x1): Interpolated grid: $dx=1.500$ mm, $dy=1.50$ mm

Maximum value of SAR (interpolated) = 1.44 W/Kg

System Performance Check at 450MHz/Zoom Scan (7x7x7)/Cube 0: Measurement grid: $dx=5$ mm, $dy=5$ mm, $dz=5$ mm

Reference Value = 39.2 V/m; Power Drift = -0.08 dB

Peak SAR (extrapolated) = 1.71 W/Kg

SAR(1 g) = 1.13 W/Kg; SAR(10 g) = 0.757 W/Kg

Maximum value of SAR (measured) = 1.41 W/Kg

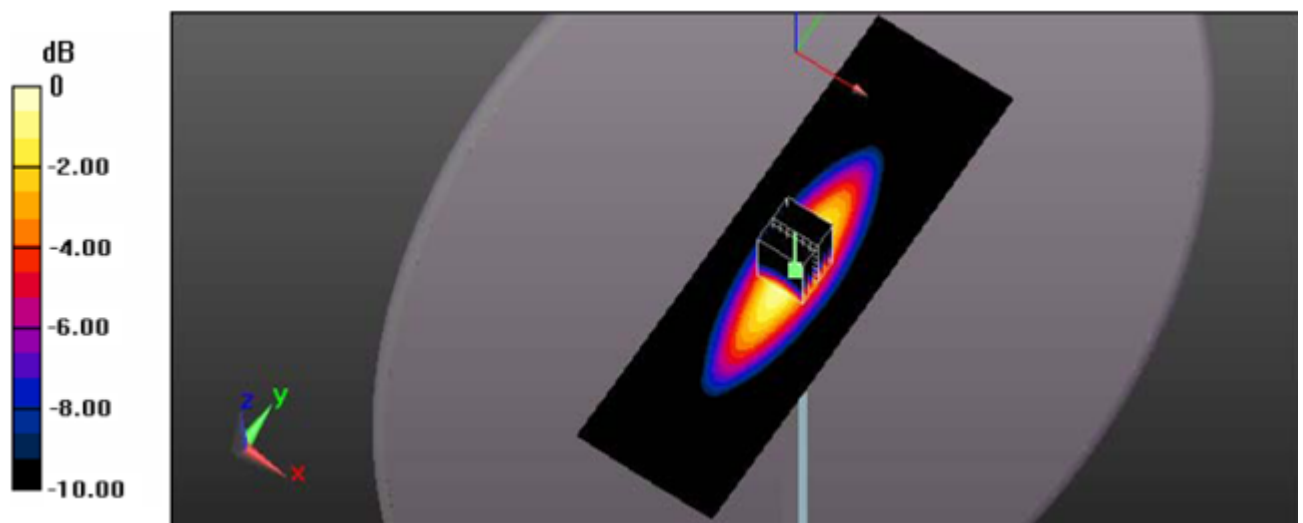

System Performance Check 450MHz Body 250mW

5.7. SAR Test Graph Results

Face Held for Digital Modulation at 12.5KHz Channel Separation, Front towards Phantom 406.15MHz

Communication System: PTT 450; Frequency: 406.15 MHz; Duty Cycle: 1:1

Medium parameters used (interpolated): $f = 406.15$ MHz; $\sigma = 0.88$ S/m; $\epsilon_r = 44.40$; $\rho = 1000$ kg/m³

Phantom section: Flat Section

Probe: ES3DV3 - SN3292; ConvF(7.12, 7.12, 7.12); Calibrated: 09/02/2016;

Sensor-Surface: 2mm (Mechanical Surface Detection)

Electronics: DAE4 Sn1315; Calibrated: 07/26/2016

Phantom: ELI 4.0; Type: QDOVA001BA;

Measurement SW: DASY52, Version 52.8 (2); SEMCAD X Version 14.6.6 (6824)

Area Scan (51x141x1): Interpolated grid: dx=1.500 mm, dy=1.500 mm

Maximum value of SAR (interpolated) = 2.51 W/kg

Zoom Scan (7x7x7)/Cube 0: Measurement grid: dx=5mm, dy=5mm, dz=5mm

Reference Value = 56.262 V/m; Power Drift = -0.14 dB

Peak SAR (extrapolated) = 2.925 mW/g

SAR(1 g) = 2.34 mW/g; SAR(10 g) = 1.79 mW/g

Maximum value of SAR (measured) = 2.45 W/kg

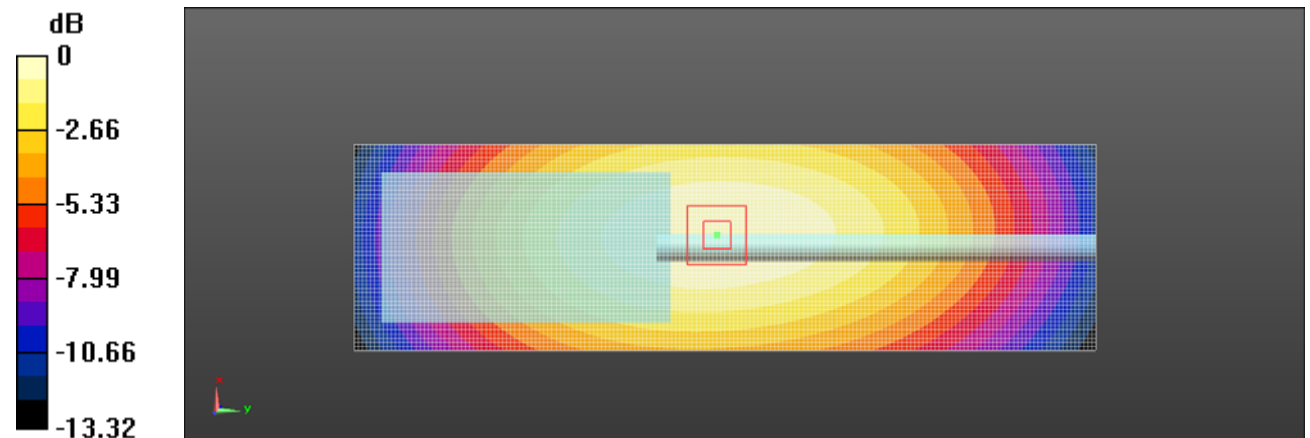

Date/Time: 01/14/2017

Figure 1: Face held for Digital Modulation at 12.5KHz Channel Separation Front towards Phantom 406.15 MHz

Body- Worn Digital Modulation at 12.5KHz Channel Separation With A1, B1,BC1,S1 and C1, Front towards Ground 406.15MHz

Communication System: PTT450; Frequency: 406.15 MHz;Duty Cycle:1:1

Medium parameters used (interpolated): $f = 406.15$ MHz; $\sigma = 0.95$ S/m; $\epsilon_r = 58.7$; $\rho = 1000$ kg/m³

Phantom section : Flat Section

Probe: ES3DV3 - SN3292;ConvF(7.33, 7.33, 7.33); Calibrated: 09/02/2016;

Sensor-Surface: 2mm (Mechanical Surface Detection)

Electronics: DAE4 Sn1315; Calibrated: 07/26/2016

Phantom: ELI 4.0; Type: QDOVA001BA;

Measurement SW: DASY52, Version 52.8 (2); SEMCAD X Version 14.6.6 (6824)

Area Scan(41x151x1): Interpolated grid: dx=1.500 mm, dy=1.500 mm

Maximum value of SAR (interpolated) = 10.4 W/kg

Zoom Scan (7x7x7)/Cube 0: Measurement grid: dx=5mm, dy=5mm, dz=5mm

Reference Value = 93.125 V/m; Power Drift = -0.12 dB

Peak SAR (extrapolated) = 12.164 mW/g

SAR(1 g) = 7.26 mW/g; SAR(10 g) = 5.37 mW/g

Maximum value of SAR (measured) = 9.82 W/kg

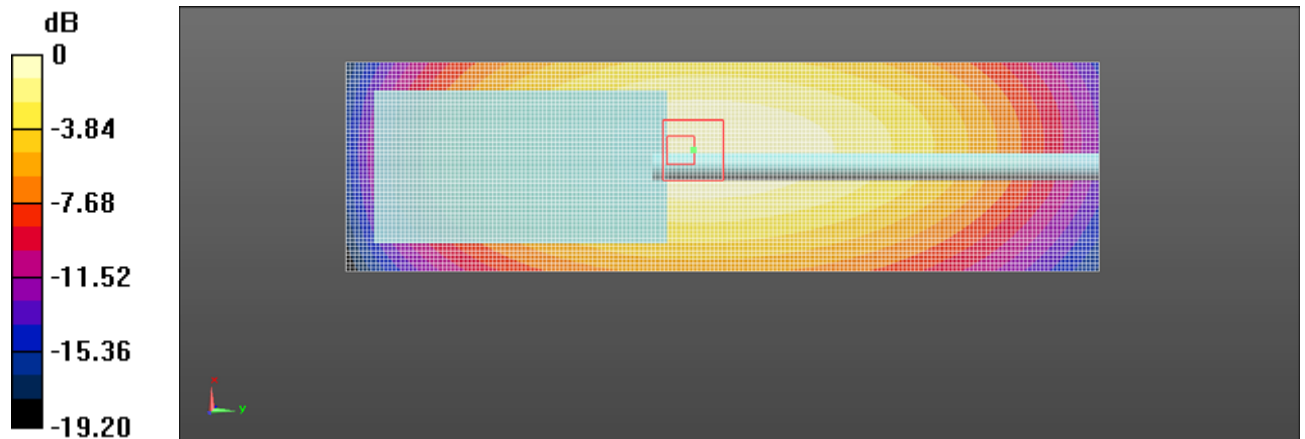

Date/Time: 01/14/2017

Plot 2: Body-worn for Digital Modulation at 12.5KHz Channel Separation With A1, B1,BC1,S1and C1; Front towards Ground 406.15 MHz

Body- Worn Digital Modulation at 12.5KHz Channel Separation With A1, B1,BC1,S1 and C1, Front towards Ground 422.50MHz

Communication System: PTT450; Frequency: 422.50 MHz;Duty Cycle:1:1

Medium parameters used (interpolated): $f = 422.50$ MHz; $\sigma = 0.96$ S/m; $\epsilon_r = 58.30$; $\rho = 1000$ kg/m³

Phantom section : Flat Section

Probe: ES3DV3 - SN3292;ConvF(7.33, 7.33, 7.33); Calibrated: 09/02/2016;

Sensor-Surface: 2mm (Mechanical Surface Detection)

Electronics: DAE4 Sn1315; Calibrated: 07/26/2016

Phantom: ELI 4.0; Type: QDOVA001BA;

Measurement SW: DASY52, Version 52.8 (2); SEMCAD X Version 14.6.6 (6824)

Area Scan (51x141x1): Interpolated grid: dx=1.500 mm, dy=1.500 mm

Maximum value of SAR (interpolated) = 7.95 W/kg

Zoom Scan (7x7x7)/Cube 0: Measurement grid: dx=5mm, dy=5mm, dz=5mm

Reference Value = 84.756 V/m; Power Drift = -0.13 dB

Peak SAR (extrapolated) = 11.785 mW/g

SAR(1 g) = 6.38 mW/g; SAR(10 g) = 4.72 mW/g

Maximum value of SAR (measured) =7.65 W/kg

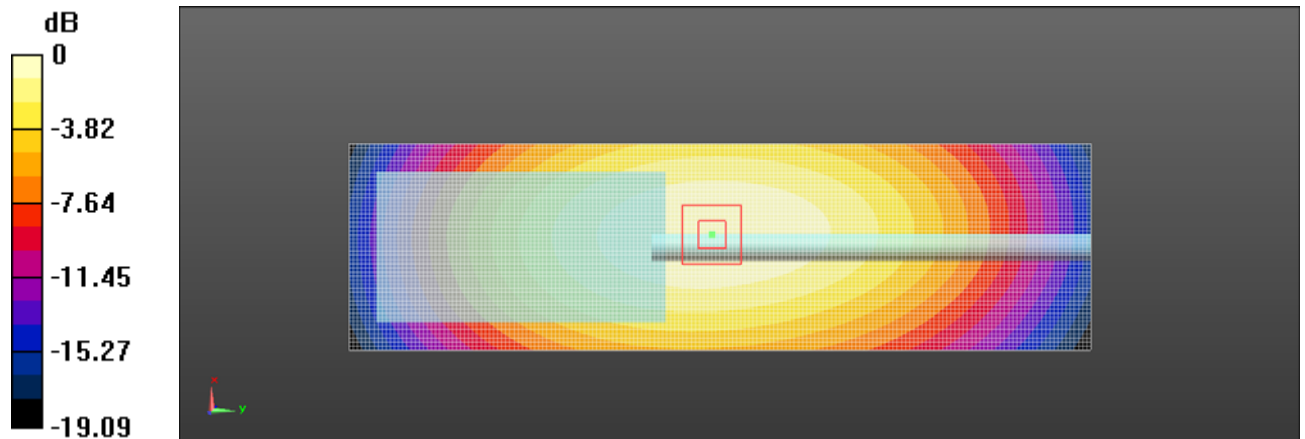

Date/Time: 01/14/2017

Plot 3: Body-worn for Digital Modulation at 12.5KHz Channel Separation With A1, B1,BC1,S1and C1; Front towards Ground 422.50 MHz

Body- Worn Digital Modulation at 12.5KHz Channel Separation With A1, B1,BC1,S1 and C1, Front towards Ground 435.00 MHz

Communication System: PTT450; Frequency: 435.00 MHz;Duty Cycle:1:1

Medium parameters used (interpolated): $f = 435.00$ MHz; $\sigma = 0.96$ S/m; $\epsilon_r = 58.0$; $\rho = 1000$ kg/m³

Phantom section : Flat Section

Probe: ES3DV3 - SN3292;ConvF(7.33, 7.33, 7.33); Calibrated: 09/02/2016;

Sensor-Surface: 2mm (Mechanical Surface Detection)

Electronics: DAE4 Sn1315; Calibrated: 07/26/2016

Phantom: ELI 4.0; Type: QDOVA001BA;

Measurement SW: DASY52, Version 52.8 (2); SEMCAD X Version 14.6.6 (6824)

Area Scan(41x151x1): Interpolated grid: dx=1.500 mm, dy=1.500 mm

Maximum value of SAR (interpolated) = 7.35 W/kg

Zoom Scan (5x5x6)/Cube 0: Measurement grid: dx=7mm, dy=7mm, dz=5mm

Reference Value = 89.514 V/m; Power Drift = -0.02 dB

Peak SAR (extrapolated) = 11.645 mW/g

SAR(1 g) = 6.62 mW/g; SAR(10 g) = 4.87 mW/g

Maximum value of SAR (measured) = 7.34 W/kg

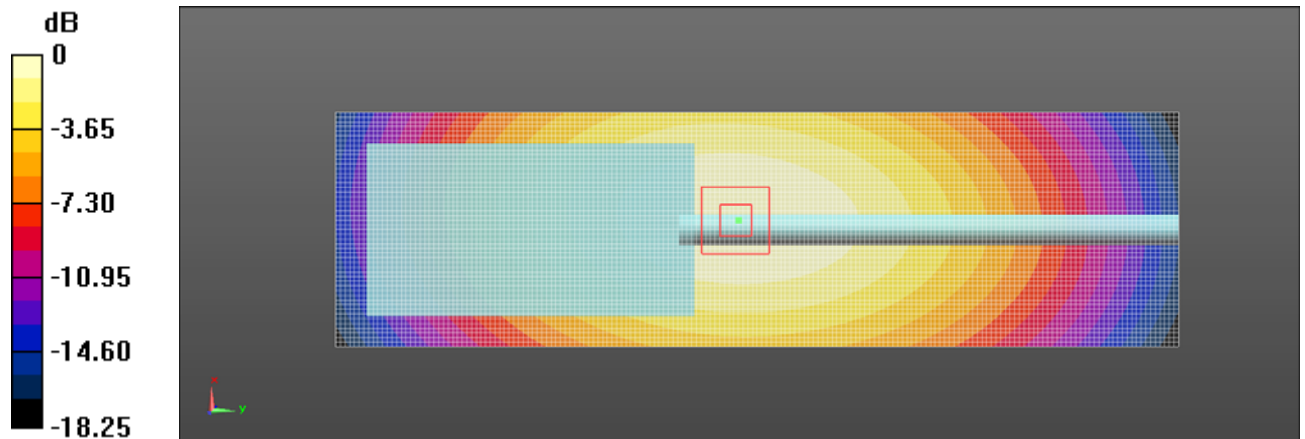

Date/Time: 01/14/2017

Plot 4: Body-worn for Digital Modulation at 12.5KHz Channel Separation With A1, B1,BC1,S1and C1; Front towards Ground 435.00 MHz

Body- Worn Digital Modulation at 12.5KHz Channel Separation With A1, B1,BC1,S1 and C1, Front towards Ground 450.50MHz

Communication System: PTT450; Frequency: 450.50 MHz;Duty Cycle:1:1

Medium parameters used (interpolated): $f = 450.50\text{MHz}$; $\sigma = 0.97\text{ S/m}$; $\epsilon_r = 57.4$; $\rho = 1000\text{ kg/m}^3$

Phantom section : Flat Section

Probe: ES3DV3 - SN3292;ConvF(7.33, 7.33, 7.33); Calibrated: 09/02/2016;

Sensor-Surface: 2mm (Mechanical Surface Detection)

Electronics: DAE4 Sn1315; Calibrated: 07/26/2016

Phantom: ELI 4.0; Type: QDOVA001BA;

Measurement SW: DASY52, Version 52.8 (2); SEMCAD X Version 14.6.6 (6824)

Towards Ground /Area Scan (51x161x1): Interpolated grid: $dx=1.50\text{ mm}$, $dy=1.50\text{ mm}$

Maximum value of SAR (interpolated) =7.74 W/Kg

Towards Ground /Zoom Scan (7x7x7)/Cube 0: Measurement grid: $dx=5\text{mm}$, $dy=5\text{mm}$, $dz=5\text{mm}$

Reference Value = 83.927 V/m; Power Drift = -0.13 dB

Peak SAR (extrapolated) = 9.071 mW/g

SAR(1 g) = 6.24 mW/g; SAR(10 g) = 4.59 mW/g

Maximum value of SAR (measured) = 7.69 W/kg

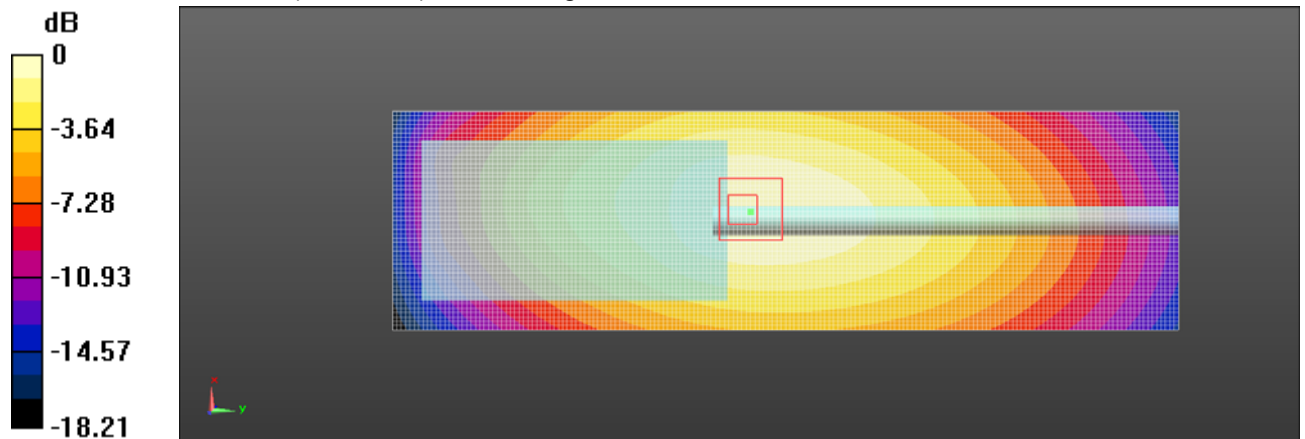

Date/Time: 01/14/2017

Plot 5: Body-worn for Digital Modulation at 12.5KHz Channel Separation With A1, B1,BC1,S1and C1; Front towards Ground 450.50 MHz

Body- Worn Digital Modulation at 12.5KHz Channel Separation With A1, B1,BC1,S1 and C1, Front towards Ground459.50MHz

Communication System: PTT450; Frequency: 459.50 MHz;Duty Cycle:1:1

Medium parameters used (interpolated): $f = 459.50$ MHz; $\sigma = 0.98$ S/m; $\epsilon_r = 56.89$; $\rho = 1000$ kg/m³

Phantom section : Flat Section

Probe: ES3DV3 - SN3292;ConvF(7.33, 7.33, 7.33); Calibrated: 09/02/2016;

Sensor-Surface: 2mm (Mechanical Surface Detection)

Electronics: DAE4 Sn1315; Calibrated: 07/26/2016

Phantom: ELI 4.0; Type: QDOVA001BA;

Measurement SW: DASY52, Version 52.8 (2); SEMCAD X Version 14.6.6 (6824)

Towards Ground /Area Scan (51x161x1): Interpolated grid: dx=1.50 mm, dy=1.50 mm

Maximum value of SAR (interpolated) = 7.75 W/Kg

Towards Ground /Zoom Scan (7x7x7)/Cube 0: Measurement grid: dx=5mm, dy=5mm, dz=5mm

Reference Value = 83.363 V/m; Power Drift = -0.16 dB

Peak SAR (extrapolated) = 11.706 mW/g

SAR(1 g) = 6.36 mW/g; SAR(10 g) = 4.71 mW/g

Maximum value of SAR (measured) = 7.69 W/kg

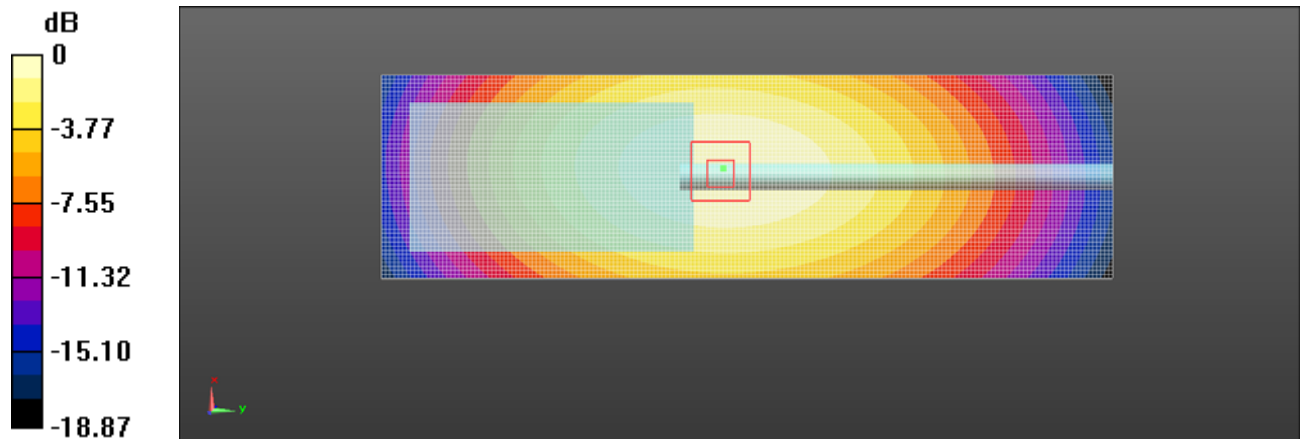

Date/Time: 01/14/2017

Plot 6: Body-worn for Digital Modulation at 12.5KHz Channel Separation With A1, B1,BC1,S1and C1; Front towards Ground 459.50 MHz

Body- Worn Digital Modulation at 12.5KHz Channel Separation With A1, B1,BC1,S1 and C1, Front towards Ground469.95MHz

Communication System: PTT450; Frequency: 469.95 MHz;Duty Cycle:1:1

Medium parameters used (interpolated): $f = 469.95$ MHz; $\sigma = 0.98$ S/m; $\epsilon_r = 56.92$; $\rho = 1000$ kg/m³

Phantom section : Flat Section

Probe: ES3DV3 - SN3292;ConvF(7.33, 7.33, 7.33); Calibrated: 09/02/2016;

Sensor-Surface: 2mm (Mechanical Surface Detection)

Electronics: DAE4 Sn1315; Calibrated: 07/26/2016

Phantom: ELI 4.0; Type: QDOVA001BA;

Measurement SW: DASY52, Version 52.8 (2); SEMCAD X Version 14.6.6 (6824)

Towards Ground /Area Scan (51x161x1): Interpolated grid: dx=1.50 mm, dy=1.50 mm

Maximum value of SAR (interpolated) = 8.68 W/Kg

Towards Ground /Zoom Scan (7x7x7)/Cube 0: Measurement grid: dx=5mm, dy=5mm, dz=5mm

Reference Value = 94.573 V/m; Power Drift = -0.16 dB

Peak SAR (extrapolated) = 11.326 mW/g

SAR(1 g) = 6.45 mW/g; SAR(10 g) =4.68 mW/g

Maximum value of SAR (measured) = 8.25 W/kg

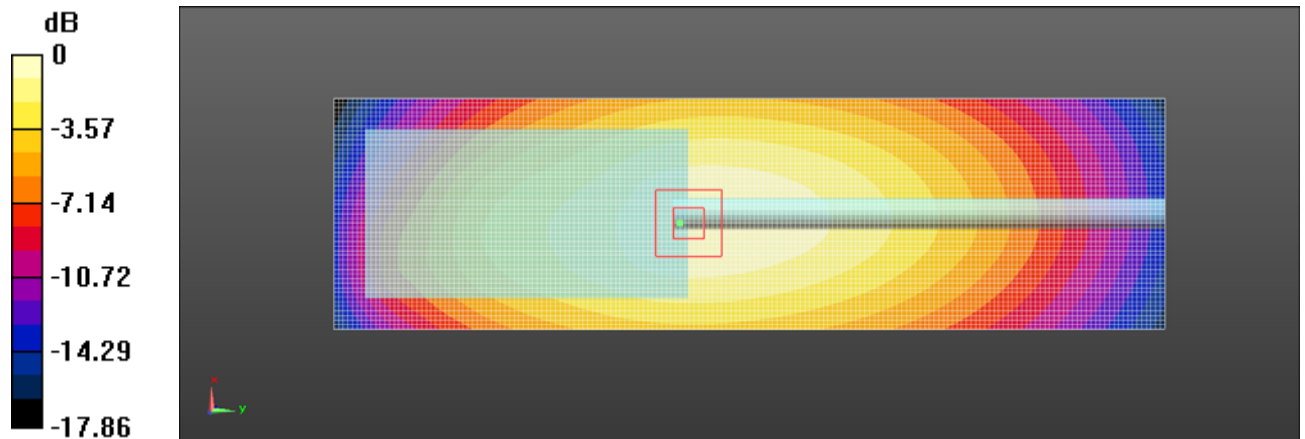

Date/Time: 01/14/2017

Plot 7: Body-worn for Digital Modulation at 12.5KHz Channel Separation With A1, B1,BC1,S1and C1; Front towards Ground 469.95 MHz

6. Calibration Certificate

6.1. Probe Calibration Certificate

**Calibration Laboratory of
Schmid & Partner
Engineering AG**
Zeughausstrasse 43, 8004 Zurich, Switzerland



S Schweizerischer Kalibrierdienst
C Service suisse d'étalonnage
S Servizio svizzero di taratura
S Swiss Calibration Service

Accredited by the Swiss Accreditation Service (SAS)
The Swiss Accreditation Service is one of the signatories to the EA
Multilateral Agreement for the recognition of calibration certificates

Accreditation No.: **SCS 0108**

Client **CIQ-SZ (Audon)**

Certificate No: **ES3-3292_Sep16**

CALIBRATION CERTIFICATE

Object: **ES3DV3 - SN:3292**

Calibration procedure(s): **QA CAL-01.v9, QA CAL-12.v9, QA CAL-23.v5, QA CAL-25.v6**
Calibration procedure for dosimetric E-field probes

Calibration date: **September 2, 2016**

This calibration certificate documents the traceability to national standards, which realize the physical units of measurements (SI).
The measurements and the uncertainties with confidence probability are given on the following pages and are part of the certificate.

All calibrations have been conducted in the closed laboratory facility: environment temperature (22 ± 3)°C and humidity < 70%.

Calibration Equipment used (MATE critical for calibration)

Primary Standards	ID	Cal Date (Certificate No.)	Scheduled Calibration
Power meter NRP	SN: 104778	06-Apr-16 (No. 217-02288/02289)	Apr-17
Power sensor NRP-291	SN: 103244	06-Apr-16 (No. 217-02288)	Apr-17
Power sensor NRP-291	SN: 103245	06-Apr-16 (No. 217-02289)	Apr-17
Reference 20 dB Attenuator	SN: S5277 (20x)	05-Apr-16 (No. 217-02293)	Apr-17
Reference Probe ES3DV2	SN: 3013	31-Dec-15 (No. ES3-3013_Dec15)	Dec-16
DAE4	SN: 660	23-Dec-15 (No. DAE4-660_Dec15)	Dec-16
Secondary Standards	ID	Check Date (in house)	Scheduled Check
Power meter E4419B	SN: GB41293874	06-Apr-16 (in house check Jun-16)	In house check: Jun-18
Power sensor E4412A	SN: MY41459087	06-Apr-16 (in house check Jun-16)	In house check: Jun-18
Power sensor E4412A	SN: 000110210	06-Apr-16 (in house check Jun-16)	In house check: Jun-18
RF generator HP 8648C	SN: US3642U01700	04-Aug-99 (in house check Jun-16)	In house check: Jun-18
Network Analyzer HP 8753E	SN: US37390585	18-Oct-01 (in house check Oct-15)	In house check: Oct-16

	Name	Function	Signature
Calibrated by:	Michael Weber	Laboratory Technician	
Approved by:	Katja Pokovic	Technical Manager	

Issued: September 2, 2016

This calibration certificate shall not be reproduced except in full without written approval of the laboratory.

**Calibration Laboratory of
Schmid & Partner
Engineering AG**
Zeughausstrasse 43, 8004 Zurich, Switzerland



S Schweizerischer Kalibrierdienst
C Service suisse d'étalonnage
S Servizio svizzero di taratura
S Swiss Calibration Service

Accredited by the Swiss Accreditation Service (SAS)

Accreditation No.: SCS 0108

The Swiss Accreditation Service is one of the signatories to the EA Multilateral Agreement for the recognition of calibration certificates

Glossary:

TSL	tissue simulating liquid
NORM _{x,y,z}	sensitivity in free space
ConvF	sensitivity in TSL / NORM _{x,y,z}
DCP	diode compression point
CF	crest factor (1/duty_cycle) of the RF signal
A, B, C, D	modulation dependent linearization parameters
Polarization ϕ	ϕ rotation around probe axis
Polarization θ	θ rotation around an axis that is in the plane normal to probe axis (at measurement center), i.e., $\theta = 0$ is normal to probe axis
Connector Angle	information used in DASY system to align probe sensor X to the robot coordinate system

Calibration is Performed According to the Following Standards:

- IEEE Std 1528-2013, "IEEE Recommended Practice for Determining the Peak Spatial-Averaged Specific Absorption Rate (SAR) in the Human Head from Wireless Communications Devices: Measurement Techniques", June 2013
- IEC 62209-1, "Procedure to measure the Specific Absorption Rate (SAR) for hand-held devices used in close proximity to the ear (frequency range of 300 MHz to 3 GHz)", February 2005
- IEC 62209-2, "Procedure to determine the Specific Absorption Rate (SAR) for wireless communication devices used in close proximity to the human body (frequency range of 30 MHz to 6 GHz)", March 2010
- KDB 865664, "SAR Measurement Requirements for 100 MHz to 6 GHz"

Methods Applied and Interpretation of Parameters:

- NORM_{x,y,z}**: Assessed for E-field polarization $\theta = 0$ ($f \leq 900$ MHz in TEM-cell; $f > 1800$ MHz: R22 waveguide). NORM_{x,y,z} are only intermediate values, i.e., the uncertainties of NORM_{x,y,z} does not affect the E²-field uncertainty inside TSL (see below ConvF).
- NORM(f)_{x,y,z} = NORM_{x,y,z} * frequency_response** (see Frequency Response Chart). This linearization is implemented in DASY4 software versions later than 4.2. The uncertainty of the frequency response is included in the stated uncertainty of ConvF.
- DCP_{x,y,z}**: DCP are numerical linearization parameters assessed based on the data of power sweep with CW signal (no uncertainty required). DCP does not depend on frequency nor media.
- PAR**: PAR is the Peak to Average Ratio that is not calibrated but determined based on the signal characteristics
- A_{x,y,z}; B_{x,y,z}; C_{x,y,z}; D_{x,y,z}; VR_{x,y,z}; A, B, C, D** are numerical linearization parameters assessed based on the data of power sweep for specific modulation signal. The parameters do not depend on frequency nor media. VR is the maximum calibration range expressed in RMS voltage across the diode.
- ConvF and Boundary Effect Parameters**: Assessed in flat phantom using E-field (or Temperature Transfer Standard for $f \leq 800$ MHz) and inside waveguide using analytical field distributions based on power measurements for $f > 800$ MHz. The same setups are used for assessment of the parameters applied for boundary compensation (alpha, depth) of which typical uncertainty values are given. These parameters are used in DASY4 software to improve probe accuracy close to the boundary. The sensitivity in TSL corresponds to NORM_{x,y,z} * ConvF whereby the uncertainty corresponds to that given for ConvF. A frequency dependent ConvF is used in DASY version 4.4 and higher which allows extending the validity from ± 50 MHz to ± 100 MHz.
- Spherical isotropy (3D deviation from isotropy)**: In a field of low gradients realized using a flat phantom exposed by a patch antenna.
- Sensor Offset**: The sensor offset corresponds to the offset of virtual measurement center from the probe tip (on probe axis). No tolerance required.
- Connector Angle**: The angle is assessed using the information gained by determining the NORM_x (no uncertainty required).

ES3DV3 – SN:3292

September 2, 2016

Probe ES3DV3

SN:3292

Manufactured:	July 6, 2010
Repaired:	August 29, 2016
Calibrated:	September 2, 2016

Calibrated for DASY/EASY Systems
(Note: non-compatible with DASY2 system!)

ES3DV3- SN:3292

September 2, 2016

DASY/EASY - Parameters of Probe: ES3DV3 - SN:3292**Basic Calibration Parameters**

	Sensor X	Sensor Y	Sensor Z	Unc (k=2)
Norm ($\mu\text{V}/(\text{V}/\text{m})^2$) ^A	0.94	0.95	0.93	$\pm 10.1\%$
DCP (mV) ^B	105.7	101.2	111.7	

Modulation Calibration Parameters

UID	Communication System Name		A dB	B dB/ μV	C	D dB	VR mV	Unc ^C (k=2)
0	CW	X	0.0	0.0	1.0	0.00	205.6	$\pm 3.5\%$
		Y	0.0	0.0	1.0		212.6	
		Z	0.0	0.0	1.0		204.7	

The reported uncertainty of measurement is stated as the standard uncertainty of measurement multiplied by the coverage factor $k=2$, which for a normal distribution corresponds to a coverage probability of approximately 95%.

^A The uncertainties of Norm X,Y,Z do not affect the E^2 -field uncertainty inside TSL (see Pages 5 and 6).

^B Numerical linearization parameter: uncertainty not required.

^C Uncertainty is determined using the max. deviation from linear response applying rectangular distribution and is expressed for the square of the field value.

ES3DV3- SN:3292

September 2, 2016

DASY/EASY - Parameters of Probe: ES3DV3 - SN:3292

Calibration Parameter Determined in Head Tissue Simulating Media

f (MHz) ^c	Relative Permittivity ^f	Conductivity (S/m) ^f	ConvF X	ConvF Y	ConvF Z	Alpha ^g	Depth ^h (mm)	Unc (k=2)
450	43.5	0.87	7.12	7.12	7.12	0.20	1.30	± 13.3 %
750	41.9	0.89	6.76	6.76	6.76	0.80	1.19	± 12.0 %
835	41.5	0.90	6.53	6.53	6.53	0.43	1.64	± 12.0 %
900	41.5	0.97	6.40	6.40	6.40	0.53	1.43	± 12.0 %
1750	40.1	1.37	5.54	5.54	5.54	0.80	1.15	± 12.0 %
1900	40.0	1.40	5.26	5.26	5.26	0.55	1.47	± 12.0 %
2450	39.2	1.80	4.97	4.97	4.97	0.64	1.41	± 12.0 %
2600	39.0	1.96	4.77	4.77	4.77	0.80	1.28	± 12.0 %

^c Frequency validity above 300 MHz of ± 100 MHz only applies for DASY v4.4 and higher (see Page 2), else it is restricted to ± 50 MHz. The uncertainty is the RSS of the ConvF uncertainty at calibration frequency and the uncertainty for the indicated frequency band. Frequency validity below 300 MHz is ± 10, 25, 40, 50 and 70 MHz for ConvF assessments at 30, 64, 128, 160 and 220 MHz respectively. Above 5 GHz frequency validity can be extended to ± 110 MHz.

^f At frequencies below 3 GHz, the validity of tissue parameters (ϵ and σ) can be relaxed to ± 10% if liquid compensation formula is applied to measured SAR values. At frequencies above 3 GHz, the validity of tissue parameters (ϵ and σ) is restricted to ± 5%. The uncertainty is the RSS of the ConvF uncertainty for indicated target tissue parameters.

^g Alpha/Depth are determined during calibration. SPEAG warrants that the remaining deviation due to the boundary effect after compensation is always less than ± 1% for frequencies below 3 GHz and below ± 2% for frequencies between 3-8 GHz at any distance larger than half the probe tip diameter from the boundary.

DASY/EASY - Parameters of Probe: ES3DV3 - SN:3292

Calibration Parameter Determined in Body Tissue Simulating Media

f (MHz) ^c	Relative Permittivity ^f	Conductivity (S/m) ^f	ConvF X	ConvF Y	ConvF Z	Alpha ^g	Depth ^g (mm)	Unc (k=2)
450	56.7	0.94	7.33	7.33	7.33	0.13	1.50	± 13.3 %
750	55.5	0.96	6.25	6.25	6.25	0.36	1.66	± 12.0 %
835	55.2	0.97	6.27	6.27	6.27	0.47	1.56	± 12.0 %
900	55.0	1.05	6.16	6.16	6.16	0.80	1.15	± 12.0 %
1750	53.4	1.49	5.28	5.28	5.28	0.70	1.36	± 12.0 %
1900	53.3	1.52	5.05	5.05	5.05	0.64	1.44	± 12.0 %
2450	52.7	1.95	4.70	4.70	4.70	0.74	1.22	± 12.0 %
2600	52.5	2.16	4.52	4.52	4.52	0.80	1.13	± 12.0 %

^c Frequency validity above 300 MHz of ± 100 MHz only applies for DASY v4.4 and higher (see Page 2), else it is restricted to ± 50 MHz. The uncertainty is the RSS of the ConvF uncertainty at calibration frequency and the uncertainty for the indicated frequency band. Frequency validity below 300 MHz is ± 10, 25, 40, 50 and 70 MHz for ConvF assessments at 30, 64, 128, 150 and 220 MHz respectively. Above 5 GHz frequency validity can be extended to ± 110 MHz.

^f At frequencies below 3 GHz, the validity of tissue parameters (ϵ and σ) can be relaxed to ± 10% if liquid compensation formula is applied to measured SAR values. At frequencies above 3 GHz, the validity of tissue parameters (ϵ and σ) is restricted to ± 5%. The uncertainty is the RSS of the ConvF uncertainty for indicated target tissue parameters.

^g Alpha/Depth are determined during calibration. SPEAG warrants that the remaining deviation due to the boundary effect after compensation is always less than ± 1% for frequencies below 3 GHz and below ± 2% for frequencies between 3-6 GHz at any distance larger than half the probe tip diameter from the boundary.

Frequency Response of E-Field (TEM-Cell: ifi110 EXX, Waveguide: R22)

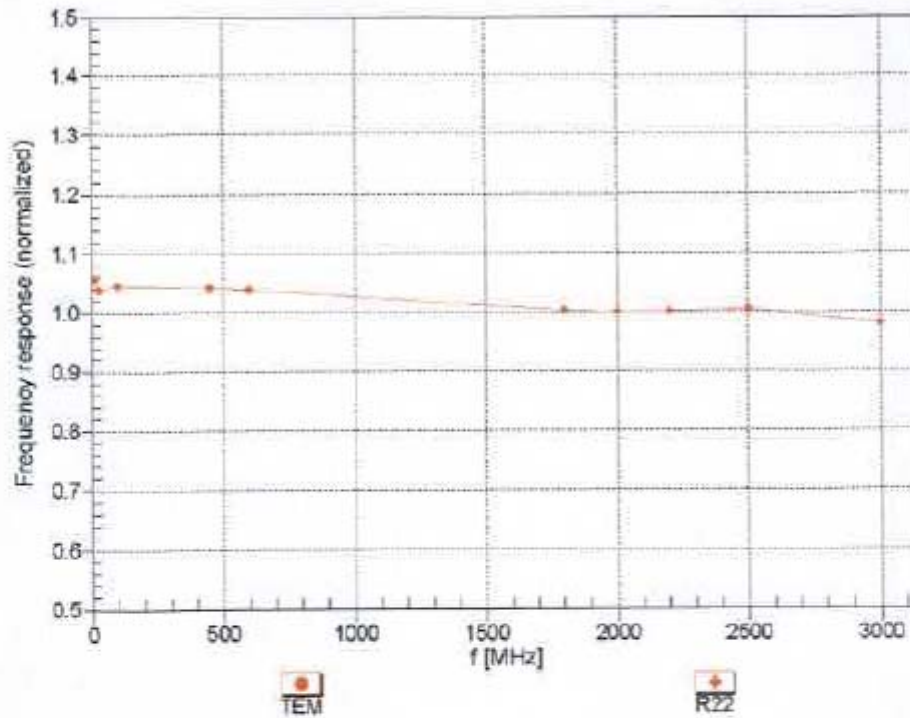

Uncertainty of Frequency Response of E-field: $\pm 6.3\%$ ($k=2$)

Receiving Pattern (ϕ), $\theta = 0^\circ$

f=600 MHz,TEM

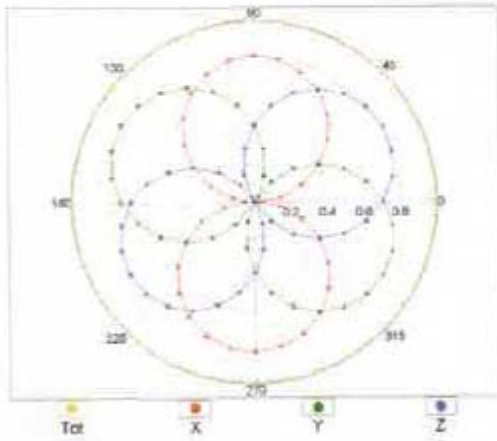

f=1800 MHz,R22

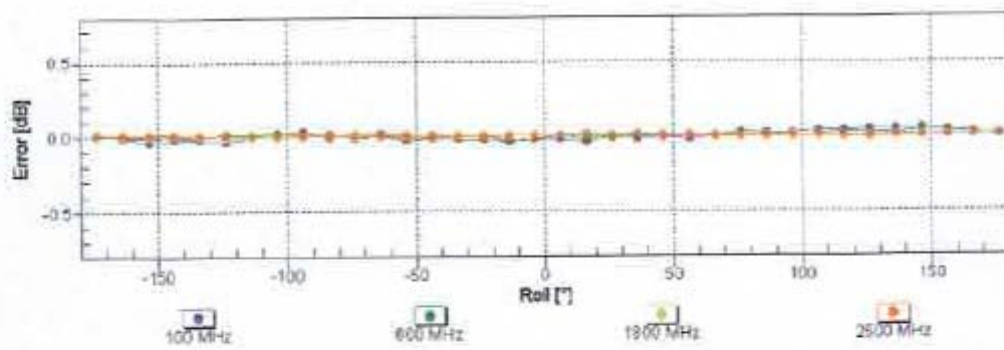
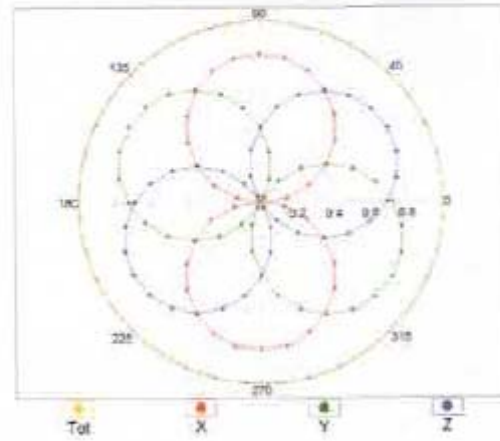

Uncertainty of Axial Isotropy Assessment: $\pm 0.5\%$ ($k=2$)

Dynamic Range f(SAR_{head}) (TEM cell , f_{eval}= 1900 MHz)

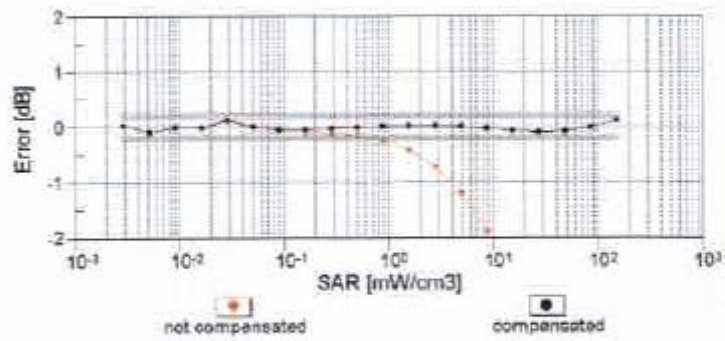
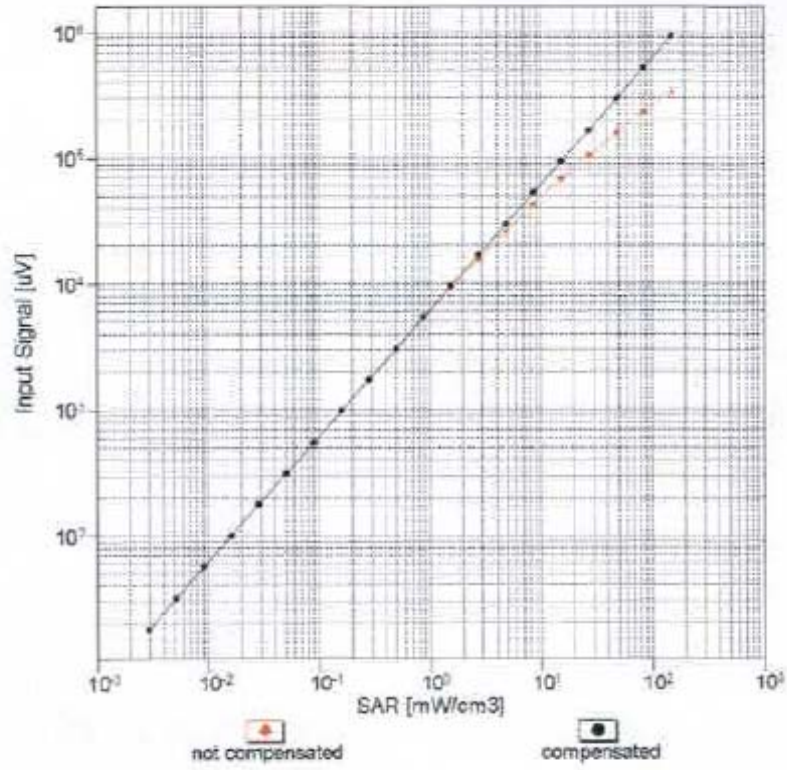

Uncertainty of Linearity Assessment: ± 0.6% (k=2)

ES3DV3- SN:3292

September 2, 2016

Conversion Factor Assessment

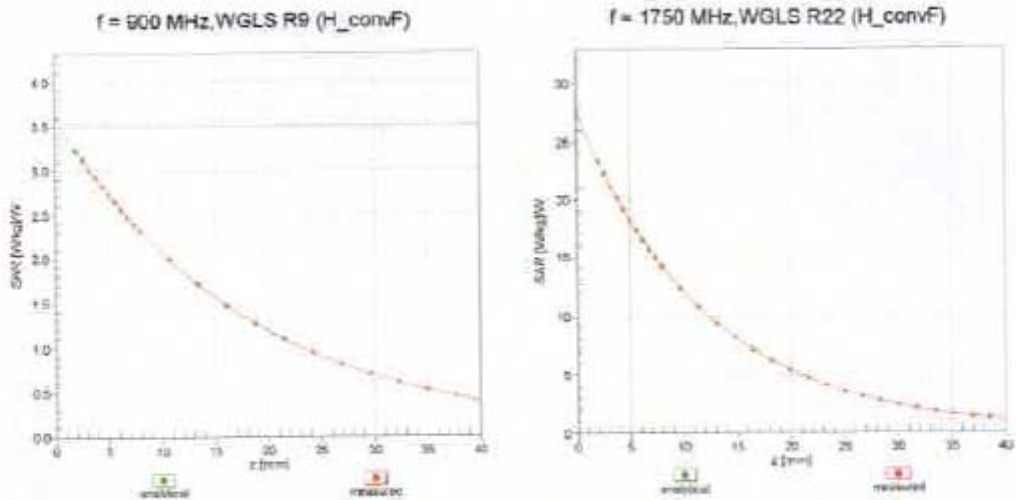

Deviation from Isotropy in Liquid

Error (ϕ, θ), f = 900 MHz

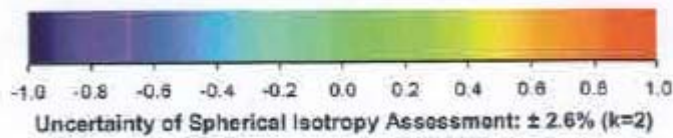
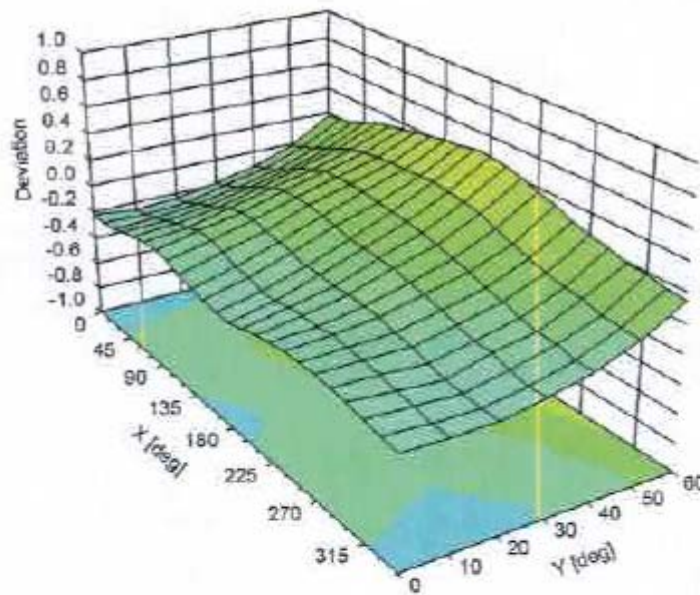

ES3DV3- SN:3292

September 2, 2016

DASY/EASY - Parameters of Probe: ES3DV3 - SN:3292**Other Probe Parameters**

Sensor Arrangement	Triangular
Connector Angle (°)	36.3
Mechanical Surface Detection Mode	enabled
Optical Surface Detection Mode	disabled
Probe Overall Length	337 mm
Probe Body Diameter	10 mm
Tip Length	10 mm
Tip Diameter	4 mm
Probe Tip to Sensor X Calibration Point	2 mm
Probe Tip to Sensor Y Calibration Point	2 mm
Probe Tip to Sensor Z Calibration Point	2 mm
Recommended Measurement Distance from Surface	3 mm

6.2. D450V3 Dipole Calibration Certificate

**Calibration Laboratory of
Schmid & Partner
Engineering AG**
Zeughausstrasse 43, 8004 Zurich, Switzerland



S Schweizerischer Kalibrierdienst
C Service suisse d'étalonnage
S Servizio svizzero di taratura
S Swiss Calibration Service

Accredited by the Swiss Accreditation Service (SAS)
The Swiss Accreditation Service is one of the signatories to the EA
Multilateral Agreement for the recognition of calibration certificates

Accreditation No.: **SCS 0108**

Client **CIQ-SZ (Auden)**

Certificate No: **D450V3-1079_Aug16**

CALIBRATION CERTIFICATE

Object **D450V3 - SN: 1079** *SAR 113128 (GDM) JD462*

Calibration procedure(s) **QA CAL-15.v8**
Calibration procedure for dipole validation kits below 700 MHz

Calibration date: **August 29, 2016**

This calibration certificate documents the traceability to national standards, which realize the physical units of measurements (SI).
The measurements and the uncertainties with confidence probability are given on the following pages and are part of the certificate.

All calibrations have been conducted in the closed laboratory facility: environment temperature (22 ± 3)°C and humidity < 70%.

Calibration Equipment used (M&TE critical for calibration)

Primary Standards	ID #	Cal Date (Certificate No.)	Scheduled Calibration
Power meter NRP	SN: 104778	06-Apr-16 (No. 217-02288/02289)	Apr-17
Power sensor NRP-Z91	SN: 103244	06-Apr-16 (No. 217-02288)	Apr-17
Power sensor NRP-Z91	SN: 103245	06-Apr-16 (No. 217-02289)	Apr-17
Reference 20 dB Attenuator	SN: 5277 (20x)	05-Apr-16 (No. 217-02293)	Apr-17
Type-N mismatch combination	SN: 5047.2 / 06327	05-Apr-16 (No. 217-02295)	Apr-17
Reference Probe ET3DV6	SN: 1507	31-Dec-15 (No. ET3-1507_Dec15)	Dec-16
DAE4	SN: 654	12-Aug-16 (No. DAE4-654_Aug16)	Aug-17

Secondary Standards	ID #	Check Date (in house)	Scheduled Check
Power meter E4419B	SN: GB41293874	06-Apr-16 (No. 217-02285/02284)	In house check: Jun-18
Power sensor E4412A	SN: MY41498087	06-Apr-16 (No. 217-02285)	In house check: Jun-18
Power sensor E4412A	SN: 000110210	06-Apr-16 (No. 217-02284)	In house check: Jun-18
RF generator HP 8648C	SN: US3642U01700	04-Aug-99 (in house check Jun-16)	In house check: Jun-18
Network Analyzer HP 8753E	SN: US37390585	18-Oct-01 (in house check Oct-15)	In house check: Oct-16

	Name	Function	Signature
Calibrated by:	Jeton Kastrati	Laboratory Technician	<i>[Signature]</i>
Approved by:	Katja Pokovic	Technical Manager	<i>[Signature]</i>

Issued: August 30, 2016

This calibration certificate shall not be reproduced except in full without written approval of the laboratory.

Calibration Laboratory of
Schmid & Partner
Engineering AG
Zeughausstrasse 43, 8004 Zurich, Switzerland



S Schweizerischer Kalibrierdienst
C Service suisse d'étalonnage
S Servizio svizzero di taratura
S Swiss Calibration Service

Accredited by the Swiss Accreditation Service (SAS)

Accreditation No.: **SCS 0108**

The Swiss Accreditation Service is one of the signatories to the EA
Multilateral Agreement for the recognition of calibration certificates

Glossary:

TSL	tissue simulating liquid
ConvF	sensitivity in TSL / NORM x,y,z
N/A	not applicable or not measured

Calibration is Performed According to the Following Standards:

- IEEE Std 1528-2013, "IEEE Recommended Practice for Determining the Peak Spatial-Averaged Specific Absorption Rate (SAR) in the Human Head from Wireless Communications Devices: Measurement Techniques", June 2013
- IEC 62209-1, "Procedure to measure the Specific Absorption Rate (SAR) for hand-held devices used in close proximity to the ear (frequency range of 300 MHz to 3 GHz)", February 2005
- IEC 62209-2, "Procedure to determine the Specific Absorption Rate (SAR) for wireless communication devices used in close proximity to the human body (frequency range of 30 MHz to 6 GHz)", March 2010
- KDB 865664, "SAR Measurement Requirements for 100 MHz to 6 GHz"

Additional Documentation:

- DASY4/5 System Handbook

Methods Applied and Interpretation of Parameters:

- Measurement Conditions:** Further details are available from the Validation Report at the end of the certificate. All figures stated in the certificate are valid at the frequency indicated.
- Antenna Parameters with TSL:** The dipole is mounted with the spacer to position its feed point exactly below the center marking of the flat phantom section, with the arms oriented parallel to the body axis.
- Feed Point Impedance and Return Loss:** These parameters are measured with the dipole positioned under the liquid filled phantom. The impedance stated is transformed from the measurement at the SMA connector to the feed point. The Return Loss ensures low reflected power. No uncertainty required.
- Electrical Delay:** One-way delay between the SMA connector and the antenna feed point. No uncertainty required.
- SAR measured:** SAR measured at the stated antenna input power.
- SAR normalized:** SAR as measured, normalized to an input power of 1 W at the antenna connector.
- SAR for nominal TSL parameters:** The measured TSL parameters are used to calculate the nominal SAR result.

The reported uncertainty of measurement is stated as the standard uncertainty of measurement multiplied by the coverage factor $k=2$, which for a normal distribution corresponds to a coverage probability of approximately 95%.

Measurement Conditions

DASY system configuration, as far as not given on page 1.

DASY Version	DASY5	V52.8.8
Extrapolation	Advanced Extrapolation	
Phantom	ELI4 Flat Phantom	Shell thickness: 2 ± 0.2 mm
Distance Dipole Center - TSL	15 mm	with Spacer
Zoom Scan Resolution	dx, dy, dz = 5 mm	
Frequency	450 MHz \pm 1 MHz	

Head TSL parameters

The following parameters and calculations were applied.

	Temperature	Permittivity	Conductivity
Nominal Head TSL parameters	22.0 °C	43.5	0.87 mho/m
Measured Head TSL parameters	(22.0 \pm 0.2) °C	44.3 \pm 6 %	0.89 mho/m \pm 6 %
Head TSL temperature change during test	< 0.5 °C	----	----

SAR result with Head TSL

SAR averaged over 1 cm ³ (1 g) of Head TSL	Condition	
SAR measured	250 mW input power	1.16 W/kg
SAR for nominal Head TSL parameters	normalized to 1W	4.58 W/kg \pm 18.1 % (k=2)

SAR averaged over 10 cm ³ (10 g) of Head TSL	condition	
SAR measured	250 mW input power	0.775 W/kg
SAR for nominal Head TSL parameters	normalized to 1W	3.06 W/kg \pm 17.6 % (k=2)

Body TSL parameters

The following parameters and calculations were applied.

	Temperature	Permittivity	Conductivity
Nominal Body TSL parameters	22.0 °C	56.7	0.94 mho/m
Measured Body TSL parameters	(22.0 \pm 0.2) °C	56.7 \pm 6 %	0.95 mho/m \pm 6 %
Body TSL temperature change during test	< 0.5 °C	----	----

SAR result with Body TSL

SAR averaged over 1 cm ³ (1 g) of Body TSL	Condition	
SAR measured	250 mW input power	1.16 W/kg
SAR for nominal Body TSL parameters	normalized to 1W	4.60 W/kg \pm 18.1 % (k=2)

SAR averaged over 10 cm ³ (10 g) of Body TSL	condition	
SAR measured	250 mW input power	0.764 W/kg
SAR for nominal Body TSL parameters	normalized to 1W	3.03 W/kg \pm 17.6 % (k=2)

Appendix (Additional assessments outside the scope of SCS 0108)**Antenna Parameters with Head TSL**

Impedance, transformed to feed point	58.0 Ω - 2.9 j Ω
Return Loss	- 22.0 dB

Antenna Parameters with Body TSL

Impedance, transformed to feed point	56.1 Ω - 5.8 j Ω
Return Loss	- 22.0 dB

General Antenna Parameters and Design

Electrical Delay (one direction)	1.348 ns
----------------------------------	----------

After long term use with 100W radiated power, only a slight warming of the dipole near the feedpoint can be measured.

The dipole is made of standard semirigid coaxial cable. The center conductor of the feeding line is directly connected to the second arm of the dipole. The antenna is therefore short-circuited for DC-signals. On some of the dipoles, small end caps are added to the dipole arms in order to improve matching when loaded according to the position as explained in the "Measurement Conditions" paragraph. The SAR data are not affected by this change. The overall dipole length is still according to the Standard.

No excessive force must be applied to the dipole arms, because they might bend or the soldered connections near the feedpoint may be damaged.

Additional EUT Data

Manufactured by	SPEAG
Manufactured on	March 03, 2011

DASY5 Validation Report for Head TSL

Date: 29.08.1

Test Laboratory: SPEAG, Zurich, Switzerland

DUT: Dipole 450 MHz; Type: D450V3; Serial: D450V3 - SN: 1079

Communication System: UID 0 - CW; Frequency: 450 MHz

Medium parameters used: $f = 450$ MHz; $\sigma = 0.89$ S/m; $\epsilon_r = 44.3$; $\rho = 1000$ kg/m³

Phantom section: Flat Section

Measurement Standard: DASY5 (IEEE/IEC/ANSI C63.19-2011)

DASY52 Configuration:

- Probe: ET3DV6 - SN1507; ConvF(6.58, 6.58, 6.58); Calibrated: 31.12.2015;
- Sensor-Surface: 4mm (Mechanical Surface Detection)
- Electronics: DAE4 Sn654; Calibrated: 12.08.2016
- Phantom: ELI v4.0; Type: QDOVA001BB; Serial: TP:1003
- DASY52 52.8.8(1258); SEMCAD X 14.6.10(7372)

Dipole Calibration for Head Tissue/d=15mm, Pin=250mW/Zoom Scan (7x7x7)/Cube 0:

Measurement grid: dx=5mm, dy=5mm, dz=5mm

Reference Value = 39.87 V/m; Power Drift = -0.05 dB

Peak SAR (extrapolated) = 1.69 W/kg

SAR(1 g) = 1.16 W/kg; SAR(10 g) = 0.775 W/kg

Maximum value of SAR (measured) = 1.26 W/kg

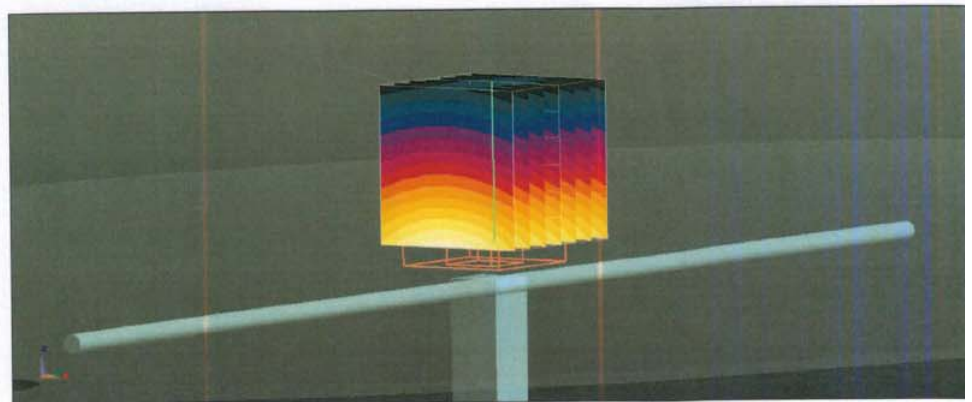
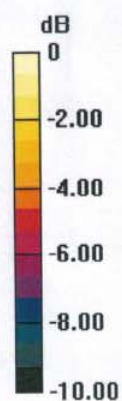

0 dB = 1.26 W/kg = 1.00 dBW/kg

Impedance Measurement Plot for Head TSL

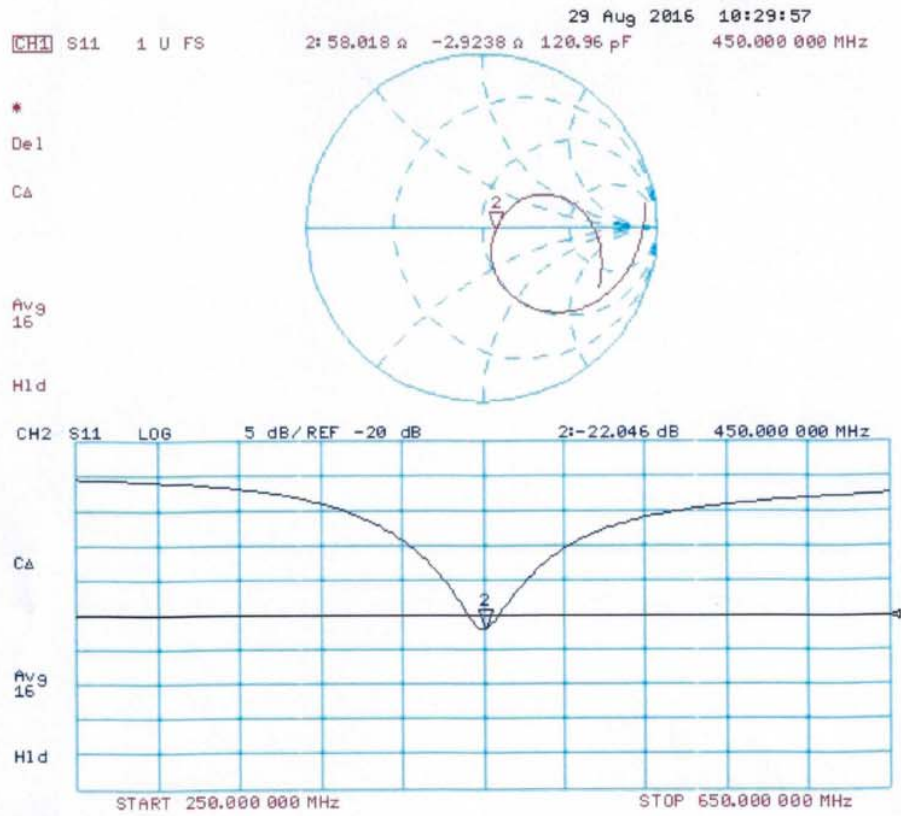

DASY5 Validation Report for Body TSL

Date: 29.08.2016

Test Laboratory: SPEAG, Zurich, Switzerland

DUT: Dipole 450 MHz D450V3; Type: D450V3; Serial: D450V3 - SN:1079

Communication System: UID 0 - CW; Frequency: 450 MHz

Medium parameters used: $f = 450$ MHz; $\sigma = 0.95$ S/m; $\epsilon_r = 56.7$; $\rho = 1000$ kg/m³

Phantom section: Flat Section

Measurement Standard: DASY5 (IEEE/IEC/ANSI C63.19-2011)

DASY52 Configuration:

- Probe: ET3DV6 - SN1507; ConvF(6.99, 6.99, 6.99); Calibrated: 31.12.2015;
- Sensor-Surface: 4mm (Mechanical Surface Detection)
- Electronics: DAE4 Sn654; Calibrated: 12.08.2016
- Phantom: ELI v4.0; Type: QDOVA001BB; Serial: TP:1003
- DASY52 52.8.8(1258); SEMCAD X 14.6.10(7372)

Dipole Calibration for Body Tissue/d=15mm, Pin=250mW/Zoom Scan (7x7x7)/Cube 0:Measurement grid: $dx=5$ mm, $dy=5$ mm, $dz=5$ mm

Reference Value = 37.17 V/m; Power Drift = -0.01 dB

Peak SAR (extrapolated) = 1.82 W/kg

SAR(1 g) = 1.16 W/kg; SAR(10 g) = 0.764 W/kg

Maximum value of SAR (measured) = 1.24 W/kg

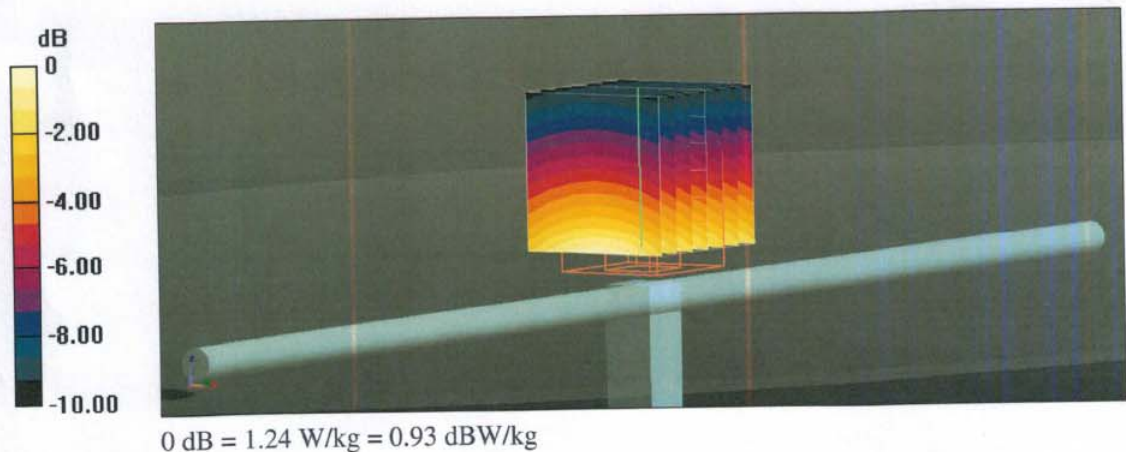

Impedance Measurement Plot for Body TSL

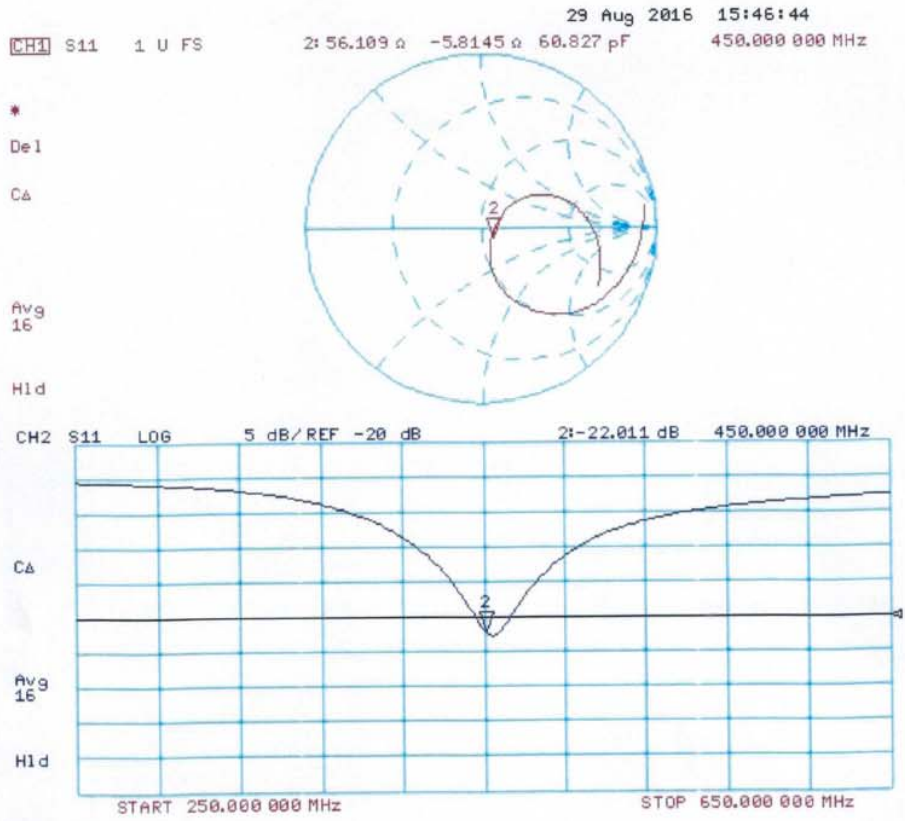

6.3. DAE4 Calibration Certificate



Add: No.51 Xueyuan Road, Haidian District, Beijing, 100191, China
 Tel: +86-10-62304633-2218 Fax: +86-10-62304633-2209
 E-mail: cttl@chinattl.com Http://www.chinattl.cn



中国
国际互
校准
CALIBRA
CNAS LO

Client : **CIQ(Shenzhen)**

Certificate No: **Z16-97120**

CALIBRATION CERTIFICATE

Object **DAE4 - SN: 1315** *JPL62*

Calibration Procedure(s) **FD-Z11-2-002-01**
 Calibration Procedure for the Data Acquisition Electronics (DAEx)

Calibration date: **July 26, 2016**

This calibration Certificate documents the traceability to national standards, which realize the physical units of measurements(SI). The measurements and the uncertainties with confidence probability are given on the following pages and are part of the certificate.

All calibrations have been conducted in the closed laboratory facility: environment temperature(22±3)°C and humidity<70%.

Calibration Equipment used (M&TE critical for calibration)

Primary Standards	ID #	Cal Date(Calibrated by, Certificate No.)	Scheduled Calibration
Process Calibrator 753	1971018	27-June-16 (CTTL, No:J16X04778)	June-17

	Name	Function	Signature
Calibrated by:	Yu Zongying	SAR Test Engineer	<i>[Signature]</i>
Reviewed by:	Qi Dianyuan	SAR Project Leader	<i>[Signature]</i>
Approved by:	Lu Bingsong	Deputy Director of the laboratory	<i>[Signature]</i>

Issued: July 27, 2016

This calibration certificate shall not be reproduced except in full without written approval of the laboratory.



Add: No.51 Xueyuan Road, Haidian District, Beijing, 100191, China
Tel: +86-10-62304633-2218 Fax: +86-10-62304633-2209
E-mail: cttl@chinattl.com Http://www.chinattl.cn

Glossary:

DAE data acquisition electronics
Connector angle information used in DASY system to align probe sensor X to the robot coordinate system.

Methods Applied and Interpretation of Parameters:

- *DC Voltage Measurement:* Calibration Factor assessed for use in DASY system by comparison with a calibrated instrument traceable to national standards. The figure given corresponds to the full scale range of the voltmeter in the respective range.
- *Connector angle:* The angle of the connector is assessed measuring the angle mechanically by a tool inserted. Uncertainty is not required.
- The report provide only calibration results for DAE, it does not contain other performance test results.



Add: No.51 Xueyuan Road, Haidian District, Beijing, 100191, China
 Tel: +86-10-62304633-2218 Fax: +86-10-62304633-2209
 E-mail: cttl@chinattf.com Http://www.chinattf.cn

DC Voltage Measurement

A/D - Converter Resolution nominal

High Range: 1LSB = 6.1 μ V, full range = -100...+300 mV
 Low Range: 1LSB = 61nV, full range = -1.....+3mV

DASY measurement parameters: Auto Zero Time: 3 sec; Measuring time: 3 sec

Calibration Factors	X	Y	Z
High Range	405.179 \pm 0.15% (k=2)	405.018 \pm 0.15% (k=2)	404.98 \pm 0.15% (k=2)
Low Range	3.99015 \pm 0.7% (k=2)	3.98549 \pm 0.7% (k=2)	3.98861 \pm 0.7% (k=2)

Connector Angle

Connector Angle to be used in DASY system	20.5° \pm 1°
---	----------------



**Acceptable Conditions for SAR Measurements Using Probes and Dipoles
Calibrated under the SPEAG-CTTL Dual-Logo Calibration Program to
Support FCC Equipment Certification**

The acceptable conditions for SAR measurements using probes, dipoles and DAEs calibrated by CTTL (*China Telecommunication Technology Labs*), under the Dual-Logo Calibration Certificate program and quality assurance (QA) protocols established between SPEAG (*Schmid & Partner Engineering AG, Switzerland*) and CTTL, to support FCC (*U.S. Federal Communications Commission*) equipment certification are defined and described in the following. The conditions in this KDB are valid until December 31, 2015.

- 1) The agreement established between SPEAG and CTTL is only applicable to calibration services performed by CTTL where its clients (companies and divisions of such companies) are headquartered in the Greater China Region, including Taiwan and Hong Kong. CTTL shall inform the FCC of any changes or early termination to the agreement.
- 2) Only a subset of the calibration services specified in the SPEAG-CTTL agreement, while it remains valid, are applicable to SAR measurements performed using such equipment for supporting FCC equipment certification. These are identified in the following.
 - a) Calibration of dosimetric (SAR) probes EX3DVx, ET3DVx and ES3DVx.
 - i) Free-space E-field and H-field probes, including those used for HAC (hearing aid compatibility) evaluation, temperature probes, other probes or equipment not identified in this document, when calibrated by CTTL, are excluded and cannot be used for measurements to support FCC equipment certification.
 - ii) Signal specific and bundled probe calibrations based on PMR (probe modulation response) characteristics or probe sensor model based linearization methods that are not fully described in SAR standards are excluded and cannot be used for measurements to support FCC equipment certification.
 - b) Calibration of SAR system validation dipoles, excluding HAC dipoles.
 - c) Calibration of data acquisition electronics DAE3Vx, DAE4Vx and DAEasyVx.
 - d) For FCC equipment certification purposes, the frequency range of SAR probe and dipole calibrations is limited to 700 MHz - 6 GHz and provided it is supported by the equipment identified in the CTTL QA protocol (a separate attachment to this document).
 - e) The identical system and equipment setup, measurement configurations, hardware, evaluation algorithms, calibration and QA protocols, including the format of calibration certificates and reports used by SPEAG shall be applied by CTTL. Equivalent test equipment and measurement configurations may be considered only when agreed by both SPEAG and the FCC.
 - f) The calibrated items are only applicable to SPEAG DASY 4 and DASY 5 systems or higher version systems that satisfy the requirements of this KDB.
- 3) The SPEAG-CTTL agreement includes specific protocols identified in the following to ensure the quality of calibration services provided by CTTL under this SPEAG-

7. Test Setup Photos

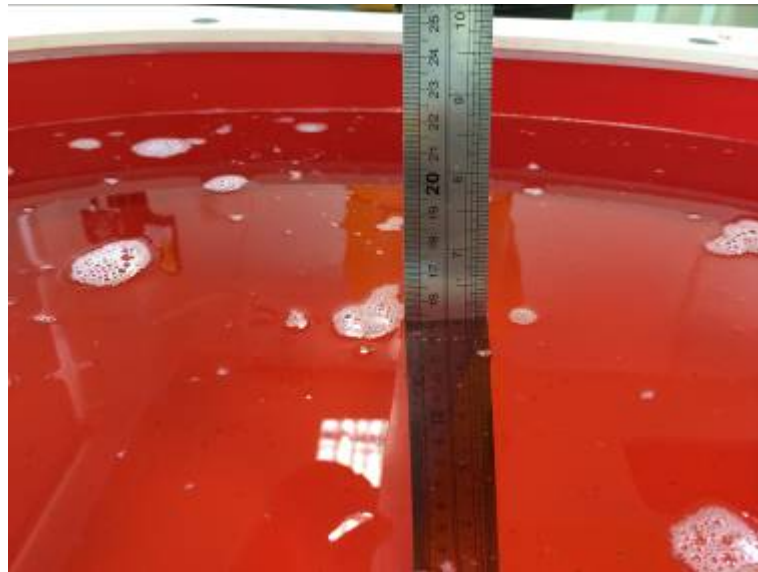

Photograph of the depth in the Head Phantom (450MHz)

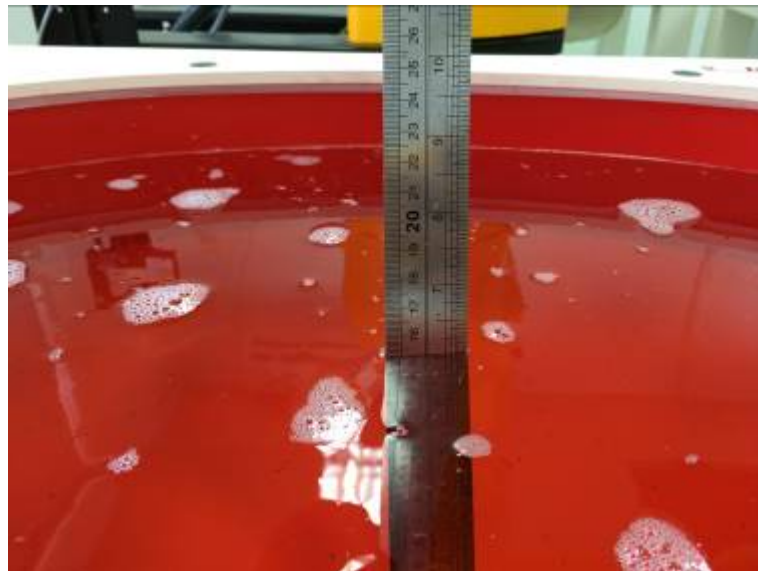

Photograph of the depth in the Body Phantom (450MHz)



Face-held, the front of the EUT towards phantom (The distance was 25mm)



**Body-worn, the front of the EUT towards ground with A1, B1 and D1
(The distance was 0mm)**

.....End of Report.....