

---

# FCC Part 90 Test Report

---

Report No.: AGC00589140205F2

**FCC ID** : PH3-DR638  
**IC** : 3070C-DR638  
**PRODUCT DESIGNATION** : VHF/UHF FM MOBILE TRANSCEIVER  
**BRAND NAME** : ALINCO  
**MODEL NAME** : DR-638  
**CLIENT** : Alinco, Inc. Electronics Division  
**DATE OF ISSUE** : Feb.18, 2014  
**STANDARD(S)** : FCC Part 90 Rules  
: RSS-119 Rules  
**REPORT VERSION** : V 1.0

Attestation of Global Compliance (Shenzhen) Co., Ltd



**CAUTION:** This report shall not be reproduced except in full without the written permission of the test laboratory and shall not be quoted out of context.

### Report Revise Record

Report Version	Revise Time	Issued Date	Valid Version	Notes
V1.0	/	Feb.18, 2014	Valid	Original Report

**VERIFICATION OF COMPLIANCE**

Applicant:	Alinco, Inc. Electronics Division
	Yodoyabashi Dai-Bldg 13F, 4-4-9 Koraibashi, Chuo-Ku, Osaka 541-0043, Japan
Manufacturer:	Alinco, Inc. Electronics Division
	Yodoyabashi Dai-Bldg 13F, 4-4-9 Koraibashi, Chuo-Ku, Osaka 541-0043, Japan
Product Designation:	VHF/UHF FM MOBILE TRANSCEIVER
Brand Name:	ALINCO
Model Name:	DR-638
Hardware Version:	V1.0
Software Version:	V1.0
Report No.:	AGC00589140205F2
Date of Test:	Feb.13, 2014 to Feb.17, 2014

**WE HEREBY CERTIFY THAT:**

The above equipment was tested by Attestation of Global Compliance (Shenzhen) Co., Ltd. The data evaluation, test procedures, and equipment configurations shown in this report were made in accordance with the procedures given in ANSI C 63.4:2009. The sample tested as described in this report is in compliance with the FCC Rules Part 90 requirements

The test results of this report relate only to the tested sample identified in this report.

Tested by Wall Huang  
Wall Huang Feb.18, 2014

Checked By Kidd Yang  
Kidd Yang Feb.18, 2014

Authorized By Solger Zhang  
Solger Zhang Feb.18, 2014

## TABLE OF CONTENTS

<b>1. GENERAL INFORMATION</b> .....	<b>6</b>
1.1 PRODUCT DESCRIPTION .....	6
1.3 TEST METHODOLOGY .....	7
1.4 TEST FACILITY .....	7
1.5 SPECIAL ACCESSORIES .....	7
1.6 EQUIPMENT MODIFICATIONS .....	7
<b>2. SYSTEM TEST CONFIGURATION</b> .....	<b>8</b>
2.1 EUT CONFIGURATION .....	8
2.2 EUT EXERCISE .....	8
2.3 GENERAL TECHNICAL REQUIREMENTS.....	8
2.4 CONFIGURATION OF TESTED SYSTEM.....	9
<b>3. SUMMARY OF TEST RESULTS</b> .....	<b>10</b>
<b>4. DESCRIPTION OF TEST MODES</b> .....	<b>11</b>
<b>5. CONDUCTED LIMITS</b> .....	<b>12</b>
5.1 PROVISIONS APPLICABLE.....	12
5.2 MEASUREMENT PROCEDURE .....	12
5.3 TEST SETUP BLOCK DIAGRAM.....	13
5.4 TEST EQUIPMENT USED.....	13
5.5 TEST RESULT .....	14
<b>6. FREQUENCY TOLERANCE</b> .....	<b>15</b>
6.1 PROVISIONS APPLICABLE.....	15
6.2 MEASUREMENT PROCEDURE .....	15
6.3 TEST SETUP BLOCK DIAGRAM .....	16
6.4 TEST EQUIPMENT USED:.....	16
6.5 TEST RESULT .....	16
<b>7. EMISSION BANDWIDTH</b> .....	<b>22</b>
7.1 PROVISIONS APPLICABLE .....	23
7.2 MEASUREMENT PROCEDURE .....	23
7.3 TEST SETUP BLOCK DIAGRAM.....	23
7.4 MEASUREMENT EQUIPMENT USED:.....	23
7.5 MEASUREMENT RESULT:.....	24
<b>8. UNWANTED RADIATION</b> .....	<b>25</b>
8.1 PROVISIONS APPLICABLE.....	26
8.2 MEASUREMENT PROCEDURE .....	26

8.3 TEST SETUP BLOCK DIAGRAM .....	27
8.4 MEASUREMENT EQUIPMENT USED: .....	29
8.5 MEASUREMENT RESULTS: .....	29
8.6 EMISSION MASK PLOT .....	32
<b>9. MODULATION CHARACTERISTICS .....</b>	<b>34</b>
9.1 PROVISIONS APPLICABLE .....	34
9.2 MEASUREMENT METHOD .....	34
9.3 MEASUREMENT INSTRUMENTS .....	34
9.4 MEASUREMENT RESULT .....	35
<b>10. MAXIMUM TRANSMITTER POWER (CONDUCTED OUTPUT POWER).....</b>	<b>38</b>
10.1 PROVISIONS APPLICABLE .....	38
10.2 TEST PROCEDURE .....	38
10.3 TEST INSTRUMENTS .....	38
10.4 TEST CONFIGURATION .....	38
10.5 TEST RESULT .....	39
10.6 CONDUCT SPURIOUS PLOT .....	40
<b>11. TRANSMITTER FREQUENCY BEHAVIOR .....</b>	<b>43</b>
11.1 PROVISIONS APPLICABLE .....	43
11.2 TEST METHOD .....	43
11.3 TEST INSTRUMENTS .....	43
11.4 DESCRIBE LIMIT LINE OF TRANSMITTER FREQUENCY BEHAVIOR .....	44
11.5 MEASURE RESULT .....	46
<b>12. RADIATED EMISSION ON RECEIVING MODE .....</b>	<b>48</b>
12.1 PROVISIONS APPLICABLE .....	48
12.2 TEST METHOD .....	48
12.3 TEST INSTRUMENTS .....	48
12.4 MEASURE RESULT (MEASURED AT 3M USING FCC PART15 B LIMITS) .....	49
<b>13. AUDIO LOW PASS FILTER RESPONSE .....</b>	<b>51</b>
13.1 LIMITS .....	51
13.2. METHOD OF MEASUREMENTS .....	51
13.3 TEST DATA .....	52
<b>APPENDIX I .....</b>	<b>54</b>
<b>PHOTOGRAPHS OF SETUP .....</b>	<b>54</b>
<b>APPENDIX II .....</b>	<b>55</b>
<b>EXTERNAL VIEW OF EUT .....</b>	<b>55</b>

## 1. GENERAL INFORMATION

### 1.1 PRODUCT DESCRIPTION

The EUT is a VHF/UHF FM MOBILE TRANSCEIVER designed for voice communication. It is designed by way of utilizing the FM modulation achieves the system operating.

A major technical description of EUT is described as following:

Communication Type	Voice / Tone only	
Modulation	FM	
Emission Type	F3E	
Emission Bandwidth	VHF: 10.49KHz UHF: 10.39KHz	
Peak Frequency Deviation	1.87KHz	
Audio Frequency Response	6.24dB	
Maximum Transmitter Power	VHF: 46.98dBm UHF: 45.99dBm	
Output power Modification	VHF: 50W UHF: 40W (It was fixed by the manufacturer, any individual can't arbitrarily change it.)	
Antenna Designation	Detachable	
Power Supply	DC 13.8V	
Limiting Voltage	DC 11.73V	
Operation Frequency Range and Channel	Frequency Range: 136MHz to 174MHz Channel Separation: 12.5KHz (VHF)	Frequency Range: 400MHz to 480MHz Channel Separation: 12.5KHz (UHF)
	Top Channel: 136.025MHz Centre Channel: 155.000MHz Bottom Channel: 173.975MHz	Top Channel: 400.025MHz Centre Channel: 440.000MHz Bottom Channel: 479.975MHz
Frequency Tolerance	VHF: 0.914ppm UHF: 0.860ppm	

## **1.2 RELATED SUBMITTAL(S) / GRANT (S)**

This submittal(s) (test report) is intended for **FCC ID:** PH3-DR638 and **IC:** 3070C-DR638, filing to comply with the FCC Part 90 requirements and the RS-119 requirements.

## **1.3 TEST METHODOLOGY**

The radiated emission testing was performed according to the procedures of ANSI C 63.4: 2009; TIA/EIA 603 and FCC CFR 47 Rules of 2.1046, 2.1047, 2.1049, 2.1051, 2.1053, 2.1055, 2.1057.

## **1.4 TEST FACILITY**

The test site used to collect the radiated data is located on the address of Attestation of Global Compliance (Shenzhen) Co., Ltd. 2/F., Building 2, No.1-No.4, Chaxi Sanwei Technical Industrial Park, Gushu, Xixiang, Bao'an District, Shenzhen, Guangdong, China. The test site is constructed and calibrated to meet the FCC requirements in documents ANSI C63.4: 2003 and IC requirements in documents RS212.

FCC register No.: 259865

## **1.5 SPECIAL ACCESSORIES**

Not available for this EUT intended for grant.

## **1.6 EQUIPMENT MODIFICATIONS**

Not available for this EUT intended for grant.

## **2. SYSTEM TEST CONFIGURATION**

### **2.1 EUT CONFIGURATION**

The EUT configuration for testing is installed on RF field strength measurement to meet the Commission's requirement and operating in a manner which intends to maximize its emission characteristics in a continuous normal application.

### **2.2 EUT EXERCISE**

The Transmitter was operated in the normal operating mode. The TX frequency was fixed which was for the purpose of the measurements.

### **2.3 GENERAL TECHNICAL REQUIREMENTS**

For FCC Part 90 requirements:

- (1). Section 15.207: Conducted Limits
- (2). Section 90.205: Maximum ERP is dependent upon the station's antenna HAAT and required service area
- (3). Section 90.207: Modulation Characteristic
- (4). Section 90.209: Occupied Bandwidth
- (5). Section 90.210: Emission Mask
- (6). Section 90.213: Frequency Tolerance
- (7). Section 90.214: Transient Frequency Behavior
- (8). Section 15.109: Radiated Emission

For RS-119 requirements:

- (1). Section RSS-Gen: Conducted Limits
- (2). Section 119.5.4: Maximum ERP is dependent upon the station's antenna HAAT and required service area
- (3). Section 119. 5.13: Modulation Characteristic
- (4). Section 119. 5.5: Occupied Bandwidth
- (5). Section 119. 5.8: Emission Mask
- (6). Section 119. 5.3: Frequency Tolerance
- (7). Section 119. 5.9: Transient Frequency Behavior
- (8). Section RSS-Gen: Radiated Emission



## 2.4 CONFIGURATION OF TESTED SYSTEM

Fig. 2-1 Configuration of Tested System



Table 2-1 Equipment Used in Tested System

Item	Equipment	Model No.	Identifier	Note
1	VHF/UHF FM MOBILE TRANSCIVER	DR-638	FCC ID: PH3-DR638 IC: 3070C-DR638	EUT

### 3. SUMMARY OF TEST RESULTS

<b>FCC Rules</b>	<b>RS-119</b>	<b>Description Of Test</b>	<b>Result</b>
§15.207	RS-Gen	Conducted Emission	Compliant
§90.205	§5.4	Maximum Transmitter Power	Compliant
§90.207	§5.13	Modulation Characteristic	Compliant
§90.209	§5.5	Occupied Bandwidth	Compliant
§90.210	§5.8	Emission Mask	Compliant
§90.213	§5.3	Frequency Tolerance	Compliant
§90.214	§5.9	Transient Frequency Behavior	Compliant
§15.109	RS-Gen	Radiated Emission	Compliant

#### 4. DESCRIPTION OF TEST MODES

##### RF TEST MODES

The EUT (VHF/UHF FM MOBILE TRANSCEIVER) has been tested under normal operating condition. (The top channel, the middle channel and the bottom channel) are chosen for testing at each channel separation.

No.	TEST MODES	CHANNEL SEPARATION
1	Low Channel	12.5 KHz
2	Middle Channel	12.5 KHz
3	High Channel	12.5 KHz

##### EMC TEST MODES

No.	TEST MODES
1	Standby Mode + (Charging)

**Note:** Only the result of the worst case was recorded in the report.

## 5. CONDUCTED LIMITS

### 5.1 PROVISIONS APPLICABLE

For an intentional radiator that is designed to be connected to the public utility (AC) power line, the, the radio frequency voltage that is conducted back onto the AC power line on any frequencies within the band 150 KHz to 30 MHz shall not exceed the limits in the following table, as measured using a 50uH/50 ohms line impedance stabilization network (LISN). Compliance with the provisions of this paragraph shall be based on the measurement of the radio frequency voltage between each power line and ground at the power terminal. The lower limit applies at the boundary between the frequencies ranges.

Frequency of Emission (MHz)	Conducted Limit(dBuV)	
	Quasi-Peak	Average
0.15 – 0.5	66 to 56 *	56 to 46 *
0.5 – 5	56	46
5 – 30	60	50

\* Decreases with the logarithm of the frequency.

### 5.2 MEASUREMENT PROCEDURE

- (1) The equipment was set up as per the test configuration to simulate typical actual usage per the user's manual. When the EUT is a tabletop system, a wooden table with a height of 0.8 meters is used and is placed on the ground plane as per ANSI C63.4 (see Test Facility for the dimensions of the ground plane used). When the EUT is a floor-standing equipment, it is placed on the ground plane which has a 3-12 mm non-conductive covering to insulate the EUT from the ground plane.
- (2) Support equipment, if needed, was placed as per ANSI C63.4.
- (3) All I/O cables were positioned to simulate typical actual usage as per ANSI C63.4.
- (4) The EUT received power through a Line Impedance Stabilization Network (LISN) which supplied power source and was grounded to the ground plane.
- (5) All support equipments received AC power from a second LISN, if any.
- (6) The EUT test program was started. Emissions were measured on each current carrying line of the EUT using a spectrum Analyzer / Receiver connected to the LISN powering the EUT. The LISN has two monitoring points: Line 1 (Hot Side) and Line 2 (Neutral Side). Two scans were taken: one with Line 1 connected to Analyzer / Receiver and Line 2 connected to a 50 ohm load; the second scan had Line 1 connected to a 50 ohm load and Line 2 connected to the Analyzer / Receiver.
- (7) Analyzer / Receiver scanned from 150 KHz to 30MHz for emissions in each of the test modes.  
During the above scans, the emissions were maximized by cable manipulation.

**5.3 TEST SETUP BLOCK DIAGRAM**

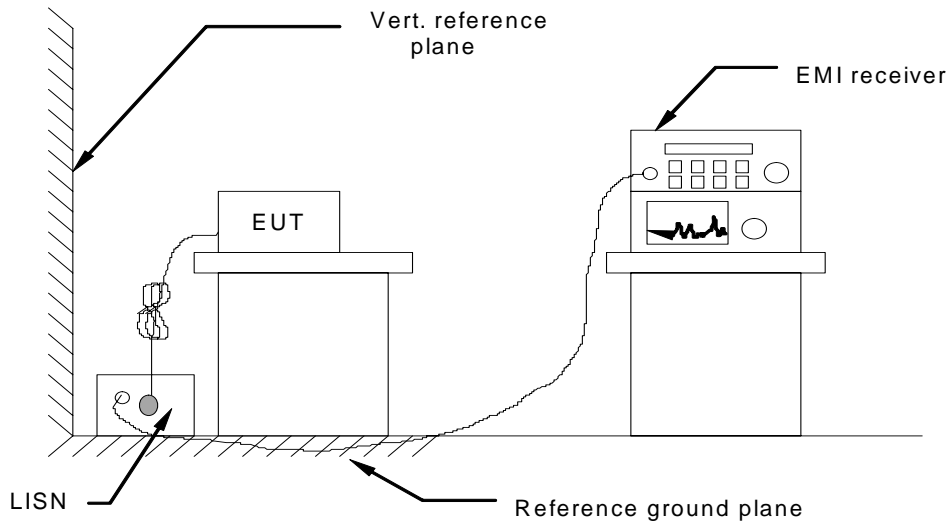

**5.4 TEST EQUIPMENT USED**

Conducted Emission Test Site					
Name of Equipment	Manufacturer	Model	Serial Number	Cal. Date	Cal. Due
TEST RECEIVER	R&S	ESCI	N/A	07/18/2013	07/17/2014
LISN	R&S	ESH3-Z5	N/A	07/18/2013	07/17/2014

**5.5 TEST RESULT**

N/A

## **6. FREQUENCY TOLERANCE**

### **6.1 PROVISIONS APPLICABLE**

- a). According to FCC Part 2 Section 2.1055(a)(1), the frequency stability shall be measured with variation of ambient temperature from  $-30^{\circ}\text{C}$  to  $+50^{\circ}\text{C}$  centigrade.
- b). According to FCC Part 2 Section 2.1055(d)(2), for battery powered equipment, the frequency stability shall be measured with reducing primary supply voltage to the battery operating end point, which is specified by the manufacturer.
- c). According to FCC Part 90 Section 90.213, the frequency tolerance must be maintained within 0.00025% for 12.5 KHz channel separation and 0.0001% for 6.25 KHz channel separation.
- d). According to RSS-119 Section 119.5.3, the frequency tolerance must be maintained within 0.00025% for 12.5 KHz channel separation and 0.0005% for 25KHz channel separation.

### **6.2 MEASUREMENT PROCEDURE**

#### **6.2.1 Frequency stability versus environmental temperature**

1. Setup the configuration per figure 1 for frequencies measurement inside an environment chamber, Install new battery in the EUT.
2. Turn on EUT and set SA center frequency to the EUT radiated frequency. Set SA Resolution Bandwidth to 1KHz and Video Resolution Bandwidth to 1KHz and Frequency Span to 50KHz. Record this frequency as reference frequency.
3. Set the temperature of chamber to  $50^{\circ}\text{C}$ . Allow sufficient time (approximately 30 min) for the temperature of the chamber to stabilize. While maintaining a constant temperature inside the chamber, turn the EUT on and measure the EUT operating frequency.
4. Repeat step 2 with a  $10^{\circ}\text{C}$  decreased per stage until the lowest temperature  $-30^{\circ}\text{C}$  is measured, record all measured frequencies on each temperature step.

#### **6.2.2 Frequency stability versus input voltage**

1. Setup the configuration per figure 1 for frequencies measured at temperature if it is within  $15^{\circ}\text{C}$  to  $25^{\circ}\text{C}$ . Otherwise, an environment chamber set for a temperature of  $20^{\circ}\text{C}$  shall be used. The EUT shall be powered by DC 13.8V
2. Set SA center frequency to the EUT radiated frequency. Set SA Resolution Bandwidth to 1 KHz and Video Resolution Bandwidth to 1KHz. Record this frequency as reference frequency.
3. Supply the EUT primary voltage at the operating end point which is specified by manufacturer and record the frequency.

**6.3 TEST SETUP BLOCK DIAGRAM**

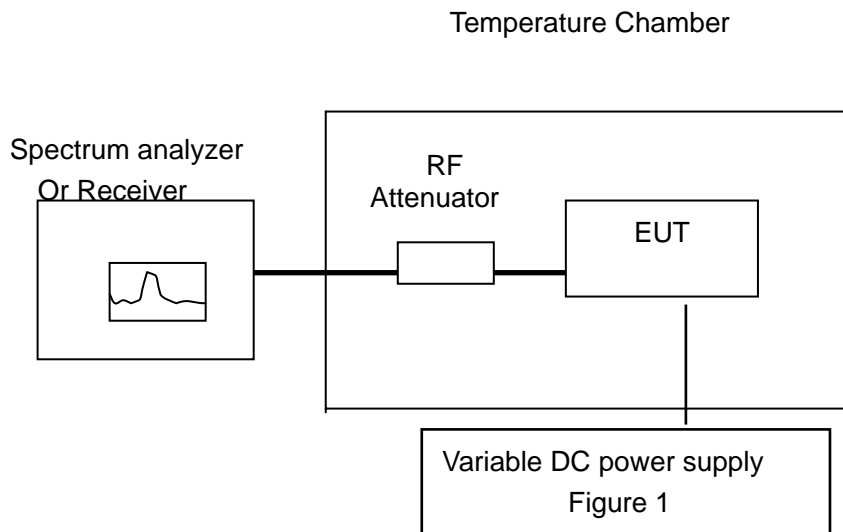

**6.4 TEST EQUIPMENT USED:**

NAME OF EQUIPMENT	MANUFACTURER	MODEL	SERIAL NUMBER	Cal. Date	Cal. Due
Receiver	R&S	ESCI	N/A	07/18/2013	07/17/2014
Climate Chamber	EXPERY	TN-400	N/A	07/18/2013	07/17/2014

**6.5 TEST RESULT**



**VHF TEST RESULT**

(1) Frequency stability versus input voltage (Supply nominal voltage is 13.8V)

**Bottom Channel @ 12.5 KHz Channel Separation**

Reference Frequency:	136.025	Limit:	5.0ppm
Environment Temperature	Power Supply	Frequency Deviation	
(°C)	(V)	(MHz)	ppm
50	13.8	136.025101	0.743
40	13.8	136.025065	0.478
30	13.8	136.025038	0.279
20	13.8	136.025061	0.448
10	13.8	136.025071	0.522
0	13.8	136.025082	0.603
-10	13.8	136.025053	0.390
-20	13.8	136.025111	0.816
-30	13.8	136.025107	0.787

**Middle Channel @ 12.5 KHz Channel Separation**

Reference Frequency:	155.000 MHz	Limit:	5.0ppm
Environment Temperature	Power Supply	Frequency Deviation	
(°C)	(V)	(MHz)	ppm
50	13.8	155.000138	0.890
40	13.8	155.000141	0.910
30	13.8	155.000131	0.845
20	13.8	155.000125	0.806
10	13.8	155.000141	0.910
0	13.8	155.000124	0.800
-10	13.8	155.000121	0.781
-20	13.8	155.000123	0.794
-30	13.8	155.000127	0.819

**Top Channel @ 12.5 KHz Channel Separation**

Reference Frequency:	173.975 MHz	Limit:	5.0ppm
Environment Temperature	Power Supply	Frequency Deviation	
(°C)	(V)	(MHz)	ppm
50	13.8	173.975161	0.925
40	13.8	173.975156	0.897
30	13.8	173.975142	0.816
20	13.8	173.975149	0.856
10	13.8	173.975153	0.879
0	13.8	173.975129	0.741
-10	13.8	173.975121	0.696
-20	13.8	173.975121	0.696
-30	13.8	173.975154	0.885

(2) Frequency stability versus input voltage (Battery limiting voltage is 11.73V)

**Bottom Channel @ 12.5 KHz Channel Separation**

Reference Frequency:	136.025	Limit:	5.0ppm
Environment Temperature	Power Supply	Frequency Deviation	
(°C)	(V)	(MHz)	ppm
50	11.73	136.025117	0.860
40	11.73	136.025082	0.603
30	11.73	136.025077	0.566
20	11.73	136.025055	0.404
10	11.73	136.025056	0.412
0	11.73	136.025067	0.493
-10	11.73	136.025052	0.382
-20	11.73	136.025116	0.853
-30	11.73	136.025111	0.816

**Middle Channel @ 12.5 KHz Channel Separation**

Reference Frequency:	155.000 MHz	Limit:	5.0ppm
Environment Temperature	Power Supply	Frequency Deviation	
(°C)	(V)	(MHz)	ppm
50	11.73	155.000137	0.884
40	11.73	155.000129	0.832
30	11.73	155.000126	0.813
20	11.73	155.000121	0.781
10	11.73	155.000112	0.723
0	11.73	155.000115	0.742
-10	11.73	155.000119	0.768
-20	11.73	155.000121	0.781
-30	11.73	155.000132	0.852

**Top Channel @ 12.5 KHz Channel Separation**

Reference Frequency:	173.975 MHz	Limit:	5.0ppm
Environment Temperature	Power Supply	Frequency Deviation	
(°C)	(V)	(MHz)	ppm
50	11.73	173.975169	0.971
40	11.73	173.975162	0.931
30	11.73	173.975152	0.874
20	11.73	173.975134	0.770
10	11.73	173.975136	0.782
0	11.73	173.975116	0.667
-10	11.73	173.975139	0.799
-20	11.73	173.975142	0.816
-30	11.73	173.975137	0.787

(3) Frequency stability versus input voltage (Battery Fully Charged voltage is 15.87V)

**Bottom Channel @ 12.5 KHz Channel Separation**

Reference Frequency:	136.025	Limit:	5.0ppm
Environment Temperature	Power Supply	Frequency Deviation	
(°C)	(V)	(MHz)	ppm
50	15.87	136.025109	0.801
40	15.87	136.025078	0.573
30	15.87	136.025072	0.529
20	15.87	136.025034	0.250
10	15.87	136.025029	0.213
0	15.87	136.025026	0.191
-10	15.87	136.025036	0.265
-20	15.87	136.025114	0.838
-30	15.87	136.025119	0.875

**Middle Channel @ 12.5 KHz Channel Separation**

Reference Frequency:	155.000 MHz	Limit:	5.0ppm
Environment Temperature	Power Supply	Frequency Deviation	
(°C)	(V)	(MHz)	ppm
50	15.87	155.00014	0.903
40	15.87	155.000134	0.865
30	15.87	155.000132	0.852
20	15.87	155.000126	0.813
10	15.87	155.000115	0.742
0	15.87	155.000118	0.761
-10	15.87	155.000128	0.826
-20	15.87	155.000129	0.832
-30	15.87	155.000136	0.877

**Top Channel @ 12.5 KHz Channel Separation**

Reference Frequency:	173.975 MHz	Limit:	5.0ppm
Environment Temperature	Power Supply	Frequency Deviation	
(°C)	(V)	(MHz)	ppm
50	15.87	173.975138	0.793
40	15.87	173.975154	0.885
30	15.87	173.975151	0.868
20	15.87	173.975144	0.828
10	15.87	173.975128	0.736
0	15.87	173.975121	0.696
-10	15.87	173.975142	0.816
-20	15.87	173.975151	0.868
-30	15.87	173.975159	0.914

**UHF TEST RESULT**

(1) Frequency stability versus input voltage (Supply nominal voltage is 13.8V)

**Bottom Channel @ 12.5 KHz Channel Separation**

Reference Frequency:	400.025 MHz	Limit:	2.5ppm
Environment Temperature	Power Supply	Frequency Deviation	
(°C)	(V)	(MHz)	ppm
50	13.8	400.025307	0.767
40	13.8	400.025316	0.790
30	13.8	400.025292	0.730
20	13.8	400.025285	0.712
10	13.8	400.025273	0.682
0	13.8	400.025228	0.570
-10	13.8	400.025331	0.827
-20	13.8	400.025341	0.852
-30	13.8	400.025307	0.767

**Middle Channel @ 12.5 KHz Channel Separation**

Reference Frequency:	440.000 MHz	Limit:	2.5ppm
Environment Temperature	Power Supply	Frequency Deviation	
(°C)	(V)	(MHz)	ppm
50	13.8	440.000352	0.800
40	13.8	440.000289	0.657
30	13.8	440.000282	0.641
20	13.8	440.000272	0.618
10	13.8	440.000261	0.593
0	13.8	440.000251	0.570
-10	13.8	440.000259	0.589
-20	13.8	440.000271	0.616

**Top Channel @ 12.5 KHz Channel Separation**

Reference Frequency:	479.975 MHz	Limit:	2.5ppm
Environment Temperature	Power Supply	Frequency Deviation	
(°C)	(V)	(MHz)	ppm
50	13.8	479.975372	0.775
40	13.8	479.975362	0.754
30	13.8	479.975356	0.742
20	13.8	479.975342	0.713
10	13.8	479.975343	0.715
0	13.8	479.975336	0.700
-10	13.8	479.975351	0.731
-20	13.8	479.975348	0.725
-30	13.8	479.975369	0.769

(2) Frequency stability versus input voltage (Battery limiting voltage is 11.73V)

**Bottom Channel @ 12.5 KHz Channel Separation**

Reference Frequency:	400.025 MHz	Limit:	2.5ppm
Environment Temperature	Power Supply	Frequency Deviation	
(°C)	(V)	(MHz)	ppm
50	11.73	400.025314	0.785
40	11.73	400.025319	0.797
30	11.73	400.025293	0.732
20	11.73	400.025287	0.717
10	11.73	400.025267	0.667
0	11.73	400.025231	0.577
-10	11.73	400.025334	0.835
-20	11.73	400.025344	0.860
-30	11.73	400.025336	0.840

**Middle Channel @ 12.5 KHz Channel Separation**

Reference Frequency:	440.000 MHz	Limit:	2.5ppm
Environment Temperature	Power Supply	Frequency Deviation	
(°C)	(V)	(MHz)	ppm
50	11.73	440.000362	0.823
40	11.73	440.000293	0.666
30	11.73	440.000279	0.634
20	11.73	440.000285	0.648
10	11.73	440.000269	0.611
0	11.73	440.000265	0.602
-10	11.73	440.000272	0.618
-20	11.73	440.000281	0.639
-30	11.73	440.000288	0.655

**Top Channel @ 12.5 KHz Channel Separation**

Reference Frequency:	479.975 MHz	Limit:	2.5ppm
Environment Temperature	Power Supply	Frequency Deviation	
(°C)	(V)	(MHz)	ppm
50	11.73	479.975369	0.769
40	11.73	479.975361	0.752
30	11.73	479.975382	0.796
20	11.73	479.975341	0.710
10	11.73	479.975339	0.706
0	11.73	479.975327	0.681
-10	11.73	479.975339	0.706
-20	11.73	479.975352	0.733
-30	11.73	479.975361	0.752

(3) Frequency stability versus input voltage (Battery Fully Charged voltage is 15.87V)

**Bottom Channel @ 12.5 KHz Channel Separation**

Reference Frequency:	400.025 MHz	Limit:	2.5ppm
Environment Temperature	Power Supply	Frequency Deviation	
(°C)	(V)	(MHz)	ppm
50	15.87	400.025368	0.920
40	15.87	400.025322	0.805
30	15.87	400.025289	0.722
20	15.87	400.025279	0.697
10	15.87	400.025263	0.657
0	15.87	400.025251	0.627
-10	15.87	400.025355	0.887
-20	15.87	400.025349	0.872
-30	15.87	400.025362	0.905

**Middle Channel @ 12.5 KHz Channel Separation**

Reference Frequency:	440.000 MHz	Limit:	2.5ppm
Environment Temperature	Power Supply	Frequency Deviation	
(°C)	(V)	(MHz)	ppm
50	15.87	440.000359	0.816
40	15.87	440.000294	0.668
30	15.87	440.000288	0.655
20	15.87	440.000279	0.634
10	15.87	440.000273	0.620
0	15.87	440.000258	0.586
-10	15.87	440.000257	0.584
-20	15.87	440.000281	0.639
-30	15.87	440.000291	0.661

**Top Channel @ 12.5 KHz Channel Separation**

Reference Frequency:	479.975 MHz	Limit:	2.5ppm
Environment Temperature	Power Supply	Frequency Deviation	
(°C)	(V)	(MHz)	ppm
50	15.87	479.975362	0.754
40	15.87	479.975351	0.731
30	15.87	479.975339	0.706
20	15.87	479.975336	0.700
10	15.87	479.975342	0.713
0	15.87	479.975353	0.735
-10	15.87	479.975347	0.723
-20	15.87	479.975355	0.740
-30	15.87	479.975359	0.748

## 7. EMISSION BANDWIDTH

### 7.1 PROVISIONS APPLICABLE

According to FCC Part 90 Section 90.209: The authorized bandwidth shall be 11.25 KHz for 12.5 KHz channel separation and 6 KHz for 6.25 KHz channel separation.

According to RSS-119 Section 119.5.5: The authorized bandwidth shall be 11.25 KHz for 12.5 KHz

### 7.2 MEASUREMENT PROCEDURE

- 1). The EUT was placed on a turntable which is 0.8m above ground plane.
- 2). The EUT was modulated by 2.5 KHz Sine wave audio signal, The level of the audio signal employed is 16 dB greater than that necessary to produce 50% of rated system deviation. Rated system deviation is 2.5 kHz (12.5 kHz channel spacing).
- 3). Set SPA Center Frequency = fundamental frequency, RBW=VBW= 300 Hz, Span =50 KHz.
- 4). Set SPA Max hold. Mark peak, -26 dB.

### 7.3 TEST SETUP BLOCK DIAGRAM

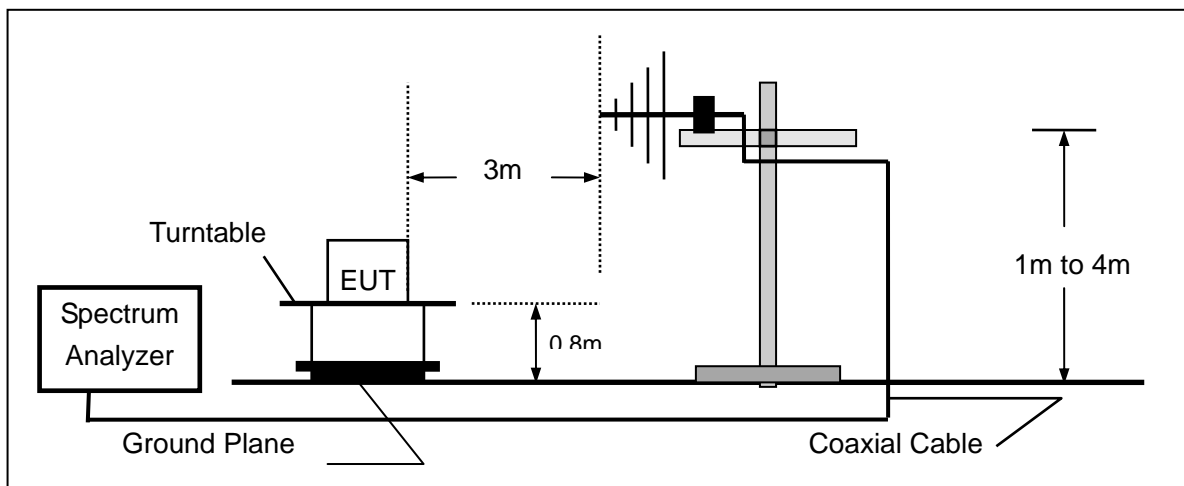

### 7.4 MEASUREMENT EQUIPMENT USED:

NAME OF EQUIPMENT	MANUFACTURER	MODEL	SERIAL NUMBER	Cal. Date	Cal. Due
SPECTRUM ANALYZER	AGILENT	E4440A	US44300399	07/18/2013	07/17/2014
MODULATION ANALYZER	HP	8920B	3104A03367	07/18/2013	07/17/2014
BROADBAND ANT.	A.H.	SAS-521-4	A0304224	07/18/2013	07/17/2014

**7.5 MEASUREMENT RESULT:**

**TEST RESULT FOR VHF**

<b>26 dB Bandwidth Measurement Result</b>			
Operating Frequency	12.5 KHz Channel Separation		
	Test Data	Limits	Result
136.025MHz	10.45KHz	11.25 KHz	Pass
155.000MHz	10.49KHz	11.25 KHz	Pass
173.975MHz	10.42KHz	11.25 KHz	Pass

**Occupied bandwidth of Middle Channel (Maximum) @ 12.5 KHz Channel Separation**

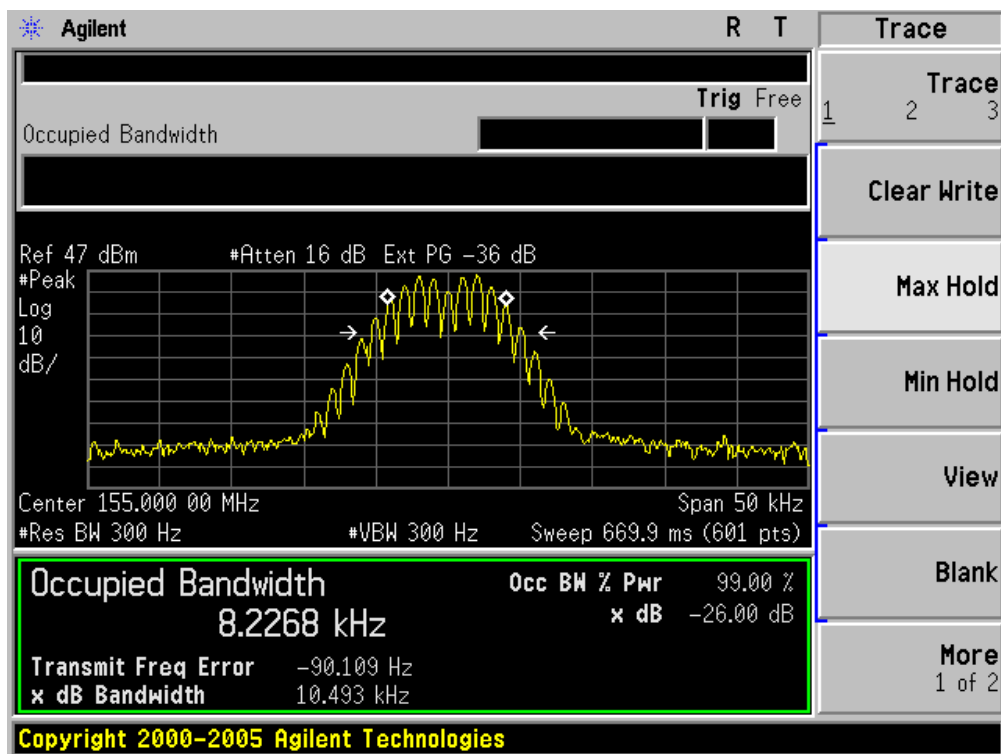



**TEST RESULT FOR UHF**

26 DB BANDWIDTH MEASUREMENT RESULT			
Operating Frequency	12.5 KHz Channel Separation		
	Test Data	Limits	Result
400.025MHz	10.36KHz	11.25 KHz	Pass
440.000MHz	10.39KHz	11.25 KHz	Pass
479.975MHz	10.34KHz	11.25 KHz	Pass

**Occupied bandwidth of Middle Channel (Maximum)**

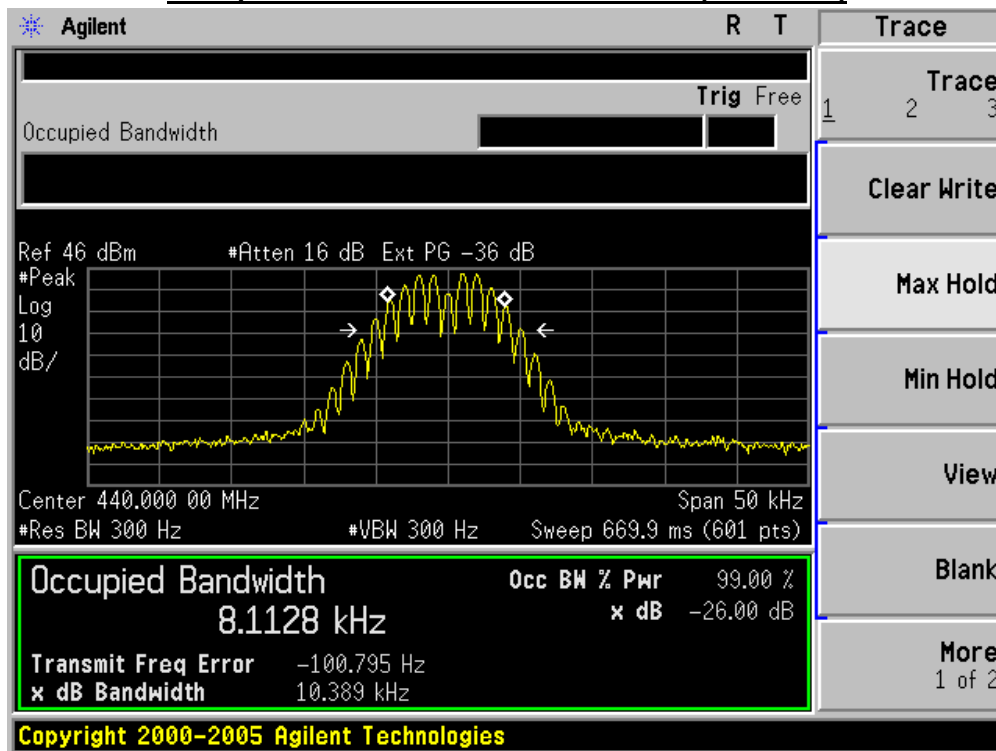

## 8. UNWANTED RADIATION

### 8.1 PROVISIONS APPLICABLE

8.1.1 According to Section 90.210, the power of each unwanted emission shall be less than Transmitted Power as specified below for transmitters designed to operate with each channel separation.

According to RSS-119 Section 119.5.8, the power of each unwanted emission shall be less than Transmitted Power as specified below for transmitters with each channel separation.

For 12.5 KHz Channel Separation:

- (1). On any frequency removed from the center of the authorized bandwidth  $f_0$  to 5.625 KHz removed from  $f_0$ : Zero dB.
- (2). On any frequency removed from the center of the authorized bandwidth by a displacement Frequency ( $f_d$  in KHz)  $f_0$  of more than 5.625 KHz but no more than 12.5 KHz: At least  $7.27(f_d - 2.88 \text{ KHz})$  dB
- (3). On any frequency removed from the center of the authorized bandwidth by a displacement Frequency ( $f_d$  in KHz)  $f_0$  of more than 12.5 KHz: At least  $50 + 10 \log(P)$  dB or 70 dB, whichever is lesser attenuation.

For 6.25 KHz Channel Separation:

- (1). On any frequency from the center of the authorized bandwidth  $f_0$  to 3.0 kHz removed from  $f_0$ : Zero dB.
- (2). On any frequency removed from the center of the authorized bandwidth by a displacement frequency ( $f_d$  in kHz) of more than 3.0 kHz but no more than 4.6 kHz: At least  $30 + 16.67(f_d - 3 \text{ kHz})$  or  $55 + 10 \log(P)$  or 65 dB, whichever is the lesser attenuation.
- (3). On any frequency removed from the center of the authorized bandwidth by more than 4.6 kHz: At least  $55 + 10 \log(P)$  or 65 dB, whichever is the lesser attenuation.

### 8.2 MEASUREMENT PROCEDURE

- (1) On a test site, the EUT shall be placed on a turntable, and in the position closest to the normal use as declared by the user.
- (2) The test antenna shall be oriented initially for vertical polarization located 3m from the EUT to correspond to the transmitter.
- (3) The output of the antenna shall be connected to the measuring receiver and either a peak or quasi-peak detector was used for the measurement as indicated on the report. The detector selection is based on how close the emission level was approaching the limit.
- (4) The transmitter shall be switched on; if possible, without the modulation and the measurement receiver shall be tuned to the frequency of the transmitter under test.
- (5) The test antenna shall be raised and lowered through the specified range of height until the measuring receiver detects a maximum signal level.
- (6) The transmitter shall then be rotated through 360° in the horizontal plane, until the maximum signal level is detected by the measuring receiver.
- (7) The test antenna shall be raised and lowered again through the specified range of height until the measuring receiver detects a maximum signal level.

- (8) The maximum signal level detected by the measuring receiver shall be noted.
- (9) The measurement shall be repeated with the test antenna set to horizontal polarization.
- (10) Replace the antenna with a proper Antenna (substitution antenna).
- (11) The substitution antenna shall be oriented for vertical polarization and, if necessary, the length of the substitution antenna shall be adjusted to correspond to the frequency of transmitting.
- (12) The substitution antenna shall be connected to a calibrated signal generator.
- (13) If necessary, the input attenuator setting of the measuring receiver shall be adjusted in order to increase the sensitivity of the measuring receiver.
- (14) The test antenna shall be raised and lowered through the specified range of the height to ensure that the maximum signal is received.
- (15) The input signal to substitution antenna shall be adjusted to the level that produces a level detected by the measuring receiver, that is equal to the level noted while the transmitter radiated power was measured, corrected for the change of input attenuation setting of the measuring receiver.
- (16) The input level to the substitution antenna shall be recorded as power level in dBm, corrected for any change of input attenuator setting of the measuring receiver.
- (17) The measurement shall be repeated with the test antenna and the substitution antenna oriented for horizontal polarization.

### 8.3 TEST SETUP BLOCK DIAGRAM

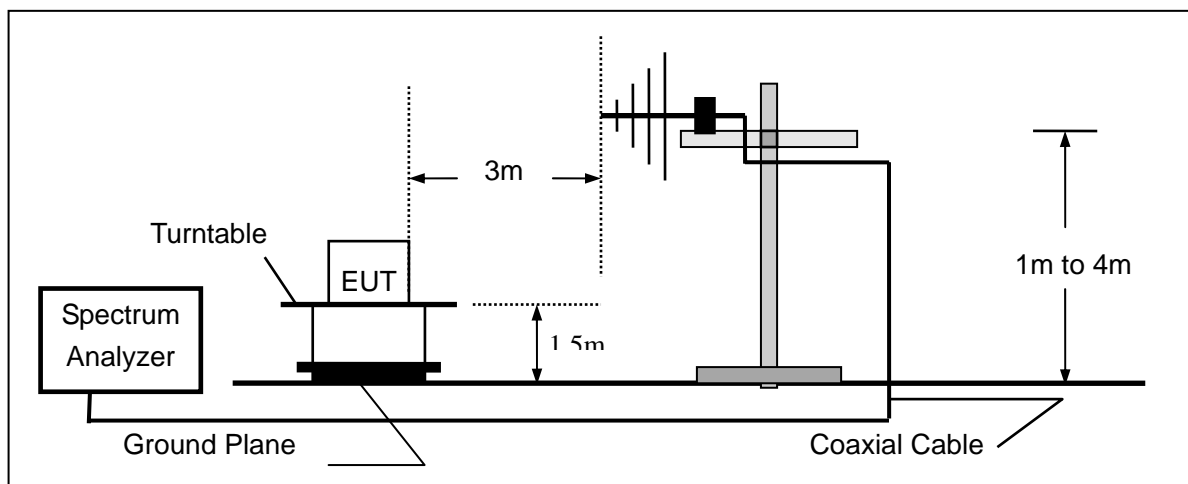

### SUBSTITUTION METHOD: (Radiated Emissions)

#### Radiated Below 1GHz

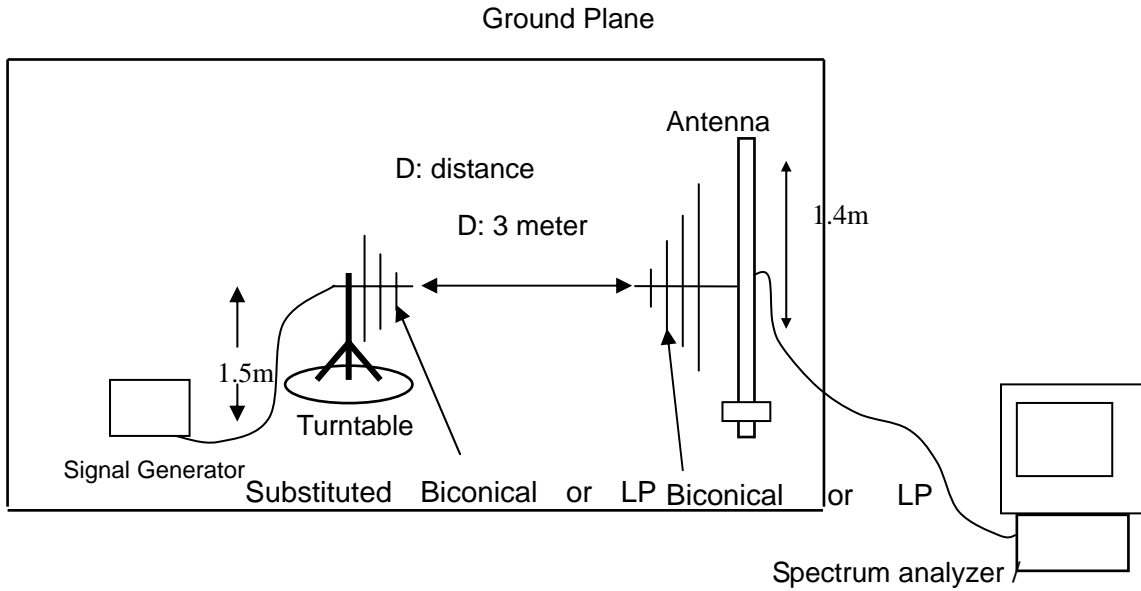

#### Radiated Above 1 GHz

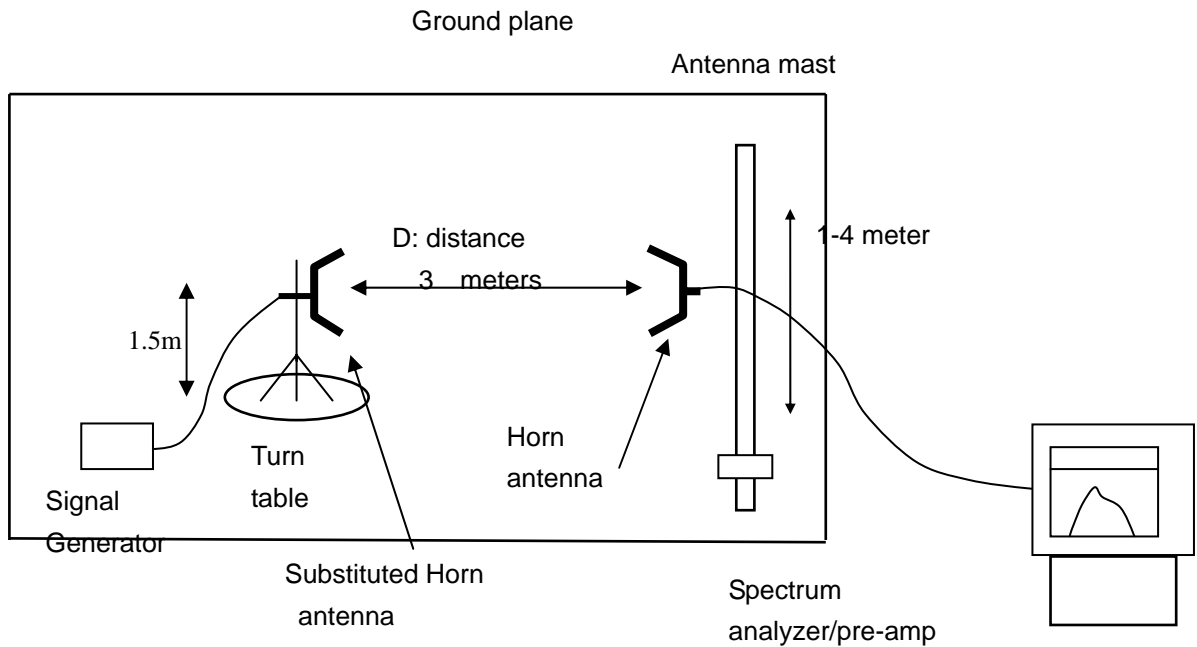

**8.4 MEASUREMENT EQUIPMENT USED:**

NAME OF EQUIPMENT	MANUFACTURER	MODEL	SERIAL NUMBER	Cal. Date	Cal. Due
SPECTRUM ANALYZER	AGILENT	E4440A	US44300399	07/18/2013	07/17/2014
HORN ANT.	EM	EM-AH-10180	100150	07/18/2013	07/17/2014
BROADBAND ANT.	A.H.	SAS-521-4	A0304224	07/18/2013	07/17/2014
AMPLIFIER	EM	EM30180	0607030	07/18/2013	07/17/2014
POSITIONING CONTROLLER	MF	MF-7802	MF780208147	--	--
Horn Antenna	A.H. Systems Inc.	SAS-574	--	07/17/2013	07/16/2014
SIGNAL GENERATOR	Agilent	E4421B	122501288	07/17/2013	07/16/2014

**8.5 MEASUREMENT RESULTS:**

**Measurement Result for 12.5 KHz Channel Separation-VHF**

On any frequency removed from the center of the authorized bandwidth by a displacement Frequency ( $f_d$  in KHz)  $f_o$  of more than 12.5 KHz: At least  $50+10 \log(P)$  dB or 70 dB, which ever is lesser attenuation.

**Limit: At least  $50+10 \log(P) = 50+10 \log(50) = 67$  (dB)**

**Measurement Result for 12.5 KHz Channel Separation-UHF**

On any frequency removed from the center of the authorized bandwidth by a displacement Frequency ( $f_d$  in KHz)  $f_o$  of more than 12.5 KHz: At least  $50+10 \log(P)$  dB or 70 dB, which ever is lesser attenuation.

**Limit: At least  $50+10 \log(P) = 50+10 \log(40) = 66$  (dB)**

**TEST RESULT FOR VHF**

**Measurement Result for 12.5 KHz Channel Separation @ 136.025MHz**

Emission Frequency (MHz)	Ant. Polarity(H/V)	Measurement Result Below carrier(dBc)	Limit below carrier(dBc)	Result(P/F)
136.025	V	0		pass
272.050	V	80.26(-33.27dBm)	67	pass
408.08	V	80.98(-33.99dBm)	67	pass
544.100	V	82.41	67	pass
680.125	V	83.24	67	pass
816.150	V	85.71	67	pass
952.175	V	87.41	67	pass
1088.200	V	90.22	67	pass
1224.225	V	91.27	67	pass
1360.250	V	92.61	67	pass

**Measurement Result for 12.5 KHz Channel Separation @ 155.000MHz**

Emission Frequency (MHz)	Ant. Polarity(H/V)	Measurement Result Below carrier(dBc)	Limit below carrier(dBc)	Result(P/F)
155.000	V	0		pass
310.000	V	80.35(-33.36dBm)	67	pass
465.000	V	82.11	67	pass
620.000	V	83.67	67	pass
775.000	V	84.28	67	pass
930.000	V	87.33	67	pass
1085.000	V	88.66	67	pass
1240.000	V	89.17	67	pass
1395.000	V	90.52	67	pass
1550.000	V	91.66	67	pass

**Measurement Result for 12.5 KHz Channel Separation @ 173.975MHz**

Emission Frequency (MHz)	Ant. Polarity(H/V)	Measurement Result Below carrier(dBc)	Limit below carrier(dBc)	Result(P/F)
173.975	V	0		pass
347.950	V	80.71(-33.72dBm)	67	pass
521.925	V	82.69	67	pass
695.900	V	83.79	67	pass
869.875	V	85.47	67	pass
1043.850	V	86.34	67	pass
1217.825	V	87.24	67	pass
1391.800	V	89.33	67	pass
1565.775	V	90.66	67	pass
1739.750	V	92.07	67	pass

**TEST RESULT FOR UHF**

**Measurement Result for 12.5 KHz Channel Separation @ 400.025MHz**

Emission Frequency (MHz)	Ant. Polarity(H/V)	Measurement Result Below carrier(dBc)	Limit below carrier(dBc)	Result(P/F)
400.075	V	0		pass
800.150	V	79.04(-43.04dBm)	66	pass
1200.23	V	79.33(-33.33dBm)	66	pass
1600.300	V	80.24	66	pass
2000.375	V	82.42	66	pass
2400.450	V	83.92	66	pass
2800.525	V	85.71	66	pass
3200.600	V	87.44	66	pass
3600.675	V	89.71	66	pass
4000.750	V	91.24	66	pass

**Measurement Result for 12.5 KHz Channel Separation @ 440.000MHz**

Emission Frequency (MHz)	Ant. Polarity(H/V)	Measurement Result Below carrier(dBc)	Limit below carrier(dBc)	Result(P/F)
440.000	V	0		pass
880.000	V	79.66(-33.66dBm)	66	pass
1320.000	V	80.32	66	pass
1760.000	V	82.39	66	pass
2200.000	V	85.74	66	pass
2640.000	V	86.94	66	pass
3080.000	V	88.57	66	pass
3520.000	V	90.14	66	pass
3960.000	V	91.09	66	pass
4400.000	V	91.77	66	pass

**Measurement Result for 12.5 KHz Channel Separation @ 479.975MHz**

Emission Frequency (MHz)	Ant. Polarity(H/V)	Measurement Result Below carrier(dBc)	Limit below carrier(dBc)	Result(P/F)
479.975	V	0		pass
959.950	V	79.55(-35.55dBm)	66	pass
1439.925	V	81.42	66	pass
1919.900	V	83.66	66	pass
2399.875	V	84.32	66	pass
2879.850	V	85.71	66	pass
3359.825	V	87.44	66	pass
3839.800	V	89.37	66	pass
4319.775	V	90.22	66	pass
4799.750	V	91.63	66	pass

**Notes:** The emissions were scanned from 30 MHz to 10th harmonics.

### 8.6 EMISSION MASK PLOT

The detailed procedure employed for Emission Mask measurements are specified as following:

- The transmitter shall be modulated by a 2.5 kHz audio signal,
- The level of the audio signal employed is 16 dB greater than that necessary to produce 50% of rated system deviation. Rated system deviation is 2.5 kHz.

#### TEST RESULT FOR VHF

#### The Worst Emission Mask for 12.5 KHz channel Separation (50W)

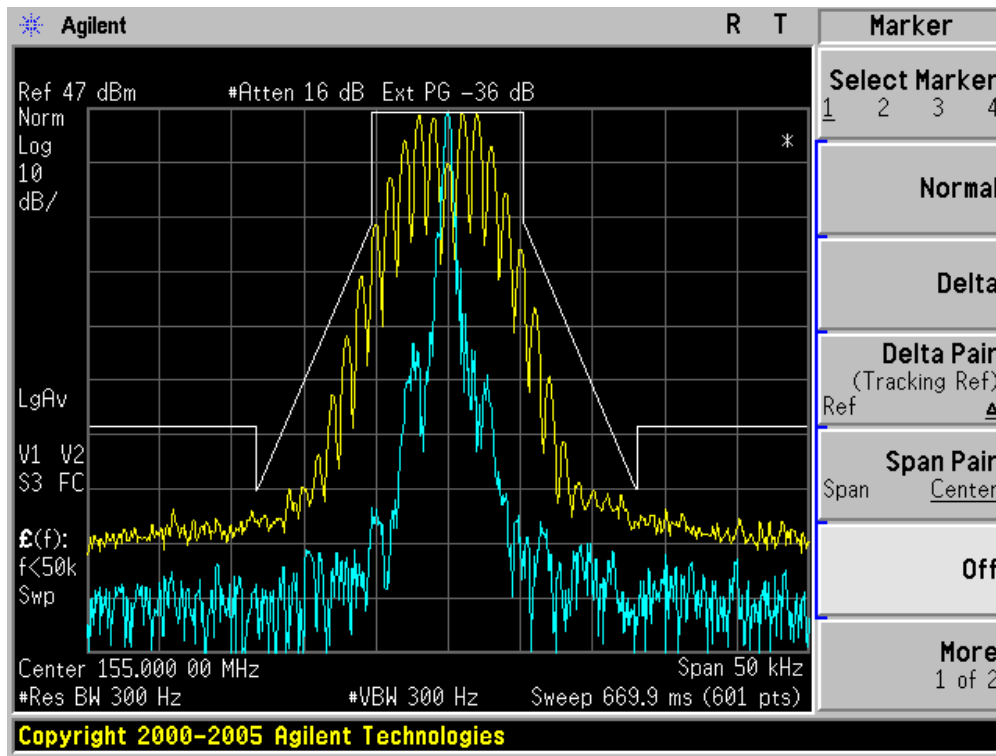



**TEST RESULT FOR UHF**

**The Worst Emission Mask for 12.5 KHz channel Separation (40W)**

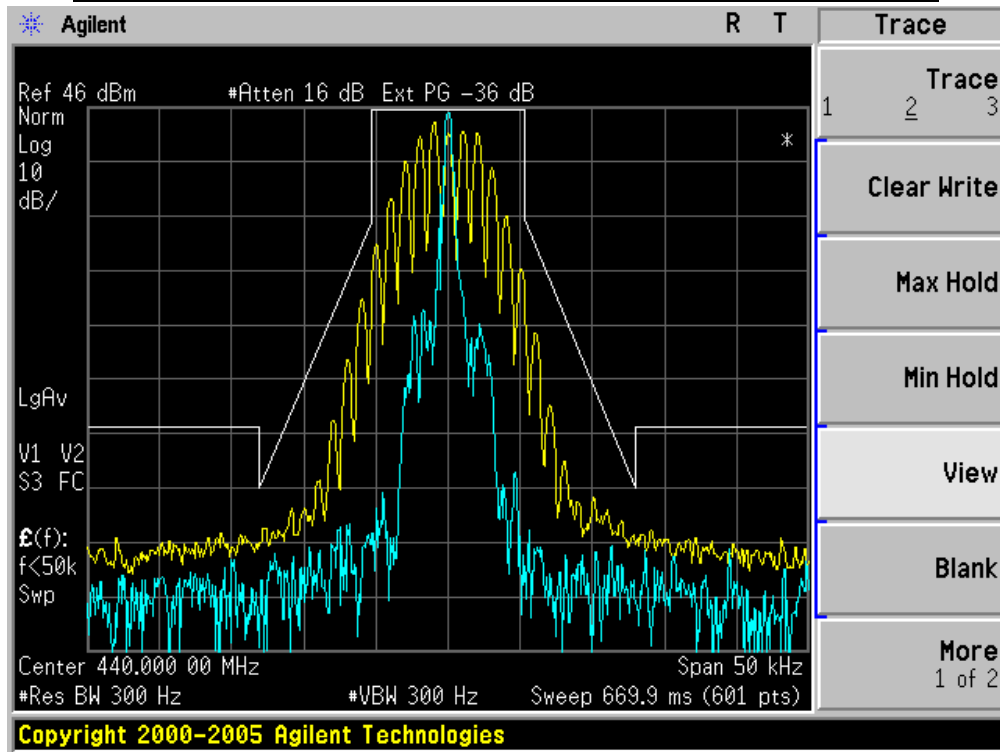

## 9. MODULATION CHARACTERISTICS

### 9.1 PROVISIONS APPLICABLE

According to CFR 47 section 2.1047(a), for Voice Modulation Communication Equipment, the frequency response of the audio modulation circuit over a range of 100 to 5000Hz shall be measured.

### 9.2 MEASUREMENT METHOD

#### 9.2.1 Modulation Limit

- (1). Configure the EUT as shown in figure 1, adjust the audio input for 60% of rated system deviation at 1KHz using this level as a reference (0dB) and vary the input level from -20 to +20dB. Record the frequency deviation obtained as a function of the input level.
- (2). Repeat step 1 with input frequency changing to 300, 1000, 1500 and 3000Hz in sequence.

#### 9.2.2 Audio Frequency Response

- (1). Configure the EUT as shown in figure 1.
- (2). Adjust the audio input for 20% of rated system deviation at 1 KHz using this level as a reference (0 dB).
- (3). Vary the Audio frequency from 100 Hz to 10 KHz and record the frequency deviation.
- (4). Audio Frequency Response =  $20\log_{10}(\text{Deviation of test frequency}/\text{Deviation of 1 KHz reference})$ .

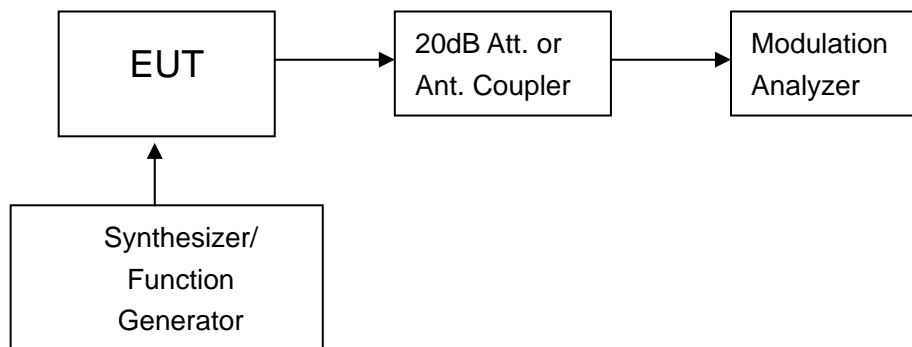

**Figure 1: Modulation characteristic measurement configuration**

### 9.3 MEASUREMENT INSTRUMENTS

NAME OF EQUIPMENT	MANUFACTURER	MODEL	SERIAL NUMBER	Cal. Date	Cal. Due
Modulation Analyzer	HP	8920B	3104A03367	07/18/2013	07/17/2014

NOTE: 8920B can generate audio modulation frequency.

**9.4 MEASUREMENT RESULT**

**(A). MODULATION LIMIT:**

**Middle Channel @ 12.5 KHz Channel Separations (VHF)**

Modulation Level (dB)	Peak Freq. Deviation At 300 Hz	Peak Freq. Deviation At 1000 Hz	Peak Freq. Deviation At 1500 Hz	Peak Freq. Deviation At 3000 Hz
-20	0.3	0.86	0.88	0.9
-15	0.35	0.97	0.99	1.07
-10	0.47	1.23	1.29	1.38
-5	0.54	1.35	1.42	1.46
0	0.67	1.51	1.54	1.58
+5	0.75	1.64	1.78	1.87
+10	0.88	1.76	1.80	1.85
+15	0.96	1.68	1.75	1.79
+20	0.89	1.55	1.65	1.8

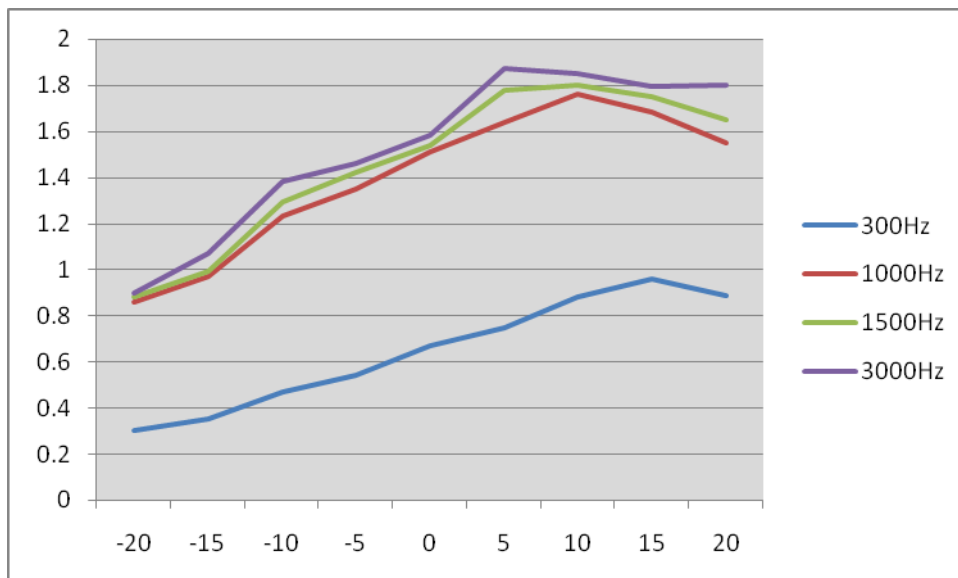

Note: All the modes had been tested, but only the worst data recorded in the report.

**(B). AUDIO FREQUENCY RESPONSE:**

**Middle Channel @ 12.5 KHz Channel Separations (VHF)**

Frequency (Hz)	Deviation (KHz)	Audio Frequency Response(dB)
100	--	--
200	--	--
300	0.19	-12.49
400	0.27	-9.43
500	0.39	-6.24
600	0.47	-4.62
700	0.55	-3.25
800	0.6	-2.50
900	0.7	-1.16
1000	0.82	0.21
1200	0.97	1.67
1400	1.26	3.95
1600	1.37	4.67
1800	1.43	5.04
2000	1.48	5.34
2400	1.53	5.63
2500	1.58	5.91
2800	1.61	6.07
3000	1.64	6.24
3200	1.48	5.34
3600	1.43	5.04
4000	1.17	3.30
4500	0.89	0.93
5000	0.64	-1.94
5500	0.44	-5.19
6000	0.33	-7.69
6500	0.22	-11.21
7000	0.14	-15.14
7500	0.1	-18.06
9000	--	--
10000	--	--
14000	--	--
18000	--	--
20000	--	--
30000	--	--

**Frequency Response of Middle Channel (VHF)**

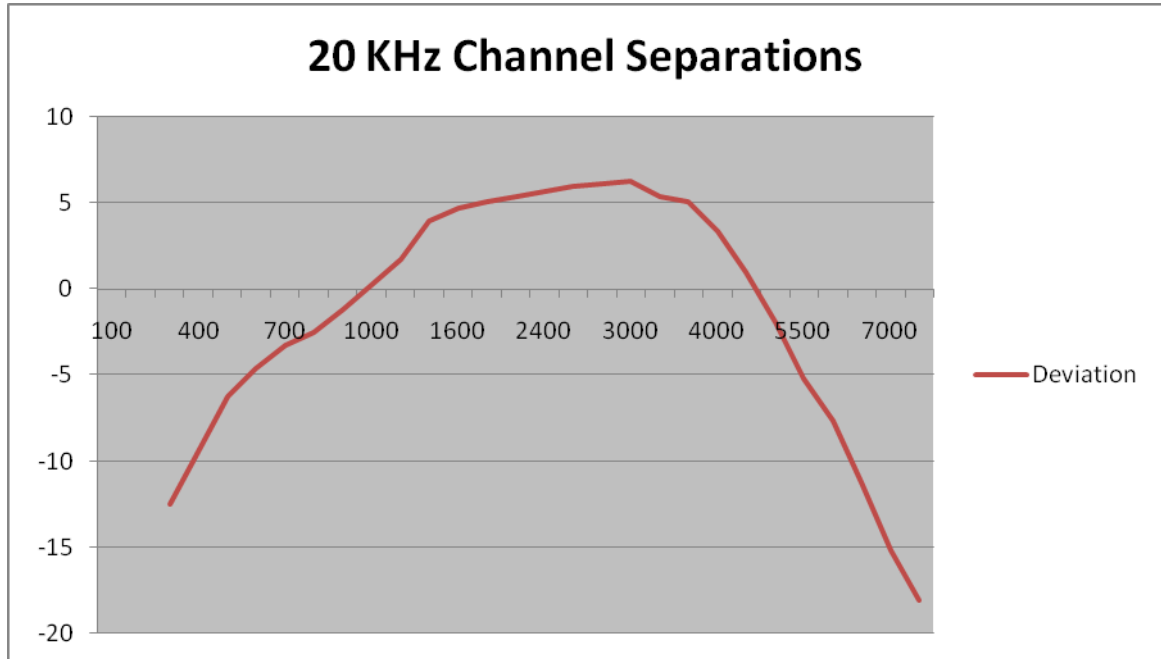

Note: All the modes had been tested, but only the worst data recorded in the report.

**10. MAXIMUM TRANSMITTER POWER (CONDUCTED OUTPUT POWER)**

**10.1 PROVISIONS APPLICABLE**

Per FCC §2.1046 and §90.205 AND RSS 119 Part 4.1: Maximum ERP is dependent upon the station’s antenna HAAT and required service area.

**10.2 TEST PROCEDURE**

The RF output of Two-way Radio was conducted to a spectrum analyzer through an appropriate attenuator.

**10.3 TEST INSTRUMENTS**

NAME OF EQUIPMENT	MANUFACTURER	MODEL	SERIAL NUMBER	Cal. Date	Cal. Due
SPECTRUM ANALYZER	AGILENT	E4440A	US44300399	07/18/2013	07/17/2014

**10.4 TEST CONFIGURATION**

Conducted Output Power:

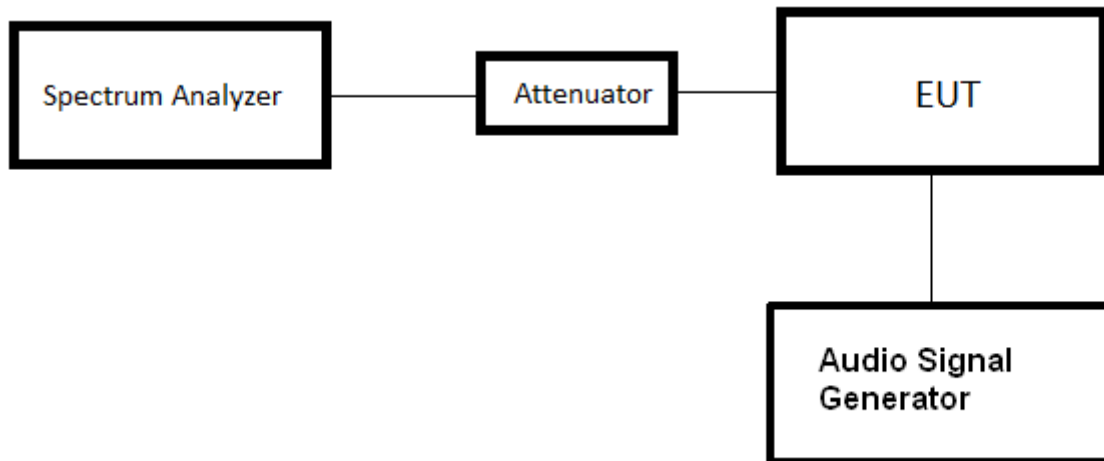

### Effective Radiated Power measurement Below 1GHz

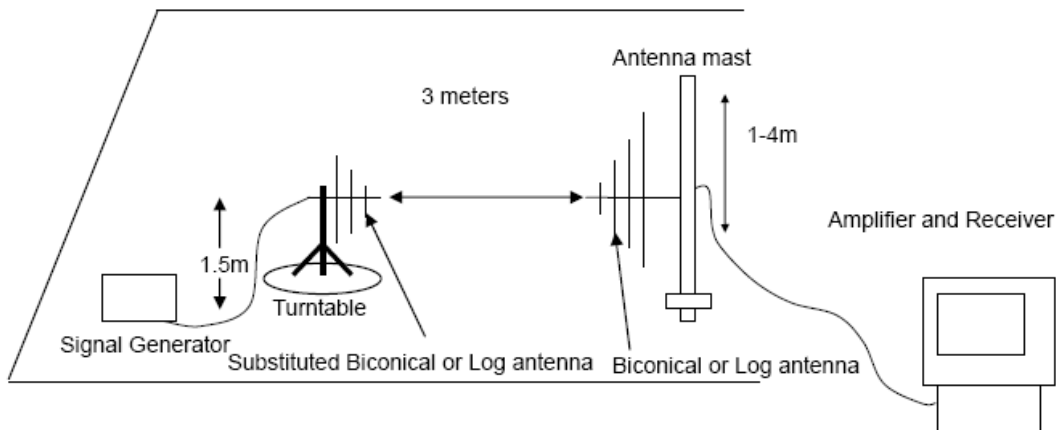
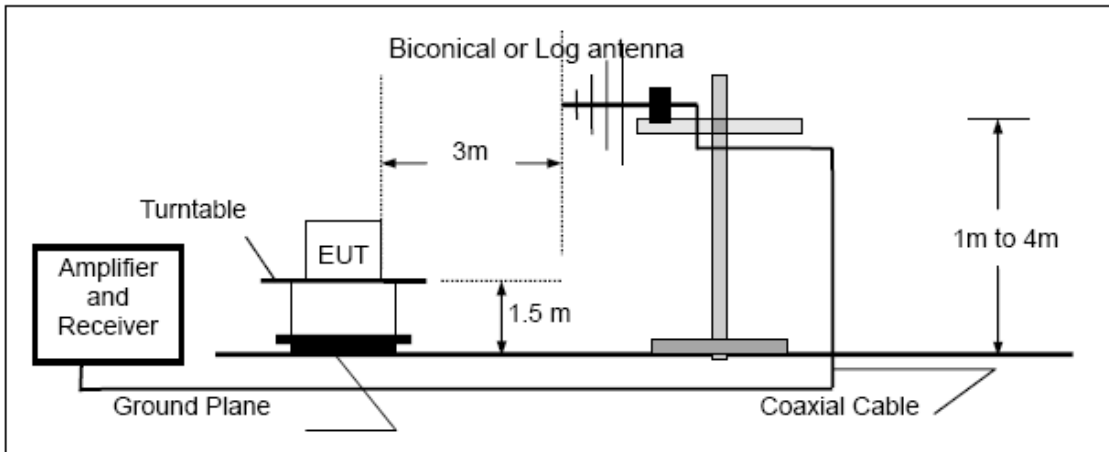

### Above 1GHz

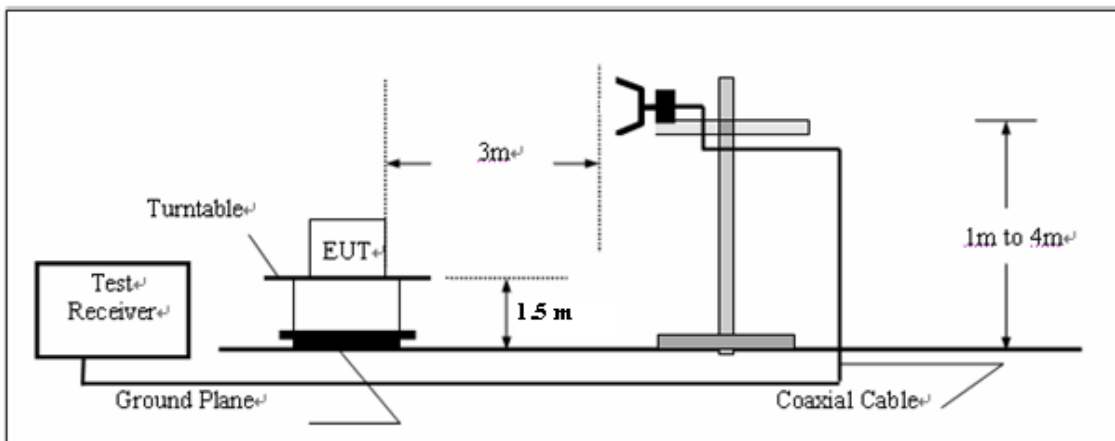

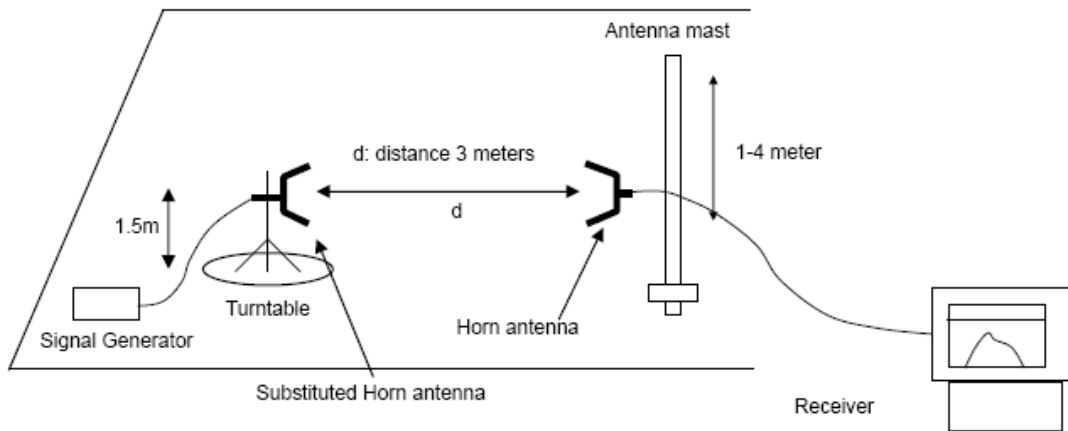

### 10.5 TEST RESULT

The maximum Conducted Power (CP) is  
60 W for 12.5 KHz Channel Separation

Calculation Formula:  $CP = R + A + L$

\* Note:

- CP: The final Conducted Power
- R : The reading value from spectrum analyzer
- A : The attenuation value of the used attenuator
- L : The loss of all connection cables

#### TEST RESULT FOR VHF

Conducted Power Measurement Results		
Channel Separation	Channel	Measurement Result (dBm)
		For 46.99dBm(50W)
12.5 KHz	Bottom(136.000MHz)	46.96
	Middle(155.000MHz)	46.98
	Top (174.000MHz)	46.95

#### TESTED RESULT FOR UHF

Conducted Power Measurement Results		
Channel Separation	Channel	Measurement Result (dBm)
		For 46.02dBm(40W)
12.5 KHz	Bottom(400.000MHz)	45.98
	Middle(440000MHz)	45.99
	Top (480.000MHz)	45.97

### 10.6 CONDUCT SPURIOUS PLOT



**TEST RESULT FOR VHF**

**Conducted Spurious Emission (worst) @ 155.000MHz With 12.5 KHz Channel Separation**

30MHz-1GHz

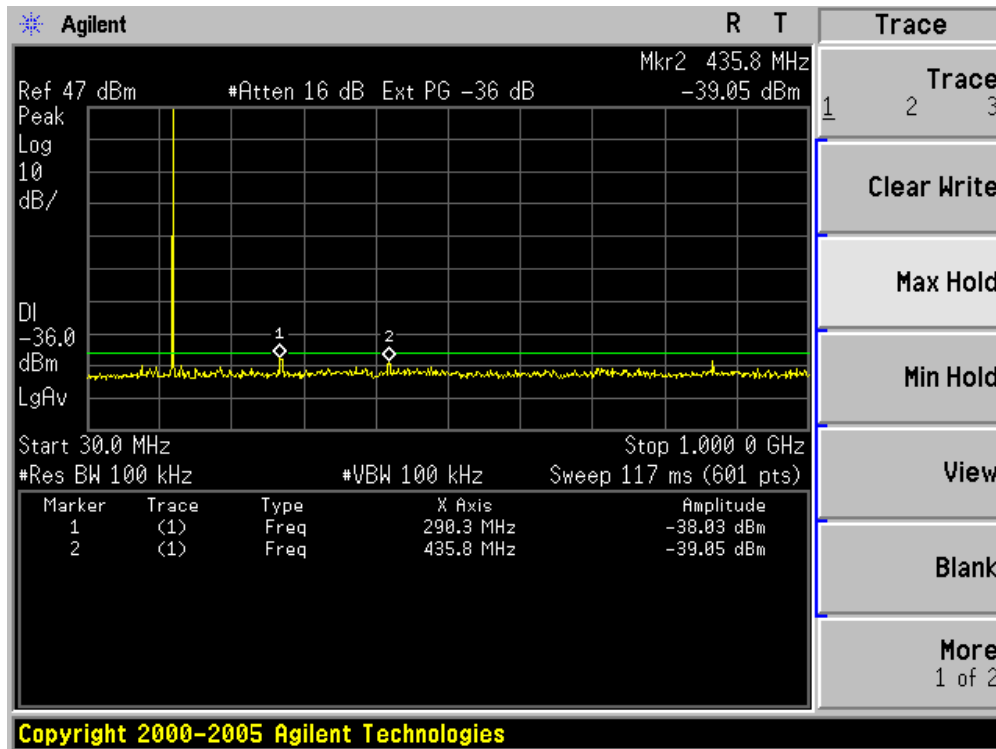

Copyright 2000-2005 Agilent Technologies

**Conduct Spurious Emission (worst) @ 155.000MHz With 12.5 KHz Channel Separation**

1GHz-12.75GHz

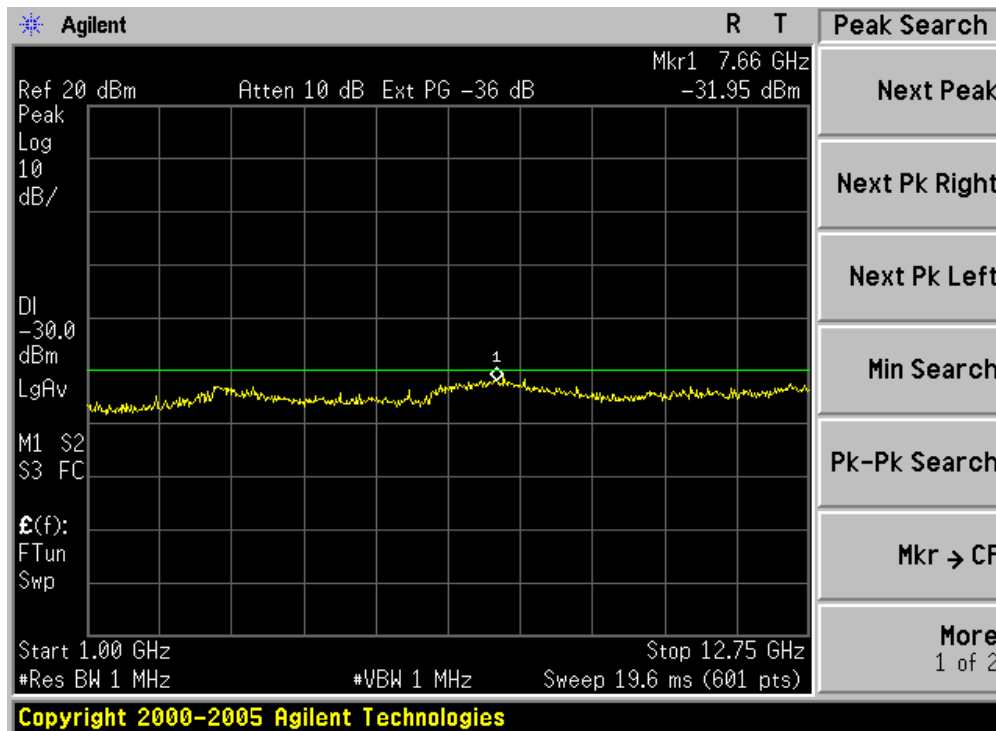

Copyright 2000-2005 Agilent Technologies

**TEST RESULT FOR UHF**

**Conducted Spurious Emission (worst) @ 440.000MHz With 12.5 KHz Channel Separation**

30MHz-1GHz

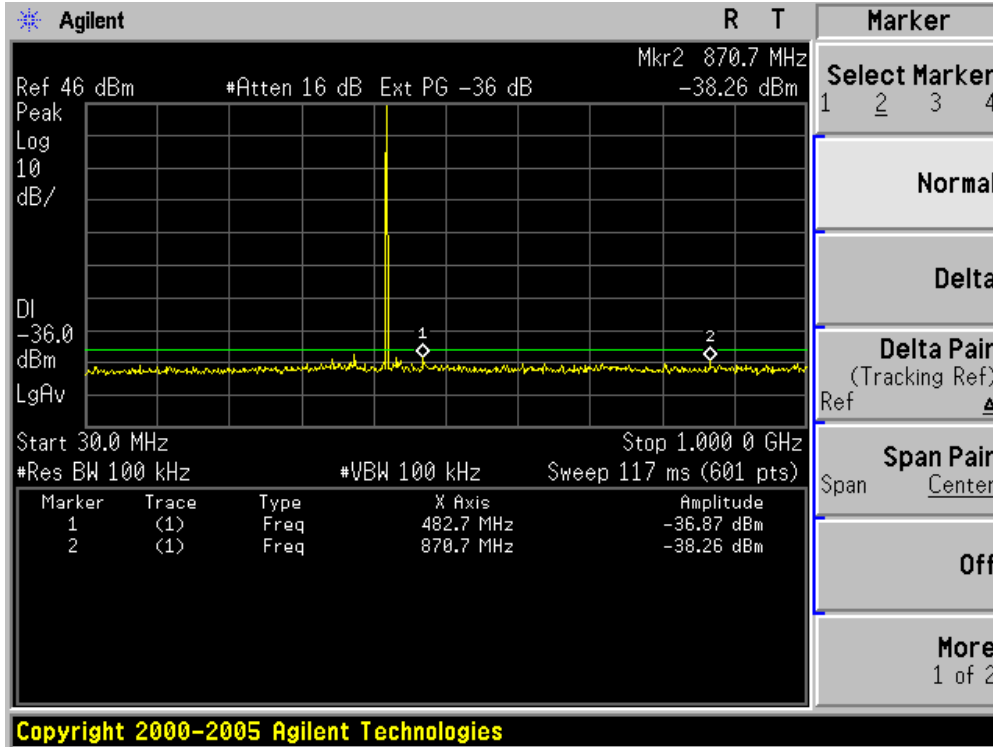

**Conduct Spurious Emission (worst) @ 440.000MHz With 12.5 KHz Channel Separation**

1GHz-12.75GHz

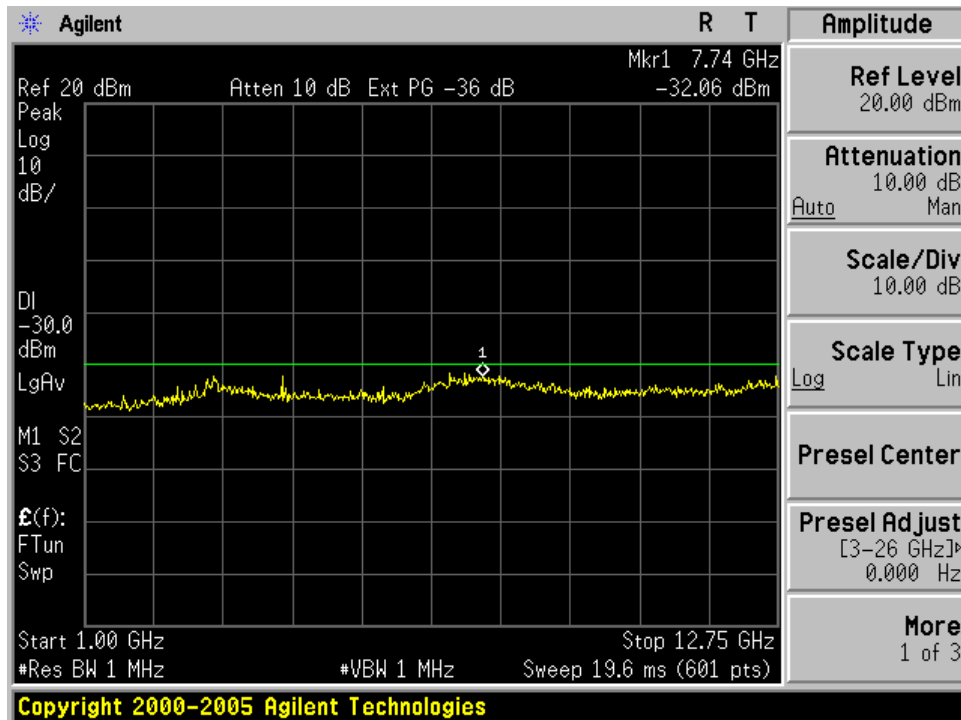

## 11. TRANSMITTER FREQUENCY BEHAVIOR

### 11.1 PROVISIONS APPLICABLE

Section 90.214

Time intervals <sup>1, 2</sup>	Maximum frequency difference <sup>3</sup>	All equipment	
		150 to 174 MHz	421 to 512 MHz
Transient Frequency Behavior for Equipment Designed to Operate on 25 kHz Channels			
t <sub>1</sub> <sup>4</sup> .....	± 25.0 kHz	5.0 ms	10.0 ms
t <sub>2</sub> .....	± 12.5 kHz	20.0 ms	25.0 ms
t <sub>3</sub> <sup>4</sup> .....	± 25.0 kHz	5.0 ms	10.0 ms
Transient Frequency Behavior for Equipment Designed to Operate on 12.5 kHz Channels			
t <sub>1</sub> <sup>4</sup> .....	± 12.5 kHz	5.0 ms	10.0 ms
t <sub>2</sub> .....	± 6.25 kHz	20.0 ms	25.0 ms
t <sub>3</sub> <sup>4</sup> .....	± 12.5 kHz	5.0 ms	10.0 ms
Transient Frequency Behavior for Equipment Designed to Operate on 6.25 kHz Channels			
t <sub>1</sub> <sup>4</sup> .....	± 6.25 kHz	5.0 ms	10.0 ms
t <sub>2</sub> .....	± 3.125 kHz	20.0 ms	25.0 ms
t <sub>3</sub> <sup>4</sup> .....	± 6.25 kHz	5.0 ms	10.0 ms

<sup>1</sup> t<sub>off</sub> is the instant when a 1 kHz test signal is completely suppressed, including any capture time due to phasing.

t<sub>1</sub> is the time period immediately following t<sub>off</sub>.

t<sub>2</sub> is the time period immediately following t<sub>1</sub>.

t<sub>3</sub> is the time period from the instant when the transmitter is turned off until t<sub>off</sub>.

t<sub>off</sub> is the instant when the 1 kHz test signal starts to rise.

<sup>2</sup> During the time from the end of t<sub>2</sub> to the beginning of t<sub>3</sub>, the frequency difference must not exceed the limits specified in §90.213.

<sup>3</sup> Difference between the actual transmitter frequency and the assigned transmitter frequency.

<sup>4</sup> If the transmitter carrier output power rating is 6 watts or less, the frequency difference during this time period may exceed the maximum frequency difference for this time period.

### 11.2 TEST METHOD

TIA/EIA-603 2.2.19

### 11.3 TEST INSTRUMENTS

NAME OF EQUIPMENT	MANUFACTURER	MODEL	SERIAL NUMBER	Cal. Date	Cal. Due
Signal Generator	AGILENT	E4412B	LR114196	05/29/2013	05/28/2014
Storage Oscilloscope	Tektronix	TDS3052	B017447	07/18/2013	07/17/2014

### 11.4 DESCRIBE LIMIT LINE OF TRANSMITTER FREQUENCY BEHAVIOR

**ton**: The switch-on instant of a transmitter is defined by the condition when the output power, measured at the antenna terminal, exceeds 0,1 % of the full output power (-30 dBc).

**t1**: period of time starting at ton and finishing according to above 11.1

**t2**: period of time starting at the end of t1 and finishing according to above 11.1

**toff**: switch-off instant defined by the condition when the output power falls below 0,1 % of the full output power (-30 dBc).

**t3**: period of time that finishing at toff and starting according to above 11.1

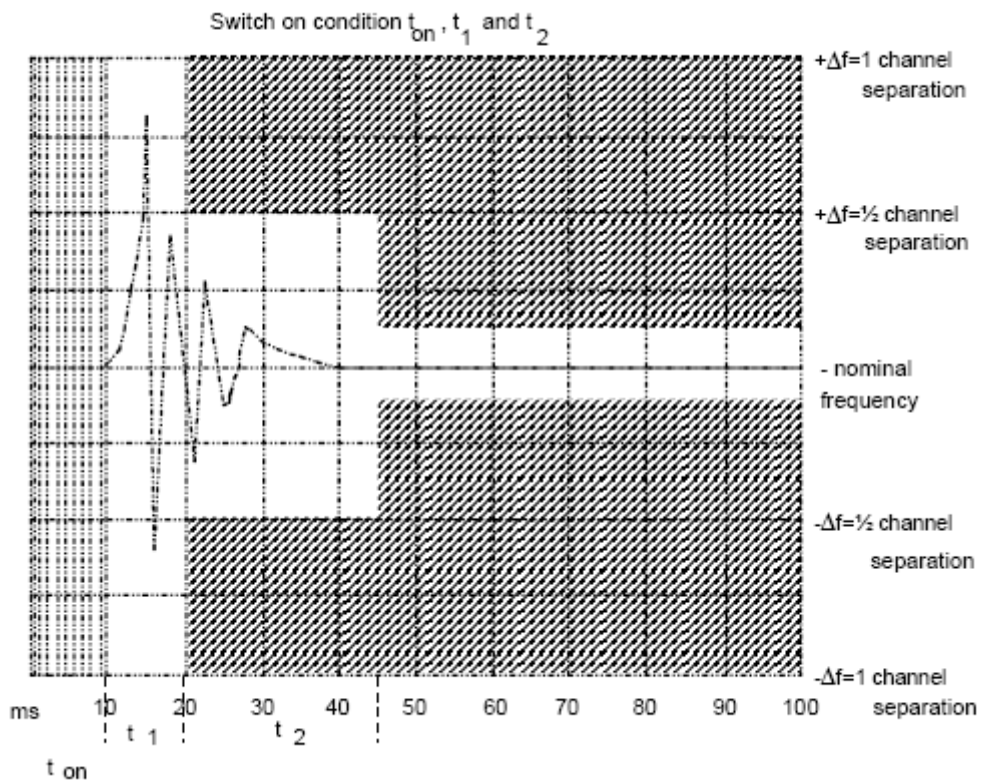

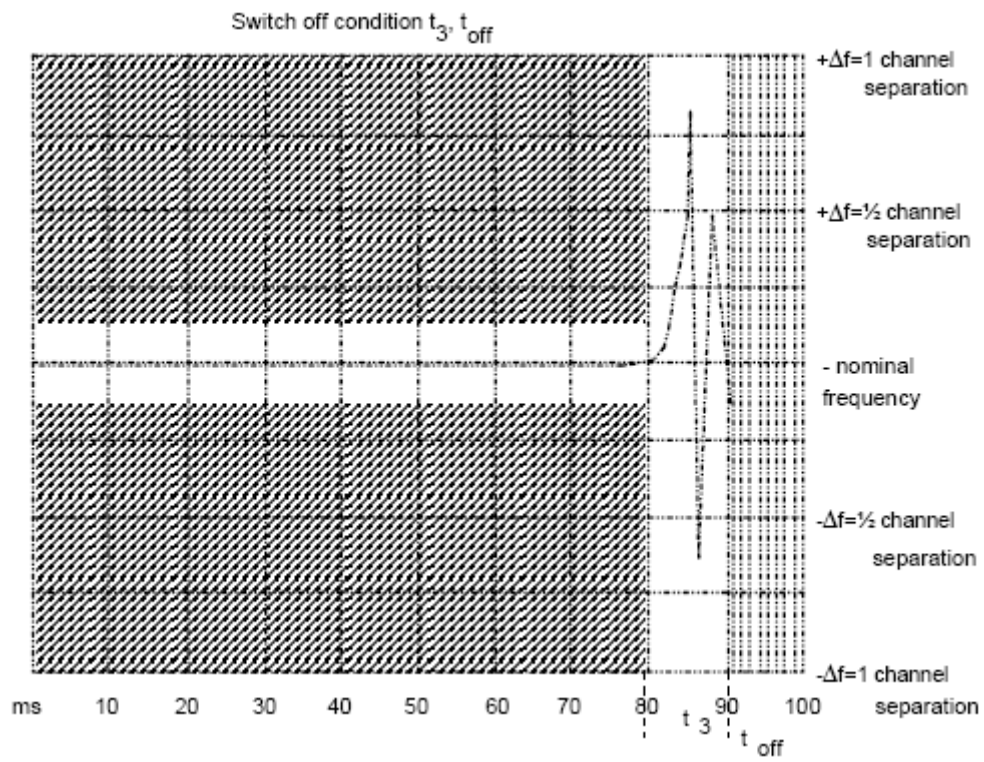

### 11.5 MEASURE RESULT

#### VHF TEST RESULTS

Transmitter Frequency Behaviour @ 12.5 KHz Channel Separation--Off to On

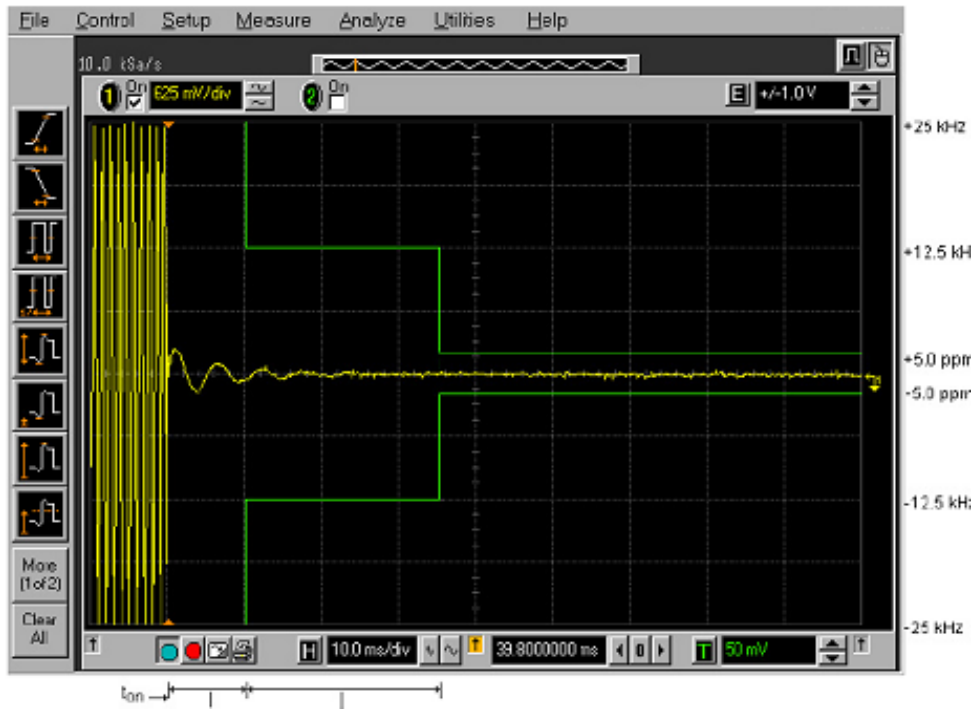

Transmitter Frequency Behaviour @ 12.5 KHz Channel Separation--On to Off

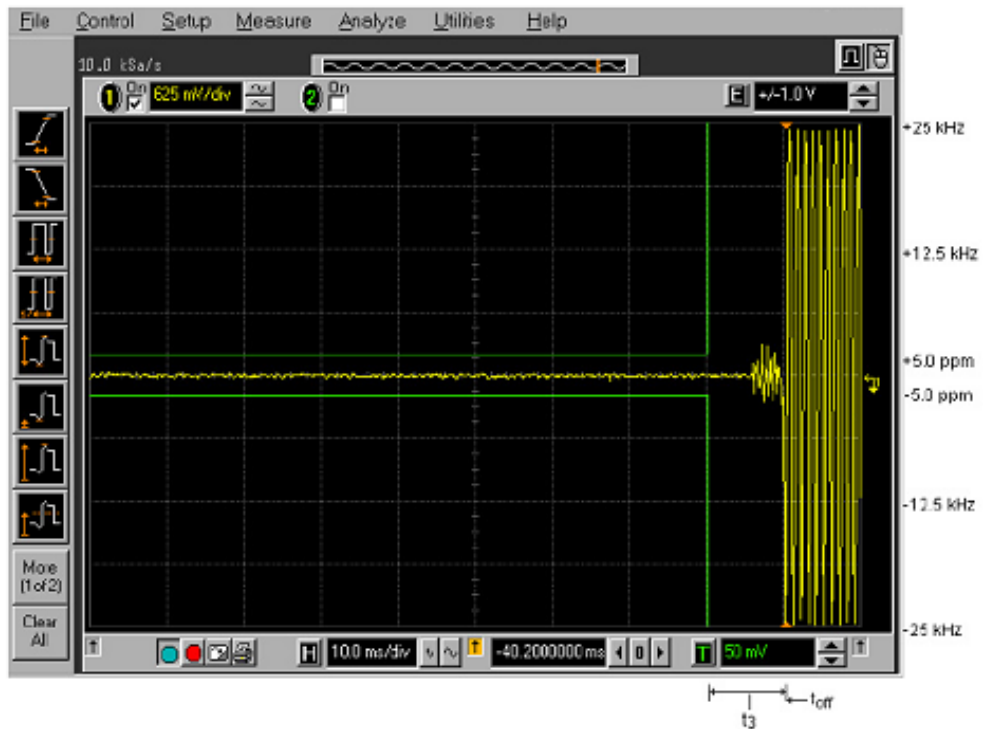

### UHF TEST RESULTS

Transmitter Frequency Behaviour @ 12.5 KHz Channel Separation--Off to On

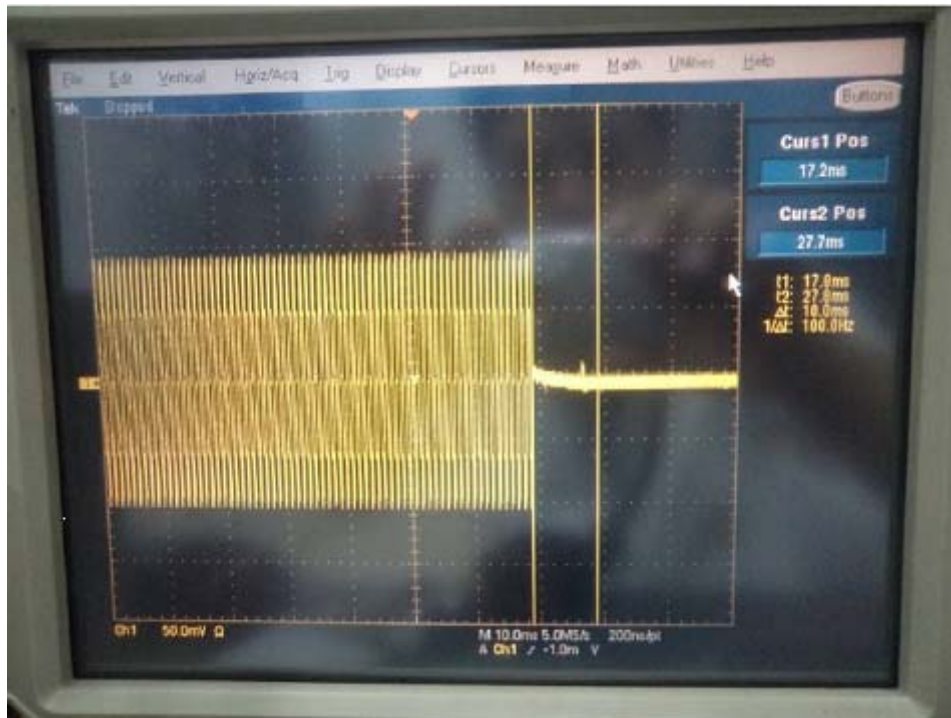

Transmitter Frequency Behaviour @ 12.5 KHz Channel Separation--On to Off

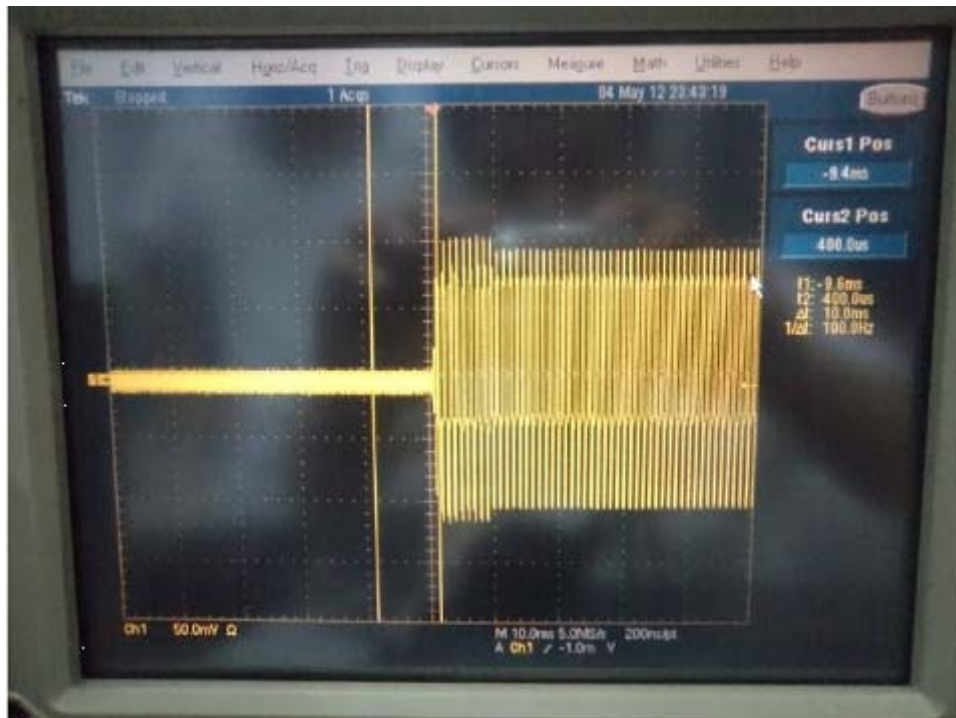

## 12. RADIATED EMISSION ON RECEIVING MODE

### 12.1 PROVISIONS APPLICABLE

FCC Part 15 Subpart B Section 15.109

RSS-Gen Subpart B Section RSS-Gen.6.1

### 12.2 TEST METHOD

ANSI C 63.4: 2003

### 12.3 TEST INSTRUMENTS

NAME OF EQUIPMENT	MANUFACTURER	MODEL	SERIAL NUMBER	Cal. Date	Cal. Due
SPECTRUM ANALYZER	AGILENT	E4440A	US44300399	07/18/2013	07/17/2014
HORN ANT.	EM	EM-AH-10180	100150	07/18/2013	07/17/2014
BROADBAND ANT.	A.H.	SAS-521-4	A0304224	07/18/2013	07/17/2014
AMPLIFIER	EM	EM30180	0607030	07/18/2013	07/17/2014
POSITIONING CONTROLLER	MF	MF-7802	MF780208147	--	--



**12.4 MEASURE RESULT (MEASURED AT 3M USING FCC PART15 B LIMITS)**  
**RADIATED EMISSION TEST RESULTS – HORIZONTAL**

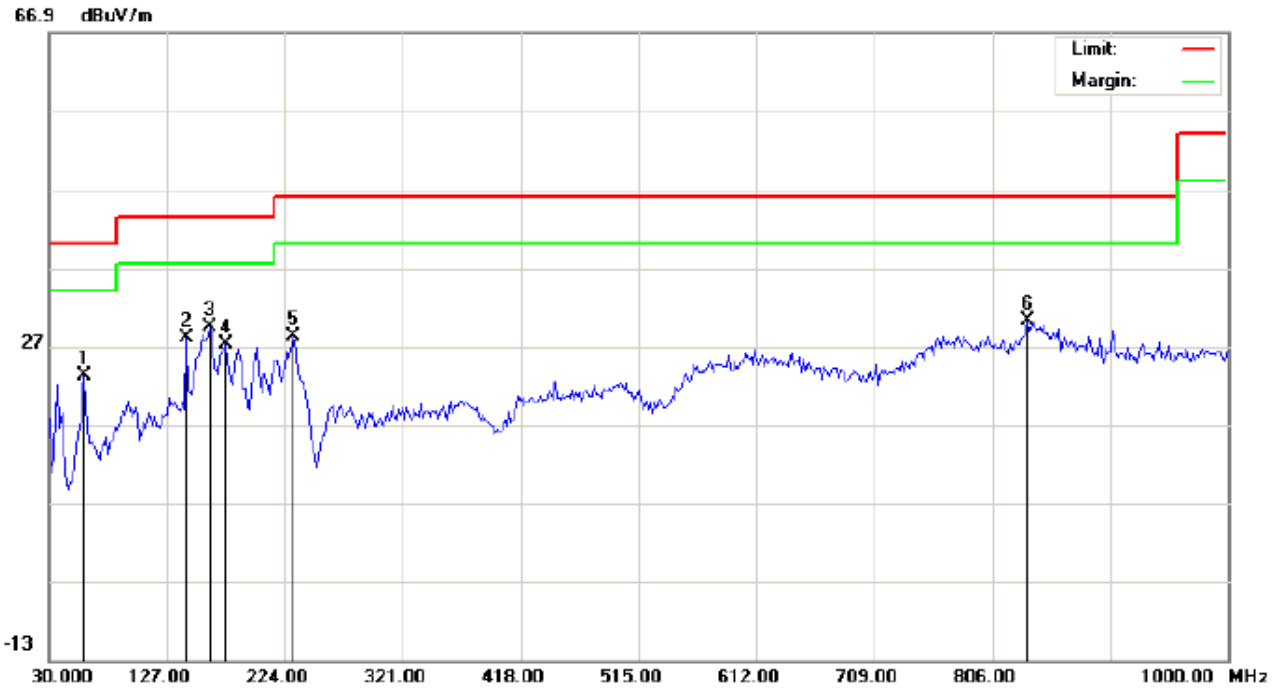

Site: site #1	Polarization: <i>Horizontal</i>	Temperature: 26
Limit: FCC Class B 3M Radiation	Power:	Humidity: 60 %
EUT: VHF/UHF FM MOBILE TRANSCEIVER	Distance: 3m	
M/N: DR-638		
Mode: Mode 1		
Note:		

No.	Mk	Freq.	Reading	Factor	Measurement	Limit	Over	Detector	Antenna	Table	Comment
		MHz	dBuV	dB/m	dBuV/m	dBuV/m	dB		Height	Degree	
									cm	degree	
1		59.1000	19.67	3.63	23.30	40.00	-16.70	peak			
2		143.1665	15.19	12.76	27.95	43.50	-15.55	peak			
3	*	162.5664	16.16	13.20	29.36	43.50	-14.14	peak			
4		175.5000	15.63	11.61	27.24	43.50	-16.26	peak			
5		230.4667	15.79	12.49	28.28	46.00	-17.72	peak			
6		835.1000	-0.40	30.55	30.15	46.00	-15.85	peak			

RADIATED EMISSION TEST RESULTS – VERTICAL

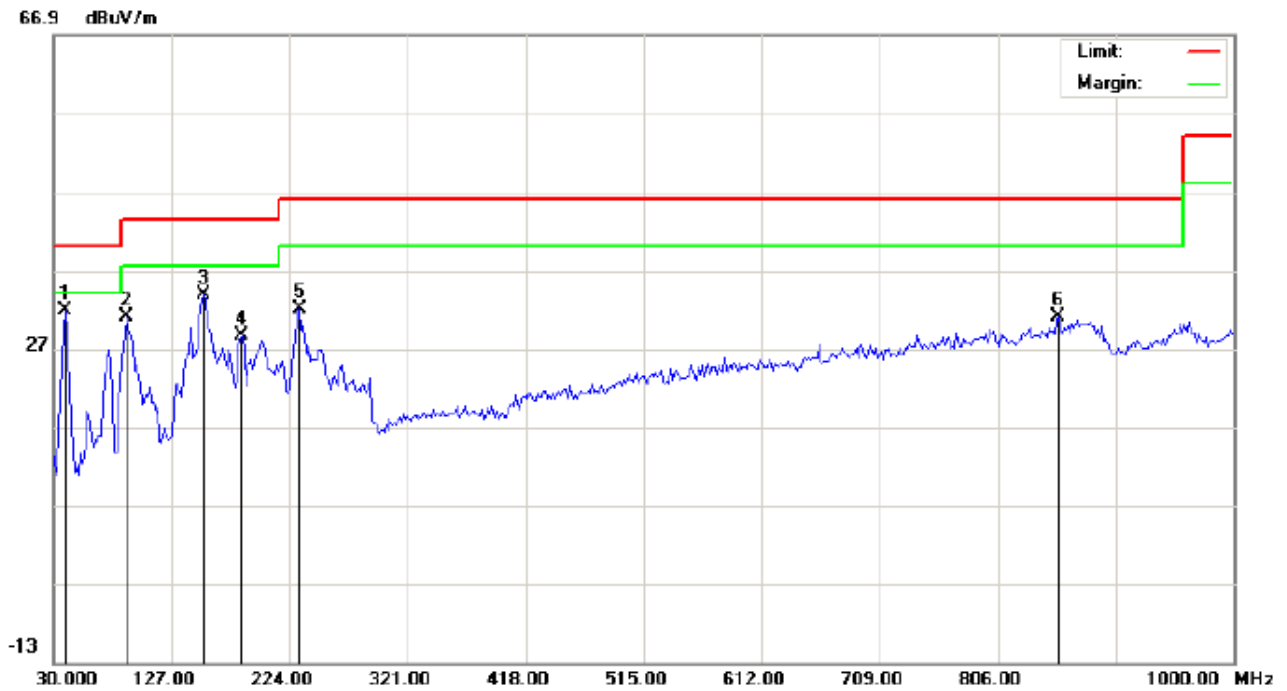

Site: site #1  
Limit: FCC Class B 3M Radiation  
EUT: VHF/UHF FM MOBILE TRANSCEIVER  
M/N: DR-638  
Mode: Mode 1  
Note:

Polarization: *Vertical*  
Power:  
Distance: 3m

Temperature: 26  
Humidity: 60 %

No.	Mk	Freq.	Reading	Factor	Measurement	Limit	Over	Detector	Antenna Height	Table Degree	Comment
		MHz	dBuV	dB/m	dBuV/m	dBuV/m	dB		cm	degree	
1	*	39.7000	23.97	7.76	31.73	40.00	-8.27	peak			
2		89.8164	22.56	8.36	30.92	43.50	-12.58	peak			
3		152.8667	20.97	12.93	33.90	43.50	-9.60	peak			
4		185.1999	19.97	8.64	28.61	43.50	-14.89	peak			
5		232.0833	22.27	9.80	32.07	46.00	-13.93	peak			
6		856.1167	1.90	29.05	30.95	46.00	-15.05	peak			

### 13. AUDIO LOW PASS FILTER RESPONSE

#### 13.1 LIMITS

**2.1047(a):** Voice modulated communication equipment. A curve or equivalent data showing the frequency response of the audio modulating circuit over a range of 100 to 5000 Hz shall be submitted. For equipment required to have an audio low-pass filter, a curve showing the frequency response of the filter or of all circuitry installed between the modulation limiter and the modulated stage shall be submitted.

**90.242(b)(8):** Recommended audio filter attenuation characteristics are given below:

Audio band	Minimum Attenuation Rel. to 1 KHz Attenuation
3 –20 KHz	$60 \log_{10}(f/3)$ dB where f is in KHz
20 – 30 KHz	50dB

#### 13.2. METHOD OF MEASUREMENTS

The rated audio input signal was applied to the input of the audio low-pass filter (or of all modulation stages) using an audio oscillator, this input signal level and its corresponding output signal were then measured and recorded using the FFT Digital Spectrum Analyzer. Tests were repeated at different audio signal frequencies from 0 to 50 KHz.

**13.3 TEST DATA**

**12.5 KHZ CHANNEL SPACING, F3E, FREQUENCY OF ALL MODULATION STATES**

Frequency (KHz)	Audio In (dBV)	Audio out (dBV)	Attenuation (Out_In) dB	Attenuation Rel.to 3 KHz (dB)	Recommended Attenuation (dB)
0.1	-76.18	-31.22	46.37	-36.54	
0.2	-76.18	-17.37	58.24	-25.64	
0.4	-76.18	-6.29	71.64	-12.84	
0.6	-76.18	0.4	74.24	-6.44	
0.8	-76.18	4.16	78.94	-2.94	
1.0	-76.18	7.19	83.64	-0.04	
1.5	-76.18	8.26	84.84	2.16	
2.0	-76.18	8.99	85.34	1.56	
2.5	-76.18	7.51	83.84	0.66	
3.0	-76.18	6.26	82.54	-1.84	0
3.5	-76.18	2.62	78.44	-4.94	-4
4.0	-76.18	-2.4	74.64	-9.44	-7
4.5	-76.18	-9.22	68.24	-16.54	-12
5.0	-76.18	-15.18	60.64	-21.74	-15
6.0	-76.18	-21.24	54.14	-28.64	-18
7.0	-76.18	-31.62	46.24	-36.44	-22
8.0	-76.18	-39.23	37.94	-47.64	-26
9.0	-76.18	-61.96	15.14	-66.94	-28
10.0	-76.18	-61.96	15.14	-66.44	-31
12.0	-76.18	-61.96	15.14	-66.44	-37
14.0	-76.18	-61.96	15.14	-66.44	-40
16.0	-76.18	-61.96	15.14	-66.44	-44
18.0	-76.18	-61.96	15.14	-66.44	-47
20.0	-76.18	-61.96	15.14	-66.44	-49
25.0	-76.18	-61.96	15.14	-66.44	-49
30.0	-76.18	-61.96	15.14	-66.44	-49
35.0	-76.18	-61.96	15.14	-66.44	-49
40.0	-76.18	-61.96	15.14	-66.44	-49
45.0	-76.18	-61.96	15.14	-66.44	-49
50.0	-76.18	-61.96	15.14	-66.44	-49

**Note:** Due to the difficulty of measuring the Frequency Response of the internal low-pass filter, the Frequency Response of All Modulation States is performed to show the roll-off at 3 KHz in comparison with the recommended audio filter attenuation.

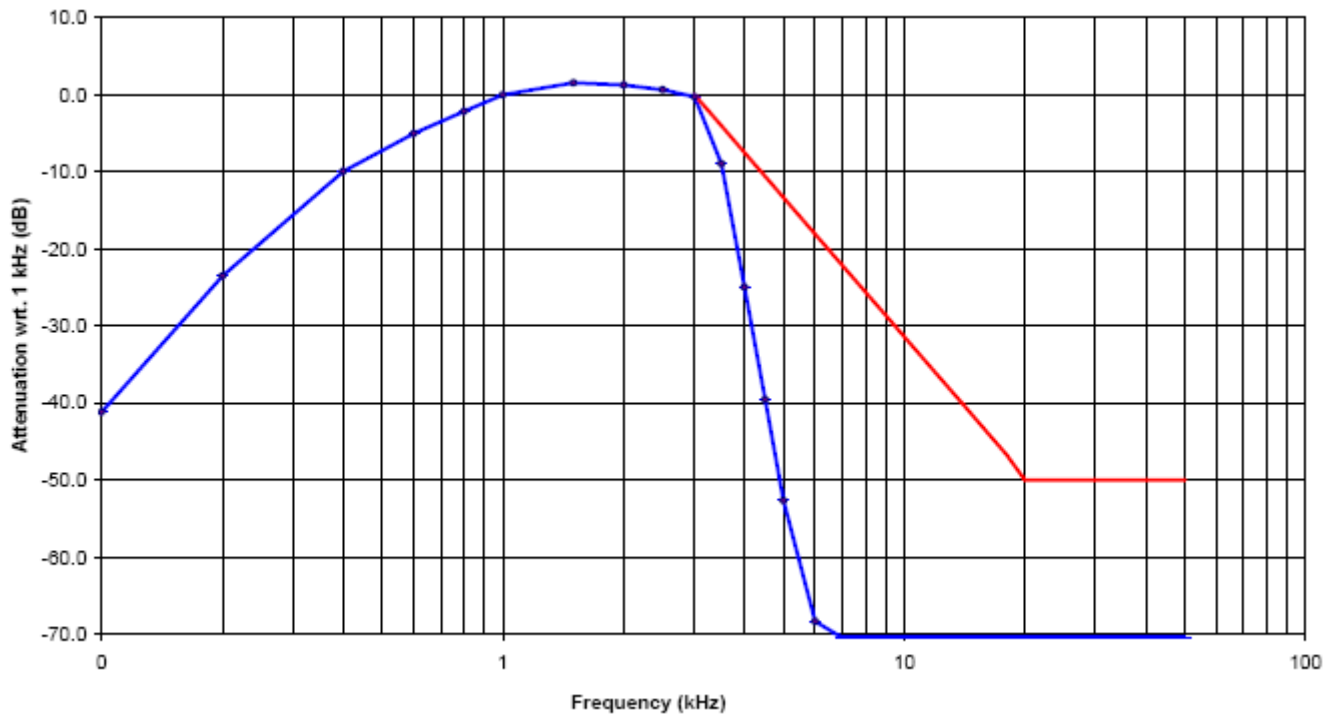

**APPENDIX I**  
**PHOTOGRAPHS OF SETUP**  
RADIATED TEST SETUP

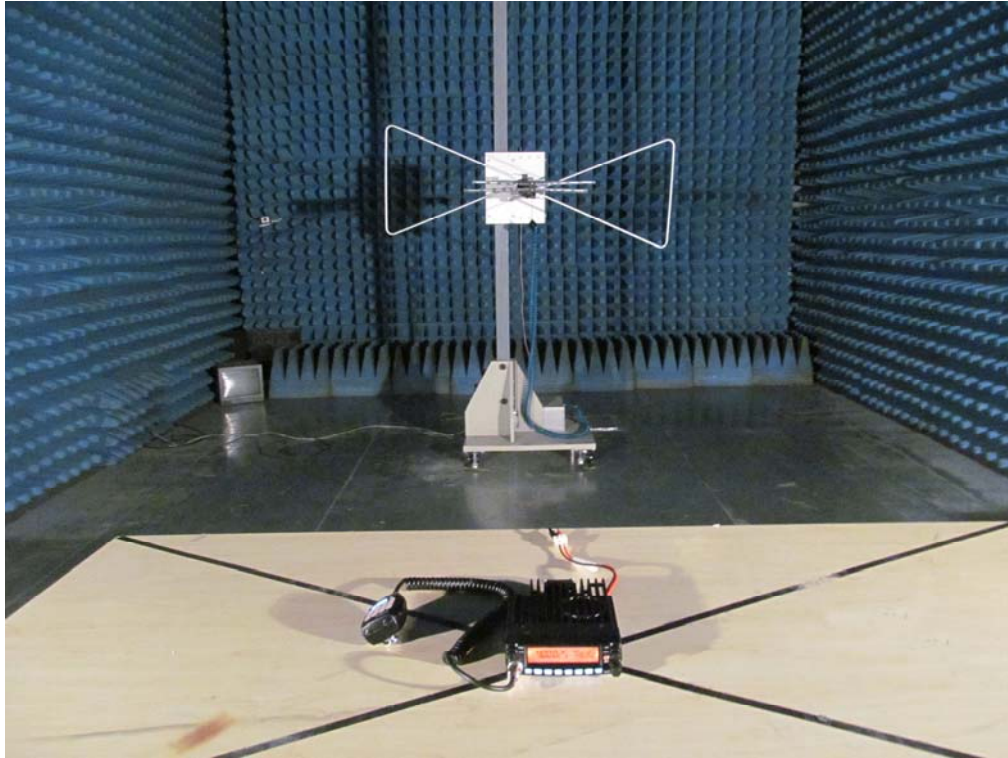

**APPENDIX II**  
**EXTERNAL VIEW OF EUT**  
TOTAL VIEW OF EUT



**TOP VIEW OF EUT**



BOTTOM VIEW OF EUT

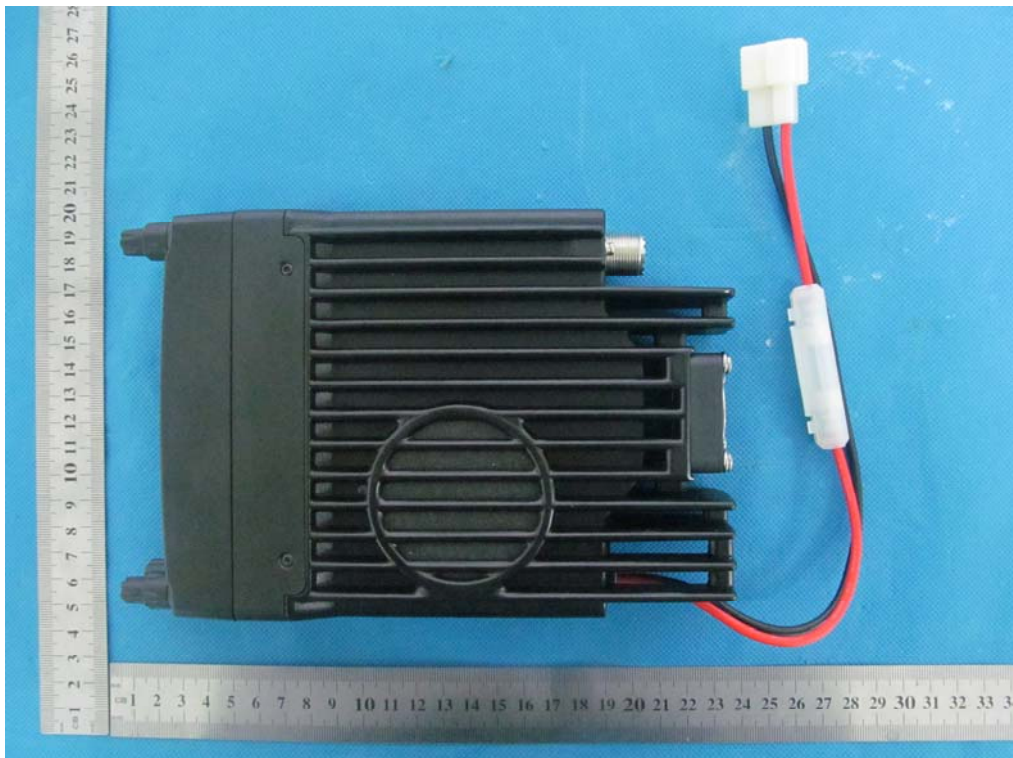

FRONT VIEW OF EUT





BACK VIEW OF EUT



LEFT VIEW OF EUT



RIGHT VIEW OF EUT



OPEN VIEW-1 OF EUT



OPEN VIEW-2 OF EUT

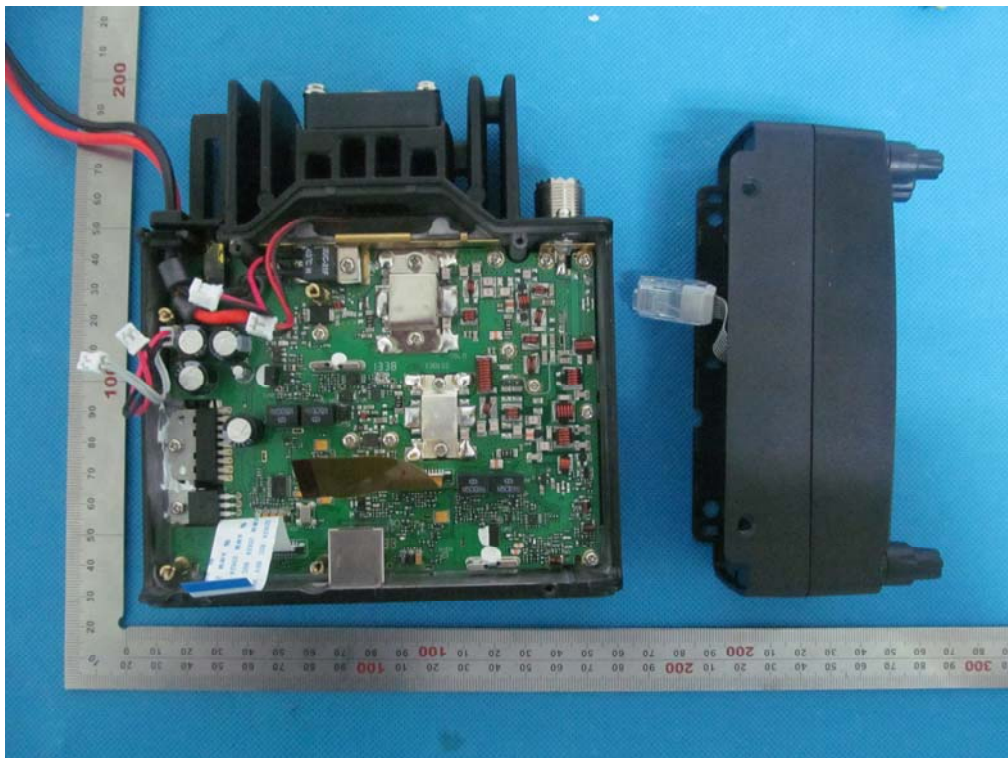

INTERNAL VIEW-1 OF EUT

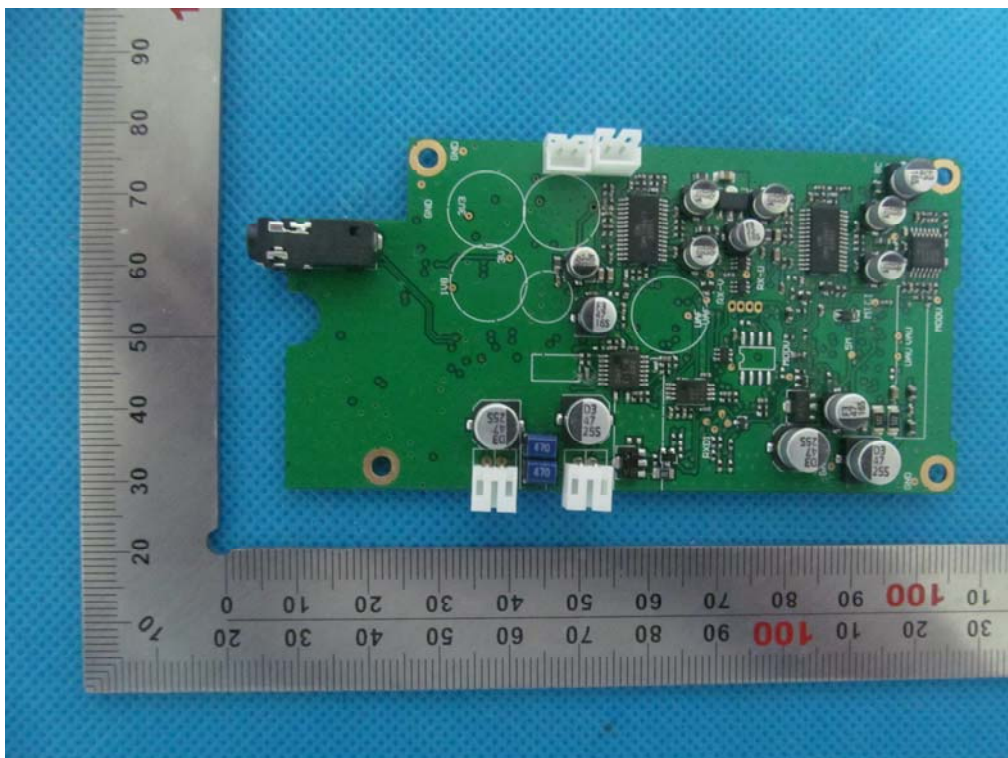

INTERNAL VIEW-2 OF EUT

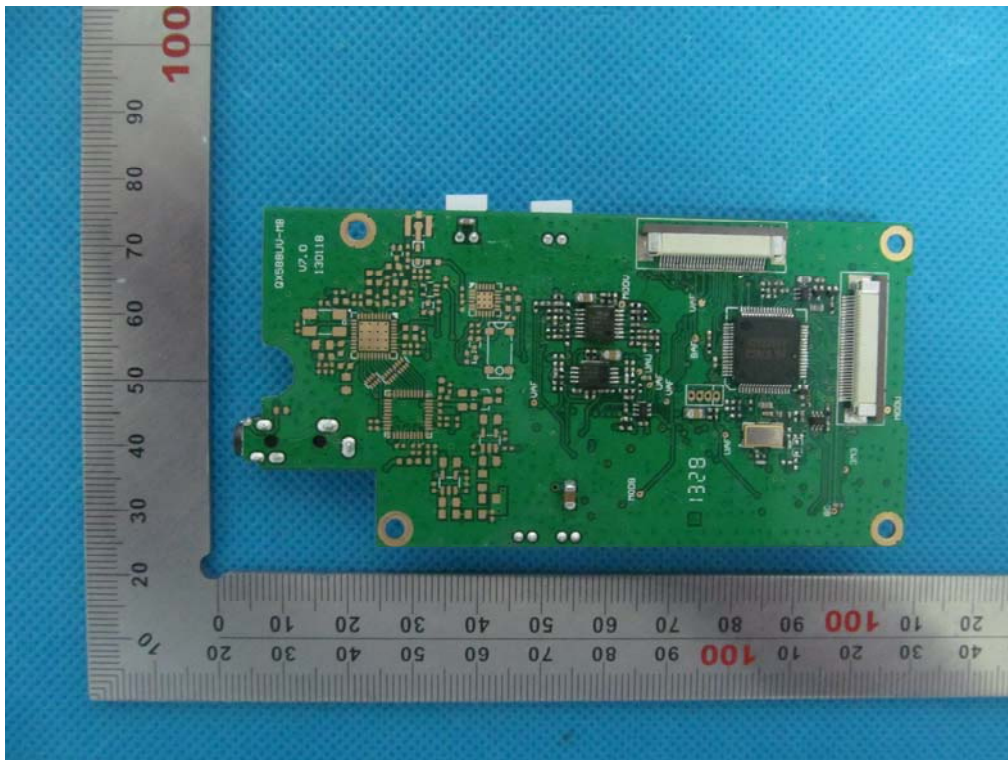

INTERNAL VIEW-3 OF EUT

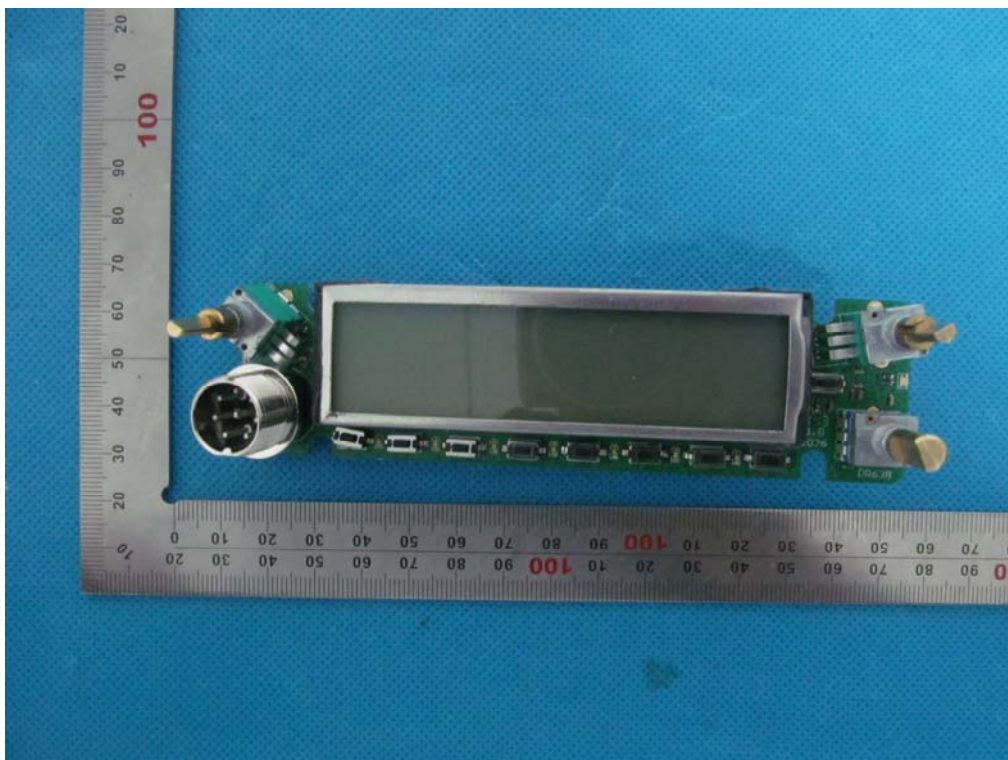

INTERNAL VIEW-4 OF EUT

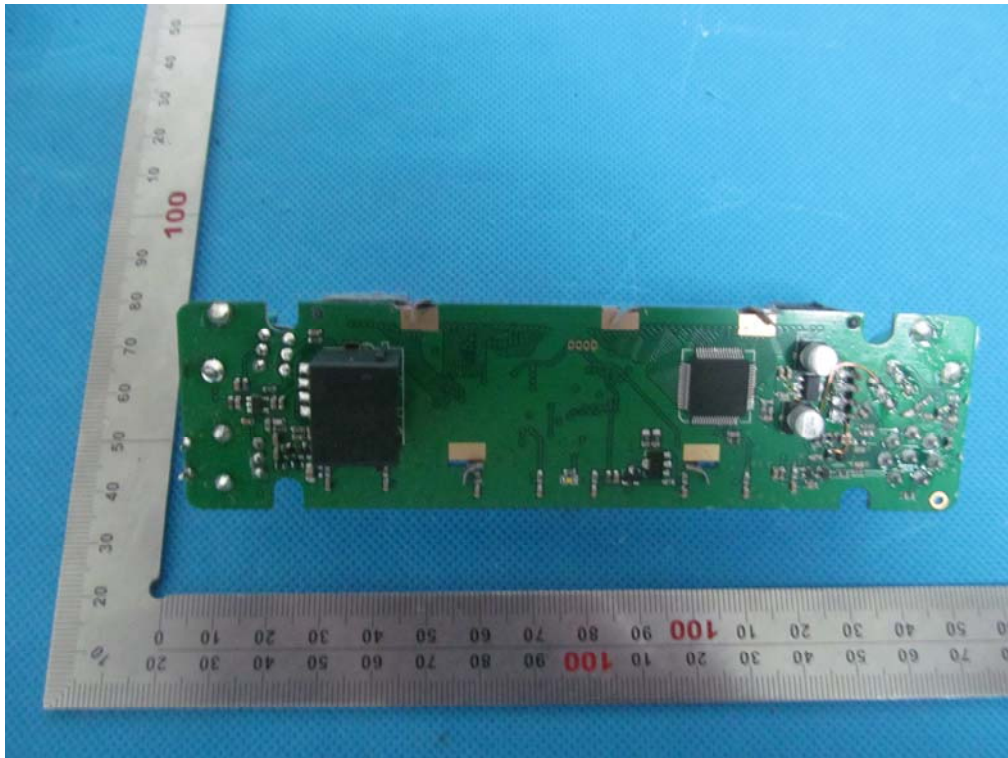

INTERNAL VIEW-5 OF EUT

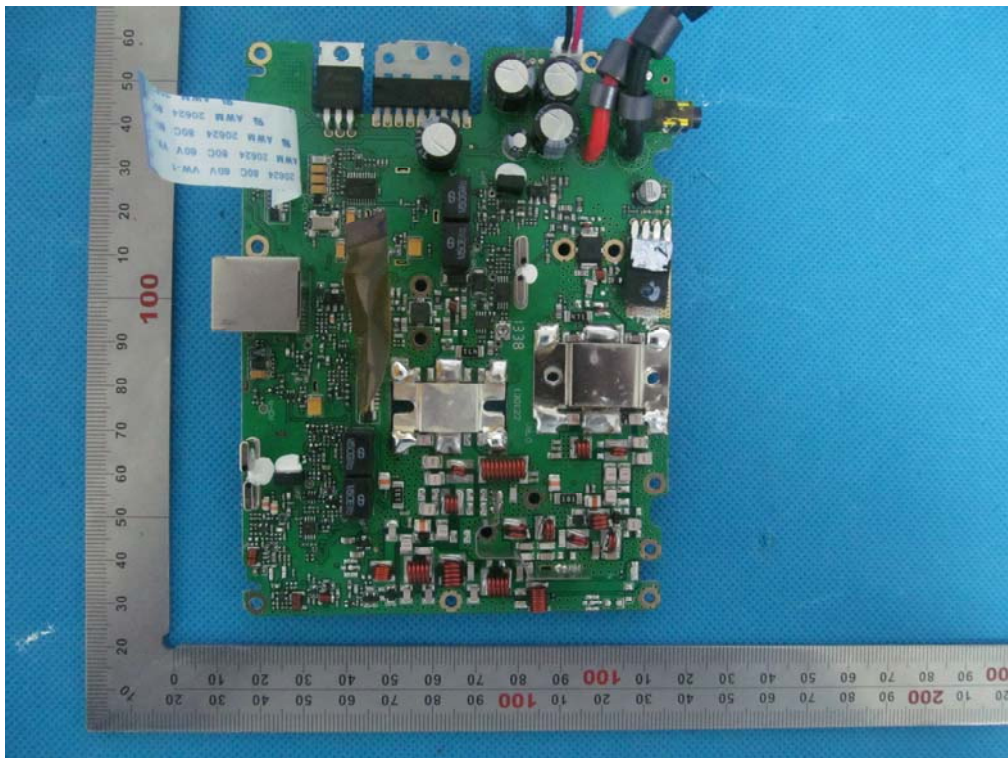

INTERNAL VIEW-6 OF EUT

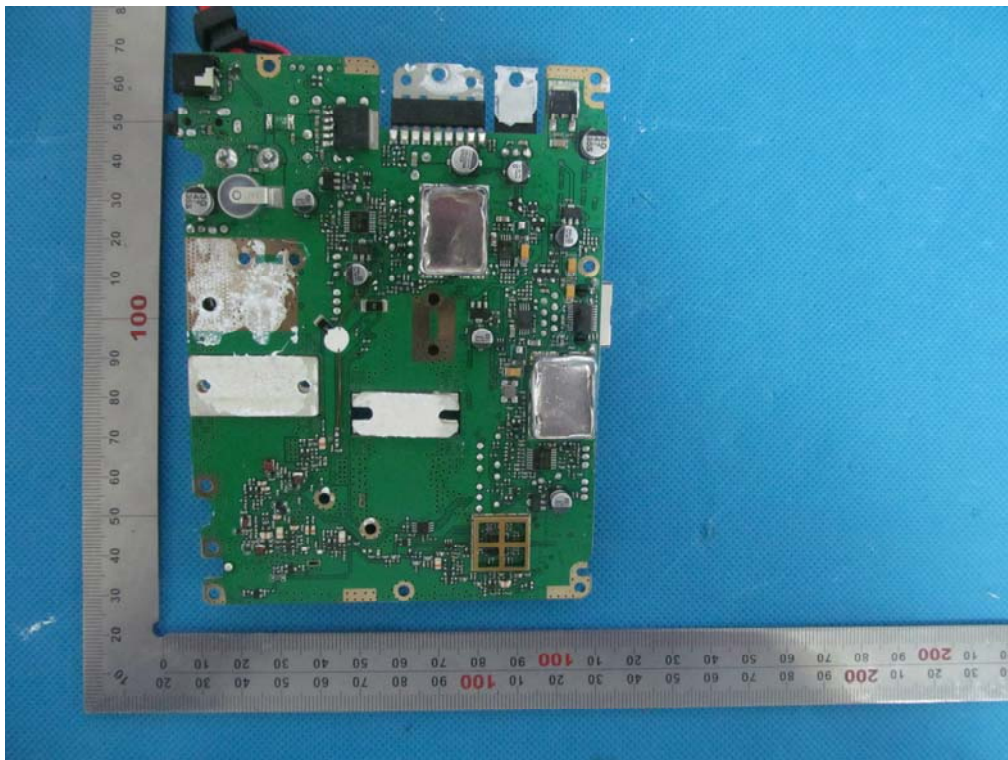

INTERNAL VIEW-7 OF EUT



INTERNAL VIEW-8 OF EUT

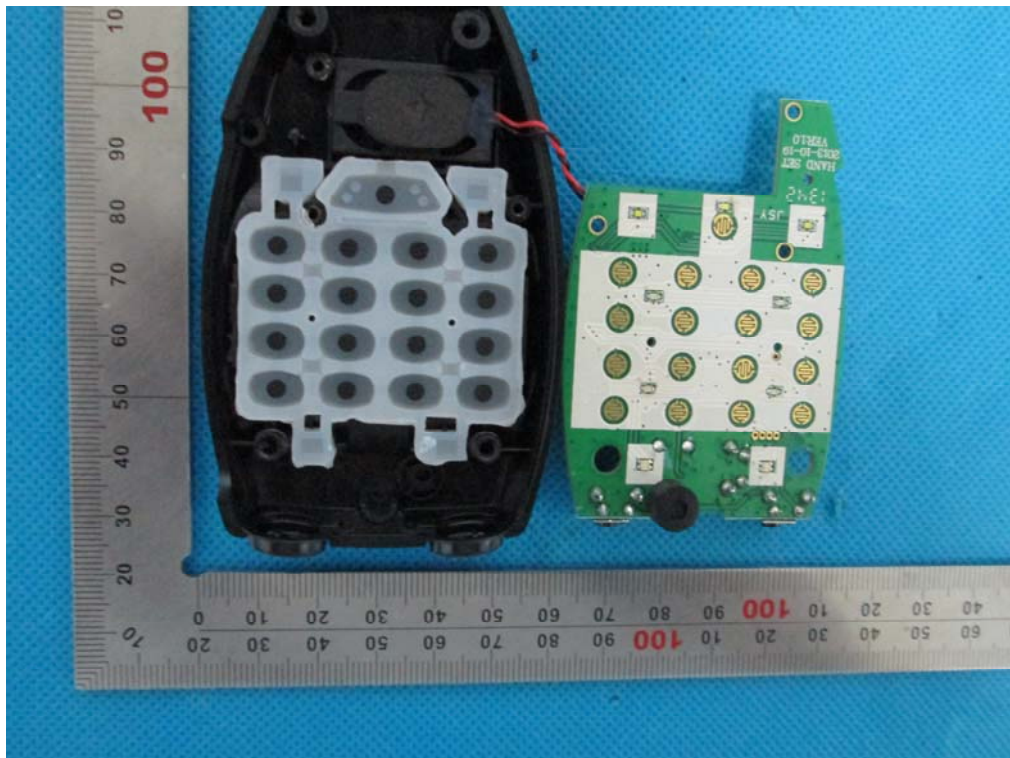

INTERNAL VIEW-9 OF EUT

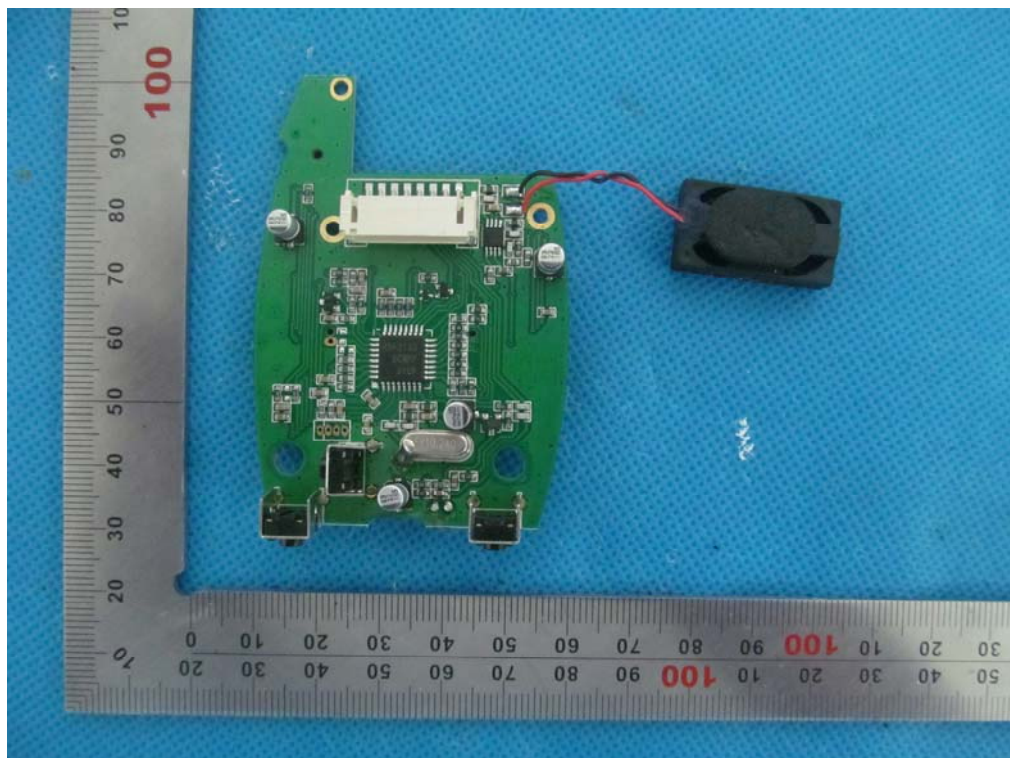

INTERNAL VIEW-10 OF EUT

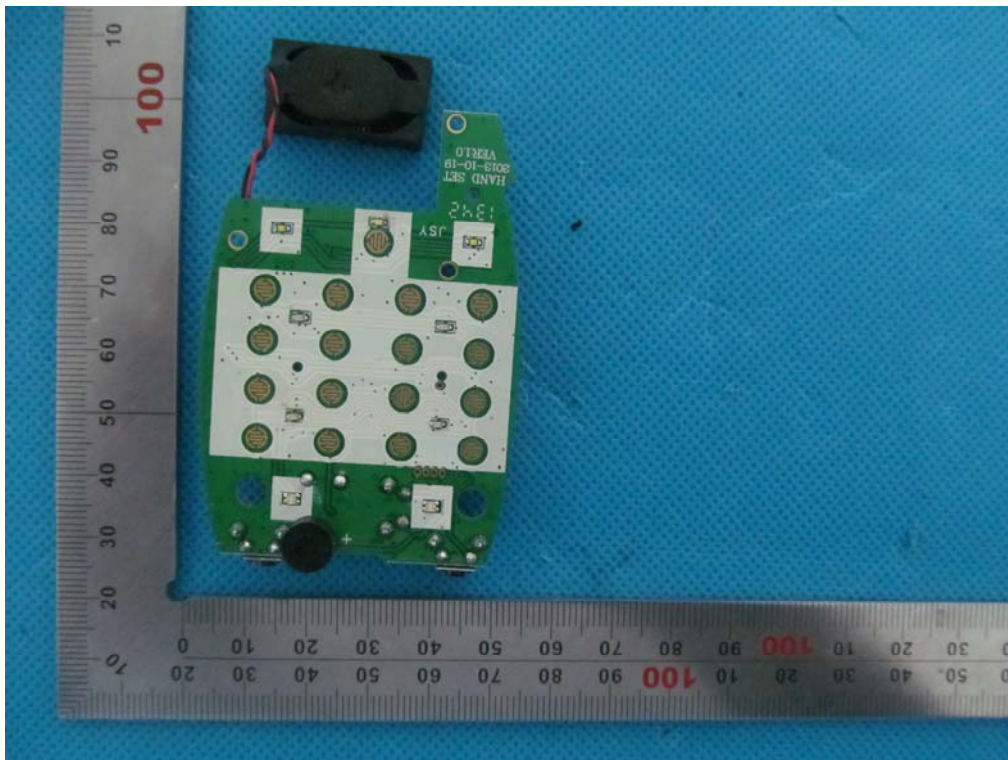

-----END OF REPORT-----