

UHF FM MOBILE TRANSCEIVER

User Manual

Model name: DR-438

Brand name: plum

FCC ID:PH3-DR438H

IC:3070C-DR438H

ALINCO, INC.

Yodoyabashi Dai-bldg 13F

4-4-9 Koraibashi, Chuo-ku, Osaka 541-0043 Japan

Phone: +81-6-7636-2362 Fax: +81-6-6208-3802

<http://www.alinco.com>

E-mail: export@alinco.co.jp



CE 0700 ⚠

UHF FM Transceiver / 400.000-489.995MHz
All EU and EFTA member states. Operator
license is required.

IC

RoHS



Copyright Alinco, Inc. PS0665/FNEG-NE

Printed in China

UHF FM Mobile Transceiver

DR-438

Instruction Manual

Thank you for purchasing your new Alinco transceiver. Please read this manual carefully before using the product to ensure full performance, and keep this manual for future reference as it contains information on after-sales services. In case addendum or errata sheets are included with this product, please read those materials and keep them together with this instruction manual for future reference.

NOTE: DR-438 may be delivered to you after dealer-programming.

In such cases, please ask your dealer about the available features in your unit and how to operate this unit.

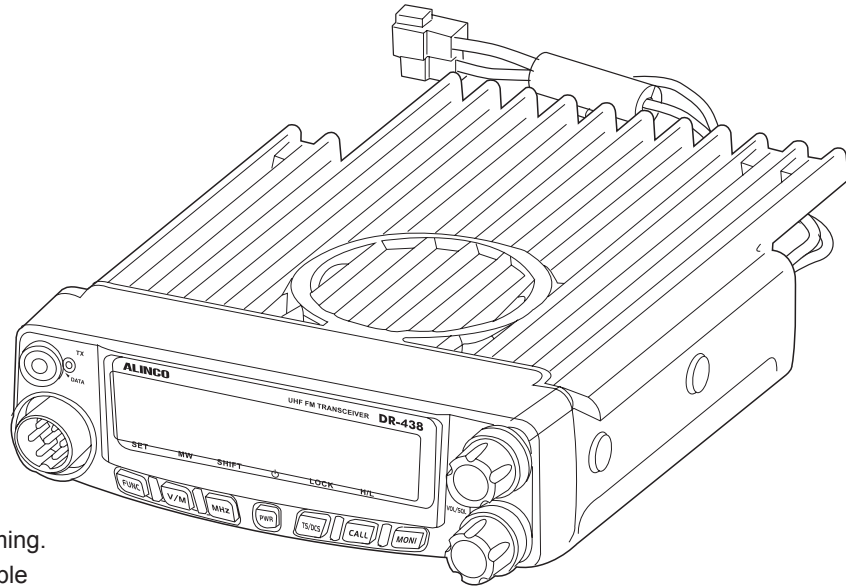

Introduction

Thank you very much for purchasing this excellent Alinco transceiver. Our products are ranked among the finest in the world. This radio has been manufactured with state of the art technology and it has been tested carefully at our factory. It is designed to operate to your satisfaction for many years under normal use.

Please read this manual completely from the first page to the last, to learn all the functions the product offers. It is important to note that some of the operations may be explained in relation to information in previous chapters. By reading just one part of the manual, you may risk not understanding the complete explanation of the function.

Before transmitting

There are many radio stations operating in proximity to the frequency ranges this product covers. Be careful not to cause interference when transmitting around such radio stations.

■ Lightning

Please note that no car provides adequate protection of its passengers or drivers against lightning. Therefore, Alinco will not take responsibility for any danger associated with using its radios or inside the car during lightning.

■ For North American users

Due to strict rules, this product is blocked for operations before sales and only dealers can program the radio before delivery to consumers. Manufacturer is not aware of details of such dealer-programming therefore please kindly contact your dealer first in case technical-service may be necessary.

Features

- **Output power selectable 40W**
- **PC-programmable**
- **Alphanumeric name tags**
- **Voice Comander (Reduce Noise & enhance audio clarity)**
- **Optional Inversion Scramble (DR-135S only)**
- **Sub-tone (CTCSS/DCS) Encode/ Decode, DTMF/ANI, 2-tone and 5-tone**
- **Various scan modes, Key lock, Narrow operations and more at NO extra costs.**

Conformity Symbols



Tested to comply MIL-STD-810G

-Shock: Method 514.6/I,IV -Vibration: Method 516.6/I

 Conformity Information

In case the unit you have purchased is marked with a CE symbol, a copy of relative conformity certificate or document can be reviewed at <http://www.alinco.com/usa.html>. Please see the back-cover for more details.

Copyright 2012 All rights reserved. NO part of this document may be reproduced, copied, translated or transcribed in any form or by any means without the prior written permission of Alinco. Inc, Osaka, Japan, English Edition Printed in China.

SAFETY TRAINING INFORMATION

WARNING:

This radio generates RF electromagnetic energy during transmission. This radio is designed for and classified as “Occupational Use Only”, meaning it must be used only during the course of employment by individuals aware of the hazards, and the ways to minimize such hazards. This radio is NOT intended for use by the “General Population” in an uncontrolled environment.

- For compliance with FCC and Industry Canada RF Exposure Requirements, the transmitter antenna installation shall comply with the following two conditions:

1. The transmitter antenna gain shall not exceed 0 dBi.
2. The antenna is required to be located outside of a vehicle and kept at a distance of 63 centimeters or more between the transmitting

antenna of this device and any persons during operation. For small vehicle as worst case, the antenna shall be located on the roof top at any place on the centre line along the vehicle in order to achieve 63 centimeters separation distance. In order to ensure this distance is met, the installation of the antenna must be mounted at least 63 centimeters away from the nearest edge of the vehicle in order to protect against exposure to bystanders.

CAUTION:

To ensure that your exposure to RF electromagnetic energy is within the FCC allowable limits for occupational use, always adhere to the following guidelines:

- DO NOT operate the radio without a proper antenna attached, as this may damage the radio and may also cause you to exceed FCC RF exposure limits. A proper antenna is the antenna supplied with this

radio by the manufacturer or an antenna specifically authorized by the manufacturer for use with this radio.

- DO NOT transmit for more than 50% during the time of employment (50% duty cycle or less). Transmitting excessive amount of time can cause RF exposure compliance requirements to be exceeded. Please carefully read this instruction manual to learn how to transmit and stop transmitting before starting to use it.

Electromagnetic Interference/Compatibility

During transmissions, your radio generates RF energy that can possibly cause interference with other devices or systems. To avoid such interference, turn off the radio in areas where signs are posted to do so. DO NOT operate the transmitter in areas that are sensitive to electromagnetic radiation such as hospitals, aircraft, and blasting sites.

Occupational/Controlled Use

This product is used in situations that users are exposed to RF as consequence of their employment provided those users are fully aware of the potential RF hazards and can exercise control over their exposure.

- This transceiver is NOT ATEX approved and NOT intended for the use in hazardous explosive atmospheres.

FCC INFORMATION

FOR CLASS B UNINTENTIONAL RADIATORS:

This equipment has been tested and found to comply with the limits for a Class B digital device, pursuant to part 15 of the FCC Rules.

These limits are designed to provide reasonable protection against harmful interference in a residential installation.

This equipment generates, uses and can radiate radio frequency energy and, if not installed and used in accordance with the instructions, may cause harmful interference to radio communications. However, there is no guarantee that interference will not occur in a particular installation.

If this equipment does cause harmful interference to radio or television reception, which can be determined by turning the equipment off and on, the user is encouraged to try to correct the interference by one or more of the following measures:

- Reorient or relocate the receiving antenna.
- Increase the separation between the equipment and receiver.
- Connect the equipment into an outlet on a circuit different from that to which the receiver is connected.
- Consult the dealer or an experienced radio/TV technician for help.

FOR CUSTOMERS IN CANADA :

Le présent appareil est conforme aux CNR d'Industrie Canada applicables aux appareils radio exempts de licence.

L'EXPLOITATION EST AUTORISÉE AUX DEUX CONDITIONS SUIVANTES :

- (1) l'appareil ne doit pas produire de brouillage, et
- (2) l'utilisateur de l'appareil doit accepter tout brouillage radioélectrique subi, même si le brouillage est susceptible d'en compromettre le fonctionnement.

PRECAUTIONS:

- ! The manufacturer declines any responsibilities against loss of life and property due to a failure of this product when used with or as a part of a device made by third parties.

- ! Use of third party accessory may result in damage to this product. It will void our warranty for repair.

■ Handling this product

- ! Be sure to reduce the audio output level to minimum before using an earphone or a headset. Excessive audio may damage hearing.
- ⊘ Do not open the unit without permission or instruction from the manufacturer. Unauthorized modification or repair may result in electric shock, fire and/or malfunction and voids warranty.
- ⊘ Do not operate this product in a wet place such as in a shower room. It may result in electric shock, fire and/or malfunction.
- ⊘ Do not place the product in a container carrying conductive materials, such as water or metal in close proximity. A short-circuit to the product may result in electric shock, fire and/or malfunction.

■ In case of emergency

In case of the following situation(s), please turn off the product, switch off the source of power, then remove or unplug the power-cord. Please contact your local dealer of this product for service and assistance. Do not use the product until the trouble is resolved. Do not try to troubleshoot the problem by yourself.









- When a strange sound, smoke and/or strange odor comes out of the product.
 - When the product is dropped or the case is broken or cracked.
 - When a liquid penetrated inside.
 - When a power cord (including DC cables, AC cables and adapters) is damaged
- ! For your safety, turn off then remove all related AC lines to the product and its accessories from the wall outlet if a thunderstorm is likely.

■ Maintenance

- ⊘ Do not open the unit and its accessories. Please consult with your local dealer of this product for service and assistance





Alert

■ Environment and condition of use



-  It is recommended that you check local traffic regulations regarding the use of a radio equipment while driving. Some countries prohibit or apply restrictions for the operation of radios and mobile- phones while driving.
-  Do not use this product in close proximity to other electronic devices, especially medical ones. It may cause interference to those devices.
-  Keep the radio out of the reach of children. This product is not a toy and contains small part that may be dangerous when swallowed.
-  In case a liquid leaks from the product, do not touch it. It may damage your skin. Rinse with plenty of cold water if the liquid contacted your skin.
-  Never operate this product in facilities where radio products are prohibited for use such as aboard aircraft, in airports, in ports, within or near the operating area of business wireless stations or their relay stations.
-  Use of this product may be prohibited or illegal outside of your country. Be informed in advance when you travel.
-  The manufacturer declines any responsibilities against loss of life and/or a property due to a failure of this product.
-  Do not use multiple radios in very close proximity. It may cause interference and/or damage to the product(s).

Alert

■ Environment and condition of use

-  Do not use the product in proximity to a TV or a radio. It may cause interference or receive interference.
-  Do not install in a humid, dusty or insufficiently ventilated place. It may result in electric shock, fire and/or malfunction.
-  Do not install in an unstable or vibrating position. It may result in electric shock, fire and/or malfunction when/if the product falls to the ground.
-  Do not install the product in proximity to a source of heat and humidity such as a heater or a stove. Avoid placing the unit in direct sunlight.
-  Be cautious of a dew formation. Please completely dry the product before use when it happens.

■ About transceiver

-  Do not connect devices other than specified ones to the jacks and ports on the product. It may result in damage to the devices.
-  Turn off and remove the power source (AC cable, DC cable, battery, cigar cable, charger adapter etc.) from the product when the product is not in use for extended period of time or in case of maintenance.
-  Use a clean, dry cloth to wipe off dirt and condensation from the surface of the product. Never use thinner or benzene for cleaning.



Check with your local waste officials for details on recycling or proper disposal in your area.

■ PC PROGRAMMING

NOTE: The utility software may be available to distributors/dealers only. USB programming cable is required. The manufacturer will not release the software to unauthorized party so please contact your dealer for details.

CONTENTS

Supplied Accessories/Optional Accessories.....	1	Memory Channel Deleting	12
Supplied Accessories	1	KEY OPERATIONS.....	13
Initial Installation	2	Squelch Off/Squelch Off Momentary	13
Mobile installation	2	Frequency/Memory Scan	13
DC Power Cable Connection	3	Memory Scan	13
Power supply voltage Display	5	CTCSS/DCS Encode and Decode setup	13
Antenna Connection	5	CTCSS SCAN	14
Accessories Connections.....	5	DCS SCAN	14
Getting Acquainted	7	High/Mid/Low Power switch	14
Front panel.....	7	Compander	14
Rear panel	8	Offset Direction and offset frequency setup	14
Display	8	Keypad Lockout	15
Microphone	9	Auto-Dialer Setup.....	15
Operating Mode	10	Transmitting Edited DTMF Tones in the Auto-dialer Memory.....	15
Basic Operations	11	PARAMETER SETTING MODE.....	16
Switching the Power On/Off	11	Frequency Channel Step Setup.....	16
Adjusting the Volume	11	DTMF, DTMF ANI, 2Tone or 5Tone Signaling	16
Switch between VFO and Channel mode	11	Sending 2-Tone Call.....	17
Adjusting Frequency/Channel Through Selector Knob.....	11	Sending 5-Tone Call.....	17
Adjusting squelch level	11	Sending DTMF call	17
Receiving	11	Signaling Combination setup	17
Transmitting	11	High/Mid/Low Power Selection	18
Transmitting Tone Burst Tone	12	Band-width Selection	18
Transmitting Optional Signaling	12	TX OFF Setup.....	18
Memory Channel Programming.....	12	Busy Channel Lockout	19

CONTENTS

Editing Channel NAME	19	Transmitting DTMF Code.....	24
Reverse TX/RX.....	19	Frequency Step	24
Talk Around	19	Optional signaling	24
Voice Comander	20	Scan Skip	25
Scrambler setup (Encryption)	20	Frequency/Channel scan	25
Radio's DTMF Self ID Enquiry	20	Busy Channel Lockout.....	25
Radio's 5TONE Self ID Enquiry	20	Reverse TX/RX.....	25
Beep Sound	21	TOT (Time-out timer)	25
TOT (Time-out timer)	21	CTCSS/DCS Encode and Decode.....	25
APO (Auto power off).....	21	Talk Around	26
DTMF Transmitting Time.....	21	Beep Sound	28
Display Illumination Color Setting	22	HIGH/MID/LOW Power Selection	28
Scan Resume Time Setup	22	LCD Backlight	26
LCD Dimmer	22	Anti-theft Alarm	27
Tone-burst Tones	22	Cable Clone.....	27
Display Mode Setup.....	22	Maintenance.....	27
PIN Setup(Useless if PIN is not assigned).....	23	Default Setting after Resetting(UHF)	31
Address list	23	Trouble Shooting.....	31
RESET (May be blocked for dealer-programmed units).....	23	Specifications	30
Microphone Operation	24	Appendix	31
Keypad Lock	24	50 groups CTCSS Tone Frequency(Hz).	31
Transmitting DTMF By Microphone Keypad	24	1024 groups DCS Code.....	31
Function Setup By Microphone Keypad.....	24		
Switches between VFO and channel mode	24		
Short Calling CALL Channel	24		

SUPPLIED ACCESSORIES

Carefully unpack to make sure the following items are found in the package in addition to this manual:

- Transceiver
DR-438

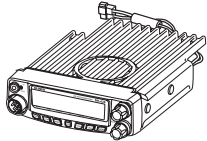

- Microphone EMS-74
(with DTMF keyboard)

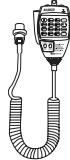

- Mobile Mounting
Bracket

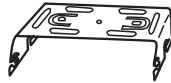

- DC Power Cable with
Fuse Holder

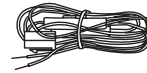

- Hardware Kit for Bracket

Black screws
(M4X8mm)
4PCS



Tapping screws
(M5X8mm)
4PCS



S-Washer



- Spare Fuses

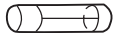

The standard accessories may vary slightly depending on the version you have purchased. Please contact your local authorized Alinco dealer should you have any questions. Alinco and authorized dealers are not responsible for any typographical errors there may be in this manual. Standard accessories may change without notice.

Warranty Policy: Please refer to any enclosed warranty information or contact your authorized Alinco dealer / distributor for the warranty policy.

- In order to operate this product, a properly tuned antenna, its feedline with connectors and fixing hardware are necessary. Please consult with your dealer for details.

MOBILE INSTALLATION

The transceiver may be installed in any position in your car, where the controls and microphone are easily accessible and it does not interfere with the safe operation of the vehicle. If your vehicle is equipped with air bags, be certain your radio will not interfere with their deployment. If you are uncertain about where to mount the unit, contact your vehicle's dealer.

1. Install the mounting bracket in the vehicle using the supplied self-tapping screws (4pcs) and flat washers (4pcs).

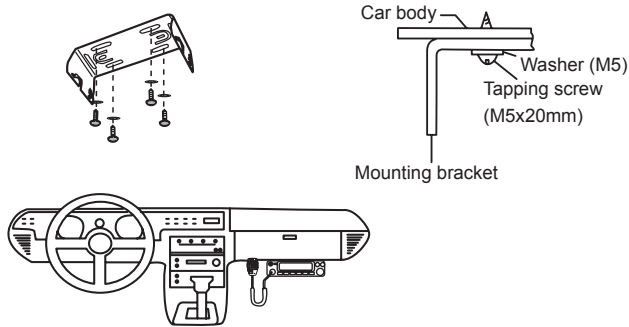

2. Position the transceiver, then insert and tighten the supplied hexagon SEMS screws.

- ▼ Double check that all screws are tightened to prevent vehicle vibration from loosening the bracket or transceiver.

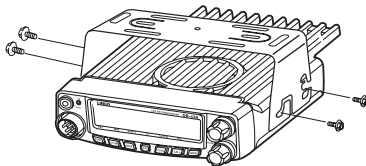

Caution:

Use only the provided screws otherwise you risk damaging the circuit board, components or fall-off of the unit.

- ▼ Determine the appropriate angle of the transceiver, using the 3 screw hole positions on the side of the mounting bracket.

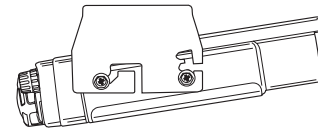
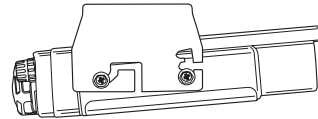
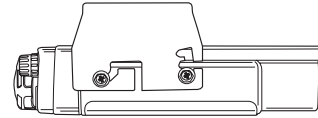

DC POWER CABLE CONNECTION

✕ MOBILE OPERATION

The vehicle battery must have a nominal rating of 12V. Never connect the transceiver to a 24V battery. Be sure to use a 12V vehicle battery that has sufficient current capacity. If the current to the transceiver is insufficient, the display may darken during transmission, or transmitting output power may drop excessively.

1. Route the DC power cable supplied with the transceiver directly to the vehicle's battery terminals using the shortest path from the transceiver.

▼ Never use the cigarette lighter socket as a DC source.

▼ The entire length of the cable must be dressed so it is isolated from heat, moisture, and the engine secondary (high voltage) ignition system/ cables.

2. After installing cable, in order to avoid the risk of damp, please use heat-resistant tap to tie together with fuse box. Don't forget to reinforce whole cable.

3. In order to avoid the risk of short circuit, please cut down connection with negative (-) of battery, then connect with radio.

4. Confirm the correct polarity of the connections, then attach the power cable to the battery terminals; red connects to the positive (+) terminal and black connects to the negative (-) terminal.

▼ Never remove the fuse holders from the cable.

5. Reconnect any wiring removed from the negative terminal.

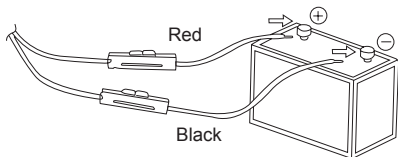

6. Connect the DC power cable to the transceiver's power supply connector.

▼ Press the connectors firmly together until the locking tab clicks.

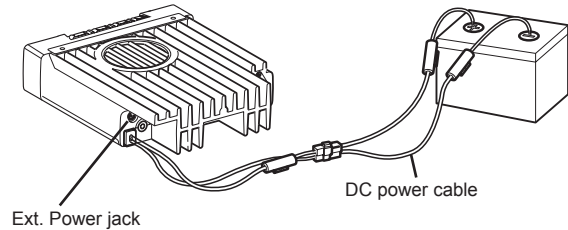

If the ignition-key on/off feature is desired (optional feature), use the optional EDC-43 (For Cigar-Plug connection) cable. Connect one of the cables between the ACC terminal or a Cigar-Plug that operates with the vehicle ignition or ACC switch on the vehicle and EXT POWER jack on the rear side of the unit.

7. When the ignition key is turned to ACC or ON (Start) position with the radio turned off, the power switch illuminates. The illumination will be turned off when the ignition key is turned to the off position. To turn on the unit, press the power switch manually while it is illuminated. (While ignition key is at ACC or ON position)

8. When the ignition key is turned to ACC or ON position with the radio's power switch on, the unit turns on automatically and the power switch will be lit. Turn the ignition key to OFF position or manually turn the power switch off to shut down the radio.

9. Use of ignition-key ON/OFF feature drains 5mAh of current from the battery as long as the EDC-43 is being connected.

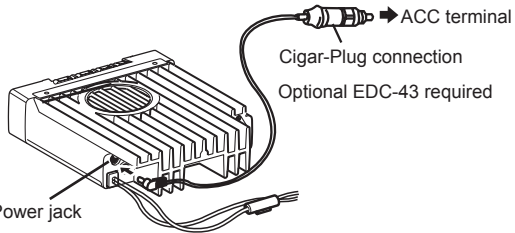

✘ FIXED STATION OPERATION

In order to use this transceiver for fixed station operation, you will need a separate 13.8V DC power supply (not included), Please contact local dealer to require.

The current capacity of your power supply must be 12A or more.

1. Connect the DC power cable to the regulated DC power supply and ensure that the polarities are correct. (Red: positive, Black: negative).

- ▼ Never directly connect the transceiver to an AC outlet.
- ▼ Use the supplied DC power cable to connect the transceiver to a regulated power supply.
- ▼ Do not substitute a cable with smaller gauge wires.

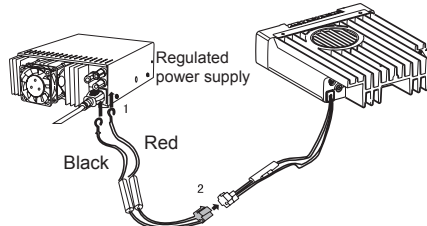

DC power cable with fuse holder

2. Connect the transceiver's DC power connector to the connector on the DC power cable.

- ▼ Press the connectors firmly together until the locking tab clicks



- ▼ Before connecting the DC power to the transceiver, be sure to switch the transceiver and the DC power supply OFF.
- ▼ Do not plug the DC power supply into an AC outlet until you make all connections.

✘ REPLACING FUSES

If the fuse blows, determine the cause, then correct the problem. After the problem is resolved, replace the fuse. If newly installed fuses continue to blow, disconnect the power cable and contact your dealer for assistance.

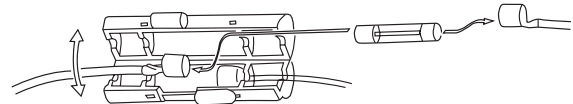

Fuse Location	Fuse Current Rating
Transceiver	15A
Supplied Accessory DC power cable	20A

Only use fuses of the specified type and rating, otherwise the transceiver could be damaged.



- ▼ If you use the transceiver for a long period when the vehicle battery is not fully charged, or when the engine is OFF, the battery may become discharged, and will not have sufficient reserves to start the vehicle. Avoid using the transceiver in these conditions.

POWER SUPPLY VOLTAGE DISPLAY

After connecting the transceiver to the power supply, the supply voltage can be displayed on LCD by pressing the **(FUNC)** key together with the **(MONI)** key.

The display immediately changes as the voltage supply changes, It also displays voltage during transmission.

The transceiver will return to its normal operation when the power is turned ON/OFF or repeat above operation.



The range of displayed voltage is from 7V to 16V DC. Because the displayed value is estimated, please use a voltmeter when a more precise reading is desired.

5

ANTENNA CONNECTION

Before operating, install an efficient, well-tuned antenna. The success of your installation will depend on the type of antenna and its correct installation.

Use a 50Ω impedance antenna and low-loss coaxial feed-line that has a characteristic impedance of 50 Ω, to match the transceiver input impedance. Coupling the antenna to the transceiver via feed-lines having an impedance other than 50Ω reduces the efficiency of the antenna system and can cause interference to nearby televisions, radio receivers and other electronic equipment.



Transmitting without first connecting an antenna or other matched load may damage the transceiver. Always connect the antenna to the transceiver before transmitting.

All fixed stations should be equipped with a lightning arrester to reduce the risk of fire, electric shock, and transceiver damage.

ACCESSORIES CONNECTIONS

EXTERNAL SPEAKER

If you plan to use an external speaker, choose a speaker with an impedance of 8 Ω. The external speaker jack accepts a 3.5 mm (1/8") mono (2-conductor) plug.

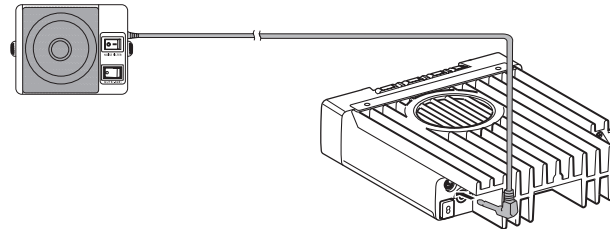

External speaker adopt double port BTL, please care about the connection.
NOTE Do not use the speaker that requires grounding.

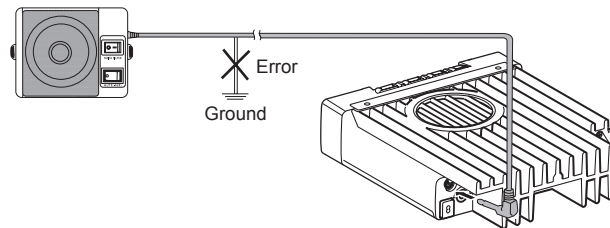

✘ MICROPHONE

For voice communications, connect a provided microphone into the socket on the front of the main unit. Turn the ring firmly on the plug until it locks. Attach the supplied microphone hanger in an appropriate location using the screws included in the screw set.

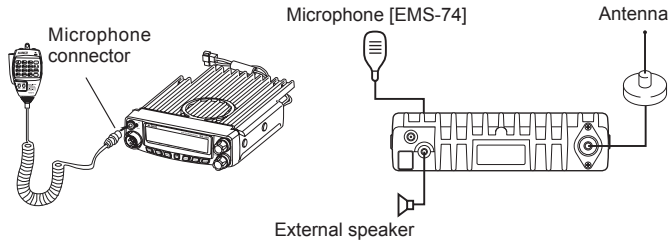

FRONT PANEL

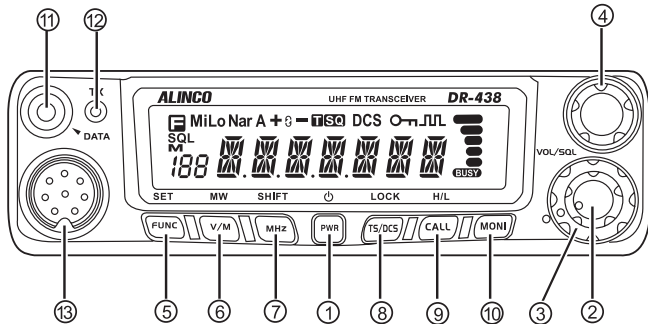

• Basic Functions

NO.	KEY	FUNCTION
1	PWR(Power)	Power on/Off
2	VOL	Adjust Volume Key
3	SQL Knob	Adjust Squelch level
4	Main Dial	Change frequency, memory channel and scan direction etc.
5	FUNC/SET	Function Key
6	V/M/MW	Switches between VFO mode and Channel mode
7	MHz/SHIFT	Step Size Key (step:1MHz)
8	TS/DCS/LOCK	Sets CTCSS and DCS value
9	CALL/H/L	CALL Channel
10	MONI	Squelch off
11	Data Terminal	Data reading/writing, cloning and theft alarm functions
12	TX	lights during Transmitting

13	Mic.connector	Microphone connection port
----	---------------	----------------------------

- Press **FUNC** key until  icon appears then press the following key.

NO.	KEY	FUNCTION
5	FUNC/SET	Confirms the selective functions and exit
6	V/M/MW	Stores data into channels
7	MHz/SHIFT	Sets offset direction and offset frequency
8	TS/DCS/LOCK	Sets Keypad lock function
9		
10	MONI	Compander mode on/off

- Press **FUNC** key and following key together to activate following function:

NO.	KEY	FUNCTION
1	MONI+PWR	Reset to factory default settings
6	V/M/MW	Erase the memory
7	MHz/SHIFT	Narrow band
8	TS/DCS/LOCK	Auto dialer
9	CALL	Enters clone data function mode
10	MONI	Enters power supply voltage indication mode

- Functions that require continuous pressing following key to be activated

NO.	KEY	FUNCTION
5	FUNC/SET	Press and hold for 2s to enter the Setting mode
10	MONI	Monitor mode

REAR PANEL

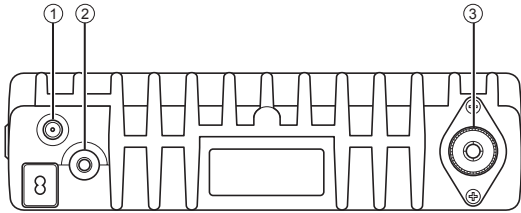

NO.	KEY	FUNCTION
1	Ext. Power Jack	Terminal for connecting optional cable for use with ignition key On/Off function.
2	Ext. Speaker Terminal	Terminal for optional external speaker.
3	Antenna Connector	Connection for 50Ω coaxial cable and antenna. Connector is PL/M.

DISPLAY

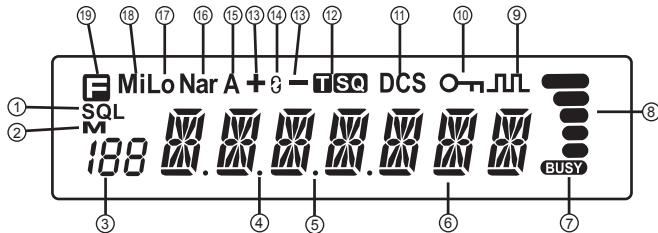

NO.	KEY	FUNCTION
1	SQL	(Not in use)
2	M	Memory mode.
3	188	Indicates the channel number in memory mode.
4	Dot	Channel skip.
5	Decimal point	Indicates the decimal point of frequency and the scanning function.
6		Indicates the frequency or memory name.
7	BUSY	Signal is being received or monitor.
8		Signal strength of receiving and transmitting.
9		Componder.
10		Keypad lock .
11	DCS	Set DCS function.
12	SQL	Set CTCSS function.
13	+ -	Offset frequency direction.
14		Scramble. (S-version only)
15	A	Auto power off.
16	Nar	Narrow mode.
17	LO	
18	Mi	
19		Function key is activated

MICROPHONE

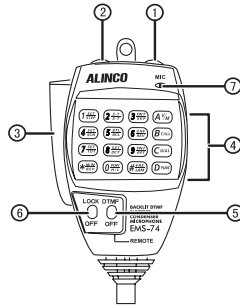

MIC Connector Diagram(in the front view of connector)

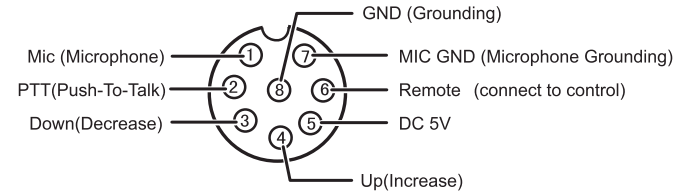

NO.	KEY	FUNCTION
1	UP	Increase frequency ,channel number or setting value.
2	DOWN	Decrease frequency, channel number or setting value.
3	PTT	Push-To-Talk key to transmit.
4	Numerical Keyd	Input VFO frequencies and other various operations
5	DTMF ON/OFF	Switches between DTMF and function operations.
6	LOCK Switch	Locks all keys excep PTT.
7	MIC	Microphone element is located.

According to practical application, you can set the radio works as VFO Transceiver mode or Channel mode.

1. Initial setting:

- A. **By programming software:** See the Function Setup menu in the programming software.
- B. **By manual setup:** Please refer to "Display Mode" in P.22.

2. VFO Mode:

A. Frequency + Memory mode: At this mode, when set display as "FR", it enters into Frequency + Memory mode. Once the radio is turned off or switched to another channel, the temporary setting will be erased and back to initial settings. (As pic 1)

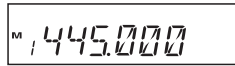

(Pic 1)

B. Channel + Name Tag Mode: When set display as "NM", it enters into Channel + Name Tag Mode. At this mode, it will display corresponding channel name when the current channel is edited with name in advance. Otherwise, it will display frequency and channel number. Its operations are the same as frequency+channel mode. (As pic 2)



(Pic 2)

C. VFO Mode(Frequency mode): This mode shows only frequency on the display. Set mode operation and Channel setting are stored as the latest value. Once the radio is turned off or changed to new frequency using VFO, the value remains until next change. (As pic 3)

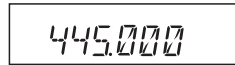

(Pic 3)

3. Commercial radio Mode:

When set display mode as "CH", it enters into Commercial radio mode. At this mode, except very limited feature, all other functions should be set by PC software in advance to the operation. If name tag is programmed, the LCD will display name tag. (As pic 4) Once the transceiver has been set as this mode, users can't access to reset or changing masked parameters manually.

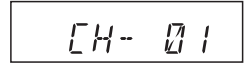

(Pic 4)



(Pic 5)

Some countries of distribution do not allow commercial users to program the radio freely and/or to operate in frequency-display(VFO) mode.





In addition, the programming software is made available to dealers only and Alinco releases the software only to the authorized importers.

Please consult with your dealer of purchase of this product in case you may have questions about channel programming and available features. Alinco and its authorized distributors are not aware of details of such programming performed by your dealer.

5 Basic Operations

The  symbol stands for restricted or optional functions. Features and/or operations may not be available to commercial-mode users unless pre-programmed by the dealer.

■ SWITCHING THE POWER ON/OFF

According to the option selected during installation, press the  switch or turn the ignition key to ACC or ON position to power on. Press the  key for 1 seconds or turn the ignition key to OFF position to turn off.

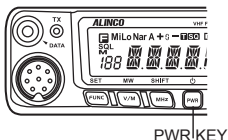

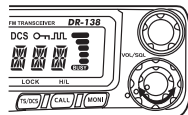

■ ADJUSTING THE VOLUME

Turn the VOL knob clockwise to increase the audio level, counterclockwise to decrease.



11  **NOTE** Press and hold MONI key to hear a white-noise to set the proper audio level.

□ SWITCH BETWEEN VFO AND MEMORY MODE

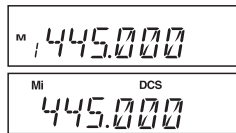

In standby, press  key or Microphone's  key until appear **M**, this indicates current frequency in Memory mode. Repeat above operation to switch between Frequency mode (VFO) and Memory mode.



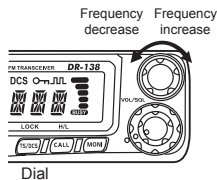

■ ADJUSTING FREQUENCY/CHANNEL THROUGH THE DIAL

- Under frequency (VFO) mode, you can change the current frequency to the desired one through dial; Turn clockwise to increase frequency; turn counterclockwise to decrease. Every click will increase or decrease one step. Press  key, the KHz order digits will



be masked. In this status, turn Main Dial or Microphone [ / ] key will increase or decrease frequency quickly by 1MHz step.

- Under channel mode, you can change the current channel to the desired one through Main Dial, clockwise turn to the forward channel, anticlockwise turn to the backward channel. In relative Operating mode, Microphone's [ / ] key has the same function for adjusting frequency and channel.

■ ADJUSTING SQUELCH LEVEL



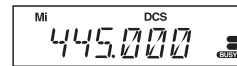

A squelch eliminates white-noise (the background noise when a signal is not received). Higher level settings will keep the squelch "closed" more tightly for quieter monitoring, but weak signals will not be heard. Lower settings allow weaker signals to "open" the squelch but noise may also cause it to open. By rotating the SQL knob, adjust the squelch level to the desired level.

■ RECEIVING

Select the desired receiving frequency or browse channels to listen to ongoing communications. The S-meter shows relative signal strength between BUSY and 5th segment when the transceiver detects an incoming signal.



■ TRANSMITTING

Press and hold  key or press MIC's  key to monitor for a while to confirm the channel desired is not busy. Release  or press Mic's  key to return standby status, Then press and hold  key to speak into microphone.

- ▼ Please hold the microphone approximately 2.5-5.0cm from your lips, and then speak into the microphone in your normal speaking voice.

 While transmitting, LED lights RED and TX-meter shows relative power level.
NOTE Release PTT to receive.



□ TRANSMITTING TONE BURST TONE

Press and hold [PTT] key, then press Microphone [DOWN] key to transmit current selected tone-burst tone. Pre-programming is necessary.

□ TRANSMITTING OPTIONAL SIGNALING

Press and hold [PTT] key, then press Microphone [UP] key or press [CALL] key in front panel or press Mic's [B_{CALL}] key to transmit pre-stored and selected DTMF/2Tone/5Tone optional signaling. Pre-programming is necessary.

□ MEMORY CHANNEL PROGRAMMING

1. Under frequency mode (VFO), turn Main Dial to select the desired frequency or input frequency by MIC's numeric keys.
2. Press [TS/DCS] key to enter CTCSS/DCS signaling setup, turn Main Dial to select the desired signaling. See P.13 for details.
3. Press [FUNC] key, LCD appears  and current channel number, **M** icon flashing means current channel is empty.
4. Turn Main Dial to select the desired channel number to store.
5. Press [V/M] key,  , **M** icon and channel number disappears and beep sounds twice.
6. Press [V/M] key again to confirm that the memory channel is properly stored.

□ MEMORY CHANNEL DELETING

1. Under Memory mode, turn Main Dial to select channel to be deleted.
2. Press [FUNC] key and [V/M] key together, current memory will be deleted beep sounds. **M** icon flashing means current memory is deleted.

SQUELCH OFF/SQUELCH OFF MOMENTARY

1. Squelch Off: Press **(MONI)** key to disable squelch, press **(MONI)** key again to resume squelch. This is set by programming software as an option.
2. Squelch Off Momentary: Press and hold **(MONI)** key to disable squelch, release **(MONI)** key to resume squelch. This is factory default operation.



The above functions can be set in by software only, not by key operation.

FREQUENCY/MEMORY SCAN

* FREQUENCY SCAN

Scans all VFO frequencies in regard to the preset tuning step.

1. In VFO mode, press **(V/M)** for 1 second to start scanning.

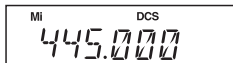

2. Turn Main Dial or press Microphone [**(UP)** / **(DOWN)**] key to change scan direction.
3. Press any key except **(PWR)** and **(FUNC)** key to stop.

□ MEMORY SCAN (CHANNEL SCAN)

Scans all memory channels unless Memory skip feature is selected for a given memory.

1. In memory mode, press **(V/M)** key for 1 second to enter into channel scan
2. Turn selector knob or press Microphone [**(UP)** / **(DOWN)**] key to change scan direction.
3. Press any key except **(PWR)** and **(FUNC)** key to exit.

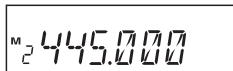

□ CTCSS/DCS ENCODE AND DECODE SETUP

Many repeaters require a CTCSS tone or a DCS code encode setting as a “key” to access the system, so-called “selective-calling”. Sometimes, CTCSS or DCS decode features are used on the output of a repeater so they can be used as a squelch. In this mode, regardless of the main squelch status, the audio can be heard ONLY when the matching tone/code signal is received. The combination of CTCSS squelch and DCS function is not available; only one or the other may be used for a given channel. The operation is available on VFO and memory mode. Dealer-Preprogrammed units can't operate this function manually. In the memory mode, the setting is temporary; changing the channel or turning off the radio will erase the setting.

1. Press **(TS/DCS)** key. The current setting will be displayed with **T/SQ/DCS** icons and relative frequency/code. Press the same key to select **T/SQ/DCS** setting.
2. The numbers (such as 88.5) represent the CTCSS frequency in Hz. When it is displayed with the **(T)** icon only, the unit transmits the sub-audible tone while the PTT is pressed (encode) and the repeater access is enabled (assuming the repeater is using 88.5Hz tone).
3. Press the same key again so that the **(SQ)** icon shows up on the display. This is the CTCSS decode frequency. This enables CTCSS squelch (or Tone Squelch, TSQ).
4. Press it again so that the 3-digit number and **(DCS)** icon is displayed. This is the DCS code, and it enables DCS encoding and decoding.

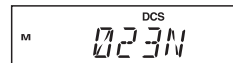
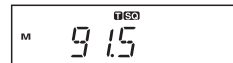
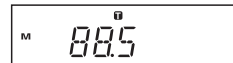

For 2-4, rotate the main dial or press the [**(UP)** / **(DOWN)**] keys to change tone or code. Press any key (Except **(FUNC)** / **(PWR)** / **(TS)** / **(DCS)**,

UP / DOWN keys) to enter the setting and return to original status. The T/SQ/DCS icon will remain on the display to show the current selective-calling status. To exit, simply use the TS/DCS key and press it until the relative status icon T/TQ/DCS disappears.

The CTCSS encoding and decoding frequencies may be set differently. The encode setting frequency automatically relates to the decode setting, but decode setting does not affect encode. The standard set of 50 different CTCSS tones are available. DCS encode/decode cannot be separated. The list of selectable tones and codes is shown on Appendix at the end of this booklet.

□ CTCSS SCAN

Repeatedly press **[TS/DCS]** key until LCD displays **[T]** icons ,then hold **[TS/DCS]** key for 1 second to enter into CTCSS scanning. Once finding a matching CTCSS tone, a voice will be heard and resumes scanning after 15 seconds.



□ DCS SCAN

Repeatedly press **[TS/DCS]** key until LCD displays DCS icons ,then hold **[TS/DCS]** key for 1 second to enter into DCS scanning. Once finding a matching DCS code,a voice will be heard and resumes scanning after 15 seconds.

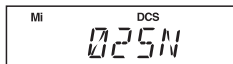

□ HIGH/MID/LOW POWER SWITCH

Press **[FUNC]** key until LCD display **[H]** icon, then press **[CALL]** key to switch between high/Mid/low power. The LCD appears:

None: Transmits in high power

MI: Transmits in middle power

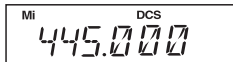
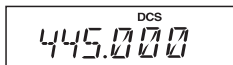

Lo: Transmits in low power

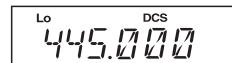

□ COMPANDER (DECREASE THE BACKGROUND NOISE AND ENHANCE AUDIO CLARITY)

Compander function will decrease the background noise and enhance audio clarity.

1. Press **[FUNC]** key, then press **[MONI]** key to turn on compander function, repeat above operation again to turn off .

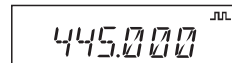

2. When "JL" icon is displayed, compander is active.

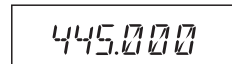

This function is valid only among the compander-capable radios and may worsen the audio if used with non-compander ones.

14

□ OFFSET DIRECTION AND OFFSET FREQUENCY SETUP

Repeater receives a signal(UP-LINK) on one frequency and re-transmits on another frequency(DOWN-LINK). The difference between these two frequencies is called the offset frequency. If the UP-LINK frequency higher than DOWN-LINK frequency, the direction is positive, If it is lower, the shift direction is negative.

1. Press **[FUNC]** key until the **[H]** icon appears on the LCD, then press **[MHZ]** key, LCD displays offset direction and offset frequency.
2. Repeatedly press **[MHZ]** key to select positive offset or negative offset.
3. When LCD displays " + " icon, it indicates positive offset, which means transmitting frequency higher than receiving frequency.

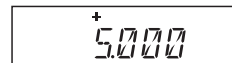

4. When LCD displays "-" icon, it indicates negative offset, which means transmitting frequency lower than receiving frequency.

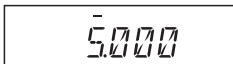

5. Turn Main Dial or Mic's [**UP** / **DOWN**] key to change offset frequency in accordance with the step setting.

6. Press any key except **FUNC** and **MHZ** key to set and finish setting.





Under channel mode, this operation can be temporarily available. Once the radio is turned off or switched to another channel, the temporary setting will be erased.

15

KEYPAD LOCKOUT

Avoiding unintentional operation, this function will lock, all keys except **MONI**、**FUNC** and **PWR**.

1. Press **FUNC** key until LCD displays  icon, then press **TS/DCS** key until LCD displays  icon. Now keypad lockout function is valid.

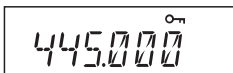

2. Repeat above operation,  icon disappears, indicating keypad lockout function is invalid.

AUTO-DIALER SETUP

This will automatically transmit pre-programmed and stored DTMF tones. It is necessary to program Auto-dialer tones in advance to operate this feature.

1. While pressing and holding **FUNC** key, press **TS/DCS** key to enter the auto-dialer enquiry mode, LCD displays current default data and current group displayed on left. If no data in current group, it shows "EMPTY".

2. Turn selector knob to choose group you wish to edit. Up to 16 Auto-dialer memories are available.

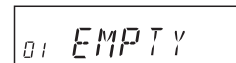

3. Press **MONI** key to program the DTMF you wish to transmit automatically.

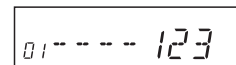

4. The display scrolls when the 7th digit is entered. The numbers 0-9, --, A-D, * and # can be stored up to a total of 23 digits.



5. After editing, press PTT key to send current auto-dialer tones. Press **MONI** to exit and store.

TRANSMITTING EDITED DTMF TONES IN THE AUTO-DIALER MEMORY

1. While pressing and holding **FUNC** key, press **TS/DCS** key to enter into auto-dialer enquiry
2. Turn Main Dial to select desired auto-dialer group to transmit.
3. Press PTT to transmit selected DTMF tones.



NOTE

IMPORTANT: All or a part of operation in this chapter may not be available to dealer-programmed units. The default setting list is available on P29.

1. Press and hold **[FUNC]** key for over 2 seconds to enter the parameter setting mode.
2. Press **[CALL]** or **[MONI]** to select the desired menu.
3. Turn Main Dial to select the desired parameter.
4. Press **[TS/DCS]** to confirm and exit.

■ FREQUENCY STEP SETUP

Only in VFO mode, this function is valid. Turn Main Dial to select frequency step.

1. Press and hold **[FUNC]** key for over 2 seconds to enter setting menu.
2. Press **[CALL]** / **[MONI]** key to choose No.01 menu, LCD displays "STP--125" 
3. Turn Main Dial to select the desired frequency channel step. Available steps in KHz are: 2.5 (shown as 2 K5), 6.25 (62), 8.33 (83), 10, 12.5 (125), 20, 25, 30 and 50.
4. Press **[TS/DCS]** key to confirm and exit



NOTE

This function is not available in memory-mode.

■ DTMF, DTMF ANI, 2TONE OR 5TONE SIGNALING

DTMF/5Tone/2Tone signalling are used for selective-calling. DTMF and 5Tone signalling can be applied for other advanced features such as ANI, PTT ID, group call, remotely stun, remotely kill, waken,...etc. The signalling edition must be done in advance to operations through programming software.

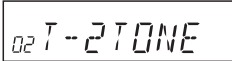
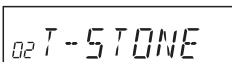
1. Press and hold **[FUNC]** key for over 2 seconds to enter into setting menu.
2. Press **[CALL]** / **[MONI]** to choose No 2 menu, LCD displays "T-OFF" .
3. Turn Main Dial to select the desired setup.
 - ▼ "DTMF": the channel will be mute by a DTMF signal. The speaker won't sound until receiving a correspondent DTMF signal. Hold "PTT" then press **[UP]** directly to transmit the pre-stored DTMF tones. 
 - ▼ "2TONE": the channel will be mute by a 2-Tone signal. The speaker won't sound until receiving a correspondent 2-Tone signal. Hold "PTT" then press **[UP]** to transmit the pre-stored 2-Tone signal. 
 - ▼ "5Tone": the channel will be mute by a 5-Tone signal. The Speaker won't sound until receiving a correspondent 5-Tone signal. hold **[PTT]** then press **[UP]** directly to transmit the pre-stored 5-Tone signal. 
4. Press **[TS/DCS]** key to confirm and exit.

SENDING 2-TONE CALL

1. Press and hold **[FUNC]** key for over 2 seconds to enter setting menu.
2. Press **[CALL]** / **[MONI]** key to choose No.03 menu, LCD displays "2TON XX", "XX" indicates the preprogrammed groups. 
3. Turn Main Dial to select the desired 2-TONE group, Press PTT to transmit selected group.
4. Total:32groups,00-31, Default: 00.
5. Press **[TS/DCS]** key to confirm and exit.



2-TONE will be operation parameters must be edited by programming software prior to the practical operation. This function is to only query edited group or name.

SENDING 5-TONE CALL

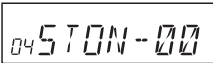
1. Press and hold **[FUNC]** key for over 2 seconds to enter setting menu.
2. Press **[CALL]** / **[MONI]** key to choose No.04 menu, LCD displays "5TON XX", "XX" indicates the preprogrammed groups. 
3. Turn Main Dial to select the desired 5-TONE group, Press **[PTT]** to transmit selected group.
4. Total:100groups,00-99,Default:00.
5. Press **[TS/DCS]** key to confirm and exit.



5-TONE operation parameters must be edited by programming software prior to the practical operation.

SENDING DTMF CALL

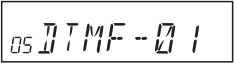
1. Press and hold **[FUNC]** key for over 2 seconds to enter setting menu.
2. Press **[CALL]** / **[MONI]** key to choose No.05 menu, LCD displays "DTMF XX", "XX" indicates the operation parameters must be. 
3. Turn Main Dial to select the desired DTMF group, Press PTT to transmit selected group.
4. Total:16groups,00-16,Default:00.
5. Press **[TS/DCS]** key to confirm and exit.

SIGNALING COMBINATION SETUP

This function is to improve the level of protecting the radio against receiving irrelative signal.

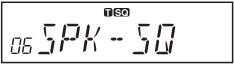
1. Press and hold **[FUNC]** key for over 2 seconds to enter setting menu.
2. Press **[CALL]** / **[MONI]** key to choose No.06 menu, LCD displays "SPK--SQ". 
3. Turn Main Dial to select the desired combination.

If select "SQ", it indicates you can hear the calling from caller when receive a matching carrier.

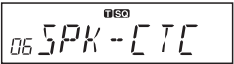
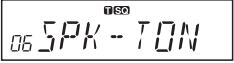
- ▼ If LCD displays "CTC", it indicates you can hear the calling from caller when receive a matching carrier and CTCSS/DCS signaling . 
- ▼ If LCD displays "TON", it indicates you can hear the calling from caller when receive a matching carrier and DTMF/2TONE/5TONE signaling . 

▼ If LCD displays "C*T", it indicates you can hear the calling from caller when receive a matching carrier and CTCSS/DCS and DTMF/2TONE/5TONE signaling .

▼ If LCD displays "C/T", it indicates you can hear the calling from caller when receive a matching carrier and either CTCSS/DCS DTMF/2TONE/5TONE signaling.

4. Press $\left[\frac{TS}{DCS} \right]$ key to confirm and exit.

 NOTE This function is available only for pre-programmed units with Tone-signals and CTCSS/DCS selective calling.

■ BAND-WIDTH SELECTION

Select suitable bandwidth in accordance with your local band-plans.

1. Press and hold $\left[\text{FUNC} \right]$ key for over 2 seconds to enter setting menu.
2. Press $\left[\text{CALL} \right] / \left[\text{MONI} \right]$ key to choose No.08 menu, LCD displays "BAND--25".
3. Turn Main Dial to select the desired setting.

12:band width is 12.5KHz(Narrow band)

4. Press $\left[\frac{TS}{DCS} \right]$ key to confirm and exit.

■ TX OFF SETUP

This function is to prohibit the transmission and to use the radio as a receiver.

1. Press and hold $\left[\text{FUNC} \right]$ key for over 2 seconds to enter setting menu.
2. Press $\left[\text{CALL} \right] / \left[\text{MONI} \right]$ key to choose No.09 menu, LCD displays "TX-ON".
3. Turn Main Dial to select the desired setting .

On:In current channel,Press PTT to transmit

OFF:In current channel,Press PTT is invalid.

4. Press $\left[\frac{TS}{DCS} \right]$ key to confirm and exit.

BUSY CHANNEL LOCKOUT

BCLO is to disable transmitting while RX signal is received. Once the channel is busy and you press PTT, the radio will beep as warning and get back to receiving.

1. Press and hold **[FUNC]** key for over 2 seconds to enter setting menu.
2. Press **[CALL]/[MONI]** key to choose No.10 menu, LCD displays "**LOCK--OFF**".
3. Turn selector knob to select the desired setting.

▼ BU: Enable BCLO, Carrier lockout, transmitting is inhibited when current channel receives a matching carrier.

▼ RL: Enable BTLO, transmitting is inhibited when current channel receives a matching carrier but dis-matching CTCSS/DCS.

▼ OFF: Busy channel lockout is disabled. It can transmit in any receiving status.

4. Press **[TS/DCS]** key to confirm and exit.

EDITING CHANNEL NAME (AVAILABLE ONLY IN MEMORY MODE)

1. In memory-mode, press and hold **[FUNC]** key for over 2 seconds to enter setting menu.
2. Press **[CALL]/[MONI]** key to choose No.11 menu, LCD displays cursor and flashing.
3. Turn Main Dial to select the desired letter, press **[TS/DCS]** key to confirm selected letter and enter into next edition, Press **[V/M]** to return forward edition.

4. After edition, press **[MHZ]** key to exit.



In Frequency display (VFO) mode, this menu is NOT available.

REVERSE TX/RX

TX frequency turns to RX frequency & RX frequency changes to TX frequency. CTCSS/DCS setting is respected also.

1. Press and hold **[FUNC]** key for over 2 seconds to enter setting menu.
2. Press **[CALL]/[MONI]** key to choose No.12 menu, LCD displays "**REV--ON**".
3. Turn Main Dial to select the desired setting.

ON: Enable Frequency Reverse

OFF: Disable Frequency Reverse.

4. Press **[TS/DCS]** key to set and exit.

TALK AROUND

By Talk Around function, you can directly communicate with other radios in your group in case the repeater is not activated or when you are out of the repeater range. The transceiver will transmit by RX frequency with its CTCSS/DCS signaling.

1. Press and hold **[FUNC]** key for over 2 seconds to enter setting menu.
2. Press **[CALL]/[MONI]** key to choose No.13 menu, LCD displays "**TALK--OF**".

3. Turn Main Dial to select the desired setting.

ON:Enable Talk Around

OFF:Disable Talk Around

4. After edition, press **[TS/DCS]** key to exit.

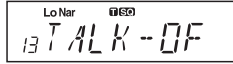
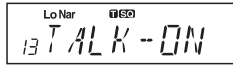

VOICE COMPANDER

Enable this function to reduce background noise and enhance audio clarity.

1. Press and hold **[FUNC]** key for over 2 seconds to enter setting menu.

2. Press **[CALL]/[MONI]** key to choose No.14 menu, LCD displays "COMP--OFF".

3. Turn Main Dial to select the desired setting.

ON:Enable compander

OFF:Disable compander

4. Press **[TS/DCS]** key to confirm and exit.

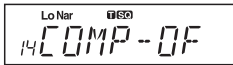
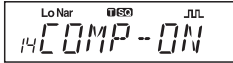

[NOTE] Enable all radios within the group. Not recommended in case NOT all radios are compander-compatible.

SCRAMBLER SETUP (ENCRYPTION)

An analog voice inversion scrambler is available as an option. This special audio process can offer a more confidential communication.

1. Press and hold **[FUNC]** key for over 2 seconds to enter setting menu.

2. Press **[CALL]/[MONI]** key to choose No.15 menu, LCD displays "SCR--OF".

3. Turn Main Dial to select the desired setting.

ON:Enable Scrambler

OF:Disable Scrambler

4. Press **[TS/DCS]** key to confirm and exit.

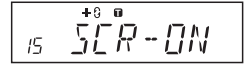

[NOTE] This setting operation is available to all units but actually works only with DR-438S version.

RADIO'S DTMF SELF ID ENQUIRY

1. Press and hold **[FUNC]** key for over 2 seconds to enter general setting menu.

2. Press **[CALL]/[MONI]** key to choose No.16 menu, LCD displays "D--XXX". XXX is radio's DTMF SELF ID.

3. Press **[TS/DCS]** key to confirm and exit.



RADIO'S STONE SELF ID ENQUIRY

1. Press and hold **[FUNC]** key for over 2s to enter general setting menu.

2. Press **[CALL]/[MONI]** key to choose No.17 menu, LCD displays "F--XXXXX", "XXXXX" is radio's 5STONE SELF ID.

3. Press **[TS/DCS]** key to confirm and exit.

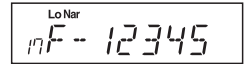

BEEP SOUND

The beep provides confirmation of entry, error status or malfunctions of the radio. You can enable or disable beep sounds.

1. Press and hold **(FUNC)** key for over 2 seconds to enter setting menu.
2. Press **(CALL)/(MONI)** key to choose No.18 menu, LCD displays"**BEEP--ON**".
3. Turn selector knob to select the desired setting.
ON:Enable beep sounds.
OFF:Disable beep sounds.
4. Press **(TS/DCS)** key to confirm and exit.

Lo Nar
18 BEEP--ON

Lo Nar
18 BEEP--OFF

TOT (TIME-OUT TIMER)

TOT prohibits the users from transmitting after a certain period of time has elapsed. When the time is over,transmitting stops and automatically returns to receiving. Until the PTT is released once and pressed again, the radio will not transmit.

1. Press and hold **(FUNC)** key for over 2 seconds to enter setting menu.
2. Press **(CALL)/(MONI)** key to choose No.19 menu, LCD displays"**TOT--3**".
3. Turn Main Dial to select the desired timer setting.
Timer:1-30min,each level 1min
OFF: Disable TOT
4. Press **(TS/DCS)** key to confirm and exit.

Lo Nar
19 TOT-- 3

APO (AUTO POWER OFF)

Once APO is activated, the radio will be automatically switched off when the pre-set time is elapsed.

1. Press and hold **(MONI)** key for over 2 seconds to enter setting menu.
2. Press **(CALL)/(MONI)** key to choose No.20 menu, LCD displays"**APO--OFF**".
3. Turn selector knob to select the desired setting.
30MIN:Auto power off after 30m
1HOUR:Auto power off after 1h
2HOUR:Auto power off after 2h
OFF:Disable Auto power off
4. Press **(TS/DCS)** key to confirm and exit.

Lo Nar A
20 APO-- 30

Lo Nar A
20 APO--OFF

DTMF TRANSMITTING TIME

1. Press and hold **(FUNC)** key for over 2 seconds to enter setting menu.
2. Press **(CALL)/(MONI)** key to choose No.21 menu, LCD displays"**SPD--50**".
3. Turn Main Dial to select the desired setting, in milliseconds.
30/50/100/200/300/500, which indicates the time for sending each DTMF signal & the interval between each DTMF being sent.
4. Press **(TS/DCS)** key to confirm and exit.

Lo Nar
21 SPD-- 50

■ DISPLAY ILLUMINATION COLOR SETTING

This is to select the display illumination color.

1. Press and hold **(CALL)/(MONI)** key for over 2 seconds to enter setting menu.
2. Press **(CALL)/(MONI)** key to choose No.22 menu, LCD displays "**COL--ORG**".
3. Turn Main Dial to select the desired color. Available colors are: **ORG-Orange, PUR-Purple, and BLU-Blue.**
4. Press **(TS/DCS)** key to confirm and exit.

■ SCAN RESUME TIME SETUP

There are 3 kinds of scan resume conditions.

1. Press and hold **(FUNC)** key for over 2 seconds to enter setting menu.
2. Press **(CALL)/(MONI)** key to choose No.23 menu, LCD displays "**SCAN--TO**".
3. Turn Main Dial to select the desired Scan Resume Time.

TO: Timed Scan, it resumes scanning after receiving 5 seconds or when the signal is gone, which ever faster.

CO: Busy Scan, it resumes scanning when the receiving signal is gone.

SE: Stops scanning when a signal is received.

4. Press **(TS/DCS)** key to confirm the selection and exit.

Lo Nar
23 SC AN--TO

Lo Nar
23 SC AN--CO

Lo Nar
23 SC AN--SE

■ LCD DIMMER

1. Press and hold **(FUNC)** key for over 2 seconds to enter setting menu.

2. Press **(CALL)/(MONI)** key to choose No.24 menu, LCD displays "**LAMP--25**".
3. Turn Main Dial to select the desired LCD brightness; 1 to turn off, 32 to the brightest.
4. Press **(TS/DCS)** key to confirm and exit.

Lo Nar
24 LAMP--25

■ TONE-BURST TONES

1. Press and hold **(FUNC)** key for over 2 seconds to enter setting menu.
2. Press **(CALL)/(MONI)** key to choose No.25 menu, LCD displays "**TB--1750**".
3. Turn Main Dial to select the desired tone frequency. Available tones are 1000,1450,1750 and 2100Hz.
4. Press **(TS/DCS)** key to confirm the selection and exit.

Lo Nar
25 TB--1750

■ DISPLAY MODE SETUP

There are 3 different display modes: Frequency+Memory mode, Channel mode&Channel+Name Tag mode.

1. Press and hold **(FUNC)** key for over 2 seconds to enter setting menu.
2. Press **(CALL)/(MONI)** key to choose No.26 menu, LCD displays "**DSP--FR**".
3. Turn Main Dial to select the desired mode.
FR: Frequency+Memory mode.
CH:Channel mode.
NM:Channel+Name Tag mode,if channel not named, it displays Frequency + Memory mode.

Lo Nar
26 DSP--FR

Lo Nar +
26 DSP--CH

Lo Nar +
26 DSP--NM

4. Press **(TS/DCS)** key to confirm and exit.



This function may not be available in dealer-programmed units.

PIN SETUP (USELESS IF PIN IS NOT ASSIGNED)

Enable this function, you have to insert a matching PIN to enter into normal status when radio is turned on. (The PIN can be assigned by programming software only.)

1. Press and hold **[FUNC]** key for over 2 seconds to enter setting menu.
2. Press **[CALL]/[MONI]** key to choose No.27 menu, LCD displays "CODE-OF".
3. Turn Main Dial to enable/disable Pin setup.
ON: Turn on Pin setup
OFF: Turn off Pin setup
4. Press **[TS/DCS]** key to confirm and exit.

ADDRESS LIST

You store desired ID and corresponding ID name in address list. The LCD displays ID corresponding name if radio received ANI calling and find matching ID in address list.

1. Press and hold **[FUNC]** key for over 2 seconds to enter general setting menu.
2. Press **[CALL]/[MONI]** key to choose No.28 menu, LCD displays "BOOK".
3. Press **[MHZ]** to enter into ID setting, press **[CALL]/[MONI]** to select the desired group (00-127, total is 128 group ID). Turn Main Dial to select desired number, press **[TS/DCS]** confirm and move cursor

to next edition, press **[V/M]** to clear out all digits.

4. After finishing edition, press **[V/M]** to confirm and enter into edition of current group's ID corresponding name. Turn selector knob to select desired letter, press **[TS/DCS]** to move cursor to next edition, press **[V/M]** to clear out all letters. 00-127, total 128 group ID and corresponding ID name.
5. Press **[MHZ]** to confirm and return into main menu. Repeat above Step 3 and Step 4 operations to edit multi-ID and corresponding ID name.
6. Press **[TS/DCS]** key to return to standby status.

RESET (May be blocked for dealer-programmed units)

If your radio seems to be malfunctioning, resetting the microprocessor may solve the problem. When performing the reset, you may lose memory data and stored information. Back up or write down important data before performing the reset.

1. Press and hold **[FUNC]** key for over 2 seconds to enter general setting menu.
2. Press **[CALL]/[MONI]** key to choose No.29 menu, LCD displays "RESTORE".
3. Turn Main Dial to select the desired operation.

FACT: Resume factory default for channel, signaling and general setting.

SETUP: Return initial setup for No.18-No 27 general setting menu.

4. Press **[MHZ]** key to perform the reset.

* In this chapter, operations shown with is available to all units, is subject to dealer-programming or restrictions. Some of features may be functional in memory mode temporary, but the setting will return to the initial parameters after changing channel or turned off the unit.

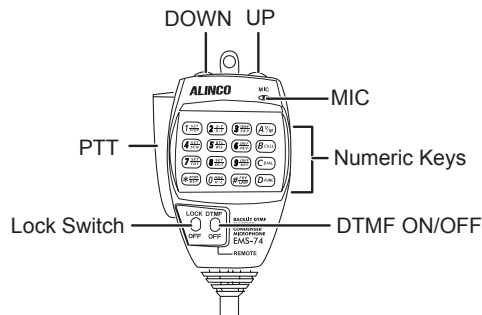

You can operate the transceiver by keypad or input desired frequency or channel through the EMS-74 microphone. Keypad operations may be blocked for dealer-programmed units.

KEYPAD LOCK

Pull down the slide switch to lock position, The lamp is turned off and all of keypads is not work except PTT switch.

TRANSMITTING DTMF BY MICROPHONE KEYPAD

Slide DTMF key to DTMF position, press and hold the [PTT] key, transmitting the desired DTMF signaling by the numeric key directly.

NOTE The keypad operation is suspended in DTMF position.

FUNCTION SETUP BY MICROPHONE KEYPAD

Squelch off: In standby, press ***STP** key, the squelch is disabled when **BUSY** icon

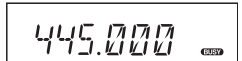

flashed in LCD, Press ***STP** again to enable squelch and the **BUSY** icon disappears.

SWITCHES BETWEEN VFO AND CHANNEL MODE

In standby, press **A/V/M** key to switch between channel mode and Frequency mode (VFO).

SHORT CALLING CALL CHANNEL

In standby, press **B/CALL** key to switch transceiver to CALL channel, press **V/M** key to exit.

TRANSMITTING DTMF CODE

In standby, press **C/DIAL**, LCD displays DTMF data and group. Press [**UP** / **DOWN**] key to select the desired transmitting DTMF group, then Press PTT to transmit.

If no DTMF data in current group, LCD displays "EMPTY", press **C/DIAL** key again and input desired DTMF code by keypad, press PTT to transmit and store DTMF data.

FREQUENCY STEP

Only in VFO mode, this function is valid.

1. Press **D/FUNC**, then press **1 STP**, LCD displays "STP--125"
2. Press **UP** / **DOWN** to select the desired frequency channel step.
3. Press any numeric keys to save and exit.

OPTIONAL SIGNALING

In standby, press **D/FUNC**, then press **2 2-5 T** to add optional signaling, repeat above operation to set DTMF, 2TONE or 5TONE signaling.

- * D: DTMF
- * T: 2-tone
- * F: 5-tone

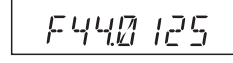
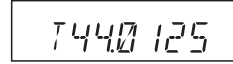
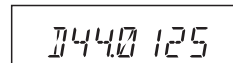



This function can be temporarily used in channel mode. Once the radio is turned off or switched to another channel, the temporary setting will be erased and back to initial settings.

☐ SCAN SKIP

In Channel mode, press **[D.FUNC]** then press **[3.000]**, decimal point appears. It means current channel is scan skip. Repeat above operation to set scan or scan skip in current channel. Decimal point disappears when the channel is available for scanning.

■ FREQUENCY/CHANNEL SCAN

In corresponding mode, press **[D.FUNC]** then press **[4.SEL]** key to start scanning.

In scanning mode, press **[UP]** / **[DOWN]** to change scan direction.

Press **[PTT]** to stop scanning.

☐ BUSY CHANNEL LOCKOUT

BCLO is to disable transmitting while RX signal is received. Once the channel is busy and you press PTT, the radio will beep as warning and get back to receiving.

1. In standby, press **[D.FUNC]**, then press **[5.SEL]** to enter into Busy Channel Lockout.
2. Press **[UP]** / **[DOWN]** to select the desired value.

BU: Enable BCLO, Carrier lockout, transmitting is inhibited when current channel receives a matching carrier; press **[PTT]** to emit error voice prompt.

RL: Enable BTLO, transmitting is inhibited when current channel receives a matching carrier but dis-matching CTCSS/DCS. press **[PTT]** to emit error voice prompt It can transmit in any receiving status.

OFF: Busy channel lockout is disabled.

3. Press number keys to confirm and exit.

☐ REVERSE TX/RX

TX frequency turns to RX frequency & RX frequency changes to TX frequency. The signaling will also be reversed if CTCSS/DCS signaling exited in this channel.

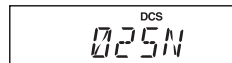

1. In standby, press **[D.FUNC]**, then press **[6.ONP.REV]**, LCD displays "REV—OF".
2. Press **[UP]** / **[DOWN]** to select the desired value.

ON: Enable Frequency Reverse

OFF: Disable Frequency Reverse

3. Press number keys to confirm and exit.

☐ TOT (TIME-OUT TIMER)

The time-out timer limits the amount of transmitting time. When you reach the time limit which has been programmed by your dealer, your transmission will be cut off. In order to transmit again, you must release PTT button to reset the timer.

1. In standby, press **[D.FUNC]**, then press **[7.SEL.TOT]** "LCD displays "TOT-X".
2. Press **[UP]** / **[DOWN]** to select the desired value.
3. Press number key to confirm and exit.

☐ CTCSS/DCS ENCODE AND DECODE

1. In standby, press **[D.FUNC]**, then press **[8.SEL]** to enter into CTCSS/DCS Encode and Decode.
2. Repeat above operation to set as below:

- ▼ LCD displays T icon,it indicates CTCSS encode set in current channel.
 - ▼ LCD displays T and SQ icon,it indicates CTCSS encode and decode set in current channel.
 - ▼ LCD displays DCS icon,it indicates DCS encode and decode set in current channel.
3. In corresponding icon,press [**UP** / **DOWN**] to select the desired CTCSS/DCS encode and decode.
4. Press ***SKIP**, **A/M**, or **C/DIAL** to confirm and exit.

□ TALK AROUND

By Talk Around function,you can directly communicate with other radios in your group in case the repeater is not activated or when you are out of the repeater range. The transceiver will transmit by RX frequency with its CTCSS/DCS signaling.

1. In standby,press **D/FUNC**,then press **9/SKIP** key,LCD displays "TALK--OF".
2. Press [**UP** / **DOWN**] to select the desired setting .
ON:Enable Talk Around
OFF:Disable Talk Around
3. Press number key to confirm and exit.

□ BEEP SOUND

The prompting tone provides confirmation of entry, error status or malfunctions of the transceiver. You can enable or disable this function.

1. In standby, press **D/FUNC**, then press ***SKIP**, LCD displays "BEEP--XX".
2. Press [**UP** / **DOWN**] to turn on/off BEEP prompt.
BEEP—OF :turn off the beep;
BEEP—ON :turn on the beep.

3. Press number key to confirm and exit.

□ LCD BACKLIGHT

1. In standby status, press **D/FUNC** , then press **#/LAMP** LCD displays "LAMP-XX" .
2. Press [**UP** / **DOWN**] to select desired backlight brightness(1-32 levels).
3. Press number key to confirm and exit.

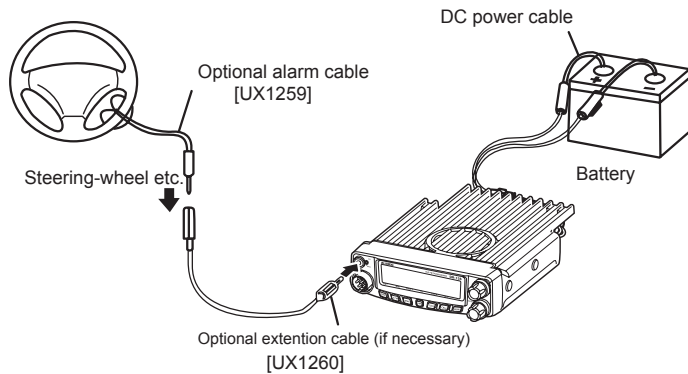

By removing or cutting the cable before turning on will sound alarm. To turn off the alarm, press PWR key to turn off the power. The alarm is canceled and turns on normally when PWR key is pressed next time.

A loud alert beep sounds when the unit is about to be removed in an improper manner. This function is useful when the unit is installed in a vehicle.

Setting: Connect the DC cable direct to the battery as shown.

Operation:

1. Connect the optional alarm cable to the DATA jack on the front panel as shown WHILE POWER IS ON. Secure the other end of the cable to an object that stays fixed in the vehicle. Use an optional extension cable if necessary.
2. Turn off the unit by pressing the PWR key. The alarm is now active.
3. To operate, turn on the unit first then remove the cable while power is ON.

This feature clones the programmed data and parameters in the master unit to slave units.

1. Use commonly available audio-cable with 3.5 mm stereo-mini plugs as shown below. Make a master unit by setting and programming it as desired. Turn on both units. Connect the cable between the DATA jacks on both units.
2. Press and hold master unit **[FUNC]** key, then press **[CALL]** key to enter into cloning mode, LCD displays "**CLONE**".

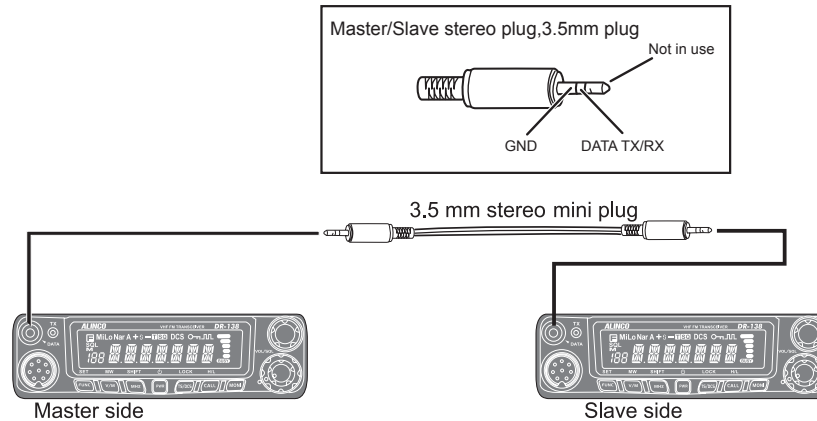

3. Press master unit's **[PTT]** key, LCD displays "**CLONEXX**". Slave unit displays "**CLONEXXX**". When the cloning is successfully finished, the slave unit will restart. Turn off the power, disconnect the cable and repeat step 3 operations to clone the next slave unit.



NOTE If the data is not successfully transmitted, turn off both units, make sure the cable connection is correct and repeat the entire operation from the beginning.

■ DEFAULT SETTING AFTER RESETTING

	DR-438	DCS encode and decode	—
VFO frequency	445.000MHz	DCS code	023N
Memory channel 0–199	—	Output power	HI
Offset direction	—	Key-lock setting	OFF
Offset frequency	5.000M	TOT	OFF
Channel step	12.5KHz	APO	OFF
CTCSS encode and decode	—	Squelch Level	4
CTCSS frequency	88.5Hz	LCD color	Orange

Optional functions will be basically deactivated and programmed values are erased.

■ TROUBLE SHOOTING

Problem	Possible Causes and Potential Solutions
(a) Power is on, nothing appears on Display.	+ and - polarities of power connection are reversed. Connect red lead to plus terminal and black lead to minus terminal of DC power supply.
(b) Fuse is blown.	Check and solve problem resulting in blown fuse and replace fuse with a new one.
(c) Display is too dim.	Set the LCD backlight parameter properly.
(d) No sound comes from speaker.	<ul style="list-style-type: none"> • Squelch level too high. Decrease squelch level. • Selective-calling like TSQ activated. Press [Moni] key to monitor.
(e) Key and Dial do not function.	Key-lock function is activated. Cancel Key-lock function.
(i) Rotating Dial will not change memory channel.	Transceiver is in CALL mode. Press (A/M) .
(g) PTT key is pressed but doesn't transmit.	<ul style="list-style-type: none"> • Microphone connection is poor. Connect microphone properly. • Antenna connection is poor. Connect antenna properly.

Please contact your dealer when a technical assistanc may be necessary.

General

Frequency Range	UHF: 400-470MHz
Number of Channels	200 channels
Channel Spacing	12.5KHz (Narrow band)
Channel step	2.5KHz, 5KHz, 6.25KHz, 8.33KHz, 10KHz, 12.5KHz
Operating Voltage	13.8V DC \pm 15%
Squelch	Carrier/CTCSS/DCS/5Tone/2Tone/DTMF
Frequency Stability	\pm 2.5ppm
Operating Temperature	-20 $^{\circ}$ C~+60 $^{\circ}$ C
Dimensions(WxHxD)	145 (W) x 47 (H) x 190 (L)mm
Weight	about 1.2Kg

 Specifications are subject to change without notice due to advancements in NOTE technology.

Receiver (ETSI EN 300 086 standard testing)

	Narrow band
Sensitivity (12dB Sinad)	\leq 0.35 μ V
Adjacent Channel Selectivity	\geq 60dB
Intermodulation	\geq 60dB
Spurious Rejection	\geq 70dB
Audio Response	+1~-3dB(0.3~2.55KHz)
Hum & Noise	\geq 40dB
Audio distortion	\leq 5%
Audio power output	> 2W@10%

Transmitter (ETSI EN 300 086 standard testing)

	Narrow band
Power Output	40W
Modulation	11K Φ F3E
Adjacent Channel Power	\geq 60dB
Hum & Noise	\geq 36dB
Spurious Emission	\geq 60dB
Audio Response	+1~-3dB(0.3~2.55KHz)
Audio Distortion	\leq 5%

14 Appendix

50 GROUPS CTCSS TONE FREQUENCY(HZ)

67.0	79.7	94.8	110.9	131.8	156.7	171.3	186.2	203.5	229.1
69.3	82.5	97.4	114.8	136.5	159.8	173.8	189.9	206.5	233.6
71.9	85.4	100.0	118.8	141.3	162.2	177.3	192.8	210.7	241.8
74.4	88.5	103.5	123.0	146.2	165.5	179.9	196.6	218.1	250.3
77.0	91.5	107.2	127.3	151.4	167.9	183.5	199.5	225.7	254.1

1024 GROUPS DCS CODE.

000	001	002	003	004	005	006	007
010	011	012	013	014	015	016	017
020	021	022	023	024	025	026	027
030	031	032	033	034	035	036	037
040	041	042	043	044	045	046	047
050	051	052	053	054	055	056	057
060	061	062	063	064	065	066	067
070	071	072	073	074	075	076	077
100	101	102	103	104	105	106	107
110	111	112	113	114	115	116	117
120	121	122	123	124	125	126	127
130	131	132	133	134	135	136	137
140	141	142	143	144	145	146	147
150	151	152	153	154	155	156	157
160	161	162	163	164	165	166	167
170	171	172	173	174	175	176	177
200	201	202	203	204	205	206	207
210	211	212	213	214	215	216	217
220	221	222	223	224	225	226	227
230	231	232	233	234	235	236	237
240	241	242	243	244	245	246	247
250	251	252	253	254	255	256	257
260	261	262	263	264	265	266	267
270	271	272	273	274	275	276	277
300	301	302	303	304	305	306	307
310	311	312	313	314	315	316	317

320	321	322	323	324	325	326	327
330	331	332	333	334	335	336	337
340	341	342	343	344	345	346	347
350	351	352	353	354	355	356	357
360	361	362	363	364	365	366	367
370	371	372	373	374	375	376	377
400	401	402	403	404	405	406	407
410	411	412	413	414	415	416	417
420	421	422	423	424	425	426	427
430	431	432	433	434	435	436	437
440	441	442	443	444	445	446	447
450	451	452	453	454	455	456	457
460	461	462	463	464	465	466	467
470	471	472	473	474	475	476	477
500	501	502	503	504	505	506	507
510	511	512	513	514	515	516	517
520	521	522	523	524	525	526	527
530	531	532	533	534	535	536	537
540	541	542	543	544	545	546	547
550	551	552	553	554	555	556	557
560	561	562	563	564	565	566	567
570	571	572	573	574	575	576	577
600	601	602	603	604	605	606	607
610	611	612	613	614	615	616	617
620	621	622	623	624	625	626	627
630	631	632	633	634	635	636	637
640	641	642	643	644	645	646	347
650	651	652	653	654	655	656	657
660	661	662	663	664	665	666	667
670	671	672	673	674	675	676	677

700	701	702	703	704	705	706	707
710	711	712	713	714	715	716	717
720	721	722	723	724	725	726	727
730	731	732	733	734	735	736	737
740	741	742	743	744	745	746	747
750	751	752	753	754	755	756	757
760	761	762	763	764	765	766	767
770	771	772	773	774	775	776	777



NOTE N is positive code, I is negative code, total: 1024groups.

SAFETY TRAINING INFORMATION



Your Qixiang Electron Science & Technology Co., Ltd radio generates RF electromagnetic energy during transmit mode. This radio is designed for and classified as “Occupational Use Only”, meaning it must be used only during the course of employment by individuals aware of the hazards, and the ways to minimize such hazards. This radio is NOT intended for use by the “General Population” in an uncontrolled environment.

This radio has been tested and complies with the FCC RF exposure limits for “Occupational Use Only”. In addition, your Qixiang Electron Science & Technology Co., Ltd radio complies with the following Standards and Guidelines with regard to RF energy and electromagnetic energy levels and evaluation of such levels for exposure to humans:

- ▮ FCC OET Bulletin 65 Edition 97-01 Supplement C, Evaluating Compliance with FCC Guidelines for Human Exposure to Radio Frequency Electromagnetic Fields.
- ▮ American National Standards Institute (C95.1-1992), IEEE Standard for Safety Levels with Respect to Human Exposure to Radio Frequency Electromagnetic Fields, 3 kHz to 300 GHz.
- ▮ American National Standards Institute (C95.3-1992), IEEE Recommended Practice for the Measurement of Potentially Hazardous Electromagnetic Fields— RF and Microwave.
- ▮ The following accessories are authorized for use with this product. Use of accessories other than those (listed in the instruction) specified may result in RF exposure levels exceed the FCC requirements for wireless RF exposure.



The information listed above provides the user with the information needed to make him or her aware of RF exposure, and what to do to as-sure that this radio operates with the FCC RF exposure limits of this radio.

Electromagnetic Interference/Compatibility

During transmissions, your Qixiang Electron Science & Technology Co., Ltd radio generates RF energy that can possibly cause interference with other devices or systems. To avoid such interference, turn off the radio in areas where signs are posted to do so. **DO NOT** operate the transmitter in areas that are sensitive to electromagnetic radiation such as hospitals, aircraft, and blasting sites.

Occupational/Controlled Use

The radio transmitter is used in situations in which persons are exposed as consequence of their employment provided those persons are fully aware of the potential for exposure and can exercise control over their exposure.

In order to comply with RF exposure requirements, a minimum distance of 200cm must be maintained between the antenna and all persons