

Figure 103: 99% Bandwidth-5825MHz-HT20-MCS0-Ch2

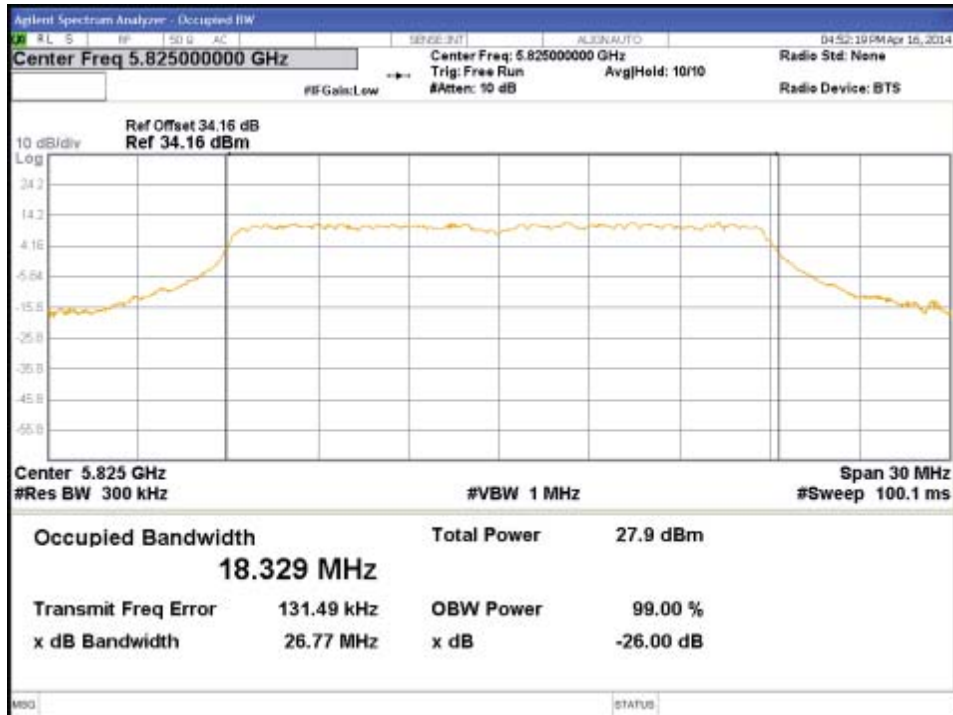

Figure 104: 99% Bandwidth-5825MHz-HT20-MCS0-Ch3



Figure 105: 6 dB Bandwidth-5755MHz-HT40-MCS0-Ch0



Figure 106: 6 dB Bandwidth-5755MHz-HT40-MCS0-Ch1



Figure 107: 6 dB Bandwidth-5755MHz-HT40-MCS0-Ch2



Figure 108: 6 dB Bandwidth-5755MHz-HT40-MCS0-Ch3



Figure 109: 6 dB Bandwidth-5795MHz-HT40-MCS0-Ch0



Figure 110: 6 dB Bandwidth-5795MHz-HT40-MCS0-Ch1



Figure 111: 6 dB Bandwidth-5795MHz-HT40-MCS0-Ch2



Figure 112: 6 dB Bandwidth-5795MHz-HT40-MCS0-Ch3



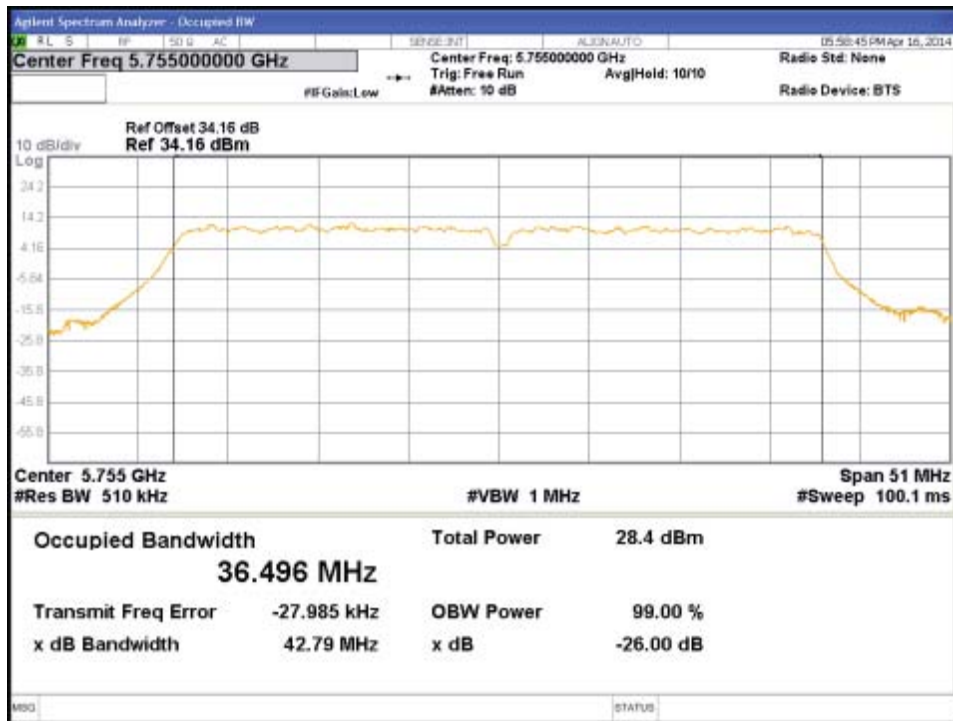

Figure 113: 99% Bandwidth-5755MHz-HT40-MCS0-Ch0

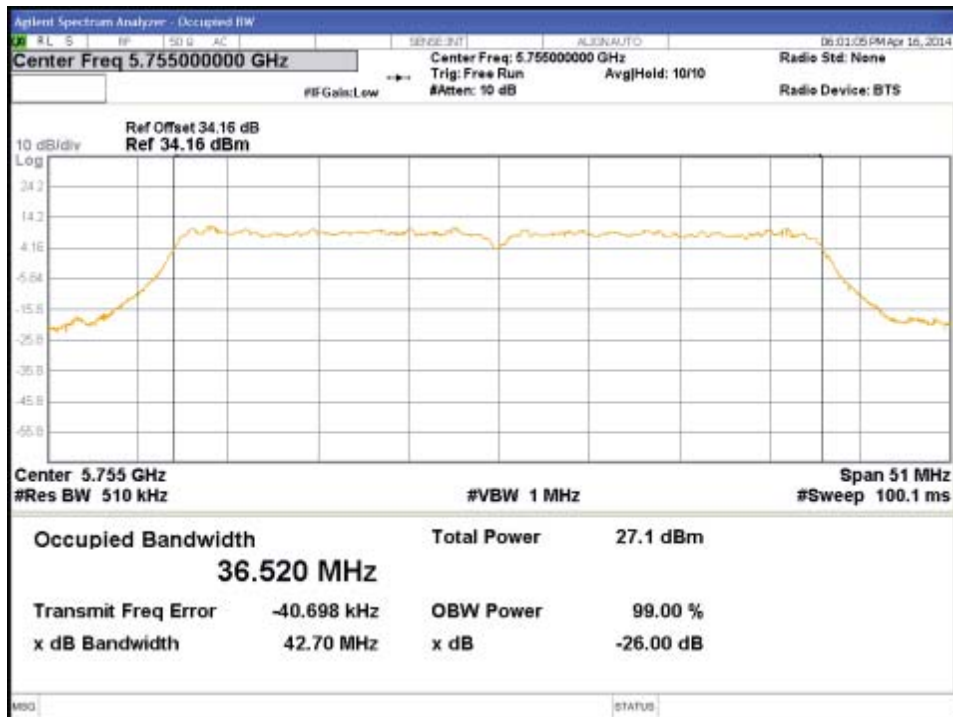

Figure 114: 99% Bandwidth-5755MHz-HT40-MCS0-Ch1

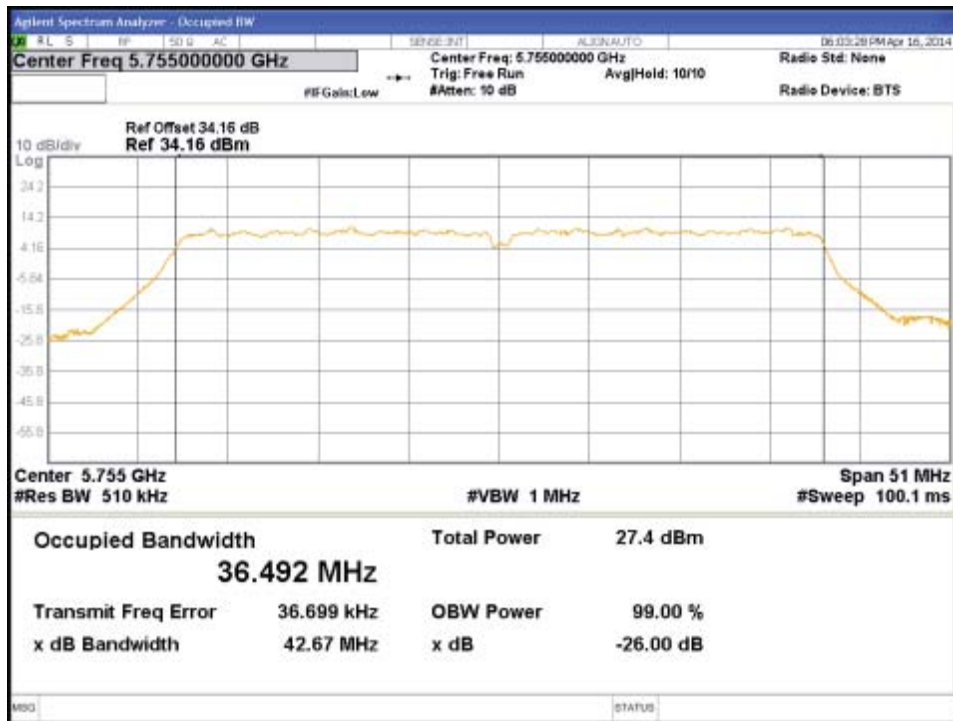

Figure 115: 99% Bandwidth-5755MHz-HT40-MCS0-Ch2

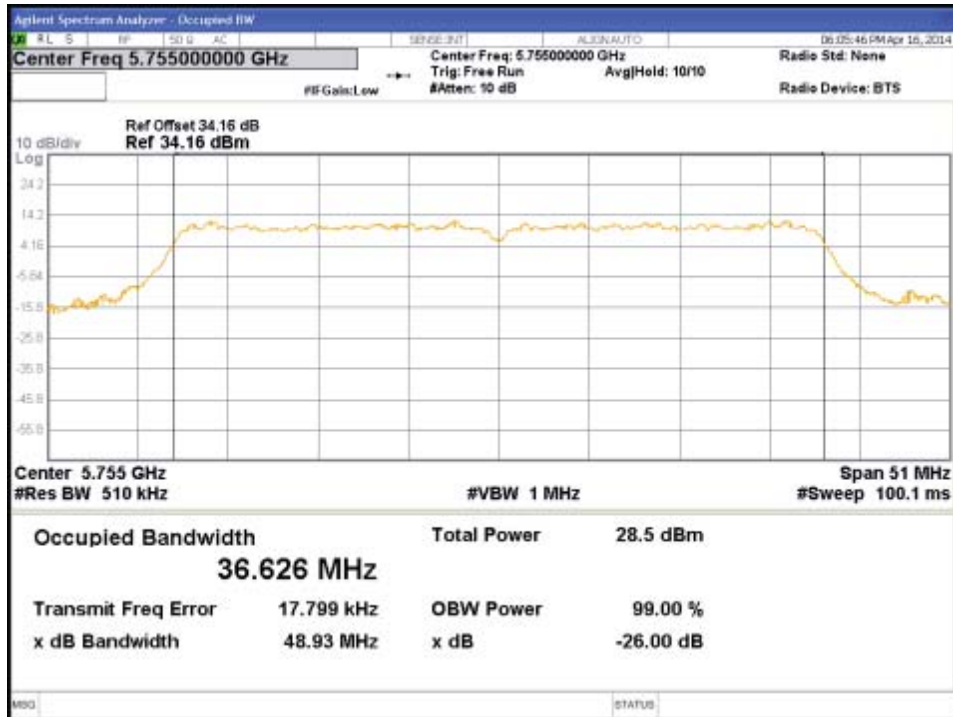

Figure 116: 99% Bandwidth-5755MHz-HT40-MCS0-Ch3

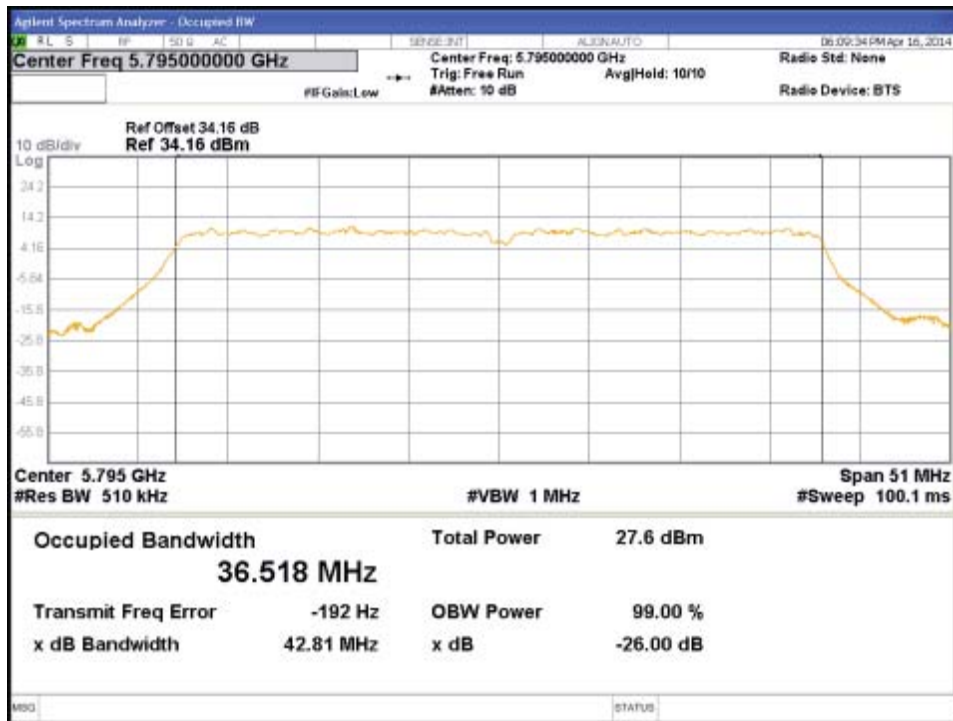

Figure 117: 99% Bandwidth-5795MHz-HT40-MCS0-Ch0

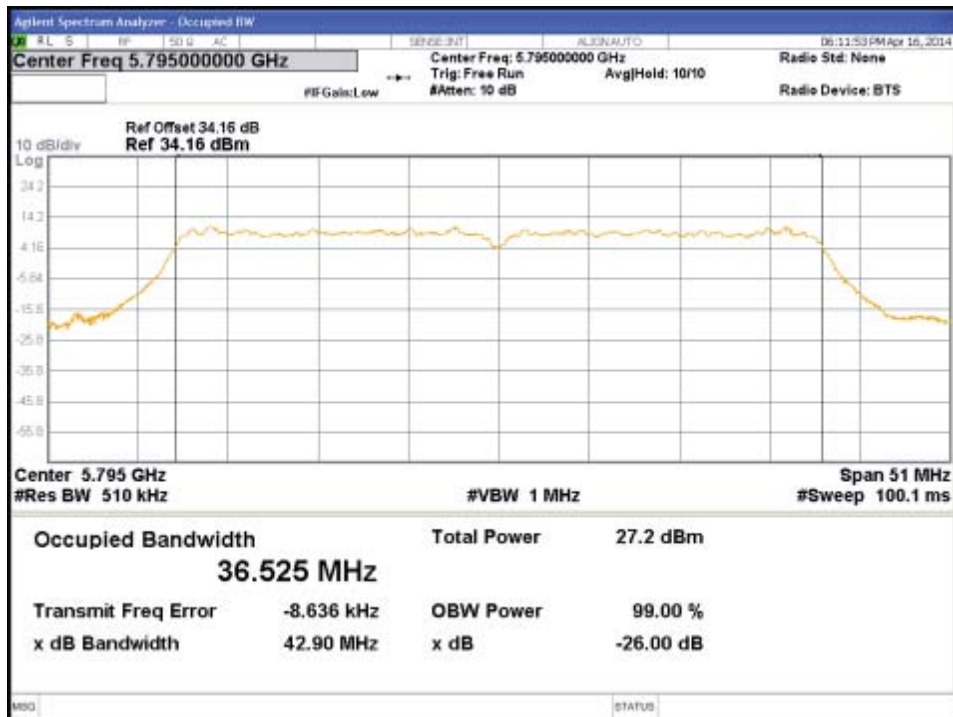

Figure 118: 99% Bandwidth-5795MHz-HT40-MCS0-Ch1



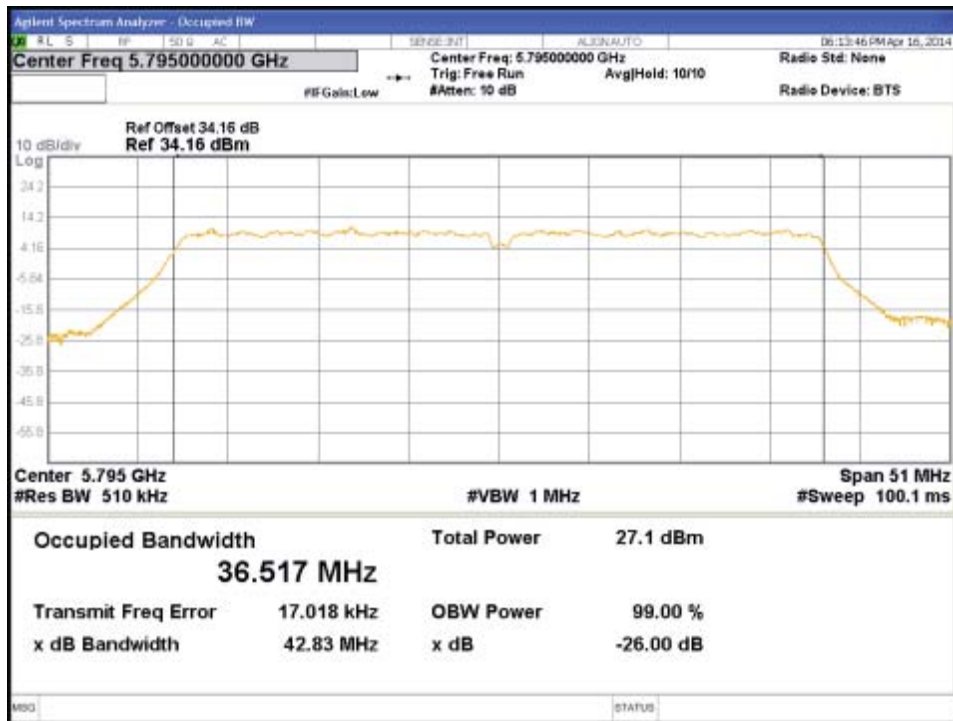

Figure 119: 99% Bandwidth-5795MHz-HT40-MCS0-Ch2

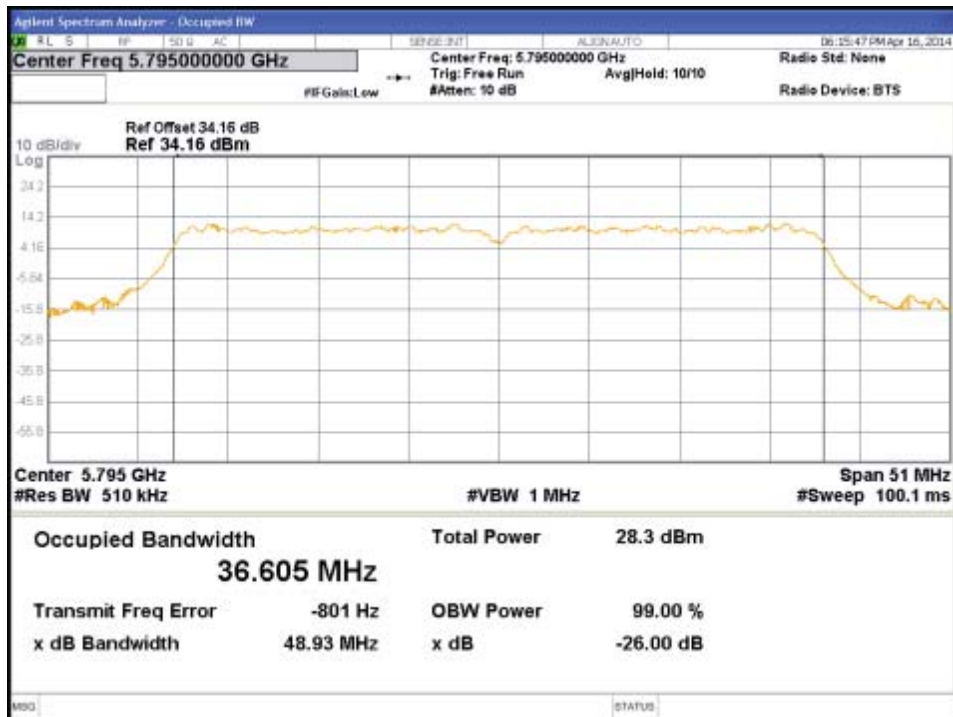

Figure 120: 99% Bandwidth-5795MHz-HT40-MCS0-Ch3



Figure 121: 6 dB Bandwidth-5745MHz-VHT20-MCS0-Ch0



Figure 122: 6 dB Bandwidth-5745MHz-VHT20-MCS0-Ch1



Figure 123: 6 dB Bandwidth-5745MHz-VHT20-MCS0-Ch2



Figure 124: 6 dB Bandwidth-5745MHz-VHT20-MCS0-Ch3



Figure 125: 6 dB Bandwidth-5785MHz-VHT20-MCS0-Ch0



Figure 126: 6 dB Bandwidth-5785MHz-VHT20-MCS0-Ch1



Figure 127: 6 dB Bandwidth-5785MHz-VHT20-MCS0-Ch2



Figure 128: 6 dB Bandwidth-5785MHz-VHT20-MCS0-Ch3





Figure 129: 6 dB Bandwidth-5825MHz-VHT20-MCS0-Ch0



Figure 130: 6 dB Bandwidth-5825MHz-VHT20-MCS0-Ch1



Figure 131: 6 dB Bandwidth-5825MHz-VHT20-MCS0-Ch2



Figure 132: 6 dB Bandwidth-5825MHz-VHT20-MCS0-Ch3

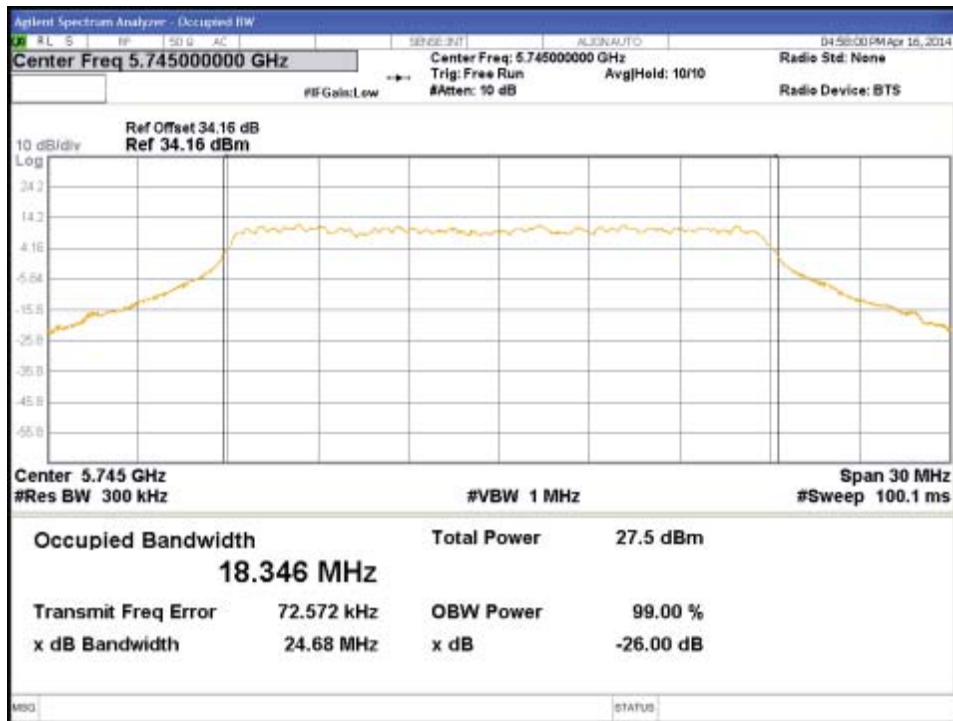

Figure 133: 99% Bandwidth-5745MHz-VHT20-MCS0-Ch0

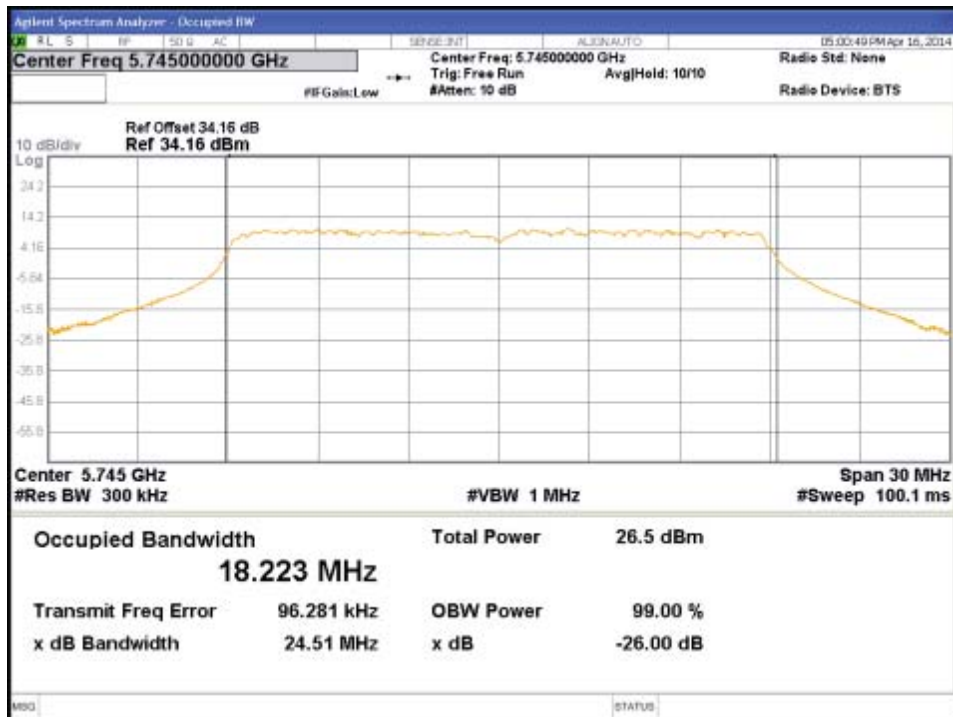

Figure 134: 99% Bandwidth-5745MHz-VHT20-MCS0-Ch1

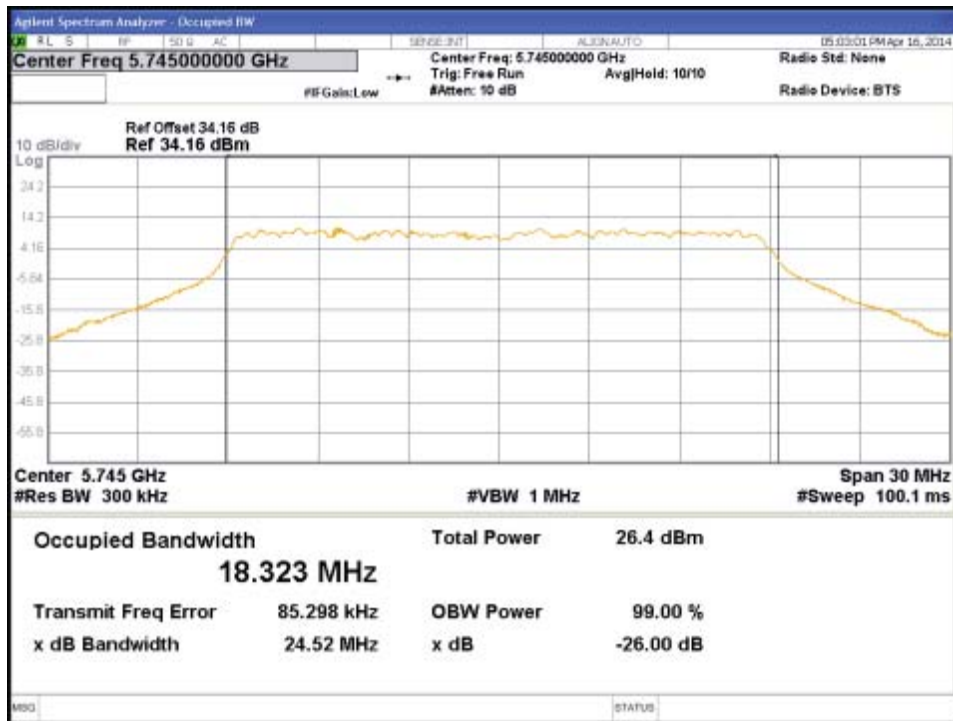

Figure 135: 99% Bandwidth-5745MHz-VHT20-MCS0-Ch2

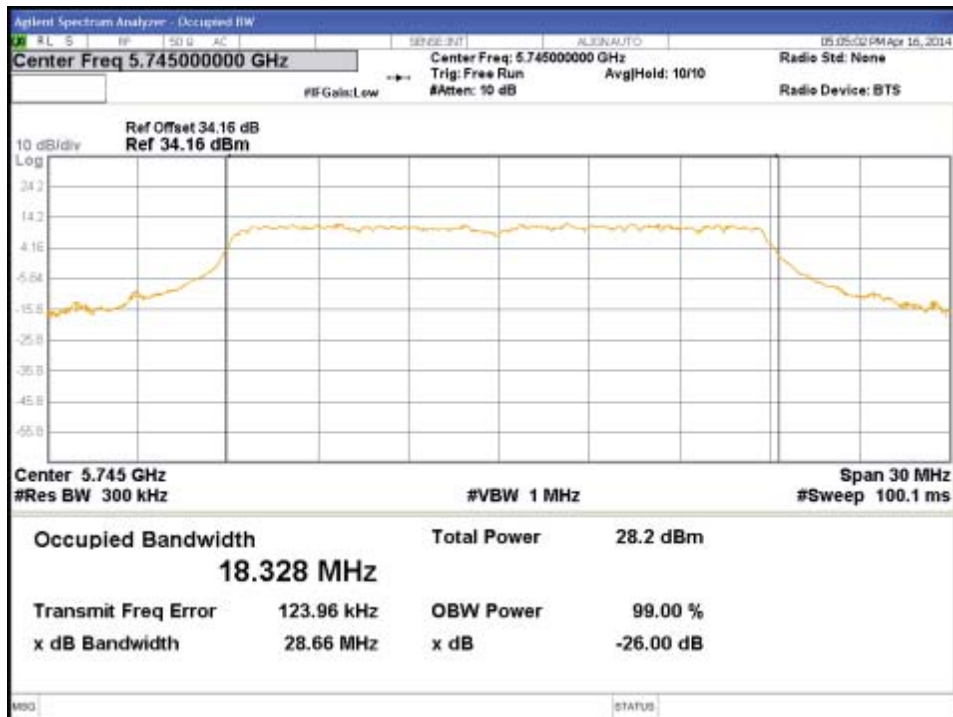

Figure 136: 99% Bandwidth-5745MHz-VHT20-MCS0-Ch3

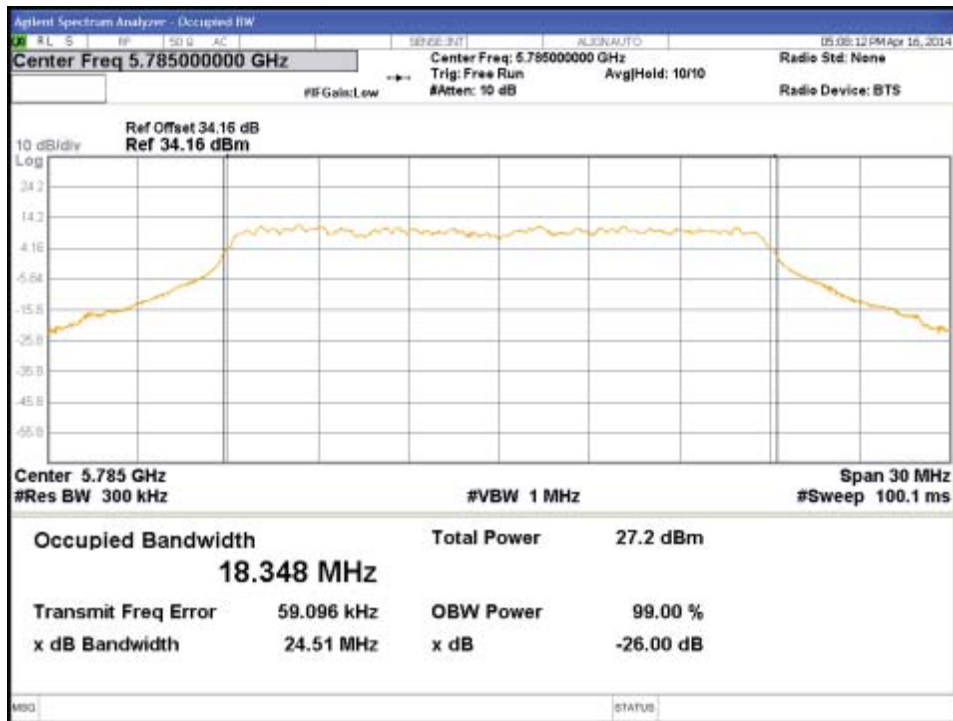

Figure 137: 99% Bandwidth-5785MHz-VHT20-MCS0-Ch0

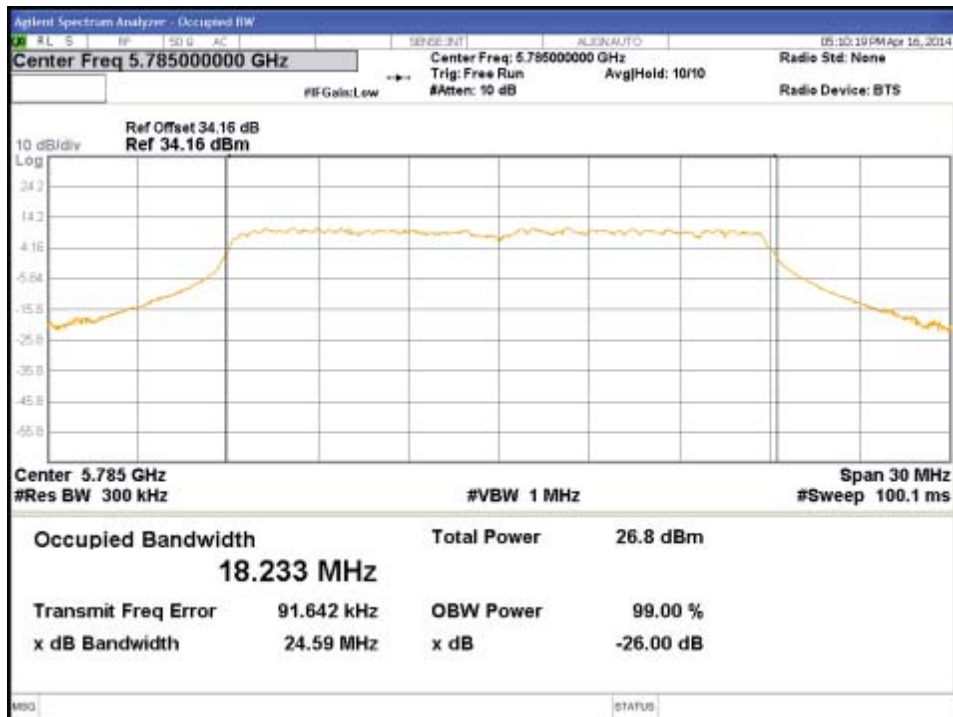

Figure 138: 99% Bandwidth-5785MHz-VHT20-MCS0-Ch1



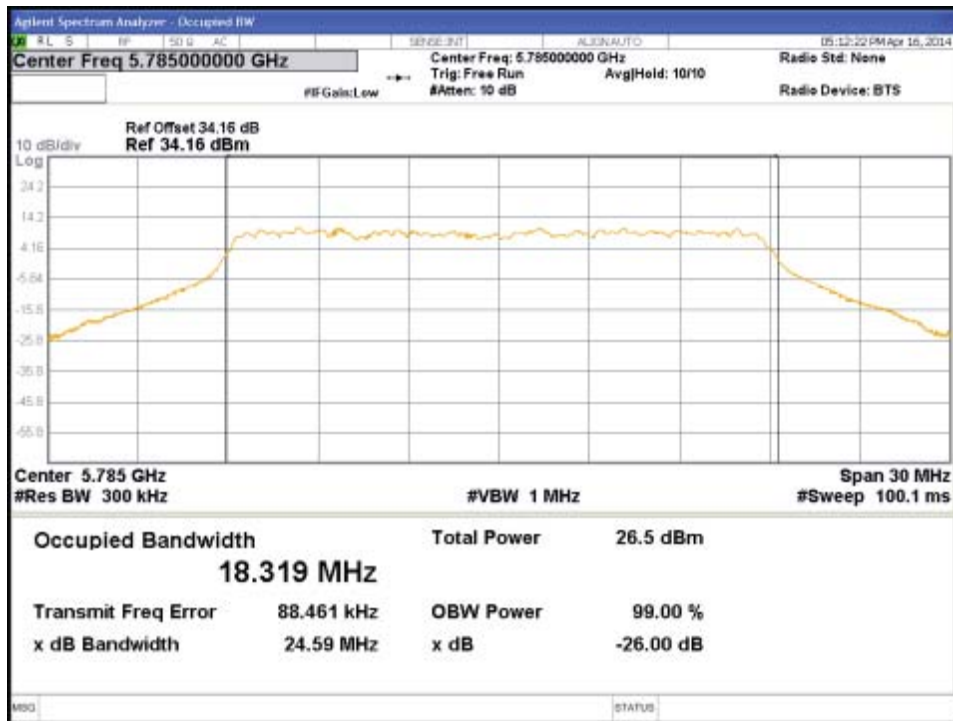

Figure 139: 99% Bandwidth-5785MHz-VHT20-MCS0-Ch2

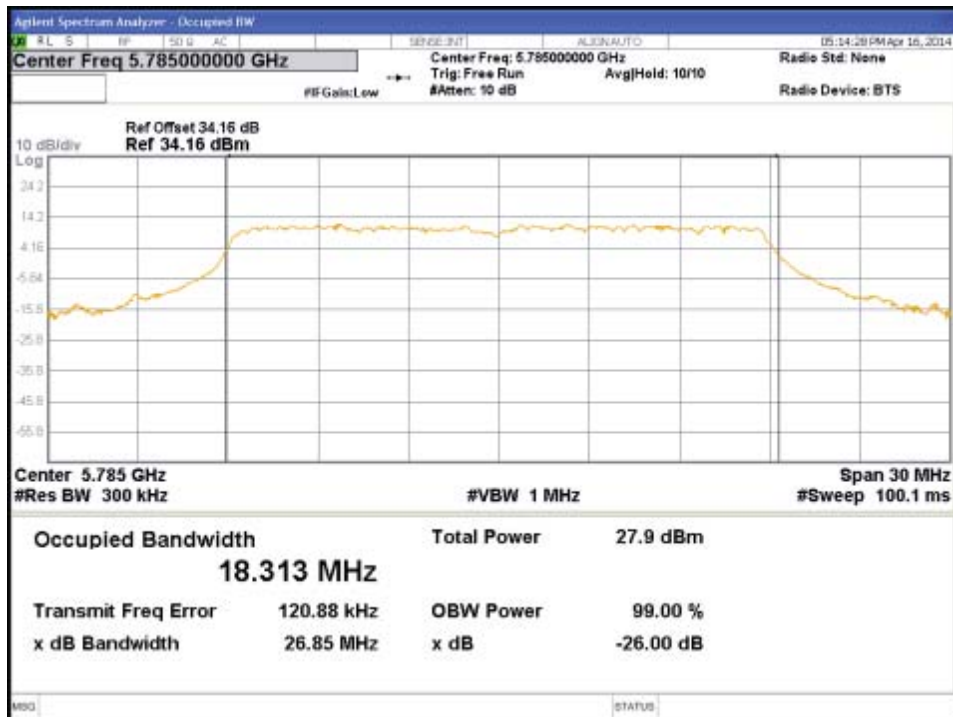

Figure 140: 99% Bandwidth-5785MHz-VHT20-MCS0-Ch3

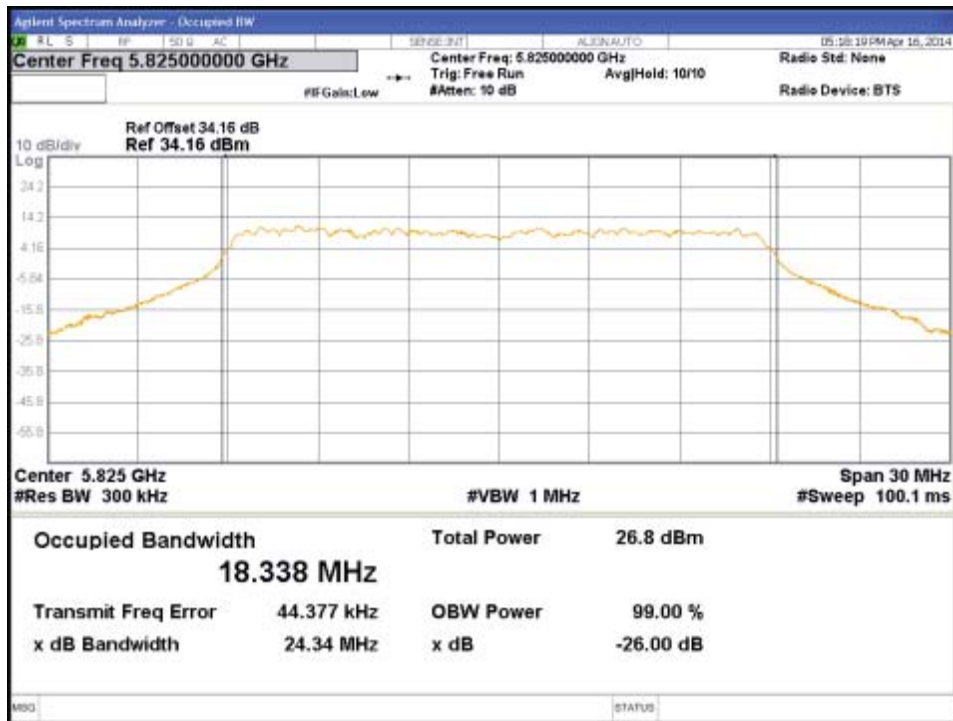

Figure 141: 99% Bandwidth-5825MHz-VHT20-MCS0-Ch0

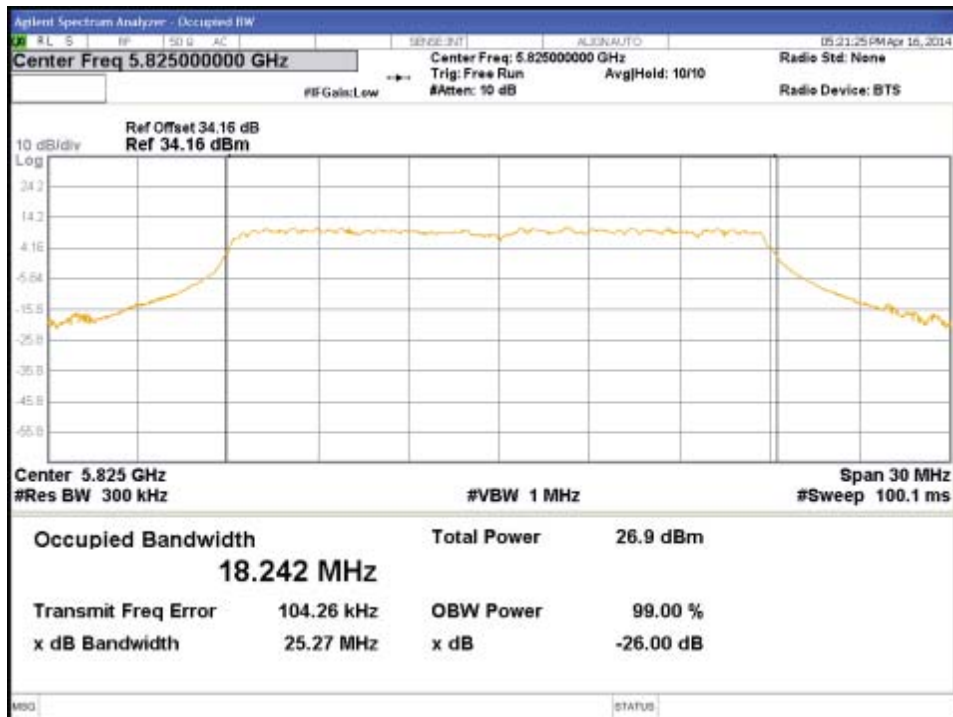

Figure 142: 99% Bandwidth-5825MHz-VHT20-MCS0-Ch1

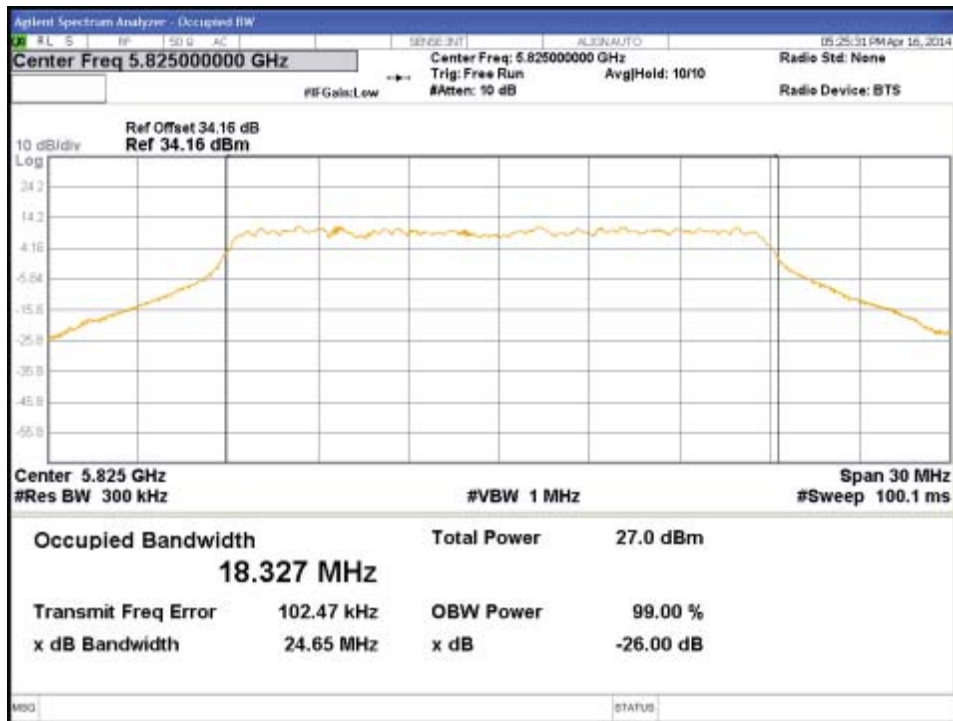

Figure 143: 99% Bandwidth-5825MHz-VHT20-MCS0-Ch2

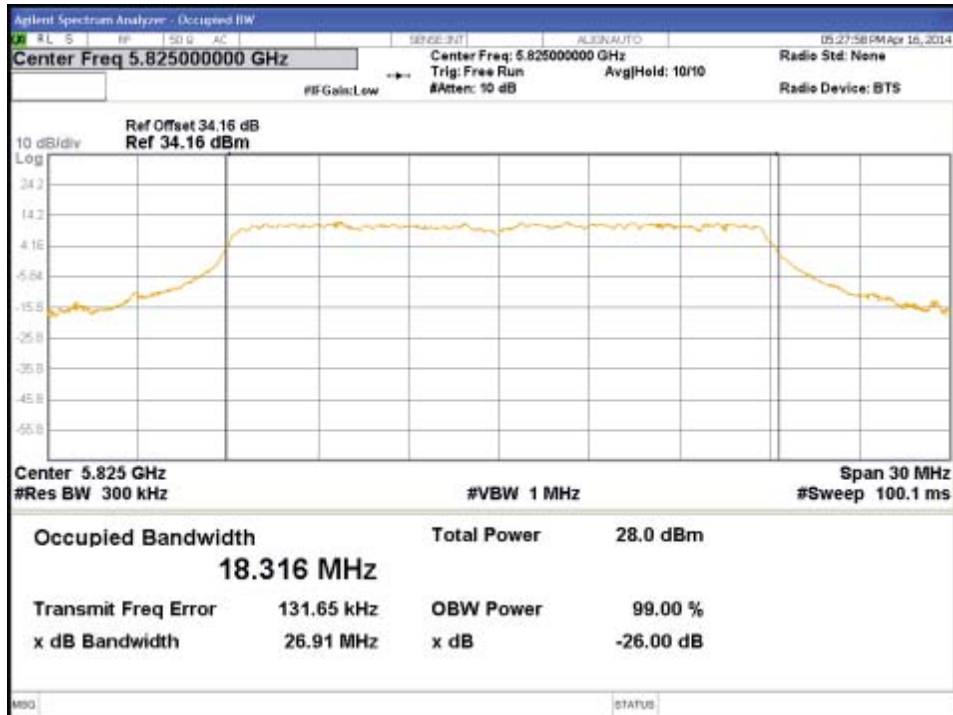

Figure 144: 99% Bandwidth-5825MHz-VHT20-MCS0-Ch3



Figure 145: 6 dB Bandwidth-5755MHz-VHT40-MCS0-Ch0



Figure 146: 6 dB Bandwidth-5755MHz-VHT40-MCS0-Ch1



Figure 147: 6 dB Bandwidth-5755MHz-VHT40-MCS0-Ch2



Figure 148: 6 dB Bandwidth-5755MHz-VHT40-MCS0-Ch3





Figure 149: 6 dB Bandwidth-5795MHz-VHT40-MCS0-Ch0



Figure 150: 6 dB Bandwidth-5795MHz-VHT40-MCS0-Ch1



Figure 151: 6 dB Bandwidth-5795MHz-VHT40-MCS0-Ch2



Figure 152: 6 dB Bandwidth-5795MHz-VHT40-MCS0-Ch3

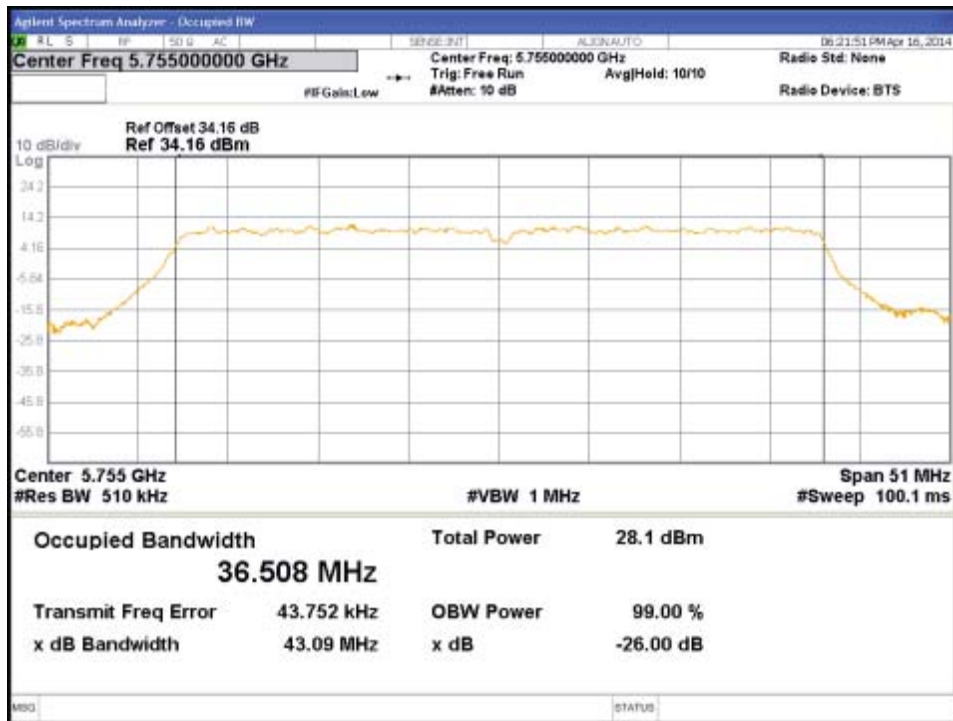

Figure 153: 99% Bandwidth-5755MHz-VHT40-MCS0-Ch0

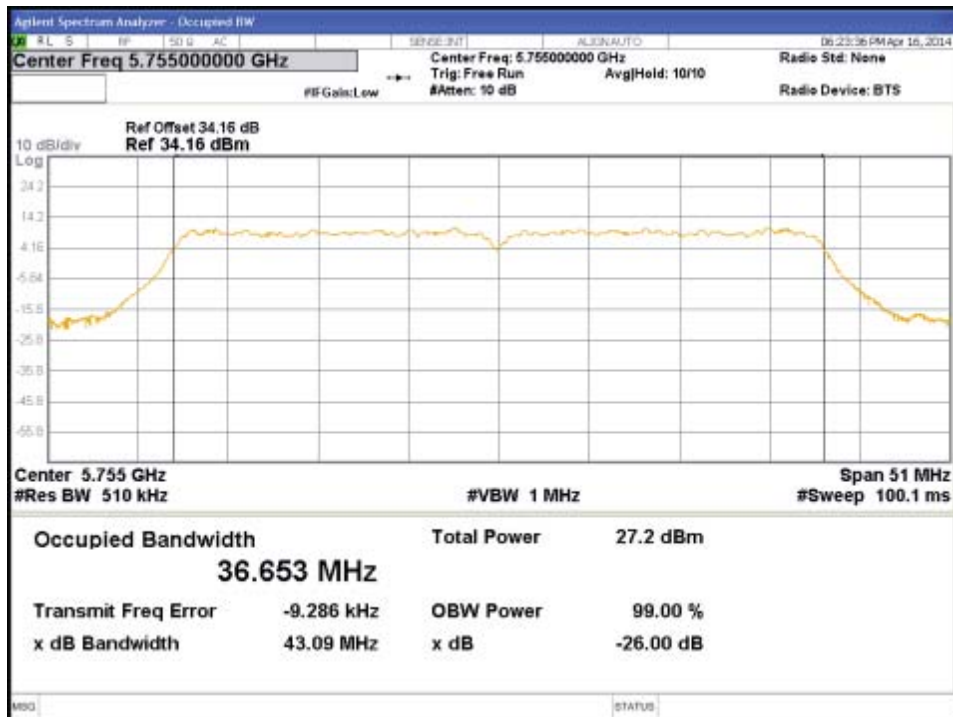

Figure 154: 99% Bandwidth-5755MHz-VHT40-MCS0-Ch1

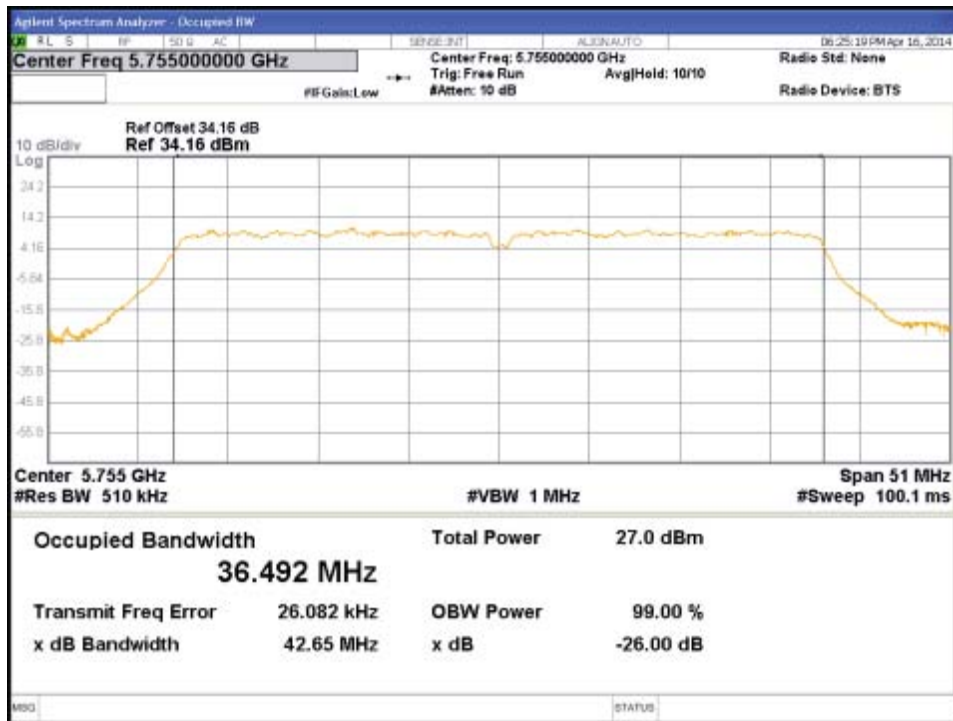

Figure 155: 99% Bandwidth-5755MHz-VHT40-MCS0-Ch2

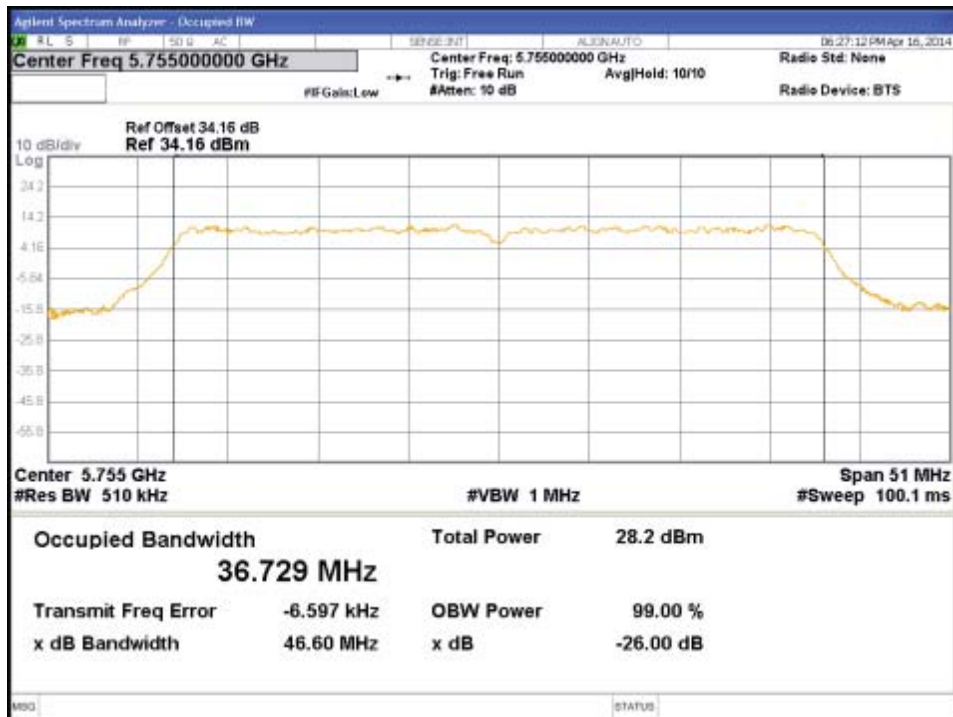

Figure 156: 99% Bandwidth-5755MHz-VHT40-MCS0-Ch3

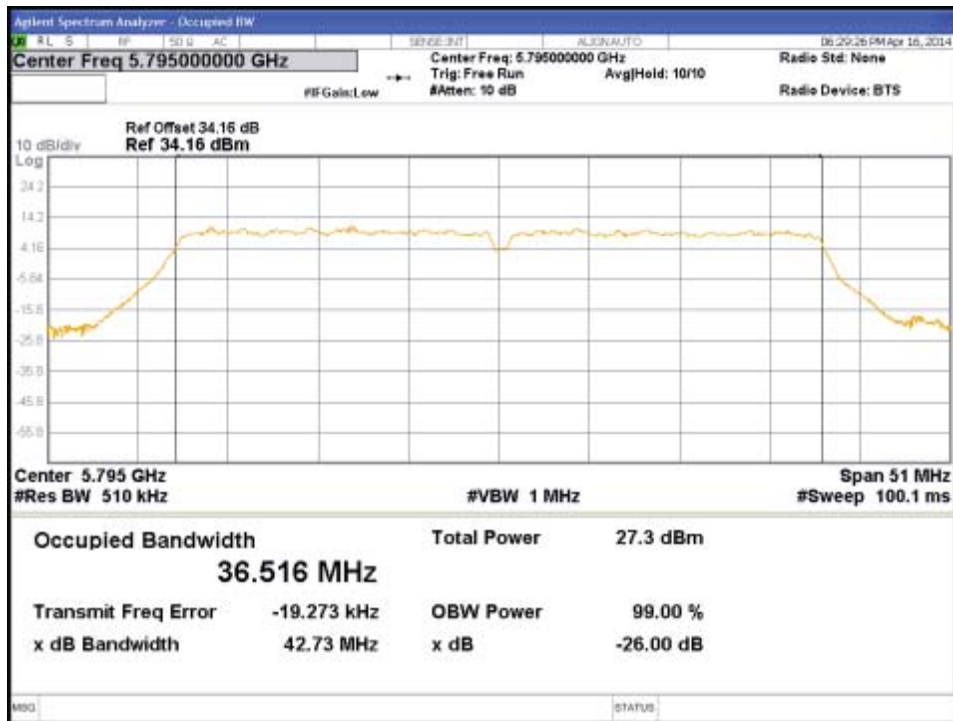

Figure 157: 99% Bandwidth-5795MHz-VHT40-MCS0-Ch0

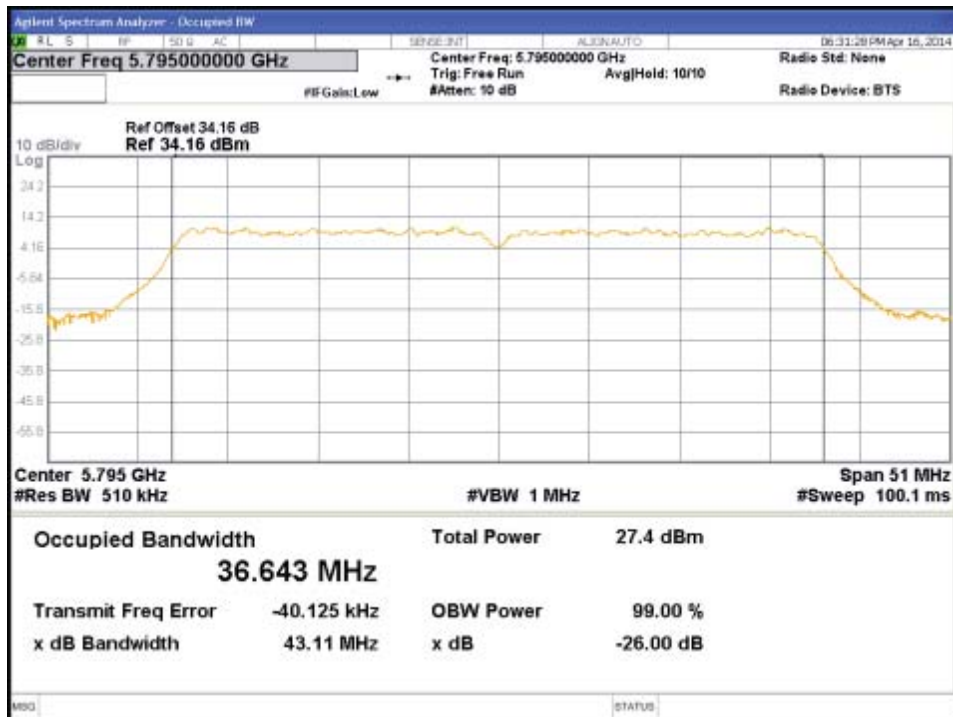

Figure 158: 99% Bandwidth-5795MHz-VHT40-MCS0-Ch1



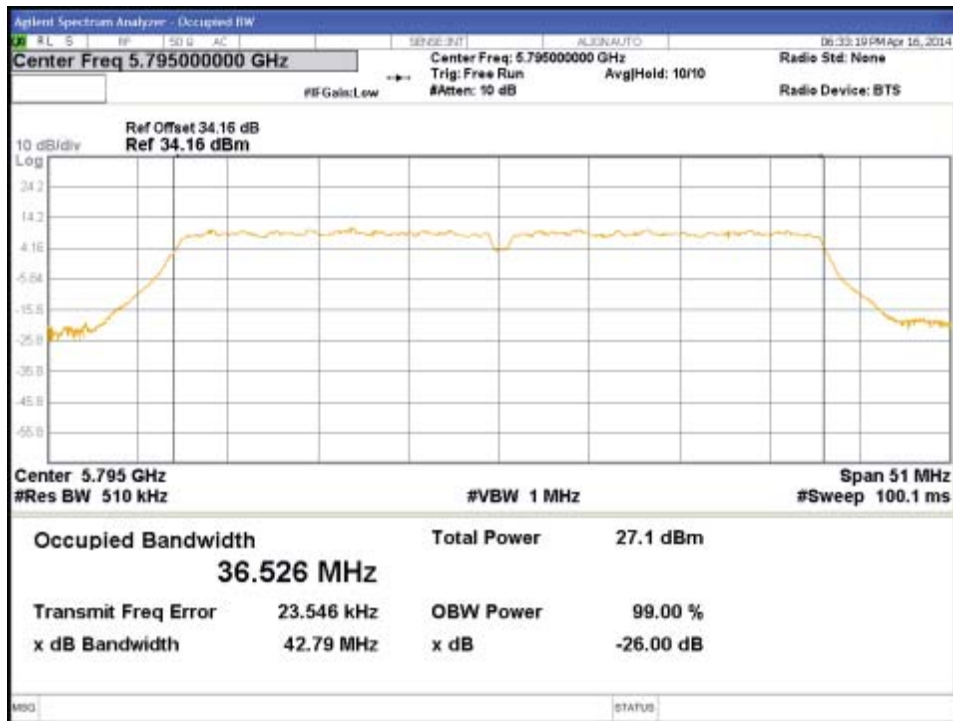

Figure 159: 99% Bandwidth-5795MHz-VHT40-MCS0-Ch2

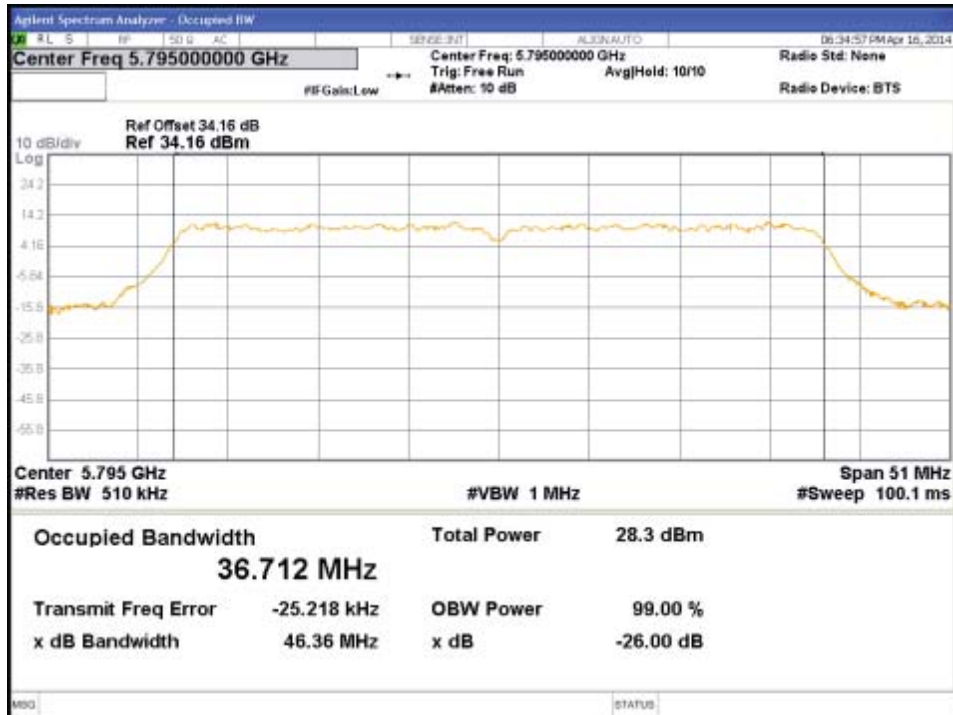

Figure 160: 99% Bandwidth-5795MHz-VHT40-MCS0-Ch3



Figure 161: 6 dB Bandwidth-5775MHz-VHT80-MCS0-Ch0



Figure 162: 6 dB Bandwidth-5775MHz-VHT80-MCS0-Ch1



Figure 163: 6 dB Bandwidth-5775MHz-VHT80-MCS0-Ch2

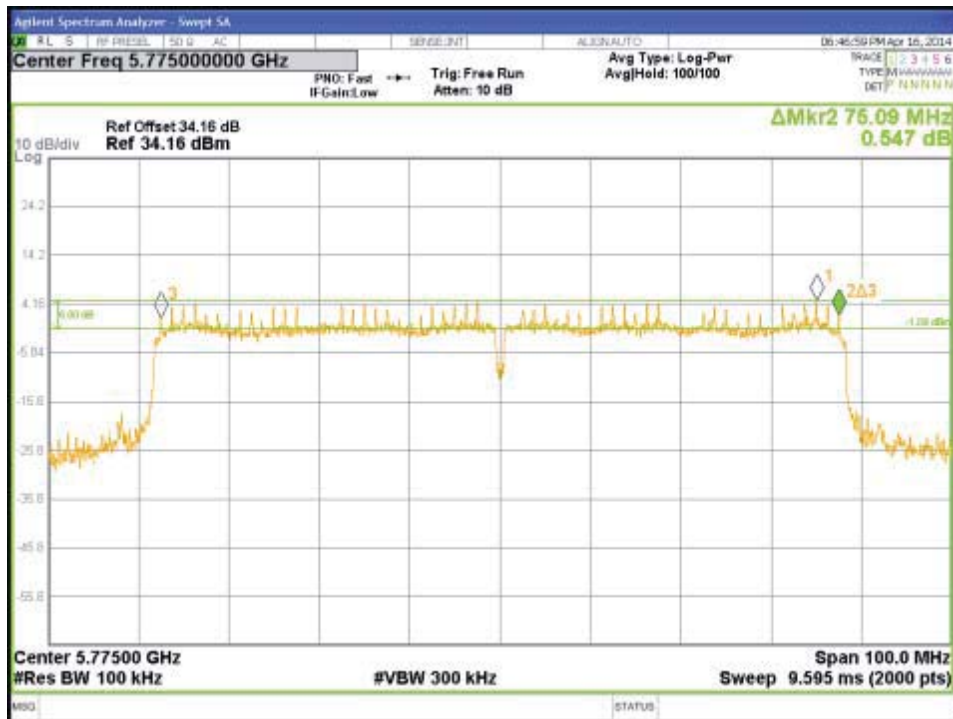

Figure 164: 6 dB Bandwidth-5775MHz-VHT80-MCS0-Ch3

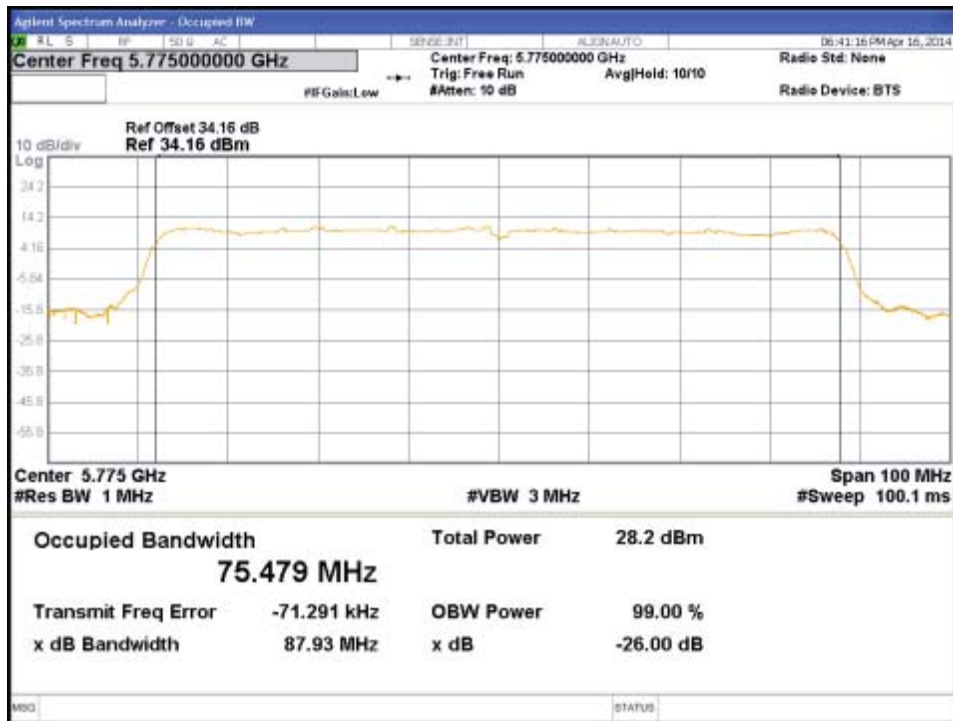

Figure 165: 99% Bandwidth-5775MHz-VHT80-MCS0-Ch0

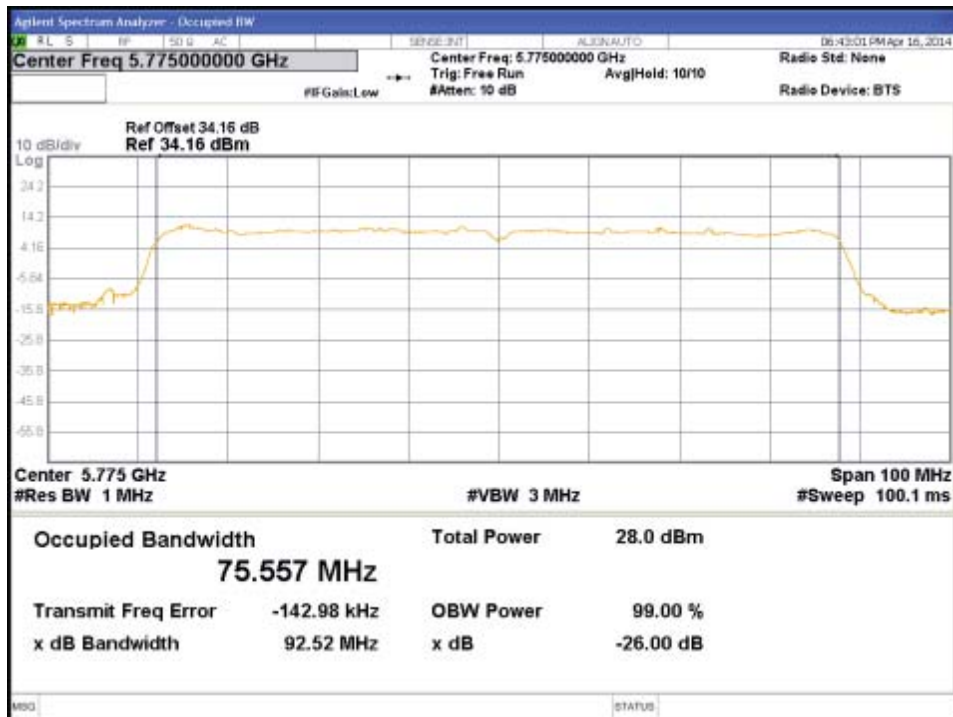

Figure 166: 99% Bandwidth-5775MHz-VHT80-MCS0-Ch1

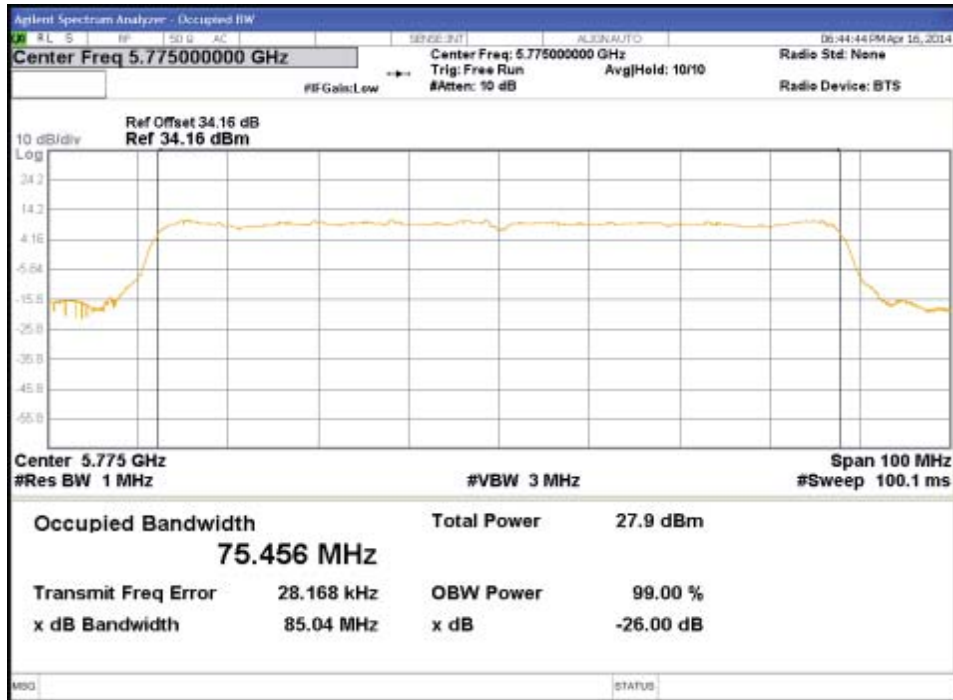

Figure 167: 99% Bandwidth-5775MHz-VHT80-MCS0-Ch2

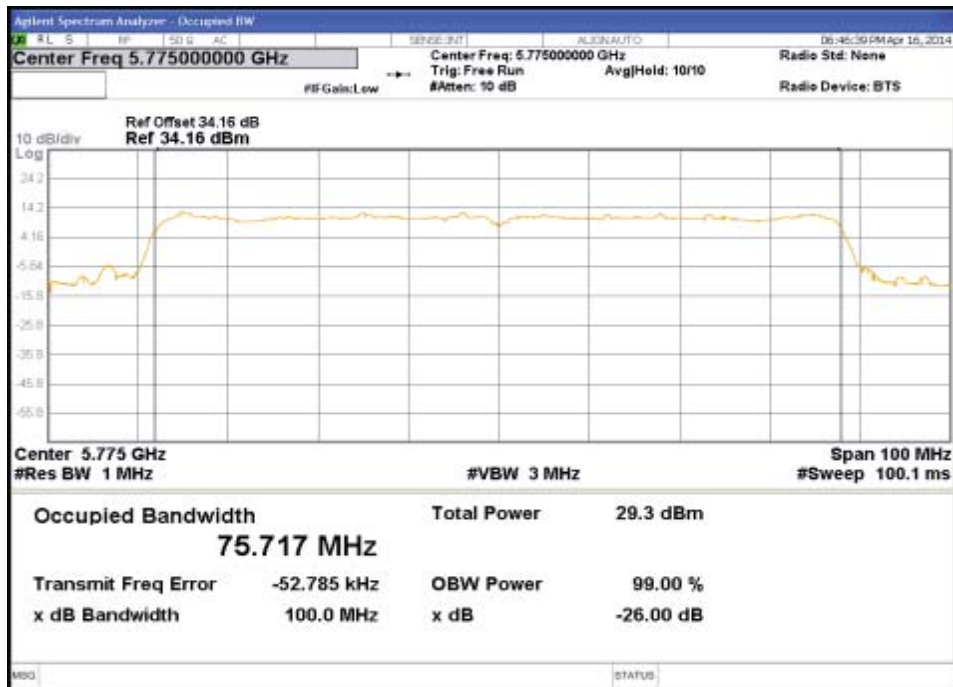

Figure 168: 99% Bandwidth-5775MHz-VHT80-MCS0-Ch3



### 4.3 Unwanted Emissions into Non-Restricted Frequency Bands

The setup was identical to RF output power measurement. Intentional radiators operating under the alternative provisions to the general emission limits, must be designed to ensure that the 20 dB or 30 dB bandwidth of the emission, or whatever bandwidth may otherwise be specified in the specific rule section under which the equipment operates, is contained within the frequency band designated in the rule section under which the equipment is operated. The requirement to contain the designated bandwidth of the emission within the specified frequency band includes the effects from frequency sweeping, frequency hopping and other modulation techniques that may be employed as well as the frequency stability of the transmitter over expected variations in temperature and supply voltage. If the frequency stability is not specified in the regulations, it is recommended that the fundamental emission be kept within at least the central 80% of the permitted band in order to minimize the possibility of out-of-band operation.

Since the transmitter complies with the conducted power limits base on the use of RMS averaging, any frequency outside the band of 5725MHz to 5850 MHz, the power output level must be below 30 dB from the in-band transmitting signal; CFR 47 Part 15.215, 15.247(d).

In the Memorandum Opinion and Order Released on March 2, 2016 (FCC 16-24), the final rules adds the following section to CFR47 15.407 (4);

*“Devices certified before March 2, 2017 with antenna gain greater than 10 dBi may demonstrate compliance with the emission limits in Section 15.247(d), but manufacturing, marketing and importing of devices certified under this alternative must cease by March 2, 2018. Devices certified before March 2, 2018 with antenna gain of 10 dBi or less may demonstrate compliance with the emission limits in Section 15.247(d), but manufacturing, marketing and importing of devices certified under this alternative must cease before March 2, 2020.”*

Since PACE Americas 5268AC applied the test procedure according CFR47 15.247(d), it will comply to the above CFR47 15.407 (4)(II) ruling.

#### 4.3.1 Test Method

The conducted method was used to measure the out-of-band emission requirement. The measurement was performed with modulation per CFR47 15.247(4)(d) 2016. This test was conducted on 3 channels of Sample in each mode on Sample, S/N 121404000111. The worst sample result indicated below.

Test Setup:

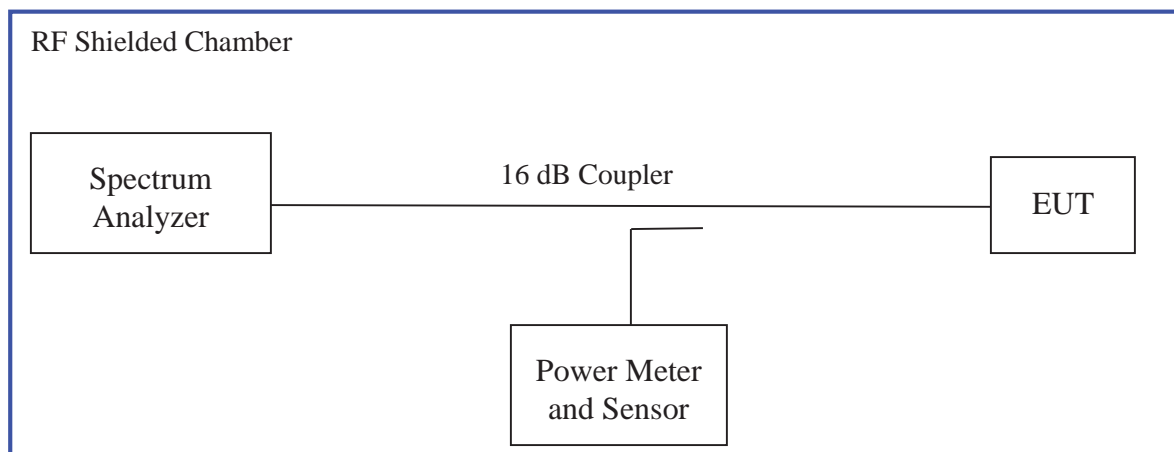

### 4.3.2 Results

As originally tested, the EUT was found to be compliant to the requirements of the test standard(s).

**Table 5:** Emissions at the Band-Edge – Test Results

<b>Test Conditions:</b> Conducted Measurement			<b>Test Date:</b> April 18, 2014		
<b>Antenna Type:</b> Integrated			<b>Power Setting:</b> See test plan		
<b>Max. Directional Gain:</b> + 8.08 dBi			<b>Signal State:</b> Modulated		
<b>Ambient Temp.:</b> 23 °C			<b>Relative Humidity:</b> 30%		
Non-Restricted Frequency Band Emission					
Freq. (MHz)	Mode	Chain	Ref. Level (dBm)	Plots	Results
5745	6Mbps	0	-20.69	Fig. 169, 170	Pass
5745	6Mbps	1	-21.92	Fig. 171, 172	Pass
5745	6Mbps	2	-22.15	Fig. 173, 174	Pass
5745	6Mbps	3	-21.19	Fig. 175, 176	Pass
5785	6Mbps	0	-21.62	Fig. 177, 178	Pass
5785	6Mbps	1	-23.44	Fig. 179, 180	Pass
5785	6Mbps	2	-22.23	Fig. 181, 182	Pass
5785	6Mbps	3	-20.07	Fig. 183, 184	Pass
5825	6Mbps	0	-20.65	Fig. 185, 186	Pass
5825	6Mbps	1	-21.99	Fig. 187, 188	Pass
5825	6Mbps	2	-21.48	Fig. 189, 190	Pass
5825	6Mbps	3	-20.51	Fig. 191, 192	Pass
5745	HT20 MCS0	0	-20.75	Fig. 193, 194	Pass
5745	HT20 MCS0	1	-21.48	Fig. 195, 196	Pass
5745	HT20 MCS0	2	-22.91	Fig. 197, 198	Pass
5745	HT20 MCS0	3	-20.48	Fig. 199, 200	Pass
5785	HT20 MCS0	0	-21.65	Fig. 201, 202	Pass
5785	HT20 MCS0	1	-22.38	Fig. 203, 204	Pass

1279 Quarry Lane, Ste. A, Pleasanton, CA 95466  
 Tel: (925) 249-9123, Fax: (925) 249-9124

5785	HT20 MCS0	2	-21.63	Fig. 205, 206	Pass
5785	HT20 MCS0	3	-20.34	Fig. 207, 208	Pass
5825	HT20 MCS0	0	-20.97	Fig. 209, 210	Pass
5825	HT20 MCS0	1	-22.11	Fig. 211, 212	Pass
5825	HT20 MCS0	2	-21.55	Fig. 213, 214	Pass
5825	HT20 MCS0	3	-19.81	Fig. 215, 216	Pass
5755	HT40 MCS0	0	-23.12	Fig. 217, 218	Pass
5755	HT40 MCS0	1	-24.27	Fig. 219, 220	Pass
5755	HT40 MCS0	2	-23.97	Fig. 221, 222	Pass
5755	HT40 MCS0	3	-22.61	Fig. 223, 224	Pass
5795	HT40 MCS0	0	-23.51	Fig. 225, 226	Pass
5795	HT40 MCS0	1	-24.23	Fig. 227, 228	Pass
5795	HT40 MCS0	2	-23.94	Fig. 229, 230	Pass
5795	HT40 MCS0	3	-22.49	Fig. 231, 232	Pass
5745	VHT20 MCS0	0	-21.88	Fig. 233, 234	Pass
5745	VHT20 MCS0	1	-22.10	Fig. 235, 236	Pass
5745	VHT20 MCS0	2	-22.92	Fig. 237, 238	Pass
5745	VHT20 MCS0	3	-21.31	Fig. 239, 240	Pass
5785	VHT20 MCS0	0	-21.03	Fig. 241, 242	Pass
5785	VHT20 MCS0	1	-22.04	Fig. 243, 244	Pass
5785	VHT20 MCS0	2	-21.49	Fig. 245, 246	Pass
5785	VHT20 MCS0	3	-20.26	Fig. 247, 248	Pass
5825	VHT20 MCS0	0	-20.75	Fig. 249, 250	Pass
5825	VHT20 MCS0	1	-21.71	Fig. 251, 252	Pass
5825	VHT20 MCS0	2	-22.10	Fig. 253, 254	Pass
5825	VHT20 MCS0	3	-20.61	Fig. 255, 256	Pass
5755	VHT40 MCS0	0	-23.84	Fig. 257, 258	Pass

5755	VHT40 MCS0	1	-24.10	Fig. 259, 260	Pass
5755	VHT40 MCS0	2	-23.23	Fig. 261, 262	Pass
5755	VHT40 MCS0	3	-22.44	Fig. 263, 264	Pass
5795	VHT40 MCS0	0	-23.81	Fig. 265, 266	Pass
5795	VHT40 MCS0	1	-24.48	Fig. 267, 268	Pass
5795	VHT40 MCS0	2	-23.99	Fig. 269, 270	Pass
5795	VHT40 MCS0	3	-22.49	Fig. 271, 272	Pass
5775	VHT80 MCS0	0	-26.23	Fig. 273, 274	Pass
5775	VHT80 MCS0	1	-28.00	Fig. 275, 276	Pass
5775	VHT80 MCS0	2	-27.25	Fig. 277, 278	Pass
5775	VHT80 MCS0	3	-25.58	Fig.279, 280	Pass

Note: All out of band emissions are lower than the 30 dBr level.  
 The maximum out of band emission on each individual output put is at least 30 dB below the maximum in-band PSD on that output per KDB 662911.

1279 Quarry Lane, Ste. A, Pleasanton, CA 95466  
 Tel: (925) 249-9123, Fax: (925) 249-9124

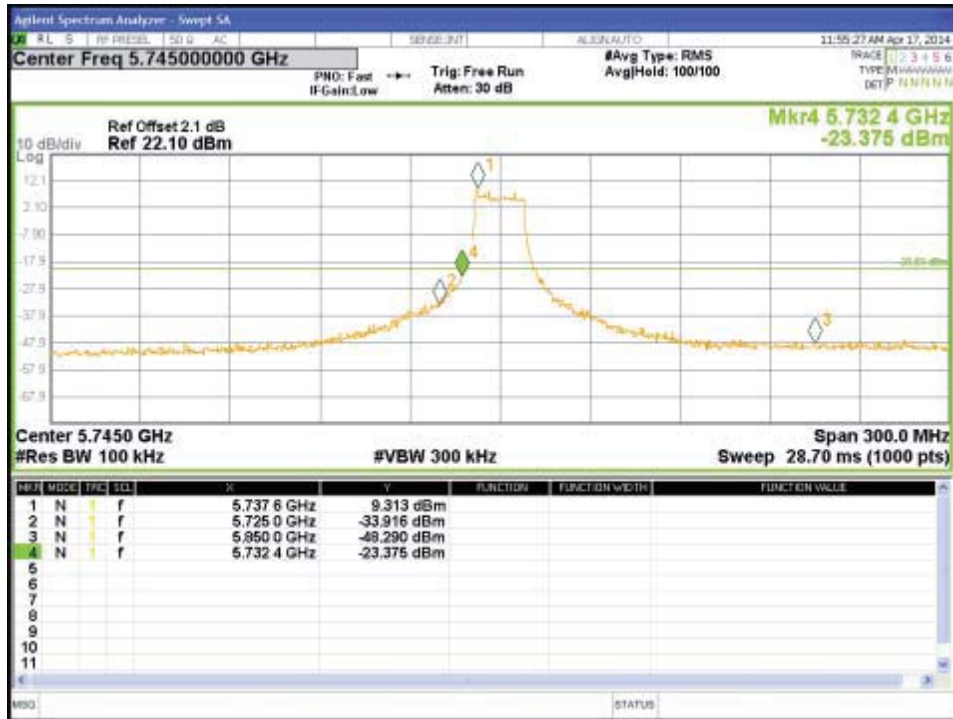

Figure 169: Conducted Band Edge-5745MHz-11a-6 Mbps-Ch0

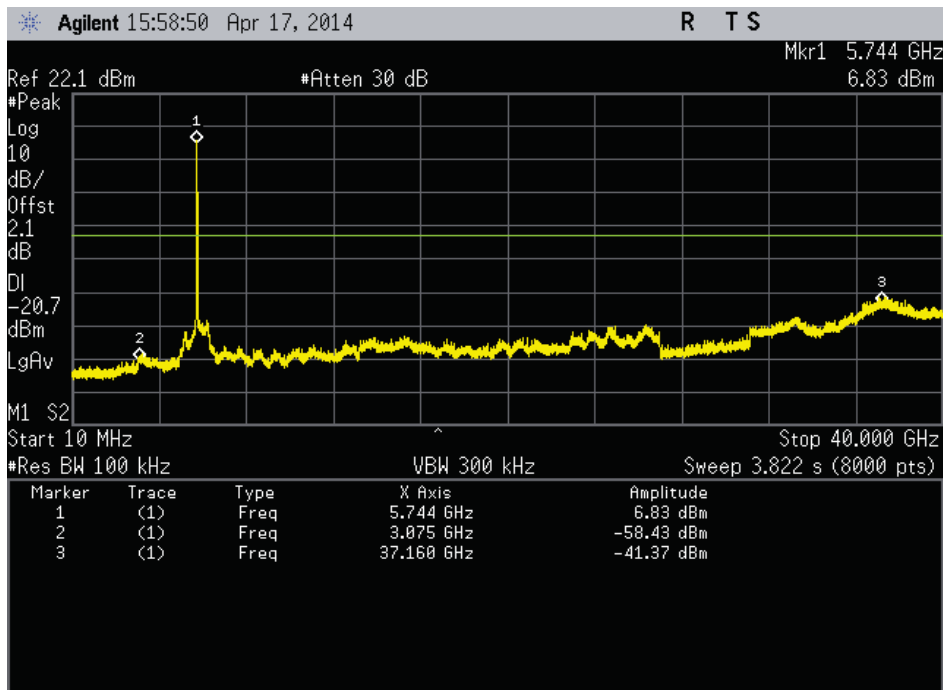

Figure 170: Out of Band Emission-802.11a-5745 MHz-6 Mbps-Ch0



1279 Quarry Lane, Ste. A, Pleasanton, CA 95466  
 Tel: (925) 249-9123, Fax: (925) 249-9124



Figure 171: Conducted Band Edge-5745MHz-11a-6 Mbps-Ch1

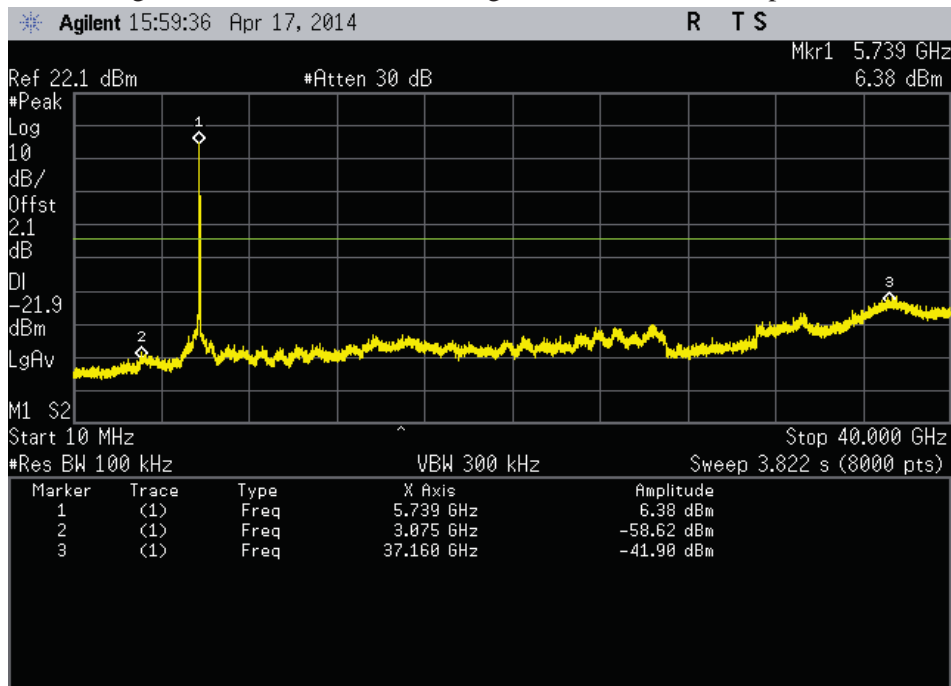

Figure 172: Out of Band Emission-802.11a-5745 MHz-6 Mbps-Ch1

1279 Quarry Lane, Ste. A, Pleasanton, CA 95466  
 Tel: (925) 249-9123, Fax: (925) 249-9124

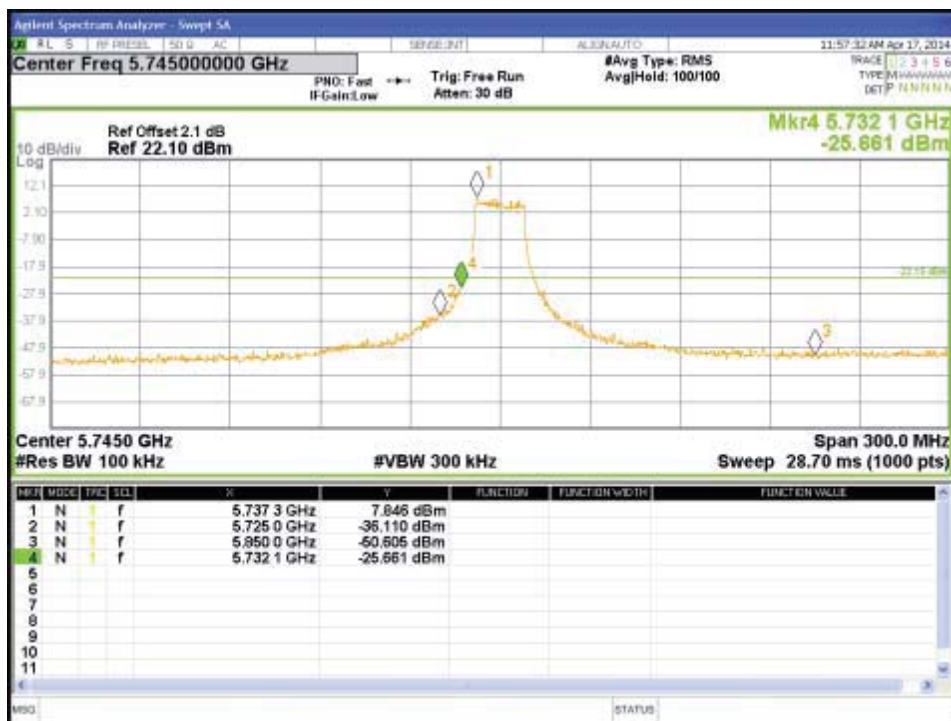

Figure 173: Conducted Band Edge-5745MHz-11a-6 Mbps-Ch2

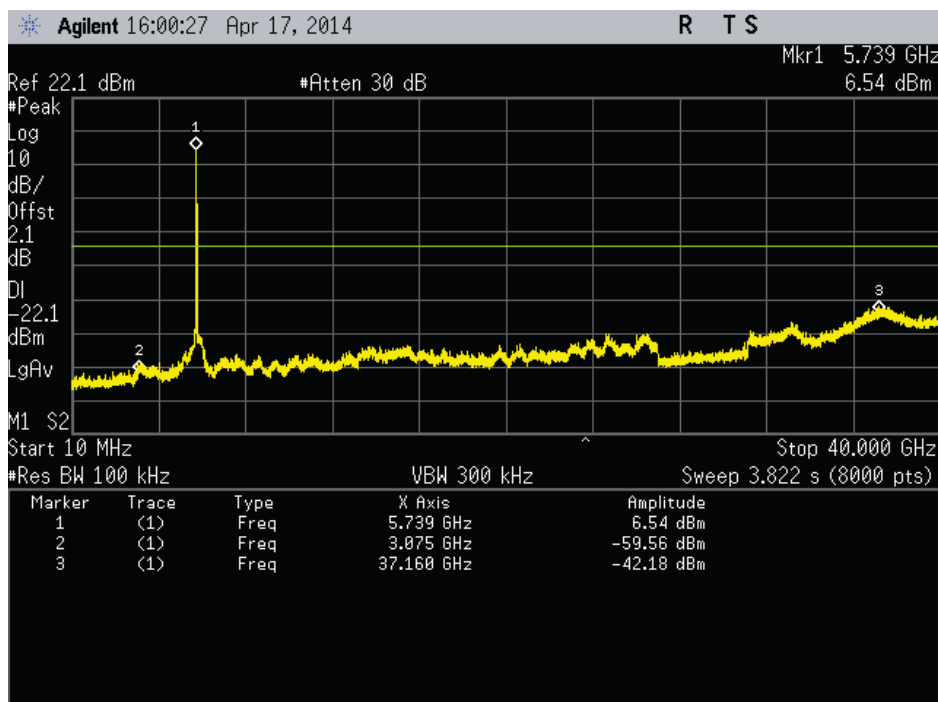

Figure 174: Out of Band Emission-802.11a-5745 MHz-6 Mbps-Ch2

1279 Quarry Lane, Ste. A, Pleasanton, CA 95466  
 Tel: (925) 249-9123, Fax: (925) 249-9124

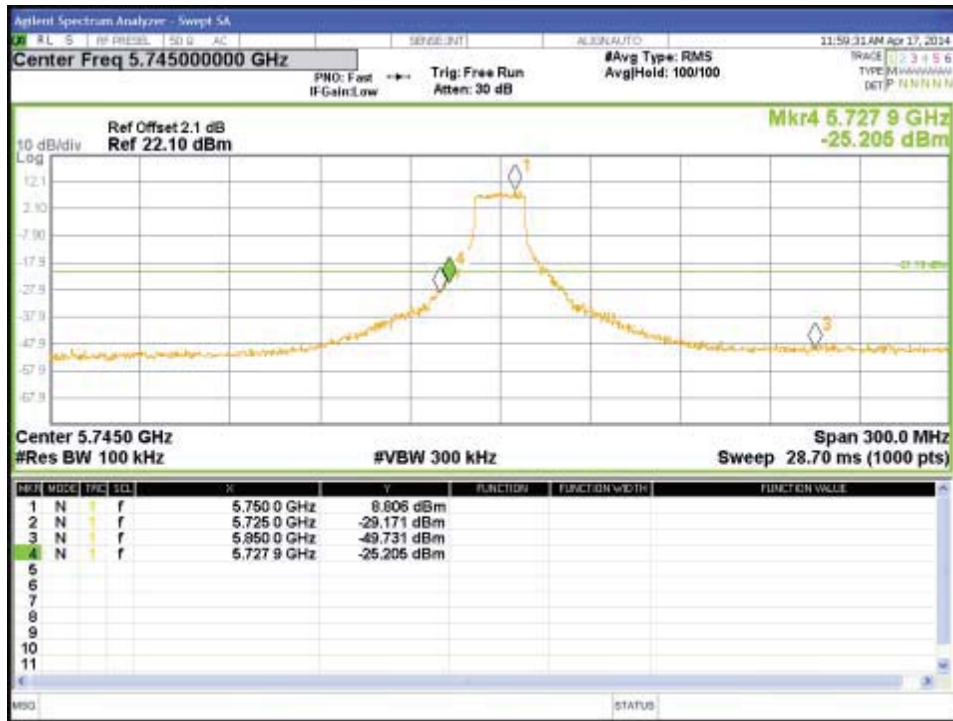

Figure 175: Conducted Band Edge-5745MHz-11a-6 Mbps-Ch3

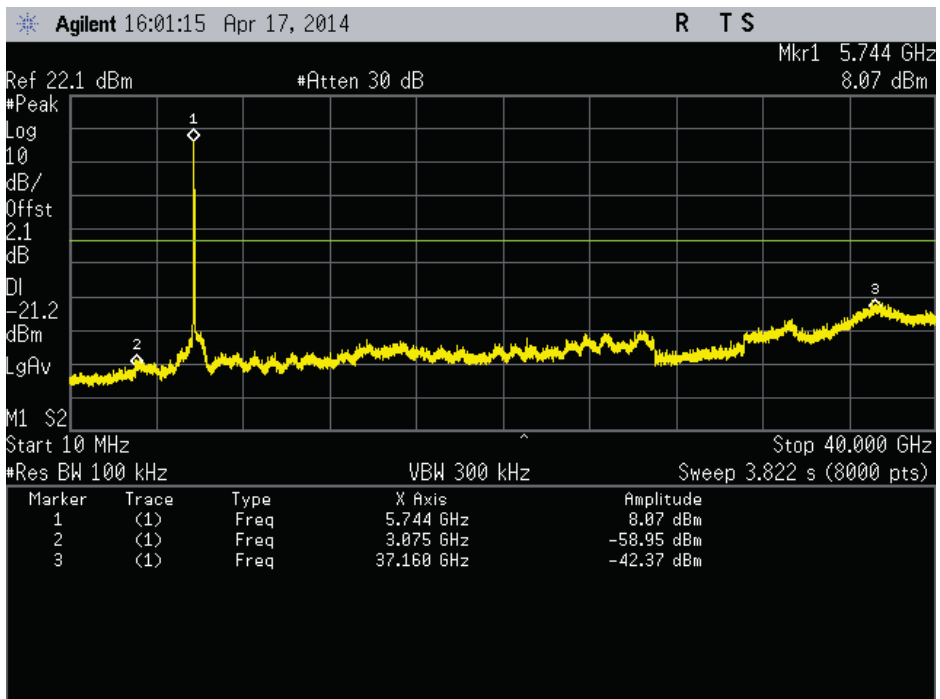

Figure 176: Out of Band Emission-802.11a-5745 MHz-6 Mbps-Ch3

1279 Quarry Lane, Ste. A, Pleasanton, CA 95466  
 Tel: (925) 249-9123, Fax: (925) 249-9124

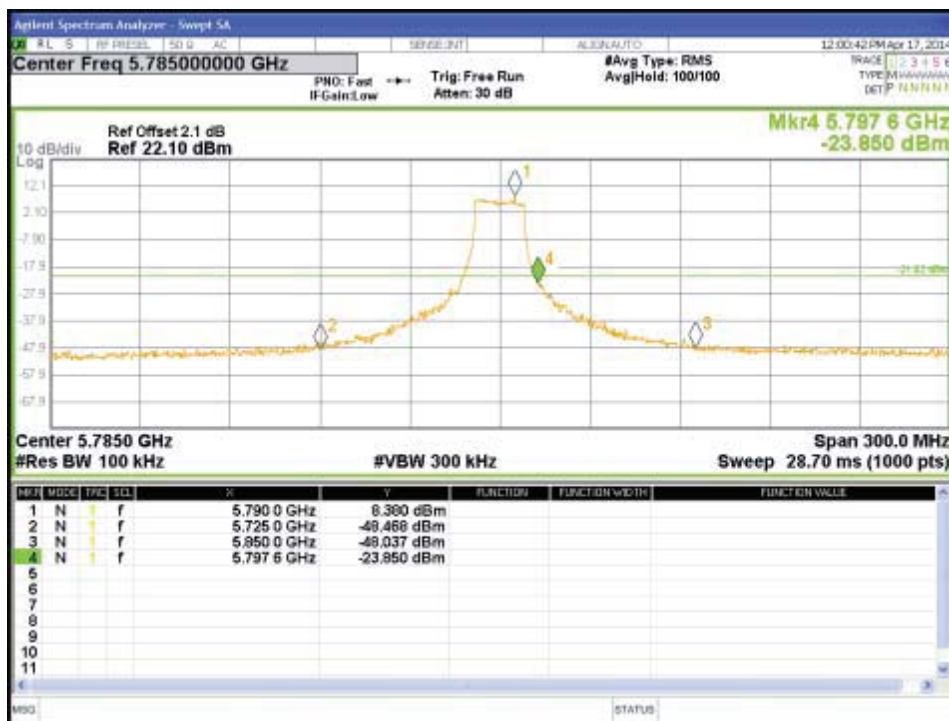

Figure 177: Conducted Band Edge-5785MHz-11a-6 Mbps-Ch0

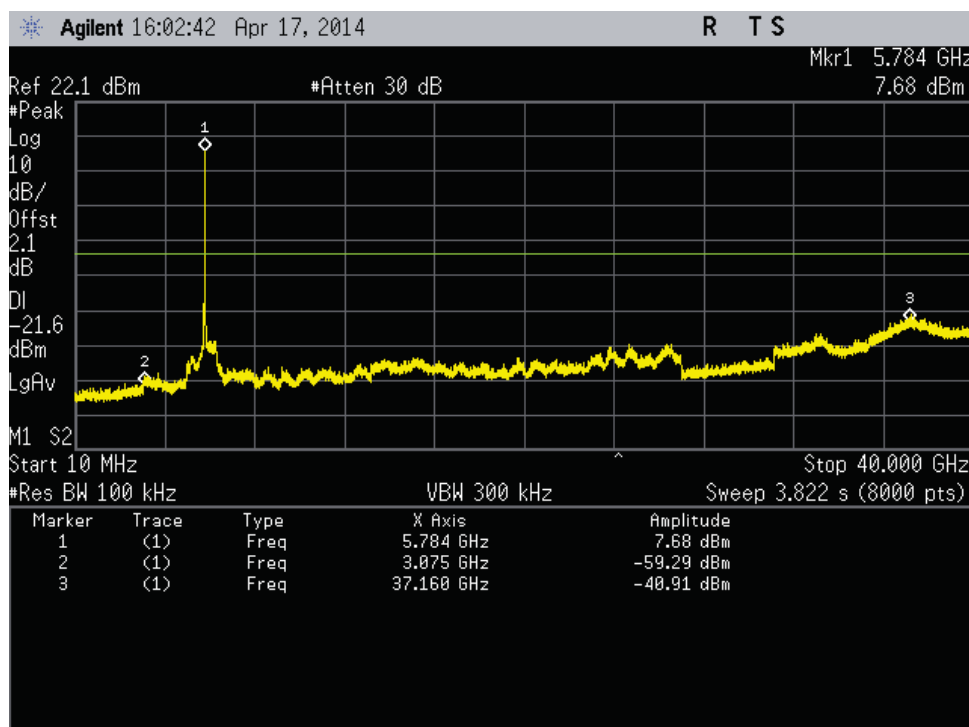

Figure 178: Out of Band Emission-802.11a-5785 MHz-6 Mbps-Ch0

1279 Quarry Lane, Ste. A, Pleasanton, CA 95466  
 Tel: (925) 249-9123, Fax: (925) 249-9124

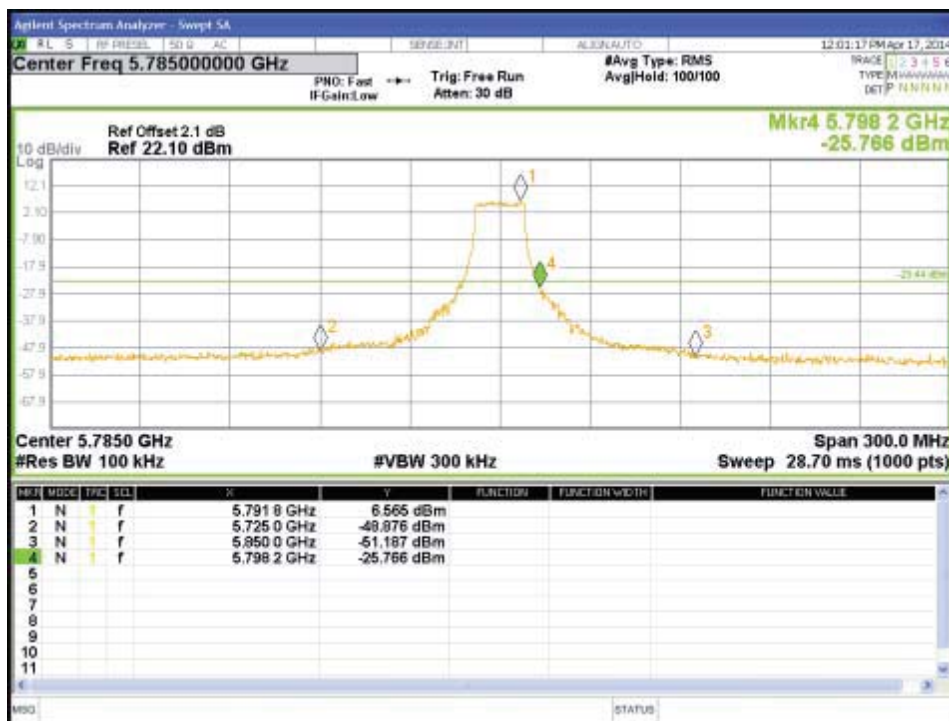

Figure 179: Conducted Band Edge-5785MHz-11a-6 Mbps-Ch1

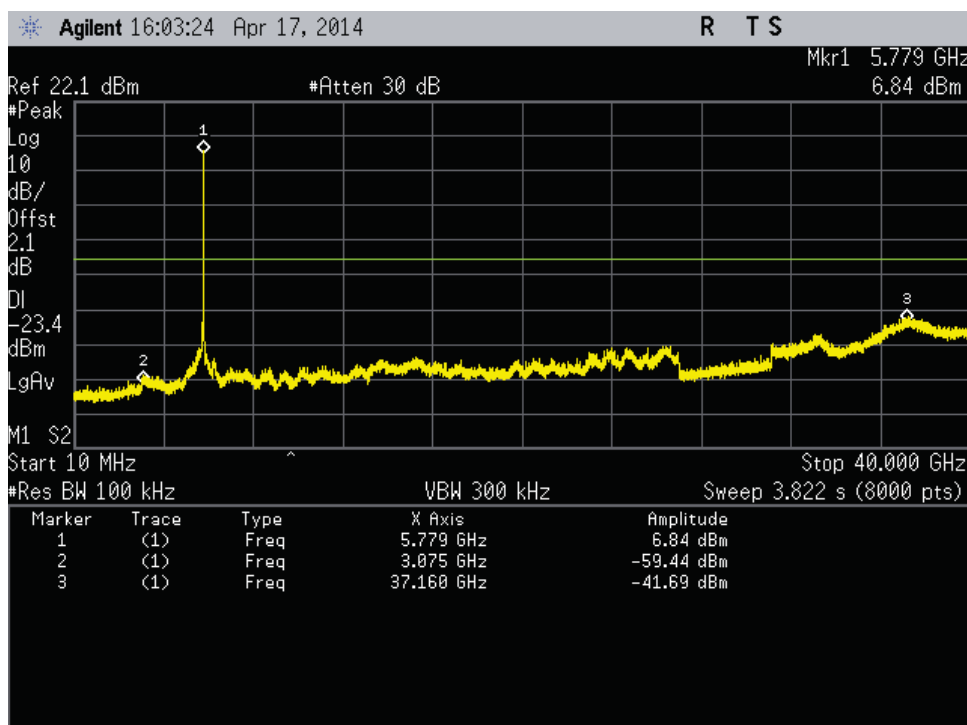

Figure 180: Out of Band Emission-802.11a-5785 MHz-6 Mbps-Ch1



1279 Quarry Lane, Ste. A, Pleasanton, CA 95466  
 Tel: (925) 249-9123, Fax: (925) 249-9124

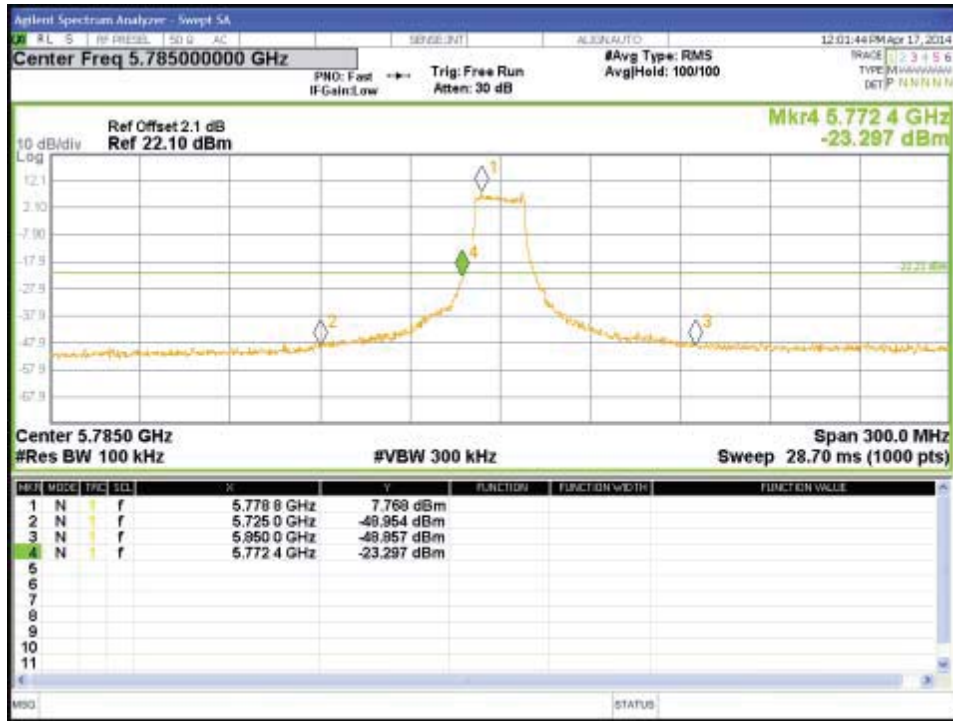

Figure 181: Conducted Band Edge-5785MHz-11a-6 Mbps-Ch2

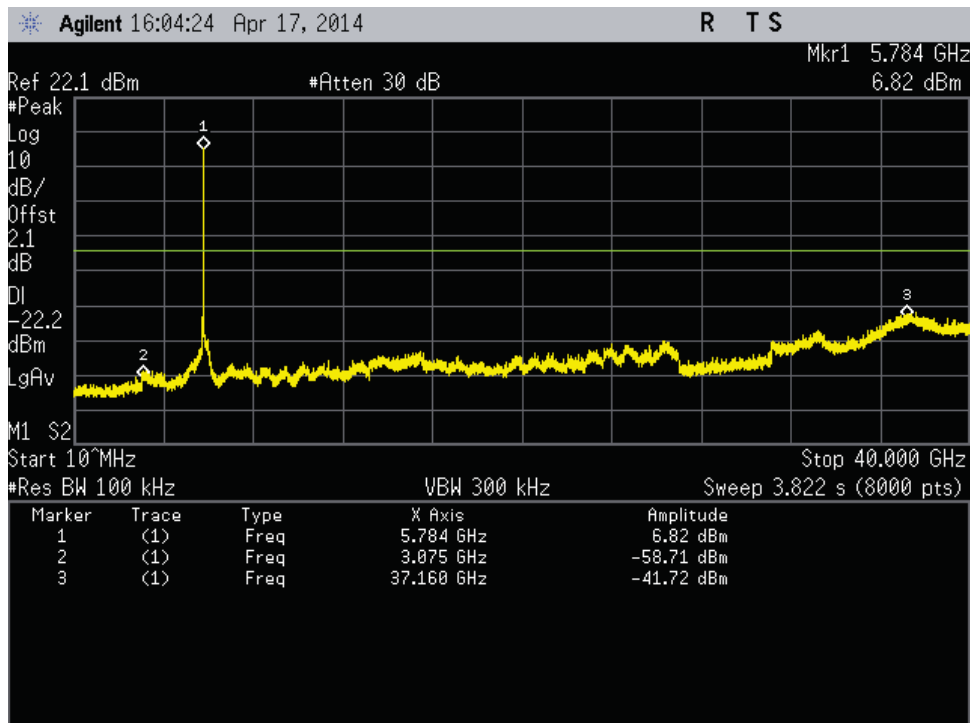

Figure 182: Out of Band Emission-802.11a-5785 MHz-6 Mbps-Ch2

1279 Quarry Lane, Ste. A, Pleasanton, CA 95466  
 Tel: (925) 249-9123, Fax: (925) 249-9124

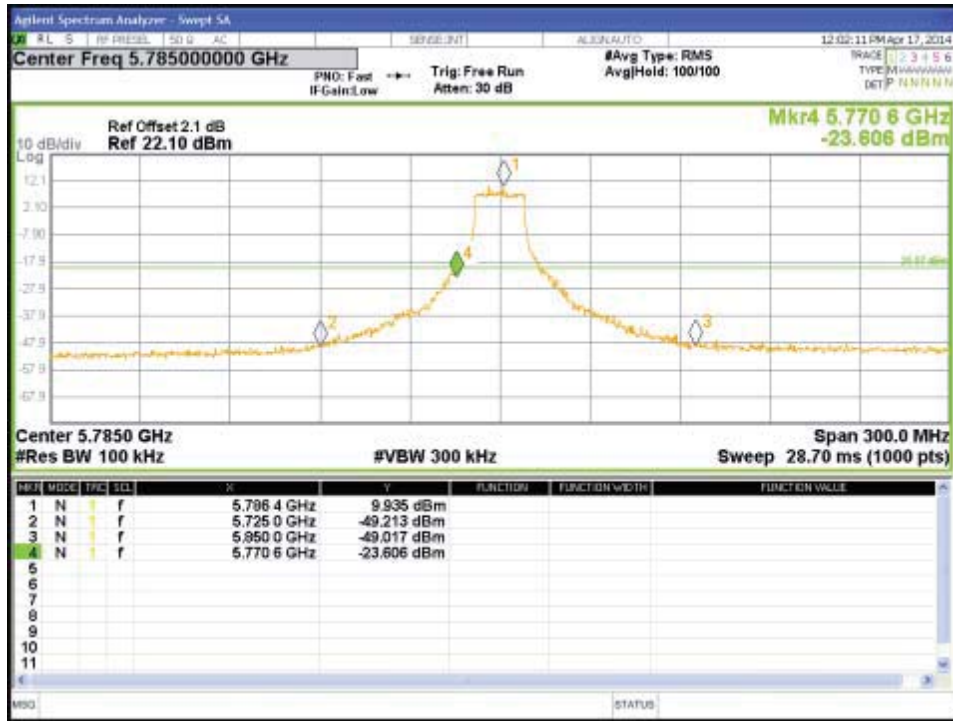

Figure 183: Conducted Band Edge-5785MHz-11a-6 Mbps-Ch3

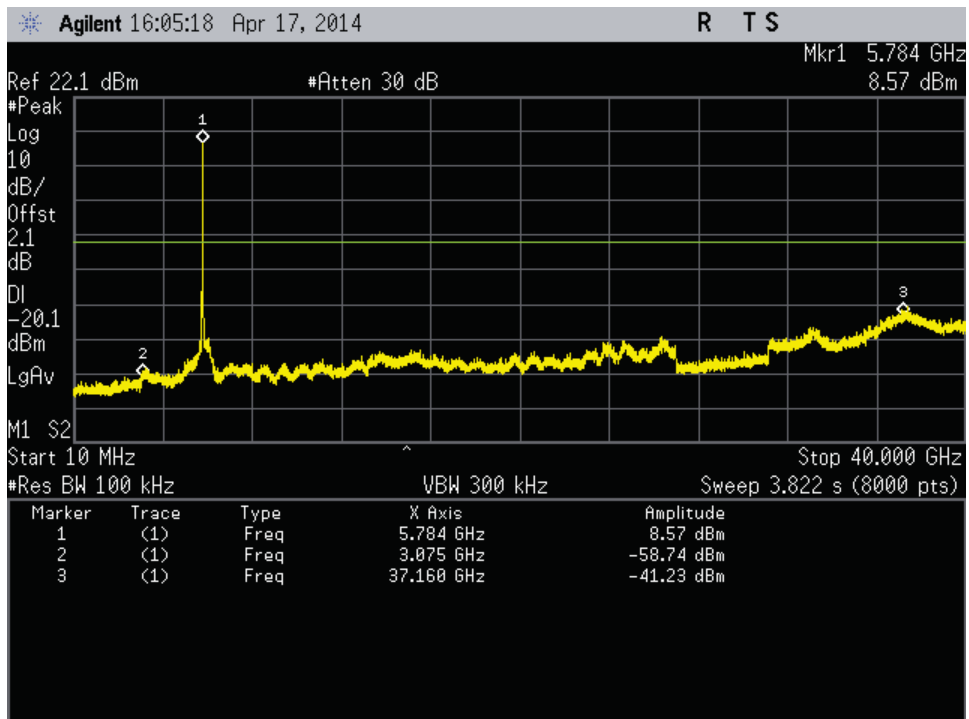

Figure 184: Out of Band Emission-802.11a-5785 MHz-6 Mbps-Ch3

1279 Quarry Lane, Ste. A, Pleasanton, CA 95466  
 Tel: (925) 249-9123, Fax: (925) 249-9124

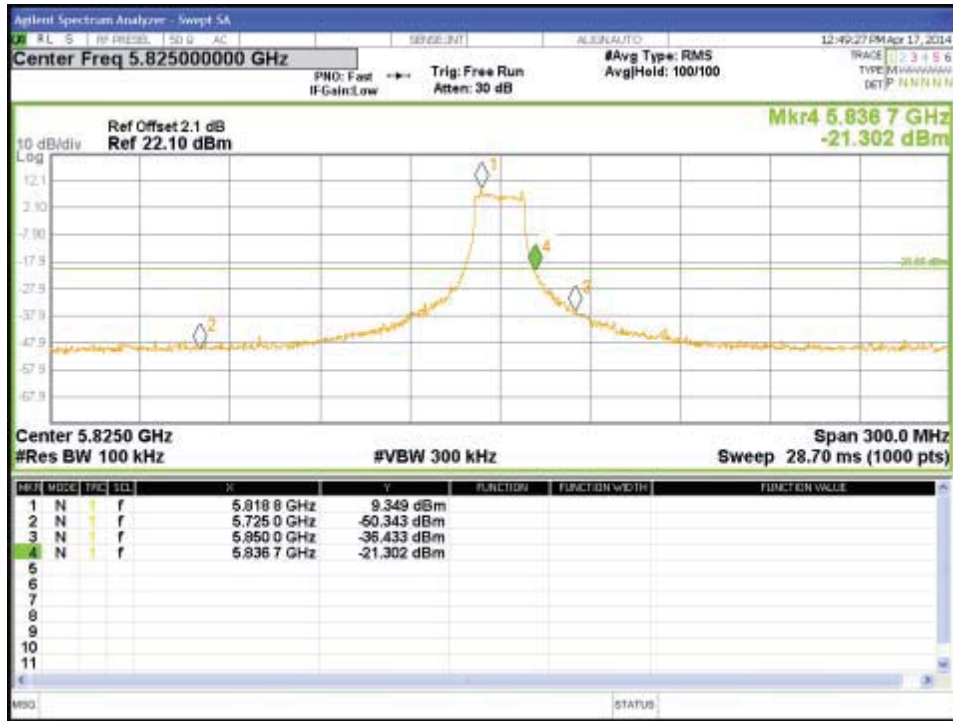

Figure 185: Conducted Band Edge-5825MHz-11a-6 Mbps-Ch0

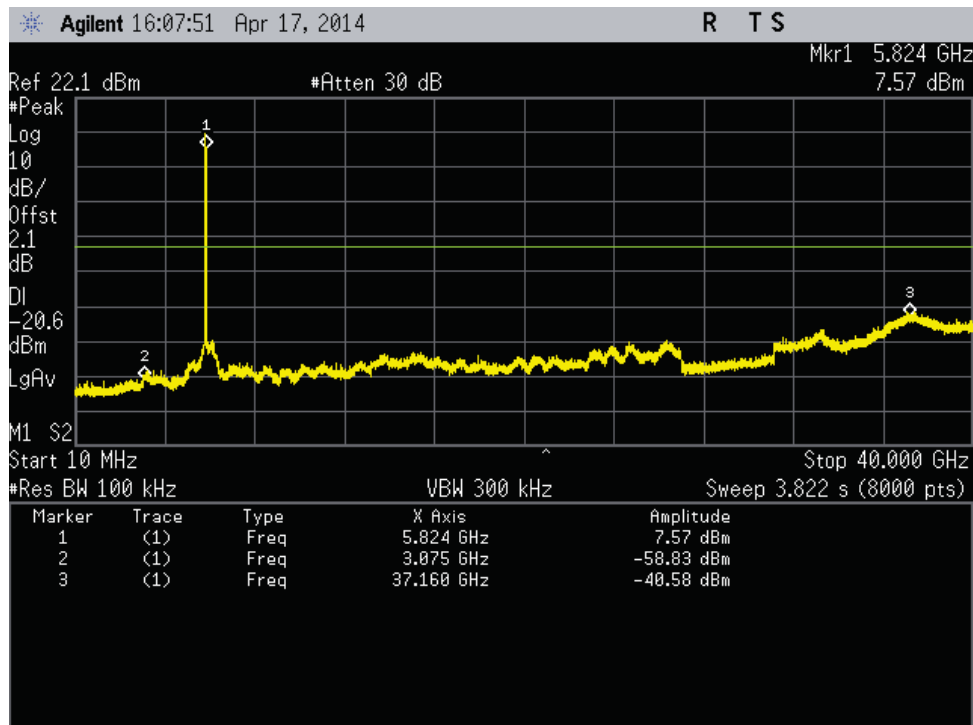

Figure 186: Out of Band Emission-802.11a-5825 MHz-6 Mbps-Ch0

1279 Quarry Lane, Ste. A, Pleasanton, CA 95466  
 Tel: (925) 249-9123, Fax: (925) 249-9124

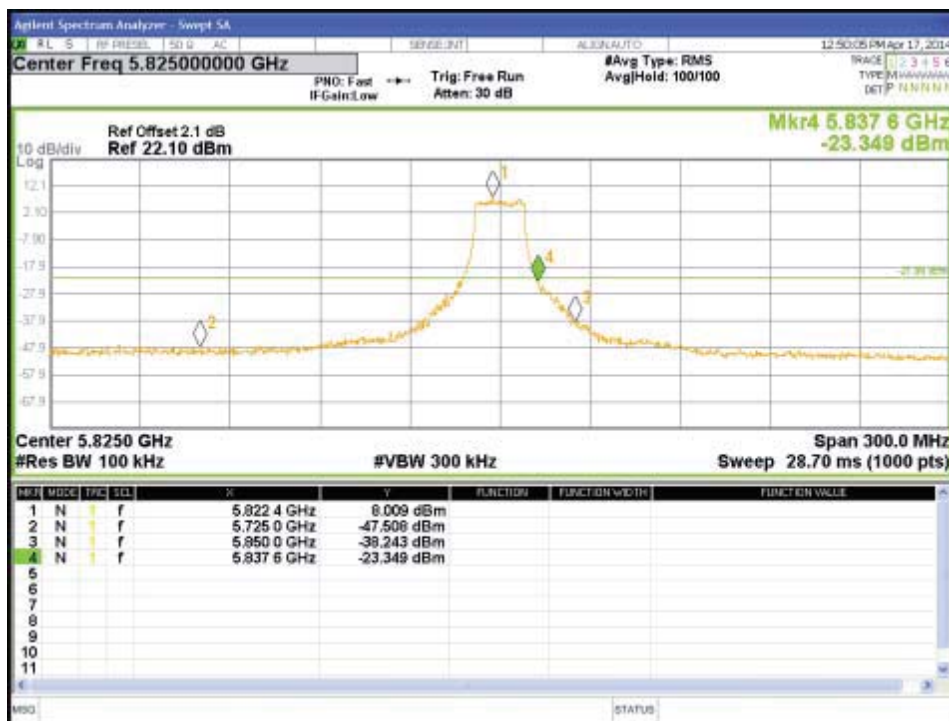

Figure 187: Conducted Band Edge-5825MHz-11a-6 Mbps-Ch1

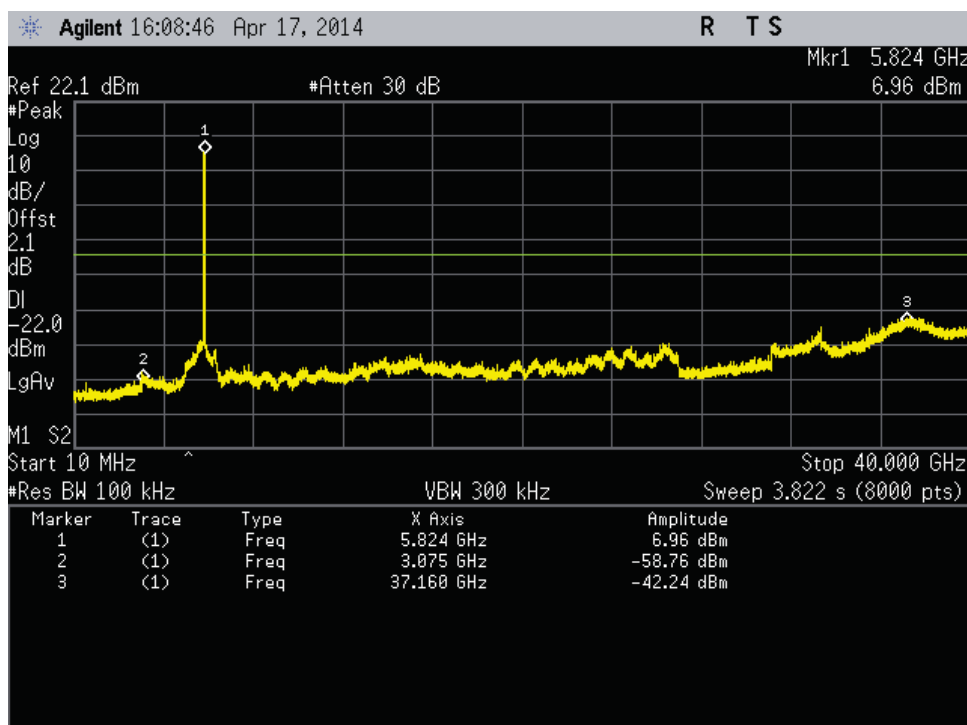

Figure 188: Out of Band Emission-802.11a-5825 MHz-6 Mbps-Ch1

1279 Quarry Lane, Ste. A, Pleasanton, CA 95466  
 Tel: (925) 249-9123, Fax: (925) 249-9124

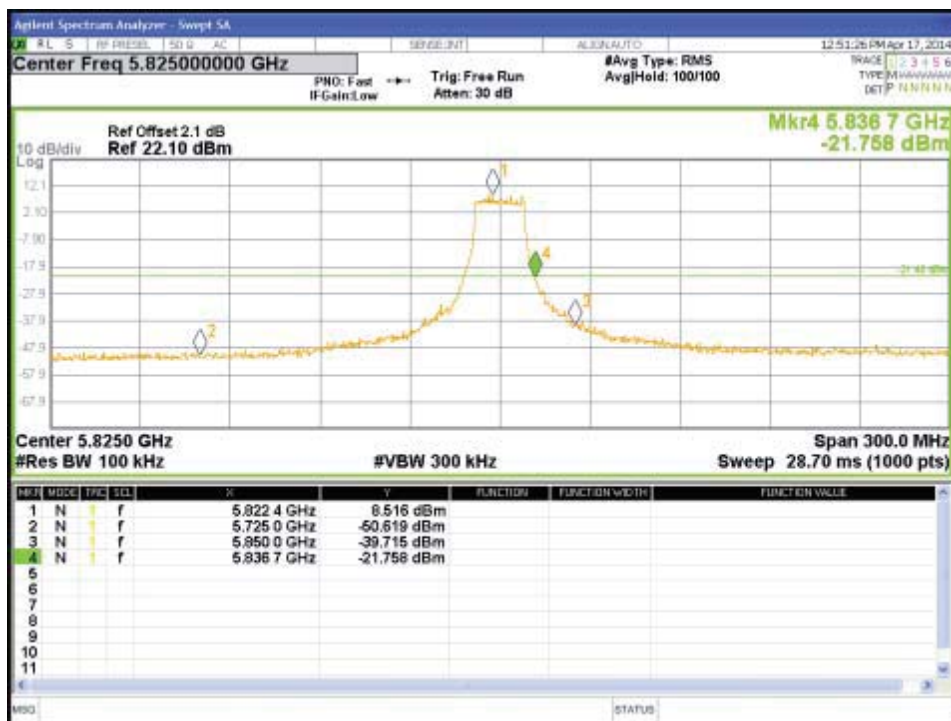

Figure 189: Conducted Band Edge-5825MHz-11a-6 Mbps-Ch2

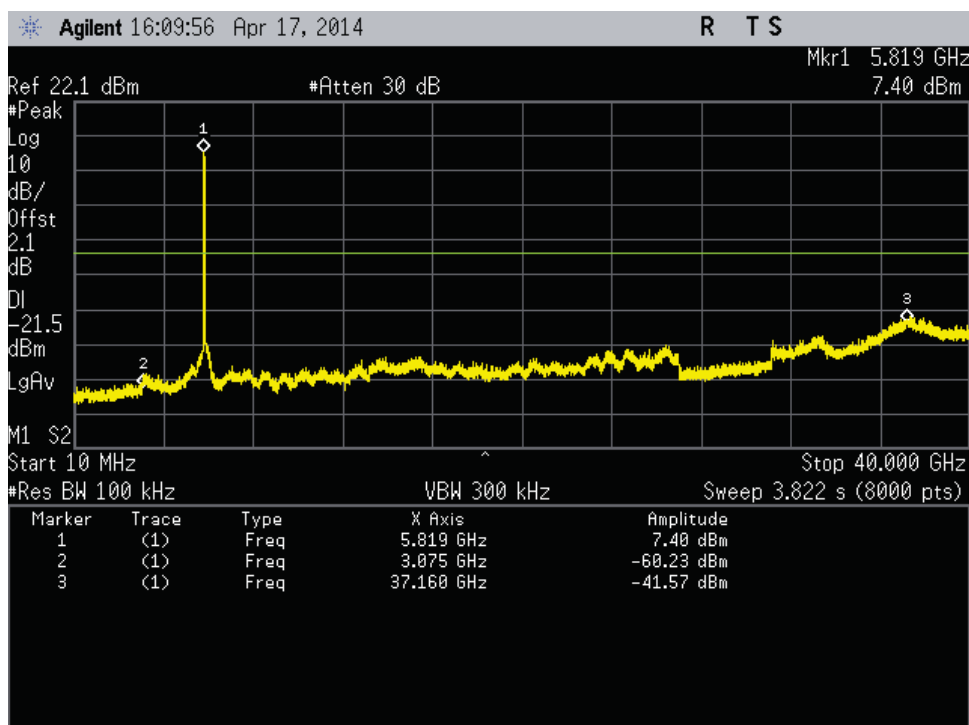

Figure 190: Out of Band Emission-802.11a-5825 MHz-6 Mbps-Ch2



1279 Quarry Lane, Ste. A, Pleasanton, CA 95466  
 Tel: (925) 249-9123, Fax: (925) 249-9124

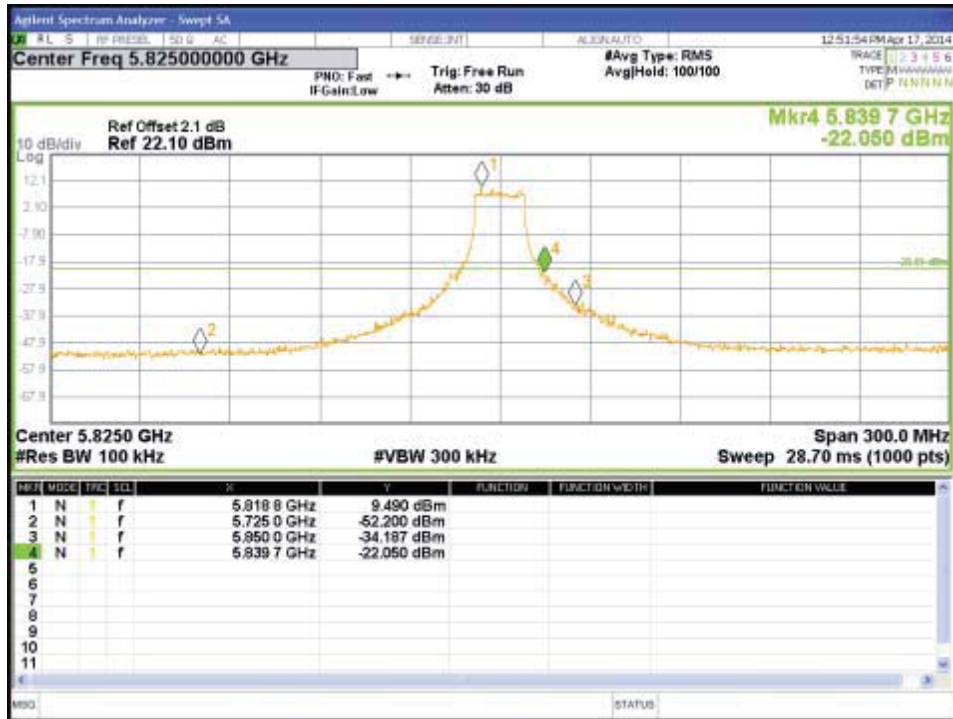

Figure 191: Conducted Band Edge-5825MHz-11a-6 Mbps-Ch3

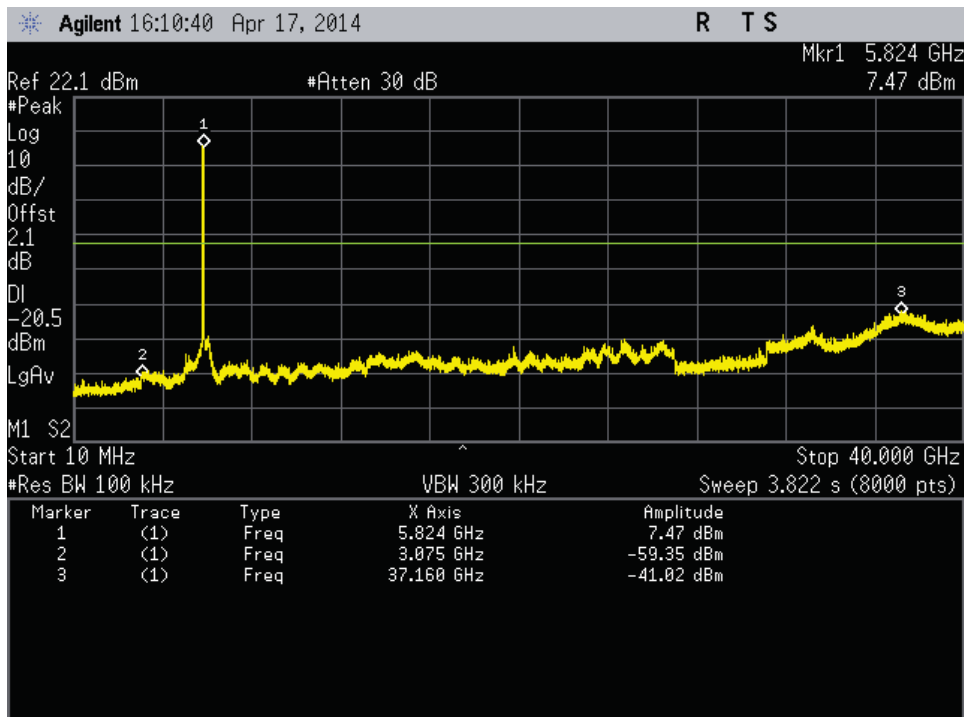

Figure 192: Out of Band Emission-802.11a-5825 MHz-6 Mbps-Ch3

1279 Quarry Lane, Ste. A, Pleasanton, CA 95466  
 Tel: (925) 249-9123, Fax: (925) 249-9124

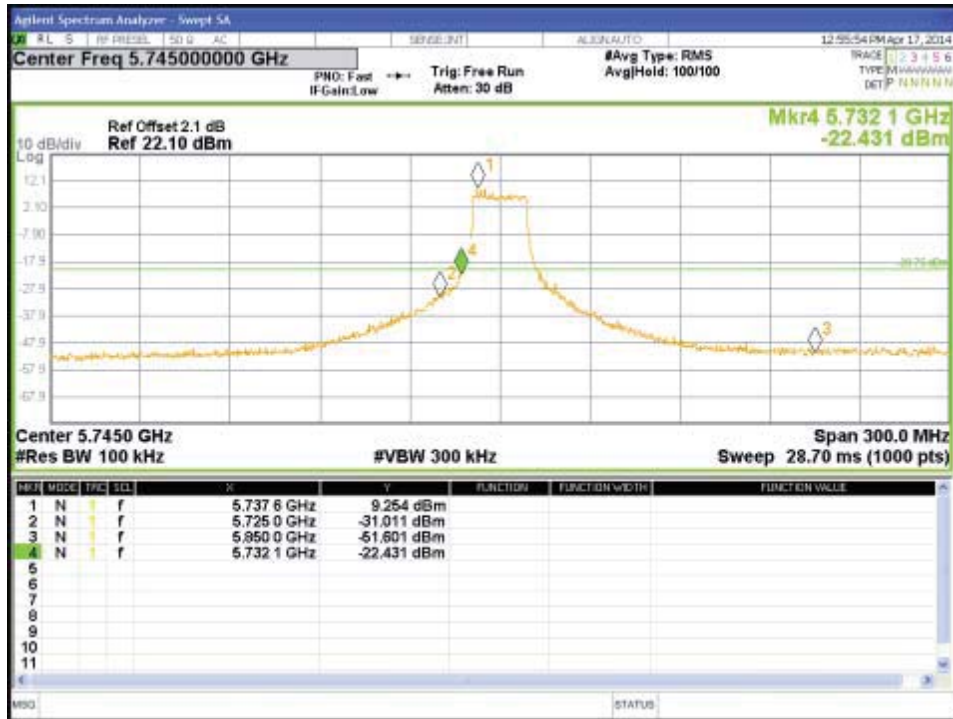

Figure 193: Conducted Band Edge-5745MHz-HT20-MCS0-Ch0

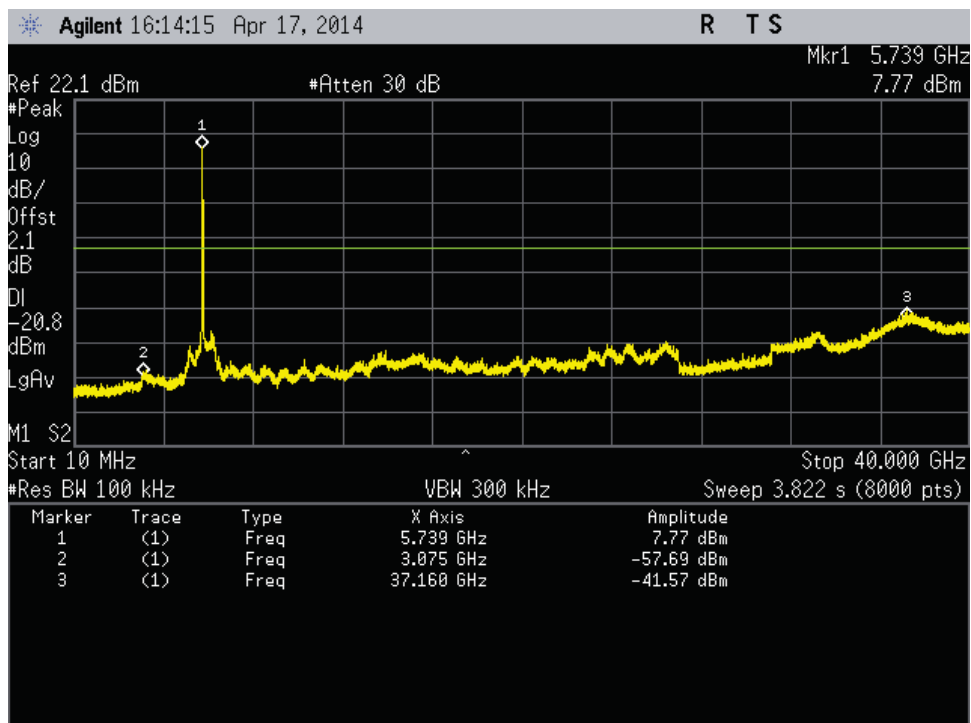

Figure 194: Out of Band Emission-802.11n HT20-5745 MHz-MCS0-Ch0

1279 Quarry Lane, Ste. A, Pleasanton, CA 95466  
 Tel: (925) 249-9123, Fax: (925) 249-9124

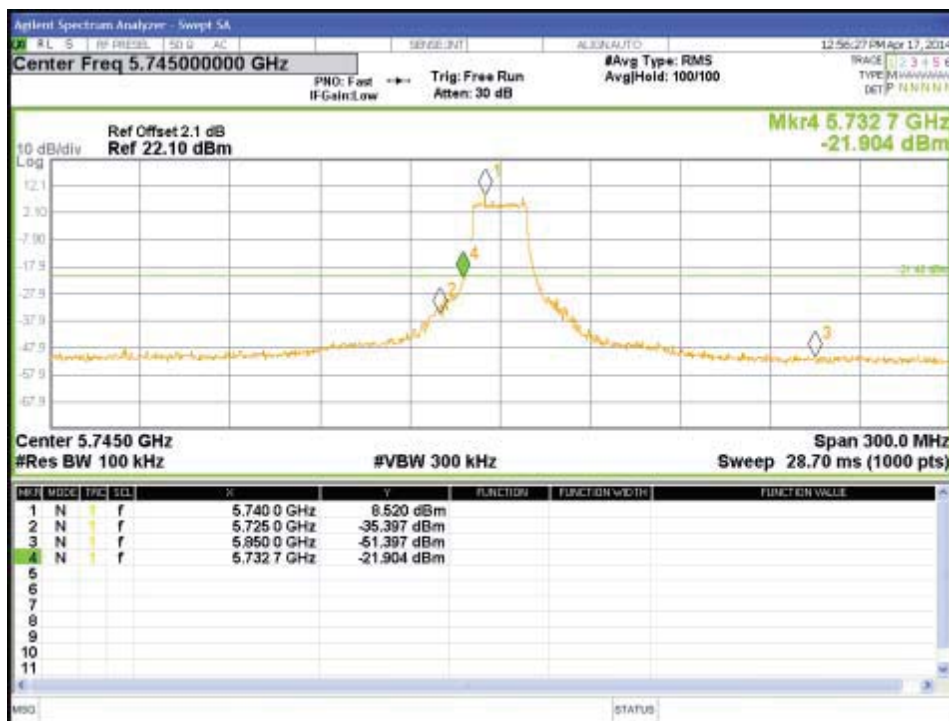

Figure 195: Conducted Band Edge-5745MHz-HT20-MCS0-Ch1

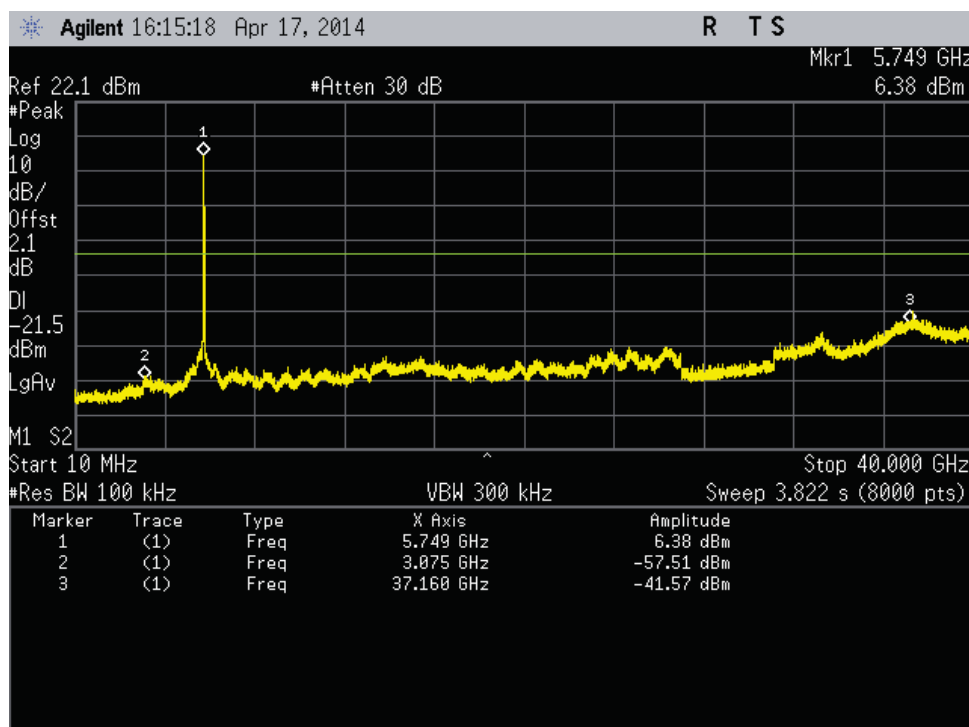

Figure 196: Out of Band Emission-802.11n HT20-5745 MHz-MCS0-Ch1

1279 Quarry Lane, Ste. A, Pleasanton, CA 95466  
 Tel: (925) 249-9123, Fax: (925) 249-9124

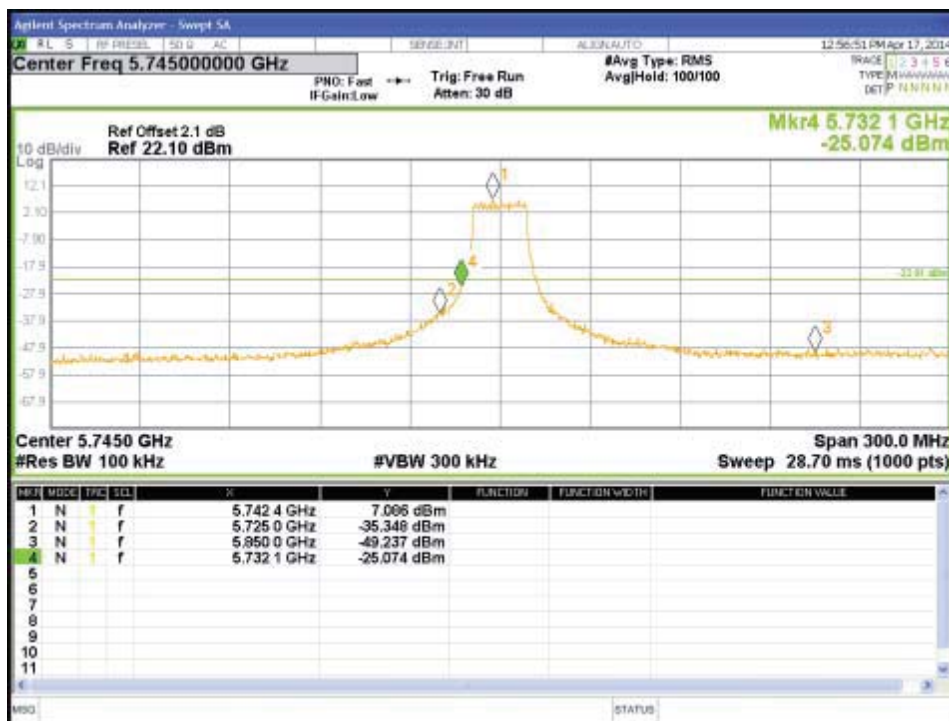

Figure 197: Conducted Band Edge-5745MHz-HT20-MCS0-Ch2

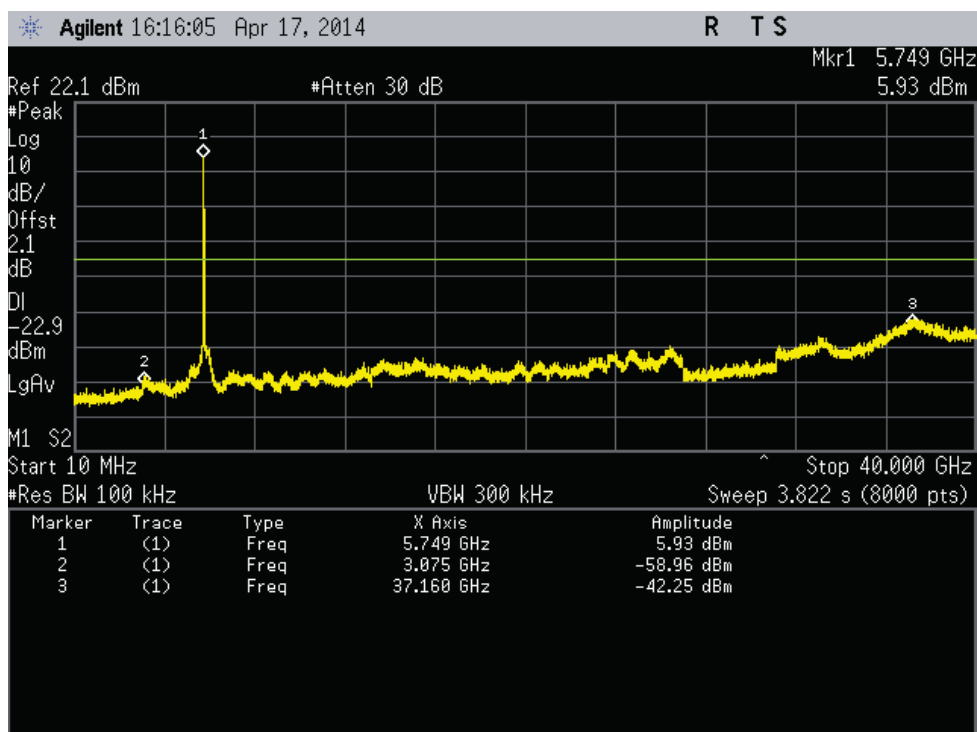

Figure 198: Out of Band Emission-802.11n HT20-5745 MHz-MCS0-Ch2

1279 Quarry Lane, Ste. A, Pleasanton, CA 95466  
 Tel: (925) 249-9123, Fax: (925) 249-9124

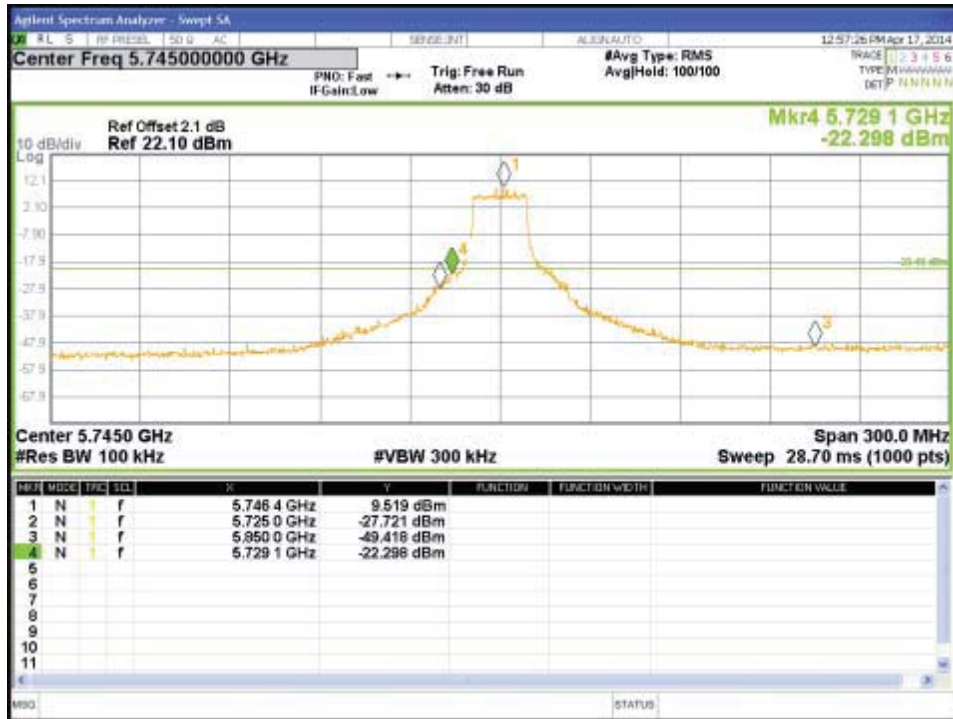

Figure 199: Conducted Band Edge-5745MHz-HT20-MCS0-Ch3

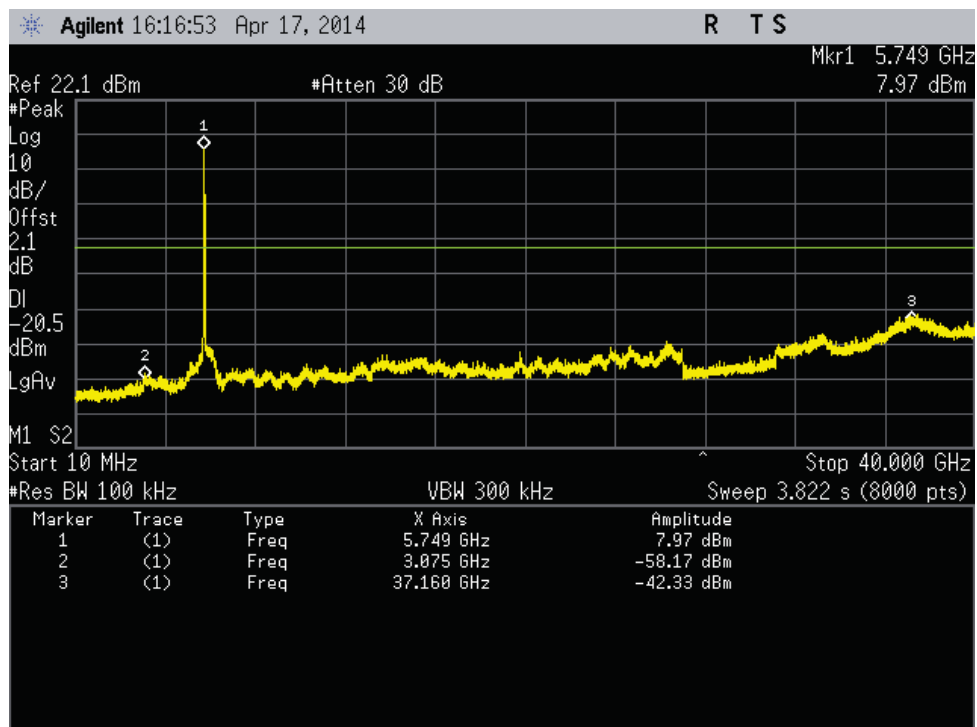

Figure 200: Out of Band Emission-802.11n HT20-5745 MHz-MCS0-Ch3



1279 Quarry Lane, Ste. A, Pleasanton, CA 95466  
 Tel: (925) 249-9123, Fax: (925) 249-9124

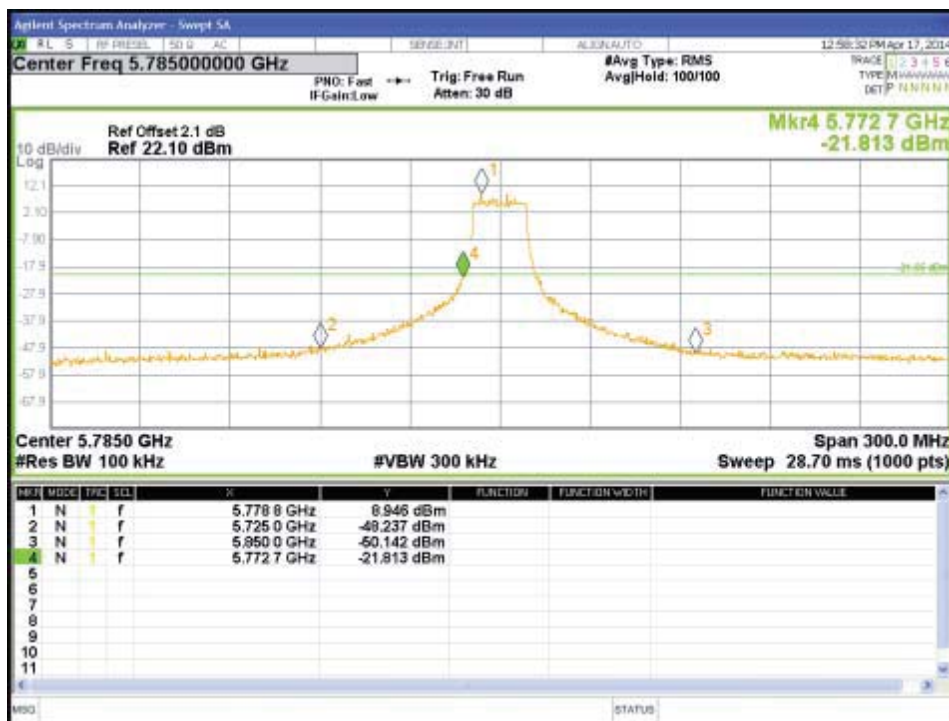

Figure 201: Conducted Band Edge-5785MHz-HT20-MCS0-Ch0

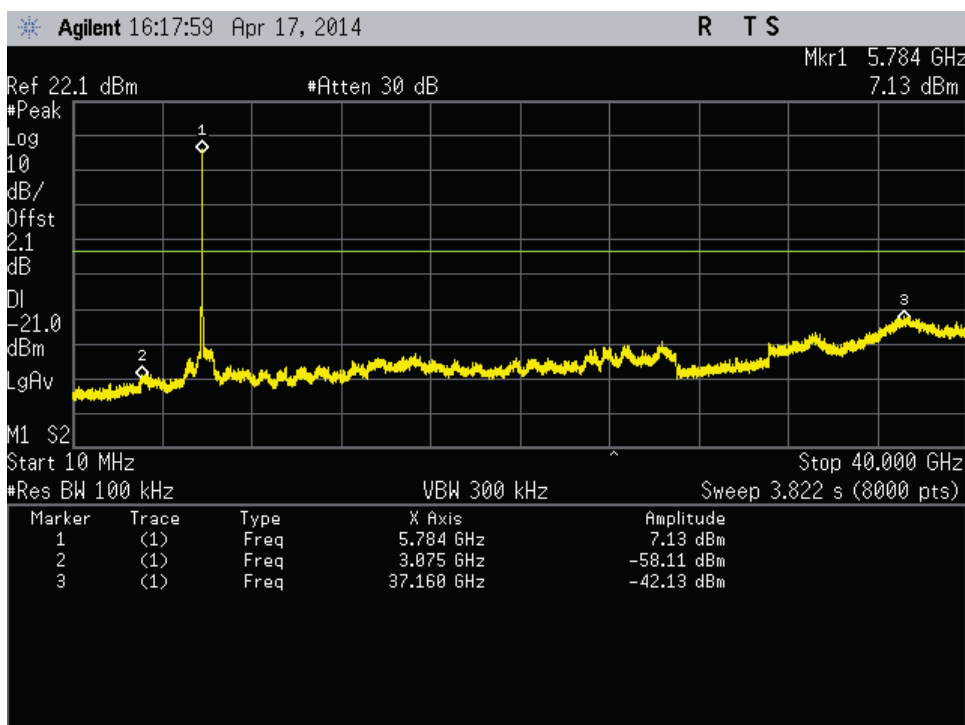

Figure 202: Out of Band Emission-802.11n HT20-5785 MHz-MCS0-Ch0

1279 Quarry Lane, Ste. A, Pleasanton, CA 95466  
 Tel: (925) 249-9123, Fax: (925) 249-9124



Figure 203: Conducted Band Edge-5785MHz-HT20-MCS0-Ch1

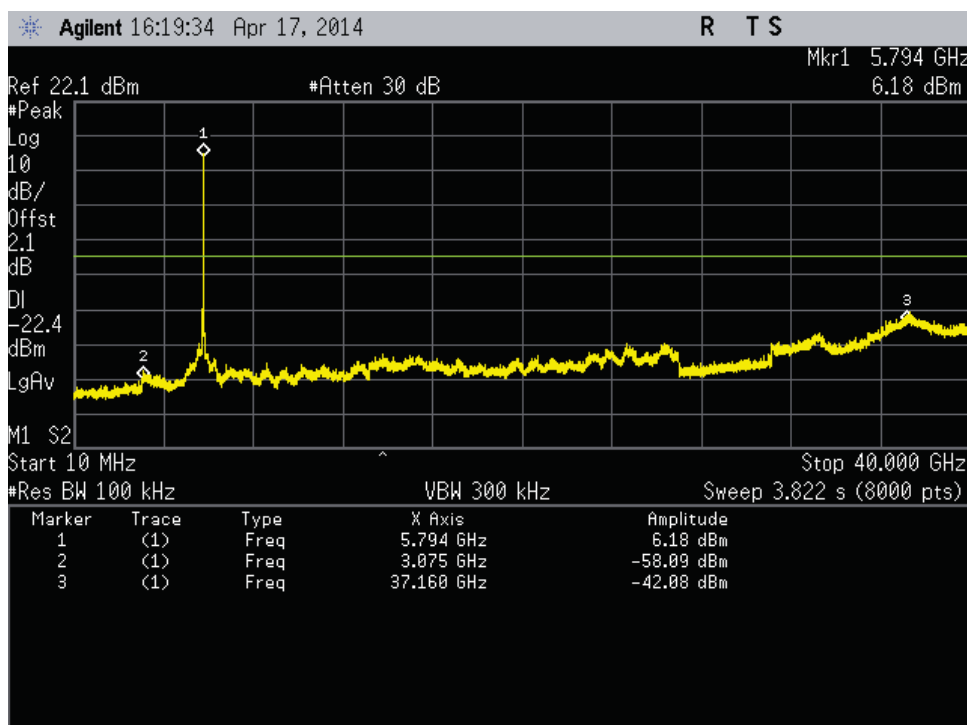

Figure 204: Out of Band Emission-802.1MHz-HT20-5785 MHz-MCS0-Ch1

1279 Quarry Lane, Ste. A, Pleasanton, CA 95466  
 Tel: (925) 249-9123, Fax: (925) 249-9124

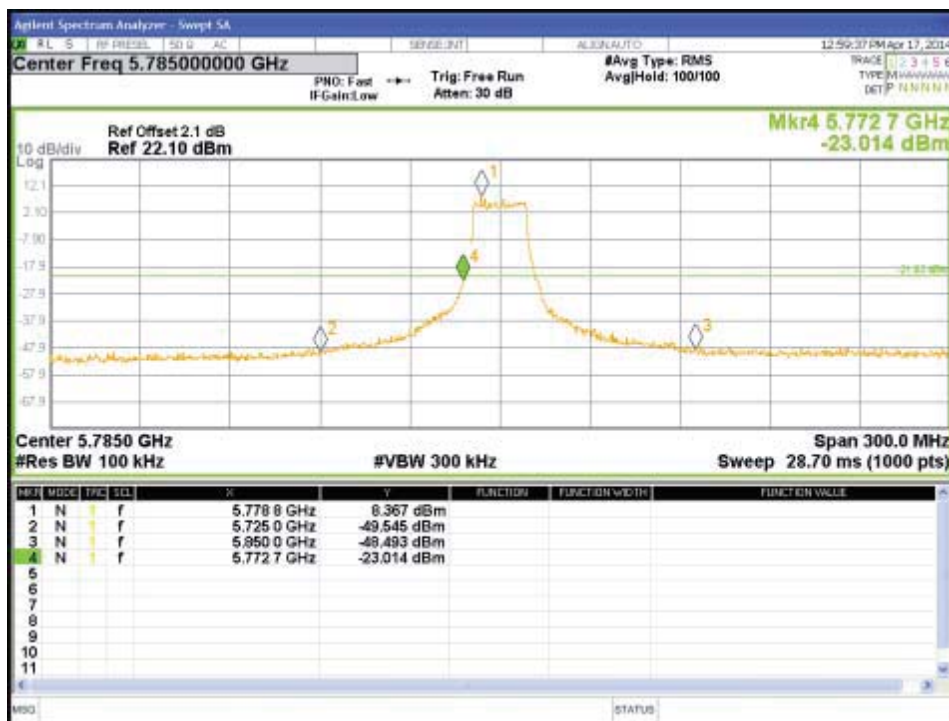

Figure 205: Conducted Band Edge-5785MHz-HT20-MCS0-Ch2

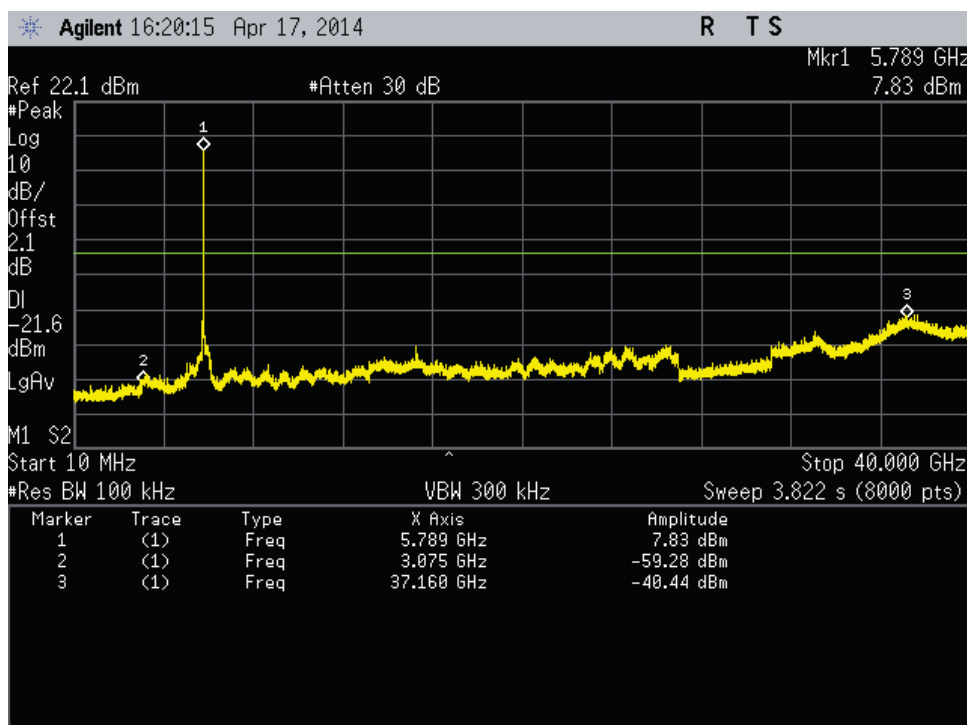

Figure 206: Out of Band Emission-802.1In HT20-5785 MHz-MCS0-Ch2

1279 Quarry Lane, Ste. A, Pleasanton, CA 95466  
 Tel: (925) 249-9123, Fax: (925) 249-9124

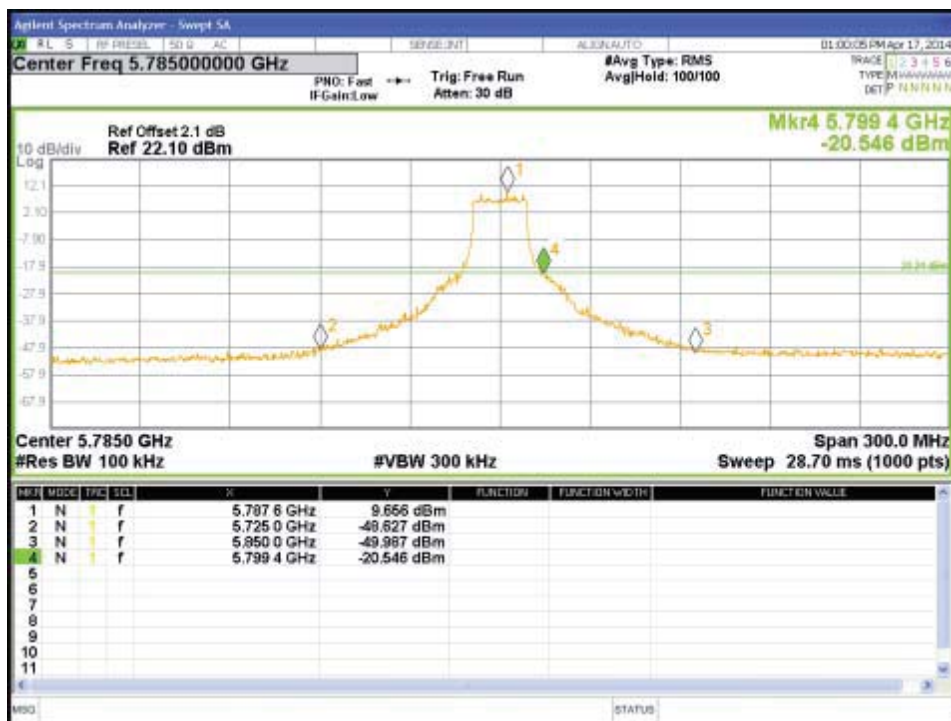

Figure 207: Conducted Band Edge-5785MHz-HT20-MCS0-Ch3

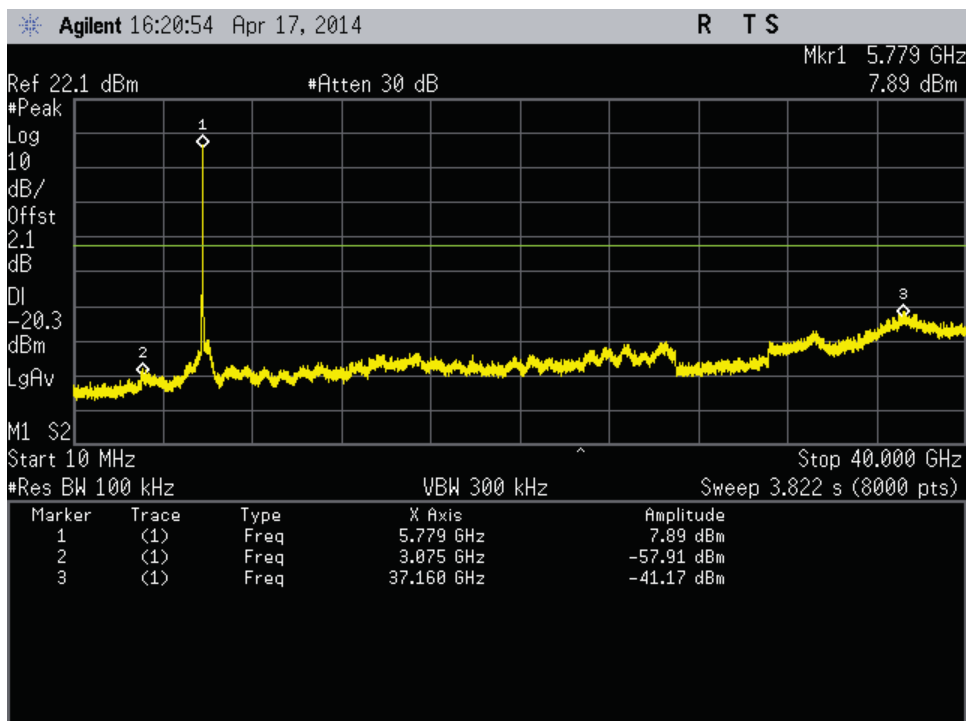

Figure 208: Out of Band Emission-802.1 In HT20-5785 MHz-MCS0-Ch3

1279 Quarry Lane, Ste. A, Pleasanton, CA 95466  
 Tel: (925) 249-9123, Fax: (925) 249-9124

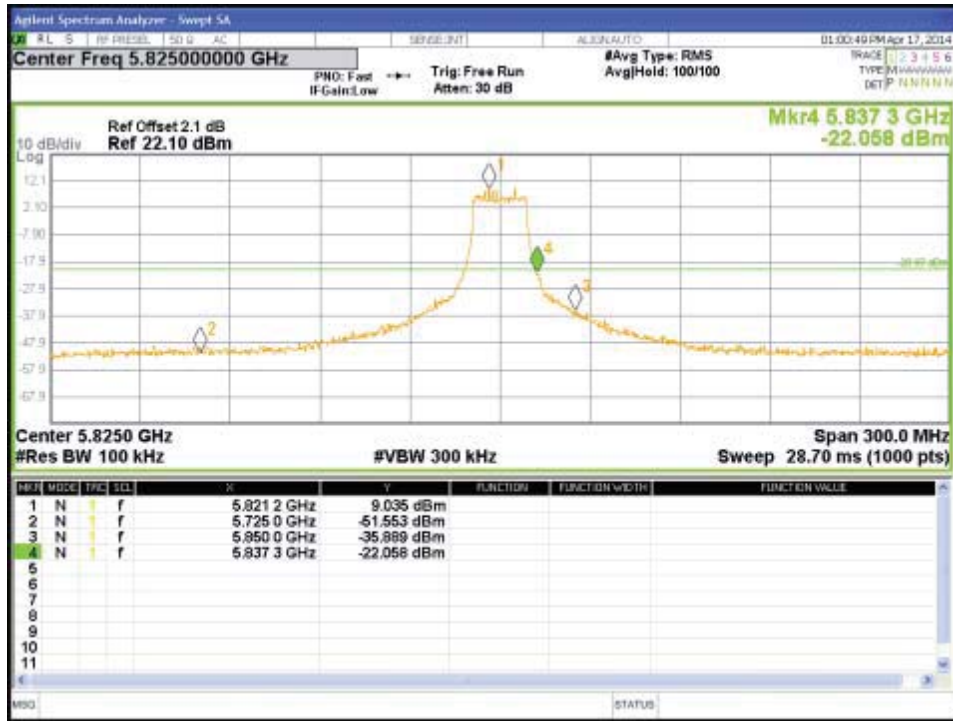

Figure 209: Conducted Band Edge-5825MHz-HT20-MCS0-Ch0

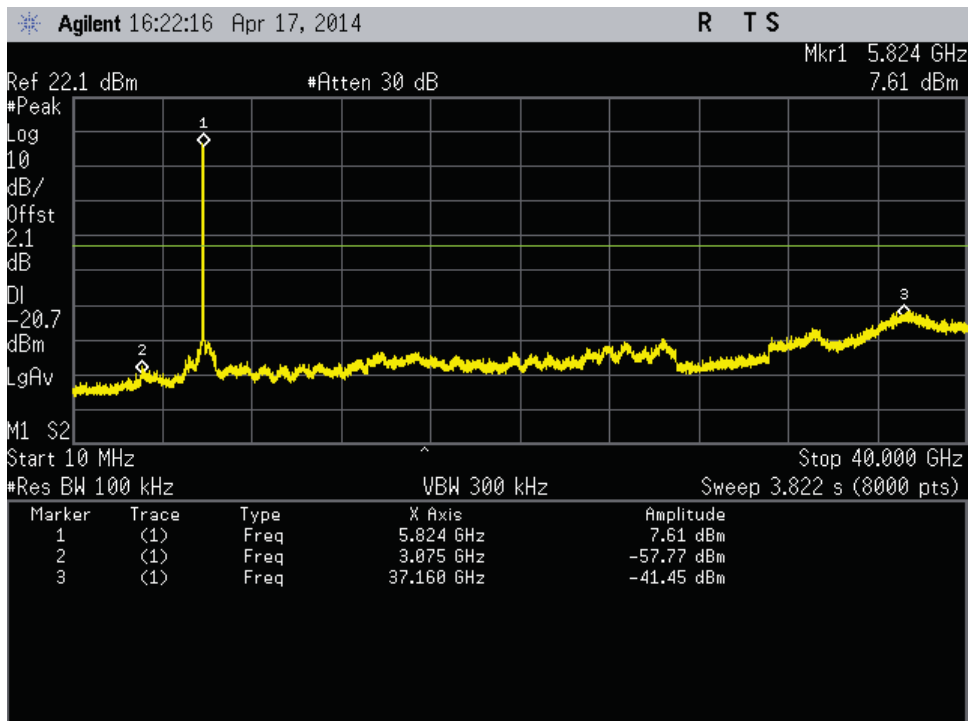

Figure 210: Out of Band Emission-802.1n HT20-5825 MHz-MCS0-Ch0



1279 Quarry Lane, Ste. A, Pleasanton, CA 95466  
 Tel: (925) 249-9123, Fax: (925) 249-9124

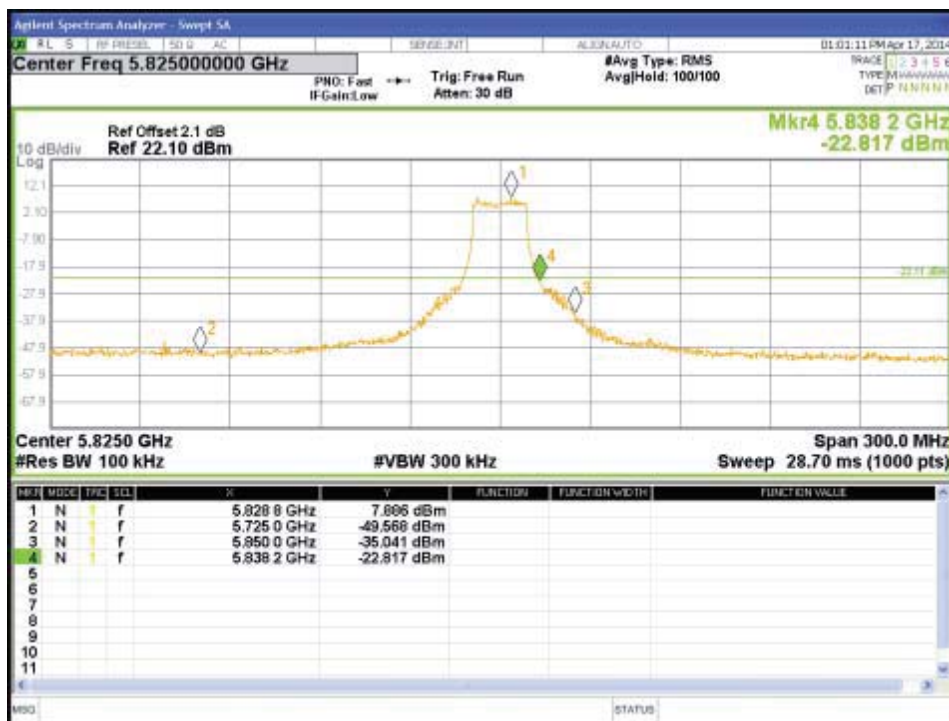

Figure 211: Conducted Band Edge-5825MHz-HT20-MCS0-Ch1

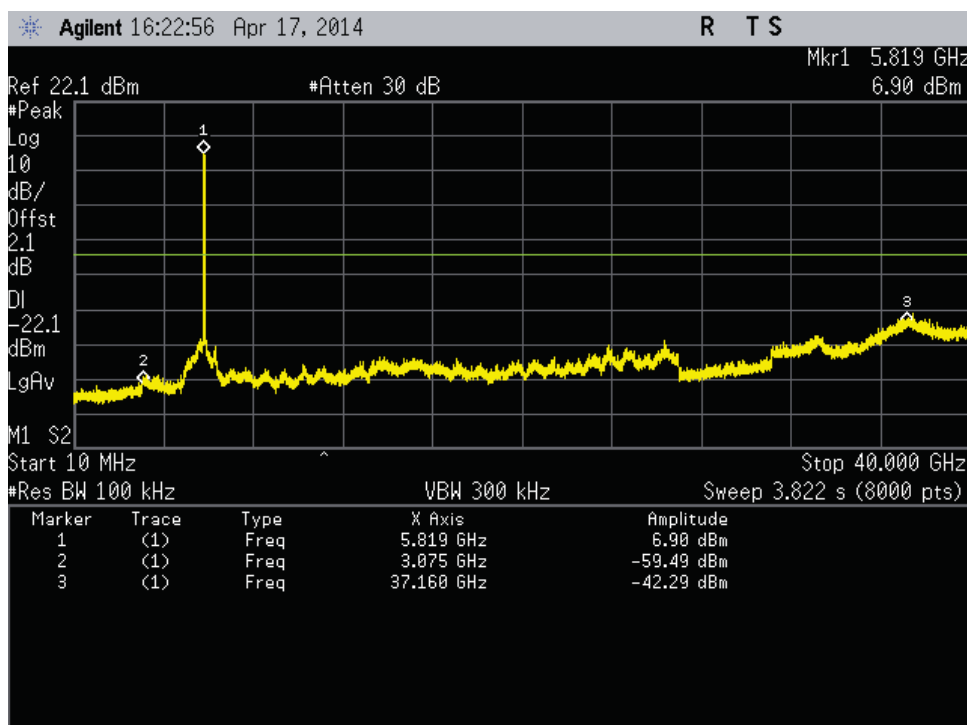

Figure 212: Out of Band Emission-802.1MHz-HT20-5825 MHz-MCS0-Ch1

1279 Quarry Lane, Ste. A, Pleasanton, CA 95466  
 Tel: (925) 249-9123, Fax: (925) 249-9124



Figure 213: Conducted Band Edge-5825MHz-HT20-MCS0-Ch2

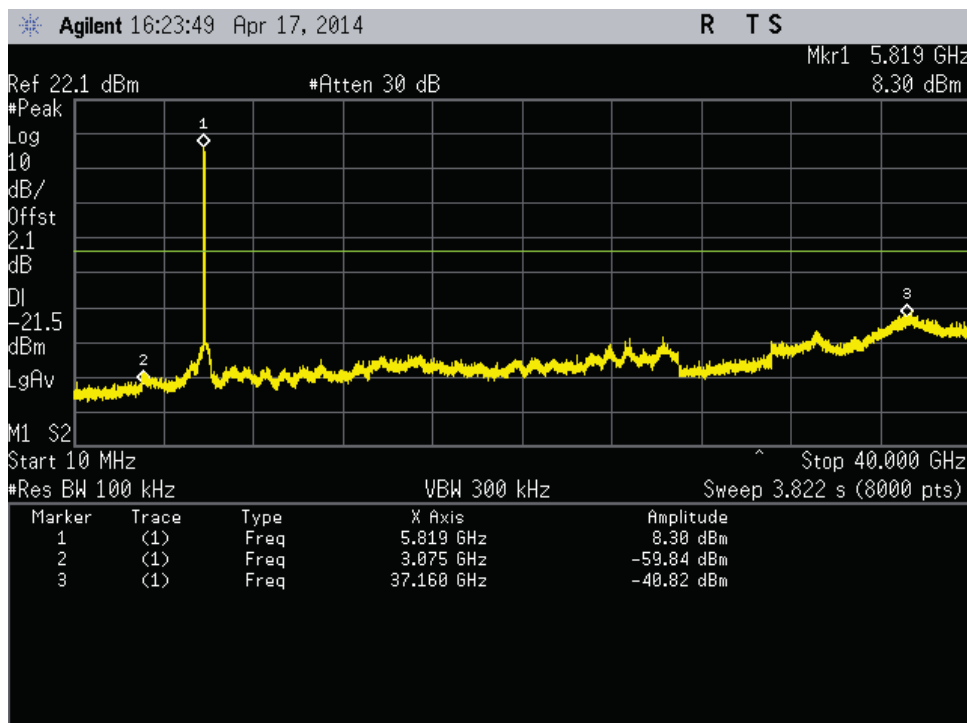

Figure 214: Out of Band Emission-802.11n HT20-5825 MHz-MCS0-Ch2

1279 Quarry Lane, Ste. A, Pleasanton, CA 95466  
 Tel: (925) 249-9123, Fax: (925) 249-9124

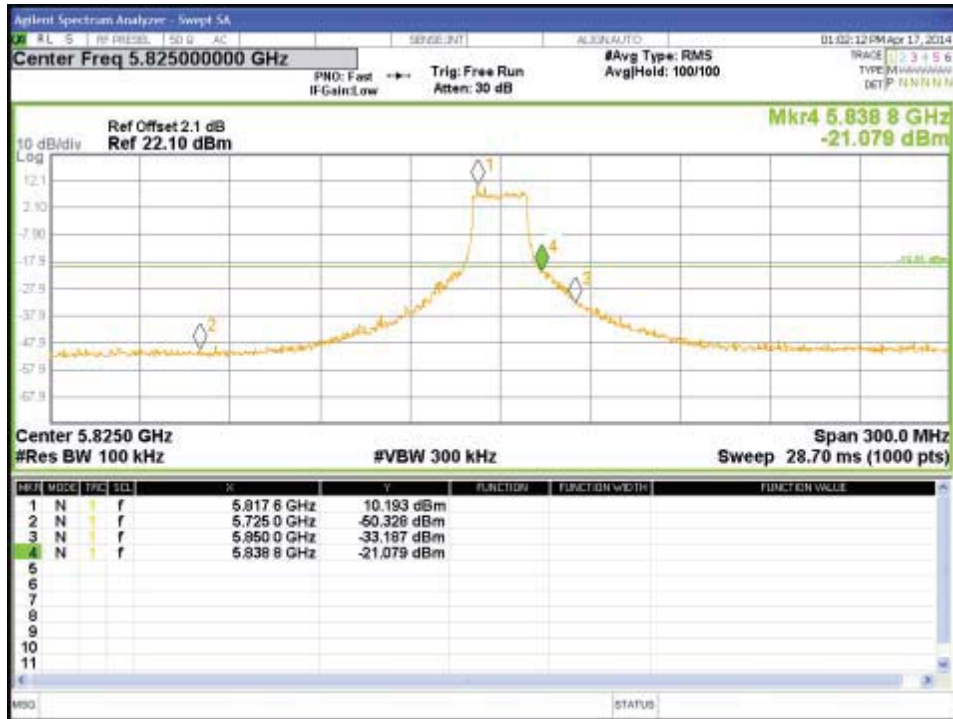

Figure 215: Conducted Band Edge-5825MHz-HT20-MCS0-Ch3

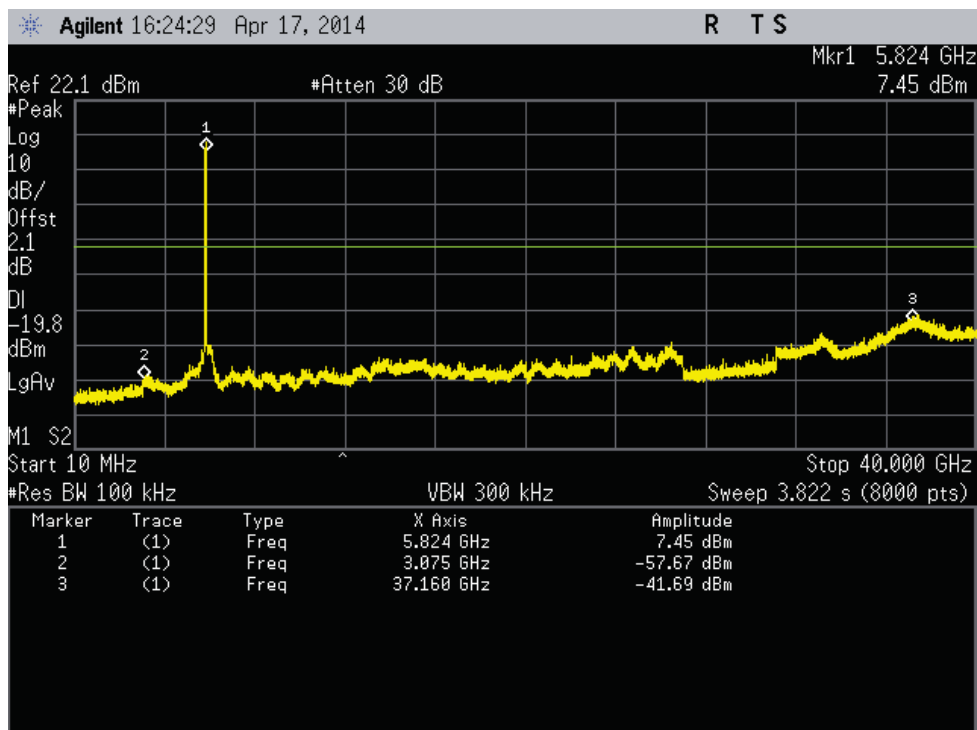

Figure 216: Out of Band Emission-802.11n HT20-5825 MHz-MCS0-Ch3

1279 Quarry Lane, Ste. A, Pleasanton, CA 95466  
 Tel: (925) 249-9123, Fax: (925) 249-9124

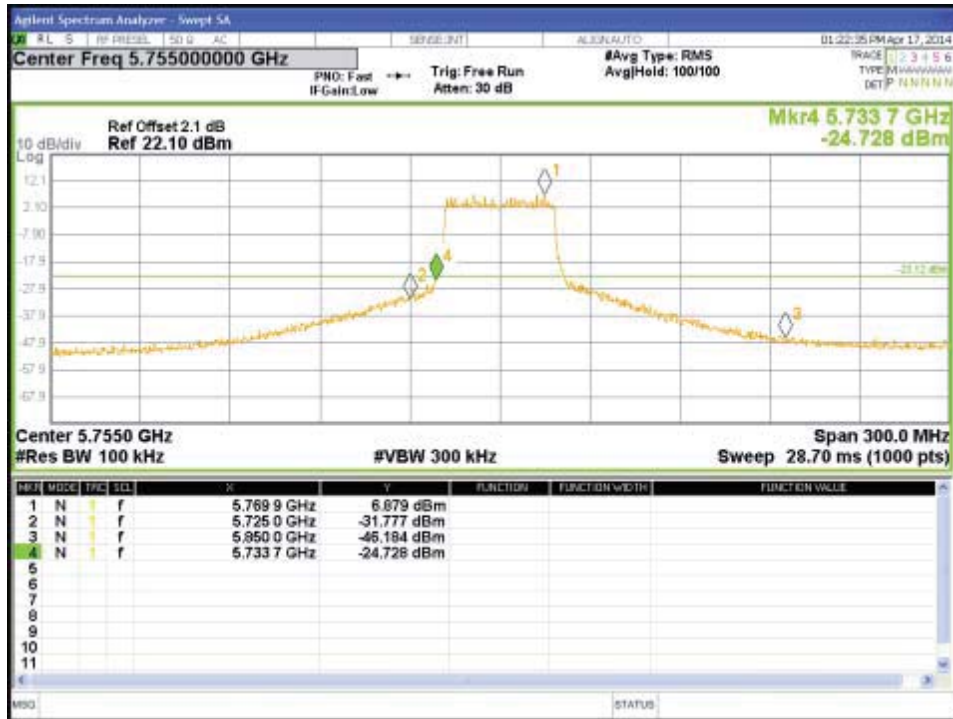

Figure 217: Conducted Band Edge-5755MHz-HT40-MCS0-Ch0

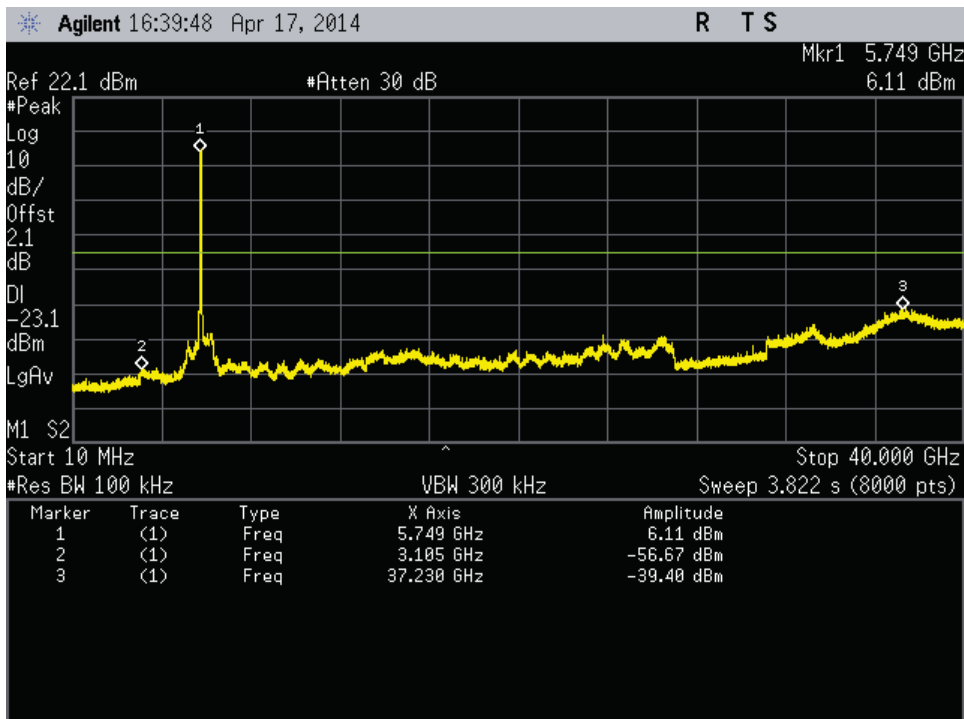

Figure 218: Out of Band Emission-802.1In HT40-5755 MHz-MCS0-Ch0

1279 Quarry Lane, Ste. A, Pleasanton, CA 95466  
 Tel: (925) 249-9123, Fax: (925) 249-9124

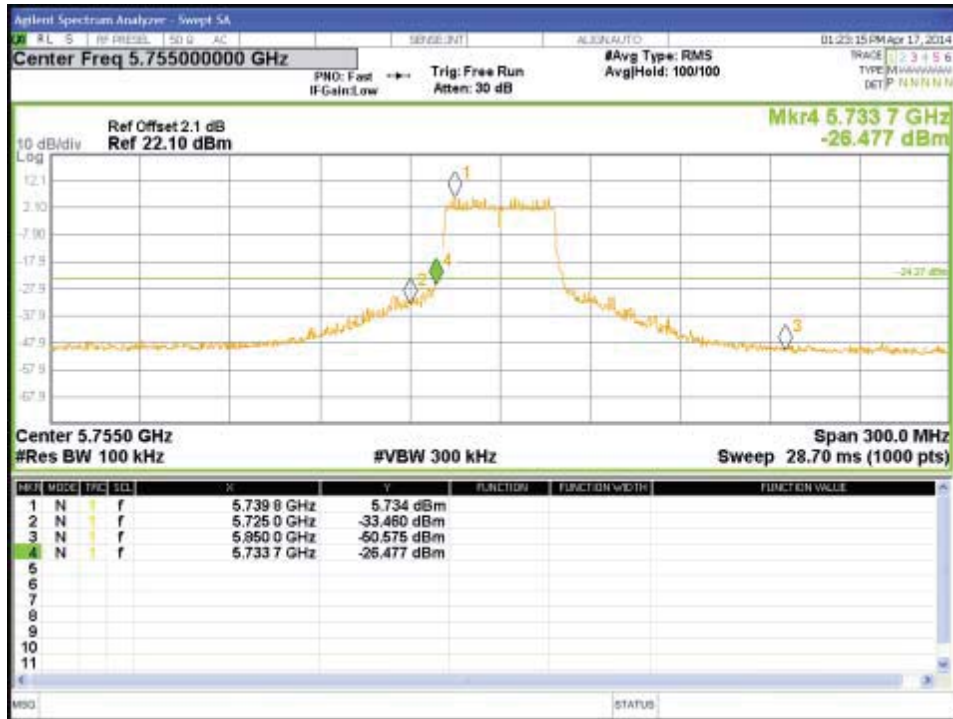

Figure 219: Conducted Band Edge-5755MHz-HT40-MCS0-Ch1

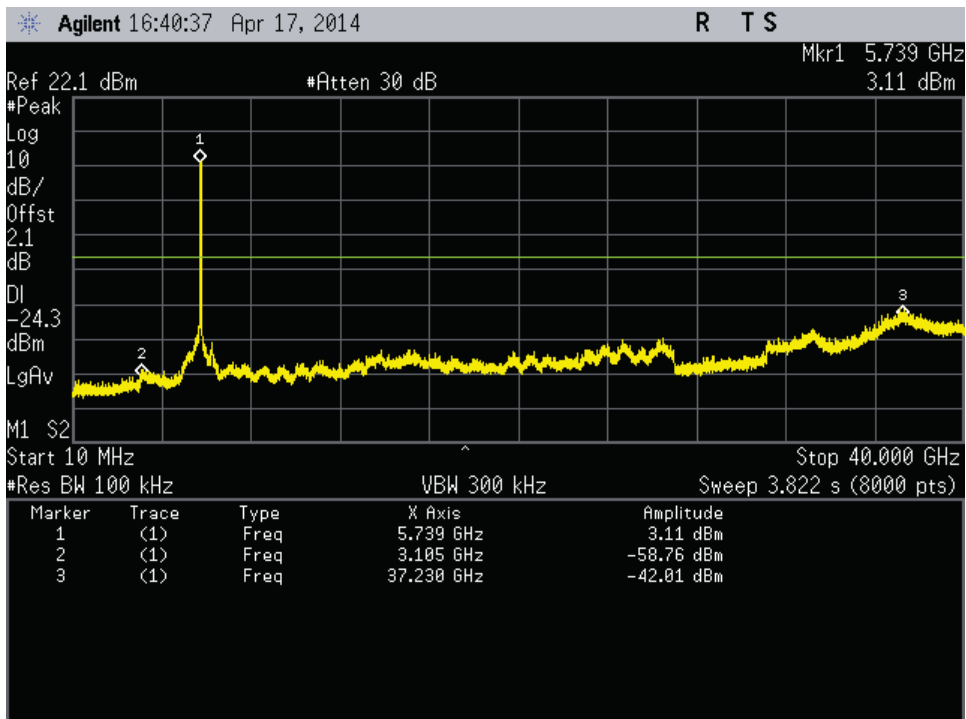

Figure 220: Out of Band Emission-802.1In HT40-5755 MHz-MCS0-Ch1

1279 Quarry Lane, Ste. A, Pleasanton, CA 95466  
 Tel: (925) 249-9123, Fax: (925) 249-9124

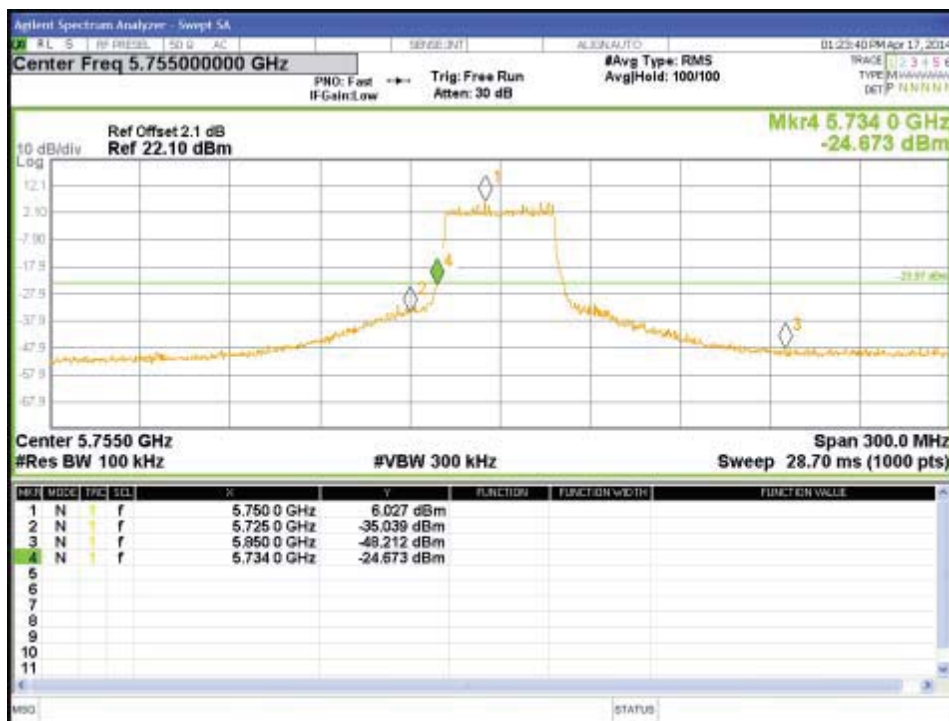

Figure 221: Conducted Band Edge-5755MHz-HT40-MCS0-Ch2

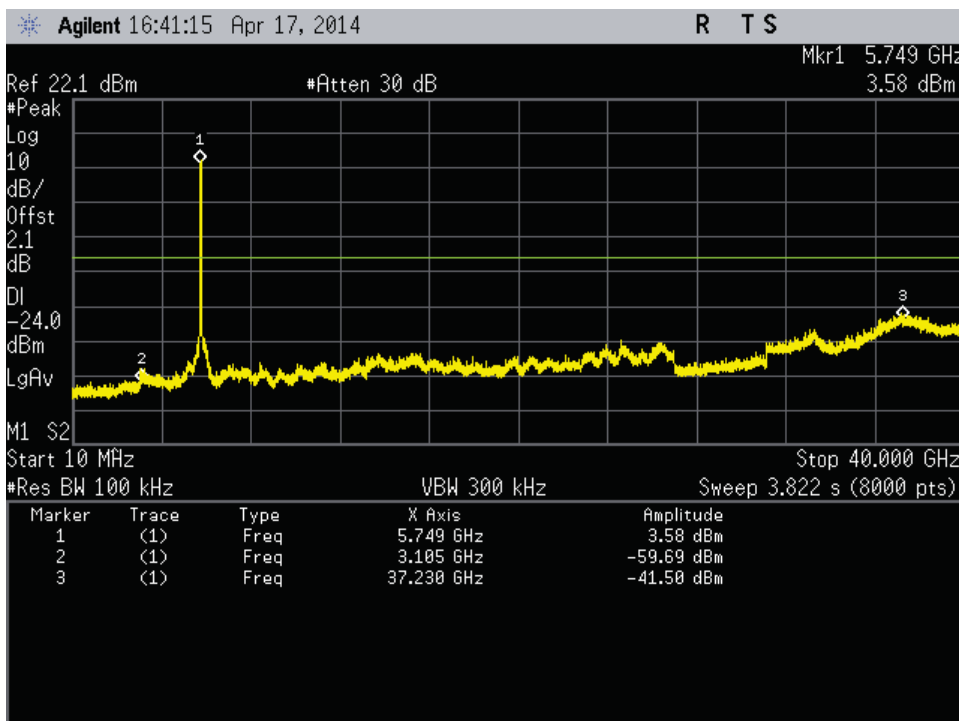

Figure 222: Out of Band Emission-802.1In HT40-5755 MHz-MCS0-Ch2



1279 Quarry Lane, Ste. A, Pleasanton, CA 95466  
 Tel: (925) 249-9123, Fax: (925) 249-9124



Figure 223: Conducted Band Edge-5755MHz-HT40-MCS0-Ch3

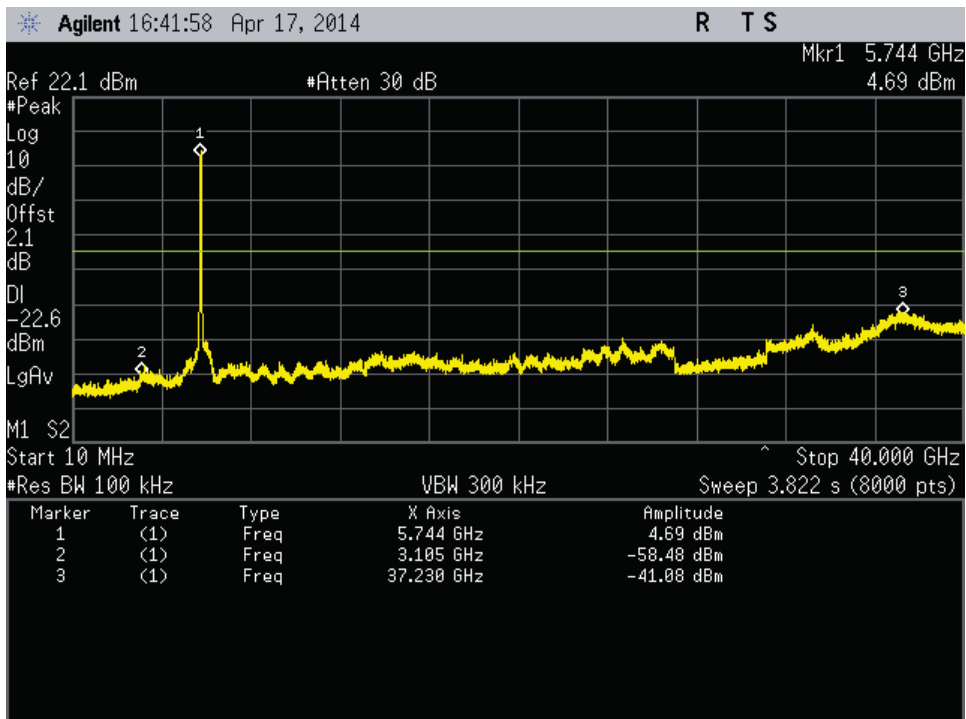

Figure 224: Out of Band Emission-802.1In HT40-5755 MHz-MCS0-Ch3

1279 Quarry Lane, Ste. A, Pleasanton, CA 95466  
 Tel: (925) 249-9123, Fax: (925) 249-9124

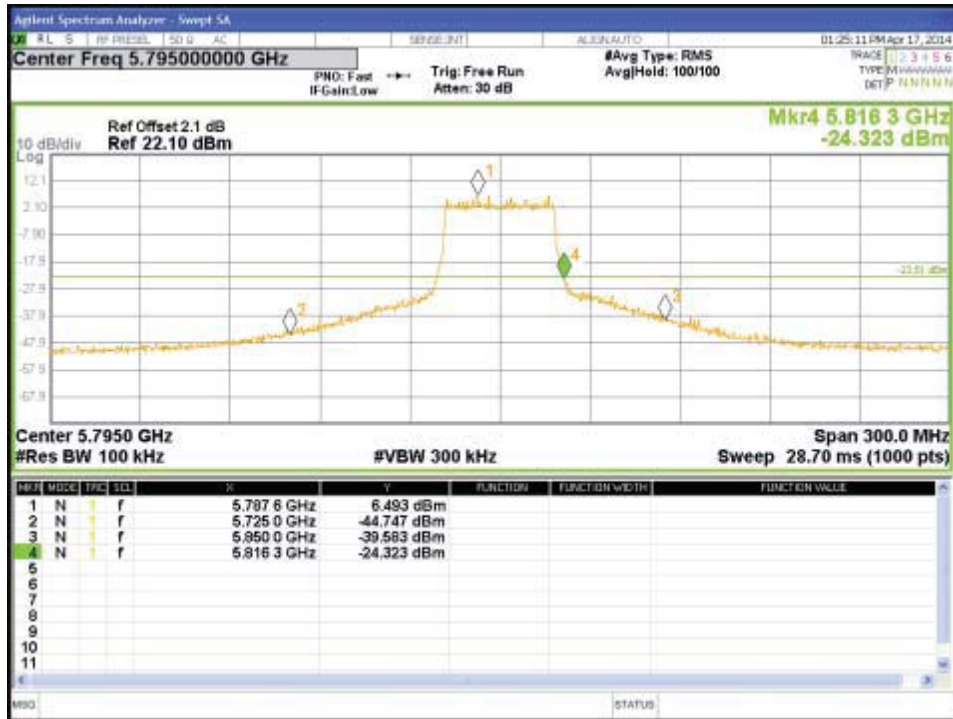

Figure 225: Conducted Band Edge-5795MHz-HT40-MCS0-Ch0

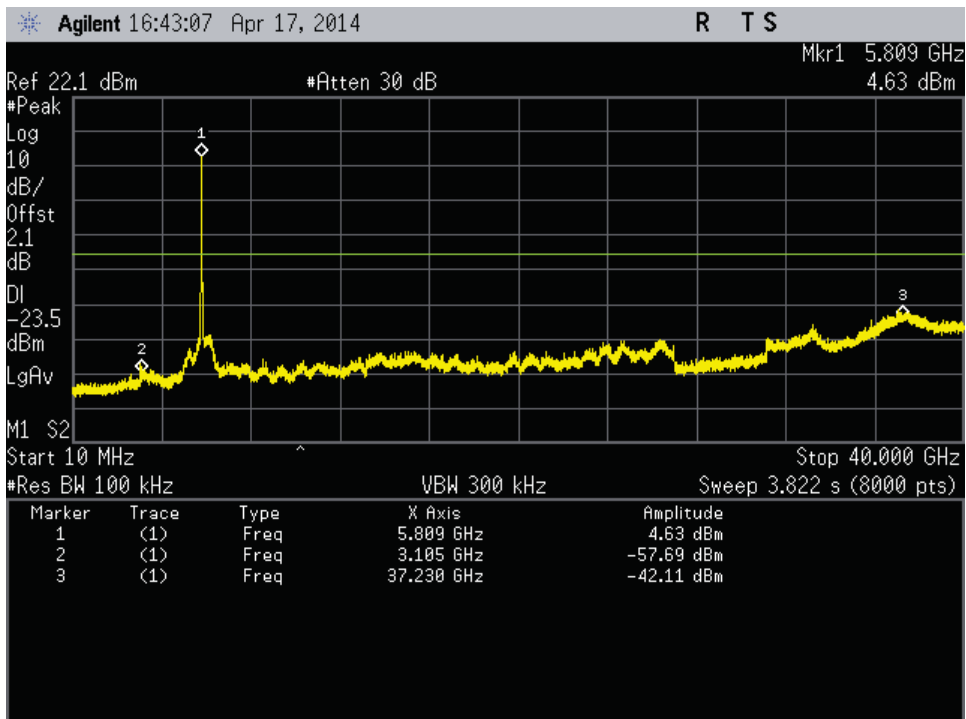

Figure 226: Out of Band Emission-802.11n HT40-5795 MHz-MCS0-Ch0

1279 Quarry Lane, Ste. A, Pleasanton, CA 95466  
 Tel: (925) 249-9123, Fax: (925) 249-9124

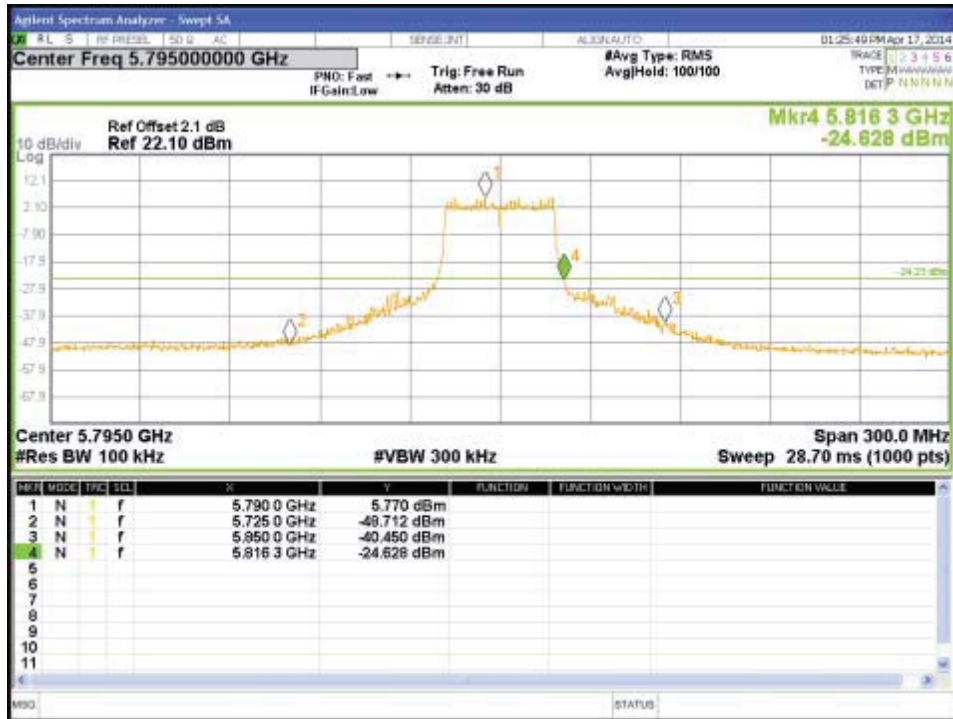

Figure 227: Conducted Band Edge-5795MHz-HT40-MCS0-Ch1

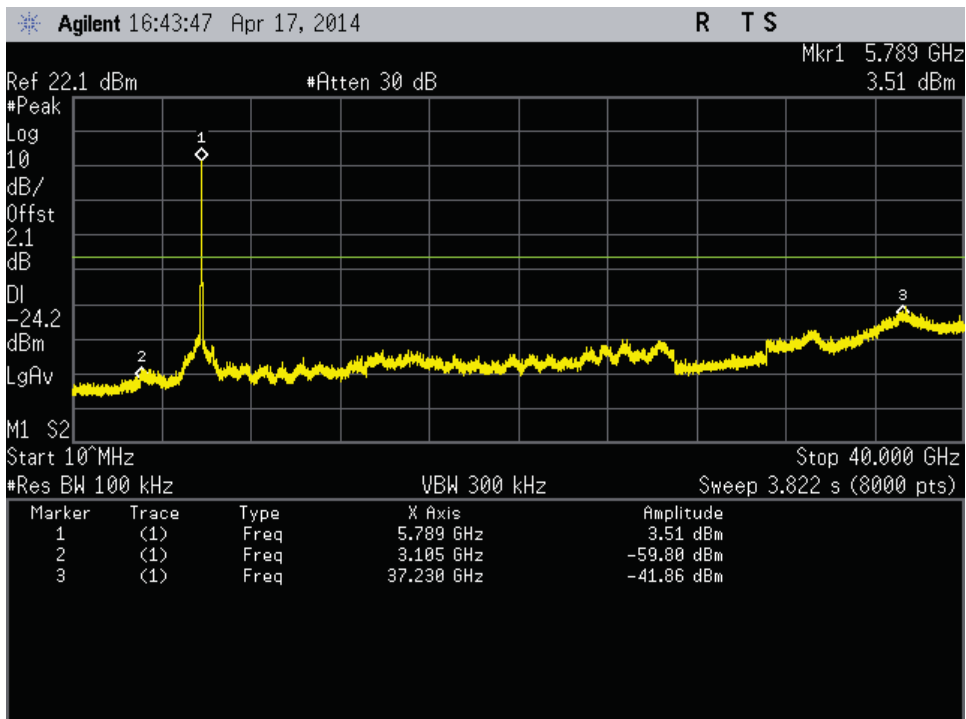

Figure 228: Out of Band Emission-802.1n HT40-5795 MHz-MCS0-Ch1

1279 Quarry Lane, Ste. A, Pleasanton, CA 95466  
 Tel: (925) 249-9123, Fax: (925) 249-9124

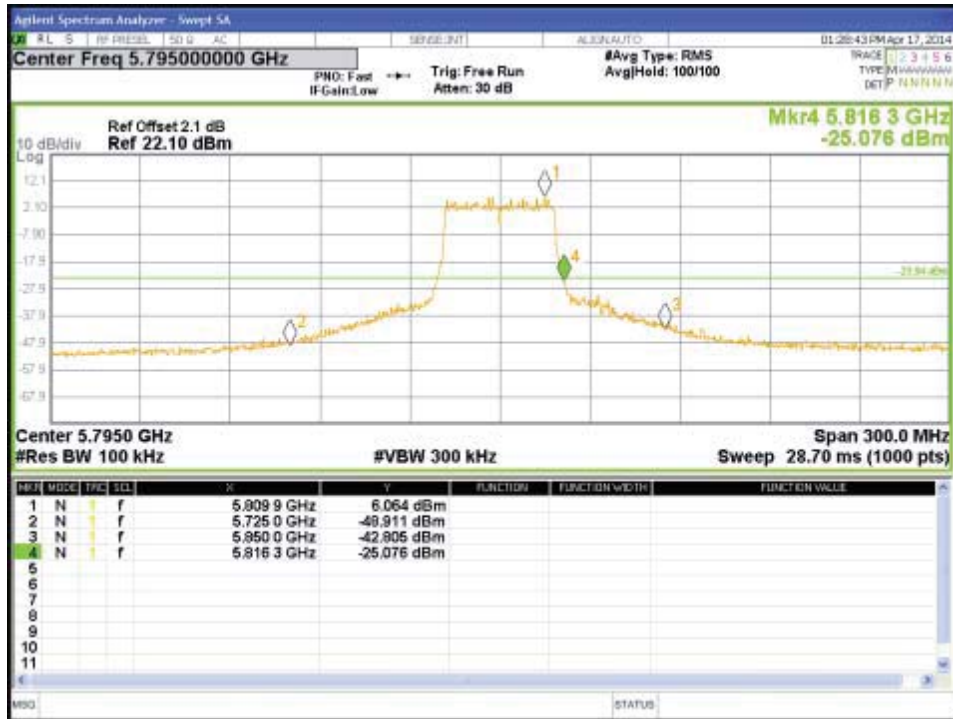

Figure 229: Conducted Band Edge-5795MHz-HT40-MCS0-Ch2

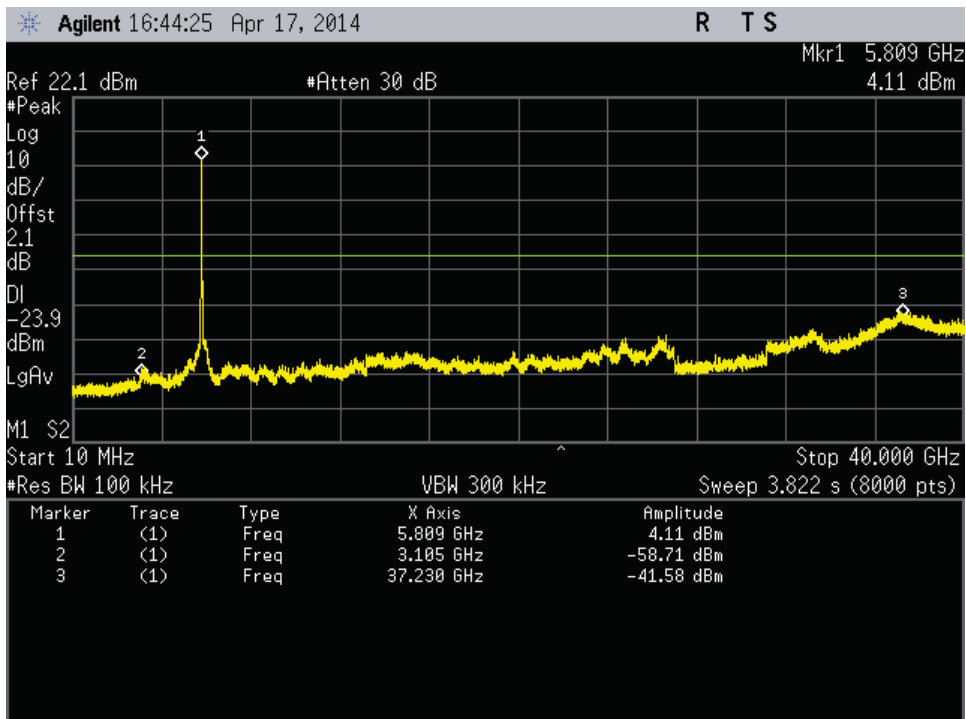

Figure 230: Out of Band Emission-802.1In HT40-5795 MHz-MCS0-Ch2

1279 Quarry Lane, Ste. A, Pleasanton, CA 95466  
 Tel: (925) 249-9123, Fax: (925) 249-9124

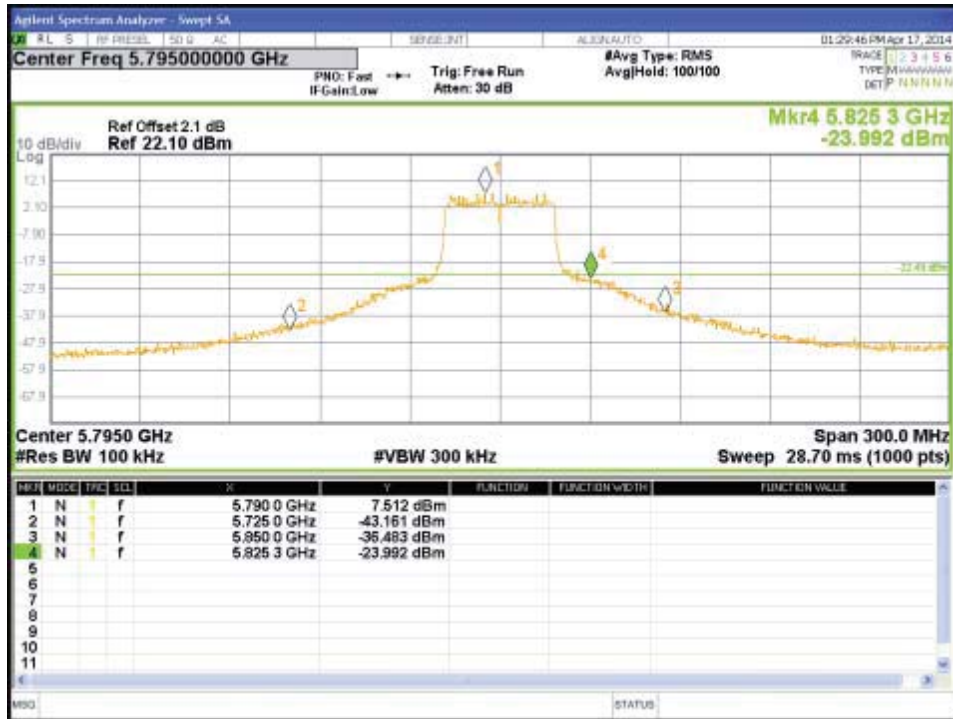

Figure 231: Conducted Band Edge-5795MHz-HT40-MCS0-Ch3

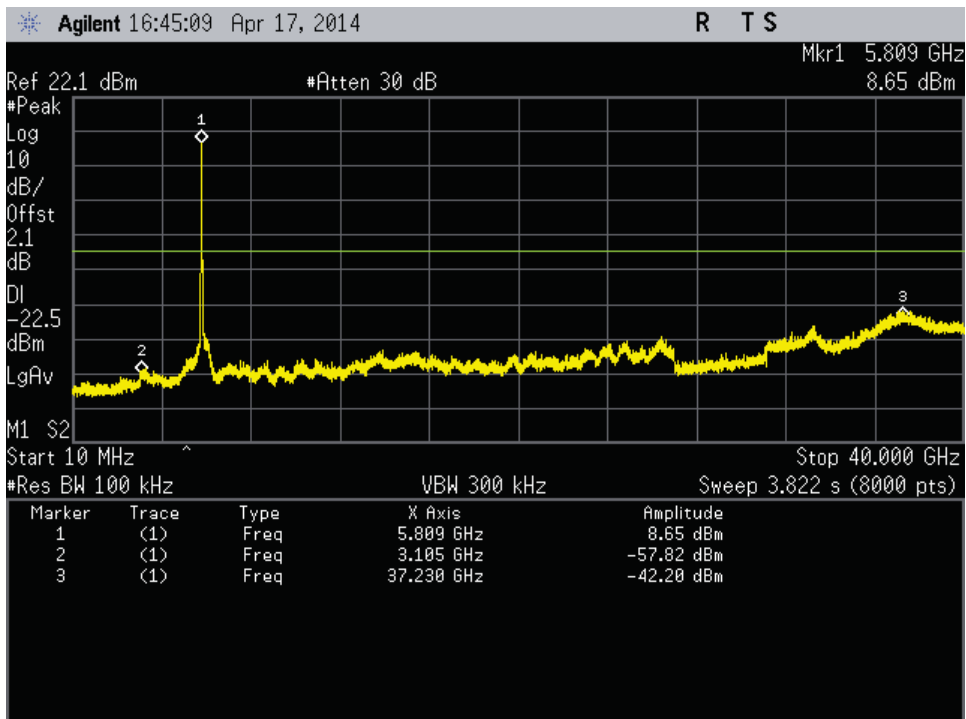

Figure 232: Out of Band Emission-802.1MHz-HT40-5795 MHz-MCS0-Ch3

1279 Quarry Lane, Ste. A, Pleasanton, CA 95466  
 Tel: (925) 249-9123, Fax: (925) 249-9124

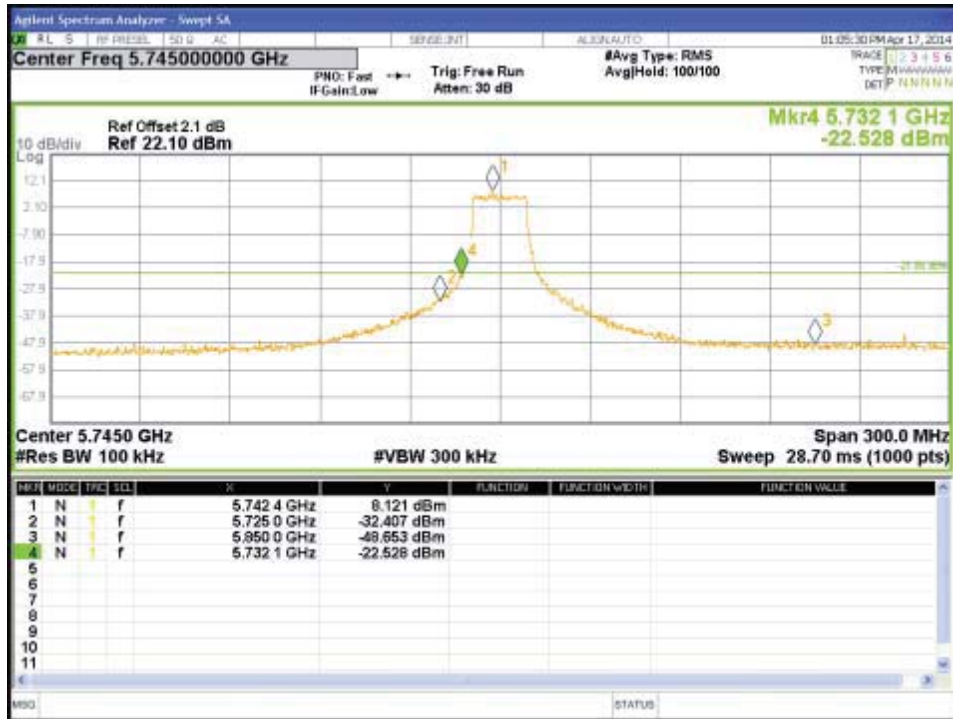

Figure 233: Conducted Band Edge-5745MHz-VHT20-MCS0-Ch0

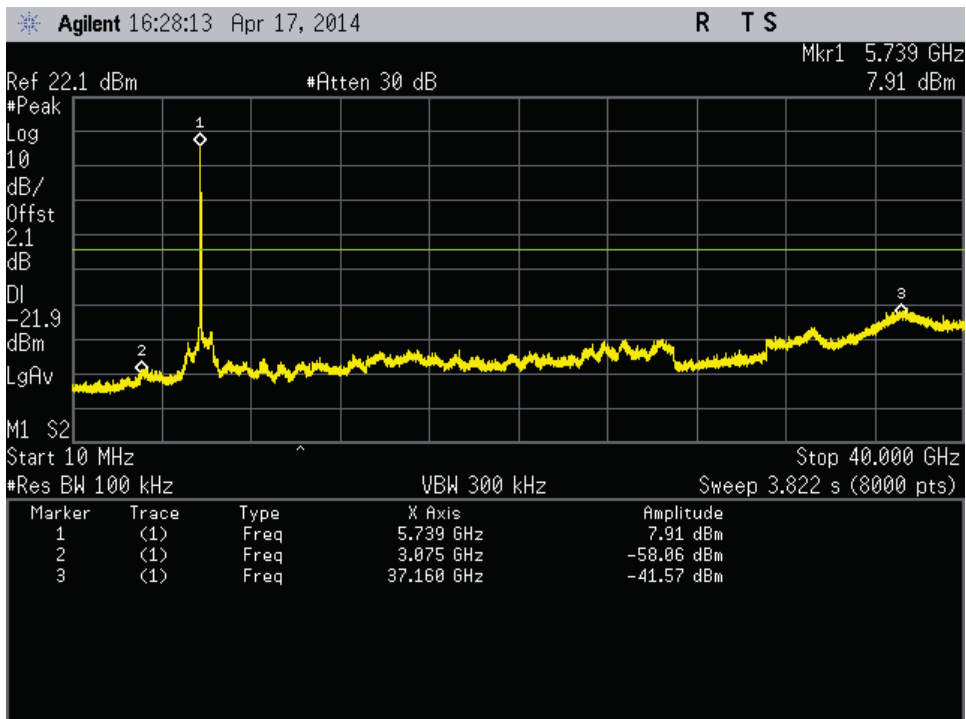

Figure 234: Out of Band Emission-802.11ac VHT20-5745 MHz-MCS0-Ch0



1279 Quarry Lane, Ste. A, Pleasanton, CA 95466  
 Tel: (925) 249-9123, Fax: (925) 249-9124

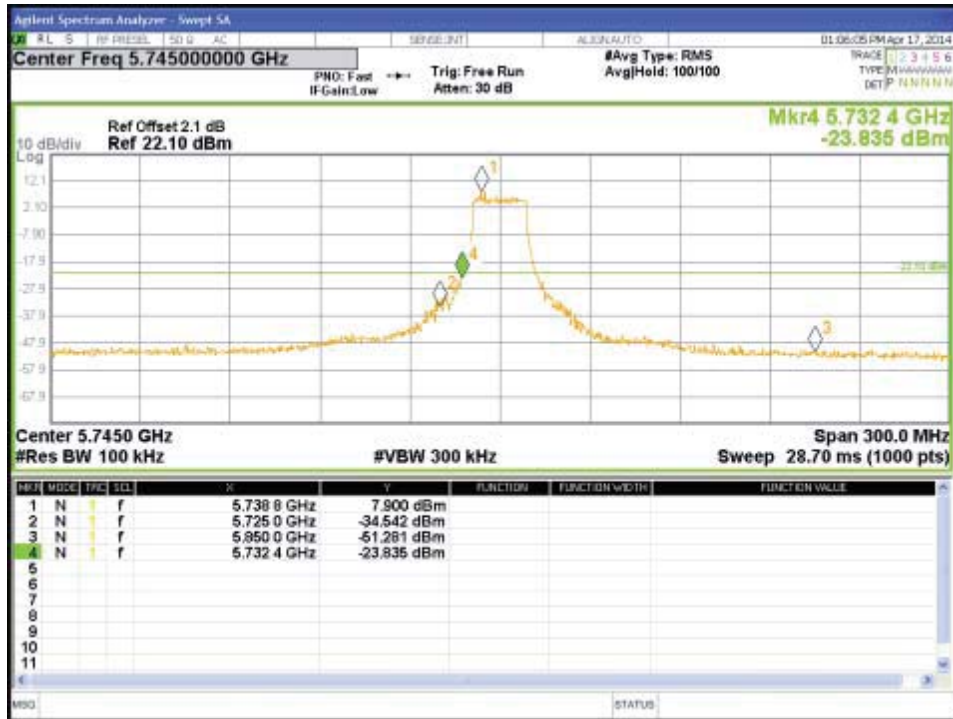

Figure 235: Conducted Band Edge-5745MHz-VHT20-MCS0-Ch1

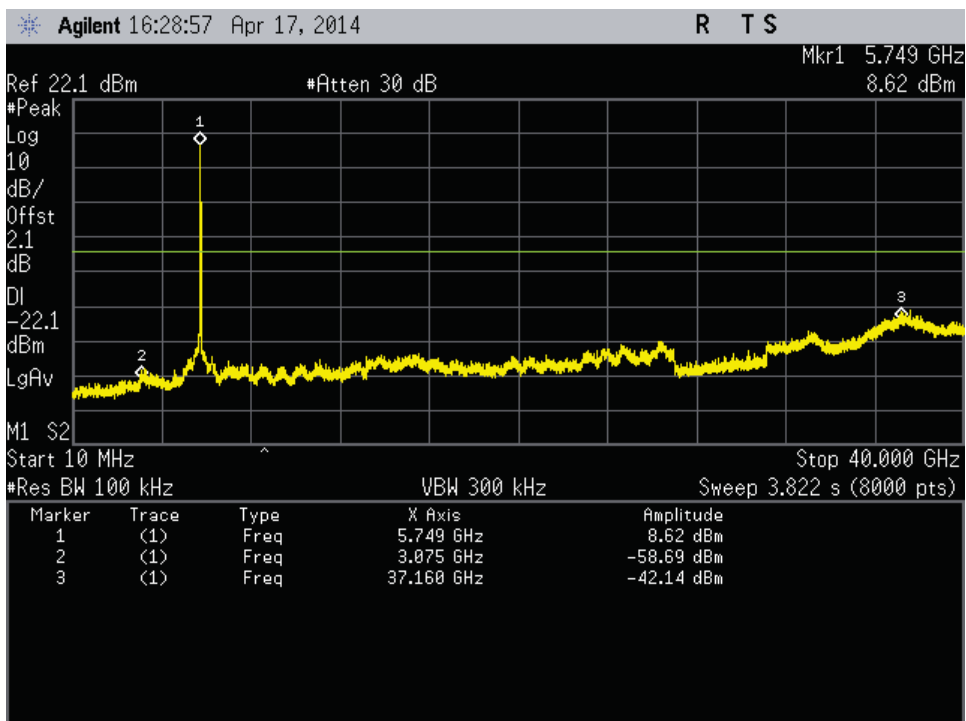

Figure 236: Out of Band Emission-802.11ac VHT20-5745 MHz-MCS0-Ch1

1279 Quarry Lane, Ste. A, Pleasanton, CA 95466  
 Tel: (925) 249-9123, Fax: (925) 249-9124

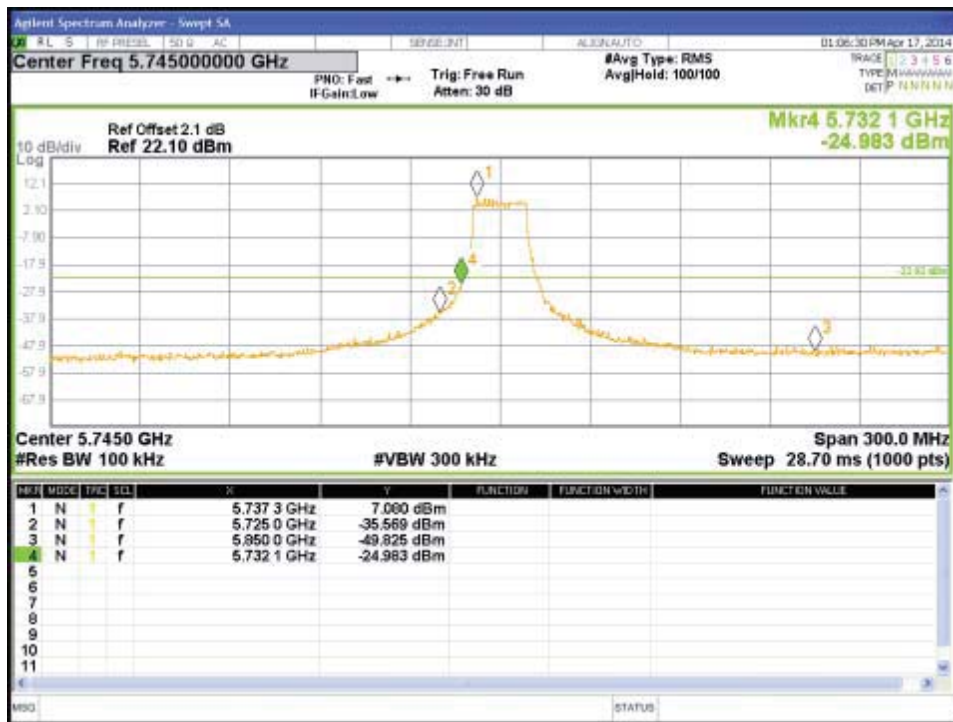

Figure 237: Conducted Band Edge-5745MHz-VHT20-MCS0-Ch2

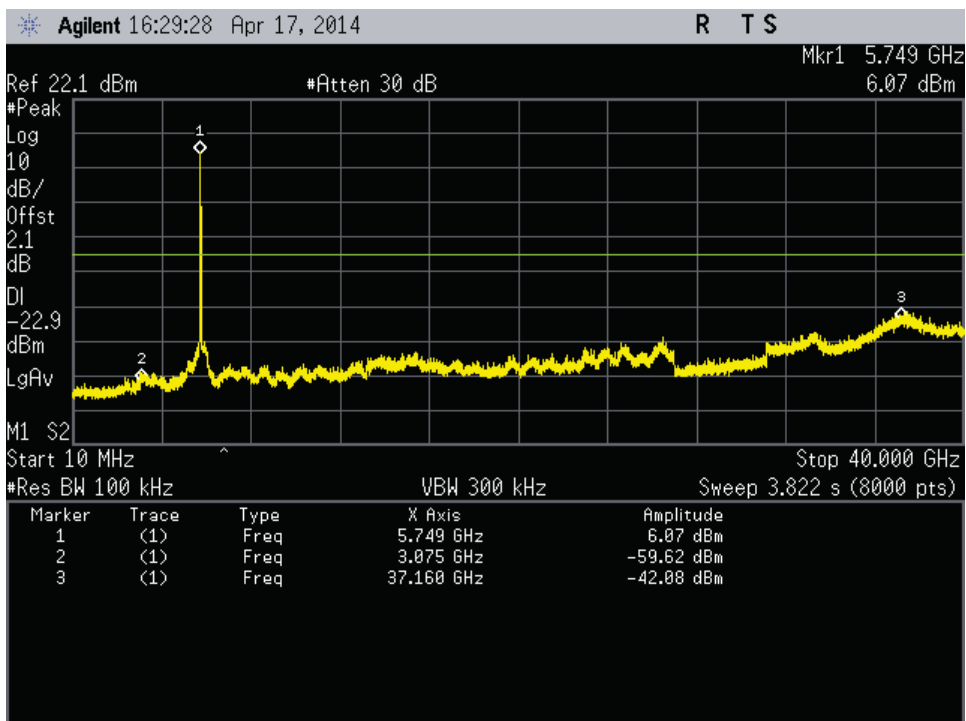

Figure 238: Out of Band Emission-802.11ac VHT20-5745 MHz-MCS0-Ch2

1279 Quarry Lane, Ste. A, Pleasanton, CA 95466  
 Tel: (925) 249-9123, Fax: (925) 249-9124

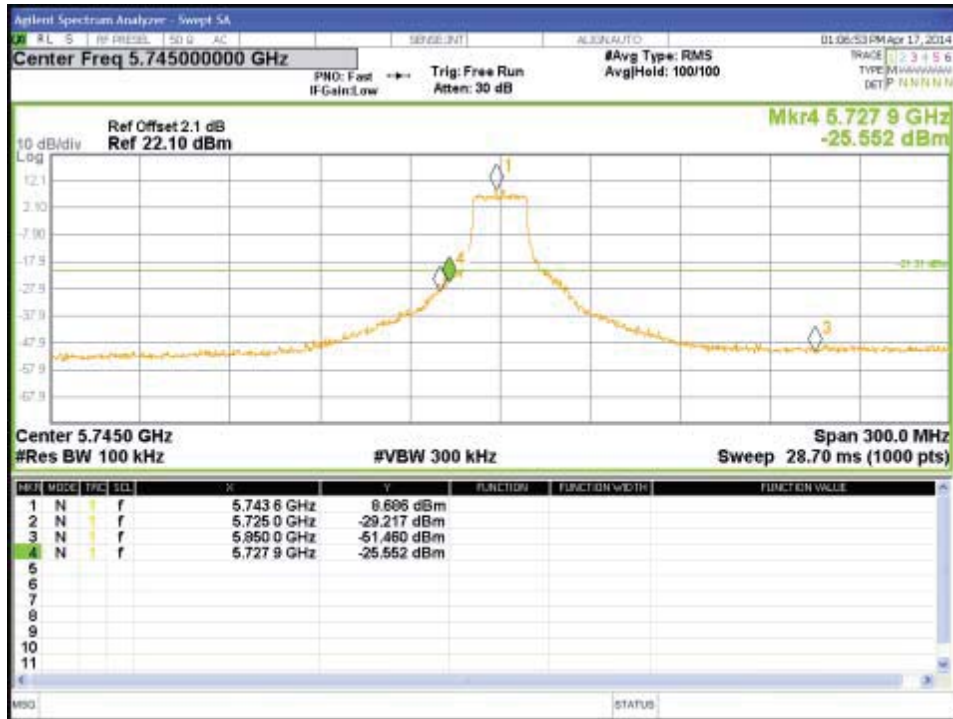

Figure 239: Conducted Band Edge-5745MHz-VHT20-MCS0-Ch3

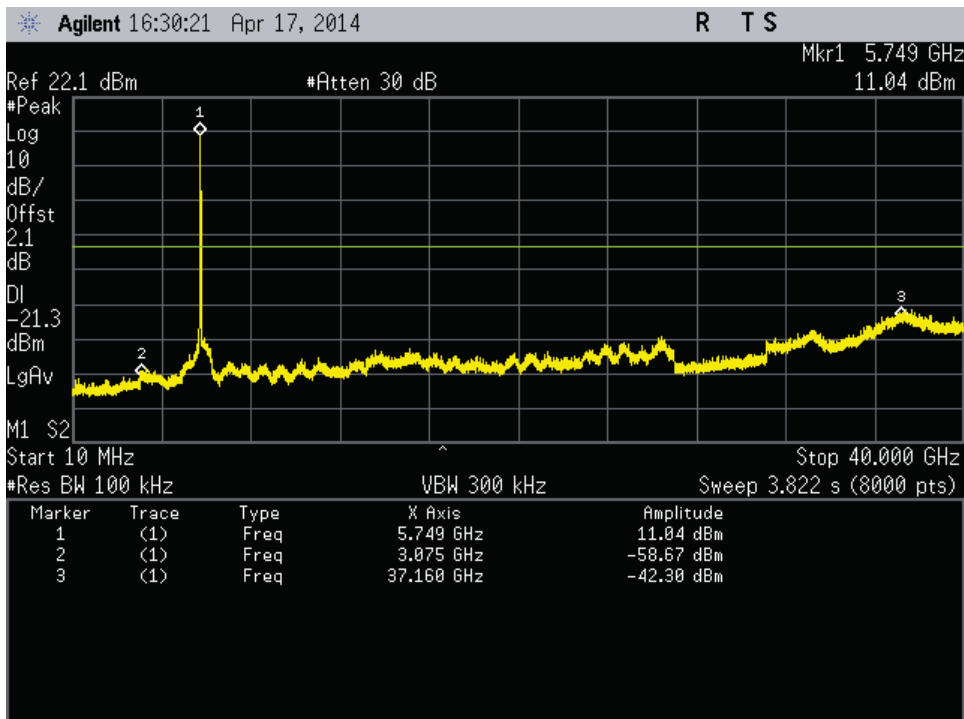

Figure 240: Out of Band Emission-802.11ac VHT20-5745 MHz-MCS0-Ch3

1279 Quarry Lane, Ste. A, Pleasanton, CA 95466  
 Tel: (925) 249-9123, Fax: (925) 249-9124



Figure 241: Conducted Band Edge-5785MHz-VHT20-MCS0-Ch0

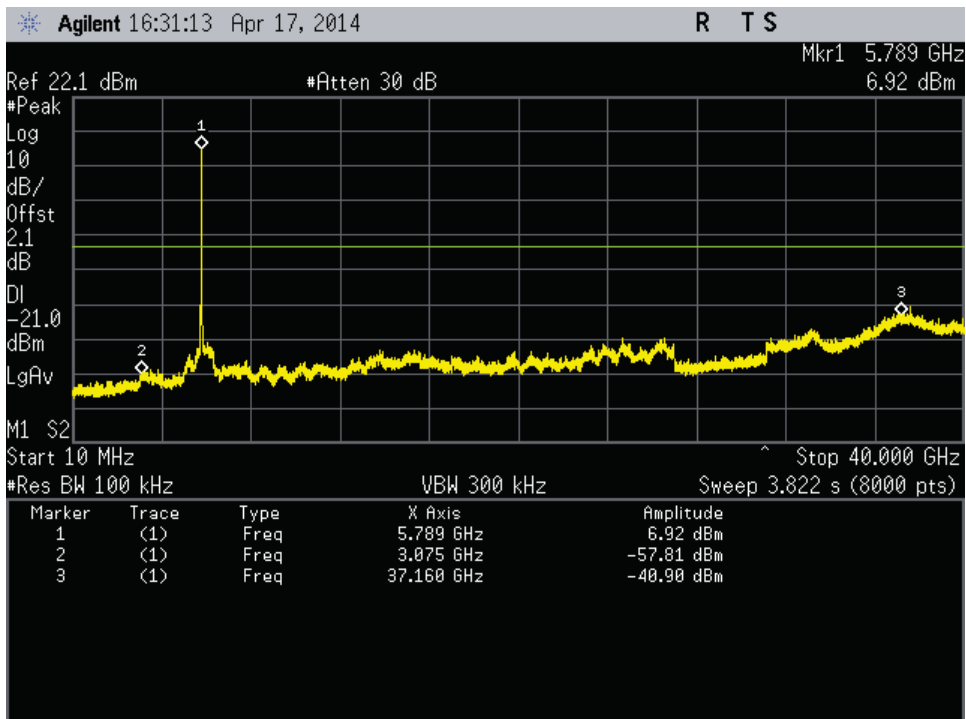

Figure 242: Out of Band Emission-802.11ac VHT20-5785 MHz-MCS0-Ch0

1279 Quarry Lane, Ste. A, Pleasanton, CA 95466  
 Tel: (925) 249-9123, Fax: (925) 249-9124

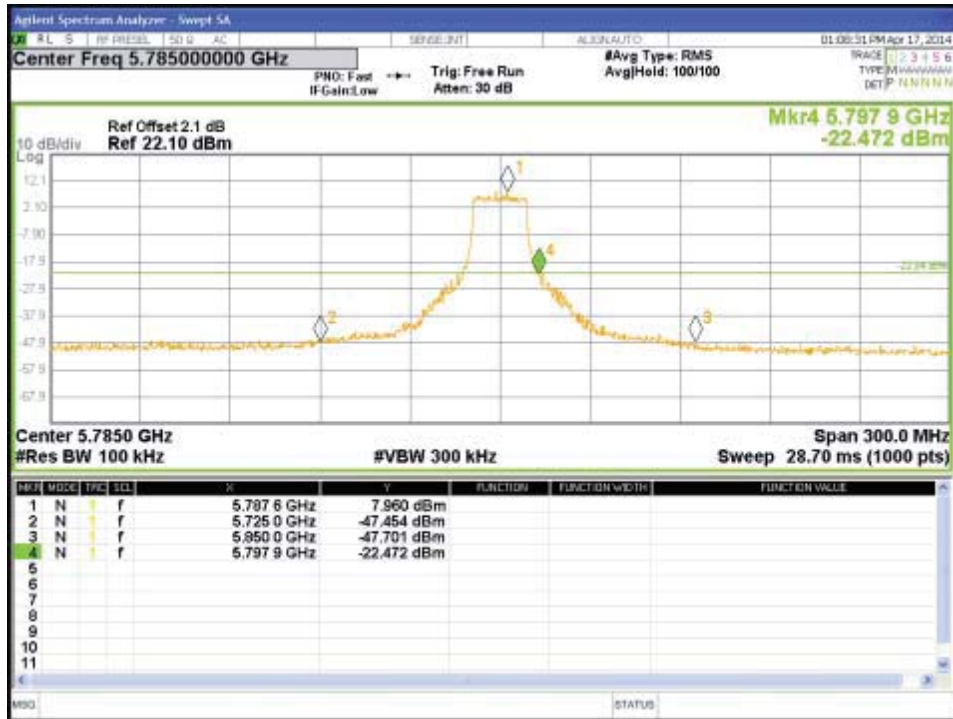

Figure 243: Conducted Band Edge-5785MHz-VHT20-MCS0-Ch1

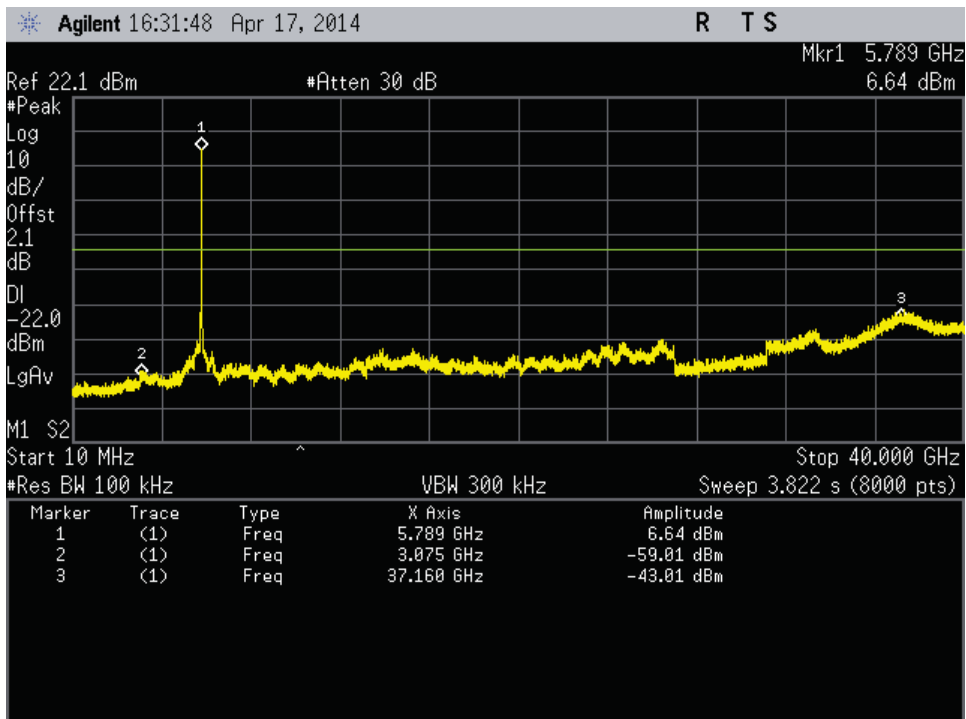

Figure 244: Out of Band Emission-802.11ac VHT20-5785 MHz-MCS0-Ch1

1279 Quarry Lane, Ste. A, Pleasanton, CA 95466  
 Tel: (925) 249-9123, Fax: (925) 249-9124

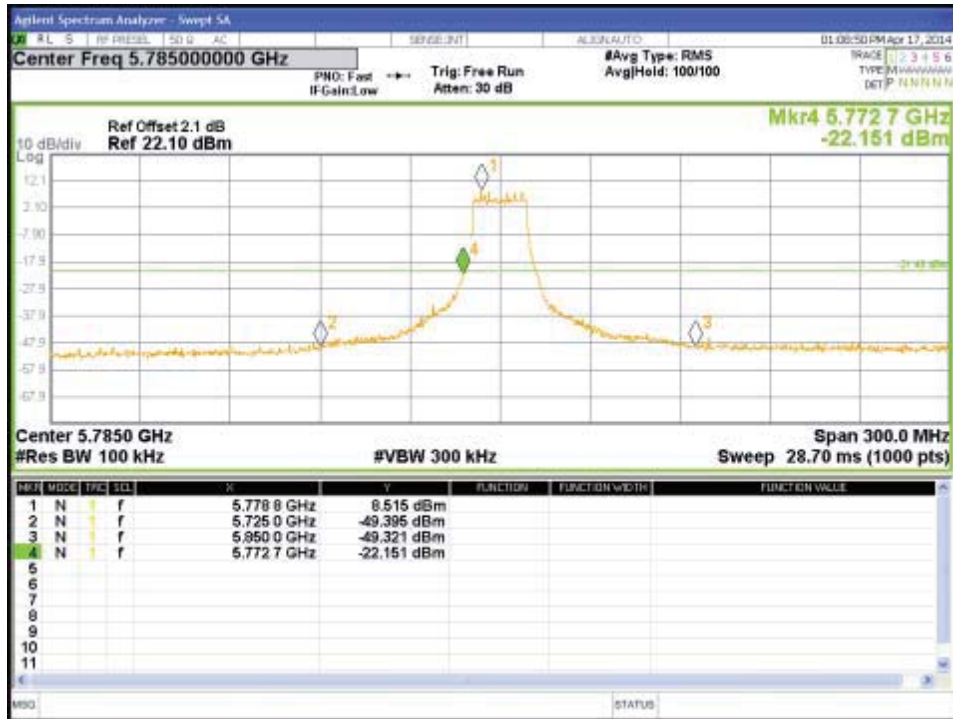

Figure 245: Conducted Band Edge-5785MHz-VHT20-MCS0-Ch2

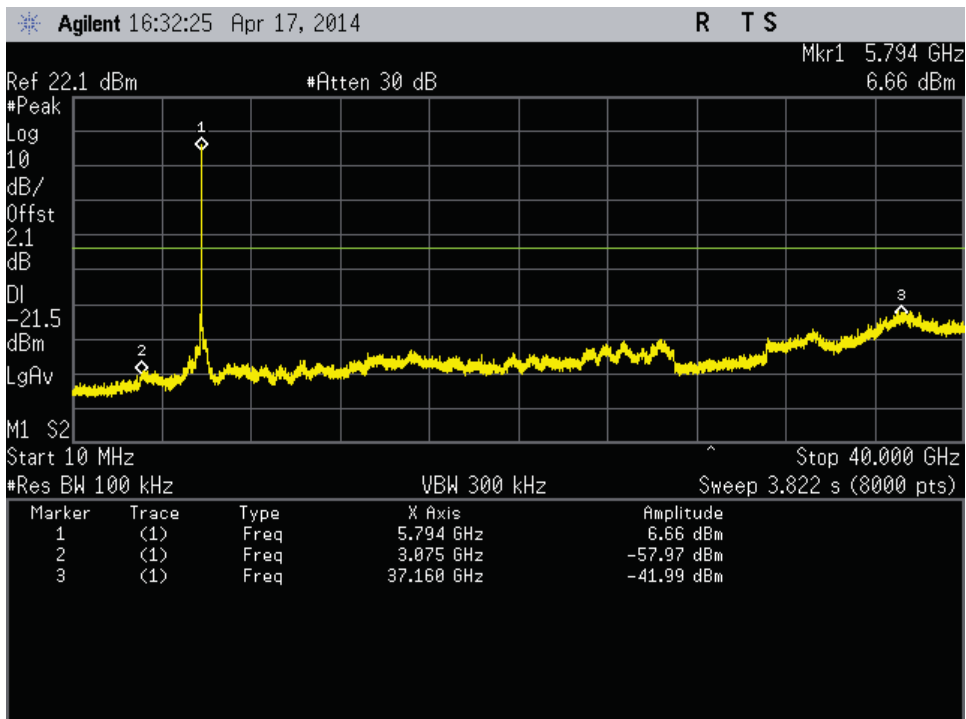

Figure 246: Out of Band Emission-802.11ac VHT20-5785 MHz-MCS0-Ch2