

Emissions Test Report

EUT Name: Wireless Video Access Point

Model No.: 405

CFR 47 Part 15.407 2012 and RSS 210: 2010

Prepared for:

Mark Rieger
Pace Americas
310 Providence Mine Road, Ste. 200
Nevada City, CA 95959
Tel: (530) 274 5440
Fax: (530) 273 6340

Prepared by:

TUV Rheinland of North America, Inc.
1279 Quarry Lane
Pleasanton, CA 94566
Tel: (925) 249-9123
Fax: (925) 249-9124
<http://www.tuv.com/>

Report/Issue Date: May 29, 2013
Job # 0000110737
Report Number: 31360999.001

Statement of Compliance

Manufacturer: Pace Americas
310 Providence Mine Road, Ste. 200
Nevada City, CA 95959
(530) 274 5440

Requester / Applicant: Mark Rieger

Name of Equipment: Wireless Video Access Point

Model No. 405

Type of Equipment: Intentional Radiator

Application of Regulations: CFR 47 Part 15.407 2012 and RSS 210: 2010

Test Dates: 8 April 2013 to 29 May 2013

Guidance Documents:

Emissions: ANSI C63.10-2009

Test Methods:

Emissions: ANSI C63.10-2009

The electromagnetic compatibility test and documented data described in this report has been performed and recorded by TUV Rheinland, in accordance with the standards and procedures listed herein. As the responsible authorized agent of the EMC laboratory, I hereby declare that the equipment described above has been shown to be compliant with the EMC requirements of the stated regulations and standards based on these results. If any special accessories and/or modifications were required for compliance, they are listed in the Executive Summary of this report.

This report must not be used to claim product endorsement by A2LA or any agency of the U.S. Government. This report contains data that are not covered by A2LA accreditation. This report shall not be reproduced except in full, without the written authorization of TUV Rheinland of North America.



Jeremy Luong

Test Engineer

Date May 29, 2013

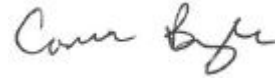

Conan Boyle

A2LA Signatory

Date May 29, 2013



Testing Cert #3331.02



US5254



Industry Canada
Industrie Canada

2932M-1

Table of Contents

1	Executive Summary	7
1.1	Scope	7
1.2	Purpose	7
1.3	Summary of Test Results	8
1.4	Special Accessories	8
1.5	Equipment Modifications	8
2	Laboratory Information	9
2.1	Accreditations & Endorsements	9
2.1.1	US Federal Communications Commission	9
2.1.2	NIST / A2LA	9
2.1.3	Canada – Industry Canada	9
2.1.4	Japan – VCCI	9
2.1.5	Acceptance by Mutual Recognition Arrangement	10
2.2	Test Facilities	10
2.2.1	Emission Test Facility	10
2.2.2	Immunity Test Facility	10
2.3	Measurement Uncertainty	10
2.3.1	Sample Calculation – radiated & conducted emissions	11
2.3.2	Measurement Uncertainty	11
2.3.1	Measurement Uncertainty Immunity	12
2.4	Calibration Traceability	12
3	Product Information	13
3.1	Product Description	13
3.2	Equipment Configuration	13
3.3	Operating Mode	13
3.4	Unique Antenna Connector	14
3.4.1	Results	14
4	Emissions	15
4.1	Output Power Requirements	15
4.1.1	Test Method	15
4.1.2	Results	16
4.2	Occupied Bandwidth	38
4.2.1	Test Method	38
4.2.2	Results	39
4.3	Peak Excursion	60
4.3.1	Test Method	60
4.3.2	Results	61
4.4	Peak Power Spectral Density	82
4.4.1	Test Method	82
4.4.2	Results	82

Table of Contents

4.5	Transmitter Spurious Emissions	107
4.5.1	Test Methodology	107
4.5.2	Transmitter Spurious Emission Limit	108
4.5.3	Test Results	108
4.5.4	Sample Calculation	140
4.6	AC Conducted Emissions	141
4.6.1	Test Methodology	141
4.6.2	Test Results	141
4.7	Frequency Stability	146
4.7.1	Test Methodology	146
4.7.2	Manufacturer Declaration	146
4.7.3	Limit	147
4.7.4	Test results	147
4.8	Voltage Variation	149
4.8.1	Test Methodology	149
4.8.2	Test results	149
4.9	Maximum Permissible Exposure	151
4.9.1	Test Methodology	151
4.9.2	RF Exposure Limit	151
4.9.3	EUT Operating Condition	152
4.9.4	Classification	152
4.9.5	Test Results	152
4.9.6	Sample Calculation	152
5	Test Equipment List	153
5.1	Equipment List	153
6	EMC Test Plan	154
6.1	Introduction	154
6.2	Customer	154
6.3	Equipment Under Test (EUT)	155
6.4	Test Specifications	160

Index of Tables

Table 1: Summary of Test Results 8

Table 2: RF Output Power at the Antenna Port – Test Results 16

Table 3: Average Output Power at the Antenna Port – Reference Only 17

Table 4: Occupied Bandwidth – Test Results 39

Table 5: Peak Excursion – Test Results 61

Table 6: Peak Power Spectral Density – Test Results 83

Table 7: Transmit Spurious Emission at Band-Edge Requirements 109

Table 8: AC Conducted Emissions – Test Results 141

Table 9: Frequency Stability – Test Results 147

Table 10: Voltage Variation – Test Results 149

Table 11: Customer Information 154

Table 12: Technical Contact Information 154

Table 13: EUT Specifications 155

Table 14: EUT Channel Power Specifications 157

Table 15: Interface Specifications 157

Table 16: Supported Equipment 158

Table 17: Description of Sample used for Testing 158

Table 18: Description of Test Configuration used for Radiated Measurement. 158

Table 19: Final Test Mode for 5150 - 5250 Bands 158

Table 20: Test Specifications 160

1 Executive Summary

1.1 Scope

This report is intended to document the status of conformance with the requirements of the CFR 47 Part 15.407 2012 and RSS 210: 2010 based on the results of testing performed on 8 April 2013 to 29 May 2013 on the Wireless Video Access Point Model 405 manufactured by Pace Americas This report only applies to the specific samples tested under the stated test conditions. It is the responsibility of the manufacturer to assure that additional production units of this model are manufactured with identical or EMI equivalent electrical and mechanical components. This report is further intended to document changes and modifications to the EUT throughout its life cycle. All documentation will be included as a supplement.

1.2 Purpose

Testing was performed to evaluate the EMC performance of the EUT in accordance with the applicable requirements, procedures, and criteria defined in the application of regulations and application of standards listed in this report. The 5150 MHz to 5250 MHz frequency band is covered in this document.

1.3 Summary of Test Results

Table 1: Summary of Test Results

Test	Test Method ANSI C63.4	Test Parameters (from Standard)	Result
Spurious Emission in Transmitted Mode	CFR47 15.209, CFR47 15.407 (b) RSS-GEN Sect.7.2.3, RSS 210 Sect. A.9.2	Class B	Complied
Restricted Bands of Operation	CFR47 15.205, RSS 210 Sect.2.6	Class B	Complied
AC Power Conducted Emission	CFR47 15.207, RSS-GEN Sect.7.2.2	Class B	Complied
Occupied Bandwidth	CFR47 15.407 (a), RSS GEN Sect.4.4.1	≥ 500 kHz	Complied
Maximum Output Power	CFR47 15.407 (a), RSS 210 Sect. A.9.2	Band 1: 16.97 dBm	Complied
Peak Power Spectral Density	CFR47 15.407 (a), RSS 210 Sect. A.9.2	Band 1: 4 dBm/MHz	Complied
Peak Excursion Ratio	CFR47 15.407 (a)(6)	< 13 dB	Complied
Conducted Emission – Antenna Port	CFR47 15.407 (b), RSS 210 Sect.6.2.2	30 MHz -40 GHz < 27 dBm/MHz	Complied
Frequency Stability	CFR47 15.407 (g), RSS GEN Sect. 4.7.	±20 ppm	Complied
RF Exposure	CFR47 15.247 (i), 2.1091	General Population	Complied

Note: This test report is covered for 5150 MHz to 5250 MHz.

1.4 Special Accessories

No special accessories were necessary in order to achieve compliance.

1.5 Equipment Modifications

None

2 Laboratory Information

2.1 Accreditations & Endorsements

2.1.1 US Federal Communications Commission



TUV Rheinland of North America at 1279 Quarry Ln, Pleasanton, CA 94566 is recognized by the commission for performing testing services for the general public on a fee basis. These laboratory test facilities have been fully described in reports submitted to and accepted by the FCC (US5254). The laboratory scope of accreditation includes: Title 47 CFR Parts 15, 18, and 90. The accreditation is updated every 3 years.

2.1.2 NIST / A2LA



TUV Rheinland of North America is accredited by the National Voluntary Laboratory Accreditation Program, which is administered under the auspices of the National Institute of Standards and Technology. The laboratory has been assessed and accredited in accordance with ISO Guide 17025:1999 and ISO 9002 (Lab Code Testing Cert #3331.02). The scope of laboratory accreditation includes emission and immunity testing. The accreditation is updated annually.

2.1.3 Canada – Industry Canada



TUV Rheinland of North America at the 1279 Quarry Ln, Pleasanton, CA 94566 address is accredited by Industry Canada for performing testing services for the general public on a fee basis. This laboratory test facilities have been fully described in reports submitted to and accepted by Industry Canada (File Number 2932M). This reference number is the indication to the Industry Canada Certification Officers that the site meets the requirements of RSS 212, Issue 1 (Provisional). The accreditation is updated every 3 years.

2.1.4 Japan – VCCI



The Voluntary Control Council for Interference by Information Technology Equipment (VCCI) is a group that consists of Information Technology Equipment (ITE) manufacturers and EMC test laboratories. The purpose of the Council is to take voluntary control measures against electromagnetic interference from Information Technology Equipment, and thereby contribute to the development of a socially beneficial and responsible state of affairs in the realm of Information Technology Equipment in Japan. TUV Rheinland of North America at 1279 Quarry Ln, Pleasanton, CA 94566 has been assessed and approved in accordance with the Regulations for Voluntary Control Measures.

VCCI Registration No. for Pleasanton: A-0031

VCCI Registration No. for Santa Clara: A-0032

2.1.5 Acceptance by Mutual Recognition Arrangement



The United States has an established agreement with specific countries under the Asia Pacific Laboratory Accreditation Corporation (APLAC) Mutual Recognition Arrangement. Under this agreement, all TUV Rheinland at 1279 Quarry Ln, Pleasanton, CA 94566 test results and test reports within the scope of the laboratory NIST / A2LA accreditation will be accepted by each member country.

2.2 Test Facilities

All of the test facilities are located at 1279 Quarry Lane, Pleasanton, California 94566, USA. The 2305 Mission College, Santa Clara, 95054, USA location is considered a Pleasanton annex.

2.2.1 Emission Test Facility

The Semi-Anechoic chamber and AC Line Conducted measurement facility used to collect the radiated and conducted data has been constructed in accordance with ANSI C63.7:1992. The site has been measured in accordance with and verified to comply with the theoretical normalized site attenuation requirements of ANSI C63.4-2009, at a test distance of 3 and 5 meters. The site is listed with the FCC and accredited by A2LA (Lab Code Testing Cert #3331.02). The 3/5-meter semi-anechoic chamber used to collect the radiated data has been verified to comply with the theoretical normalized site attenuation requirements of ANSI C63.4-2009, at a test distance of 3 meter and 5 meters. A report detailing this site can be obtained from TUV Rheinland of North America.

2.2.2 Immunity Test Facility

ESD, EFT, Surge, PQF: These tests are performed in an environmentally controlled room with a 3.7 m x 4.8 m x 3.175 mm thick aluminum floor connected to PE ground.

For ESD testing, tabletop equipment is placed on an insulated mat with a surface resistivity of 10^9 Ohms/square on a 1.6 m x 0.8 m x 0.8 m high non-conductive table with a 3.175 mm aluminum top (Horizontal Coupling Plane). The HCP is connected to the main ground plane via a low impedance ground strap through two 470-k Ω resistors. The Vertical Coupling Plane consists of an aluminum plate 50 cm x 50 cm x 3.175 mm thick. The VCP is connected to the main ground plane via a low impedance ground strap through two 470-k Ω resistors.

For EFT, Surge, PQF, the HCP and VCP are removed.

RF Field Immunity testing is performed in a 7.3m x 4.3m x 4.1m anechoic chamber.

RF Conducted and Magnetic Field Immunity testing is performed on a 4.8m x 3.7m x 3.175mm thick aluminum ground plane.

All test areas allow a minimum distance of 1 meter from the EUT to walls or conducting objects.

2.3 Measurement Uncertainty

Two types of measurement uncertainty are expressed in this report, per *ISO Guide To The Expression Of Uncertainty In Measurement*, 1st Edition, 1995.

The *Combined Standard Uncertainty* is the standard uncertainty of the result of a measurement when that result is obtained from the values of a number of other quantities; it is equal to the positive square root of the sum of the variances or co-variances of these other quantities, weighted according to how the measurement result varies with changes in these quantities. The term *standard uncertainty* is the result of a measurement expressed as a standard deviation.

2.3.1 Sample Calculation – radiated & conducted emissions

The field strength is calculated by subtracting the Amplifier Gain and adding the Cable Loss and Antenna Correction Factor to the measured reading. The basic equation is as follows:

$$\text{Field Strength (dB}\mu\text{V/m)} = \text{RAW} - \text{AMP} + \text{CBL} + \text{ACF}$$

Where: RAW = Measured level before correction (dBμV)

AMP = Amplifier Gain (dB)

CBL = Cable Loss (dB)

ACF = Antenna Correction Factor (dB/m)

$$\mu\text{V/m} = 10^{\frac{\text{dB}\mu\text{V} / \text{m}}{20}}$$

Sample radiated emissions calculation @ 30 MHz

Measurement +Antenna Factor–Amplifier Gain+Cable loss=Radiated Emissions (dBuV/m)

$$25 \text{ dBuV/m} + 17.5 \text{ dB} - 20 \text{ dB} + 1.0 \text{ dB} = 23.5 \text{ dBuV/m}$$

2.3.2 Measurement Uncertainty

Per CISPR 16-4-2	U _{lab}	U _{cispr}
Radiated Disturbance @ 10 meters		
30 – 1,000 MHz	2.25 dB	4.51 dB
Radiated Disturbance @ 3 meters		
30 – 1,000 MHz	2.26 dB	4.52 dB
1 – 6 GHz	2.12 dB	4.25 dB
6 – 18 GHz	2.47 dB	4.93 dB
Conducted Disturbance @ Mains Terminals		
150 kHz – 30 MHz	1.09 dB	2.18 dB
Disturbance Power		
30 MHz – 300 MHz	3.92 dB	4.3 dB

Voltech PM6000A

The estimated combined standard uncertainty for harmonic current and flicker measurements is $\pm 5.0\%$.	Per CISPR 16-4-2 Methods
--	--------------------------

2.3.1 Measurement Uncertainty Immunity

The estimated combined standard uncertainty for ESD immunity measurements is $\pm 8.2\%$.	Per IEC 61000-4-2
The estimated combined standard uncertainty for radiated immunity measurements is ± 4.10 dB.	Per IEC 61000-4-3
The estimated combined standard uncertainty for conducted immunity measurements with CDN is ± 3.66 dB	Per IEC 61000-4-6
The estimated combined standard uncertainty for power frequency magnetic field immunity is $\pm 2.9\%$.	Per IEC 61000-4-8

Thermo KeyTek EMC Pro

The estimated combined standard uncertainty for EFT fast transient immunity measurements is $\pm 2.6\%$.
The estimated combined standard uncertainty for surge immunity measurements is $\pm 2.6\%$.
The estimated combined standard uncertainty for voltage variation and interruption measurements is $\pm 1.74\%$.

The expanded uncertainty at a level of 95% confidence is obtained by multiplying the combined standard uncertainty by a coverage factor of 2. Compliance criteria are not based on measurement uncertainty.

2.4 Calibration Traceability

All measurement instrumentation is traceable to the National Institute of Standards and Technology (NIST). Measurement method complies with ANSI/NCSL Z540-1-1994 and ISO Standard 17025:2005. Equipment calibration records are kept on file at the test facility.

3 Product Information

3.1 Product Description

The Pace 405 wireless video access point allows service providers to securely deliver high quality HD video to any location in a subscriber home. Using state of the art wireless technology including digital beam forming, customers retain traditional “wired” levels of service and quality while service providers enjoy the benefits of shortened installation times and more flexibility in how they deploy their IPTV or OTT services

Key Feature:

- 5GHz 802.11n wireless access point
- 4x4 MIMO (up to 600Mbps phy rate)
- High-Power Transmit For Maximum Coverage
- Gigabit Ethernet port
- Robust quality of service (QoS) and traffic management features
- Simple, push-button wireless setup for wireless set-tops
- TR-069 Management Client
- LEDs: Power, Wireless Signal Quality, Operational Mode (AP/STA), Ethernet Link, Wireless Pairing Indicator

3.2 Equipment Configuration

A description of the equipment configuration is given in the Test Plan Section. The EUT was tested as called for in the test standard and was configured and operated in a manner consistent with its intended use. The EUT was connected to rated power and allowed to reach intended operating conditions. The placement of the EUT system components was guided by the test standard and selected to represent typical installation conditions.

In the case of an EUT that can operate in more than one configuration, preliminary testing was performed to determine the configuration that produced maximum radiation.

The final configuration was selected to produce the worst case radiation for emissions testing and to place the EUT in the most susceptible state for immunity testing.

3.3 Operating Mode

A description of the operation mode is given in the Test Plan Section. In the case of an EUT that can operate in more than one state, preliminary testing was performed to determine the operating mode that produced maximum radiation.

The final operating mode was selected to produce the worst case radiation for emissions testing and to place the EUT in the most susceptible state for immunity testing.

3.4 Unique Antenna Connector

An intentional radiator shall be designed to ensure that no antenna other than that furnished by the responsible party shall be used with the device. The use of a permanently attached antenna or of an antenna that uses a unique coupling to the intentional radiator shall be considered sufficient to comply with the provisions of this Section. The manufacturer may design the unit so that a broken antenna can be replaced by the user, but the use of a standard antenna jack or electrical connector is prohibited. This requirement does not apply to carrier current devices or to devices operated under the provisions of CFR47 Parts 15.211, 15.213, 15.217, 15.219, or 15.221.

3.4.1 Results

The Wireless Video Access Point has 4 internal fixed antennas, 3 onboard PCB dipole antennas and 1 stamped metal loop antenna. Each antenna has the maximum gain of 2dBi. The total directional gain is 8dBi. All antennas are integrated on the PCB. There is no external antenna connection available.

4 Emissions

Testing was performed in accordance with CFR 47 Part 15.407: 2012 and RSS 210 Annex 9: 2010. These test methods are listed under the laboratory's A2LA Scope of Accreditation. This test measures the levels emanating from the EUT, thus evaluating the potential for the EUT to cause radio frequency interference to other electronic devices. Procedures described in section 8 of the standard were used.

4.1 Output Power Requirements

The maximum output power requirement is the maximum equivalent isotropic radiated power delivering at the transmitting antenna under specified conditions of measurements in the presence of modulation.

The maximum output power and harmonics shall not exceed CFR47 Part 15.407 (a):2012 and RSS 210 A9.2: 2010.

The maximum transmitted powers are

Band 5150-5250 MHz: 50 mW or 4 dBm + 10Log B.

Band 5250-5350 MHz, 5470-5725 MHz: 250 mW or 11 dBm + 10Log B.

Band 5725-5825 MHz: 1 W or 17 dBm + 10Log B. Where B is 26 dB Bandwidth.

4.1.1 Test Method

The ANSI C63.10-2009 Section 6.10.3.1 conducted method was used to measure the channel power output. The preliminary investigation was performed at different data rate/ chain to determine the highest power output for each mode. The worst findings were conducted on 3 channels in each operating range per CFR47 Part 15.407(a): 2012 and RSS 210 A.9.2; 5150 MHz to 5250 MHz. The worst mode results indicated below.

Test Setup:

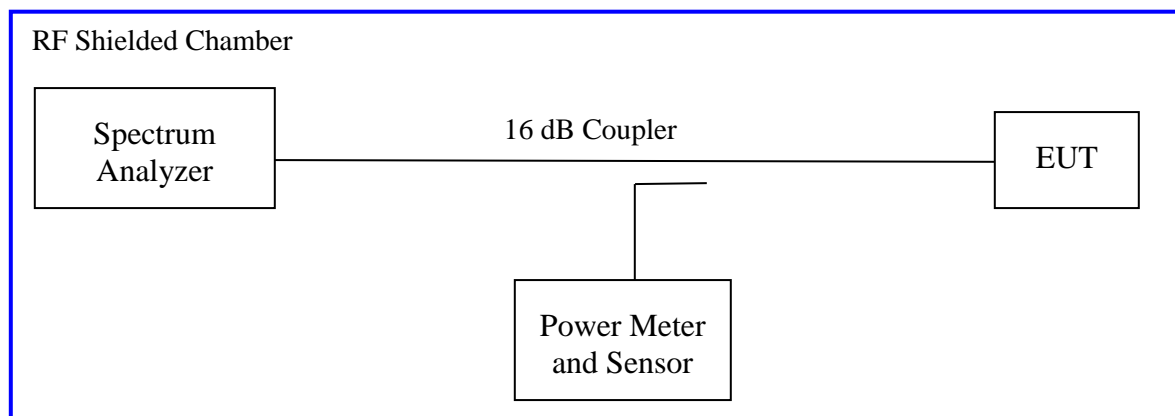

Method SA-1 of "Guidelines for Compliance Testing of Unlicensed National Information Infrastructure (U-NII) Devices" applies since the EUT continuously transmit; where duty cycle is greater than 98%. Sample detector was used.

Each chain was measured individually and applied the measure-and-sum approach per KDB66291.

4.1.2 Results

As originally tested, the EUT was found to be compliant to the requirements of the test standard(s).

Table 2: RF Output Power at the Antenna Port – Test Results

Test Conditions: Conducted Measurement, Normal Temperature							
Antenna Type: Integrated				Power Setting: See test plan			
Max. Directional Gain: + 8 dBi				Signal State: Modulated at 100%.			
Ambient Temp.: 23° C				Relative Humidity: 33%			
802.11n (HT20) Mode, 4x4							
Operating Channel	Limit [dBm]	Ch0 [dBm]	Ch1 [dBm]	Ch2 [dBm]	Ch3 [dBm]	Total Power [dBm]	Margin [dB]
5180	14.97	6.19	8.04	6.78	7.05	13.09	-1.88
5200	14.97	4.43	6.90	5.63	5.65	11.76	-3.21
5240	14.97	4.51	6.73	5.24	5.65	11.63	-3.34
<p>Note: 1. The highest output power was observed at HT20 6.5 Mbps, 4 Data Streams. 2. All chains will be on at all time and beam performing. RF output powers were summed per KDB 662911. 3. The total directional gain would be 8dBi; 2dBi +10*Log(4). Per CFR47 Part 15.407 (a), the limit is reduced for every dBi gain exceeding 6dBi. The limit would be 14.97 dBm.</p>							
802.11n (HT40) Mode, 4x4							
Operating Channel	Limit [dBm]	Ch0 [dBm]	Ch1 [dBm]	Ch2 [dBm]	Ch3 [dBm]	Total Power [dBm]	Margin [dB]
5190	14.97	8.13	9.80	8.63	7.94	14.71	-0.26
5230	14.97	7.69	9.83	8.43	9.15	14.87	-0.10
<p>Note: 1. The highest output power was observed at HT40 13.5 Mbps, 4 Data Streams. 2. All chains will be on at all time and beam performing. RF output powers were summed per KDB 662911. 3. The total directional gain would be 8dBi; 2dBi +10*Log(4). Per CFR47 Part 15.407 (a), the limit is reduced for every dBi gain exceeding 6dBi. The limit would be 14.97 dBm</p>							

Table 3: Average Output Power at the Antenna Port – Reference Only

Test Conditions: Conducted Measurement, Normal Temperature							
Antenna Type: Integrated				Power Setting: See test plan			
Max. Directional Gain: + 8 dBi				Signal State: Modulated at 100%.			
Ambient Temp.: 23 °C				Relative Humidity: 33%			
802.11n (HT20) Mode, 4x4							
Operating Channel	Limit [dBm]	Ch0 [dBm]	Ch1 [dBm]	Ch2 [dBm]	Ch3 [dBm]	Total Power [dBm]	Margin [dB]
5180		6.83	8.68	7.44	7.75	13.75	
5200		5.14	7.53	6.28	6.31	12.42	
5240		4.91	7.18	5.66	6.07	12.06	
Note: The highest output power was observed at HT20 6.5 Mbps, 4 Data Streams.							
802.11n (HT40) Mode, 4x4							
Operating Channel	Limit [dBm]	Ch0 [dBm]	Ch1 [dBm]	Ch2 [dBm]	Ch3 [dBm]	Total Power [dBm]	Margin [dB]
5190		8.47	10.13	8.94	8.30	15.04	
5230		7.78	9.94	8.56	9.31	14.99	
Note: The highest output power was observed at HT40 13.5 Mbps, 4 Data Streams.							

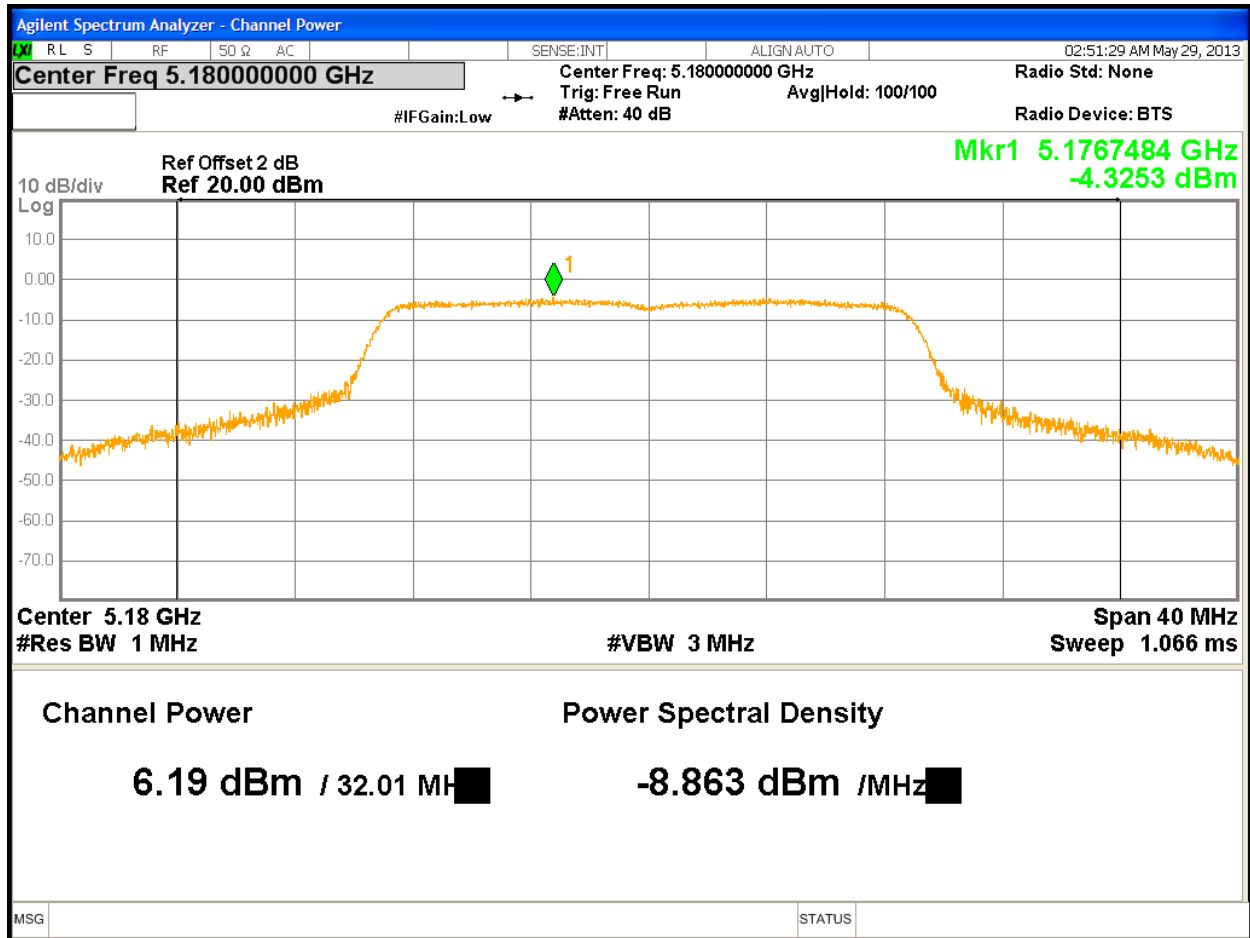

Figure 1: Maximum Transmitted Power, 5180 MHz at HT20, Chain 0

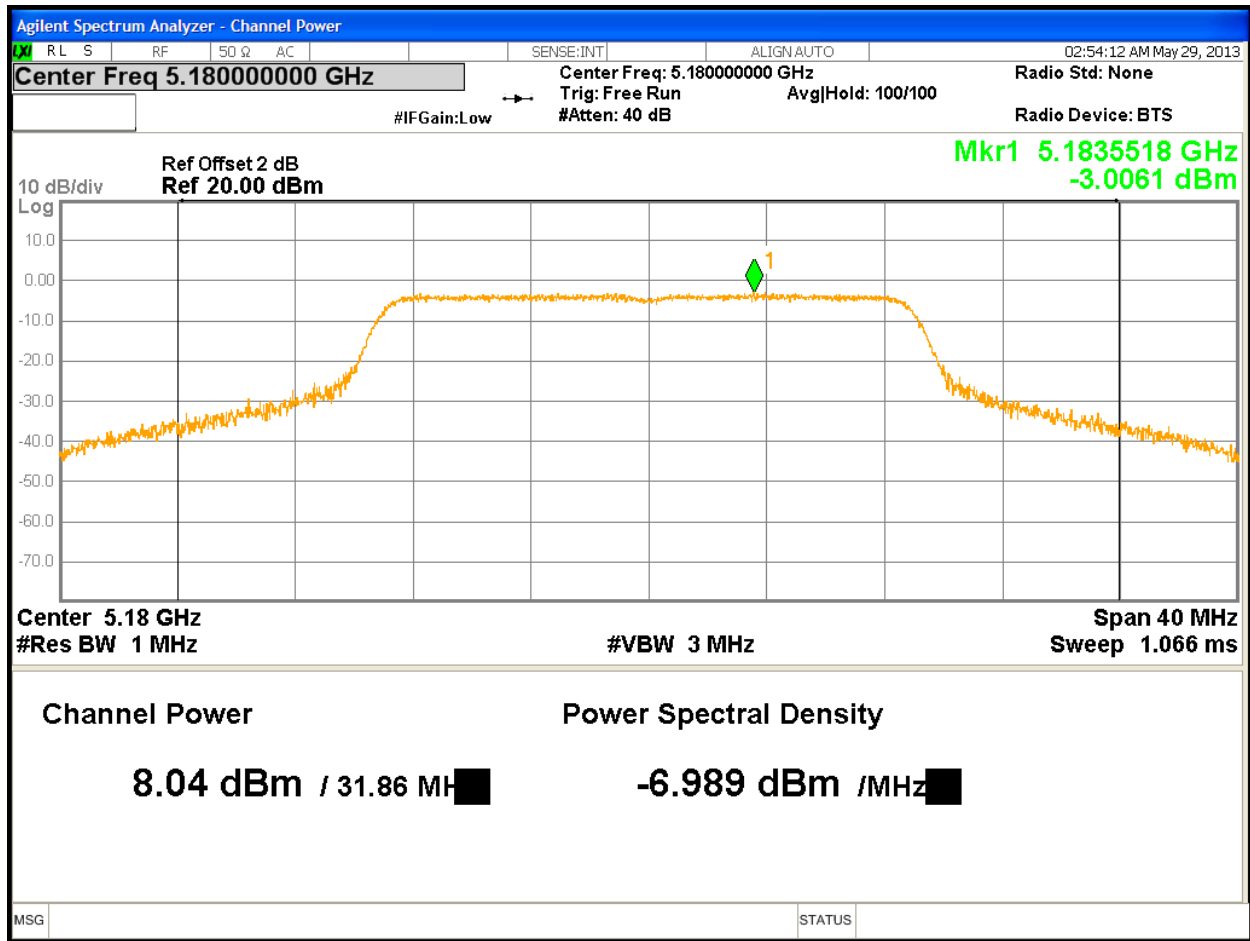

Figure 2: Maximum Transmitted Power, 5180 MHz at HT20, Chain 1

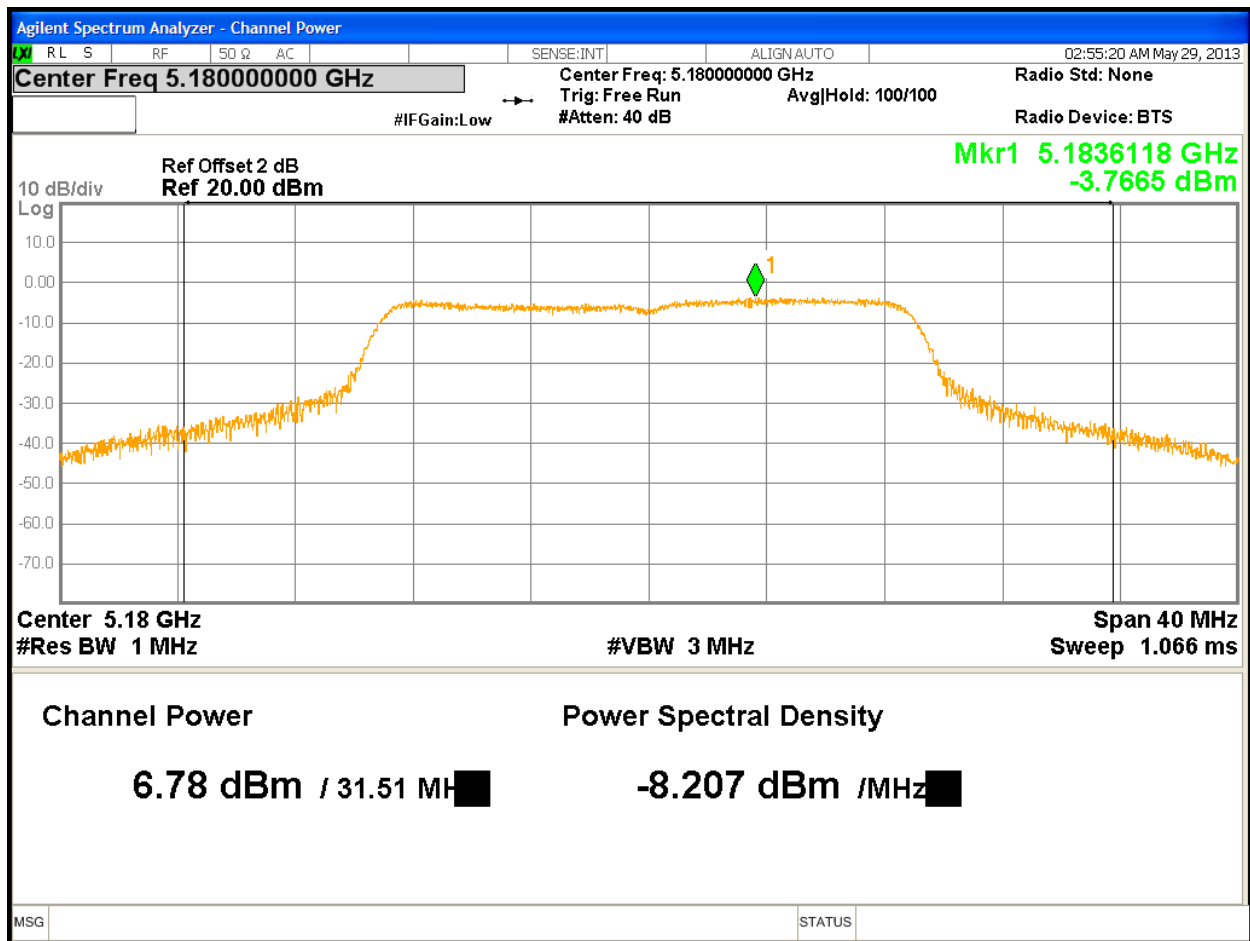

Figure 3: Maximum Transmitted Power, 5180 MHz at HT20, Chain 2

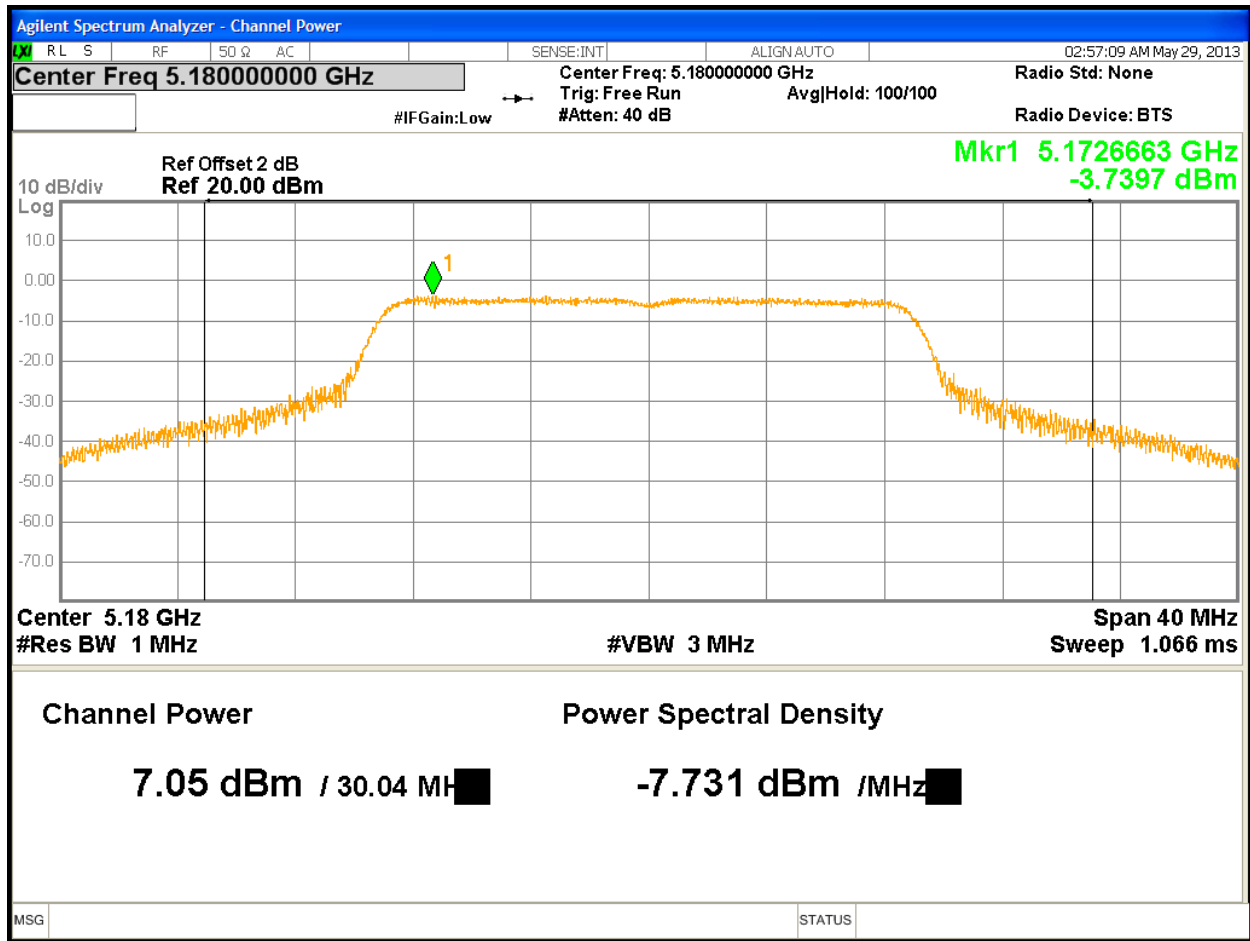

Figure 4: Maximum Transmitted Power, 5180 MHz at HT20, Chain 3

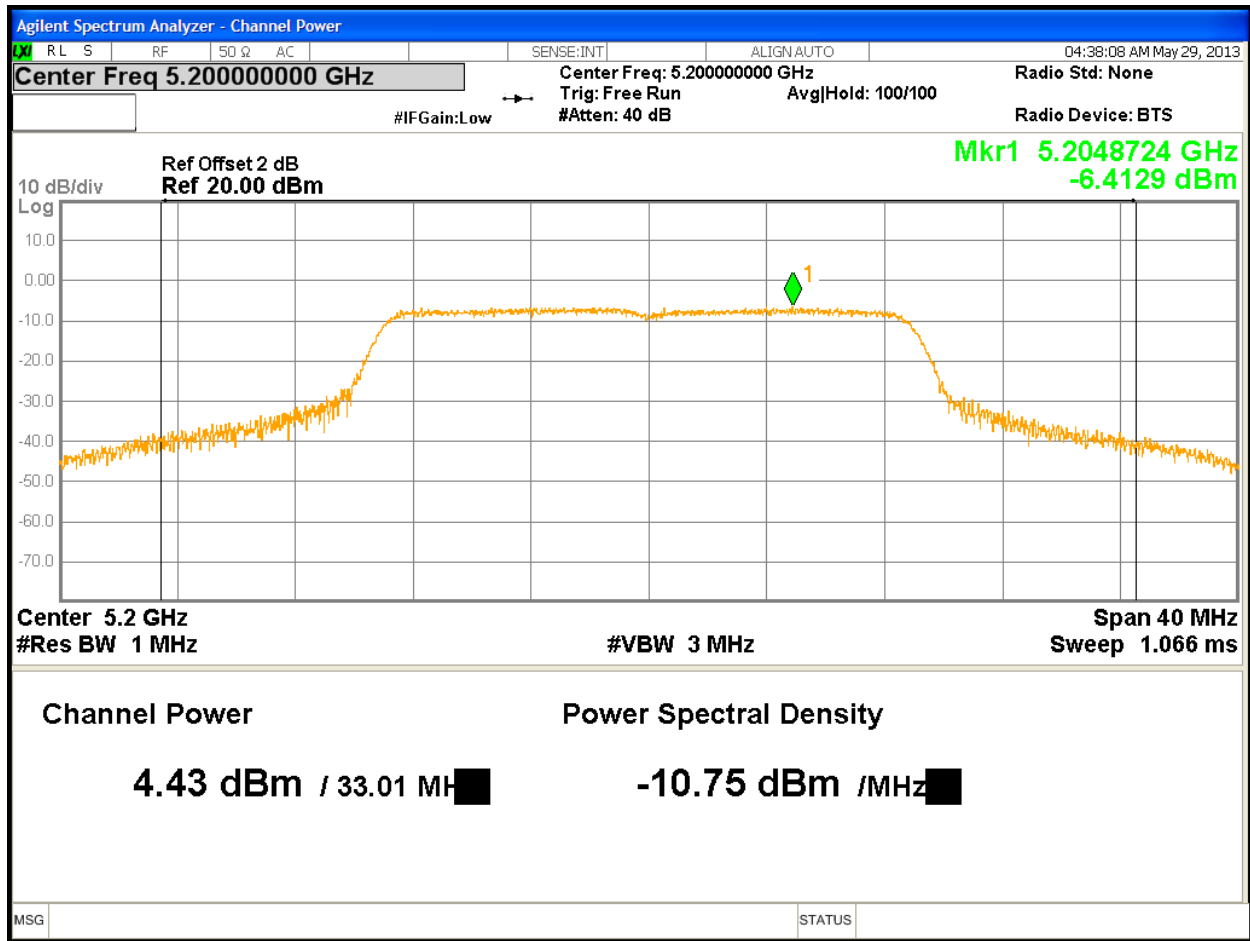

Figure 5: Maximum Transmitted Power, 5200 MHz at HT20, Chain 0

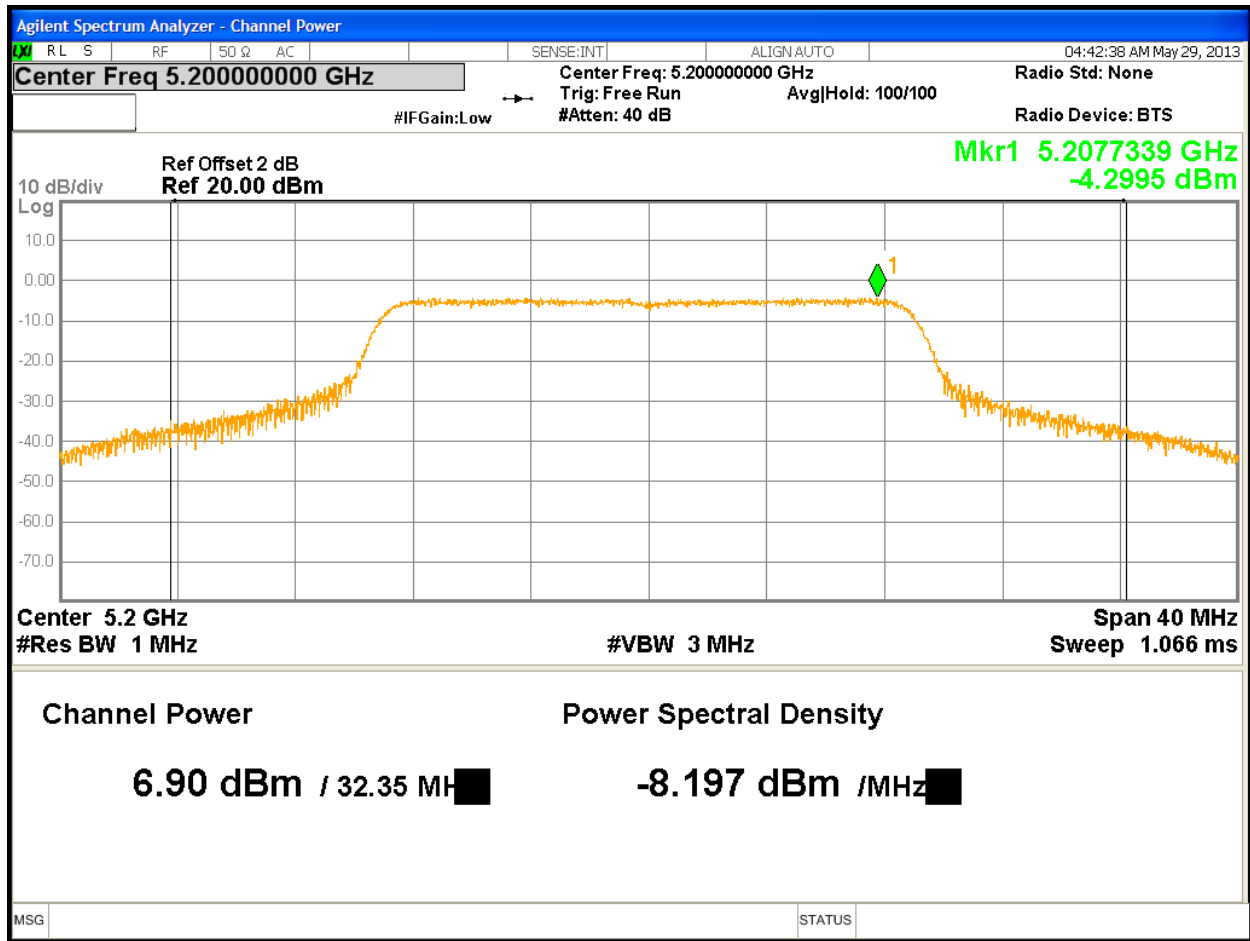

Figure 6: Maximum Transmitted Power, 5200 MHz at HT20, Chain 1

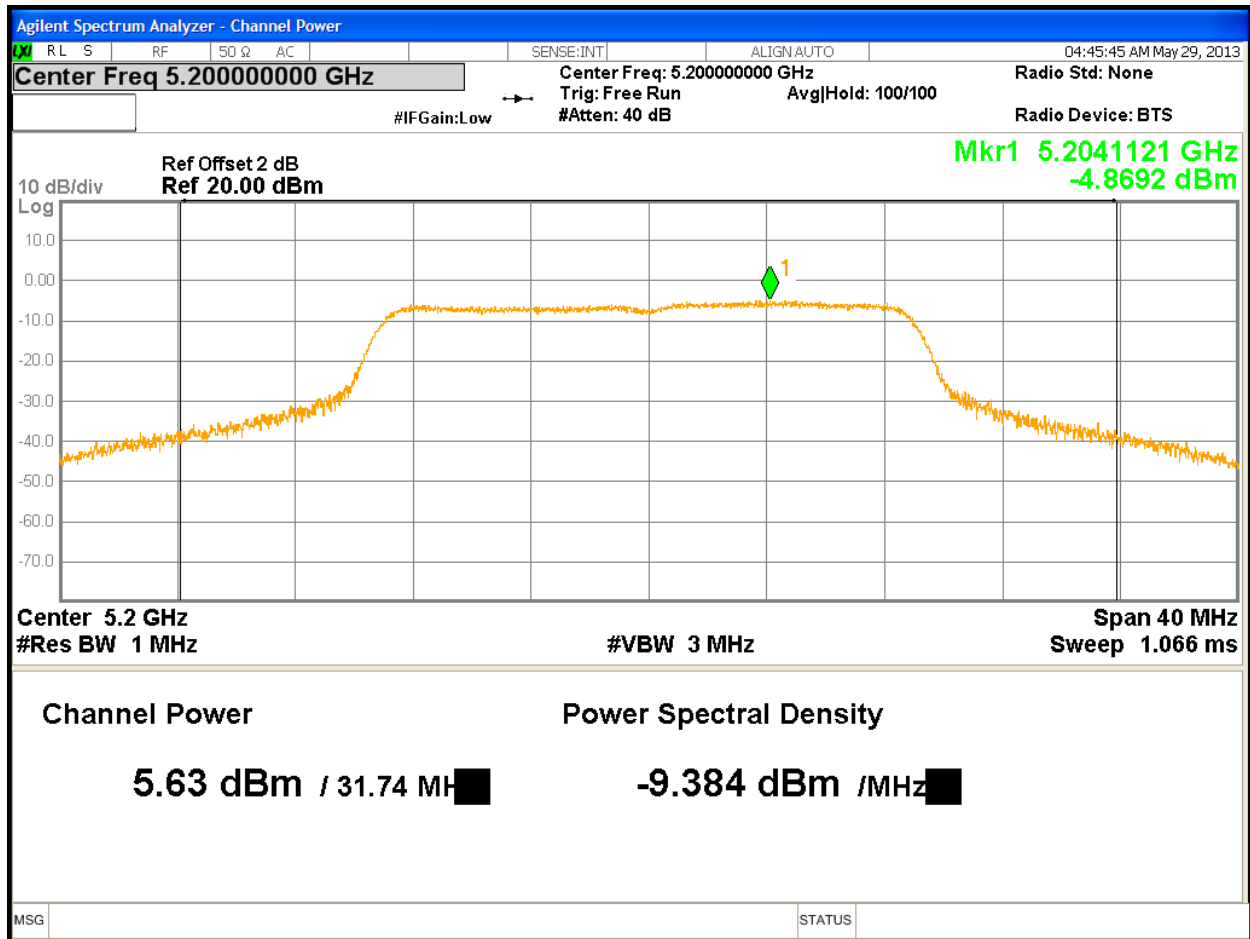

Figure 7: Maximum Transmitted Power, 5200 MHz at HT20, Chain 2

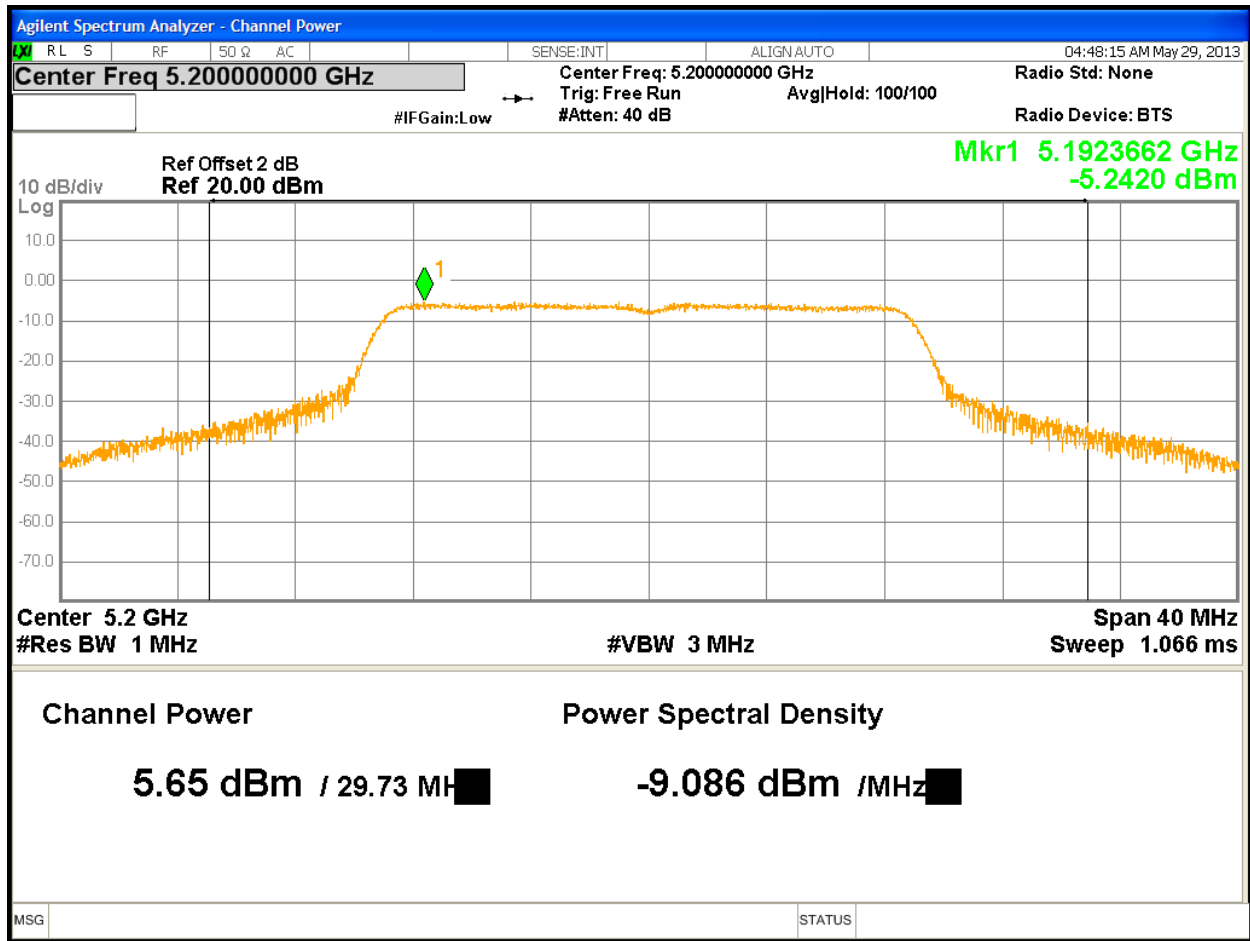

Figure 8: Maximum Transmitted Power, 5200 MHz at HT20, Chain 3

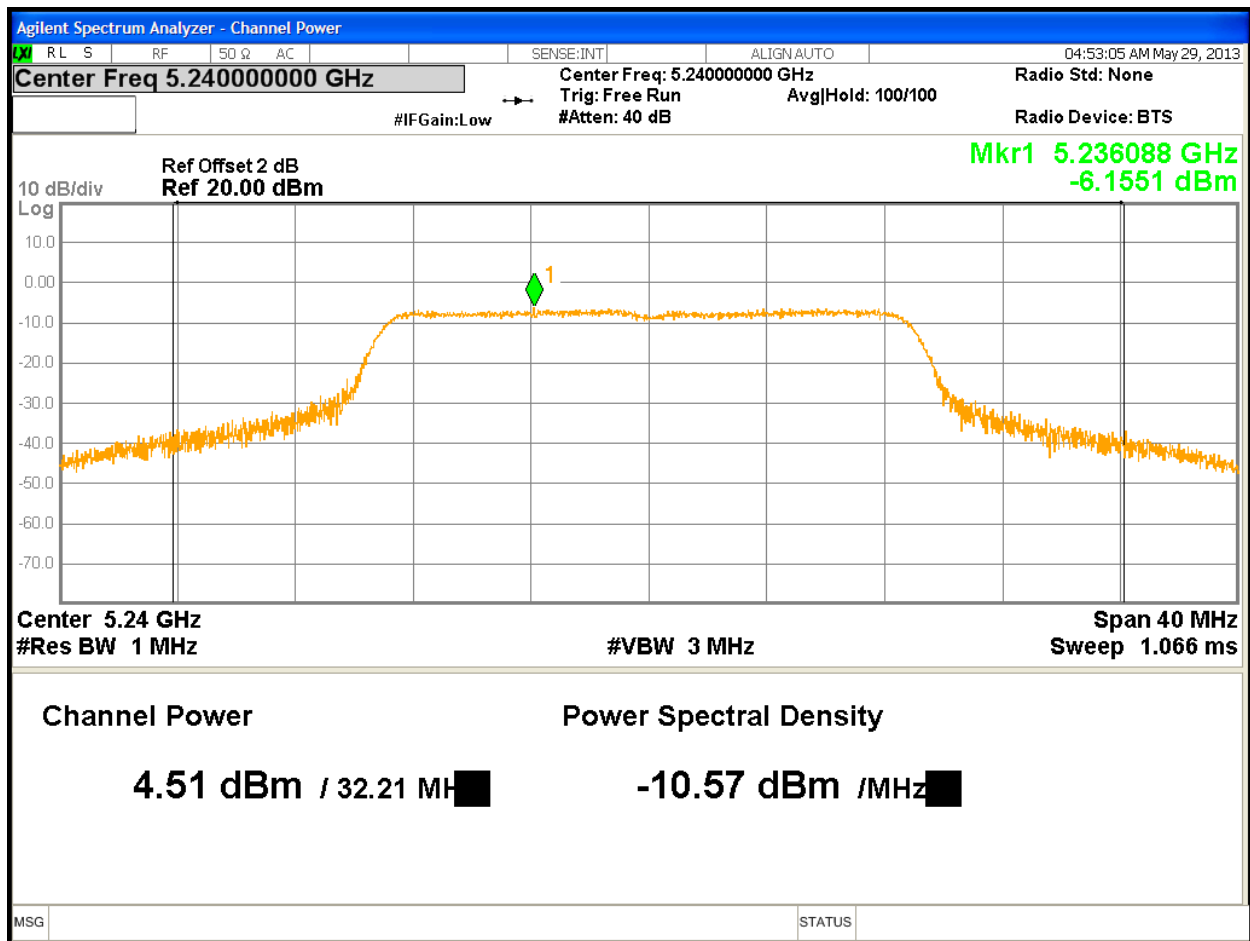

Figure 9: Maximum Transmitted Power, 5240 MHz at HT20, Chain 0

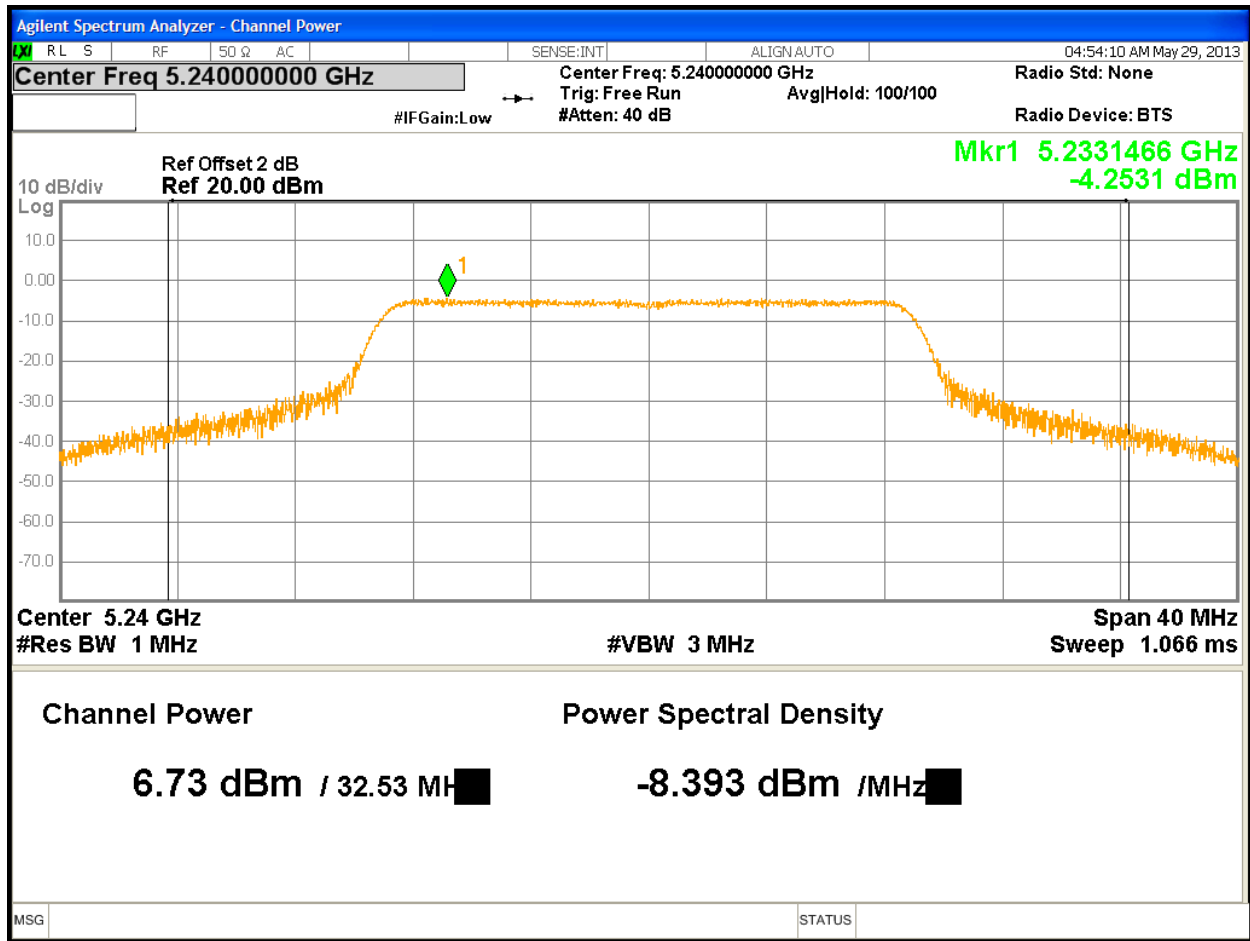

Figure 10: Maximum Transmitted Power, 5240 MHz at HT20, Chain 1

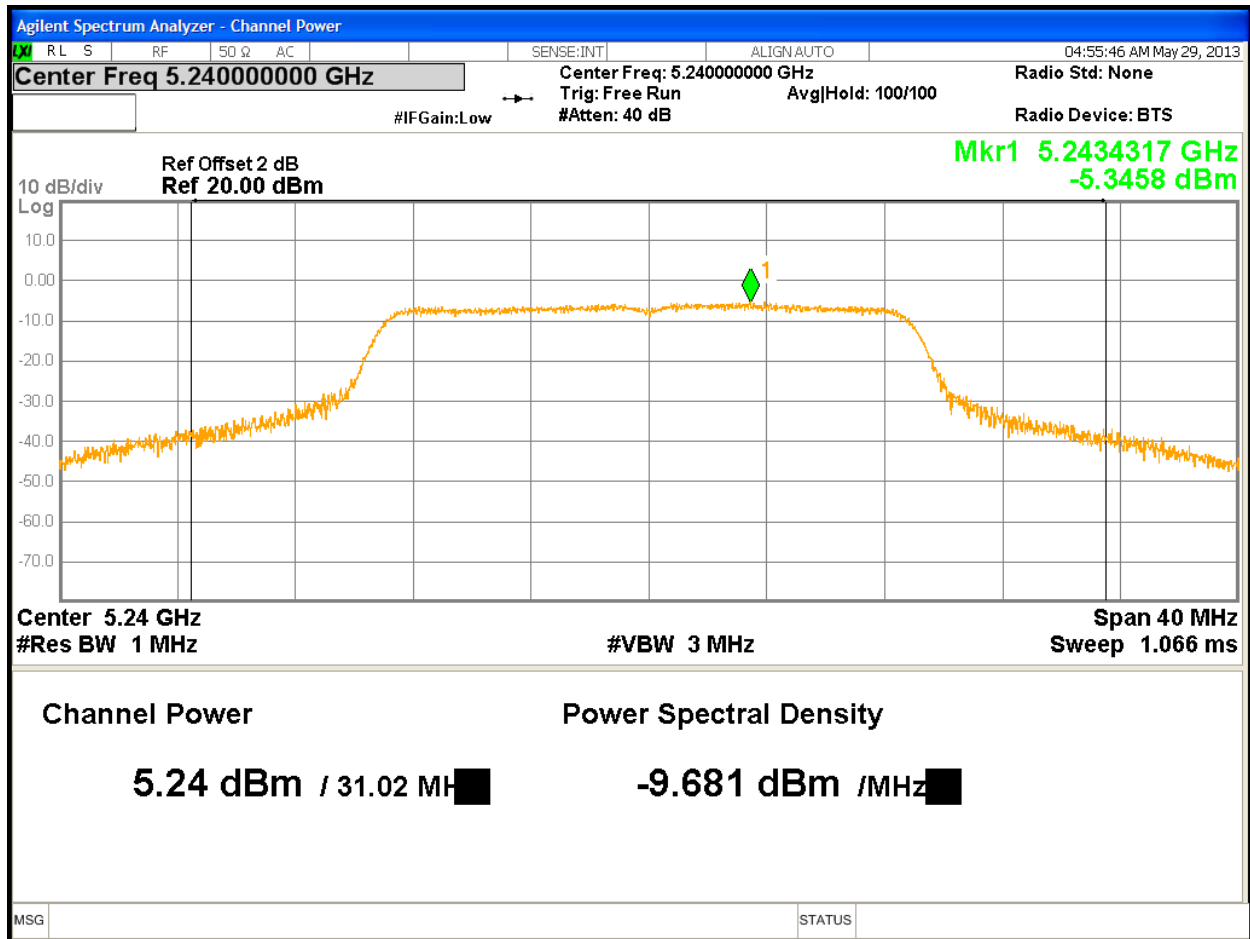

Figure 11: Maximum Transmitted Power, 5240 MHz at HT20, Chain 2

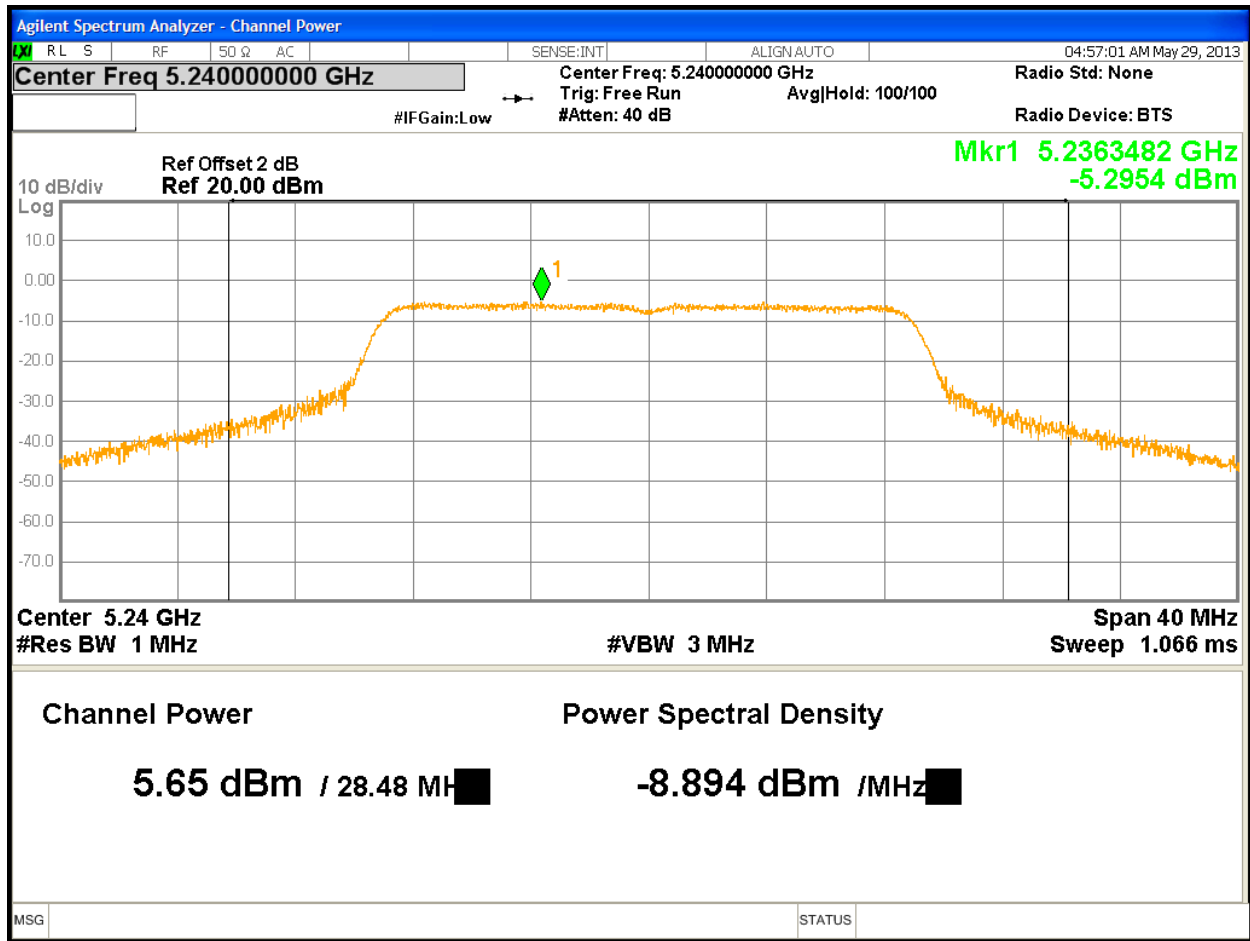

Figure 12: Maximum Transmitted Power, 5240 MHz at HT20, Chain 3

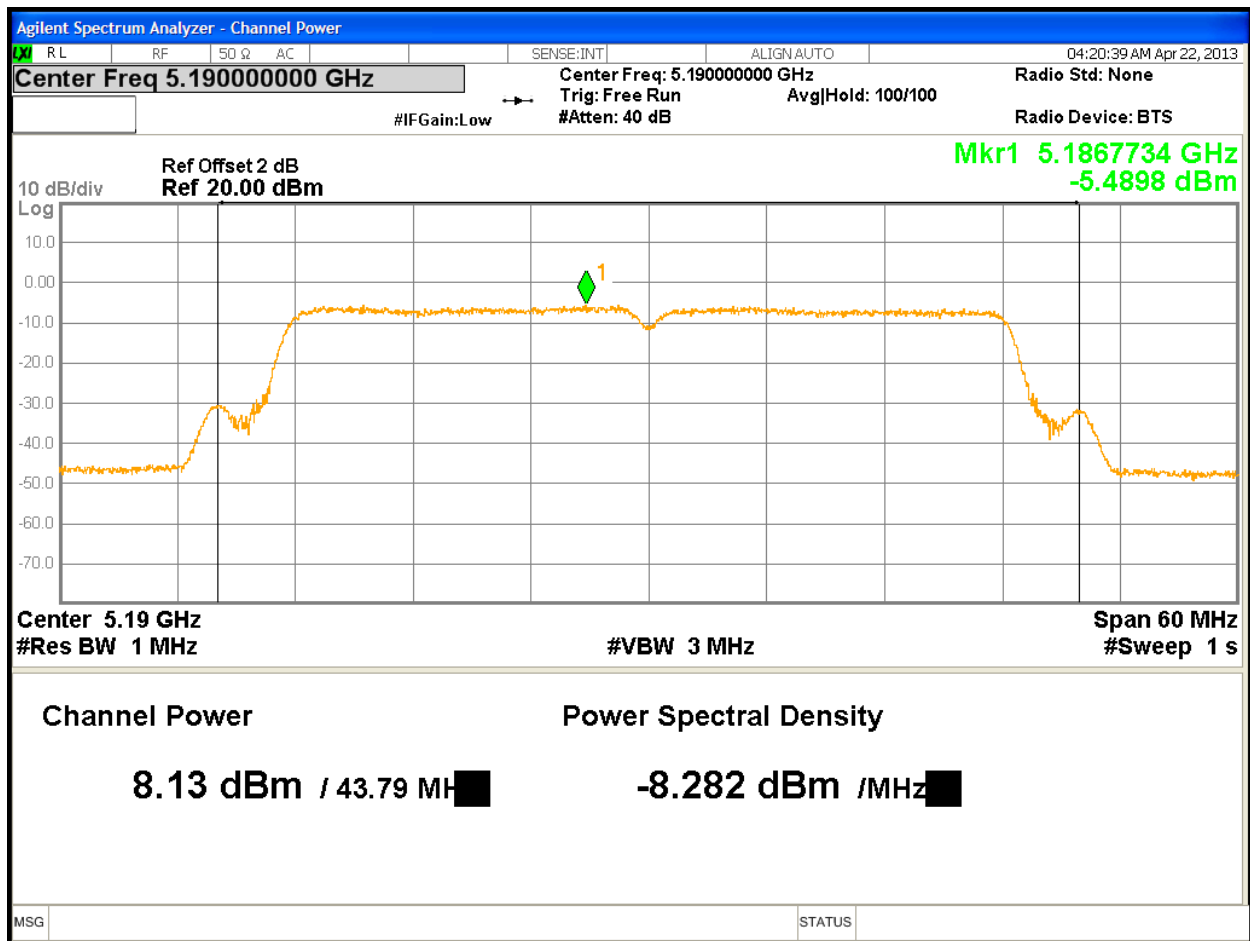

Figure 13: Maximum Transmitted Power, 5190 MHz at HT40, Chain 0

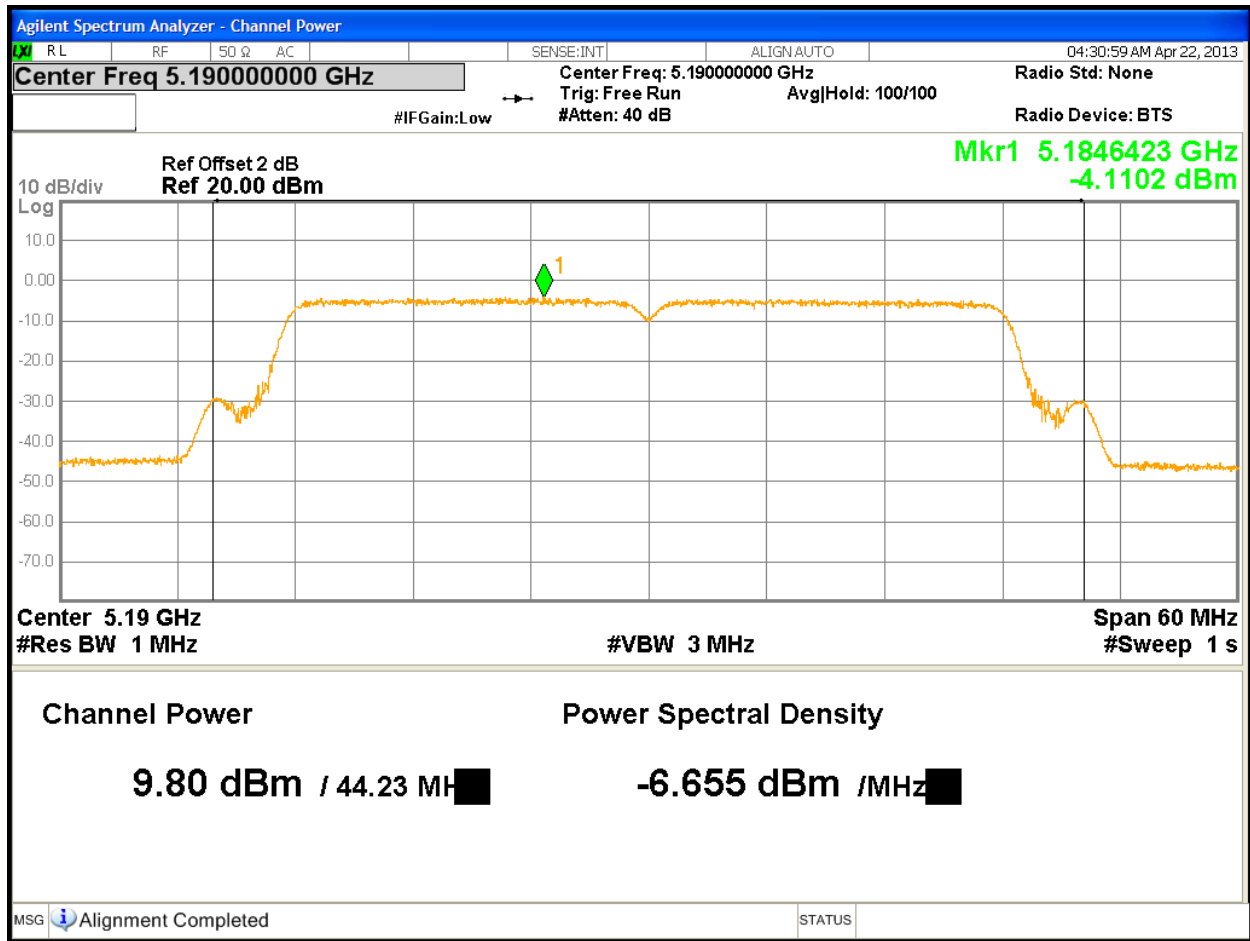

Figure 14: Maximum Transmitted Power, 5190 MHz at HT40, Chain 1

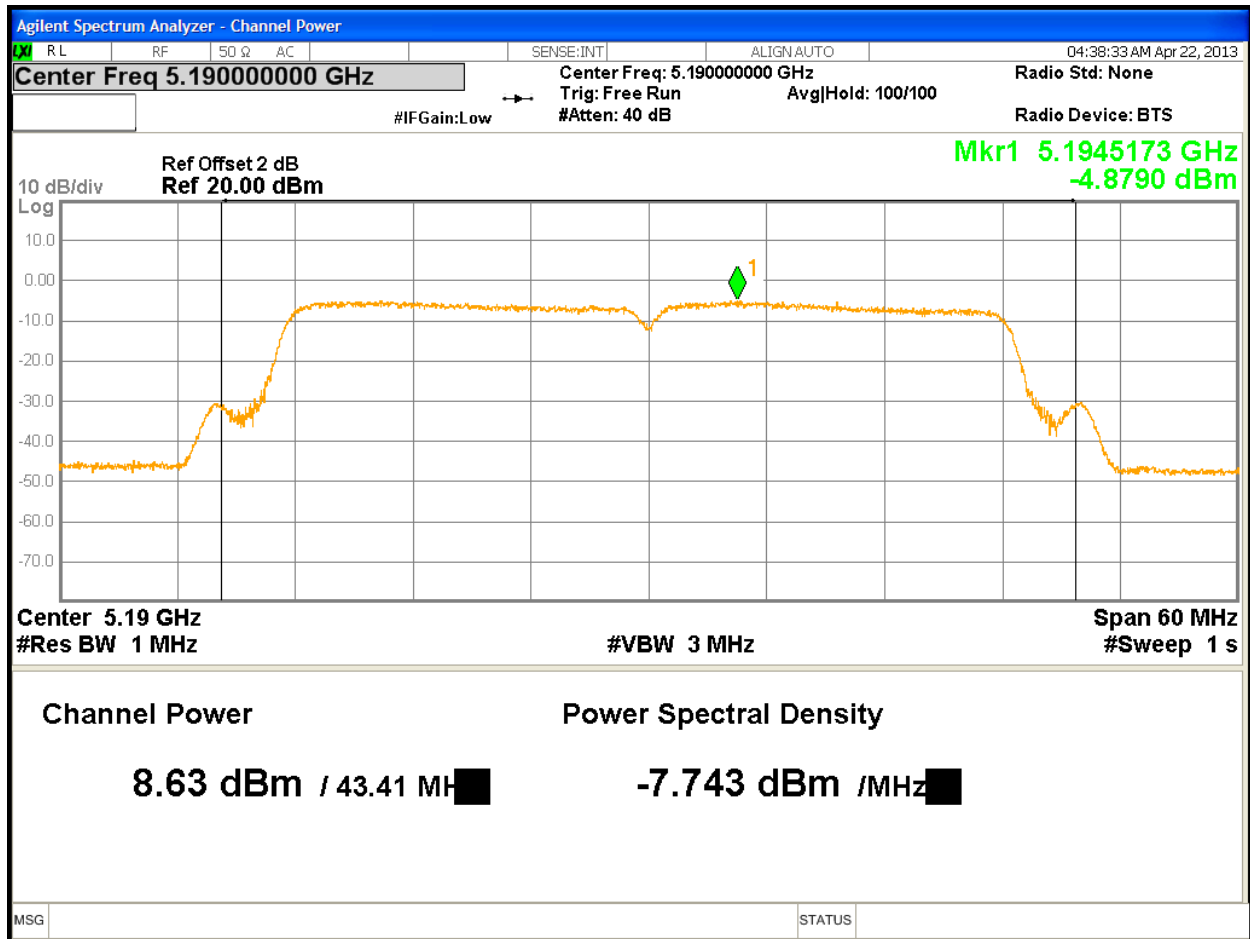

Figure 15: Maximum Transmitted Power, 5190 MHz at HT40, Chain 2

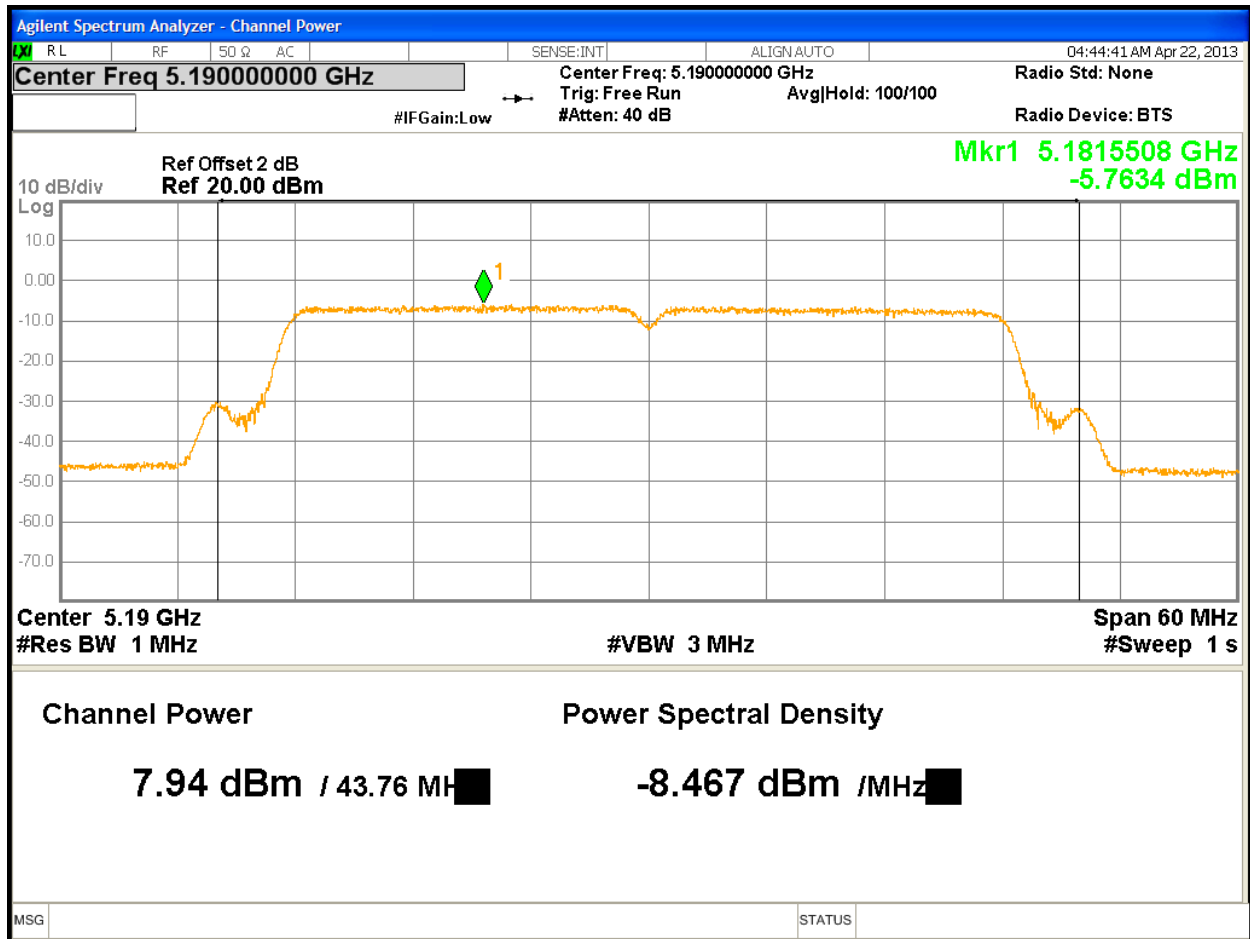

Figure 16: Maximum Transmitted Power, 5190 MHz at HT40, Chain 3

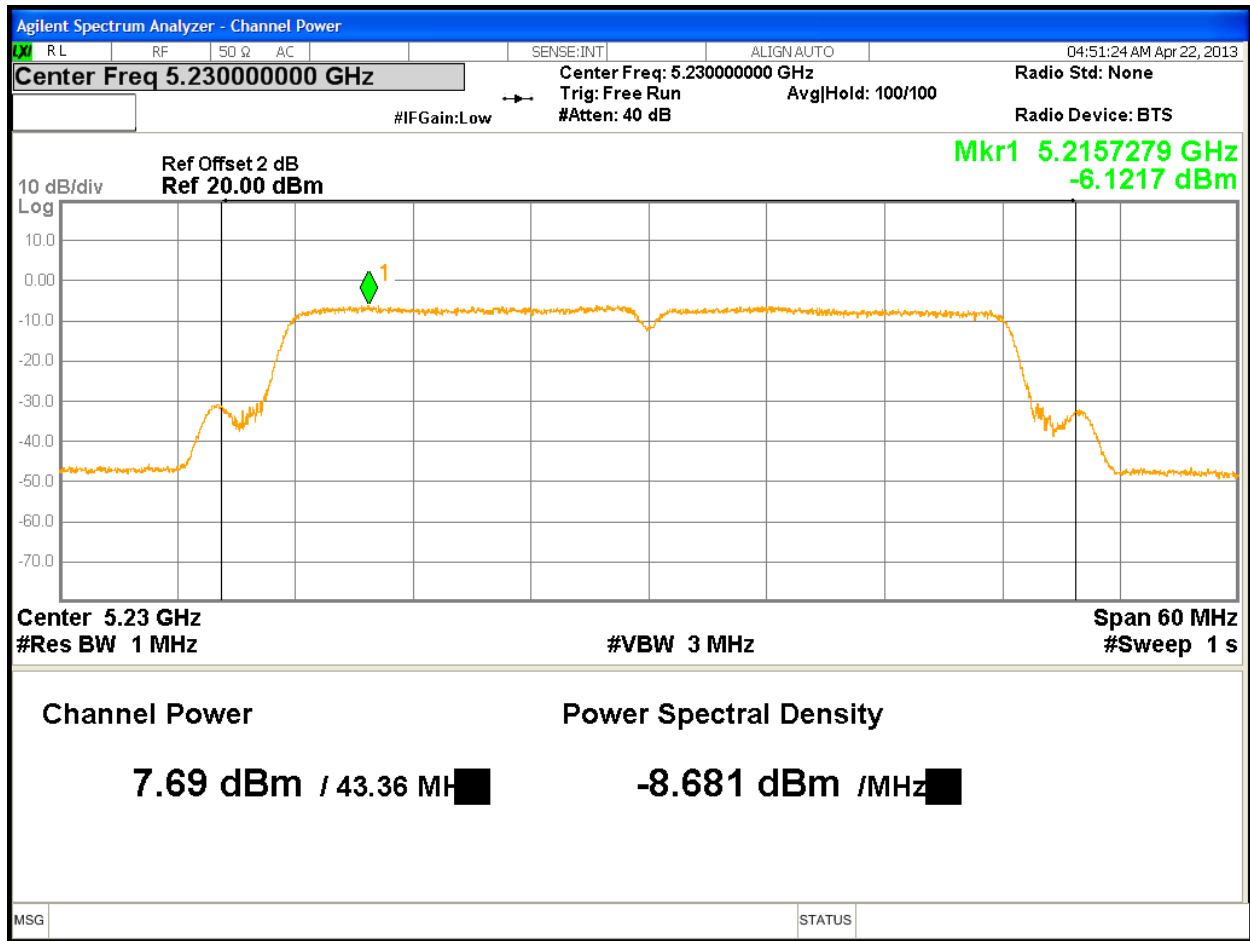

Figure 17: Maximum Transmitted Power, 5230 MHz at HT40, Chain 0

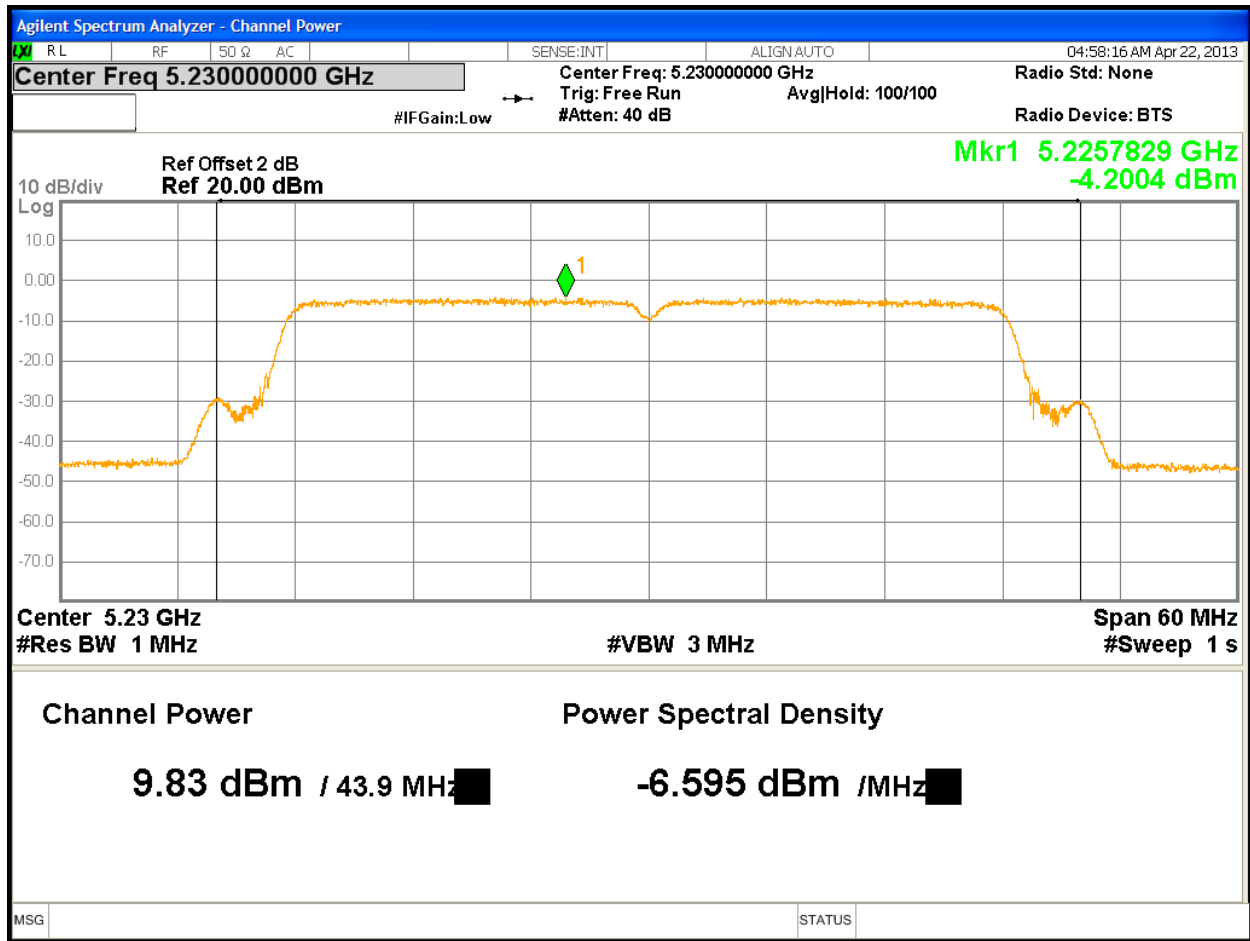

Figure 18: Maximum Transmitted Power, 5230 MHz at HT40, Chain 1

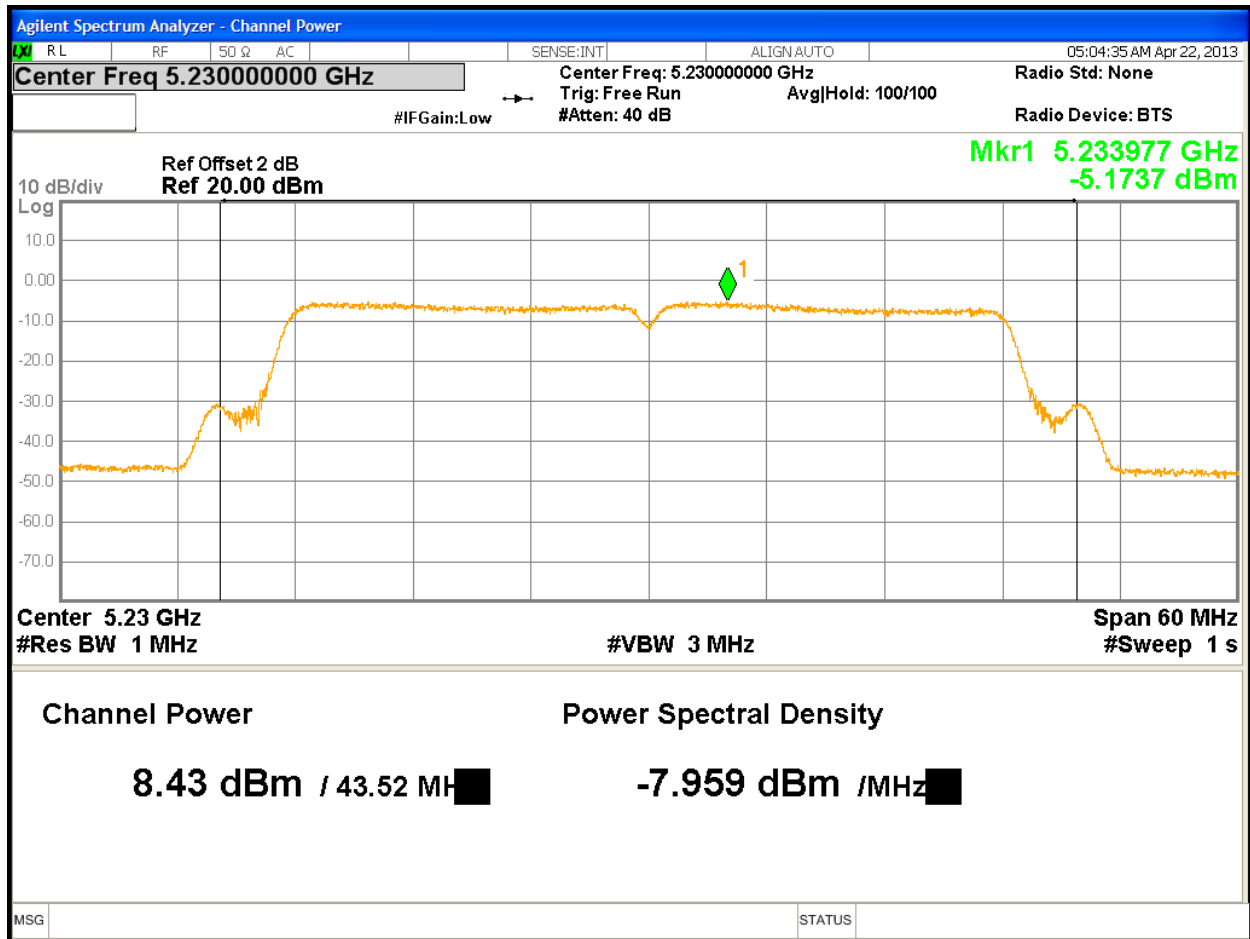

Figure 19: Maximum Transmitted Power, 5230 MHz at HT40, Chain 2

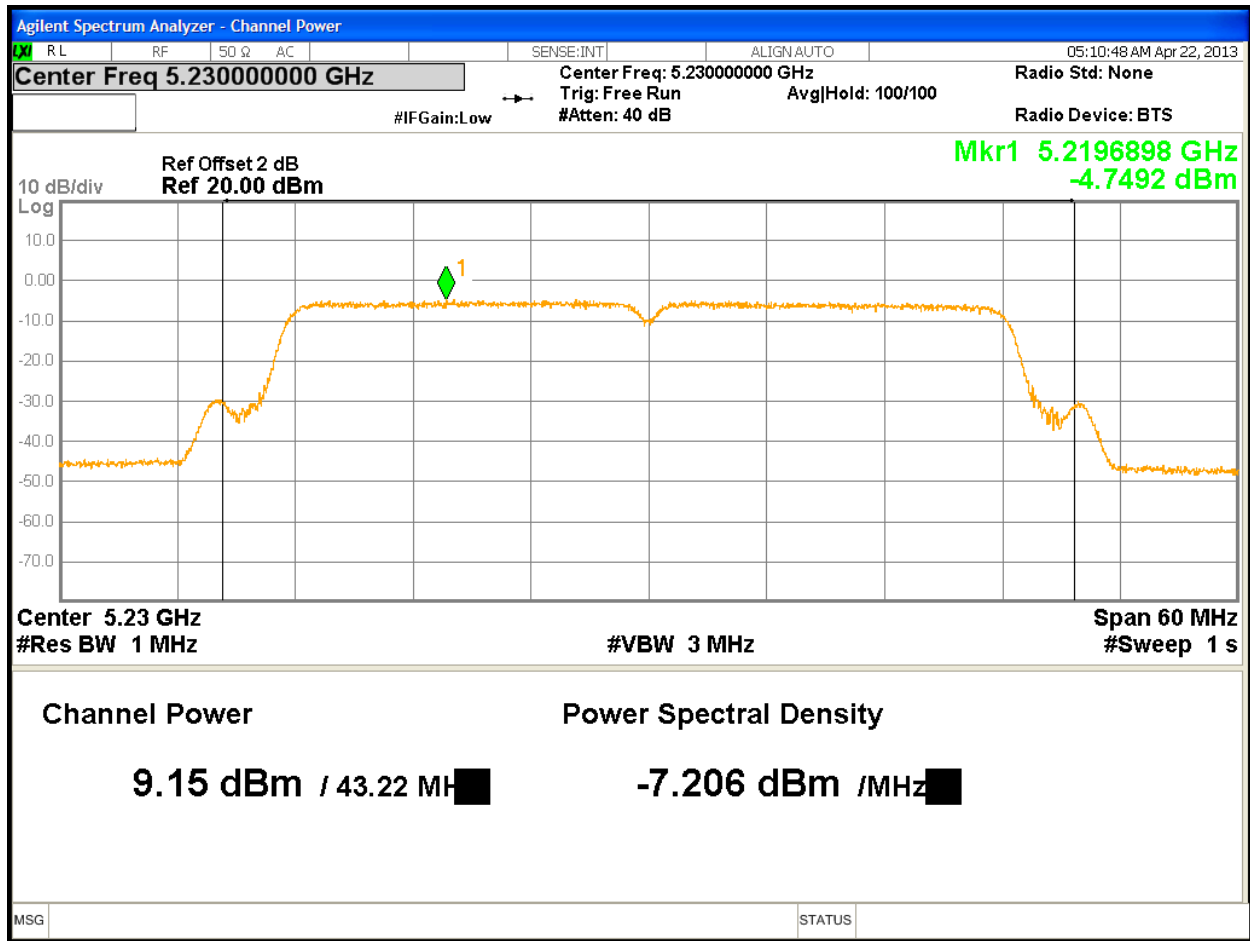

Figure 20: Maximum Transmitted Power, 5230 MHz at HT40, Chain 3

4.2 Occupied Bandwidth

The occupied bandwidth is measured at an amplitude level reduced from the reference level by a specified ratio. The reference level is the level of the highest amplitude signal observed from the transmitter at the fundamental frequency.

The 99% bandwidth is the bandwidth in which 99% of the transmitted power occupied.

The 26 dB bandwidth is defined the bandwidth of 26 dB from highest transmitted level of the fundamental frequency.

There is no restriction limits for the bandwidth. The 26 dB bandwidth was used to determine the limit for maximum conducted output power per CFR47 Part 15.407(a).

To obtain the tighter limit,

4.2.1 Test Method

The conducted method was used to measure the occupied bandwidth. The measurement was performed with modulation per CFR47 15.407(a) 2012 and RSS Gen Sect. 4.4.1:2010. The preliminary investigation was performed to find the narrowest 26 dB bandwidth for each operational mode at different data rates. This worst finding was performed on 3 channels in each operating frequency range; 5150 MHz to 5250 MHz. The worst results indicated below.

Test Setup:

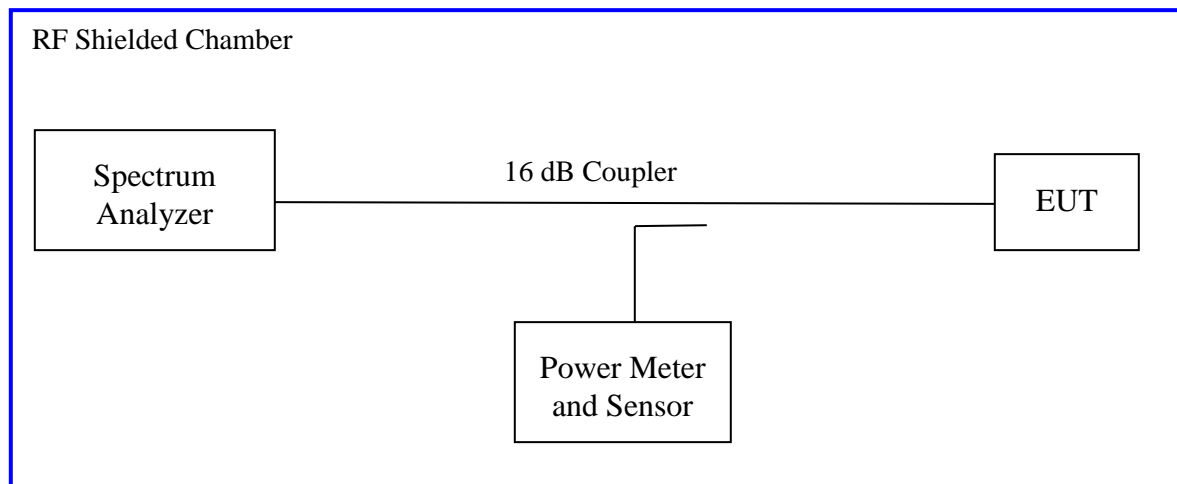

4.2.2 Results

These occupied bandwidth measurements were taken for references only.

Table 4: Occupied Bandwidth – Test Results

Test Conditions: Conducted Measurement, Normal Temperature and Voltage only								
Antenna Type: Integrated					Power Setting: See Test Plan			
Max. Directional Gain: + 8 dBi					Signal State: Modulated at 100%.			
Ambient Temp.: 21 °C					Relative Humidity: 33%			
Bandwidth (MHz) for 802.11n HT20								
Freq. (MHz)	26dB Bandwidth (MHz)				99% Bandwidth (MHz)			
	Ch0	Ch1	Ch2	Ch3	Ch0	Ch1	Ch2	Ch3
5180	26.859	27.807	25.955	26.119	18.165	18.401	18.112	18.141
5200	27.076	27.658	25.640	26.029	18.163	18.403	18.103	18.136
5240	26.993	27.812	25.100	25.993	18.185	18.408	18.023	18.136
Note: The bandwidth was measured at 6.5 Mbps for 802.11n HT20 mode.								
Bandwidth (MHz) for 802.11n HT40								
Freq. (MHz)	26dB Bandwidth (MHz)				99% Bandwidth (MHz)			
	Ch0	Ch1	Ch2	Ch3	Ch0	Ch1	Ch2	Ch3
5190	43.833	44.234	43.946	43.712	36.460	36.655	36.470	36.260
5230	43.842	44.300	44.026	43.159	36.417	36.618	36.510	36.222
Note: The bandwidth was measured at 13Mbps for 802.11n HT40 mode.								

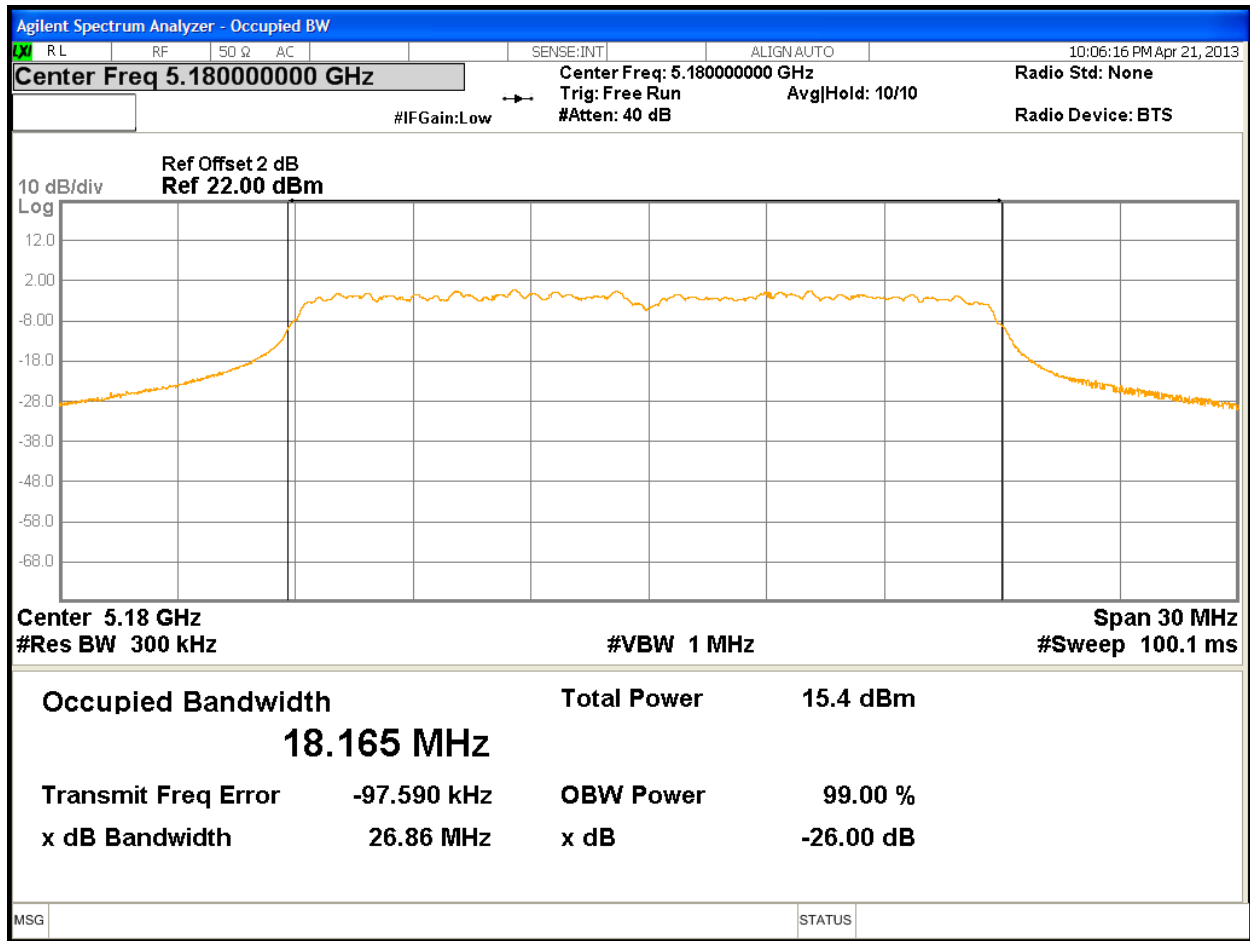

Figure 21: 26 dB and 99% Bandwidth at 5180 MHz, Chain 0

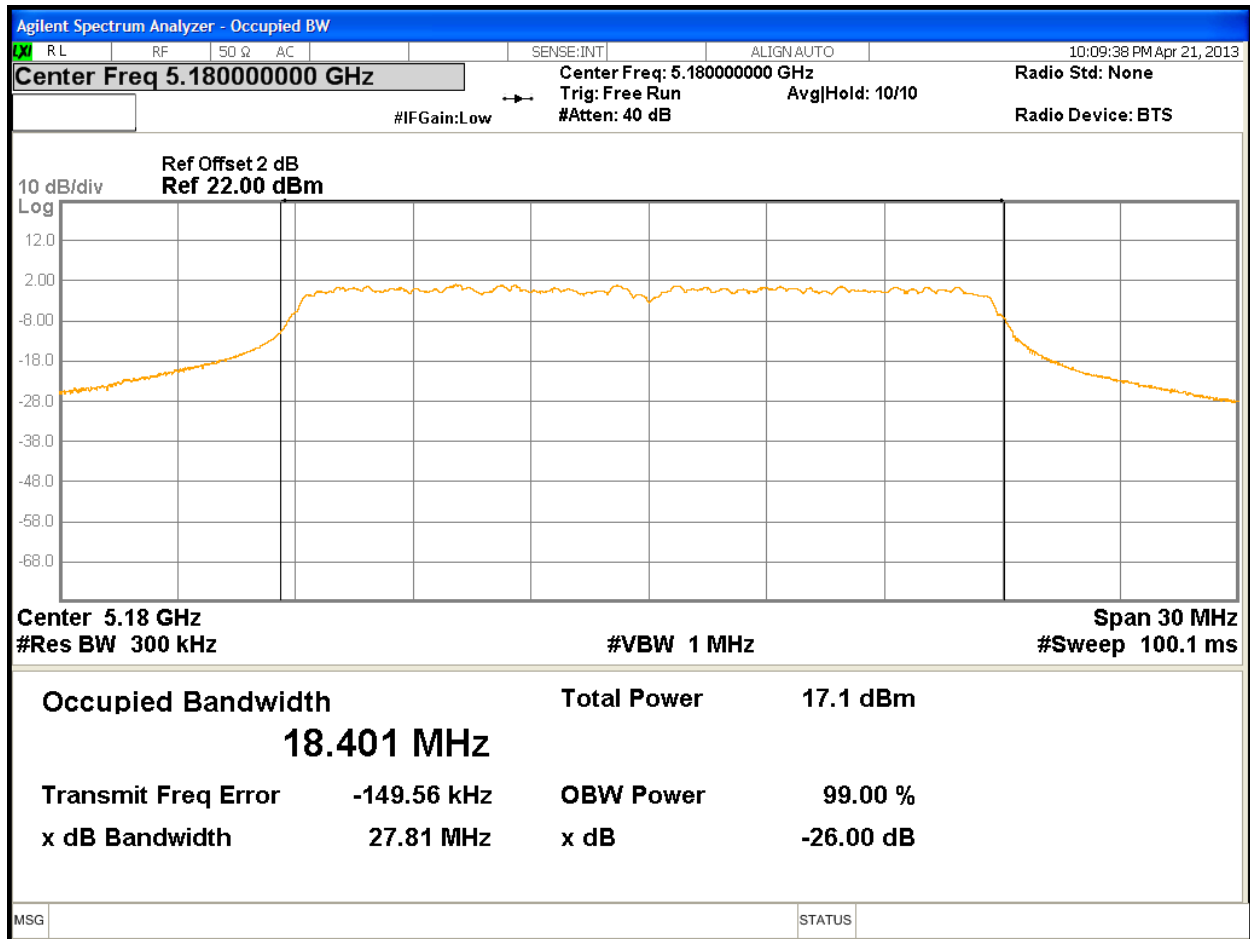

Figure 22: 26 dB and 99% Bandwidth at 5180 MHz, Chain 1

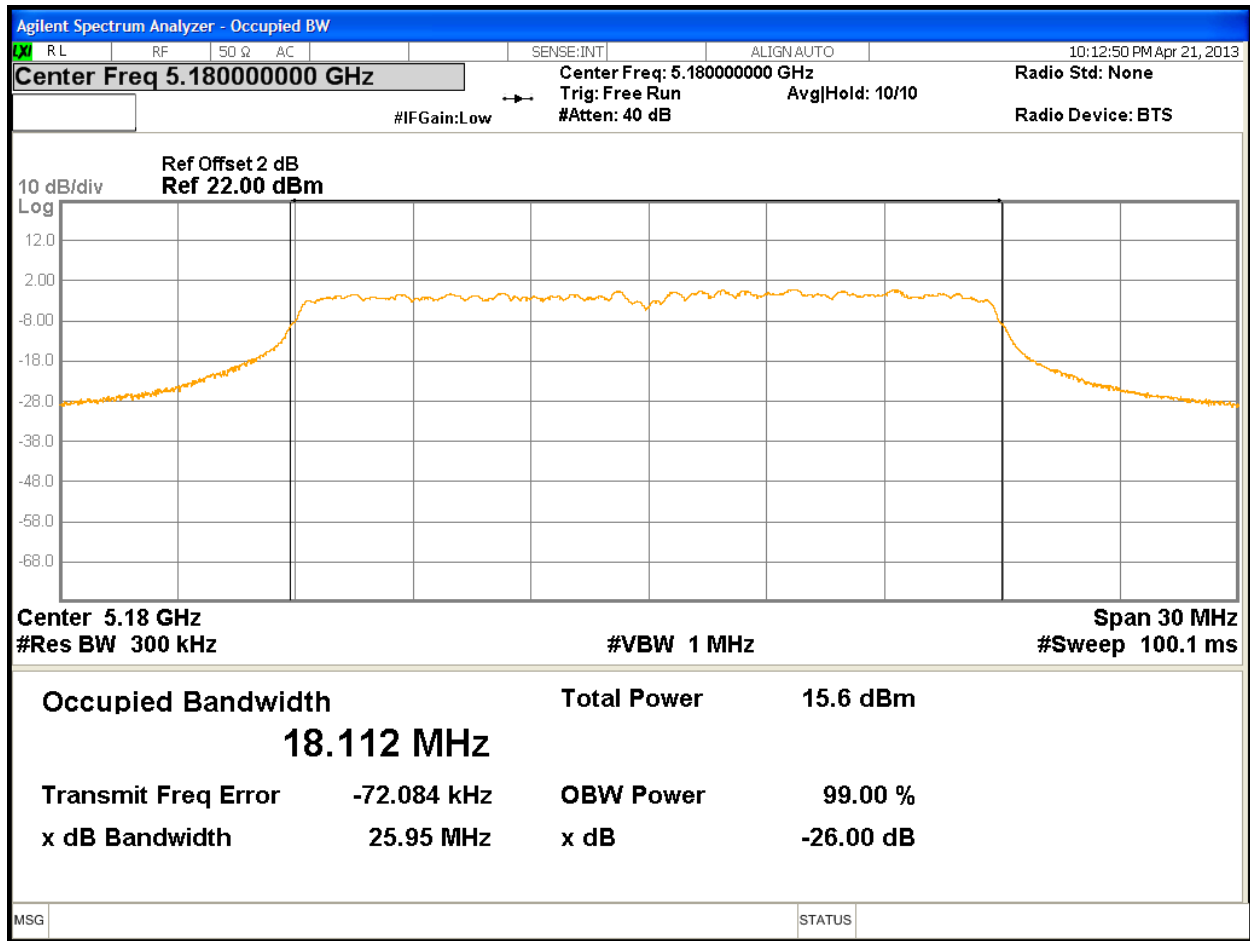

Figure 23: 26 dB and 99% Bandwidth at 5180 MHz, Chain 2

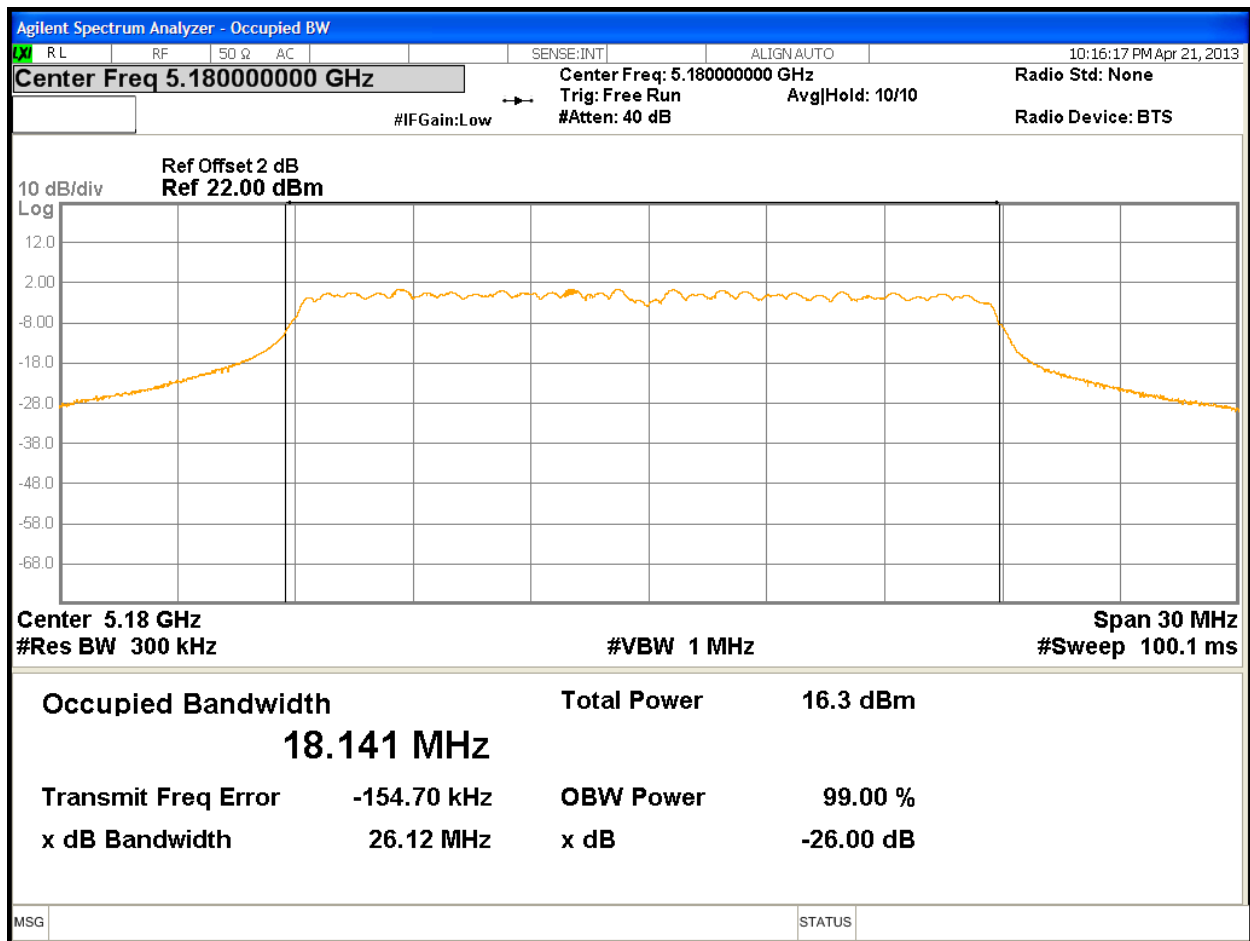

Figure 24: 26 dB and 99% Bandwidth at 5180 MHz, Chain 3

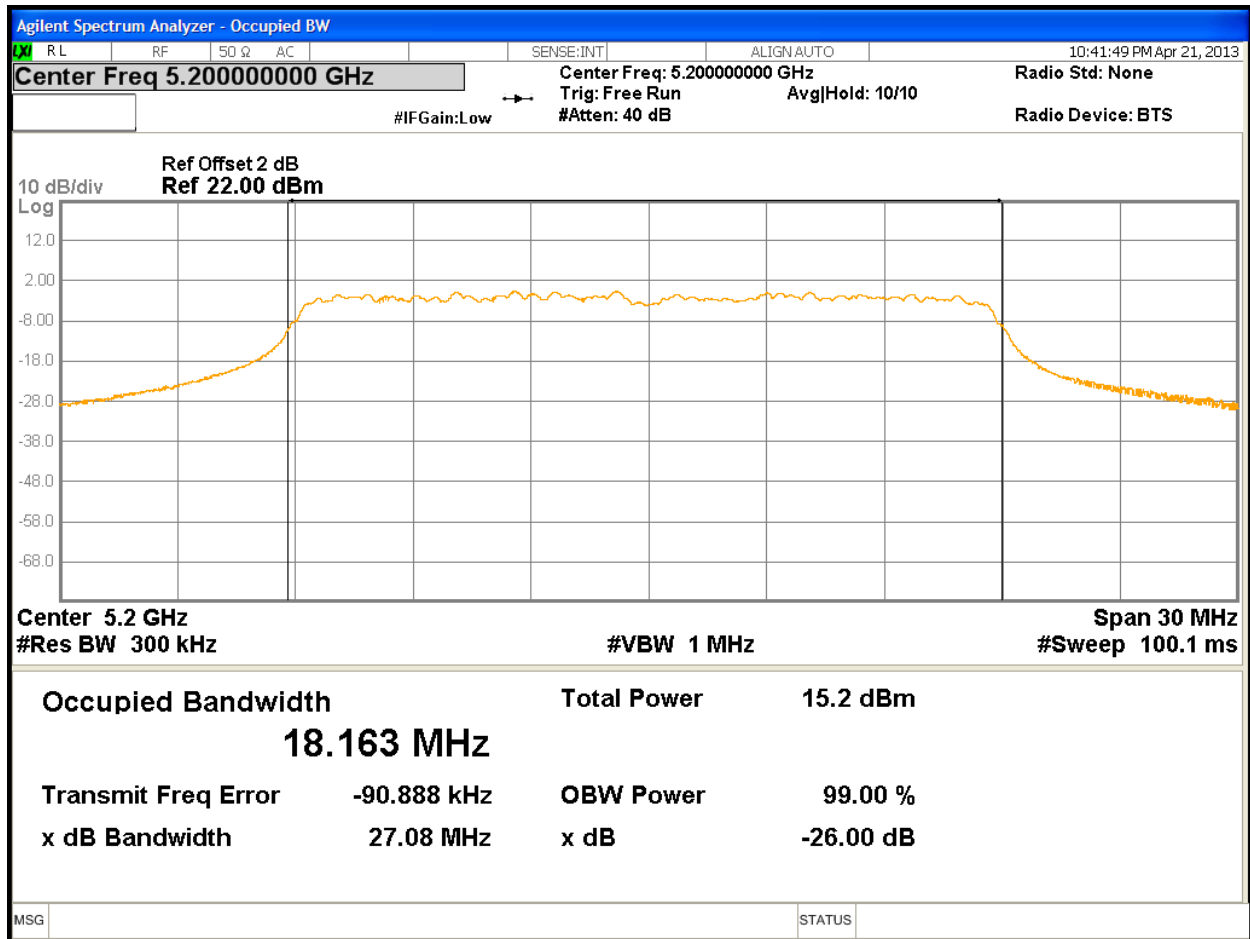

Figure 25: 26 dB and 99% Bandwidth at 5200 MHz, Chain 0

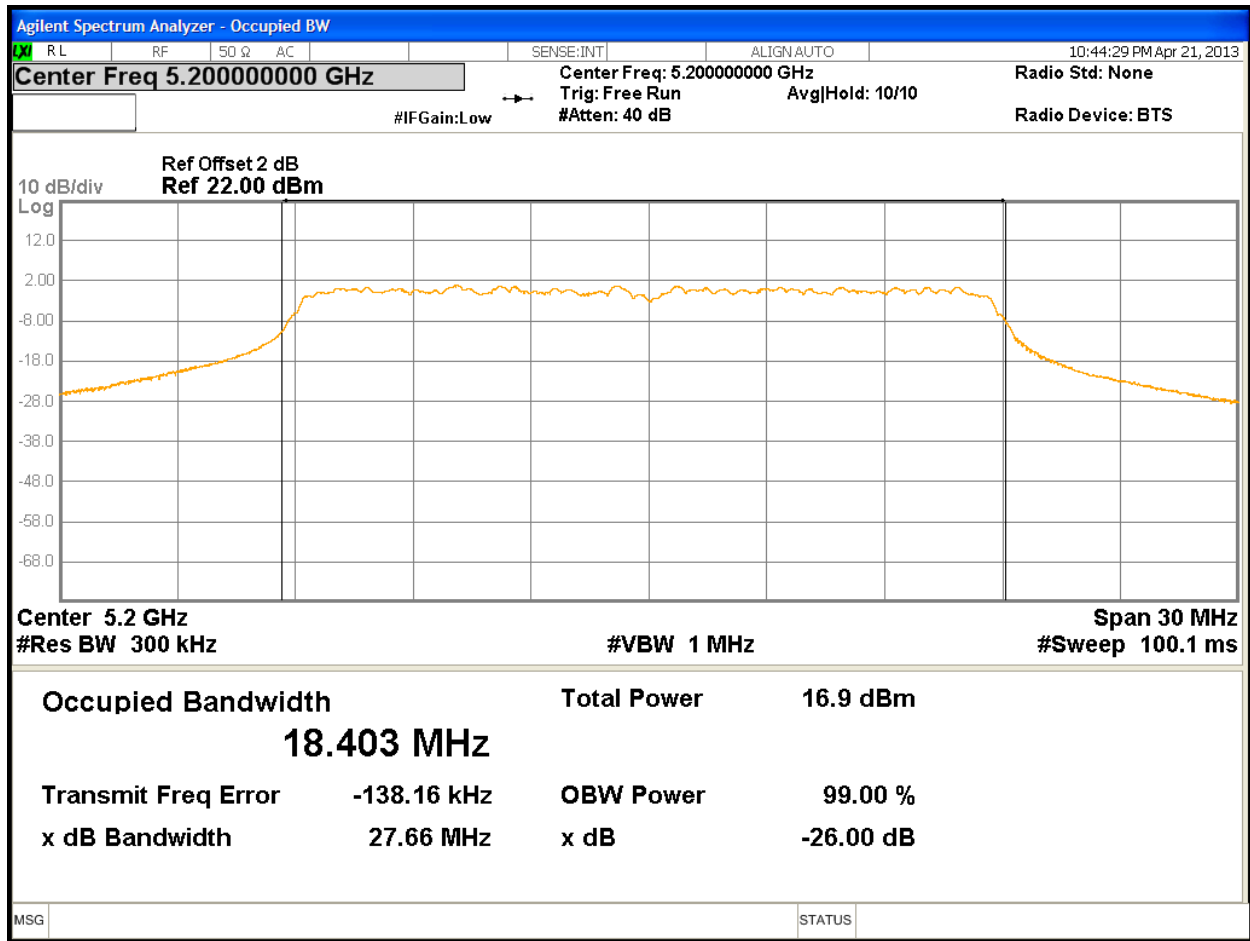

Figure 26: 26 dB and 99% Bandwidth at 5200 MHz, Chain 1

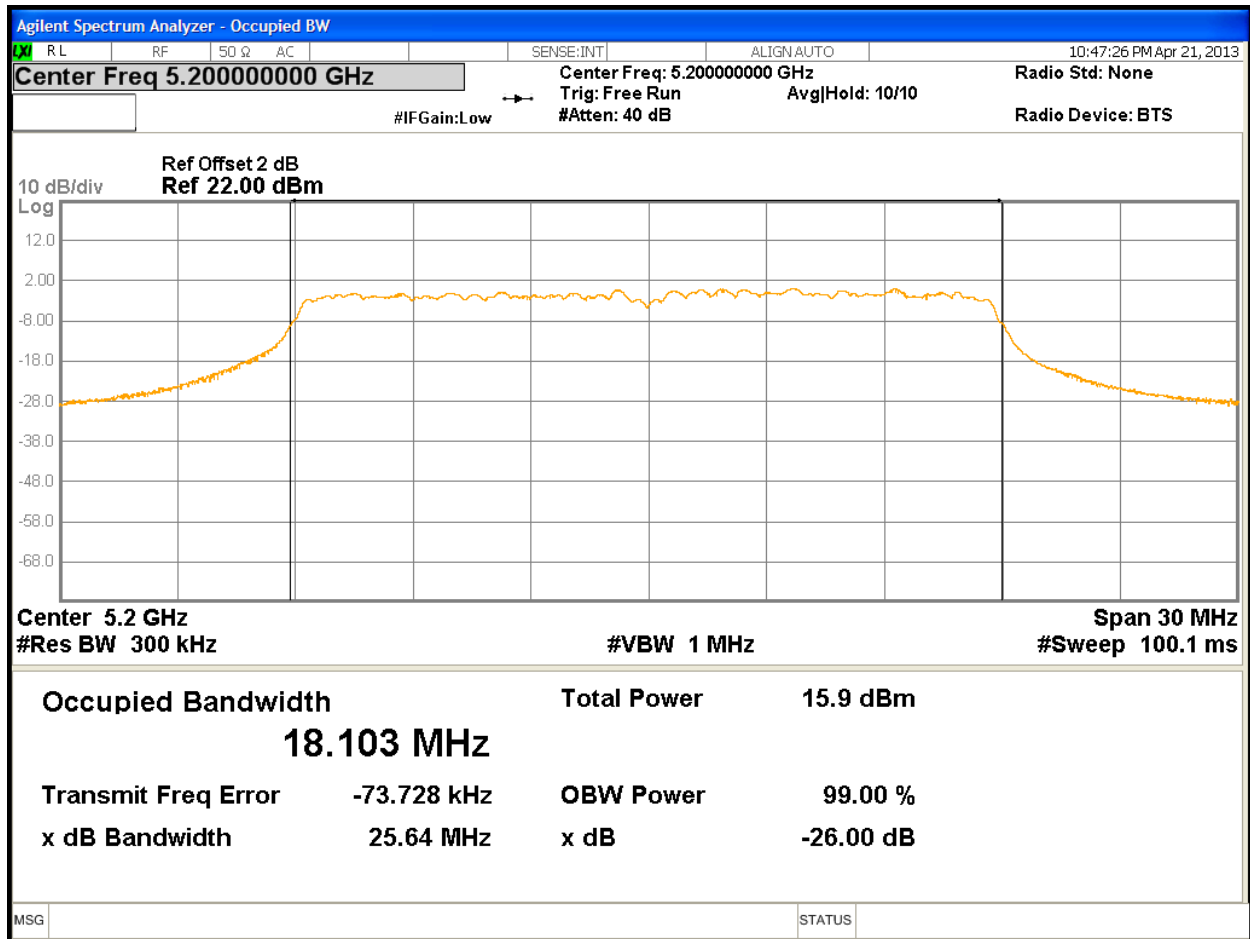

Figure 27: 26 dB and 99% Bandwidth at 5200 MHz, Chain 2

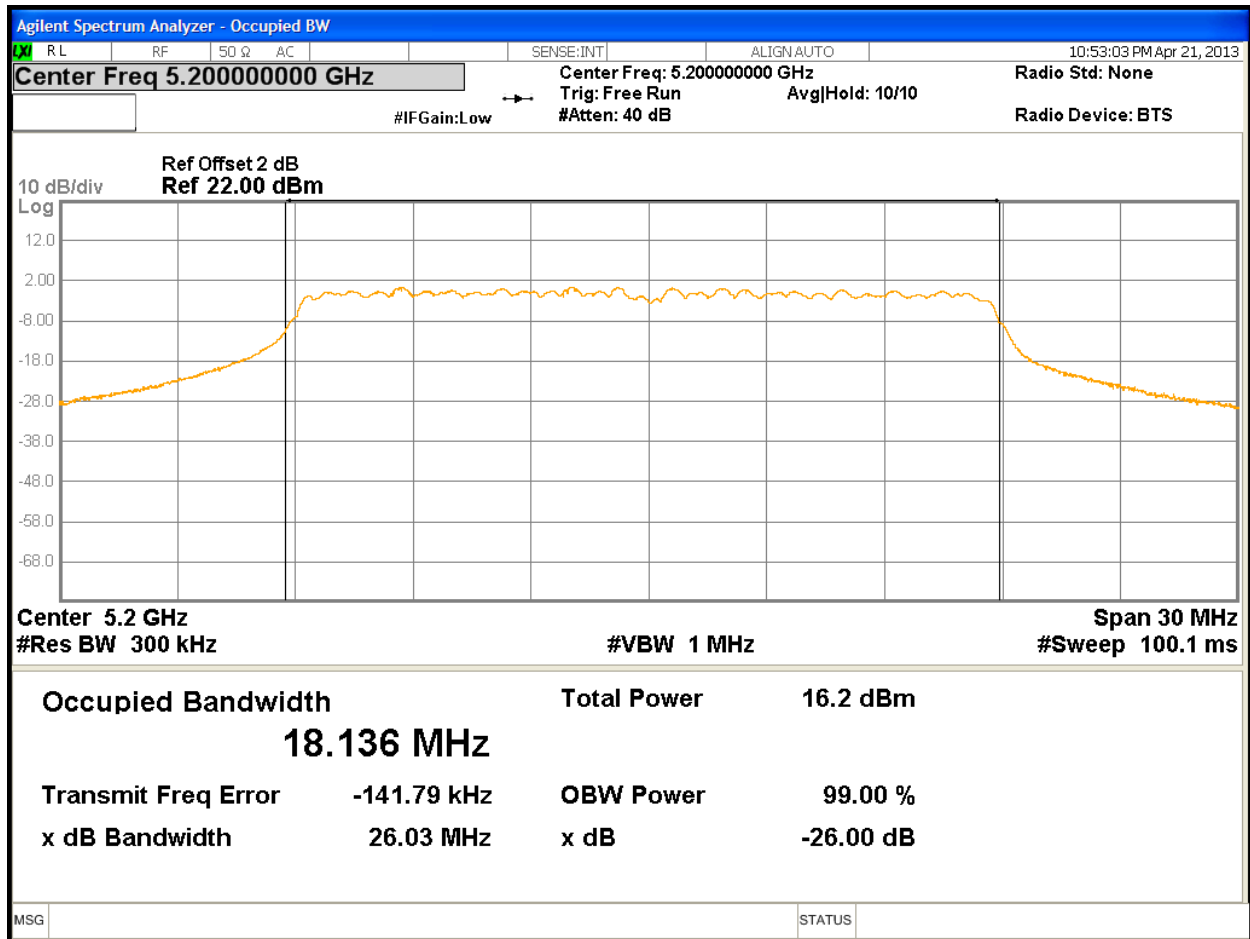

Figure 28: 26 dB and 99% Bandwidth at 5200 MHz, Chain 3

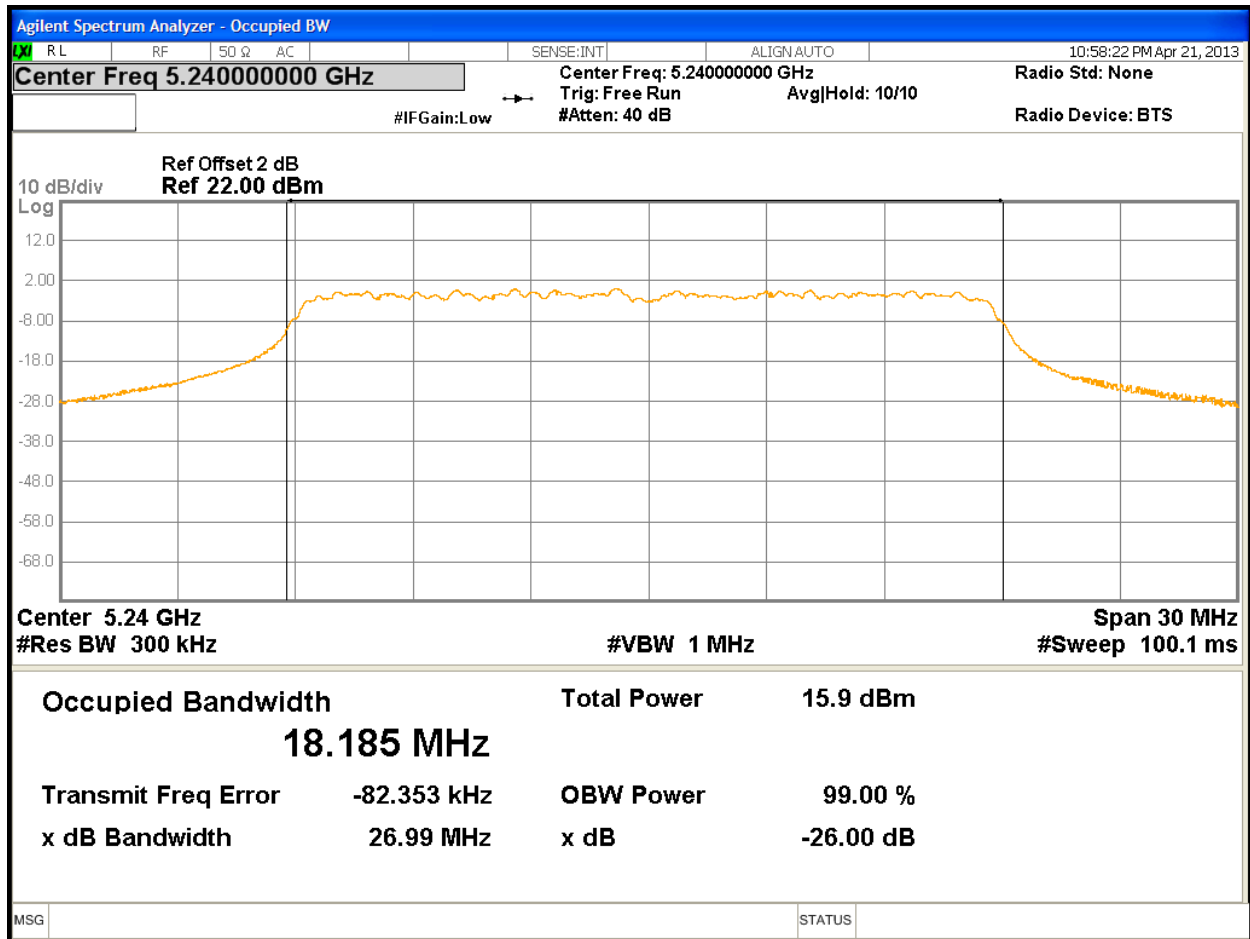

Figure 29: 26 dB and 99% Bandwidth at 5240 MHz, Chain 0

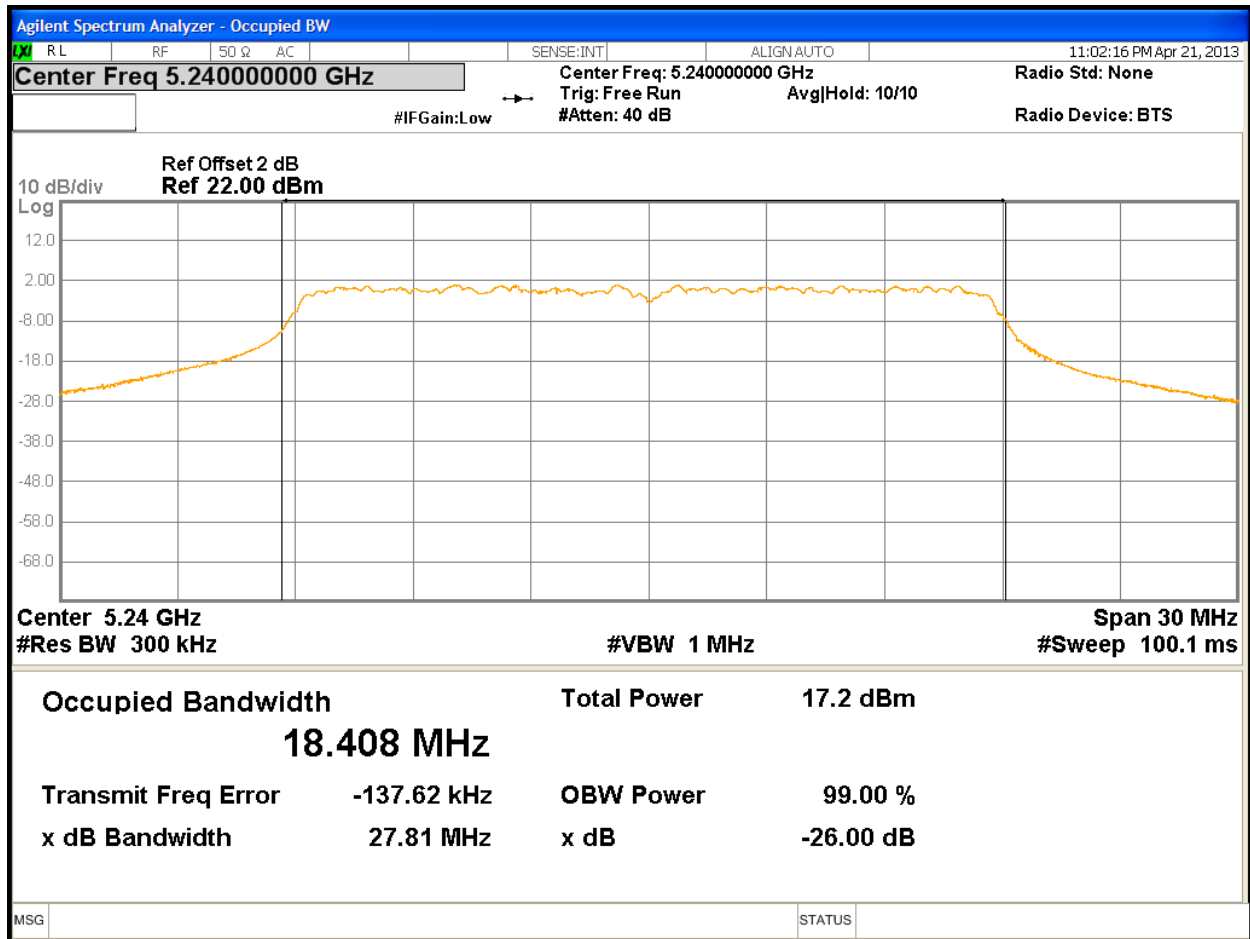

Figure 30: 26 dB and 99% Bandwidth at 5240 MHz, Chain 1

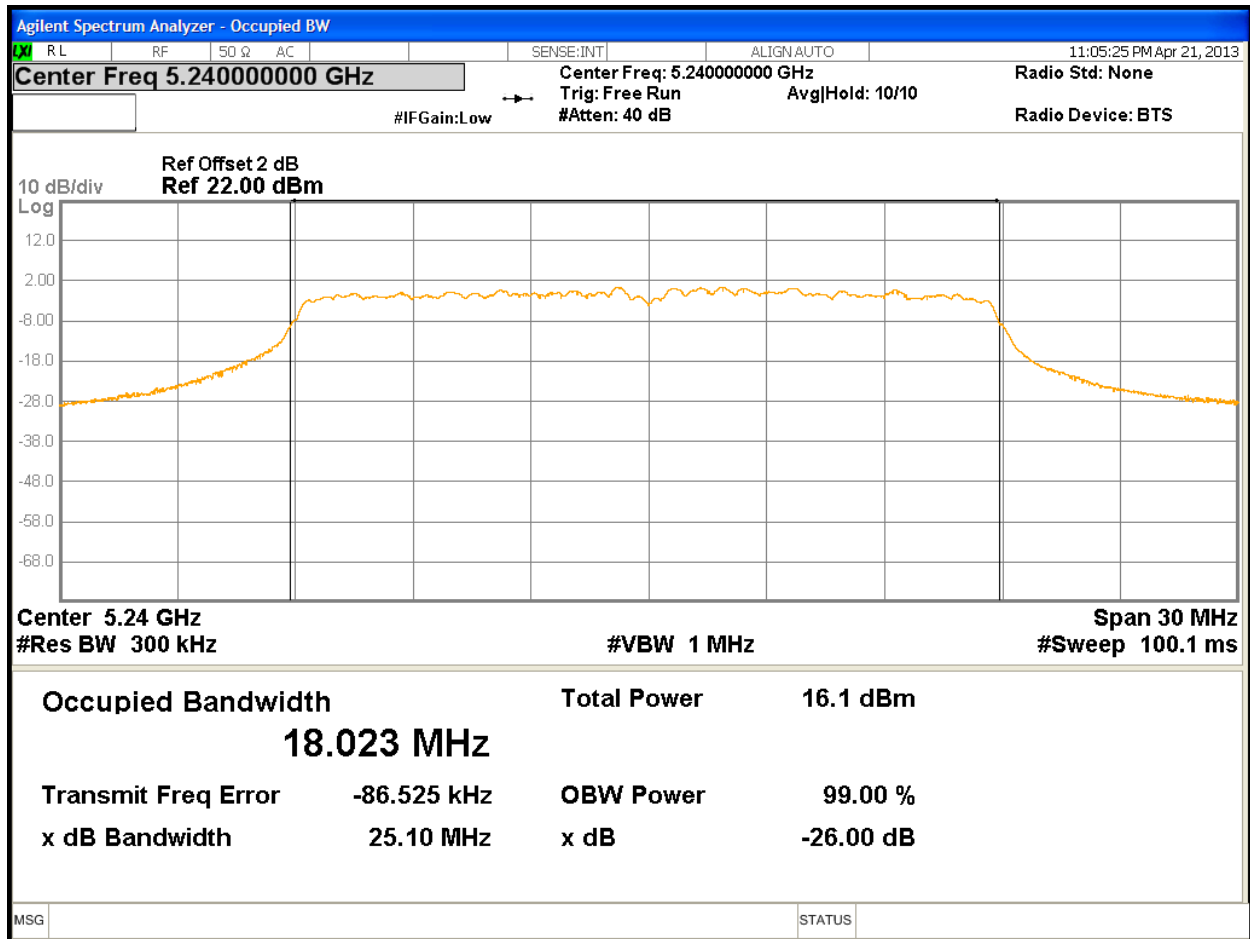

Figure 31: 26 dB and 99% Bandwidth at 5240 MHz, Chain 2

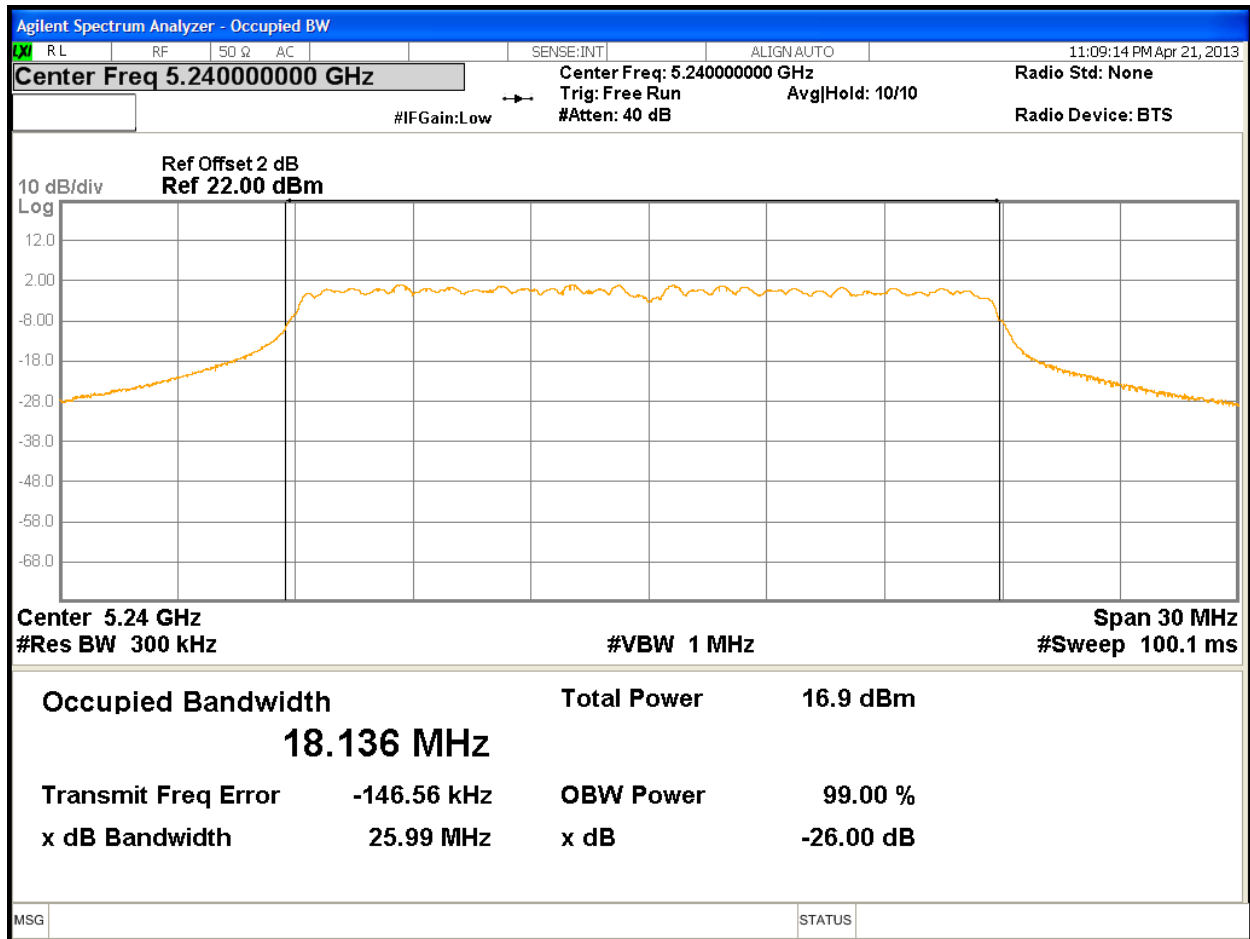

Figure 32: 26 dB and 99% Bandwidth at 5240 MHz, Chain 3

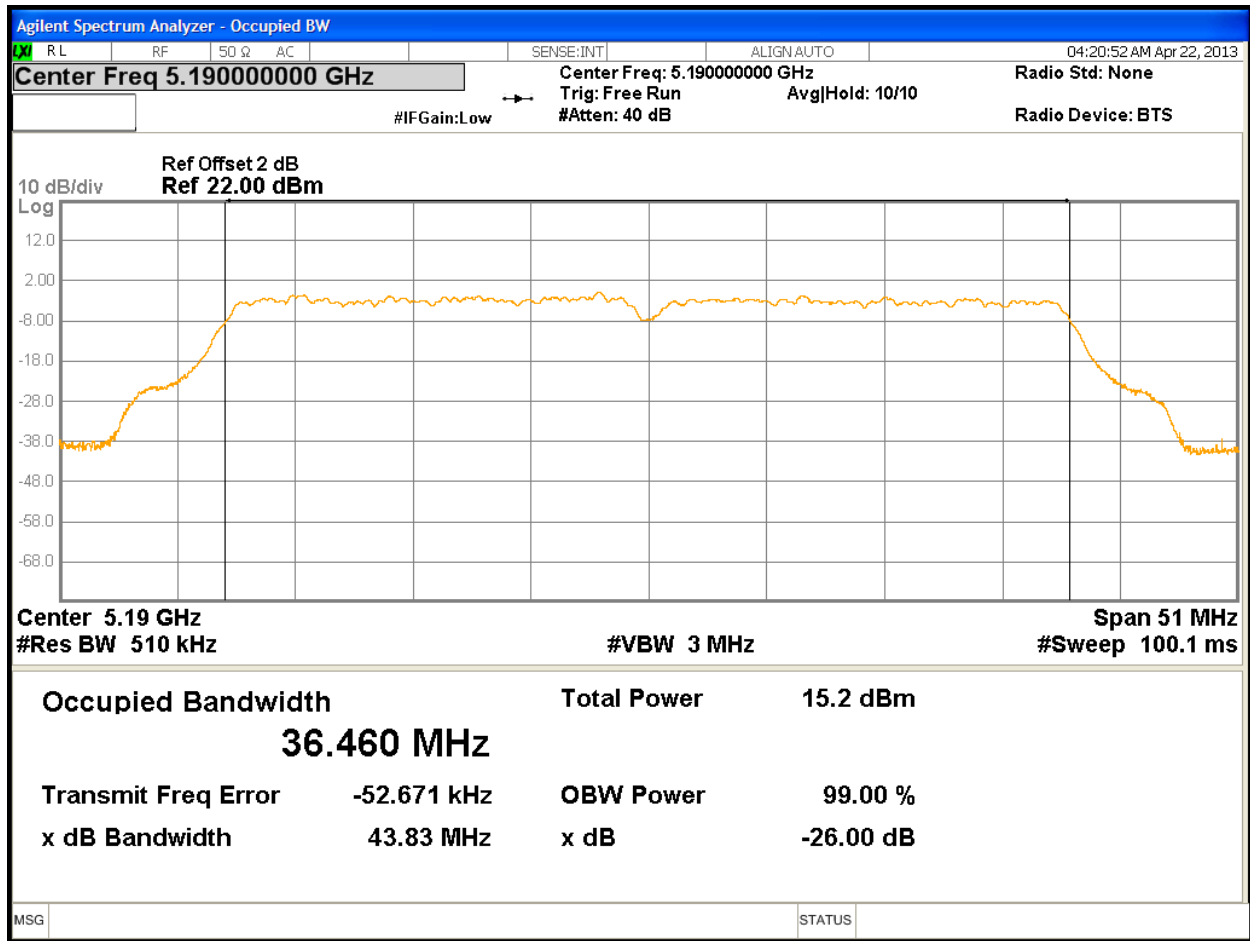

Figure 33: 26 dB and 99% Bandwidth at 5190 MHz, Chain 0

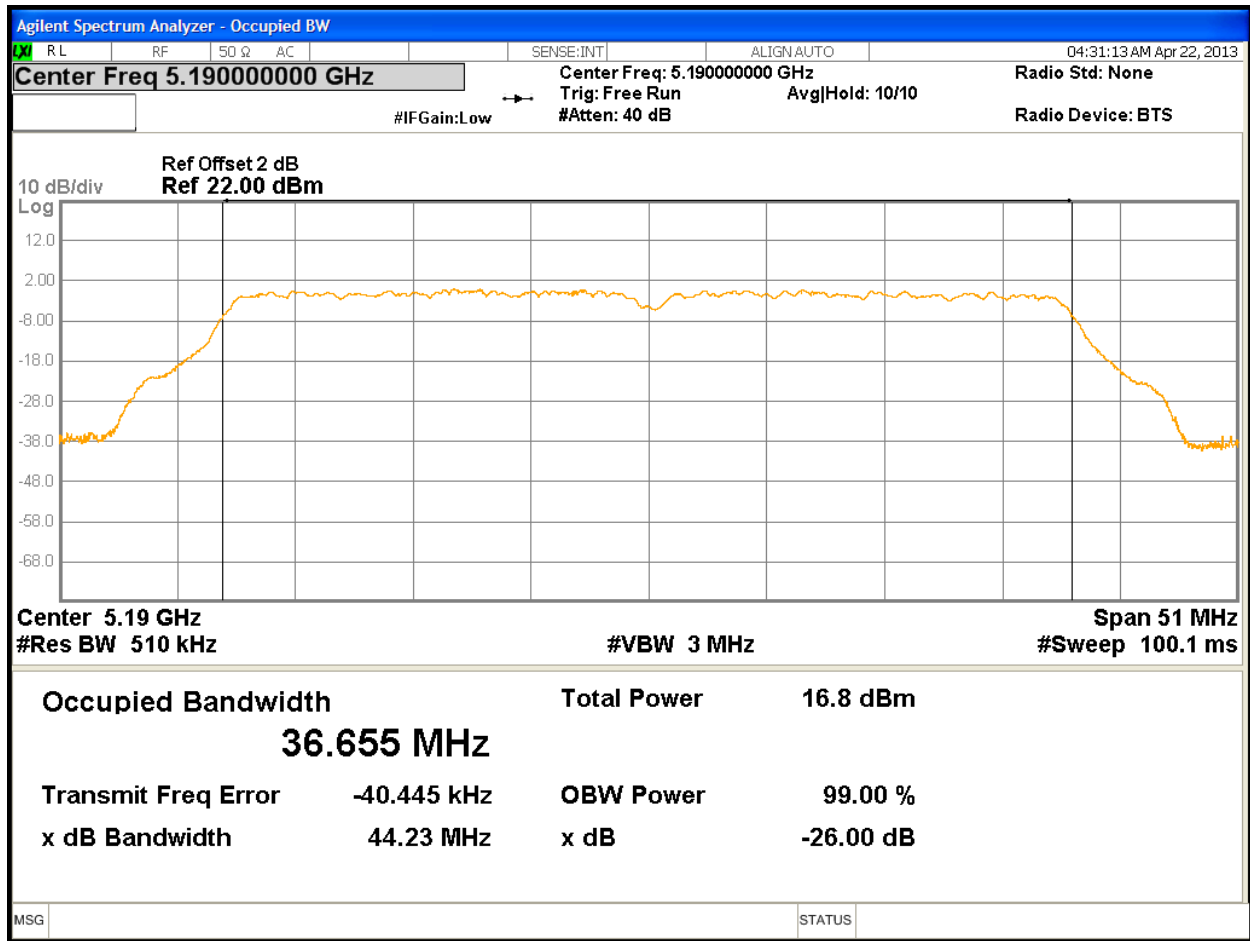

Figure 34: 26 dB and 99% Bandwidth at 5190 MHz, Chain 1

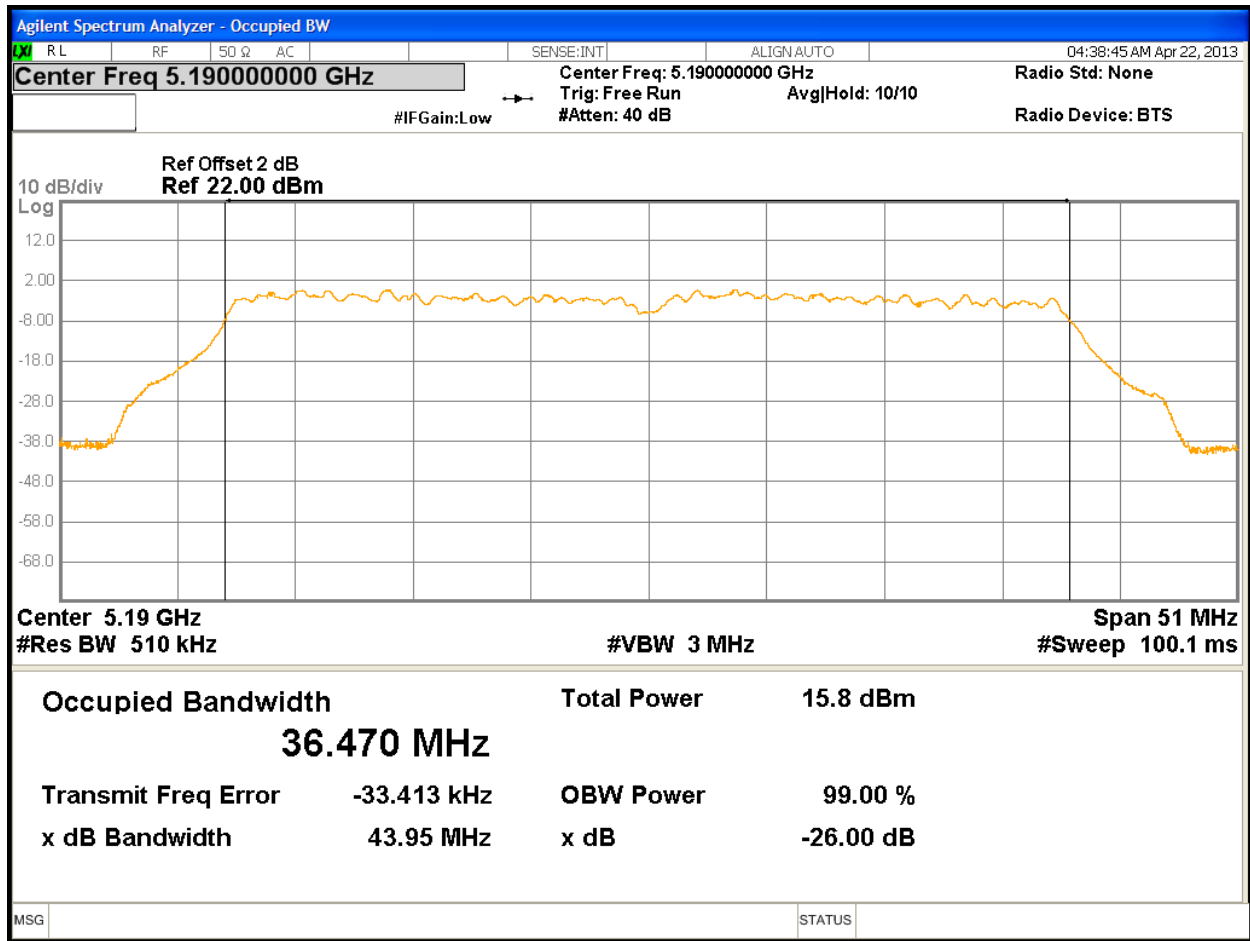

Figure 35: 26 dB and 99% Bandwidth at 5190 MHz, Chain 2

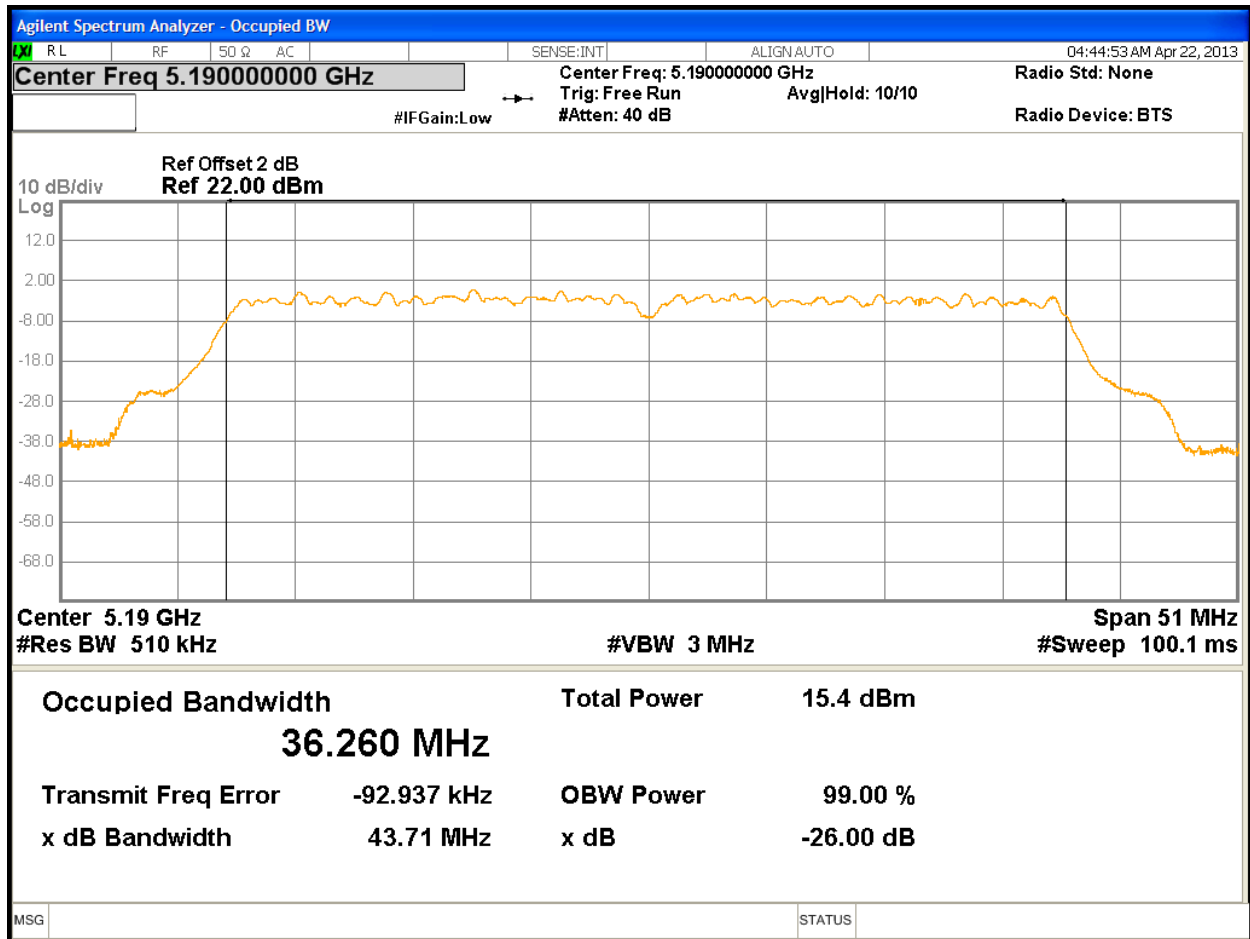

Figure 36: 26 dB and 99% Bandwidth at 5190 MHz, Chain 3

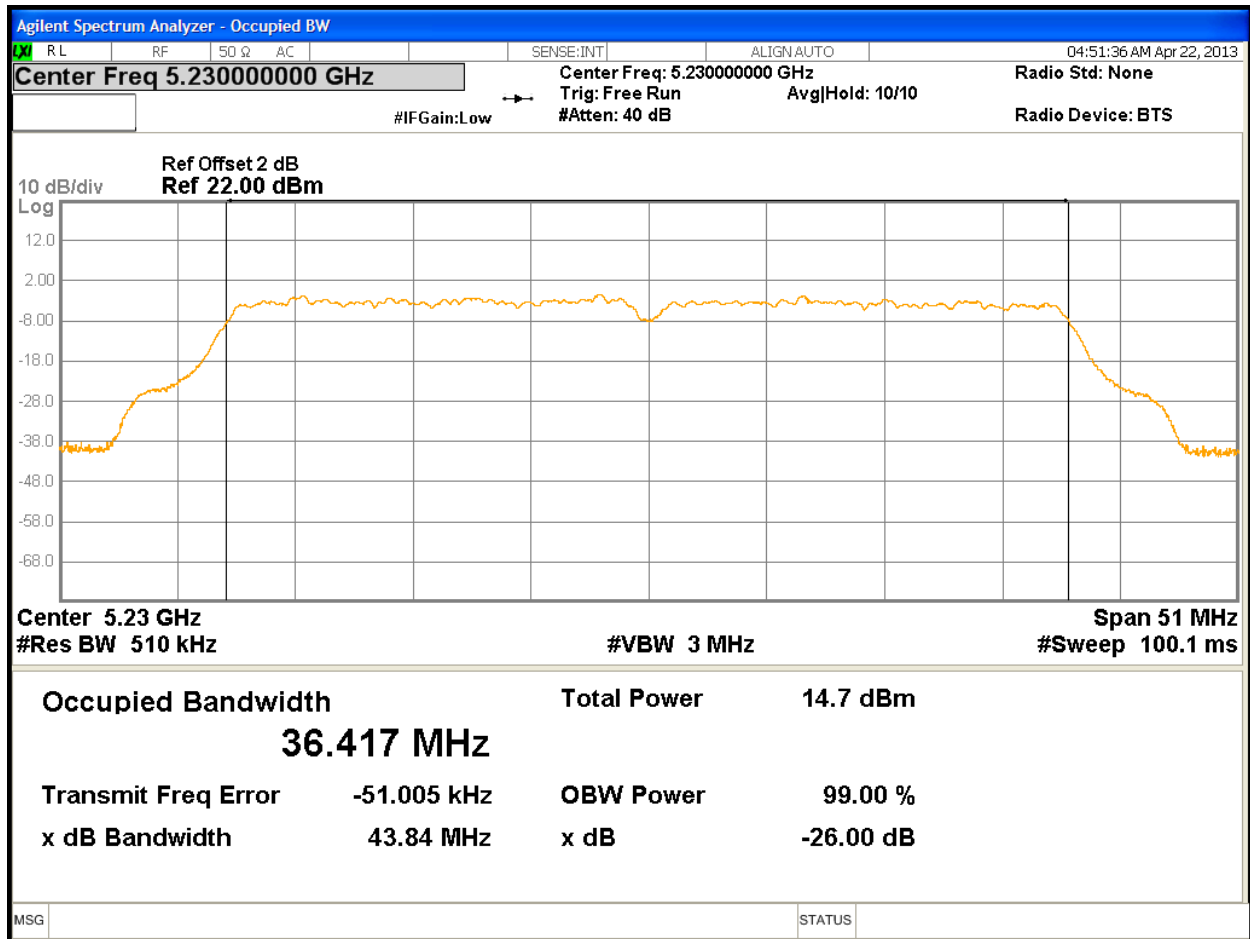

Figure 37: 26 dB and 99% Bandwidth at 5230 MHz, Chain 0

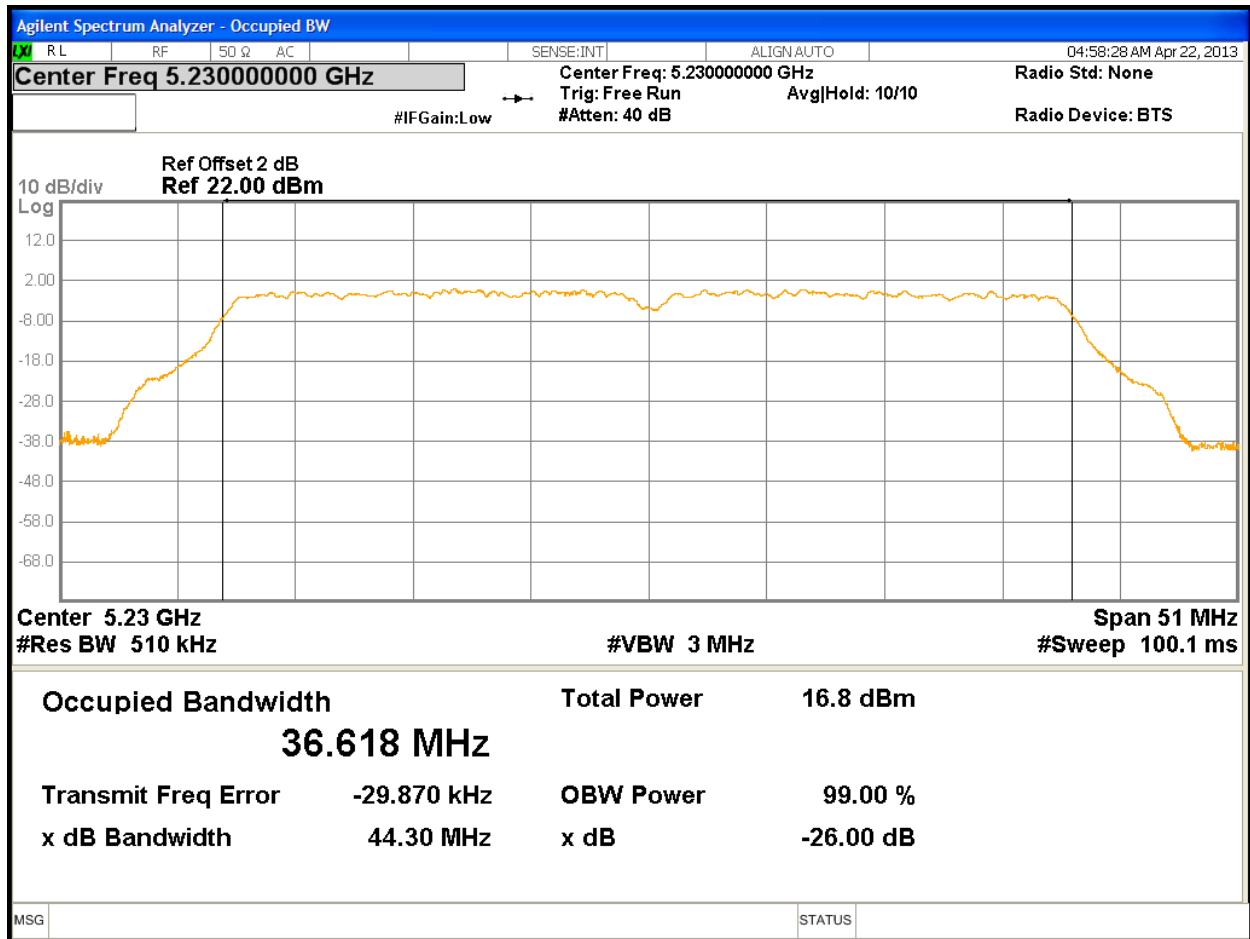

Figure 38: 26 dB and 99% Bandwidth at 5230 MHz, Chain 1

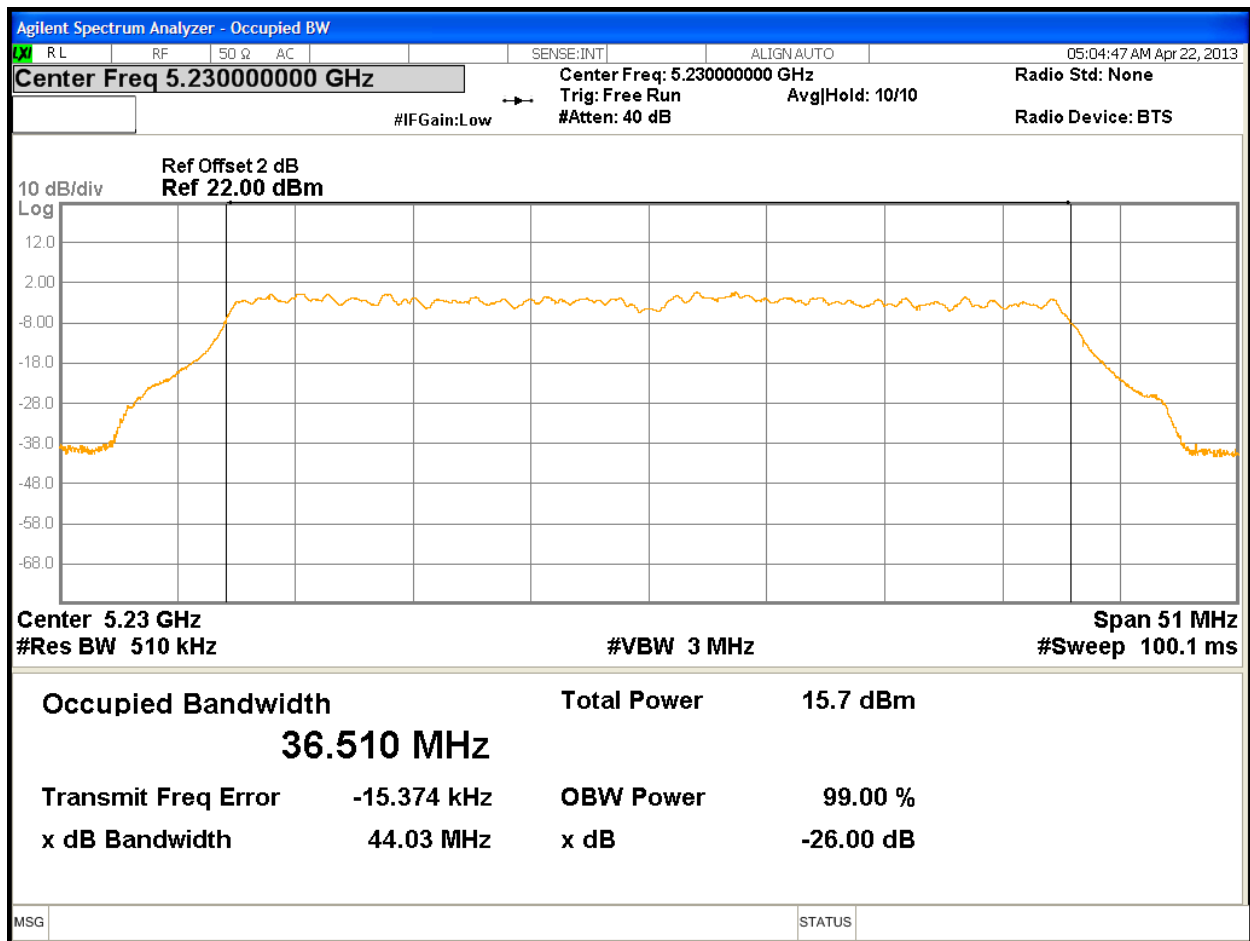

Figure 39: 26 dB and 99% Bandwidth at 5230 MHz, Chain 2

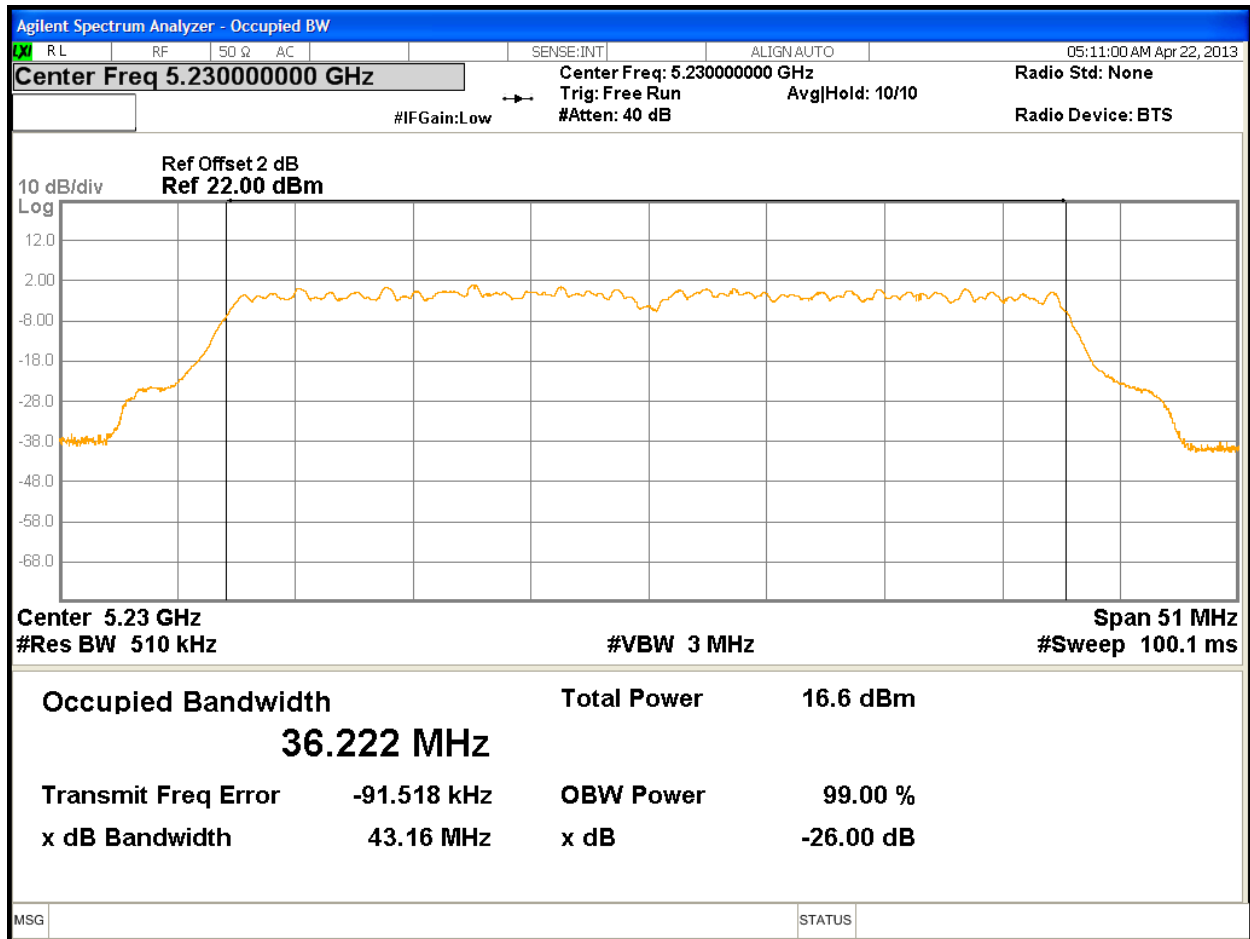

Figure 40: 26 dB and 99% Bandwidth at 5230 MHz, Chain 3

4.3 Peak Excursion

According to the CFR47 Part 15.407 (a)(6), the ratio of the peak excursion of the modulation envelope (measured using a peak hold function) to the maximum conducted output power shall not exceed 13 dB across any 1 MHz bandwidth or the emission bandwidth whichever is less.

4.3.1 Test Method

The ANSI C63.10-2009 Section 6.10.4 conducted method was used to measure the peak excursion.

The measurement was performed with modulation per CFR47 Part 15.407 (a) (6). This test was conducted on 3 channels in each operating frequency range of 5150 MHz to 5250 MHz. The worst sample result indicated below.

Test Setup:

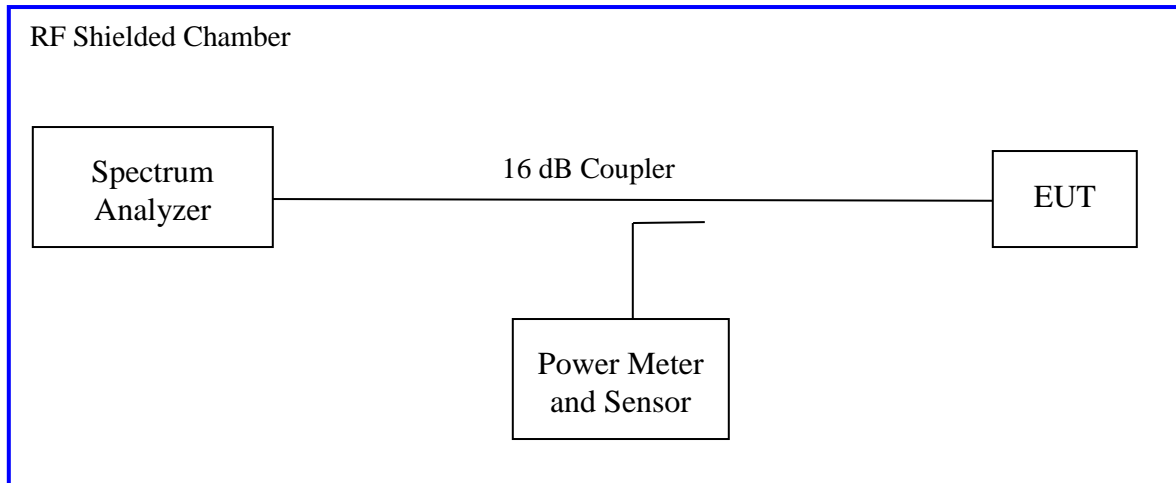

4.3.2 Results

As originally tested, the EUT was found to be compliant to the requirements of the test standard(s).

Table 5: Peak Excursion – Test Results

Test Conditions: Conducted Measurement, Normal Temperature						
Antenna Type: Integrated			Power Setting: see test plan			
Max. Directional Gain: + 8 dBi			Signal State: Modulated at 100%.			
Ambient Temp.: 23° C			Relative Humidity: 32%			
802.11n (HT20) Mode						
Operating Channel	Limit [dB]	Ch0 [dB]	Ch1 [dB]	Ch2 [dB]	Ch3 [dB]	Margin [dB]
5180	13.0	7.58	7.58	7.80	7.81	-5.19
5200	13.0	7.48	7.67	7.72	8.27	-4.73
5240	13.0	7.17	7.42	8.29	8.36	-4.64
Note: The peak excursion was observed at HT20 6.5 Mbps per Data Stream.						
802.11n (HT40) Mode						
Operating Channel	Limit [dB]	Ch0 [dB]	Ch1 [dB]	Ch2 [dB]	Ch3 [dB]	Margin [dB]
5190	13.0	7.19	7.21	7.61	7.75	-5.25
5230	13.0	7.33	7.10	7.32	8.41	-4.59
Note: The peak excursion was observed at HT40 13.5 Mbps per Data Stream						

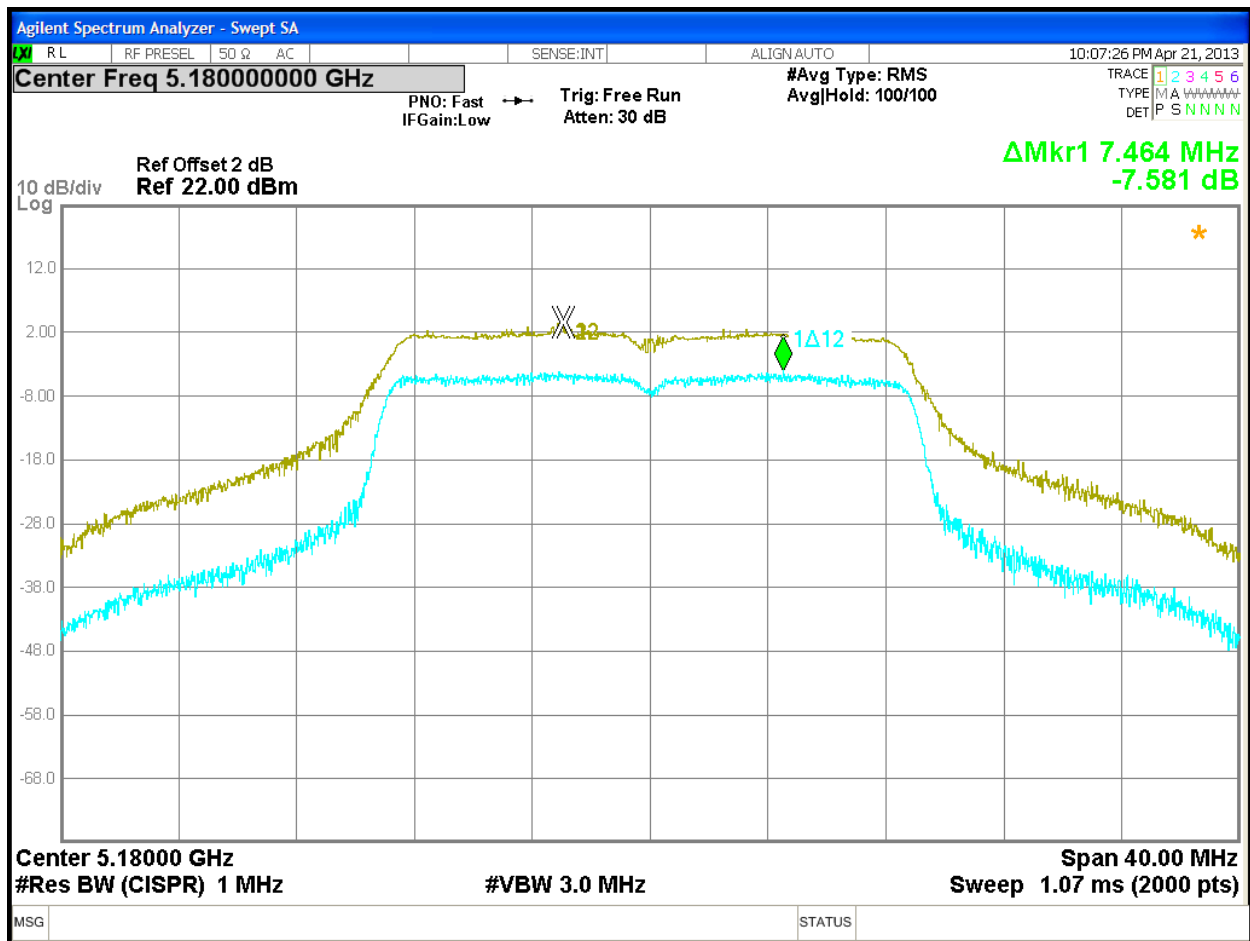

Figure 41: Peak Excursion, 5180 MHz at 802.11n, Chain 0 – 6.5 Mbps

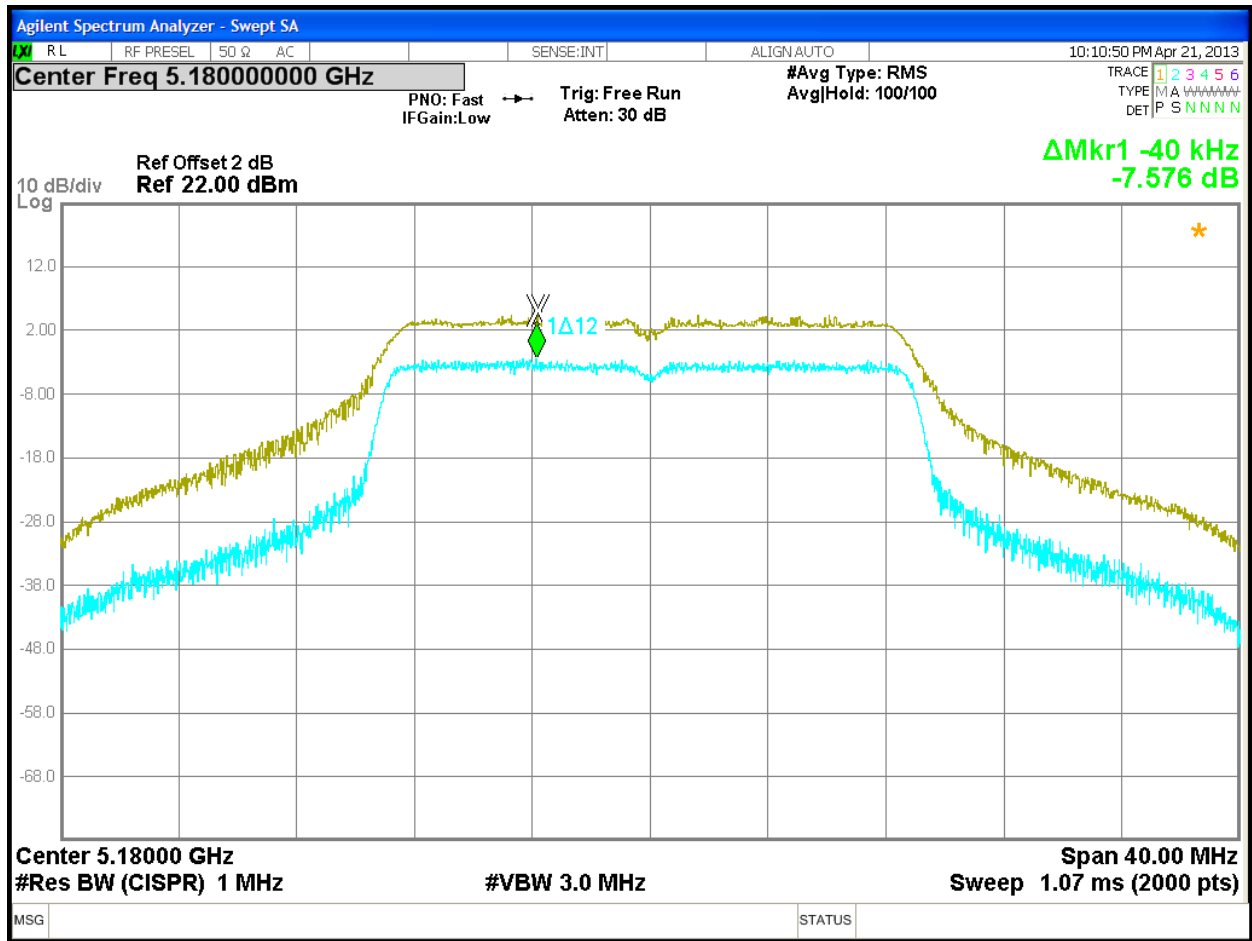

Figure 42: Peak Excursion, 5180 MHz at 802.11n, Chain 1 – 6.5 Mbps

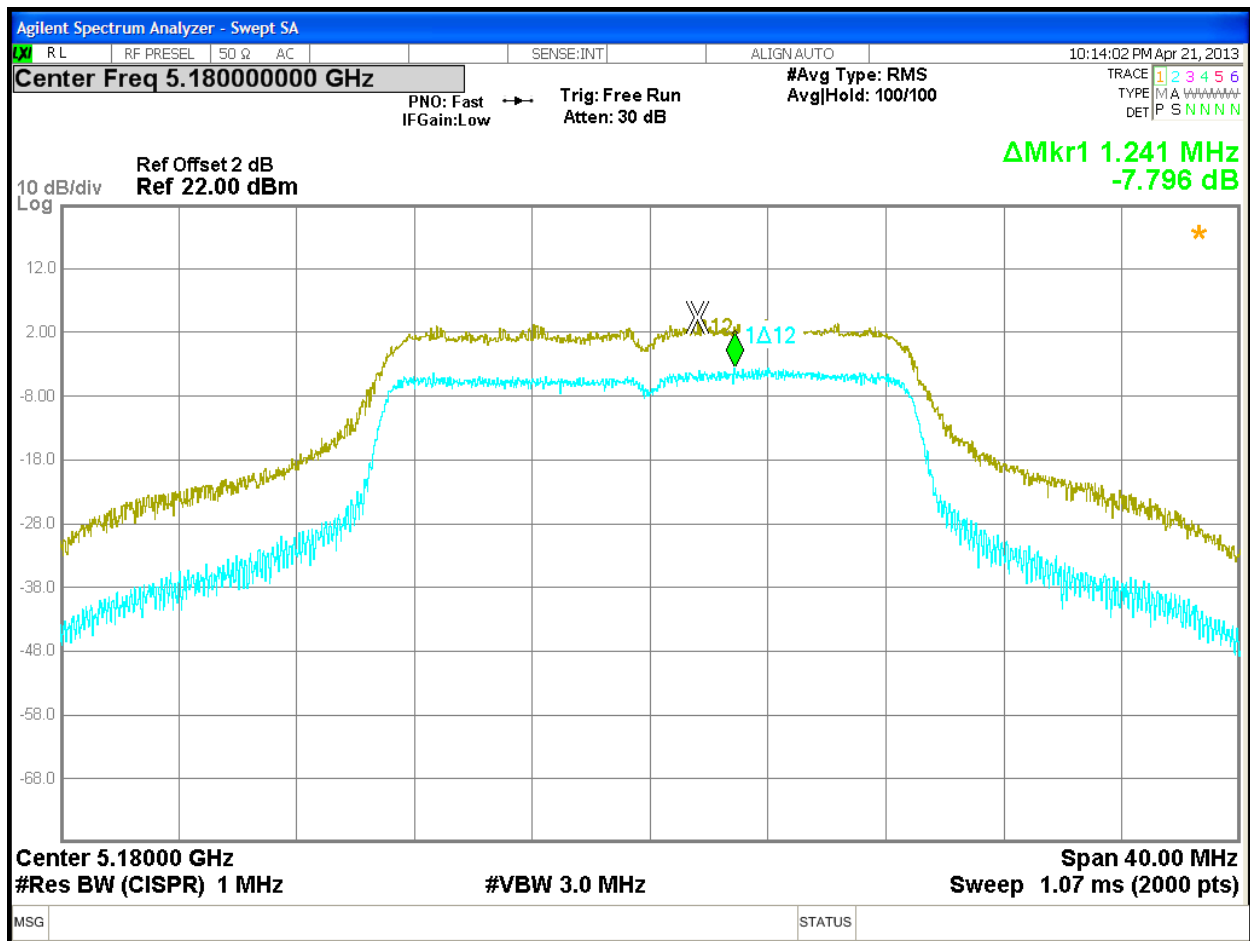

Figure 43: Peak Excursion, 5180 MHz at 802.11n, Chain 2 – 6.5 Mbps

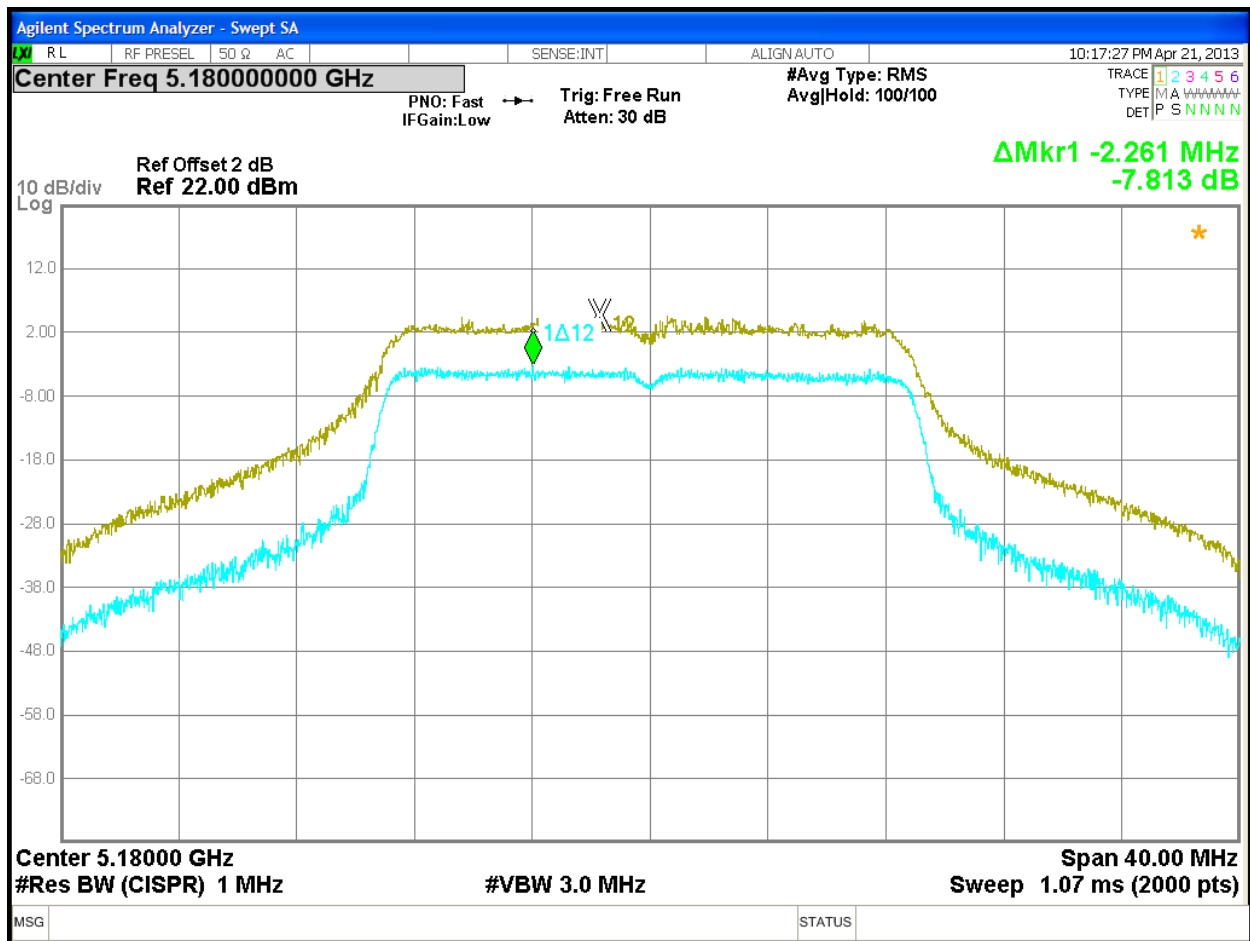

Figure 44: Peak Excursion, 5180 MHz at 802.11n, Chain 3 – 6.5 Mbps

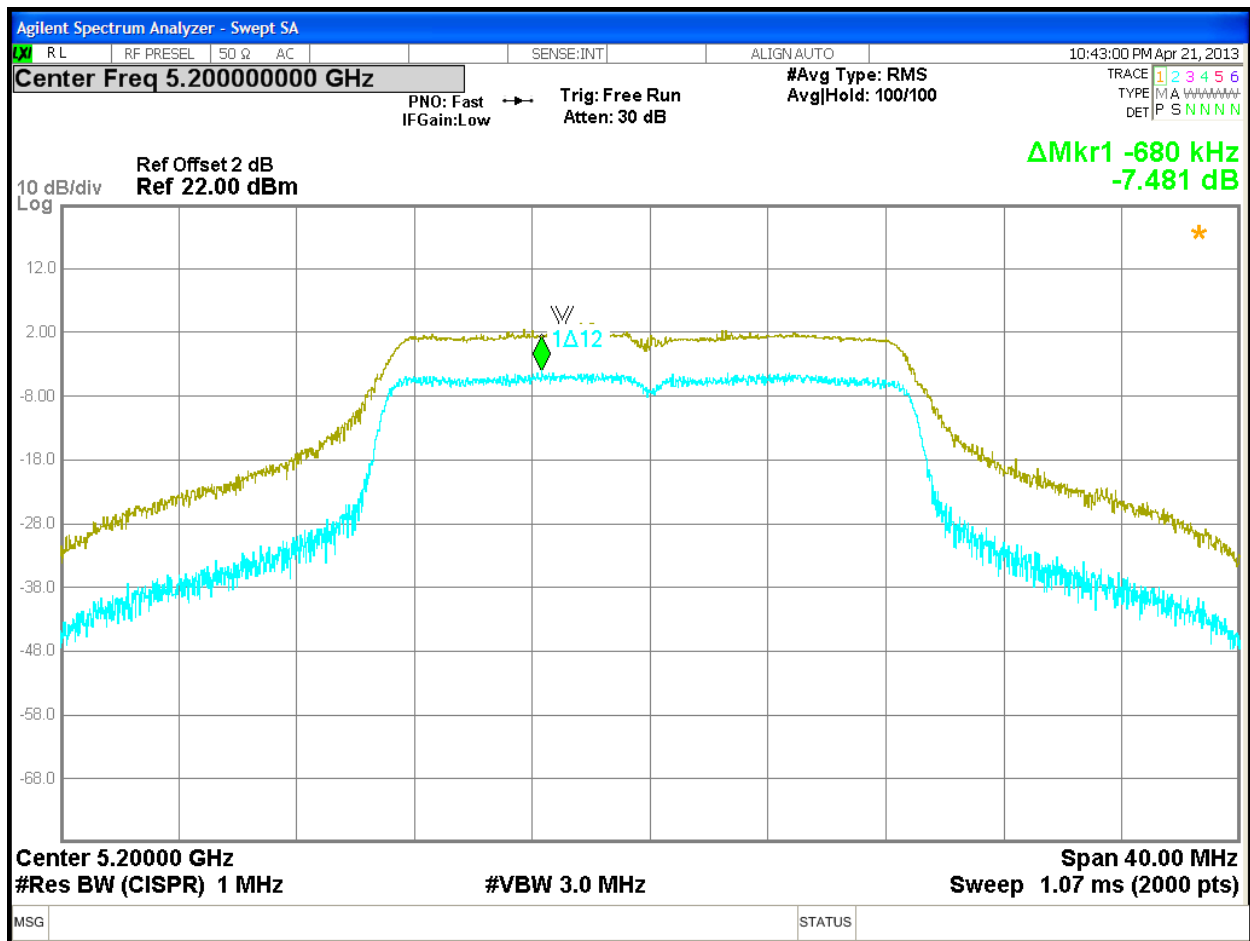

Figure 45: Peak Excursion, 5200 MHz at 802.11n, Chain 0 – 6.5 Mbps

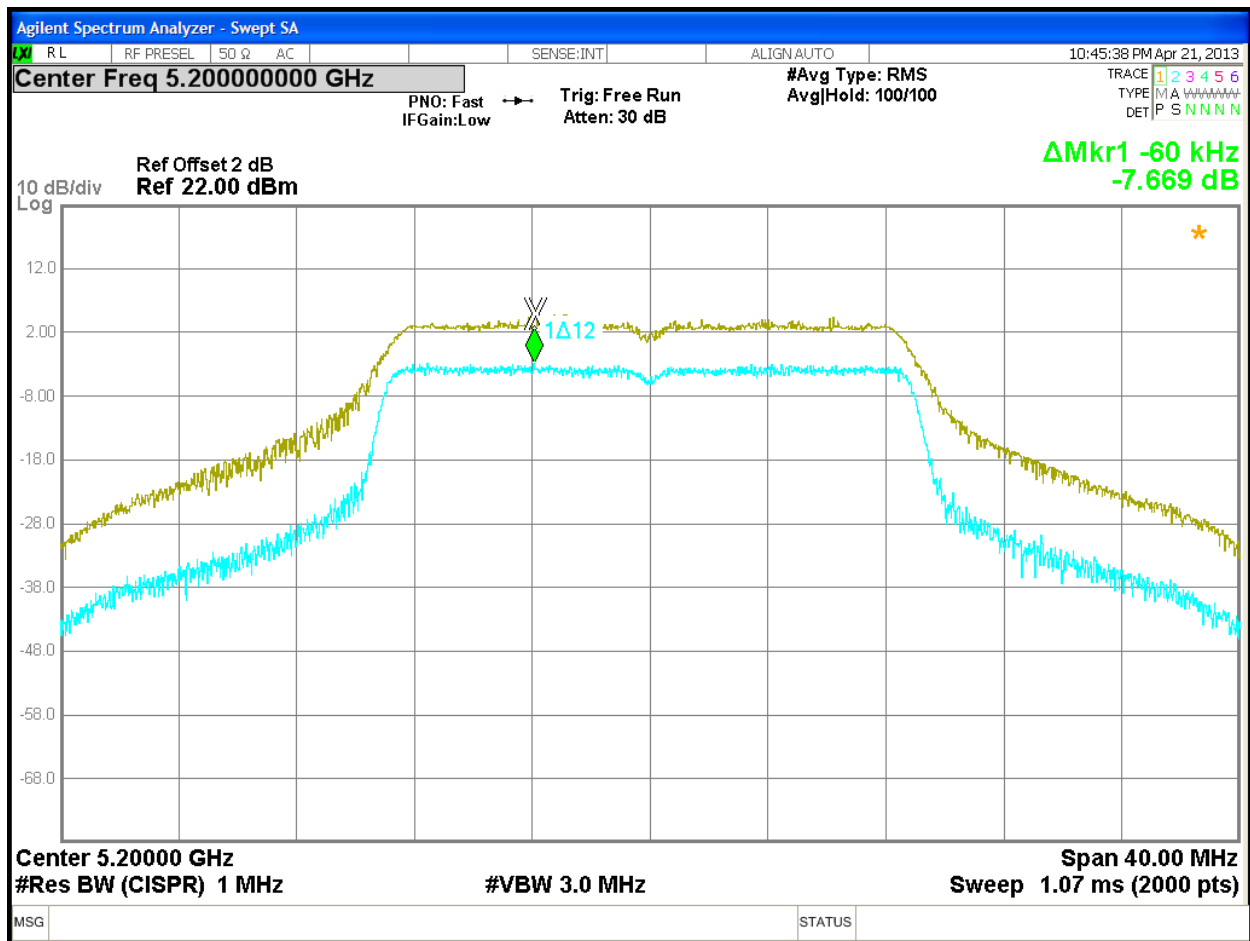

Figure 46: Peak Excursion, 5200 MHz at 802.11n, Chain 1 – 6.5 Mbps

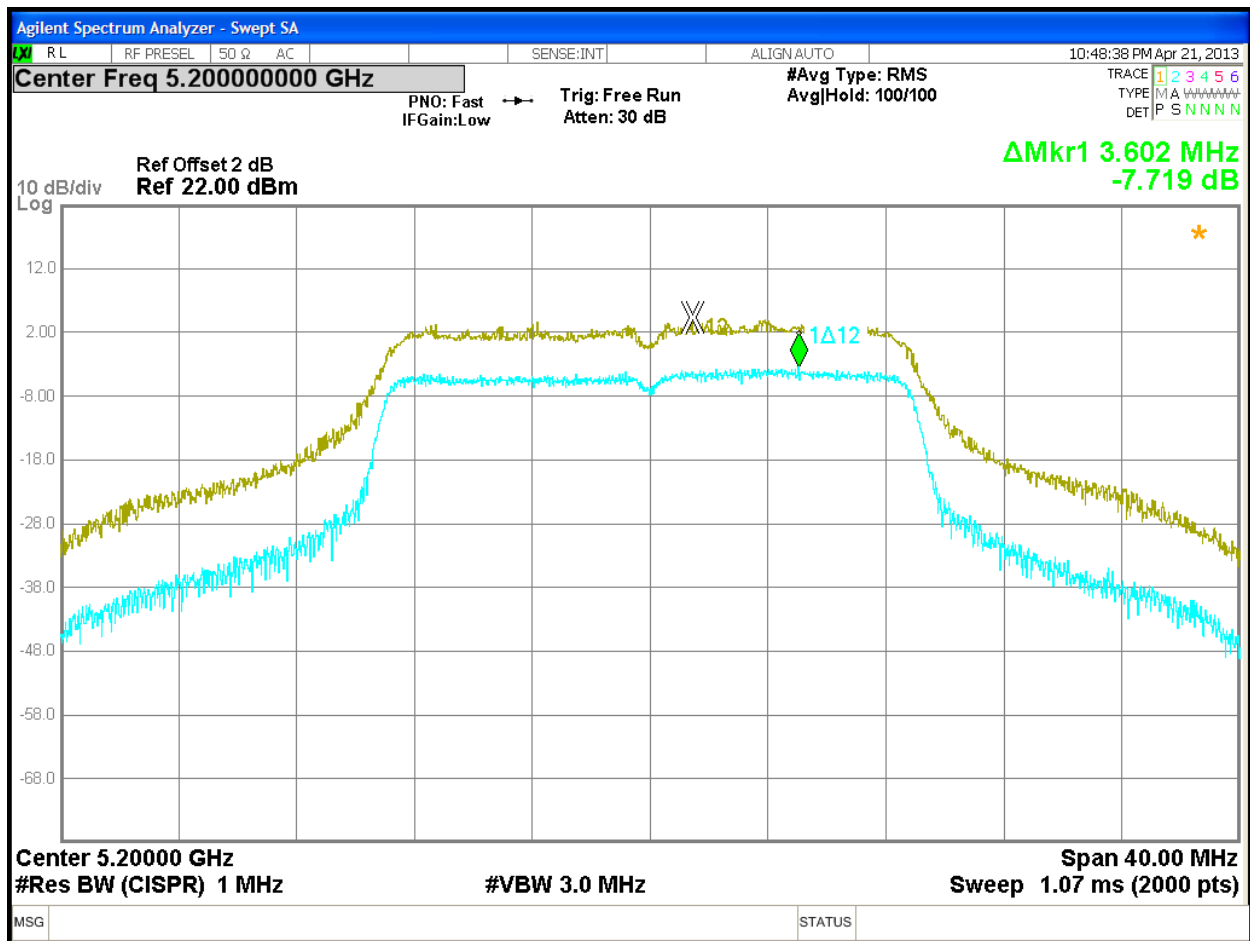

Figure 47: Peak Excursion, 5200 MHz at 802.11n, Chain 2 – 6.5 Mbps

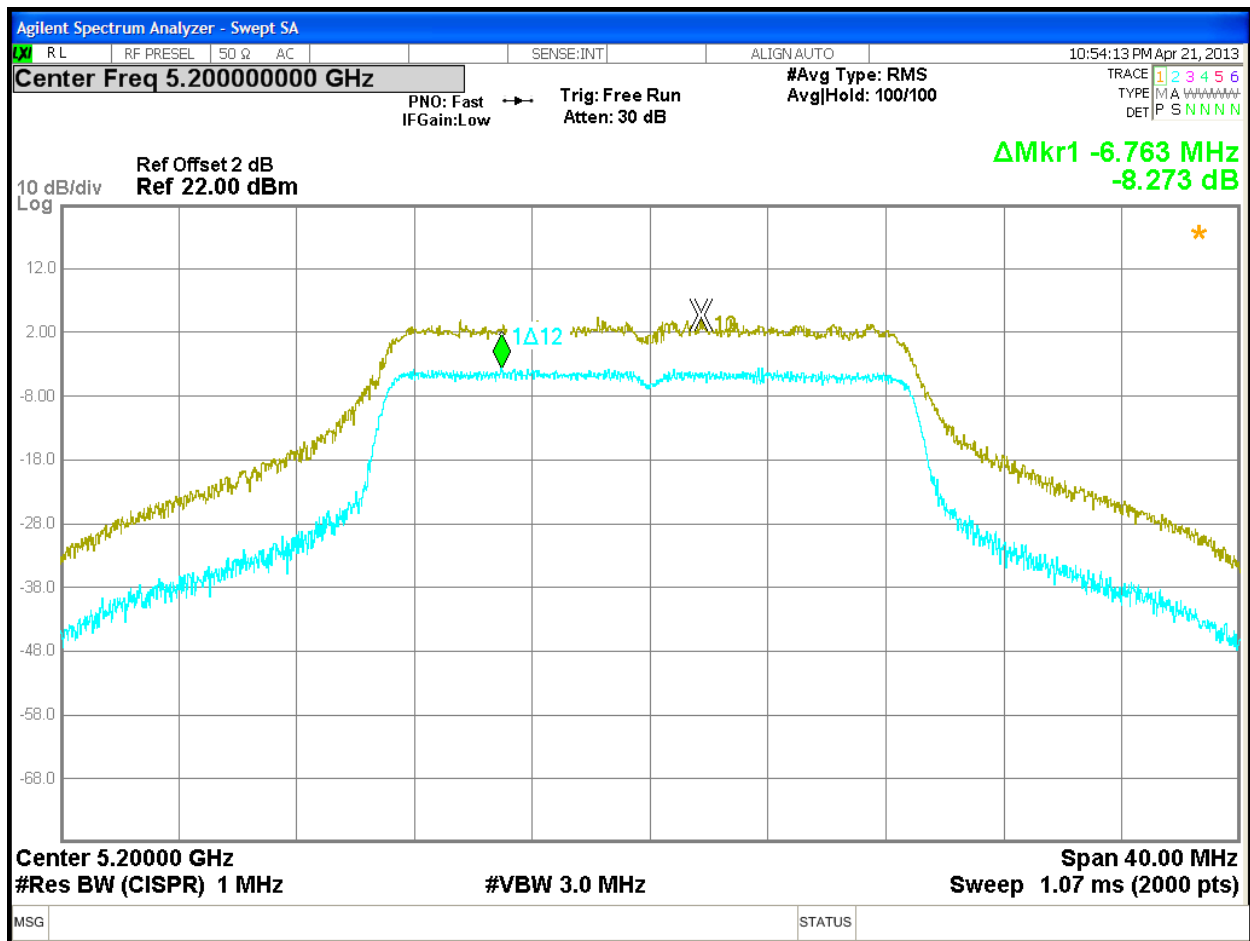

Figure 48: Peak Excursion, 5200 MHz at 802.11n, Chain 1 – 6.5 Mbps

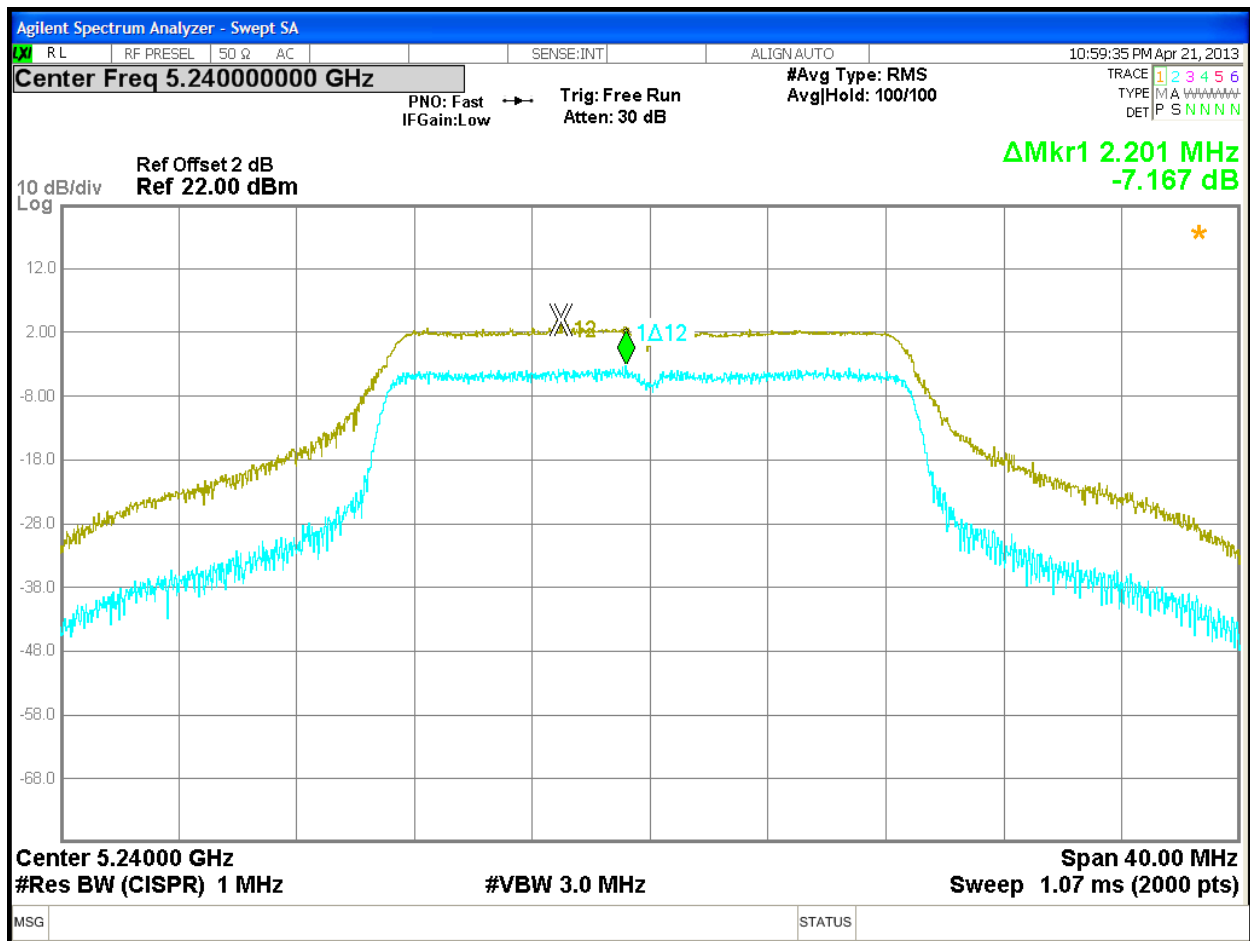

Figure 49: Peak Excursion, 5240 MHz at 802.11n, Chain 0 – 6.5 Mbps

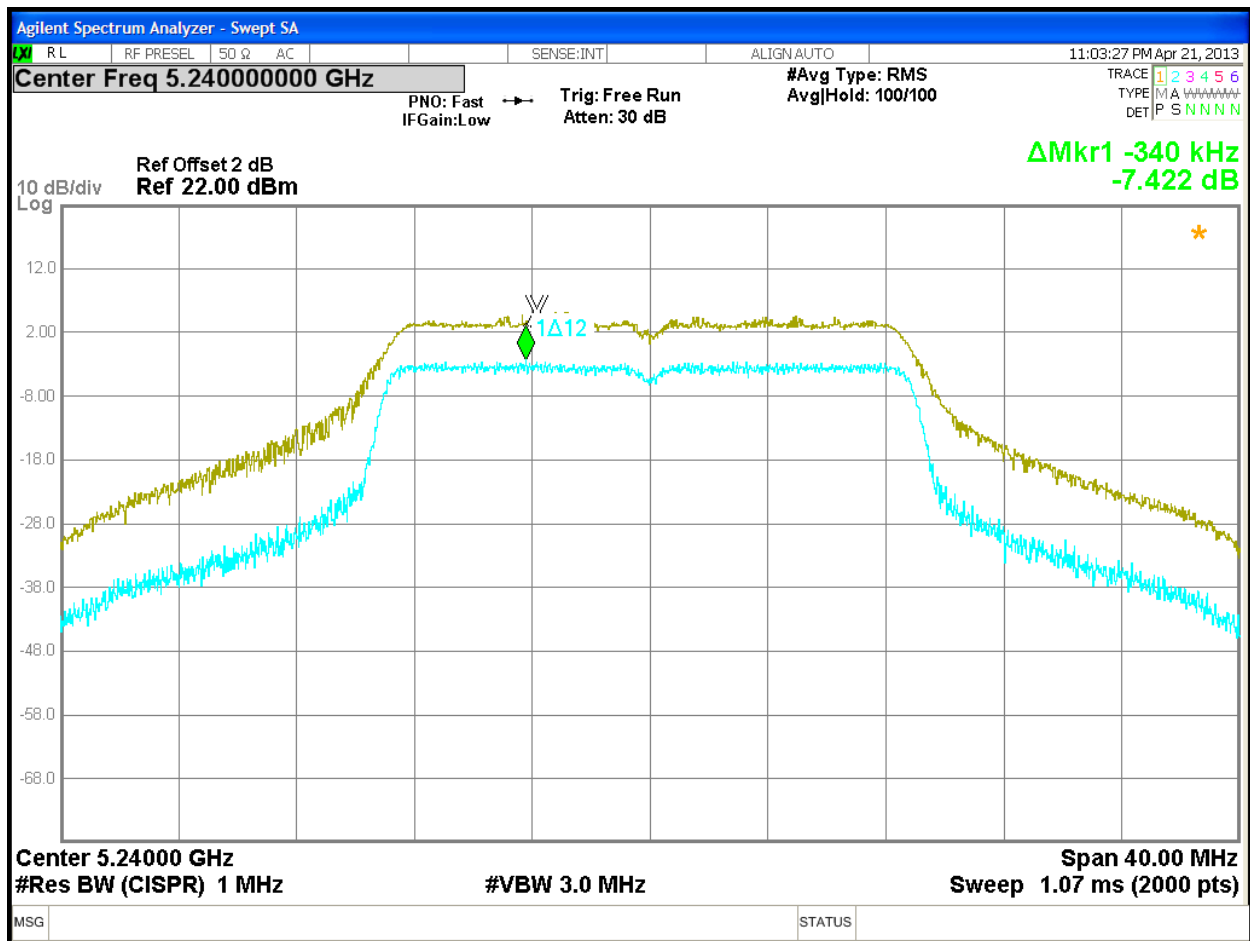

Figure 50: Peak Excursion, 5240 MHz at 802.11n, Chain 1 – 6.5 Mbps

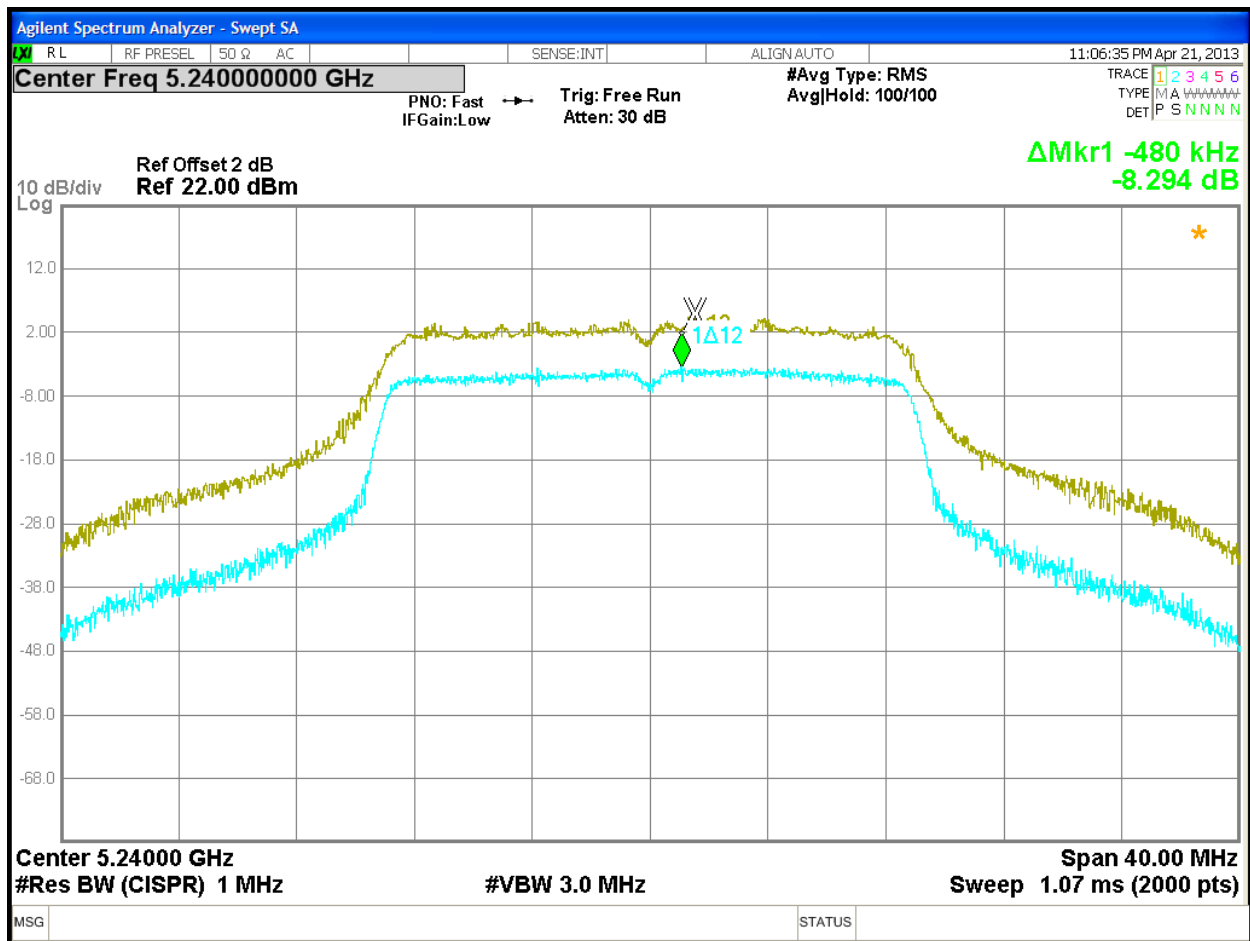

Figure 51: Peak Excursion, 5240 MHz at 802.11n, Chain 2 – 6.5 Mbps

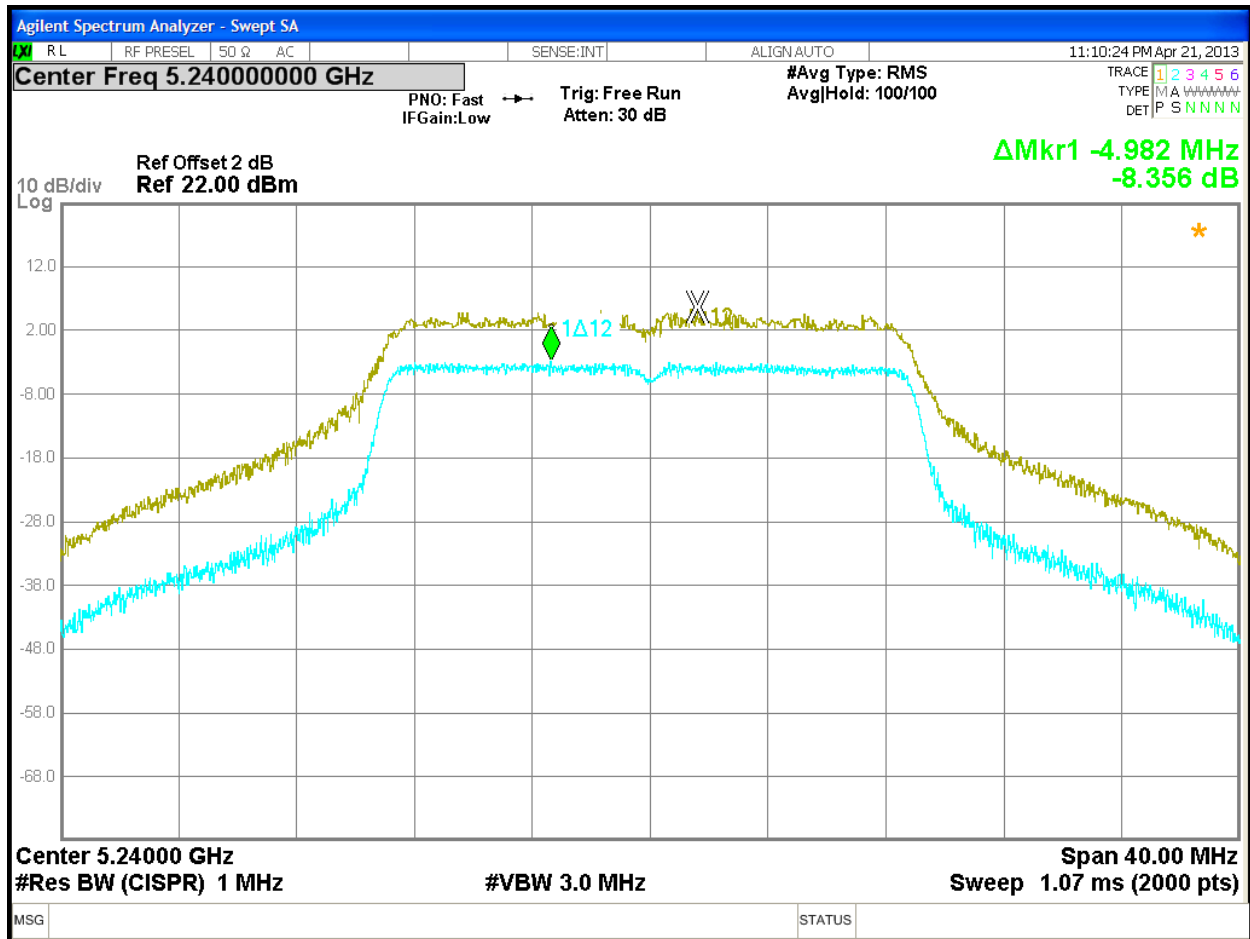

Figure 52: Peak Excursion, 5240 MHz at 802.11n, Chain 3 – 6.5 Mbps

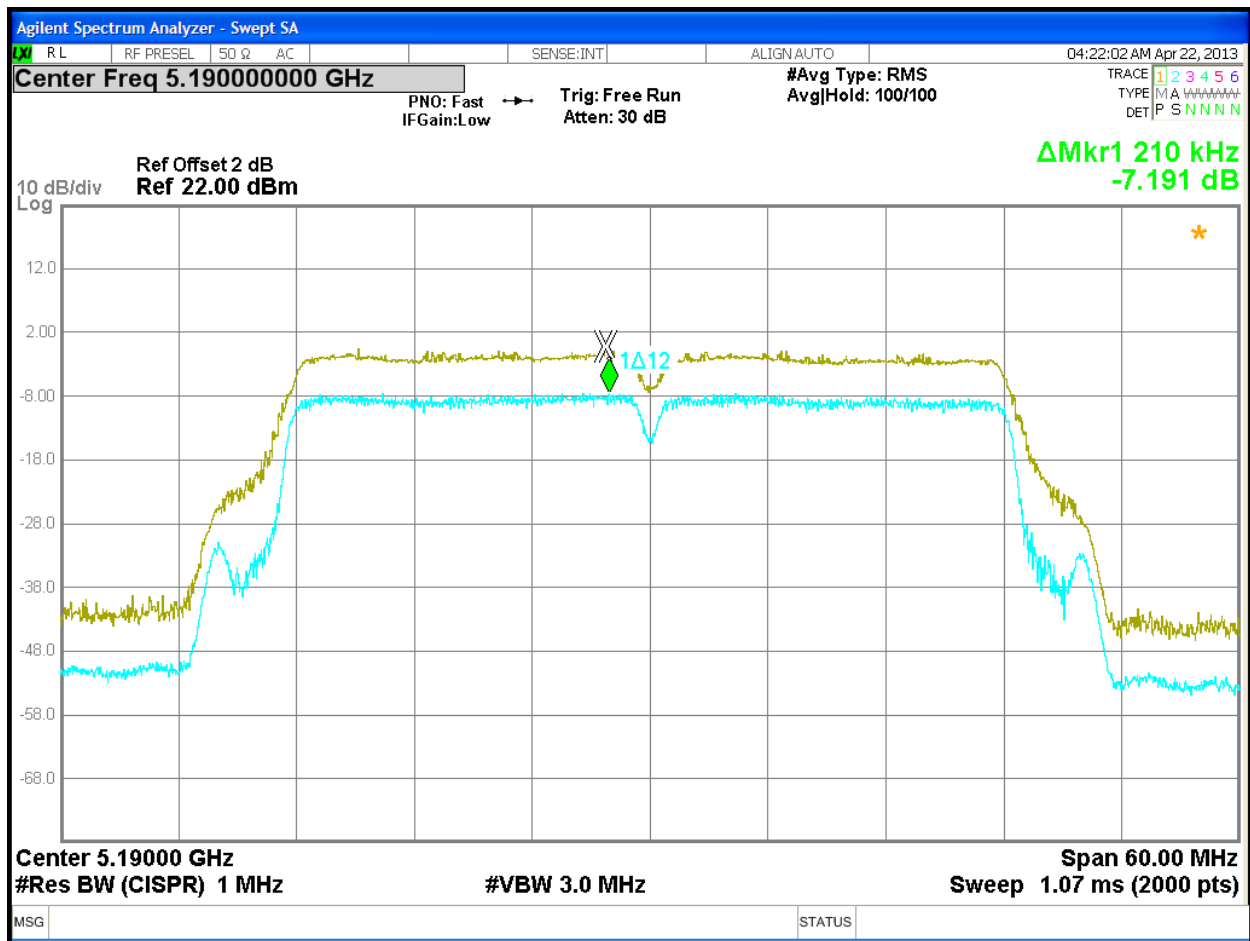

Figure 53: Peak Excursion, 5190 MHz at 802.11n, Chain 0 – 13.5 Mbps

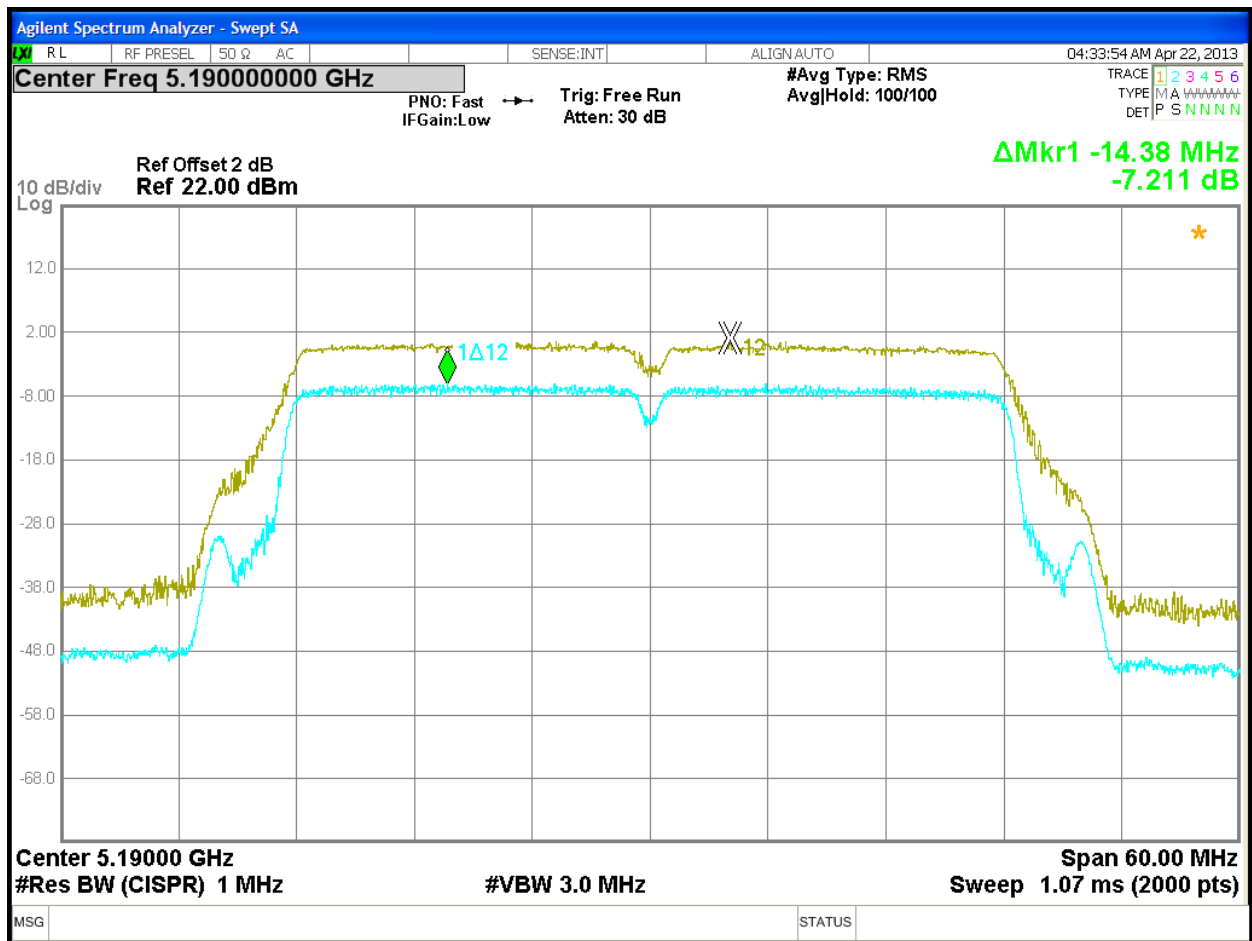

Figure 54: Peak Excursion, 5190 MHz at 802.11n, Chain 1 – 13.5 Mbps

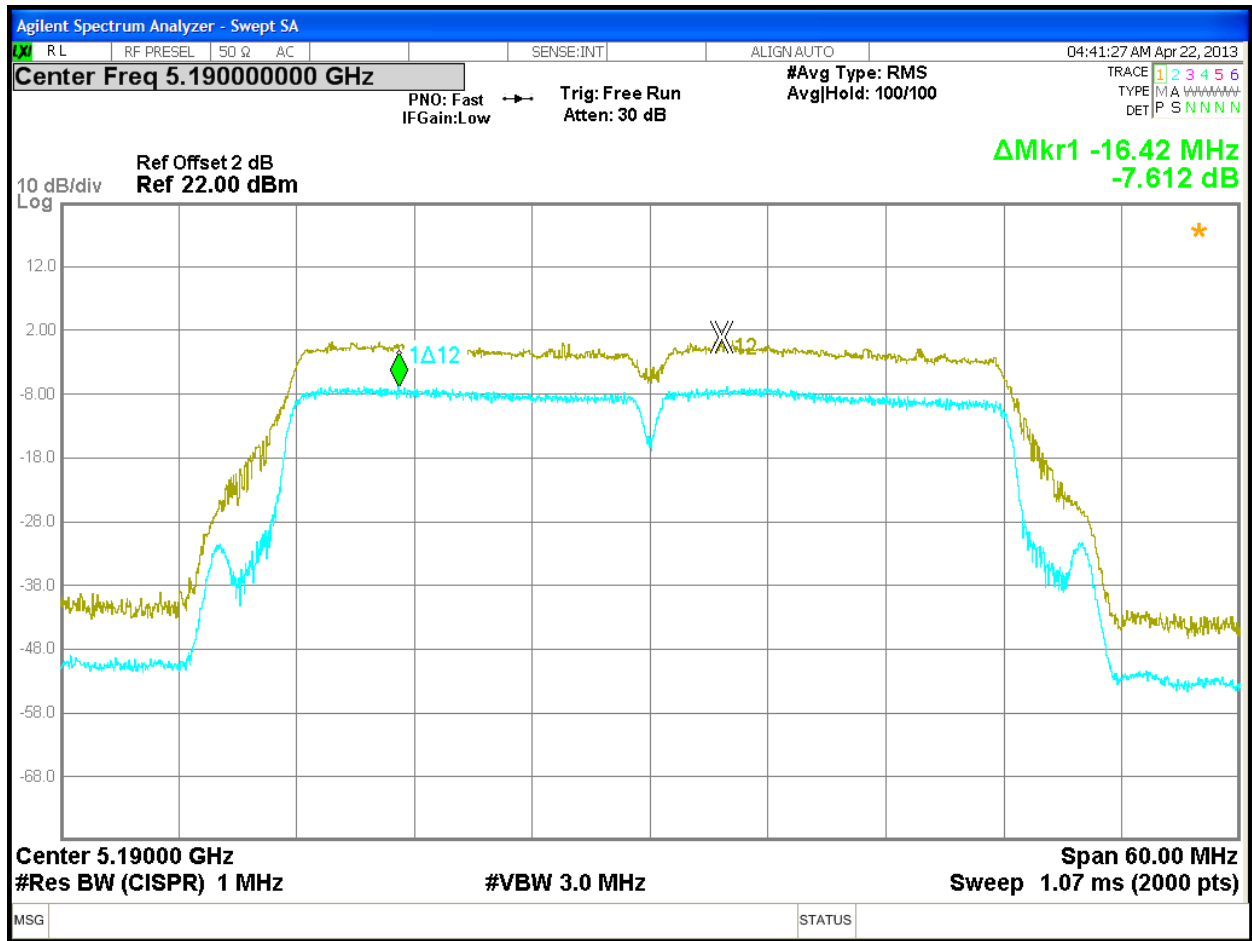

Figure 55: Peak Excursion, 5190 MHz at 802.11n, Chain 2 – 13.5 Mbps

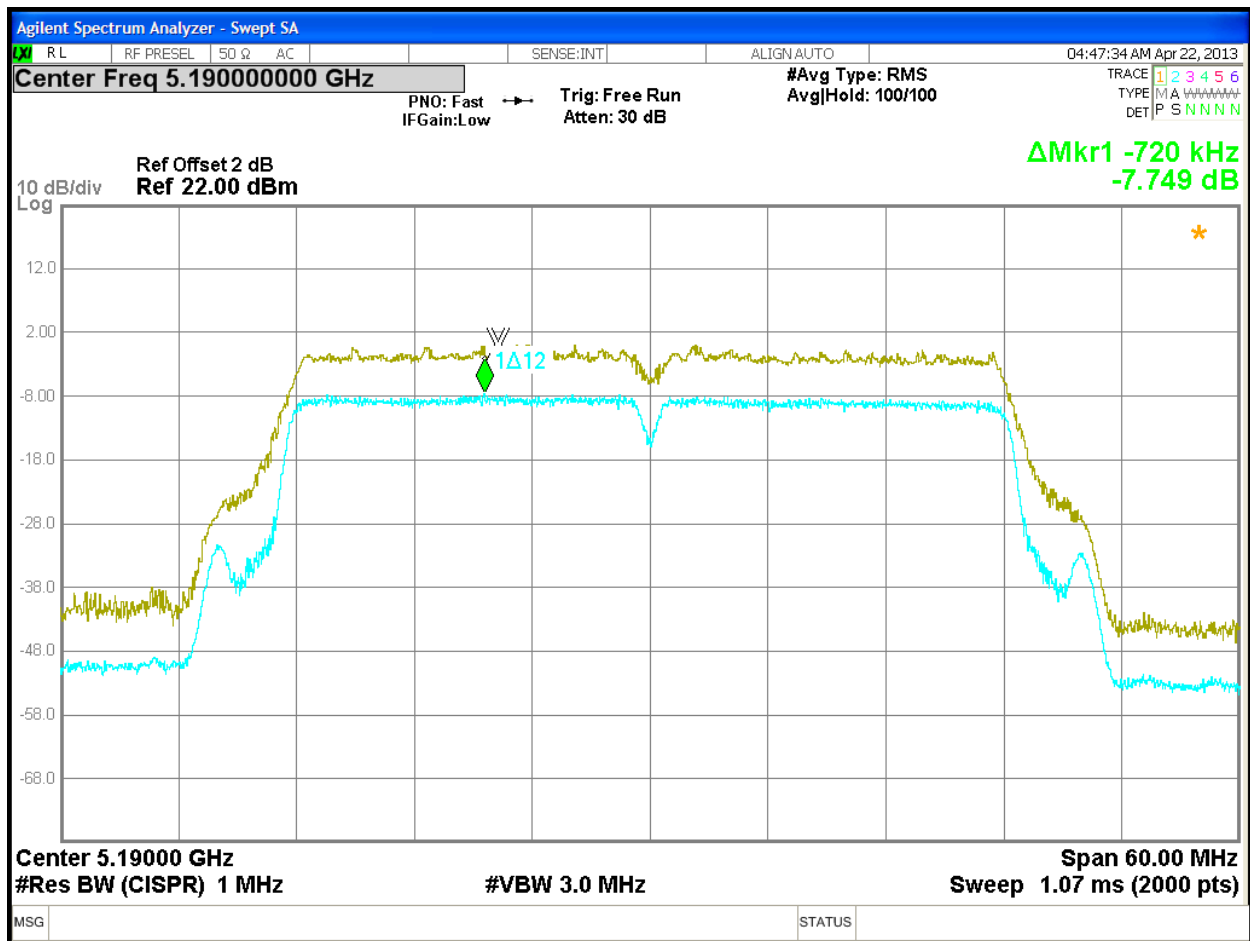

Figure 56: Peak Excursion, 5190 MHz at 802.11n, Chain 3 – 13.5 Mbps

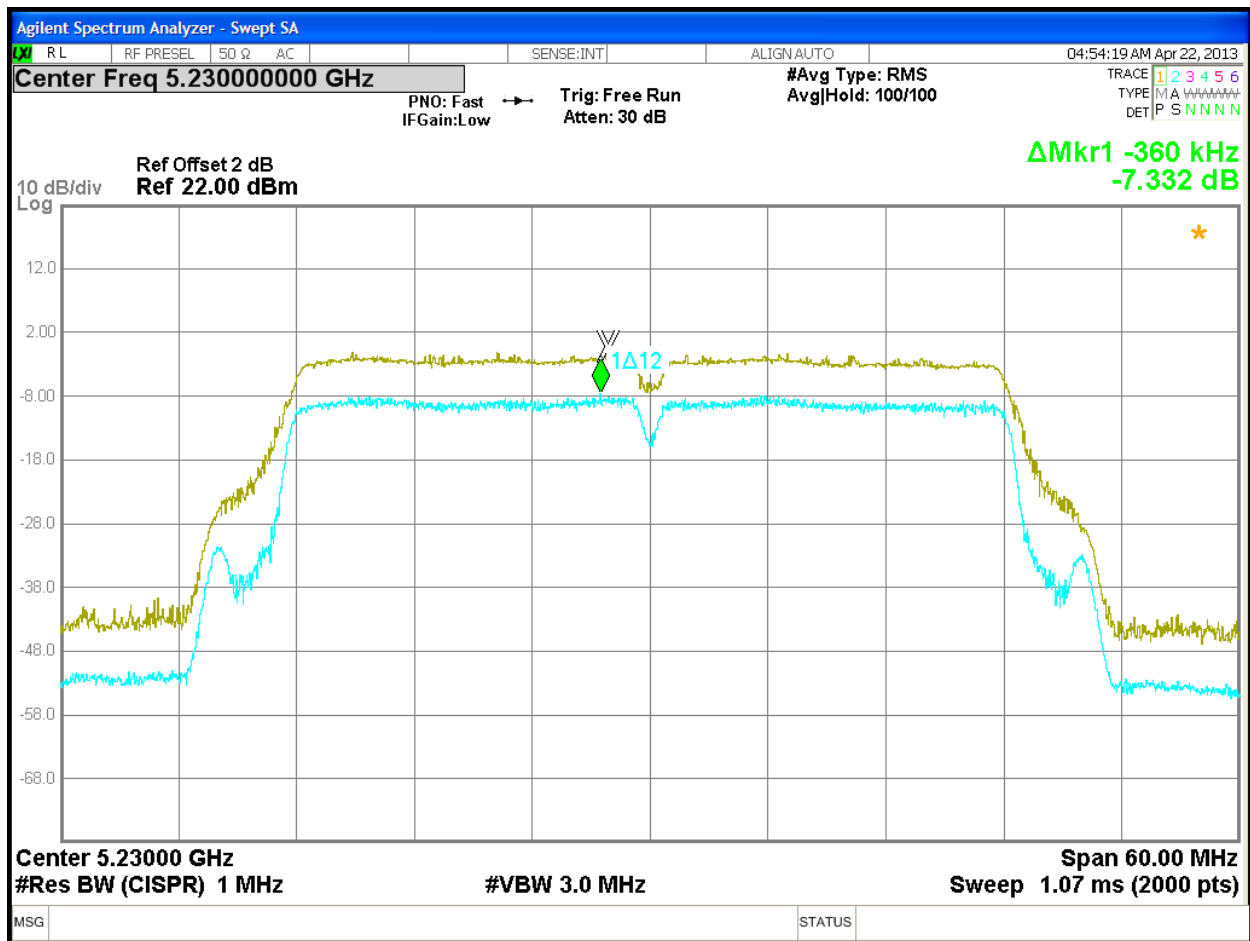

Figure 57: Peak Excursion, 5230 MHz at 802.11n, Chain 0 – 13.5 Mbps

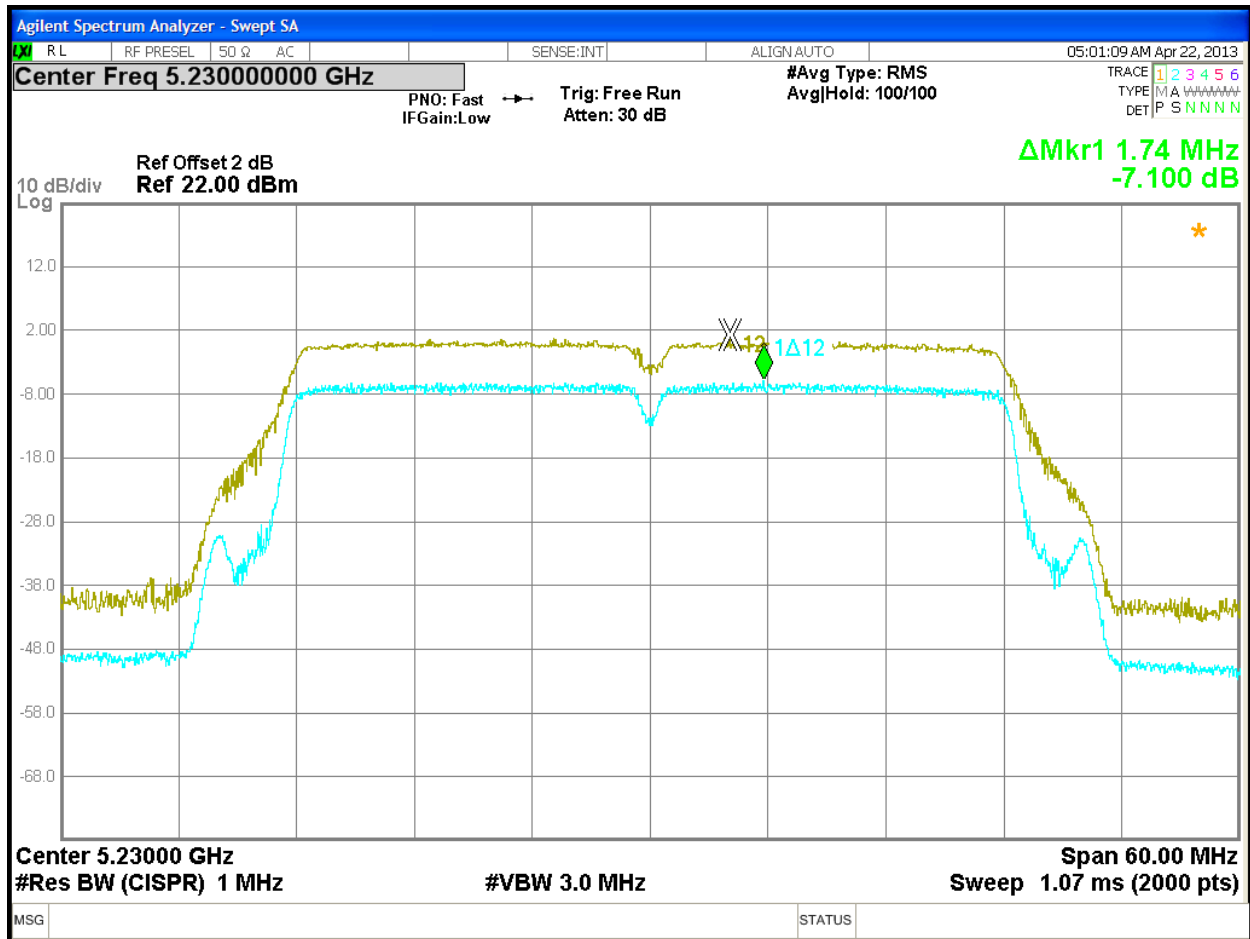

Figure 58: Peak Excursion, 5230 MHz at 802.11n, Chain 1 – 13.5 Mbps

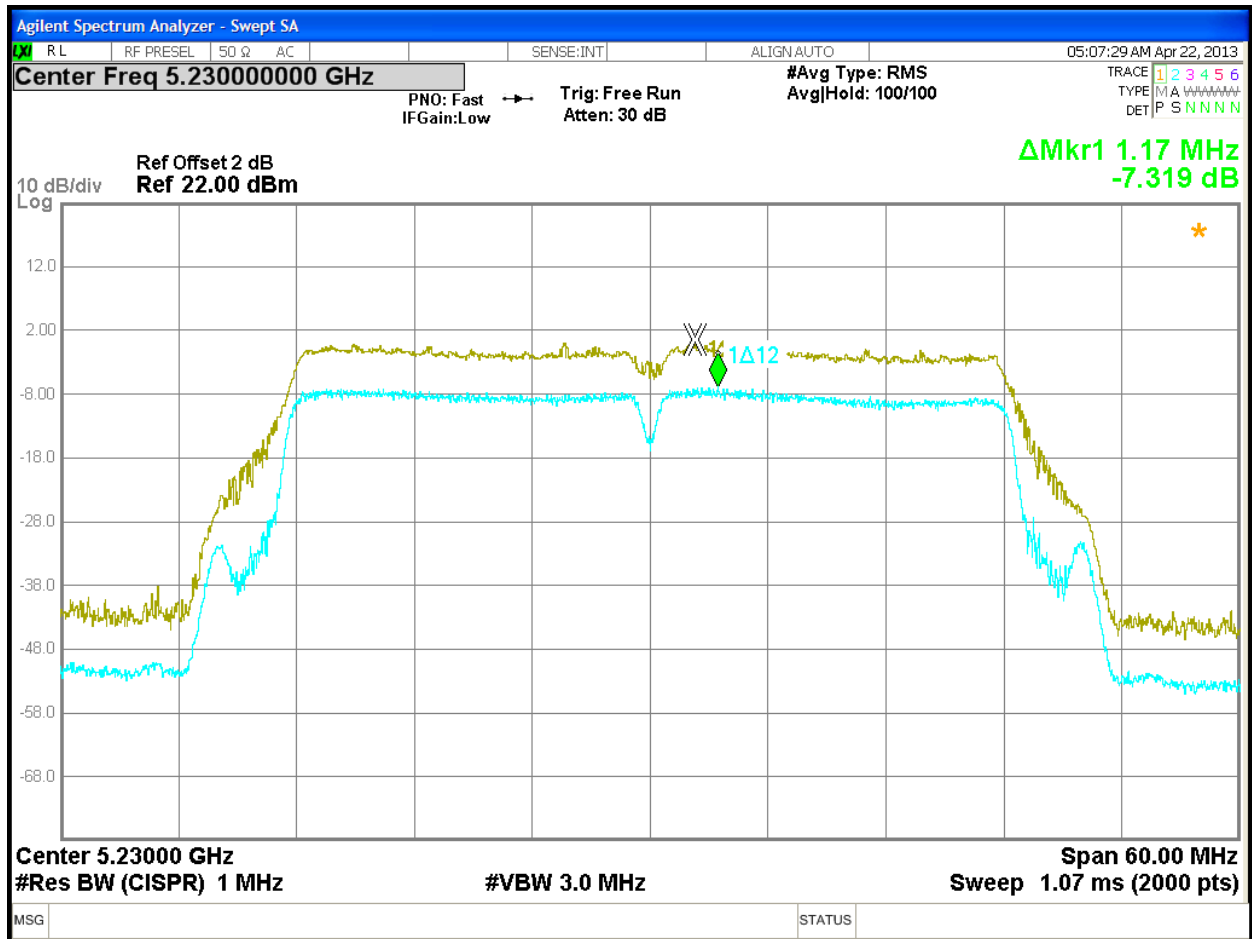

Figure 59: Peak Excursion, 5230 MHz at 802.11n, Chain 2 – 13.5 Mbps

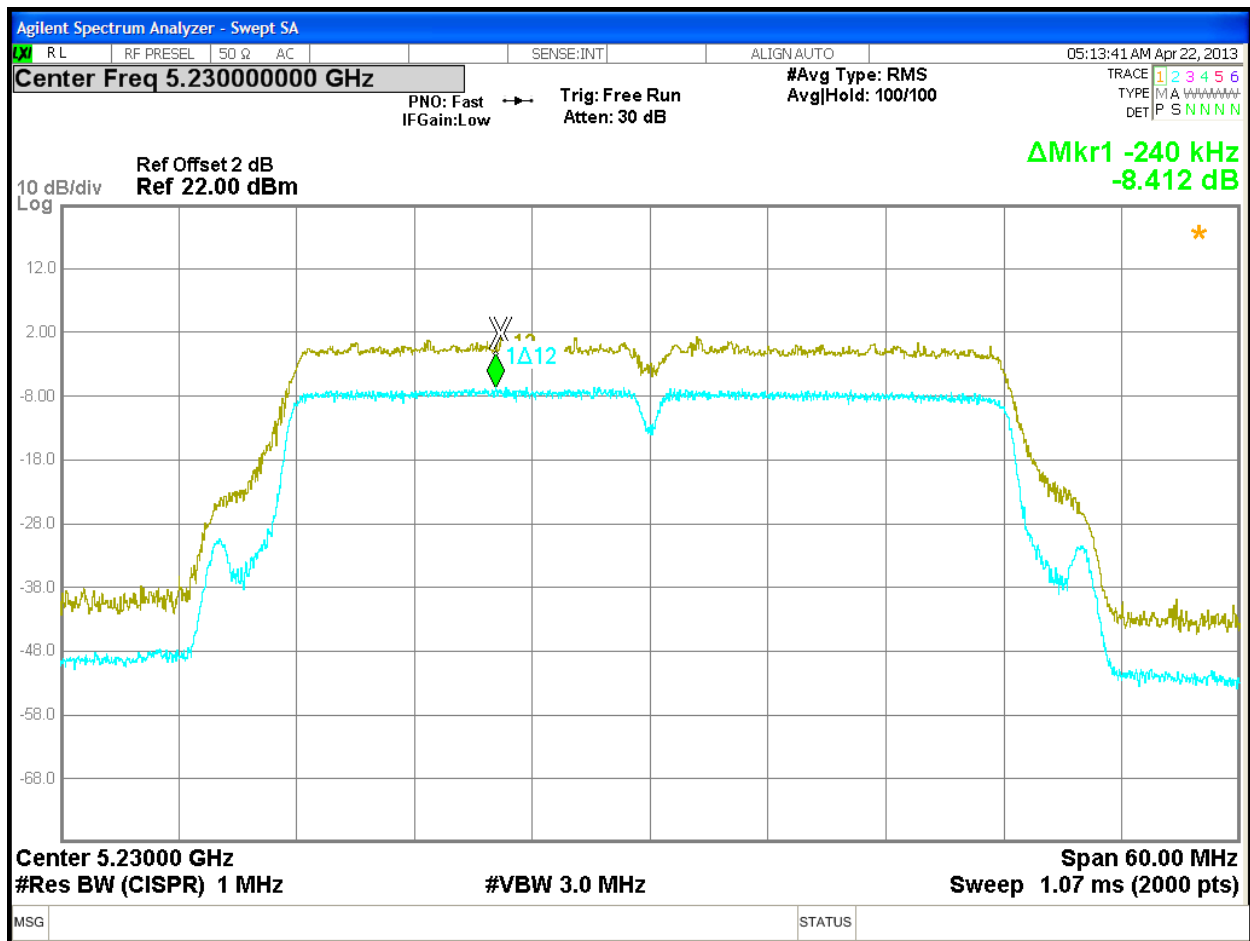

Figure 60: Peak Excursion, 5230 MHz at 802.11n, Chain 3 – 13.5 Mbps

4.4 Peak Power Spectral Density

According to the CFR47 Part 15.407 (a) and RSS 210 (A9.2), the spectral power density output of the antenna port shall be less than 4 dBm in any 1 MHz band during any time interval of continuous transmission.

4.4.1 Test Method

The conducted method was used to measure the channel power output per ANSI C63.10-2009 Section 6.11.2. The measurement was performed with modulation per CFR47 Part 15.407 (a) and RSS 210 (A9.2). The pre-evaluation was performed to find the worst modes. The worst findings were conducted on 3 channels in each operating frequency range of 5150 MHz to 5250 MHz. The worst sample result indicated below.

Test Setup:

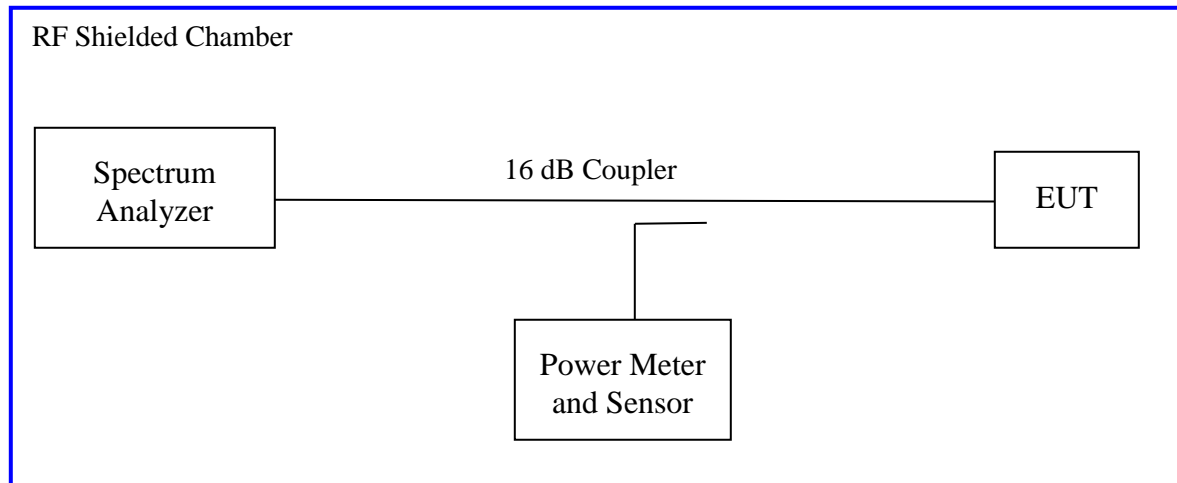

4.4.2 Results

As originally tested, the EUT was found to be compliant to the requirements of the test standard(s).

Table 6: Peak Power Spectral Density – Test Results

Test Conditions: Conducted Measurement, Normal Temperature and Voltage only								
Antenna Type: Integrated				Power Setting: See Test plan				
Max. Directional Gain: + 8 dBi				Signal State: Modulated at 100%.				
Ambient Temp.: 23° C				Relative Humidity: 32%				
Peak Power Spectral Density								
802.11n (HT20) Mode								
Freq. (MHz)	Total PSD [dBm]			Limit [dBm]		Margin [dB]		
5180	1.746			2.00		-0.25		
5200	0.272			2.00		-1.73		
5240	0.195			2.00		-1.81		
<p>Note: 1. The highest peak output power was observed at HT20 6.5 Mbps per data stream. 2. All chains will be on at all time and beam performing. Power spectral density were summed the spectra across the output KDB 662911. 3. The total directional gain would be 8dBi; 2dBi +10*Log(4). Per CFR47 Part 15.407 (a), the limit is reduced for every dBi gain exceeding 6dBi. The limit would be 2dBi.</p>								
802.11n (HT40) Mode								
Freq. (MHz)	Ch0 [dBm]	Ch1 [dBm]	Ch2 [dBm]	Ch3 [dBm]	CF [dB]	Max. PPSD [dBm]	Limit [dBm]	Margin [dB]
5190	-7.43	-5.87	-6.39	-7.70	6.00	0.13	2.00	-1.87
5230	-7.83	-5.98	-6.85	-6.53	6.00	0.02	2.00	-1.98
<p>Note: 1. The highest peak output power was observed at HT40 13.5 Mbps per data stream. 2. All chains will be on at all time and beam performing. The highest power spectral densities was added 10*Log(4) per KDB 662911, accounted for the number of outputs. 3. The total directional gain would be 8dBi; 2dBi +10*Log(4). Per CFR47 Part 15.407 (a), the limit is reduced for every dBi gain exceeding 6dBi. The limit would be 2dBi.</p>								

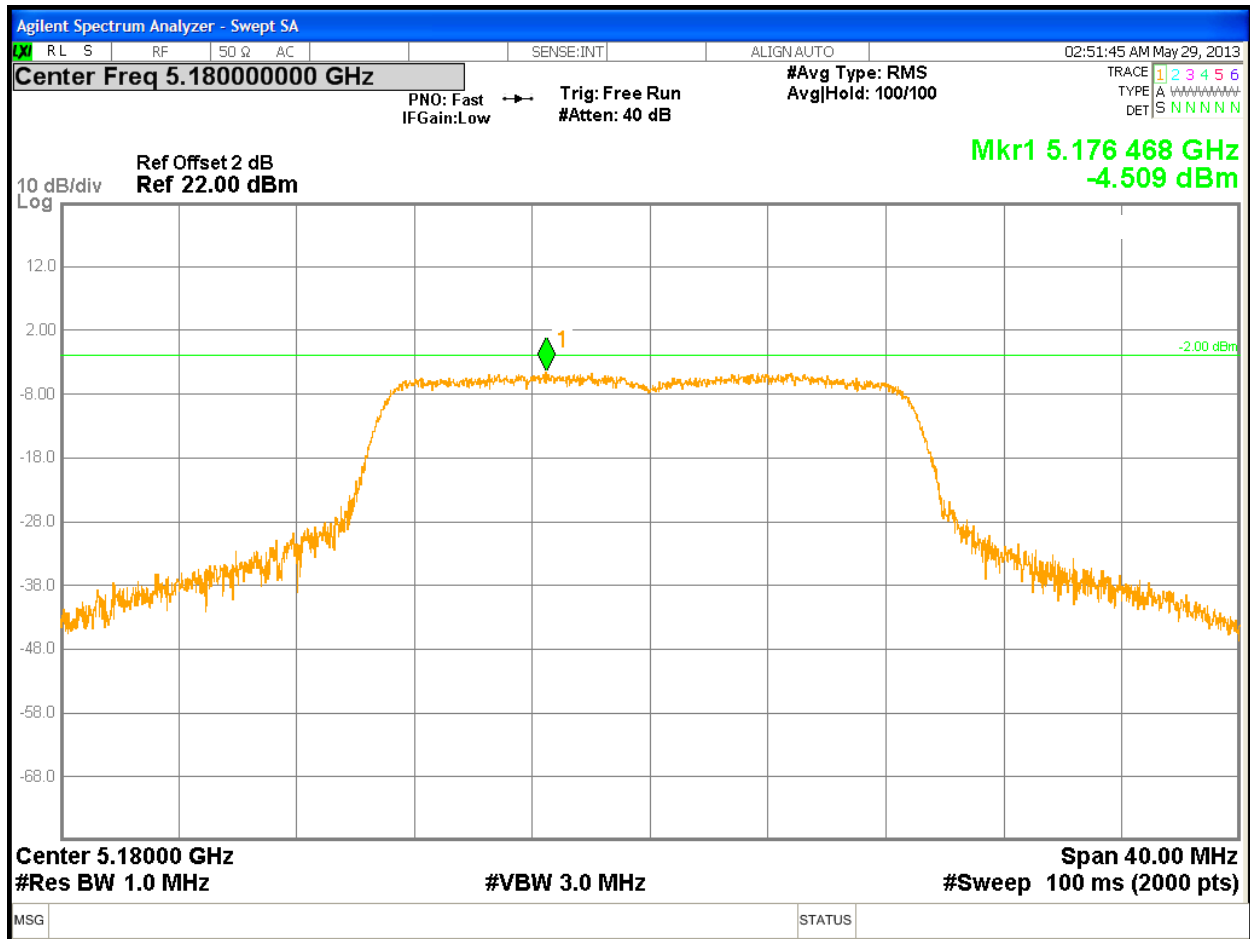

Figure 61: Power Spectral Density, 5180 MHz at 802.11n, Chain 0 – 6.5 Mbps

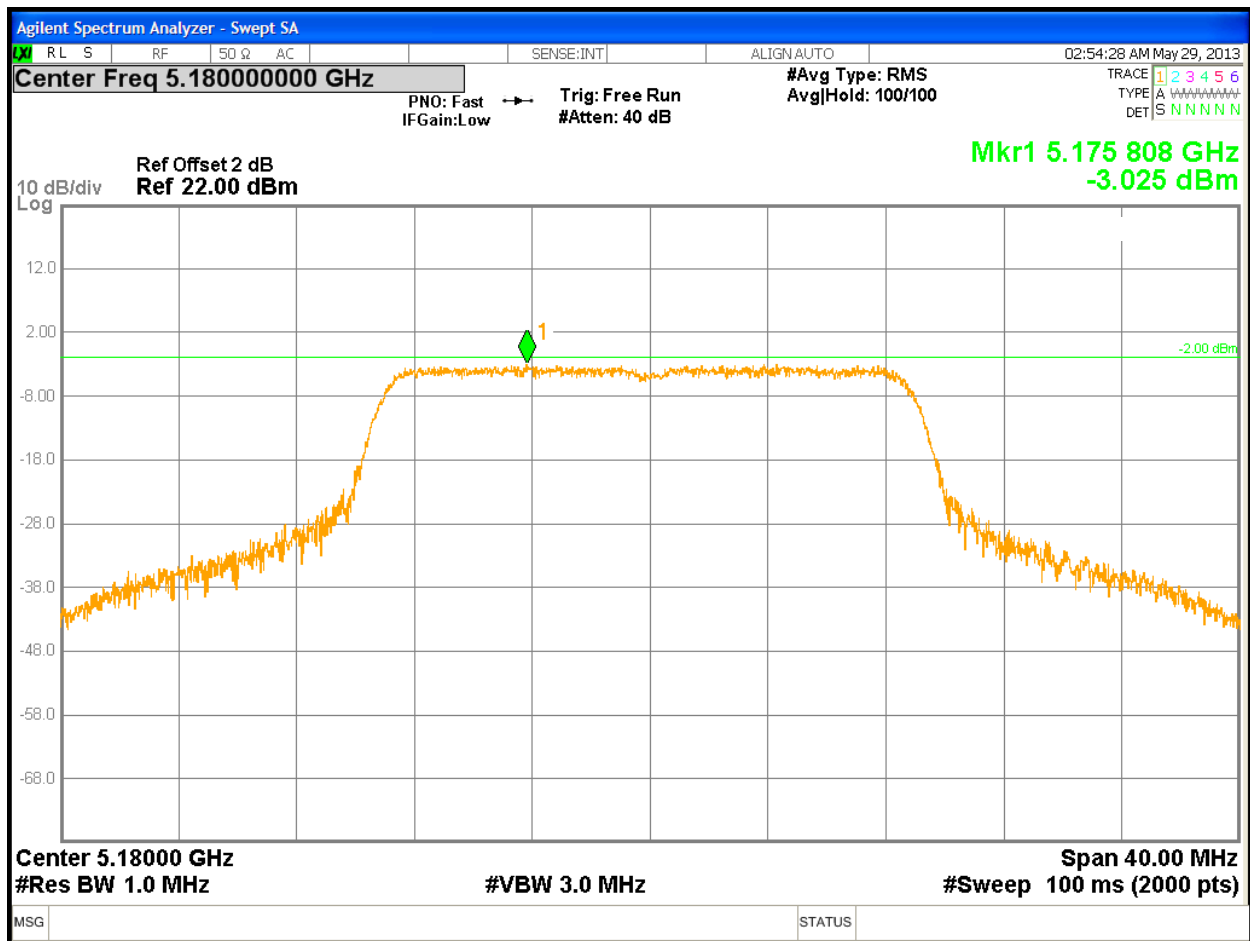

Figure 62: Power Spectral Density, 5180 MHz at 802.11n, Chain 1 – 6.5 Mbps

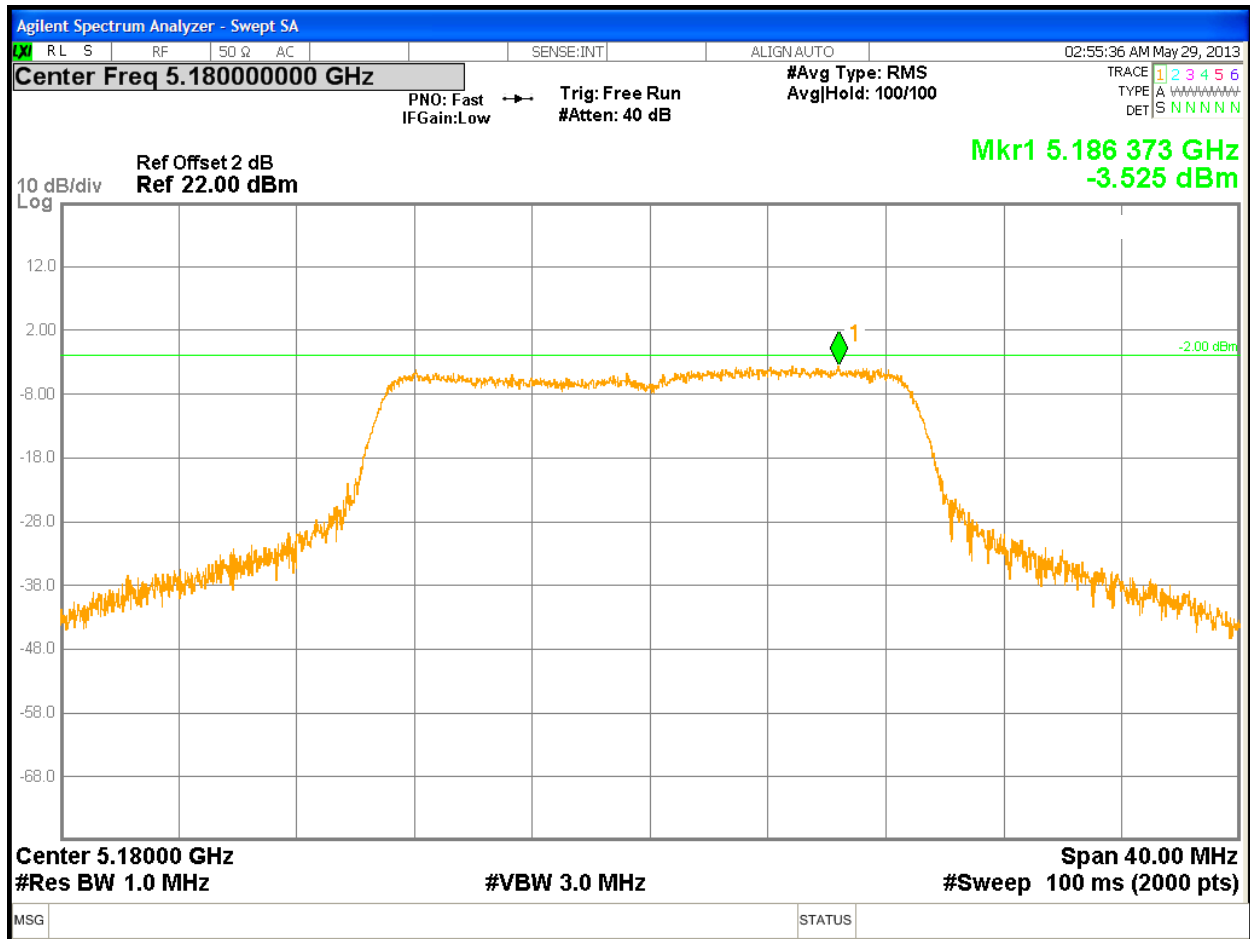

Figure 63: Power Spectral Density, 5180 MHz at 802.11n, Chain 2 – 6.5 Mbps

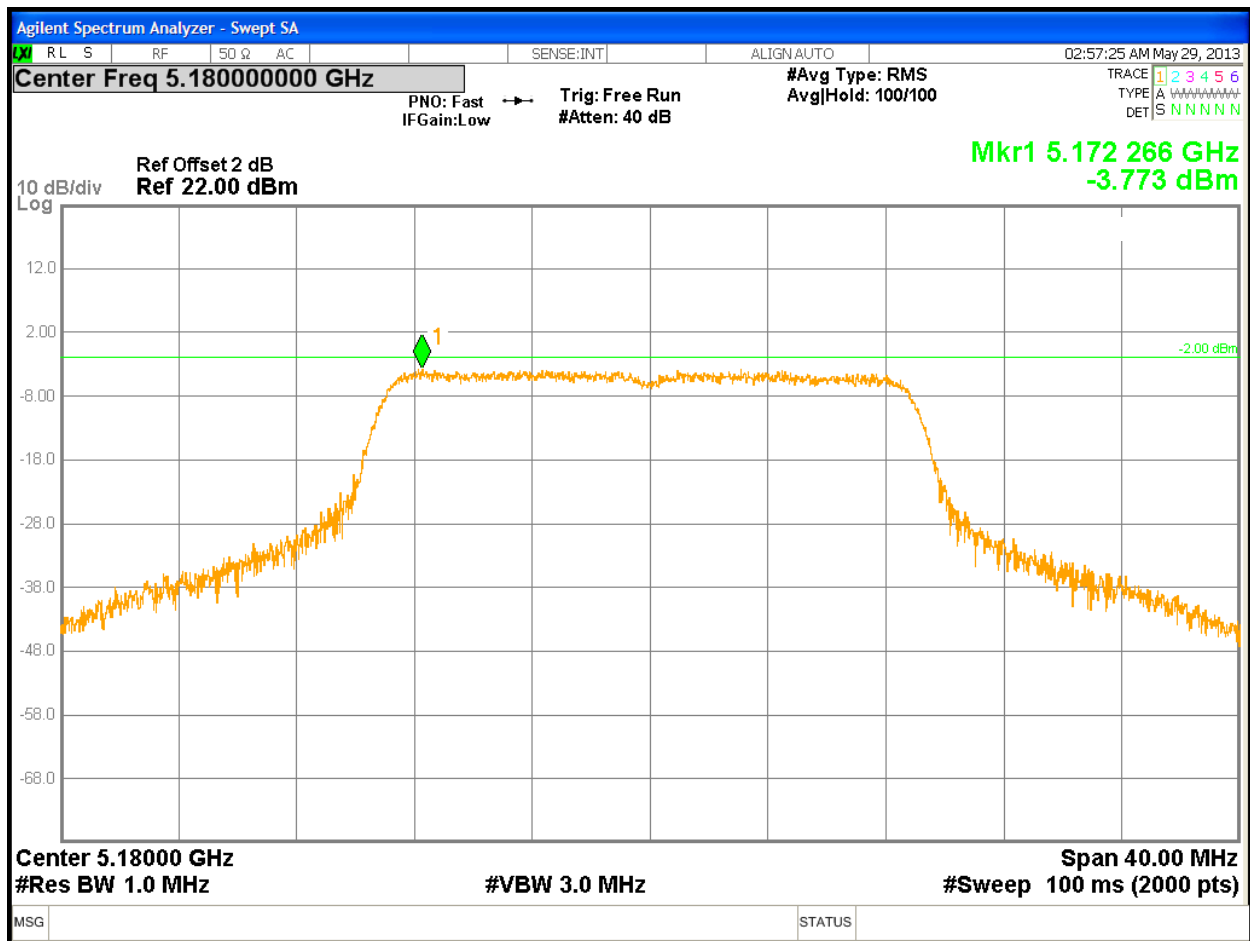

Figure 64: Power Spectral Density, 5180 MHz at 802.11n, Chain 3 – 6.5 Mbps

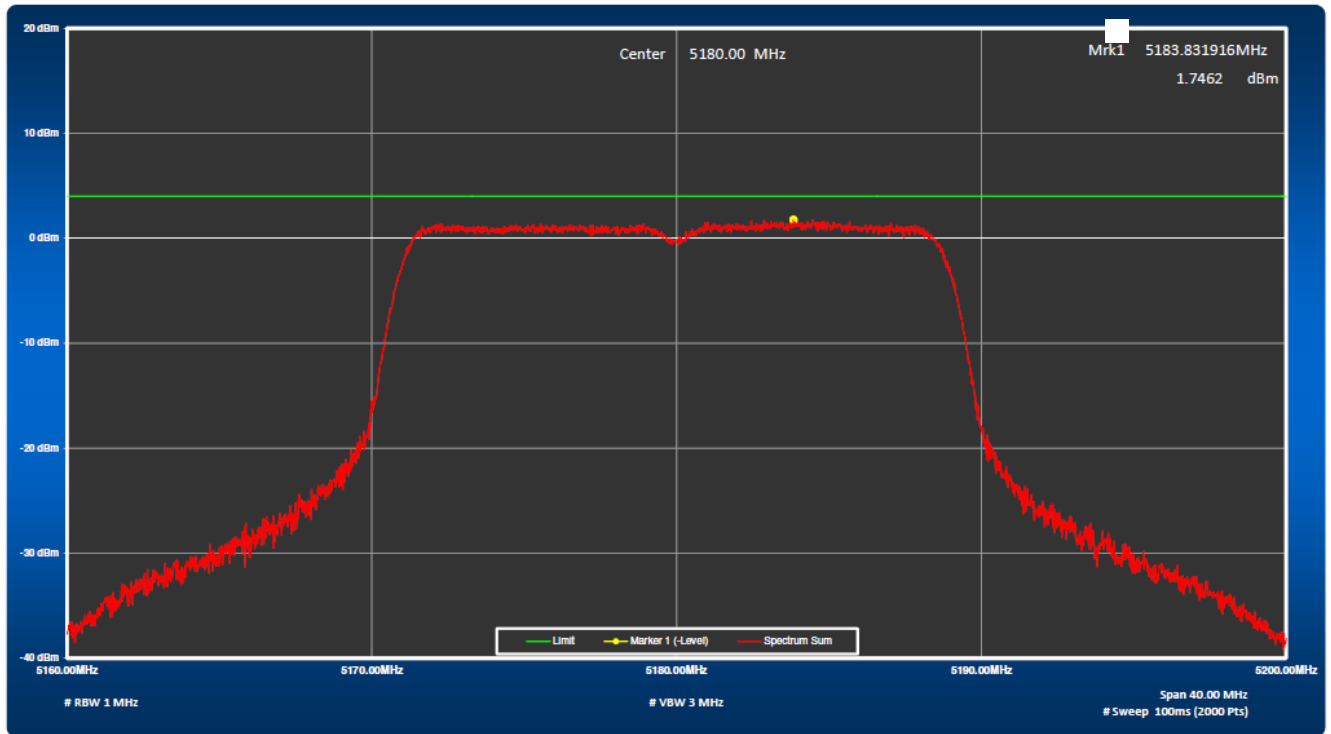

Figure 65: Total Power Spectral Density, 5180 MHz at 802.11n, HT20

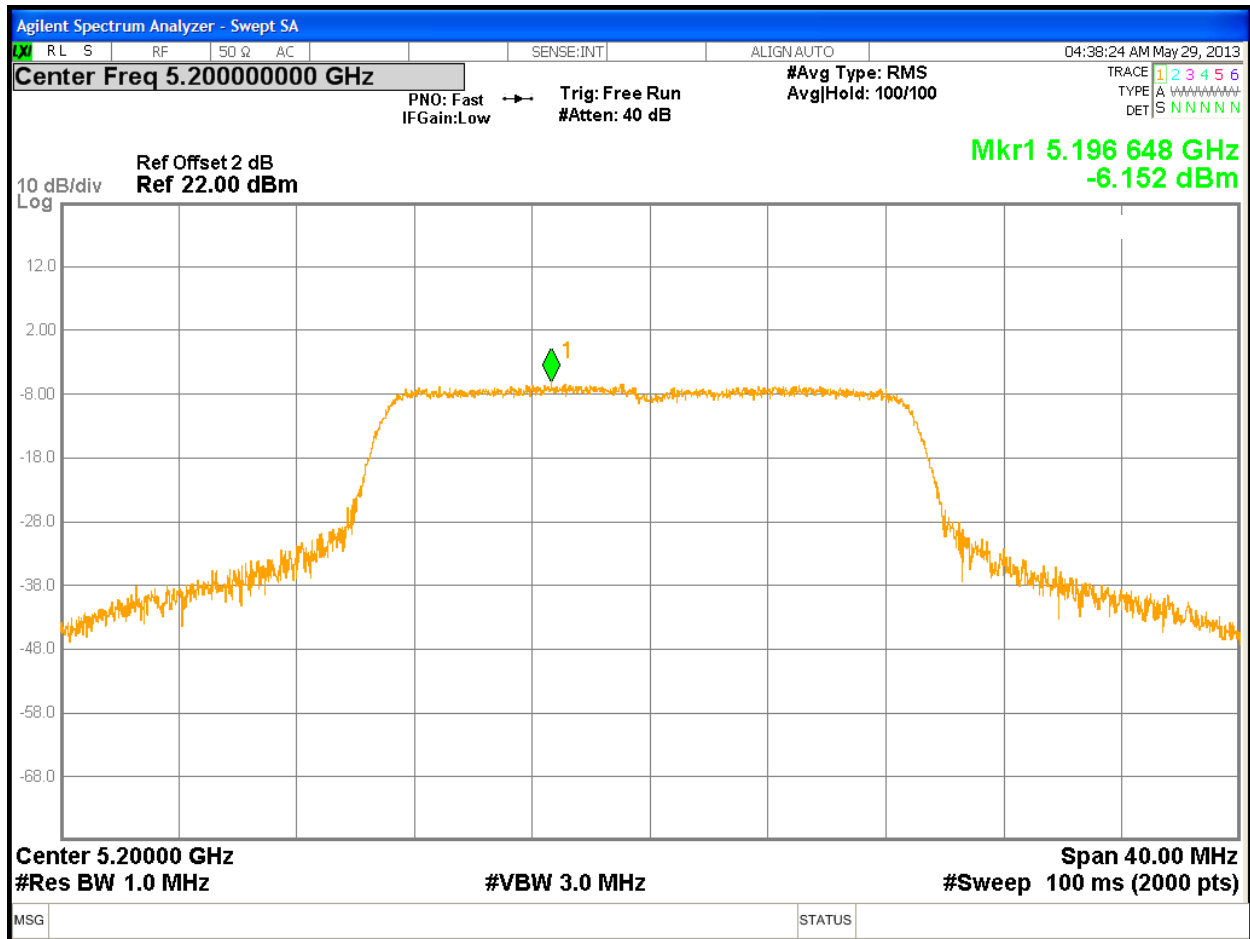

Figure 66: Power Spectral Density, 5200 MHz at 802.11n, Chain 0 – 6.5 Mbps

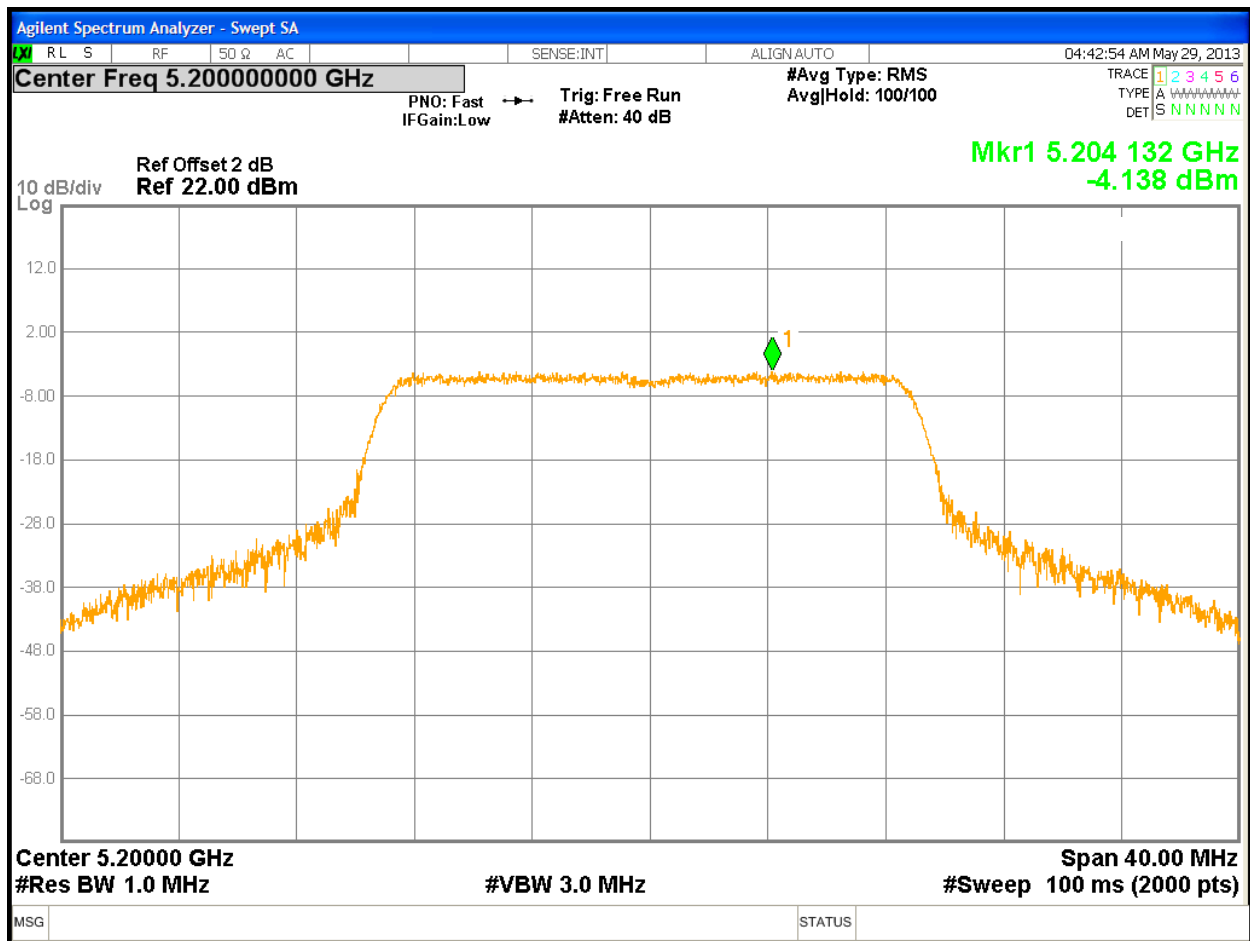

Figure 67: Power Spectral Density, 5200 MHz at 802.11n, Chain 1 – 6.5 Mbps

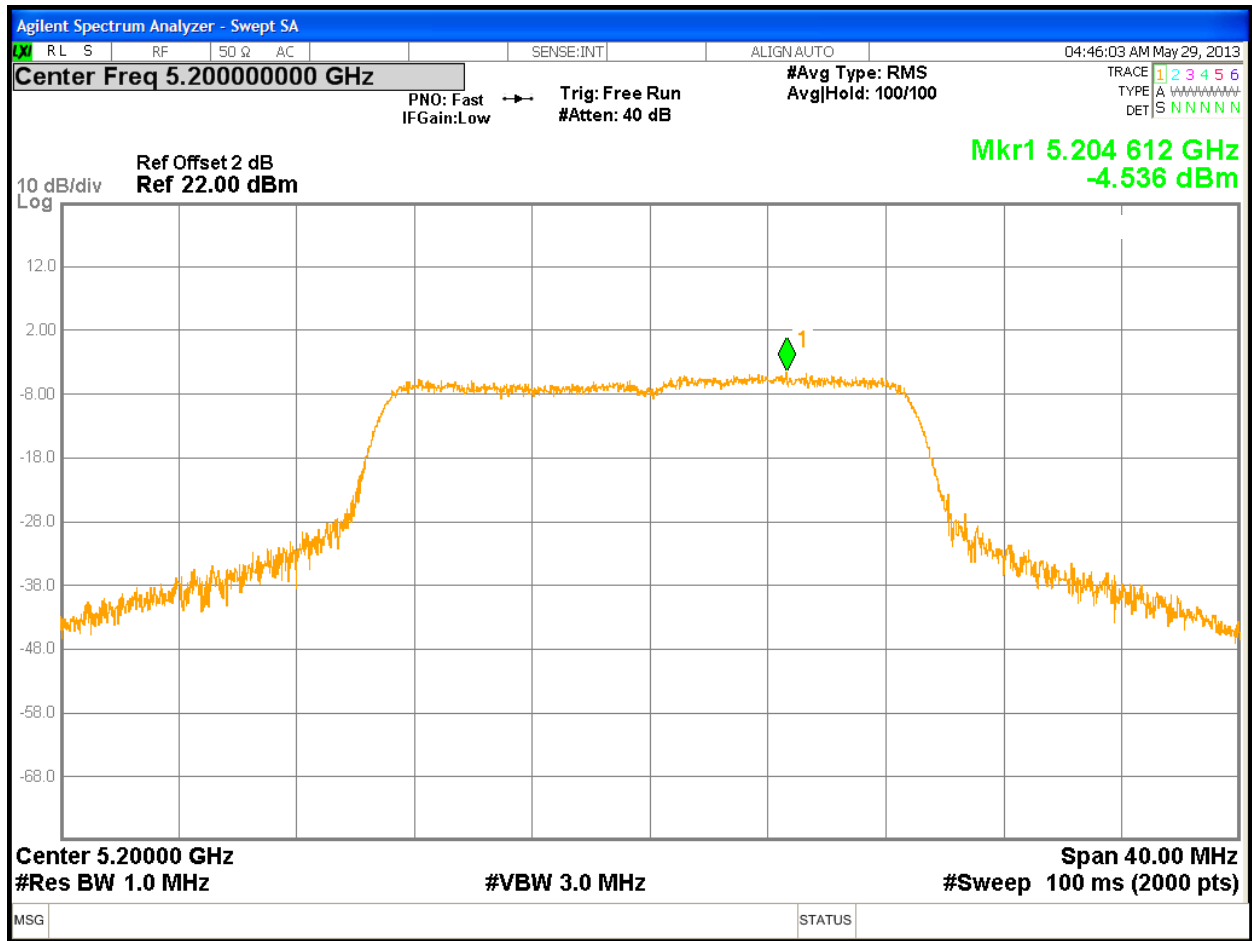

Figure 68: Power Spectral Density, 5200 MHz at 802.11n, Chain 2 – 6.5 Mbps

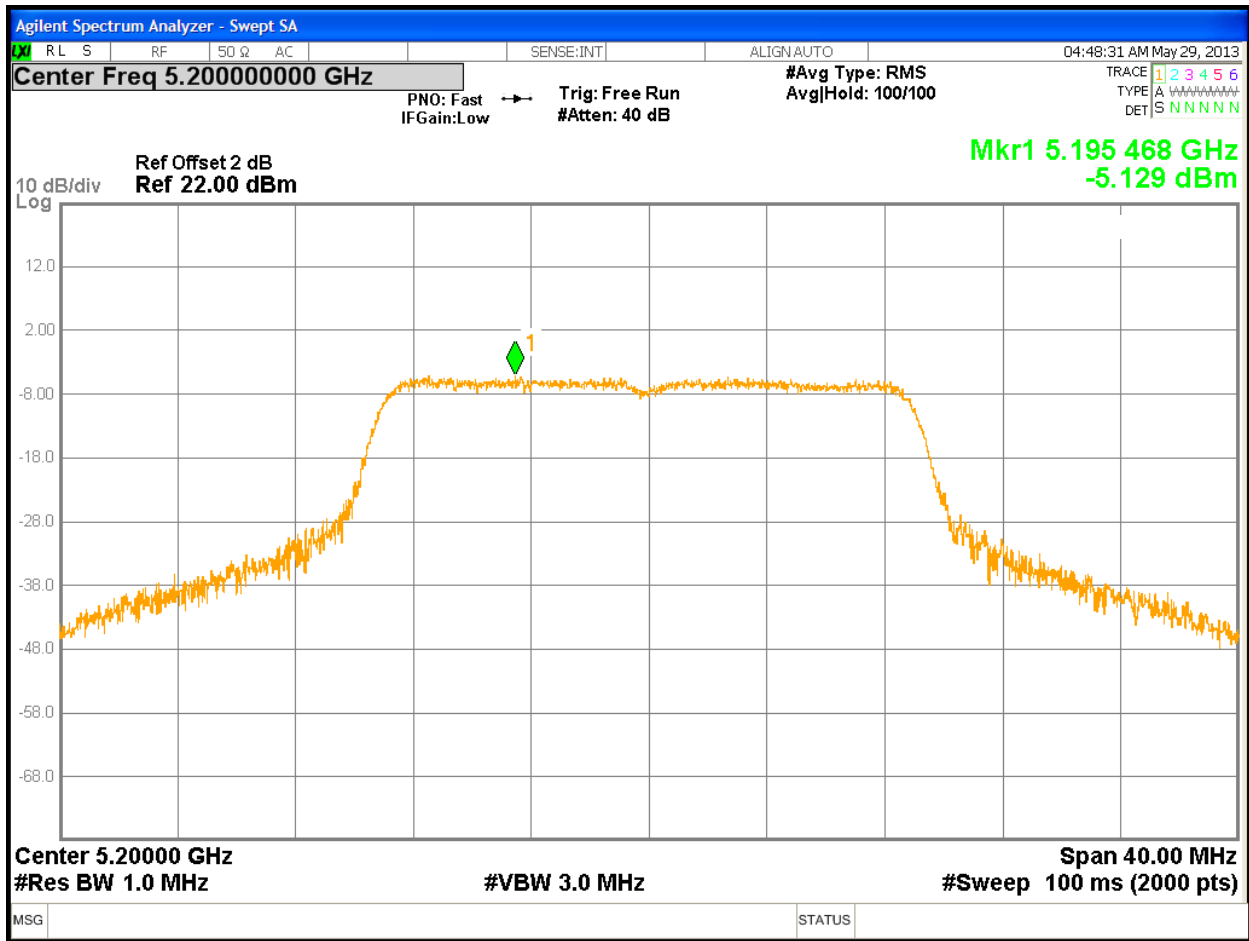

Figure 69: Power Spectral Density, 5200 MHz at 802.11n, Chain 3 – 6.5 Mbps

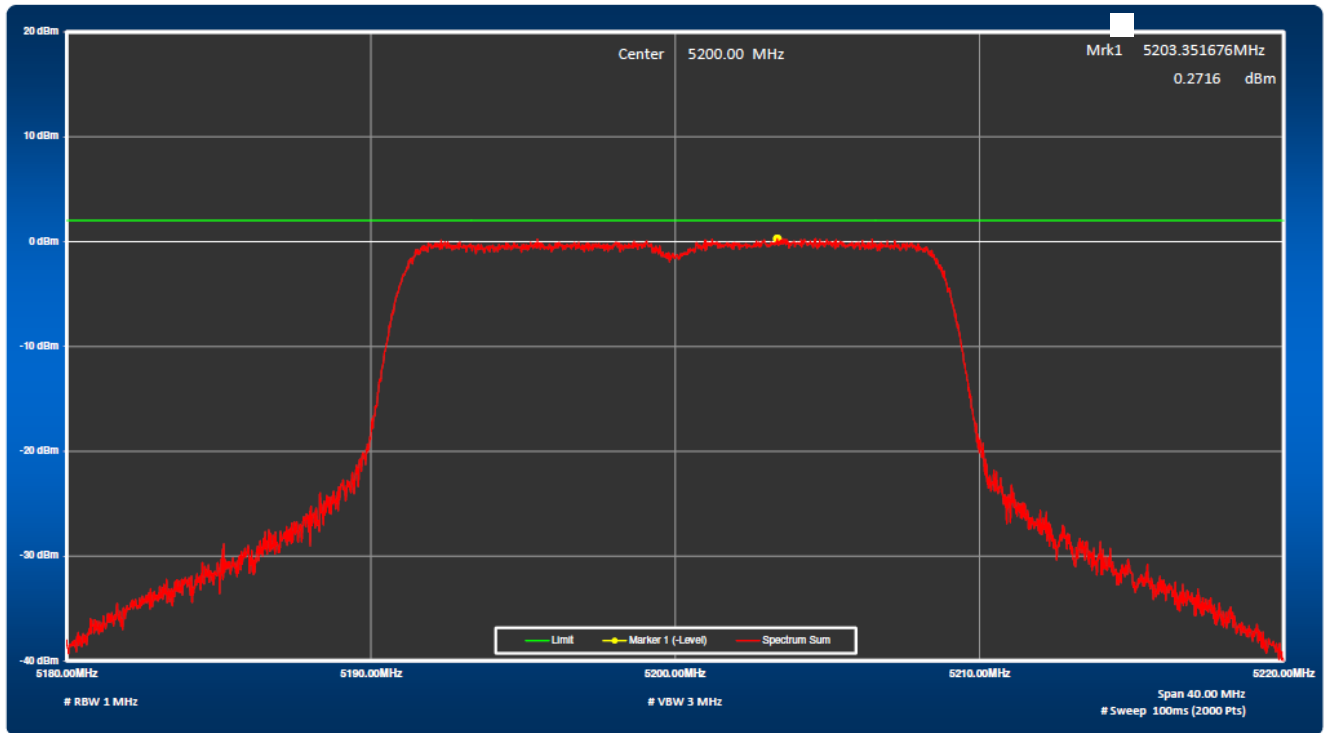

Figure 70: Total Power Spectral Density, 5200 MHz at 802.11n, HT20

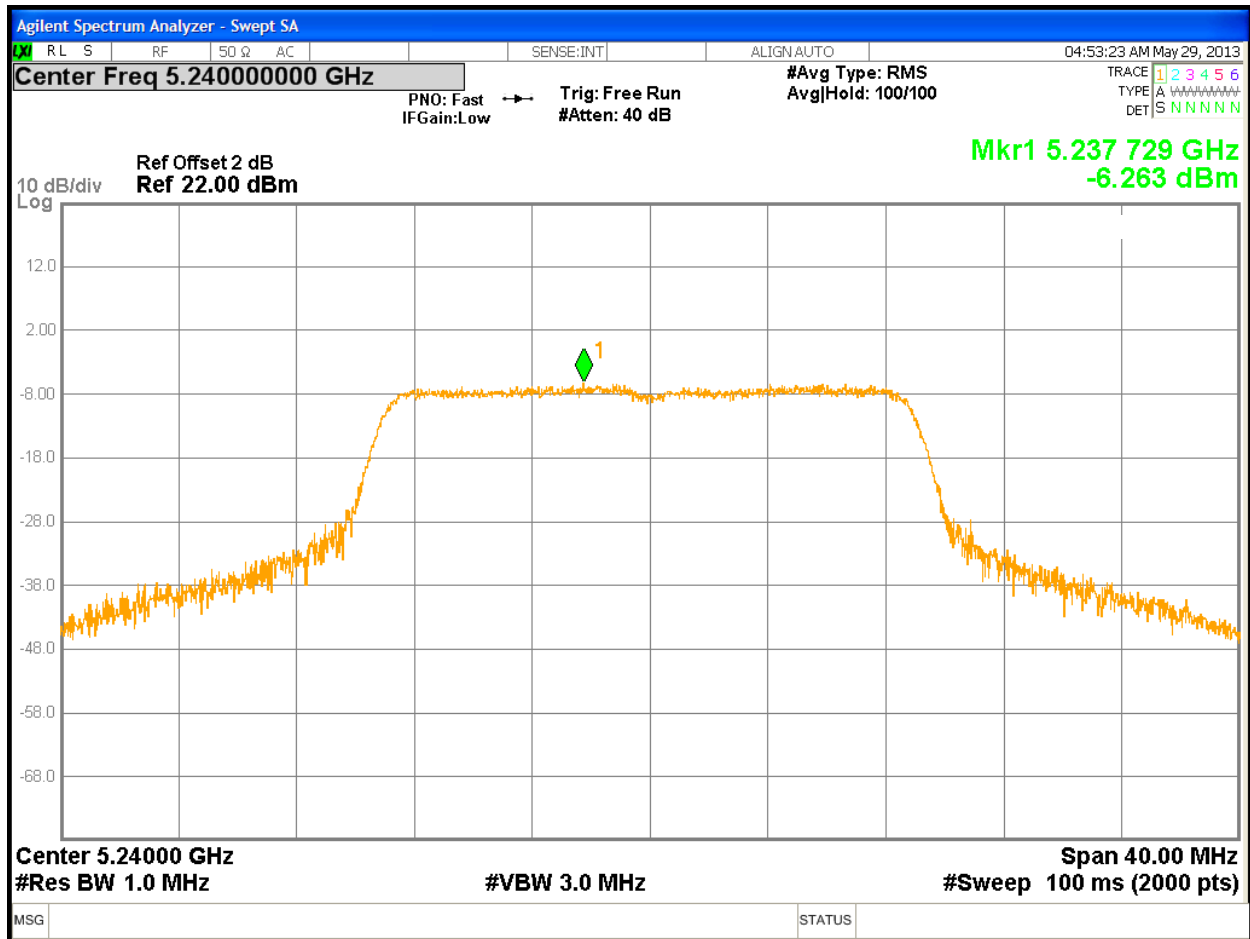

Figure 71: Peak Power Spectral Density, 5240 MHz at 802.11n, Chain 0 – 6.5 Mbps

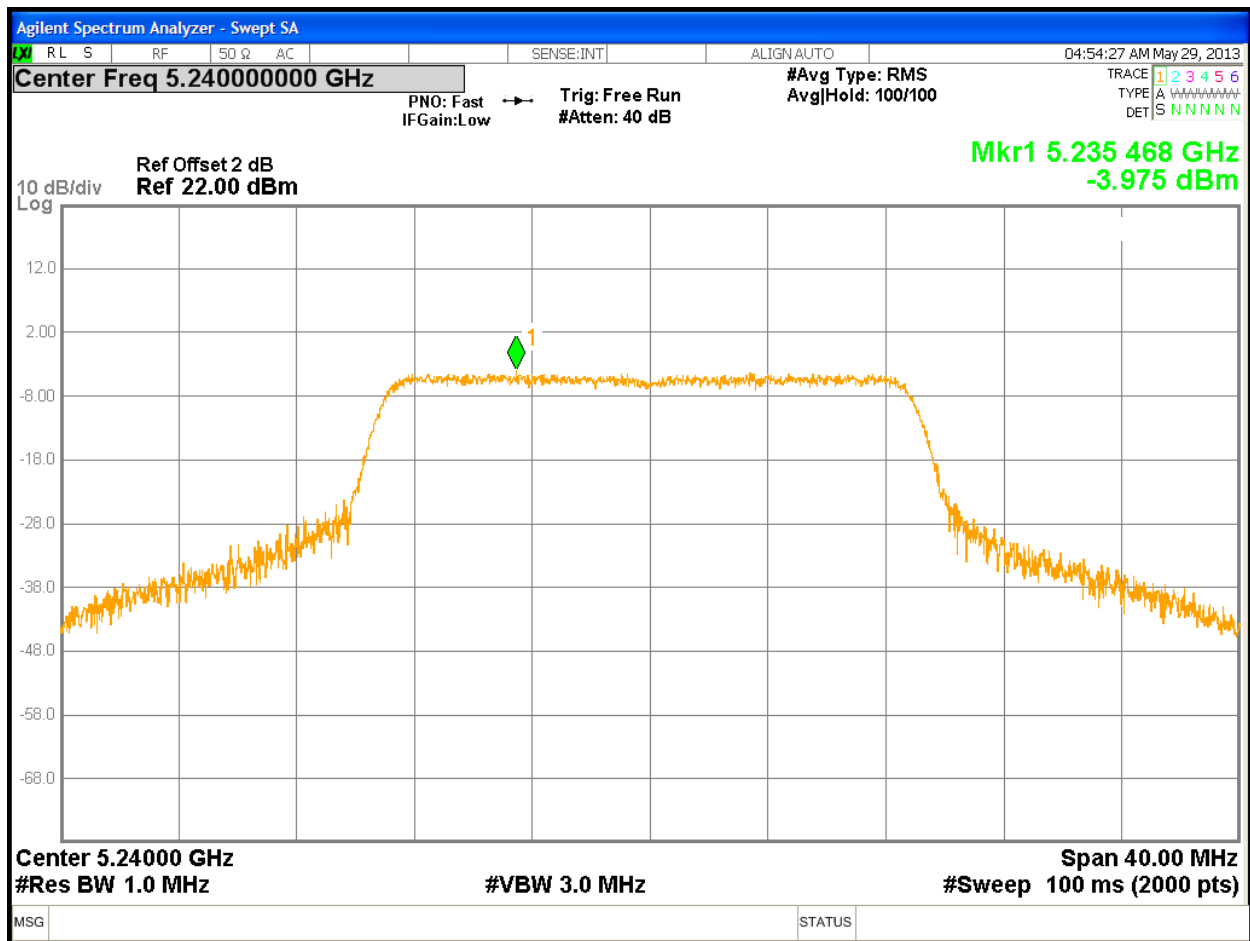

Figure 72: Peak Power Spectral Density, 5240 MHz at 802.11n, Chain 1 – 6.5 Mbps

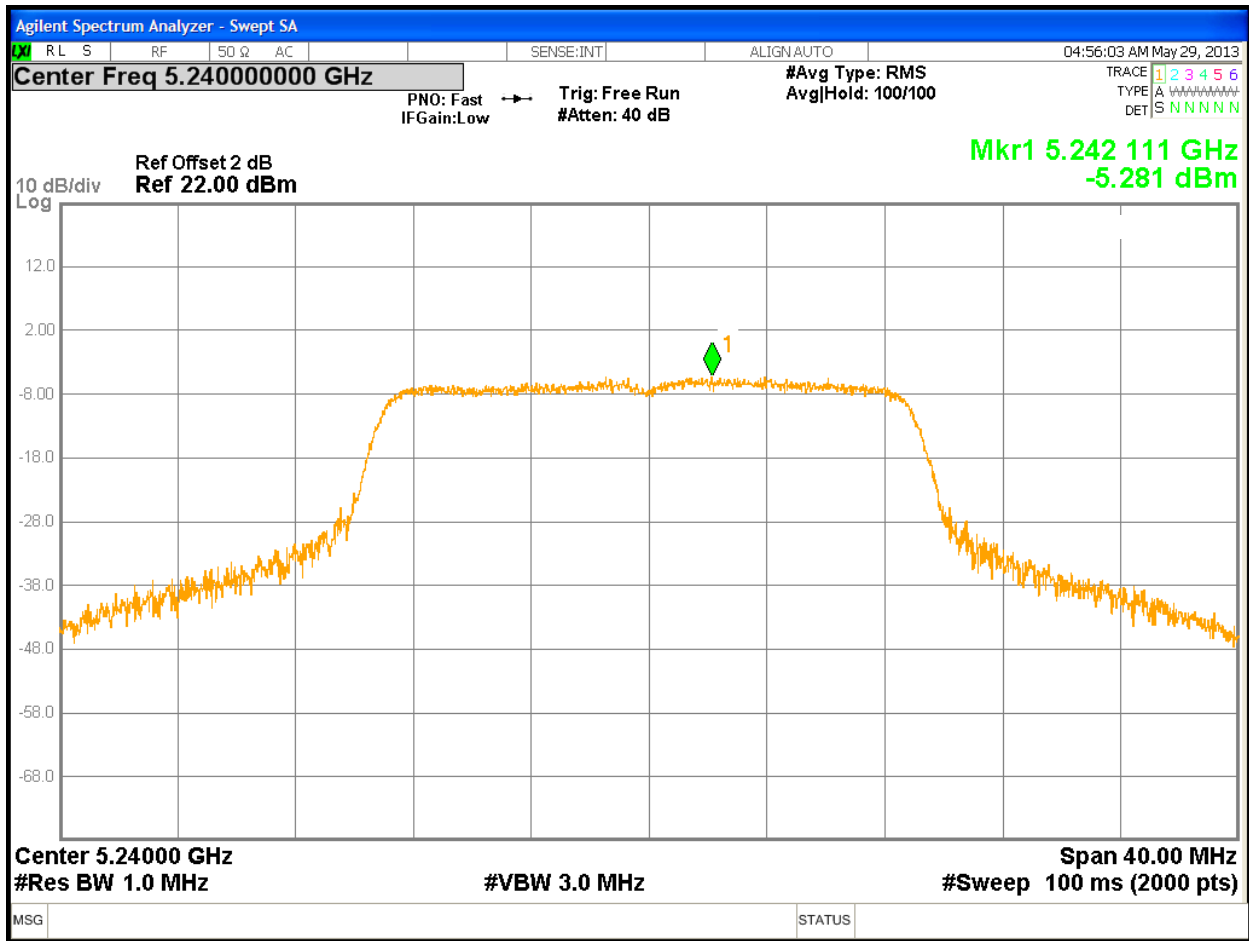

Figure 73: Peak Power Spectral Density, 5240 MHz at 802.11n, Chain 2 – 6.5 Mbps

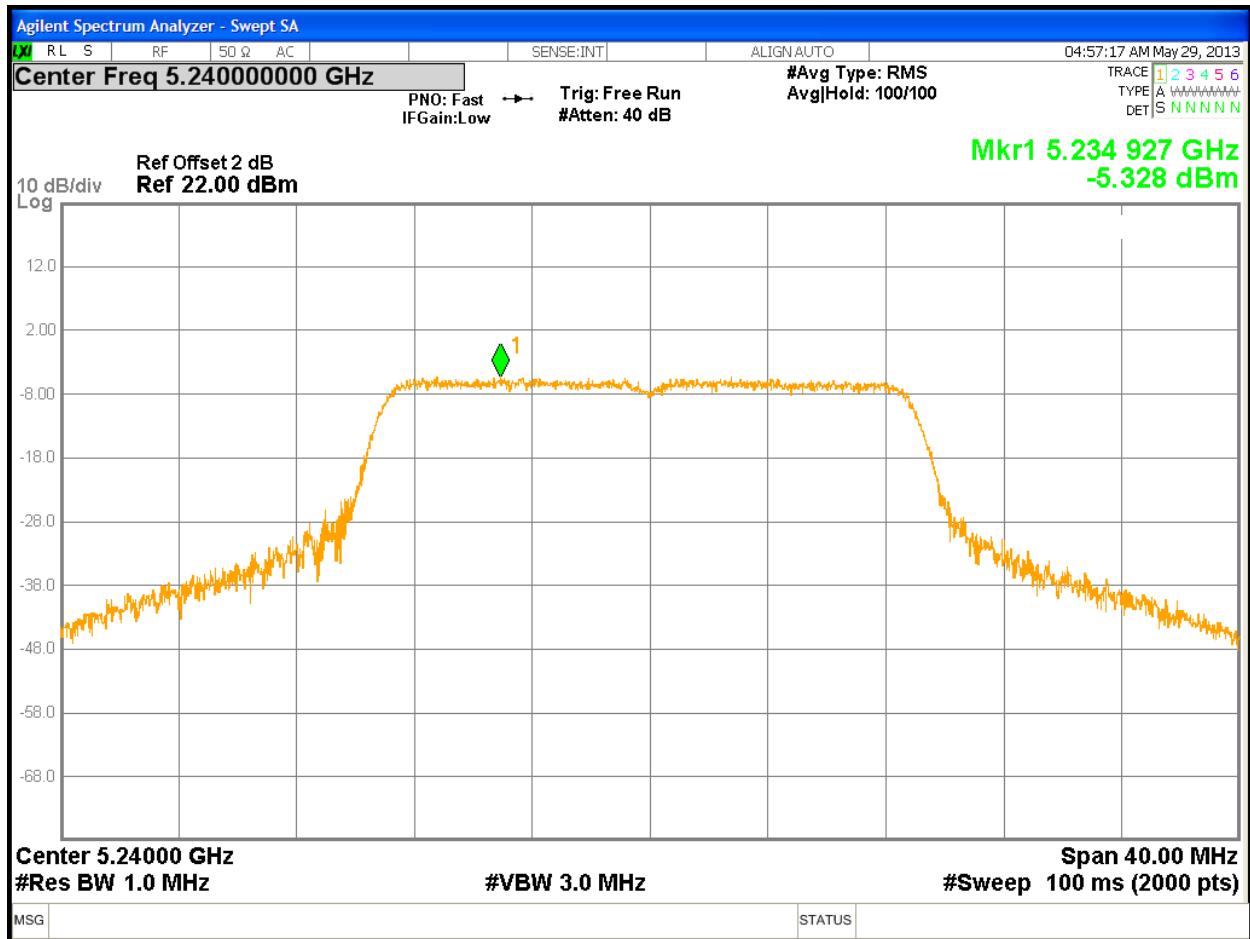

Figure 74: Peak Power Spectral Density, 5240 MHz at 802.11n, Chain 3 – 6.5 Mbps

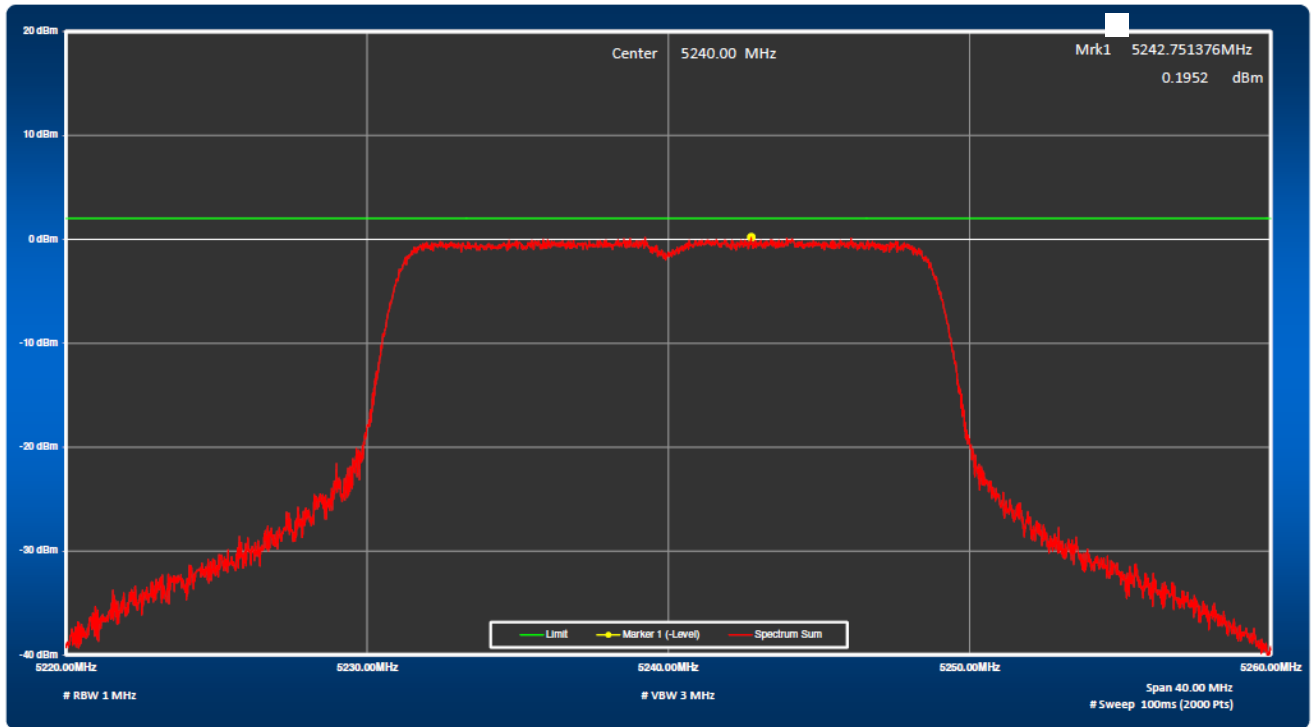

Figure 75: Total Power Spectral Density, 5240 MHz at 802.11n, HT20

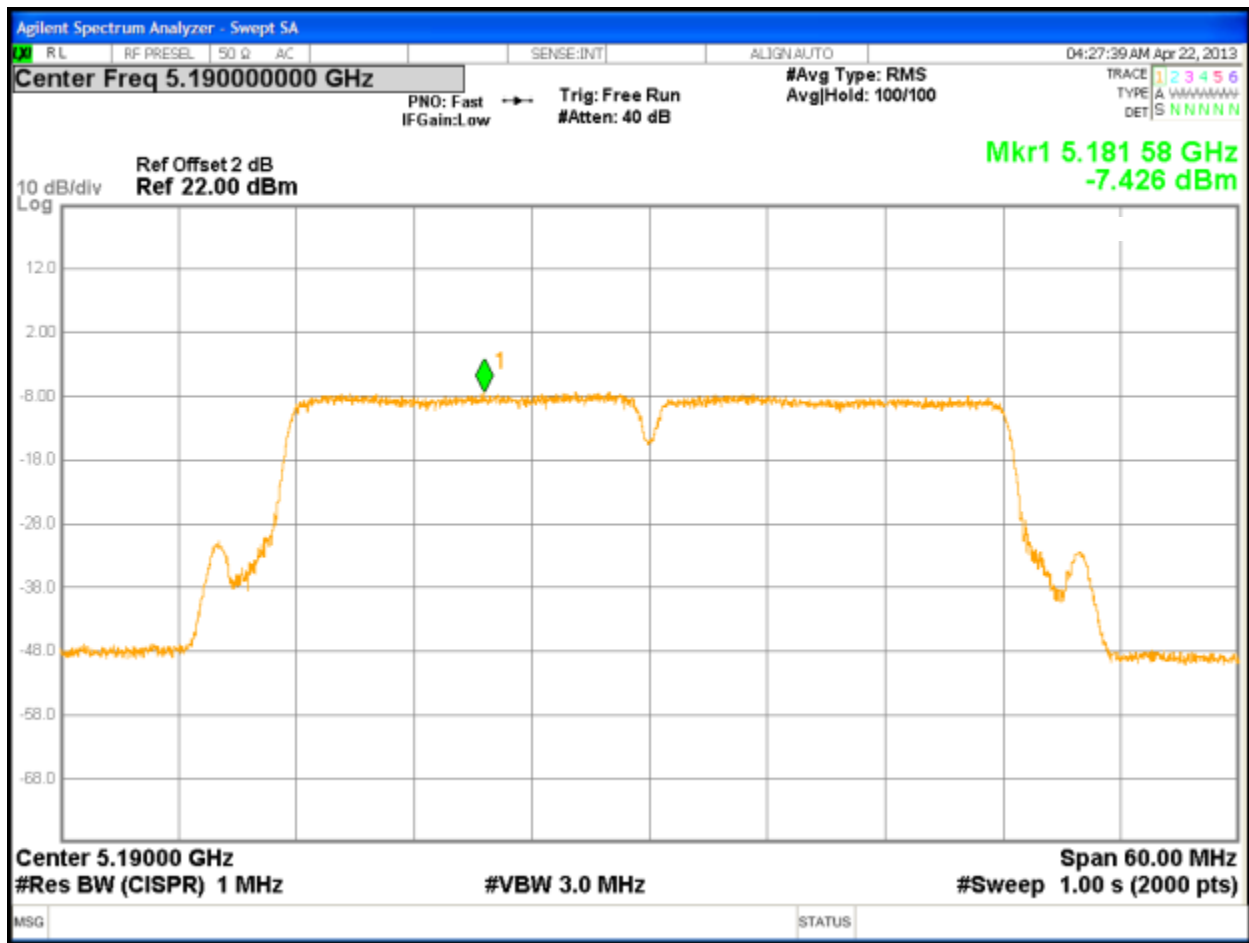

Figure 76: Peak Power Spectral Density, 5190 MHz at 802.11n, Chain 0 – 13.5 Mbps

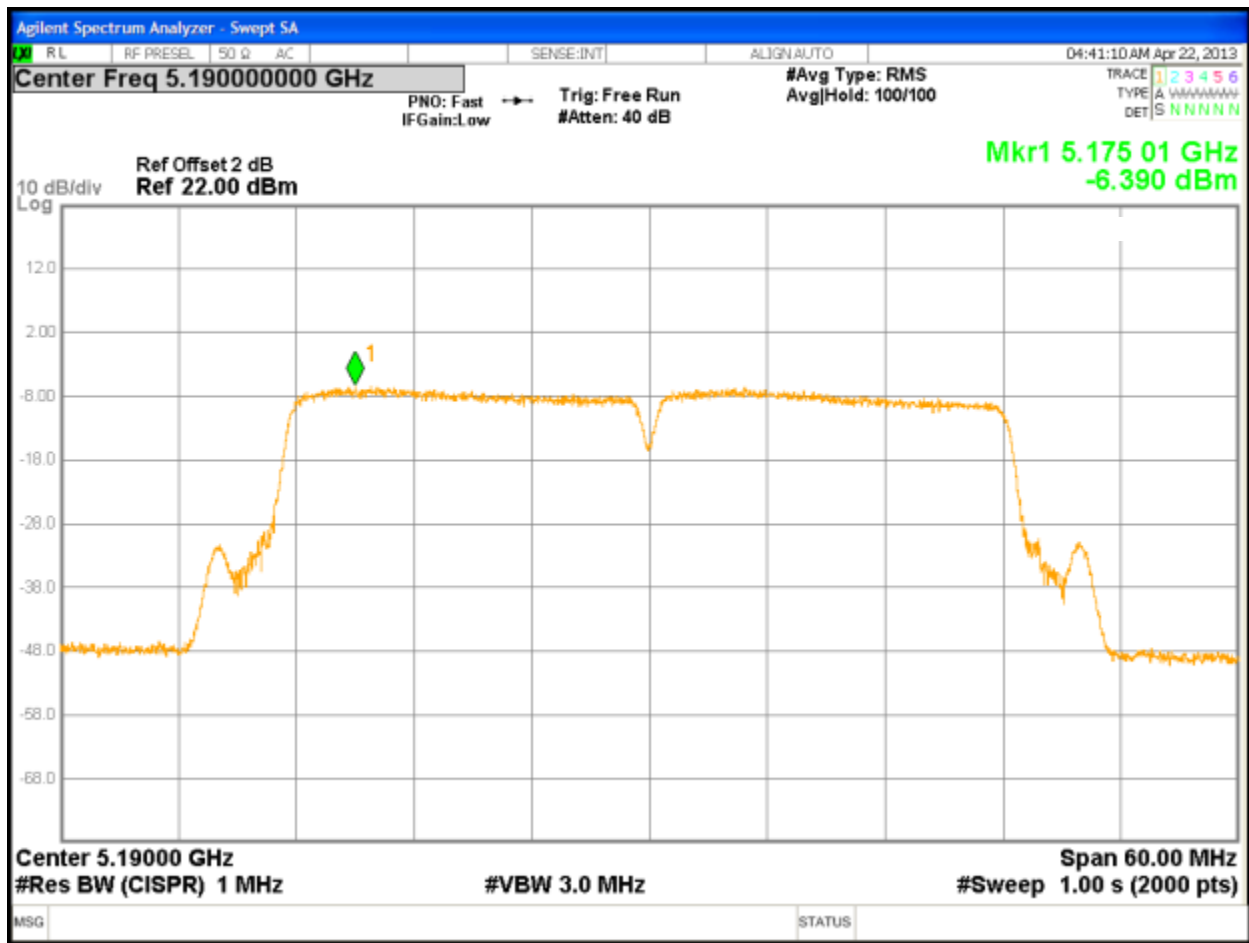

Figure 78: Peak Power Spectral Density, 5190 MHz at 802.11n, Chain 2 – 13.5 Mbps

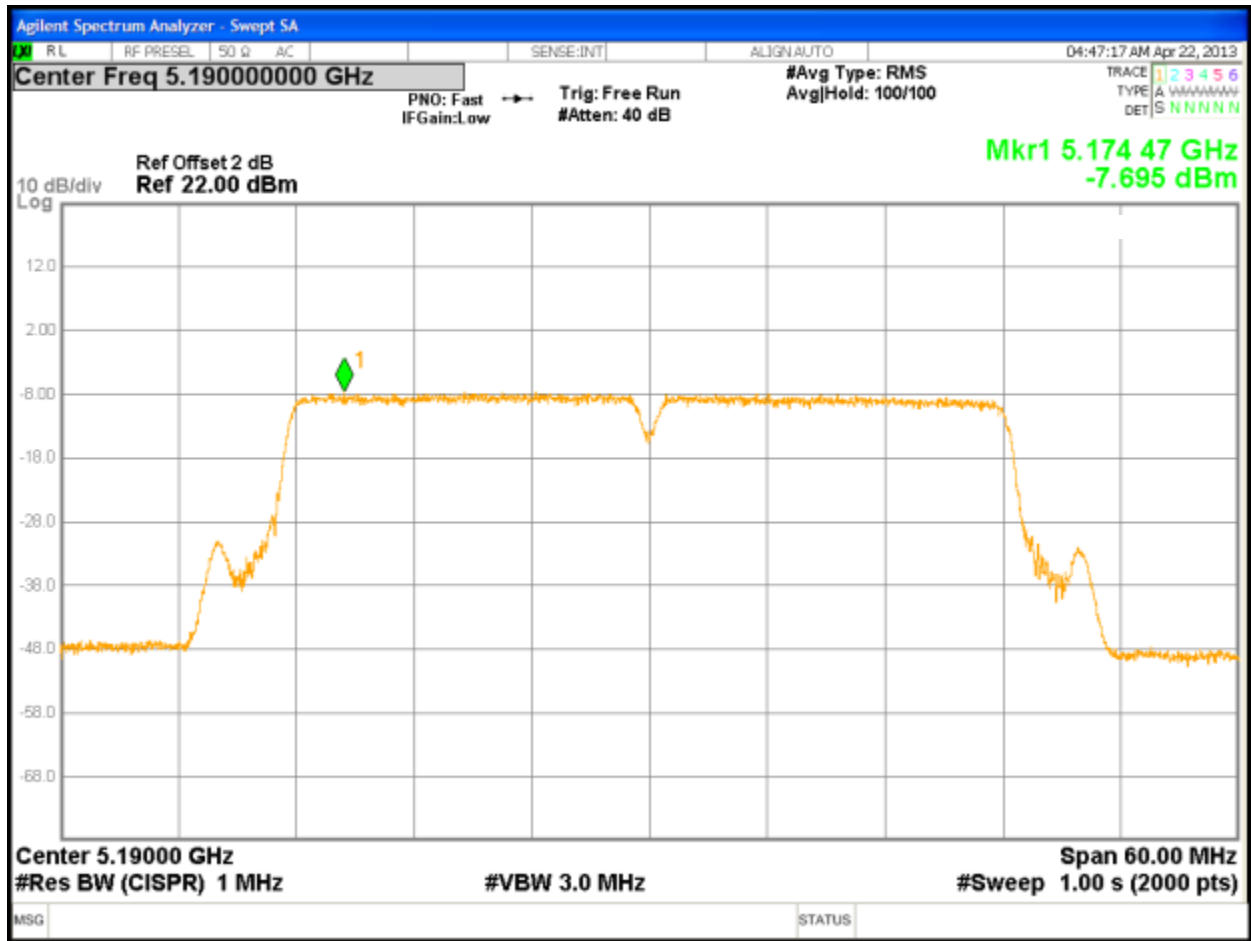

Figure 79: Peak Power Spectral Density, 5190 MHz at 802.11n, Chain 3 – 13.5 Mbps

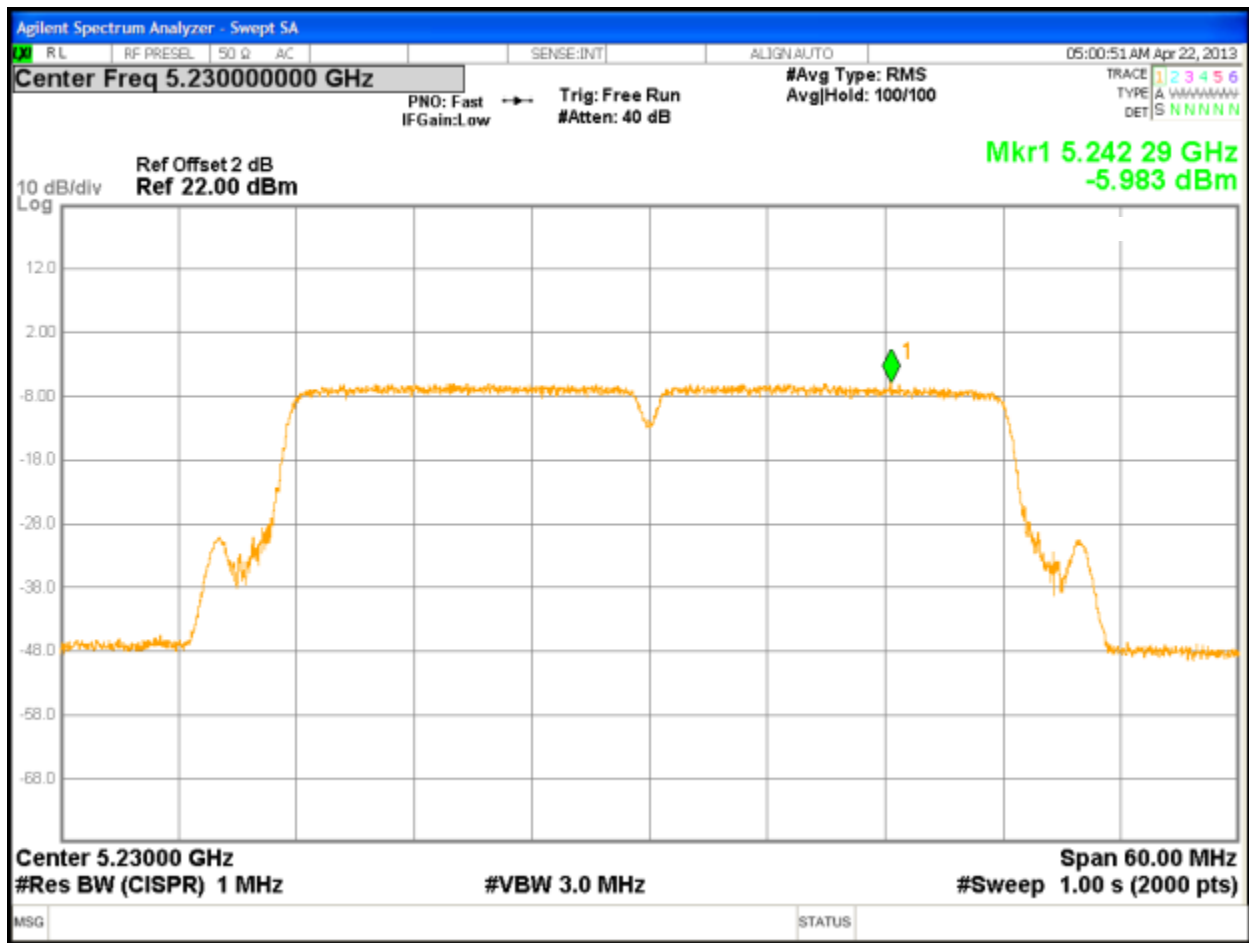

Figure 81: Peak Power Spectral Density, 5230 MHz at 802.11n, Chain 1 – 13.5 Mbps

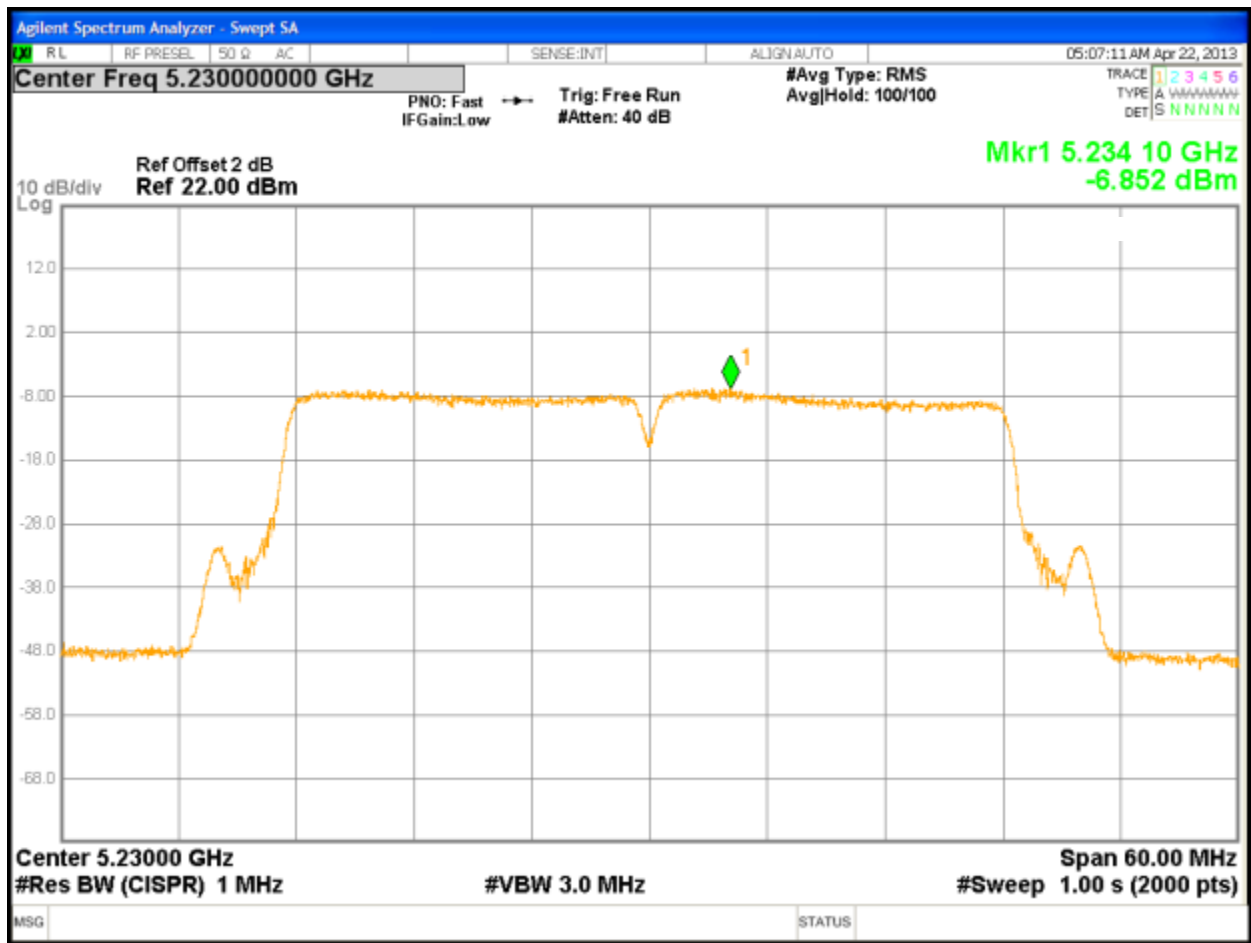

Figure 82: Peak Power Spectral Density, 5230 MHz at 802.11n, Chain 2 – 13.5 Mbps

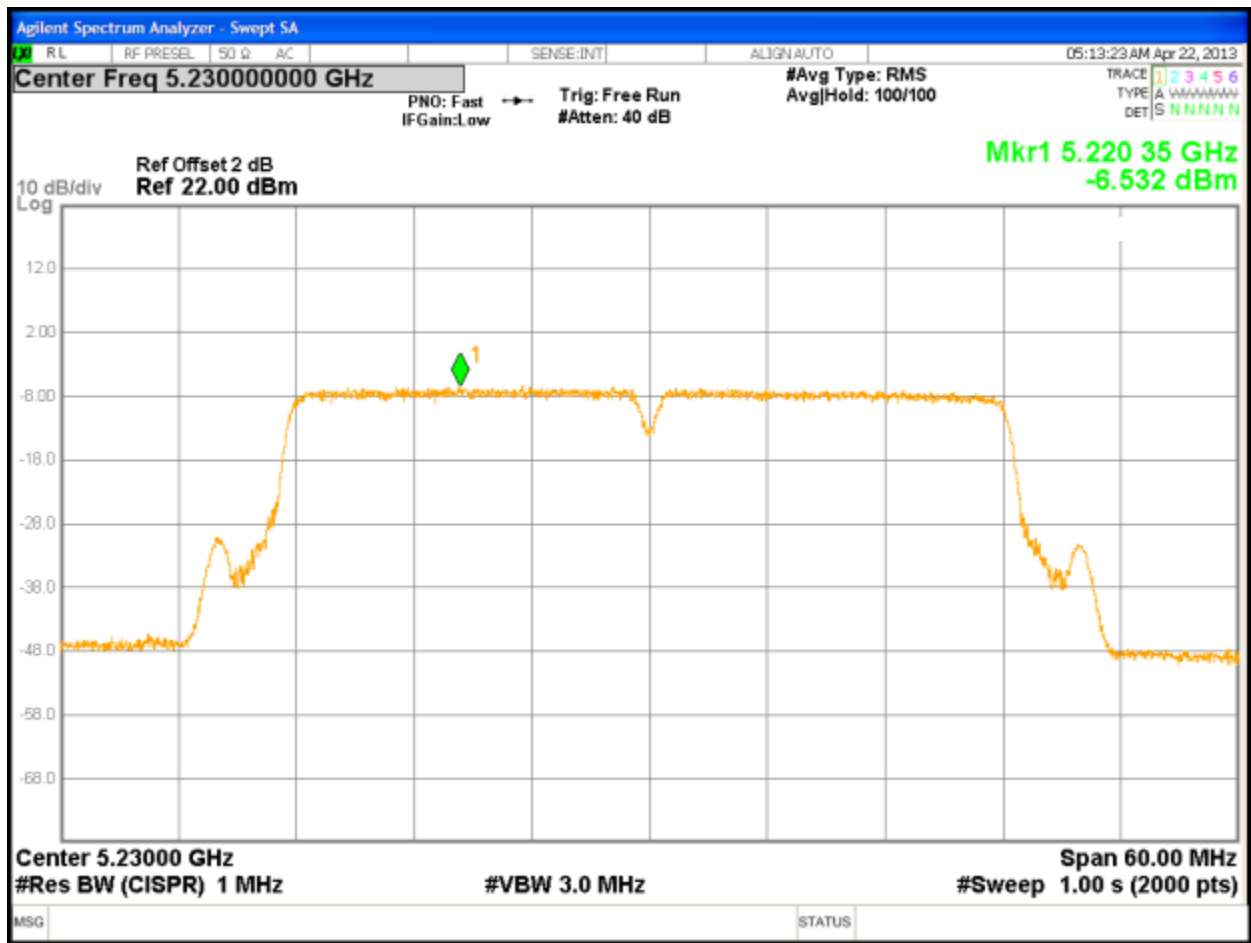

Figure 83: Peak Power Spectral Density, 5230 MHz at 802.11n, Chain 3 – 13.5 Mbps

4.5 Transmitter Spurious Emissions

Transmitter spurious emissions are emissions outside the frequency range of the equipment when the equipment is in transmit mode; per requirement of CFR47 15.205, 15.209, 15.407(b), RSS 210 Sect. A.9.2

4.5.1 Test Methodology

4.5.1.1 Preliminary Test

A test program that controls instrumentation and data logging was used to automate the preliminary RF emission test procedure. The frequency range of interest was divided into sub-ranges to yield a frequency resolution of approximately 120 kHz and provide a reading at each frequency for no more than 12° of turntable rotation. For each frequency sub-range the turntable was rotated 360° while peak emission data was recorded and plotted over the frequency range of interest in horizontal and vertical antenna polarization's.

Preliminary emission profile testing was performed inside the anechoic chamber. The EUT was placed on a 1.0m x 1.5m non-conductive table 80cm above the floor. The EUT was positioned as shown in the setup photographs. The receiving antenna was placed at a distance of 3m at a fixed height of 1m. Measurement equipment was located outside of the chamber. A video camera was placed inside the chamber to view the EUT.

Pres-scans were performed to determine the worst axis, data rate/ chains.

4.5.1.2 Final Test

For each frequency measured, the peak emission was maximized by manipulating the receiving antenna from 1 to 4 meters above the ground plane and placing it at the position that produced the maximum signal strength reading. The turntable was then rotated through 360° while observing the peak signal and placing the EUT at the position that produced maximum radiation. The six highest emissions relative to the limit were measured unless such emissions were more than 20 dB below the limit. If less than six emissions are within 20 dB of the limit, than the noise level of the receiver is measured at frequencies where emissions are expected. Multiples of all oscillator and microprocessor frequencies were also checked.

Final testing was performed on an NSA compliant test site. The EUT was placed on a 1.0m x 1.5m non-conductive table 80cm above the ground plane. The placement of EUT and cables were the same as for preliminary testing and is shown in the setup photographs.

The final scans performed on the worst axis, Y-Axis, for three operating channels;

6.5 Mbit/s for 802.11n HT20 Mode: 5180 MHz, 5200 MHz, 5240 MHz

13.5 Mbit/s for 802.11n HT40 Mode: 5190 MHz, 5230 MHz

4.5.1.3 Deviations

None.

4.5.2 Transmitter Spurious Emission Limit

The spurious emissions of the transmitter shall not exceed the values in CFR47 Part 15.205, 15.209: 2009 and RSS 210 A1.1.2 2007.

Frequency (MHz)	Field strength (microvolts/meter)	Measurement distance (meters)
0.009-0.490	2400/F (kHz)	300
0.490-1.705	24000/F (kHz)	30
1.705-30.0	30	30
30-88	100 **	3
88-216	150 **	3
216-960	200 **	3
Above 960	500	3

According to CFR47 15.407 (b), all harmonics and spurious emissions which are outside the 5150 MHz - 5250 MHz, 5250 MHz – 5350 MHz, or 5470 MHz – 5725 MHz shall not exceed -27 dBm/MHz. This is equivalent to 68.2 dBuV/m at 3 meter distance.

4.5.3 Test Results

The final measurement data was taken under the worst case operating modes, configurations, and/or cable positions. It also reflects the results including any modifications and/or special accessories listed in Sections 1.4 and test plan.

As originally tested, the EUT was found to be compliant to the requirements of the test standard(s).

Table 7: Transmit Spurious Emission at Band-Edge Requirements

Test Conditions: Radiated Measurement, Normal Temperature and Voltage only								
Antenna Type: Integrated				Power Setting: See test plan				
Max. Directional Gain: + 8 dBi				Signal State: Modulated at 100%.				
Ambient Temp.: 23° C				Relative Humidity: 33%				
Band-Edge Results								
Freq. (MHz)	Level (dBuV/m)	Polarity (H/V)	Limit (dBuV/m)	Margin (dB)	Det.	Table Deg.	Tower (cm)	Note
5150.00	62.32	V	74.00	-11.68	Pk	171	135	HT20, 5180 MHz, 11 dBm
5150.00	45.04	V	54.00	-8.96	Ave	171	135	HT20, 5180 MHz, 11 dBm
5150.00	63.67	H	74.00	-10.33	Pk	265	193	HT20, 5180 MHz, 11 dBm
5150.00	44.17	H	54.00	-9.83	Ave	265	193	HT20, 5180 MHz, 11 dBm
5150.00	62.35	H	74.00	-11.65	Pk	264	232	HT20, 5240 MHz, 11 dBm
5150.00	43.56	H	54.00	-10.44	Ave	264	232	HT20, 5240 MHz, 11 dBm
5150.00	63.46	V	74.00	-10.54	Pk	298	173	HT20, 5240 MHz, 11 dBm
5150.00	43.15	V	54.00	-10.85	Ave	298	173	HT20, 5240 MHz, 11 dBm
5150.00	64.89	V	74.00	-9.11	Pk	295	176	HT40, 5190 MHz, 11 dBm
5150.00	48.62	V	54.00	-5.38	Ave	295	176	HT40, 5190 MHz, 11 dBm
5150.00	64.54	H	74.00	-9.46	Pk	263	192	HT40, 5190 MHz, 11 dBm
5150.00	48.34	H	54.00	-5.66	Ave	263	192	HT40, 5190 MHz, 11 dBm
5150.00	62.64	H	74.00	-11.36	Pk	261	190	HT40, 5230 MHz, 11 dBm
5150.00	42.96	H	54.00	-11.04	Ave	261	190	HT40, 5230 MHz, 11 dBm
5150.00	62.33	V	74.00	-11.67	Pk	296	190	HT40, 5230 MHz, 11 dBm
5150.00	42.15	V	54.00	-11.85	Ave	296	190	HT40, 5230 MHz, 11 dBm
<p>Note: 1. Band-edge frequencies were taken at 5150 MHz since 5250-5350 MHz band is not a restricted band. 2. All the band-edge measurements met the restricted band requirements of CFR47 15.205. 3. It is also complied with the -27 dBm/MHz (68.2dBuV/m at 3m) requirements as stated in CFR47 15.407 (b) (1) to 15.407 (b) (3).</p>								

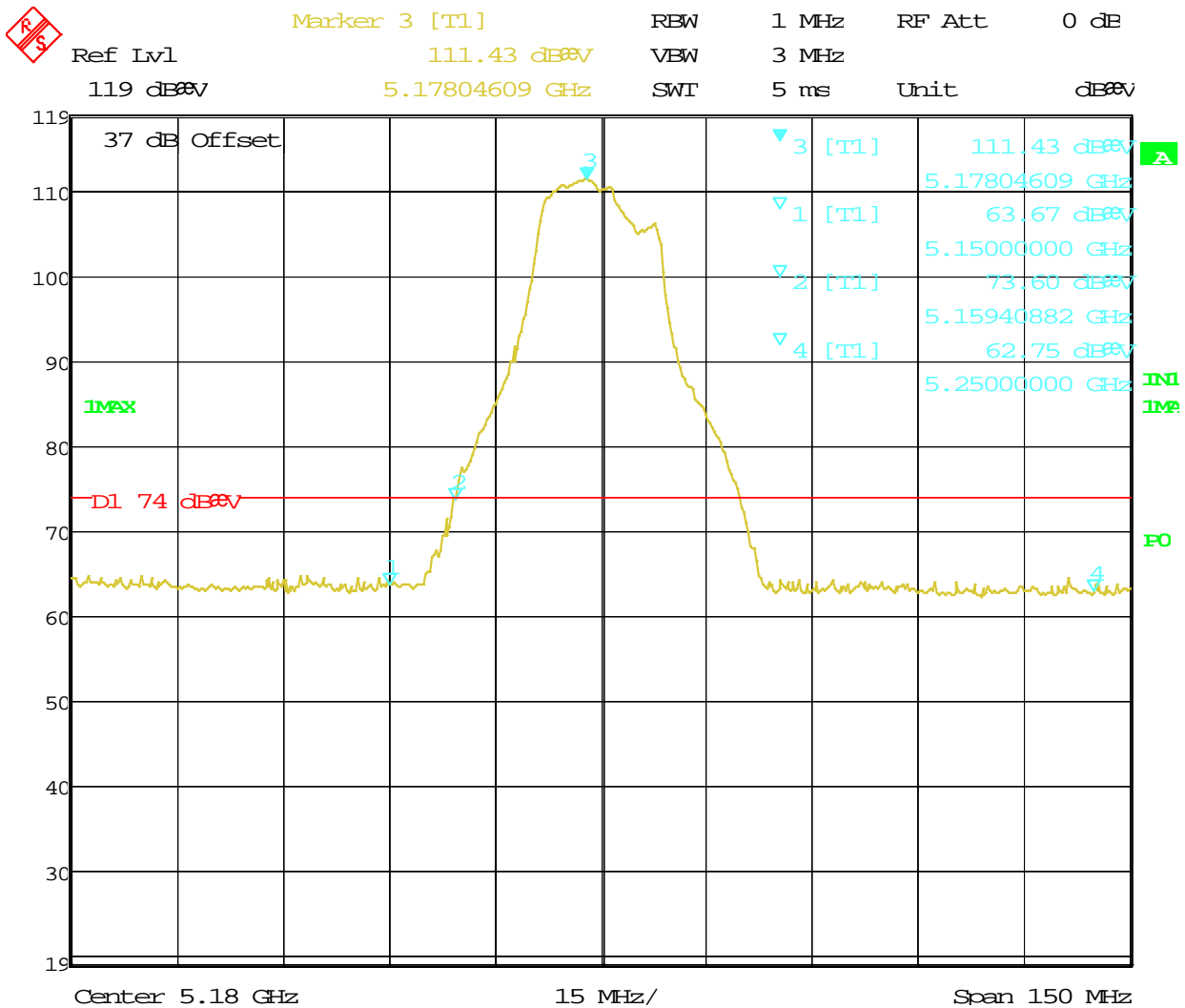

Date: 11.MAR.2013 12:51:39

Figure 84: Radiated Emission at the Edge for Channel 5180 MHz at 6.5Mbps – Horz. (Peak)

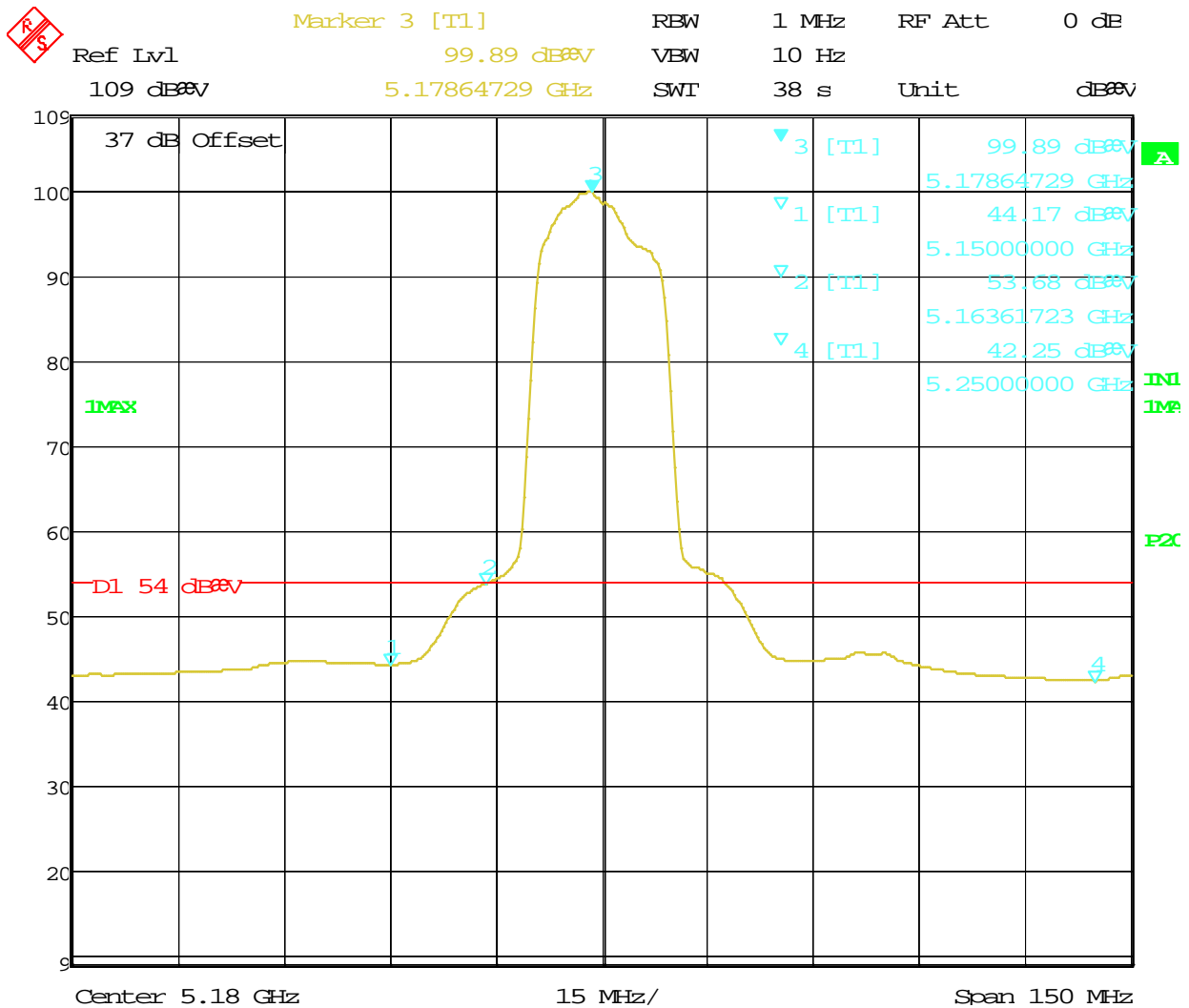

Date: 11.MAR.2013 12:52:50

Figure 85: Radiated Emission at the Edge for Channel 5180 MHz at 6.5Mbps – Horz. (Ave.)

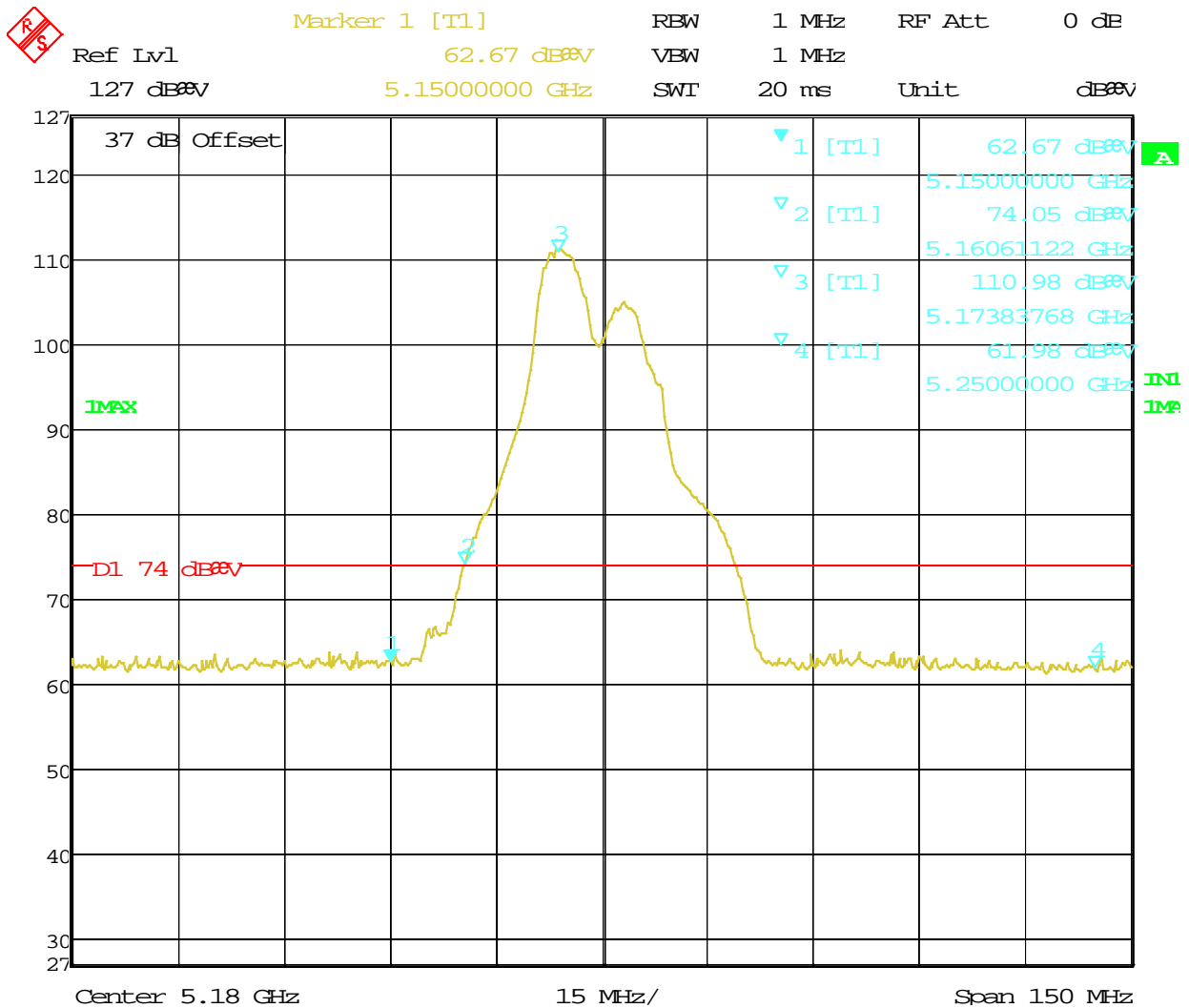

Date: 11.MAR.2013 12:43:37

Figure 86: Radiated Emission at the Edge for Channel 5180 MHz at 6.5Mbps – Vert. (Peak)

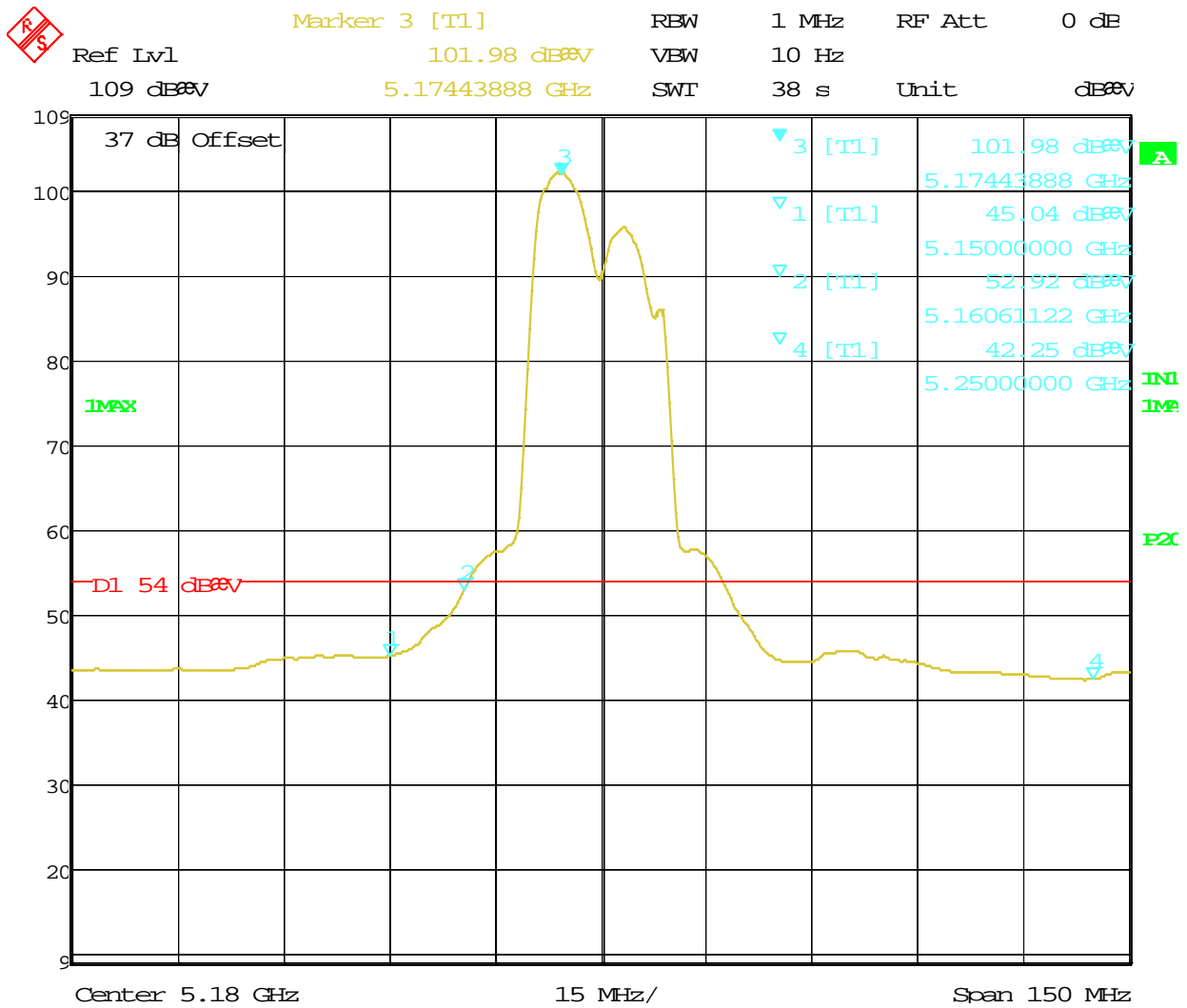

Date: 11.MAR.2013 12:46:59

Figure 87: Radiated Emission at the Edge for Channel 5180 MHz at 6.5Mbps – Vert. (Ave.)

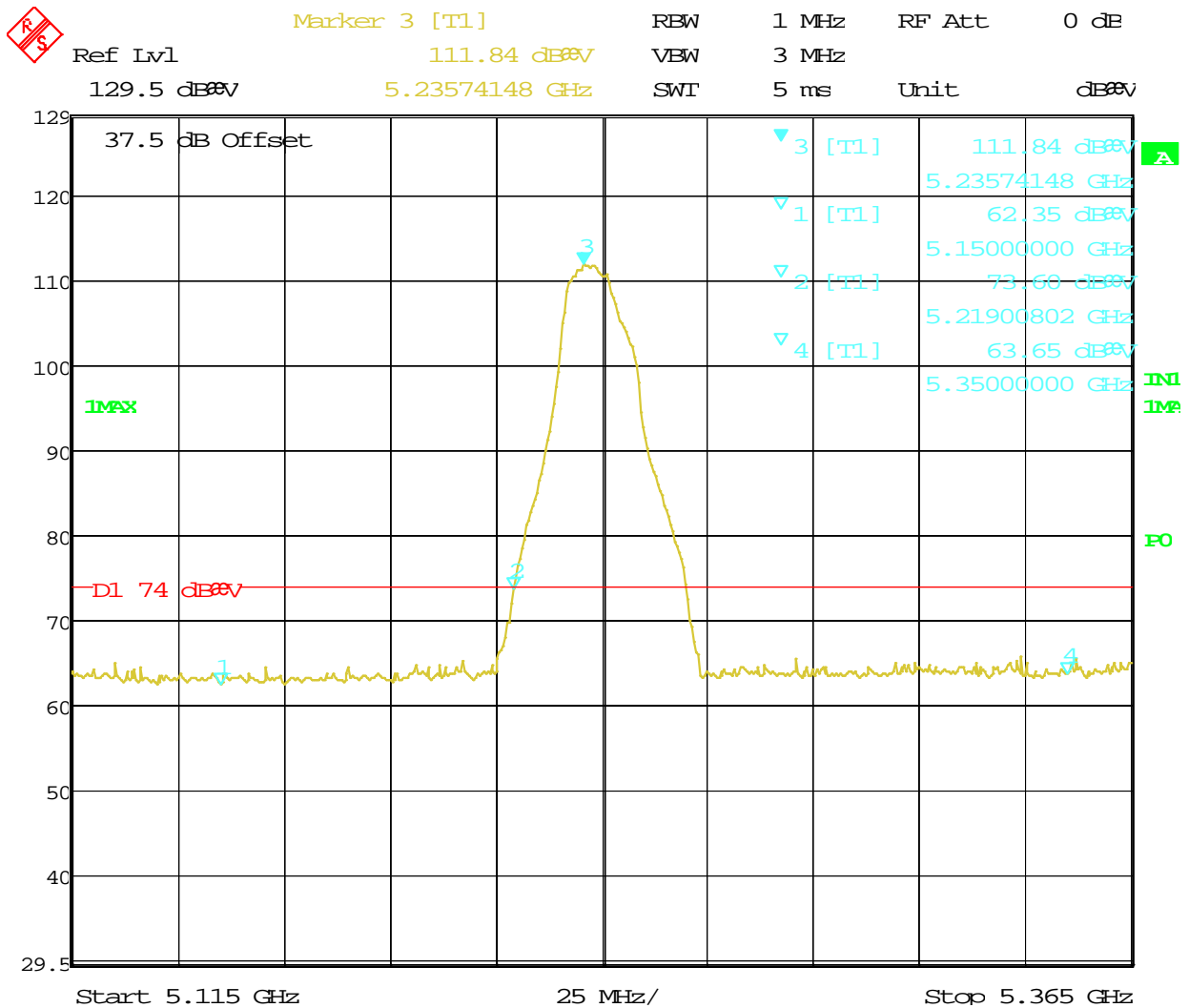

Date: 11.MAR.2013 13:09:48

Figure 88: Radiated Emission at the Edge for Channel 5240 MHz at 6.5Mbps – Horz. (Peak)

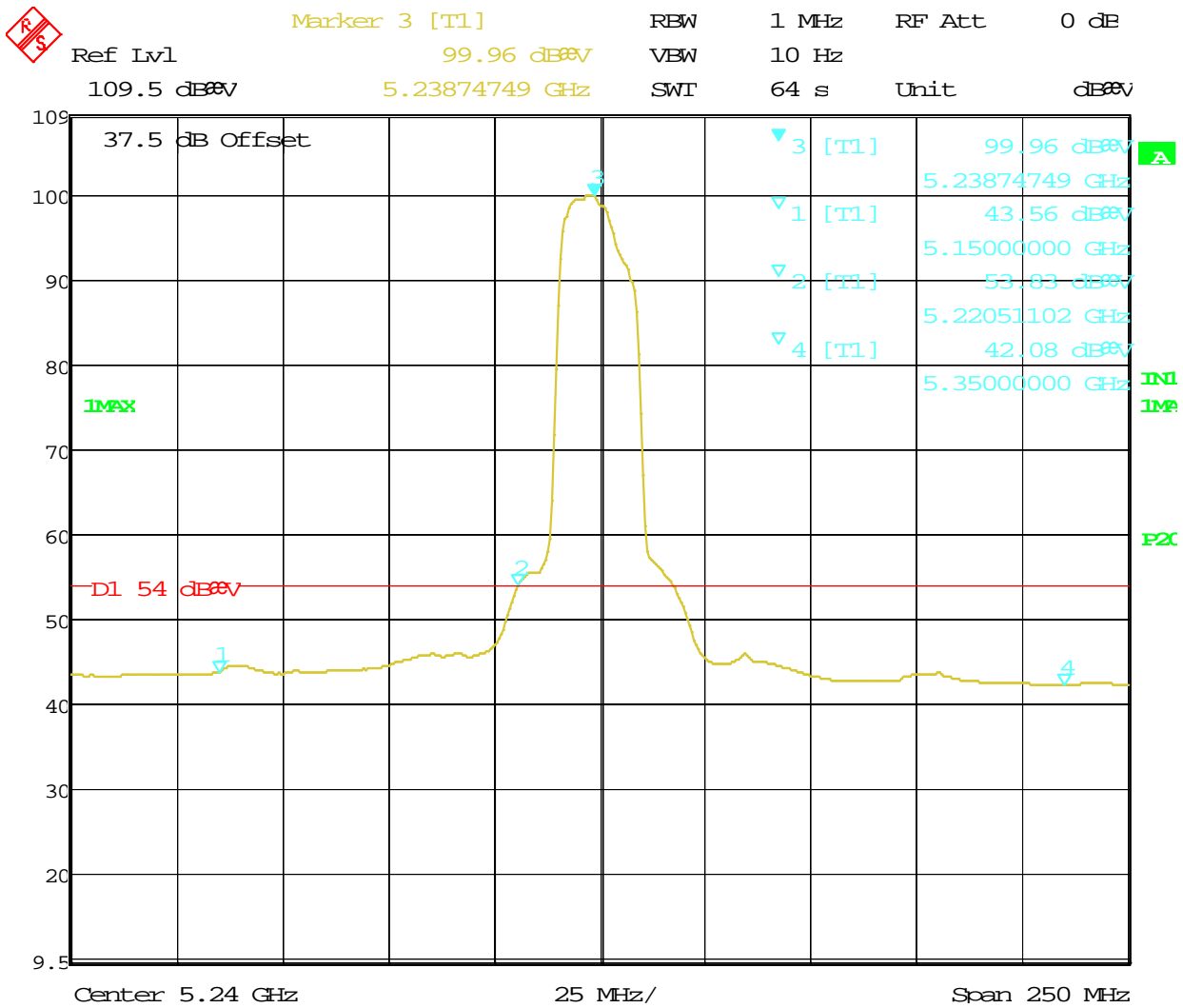

Date: 11.MAR.2013 13:11:22

Figure 89: Radiated Emission at the Edge for Channel 5240 MHz at 6.5Mbps – Horz. (Ave.)

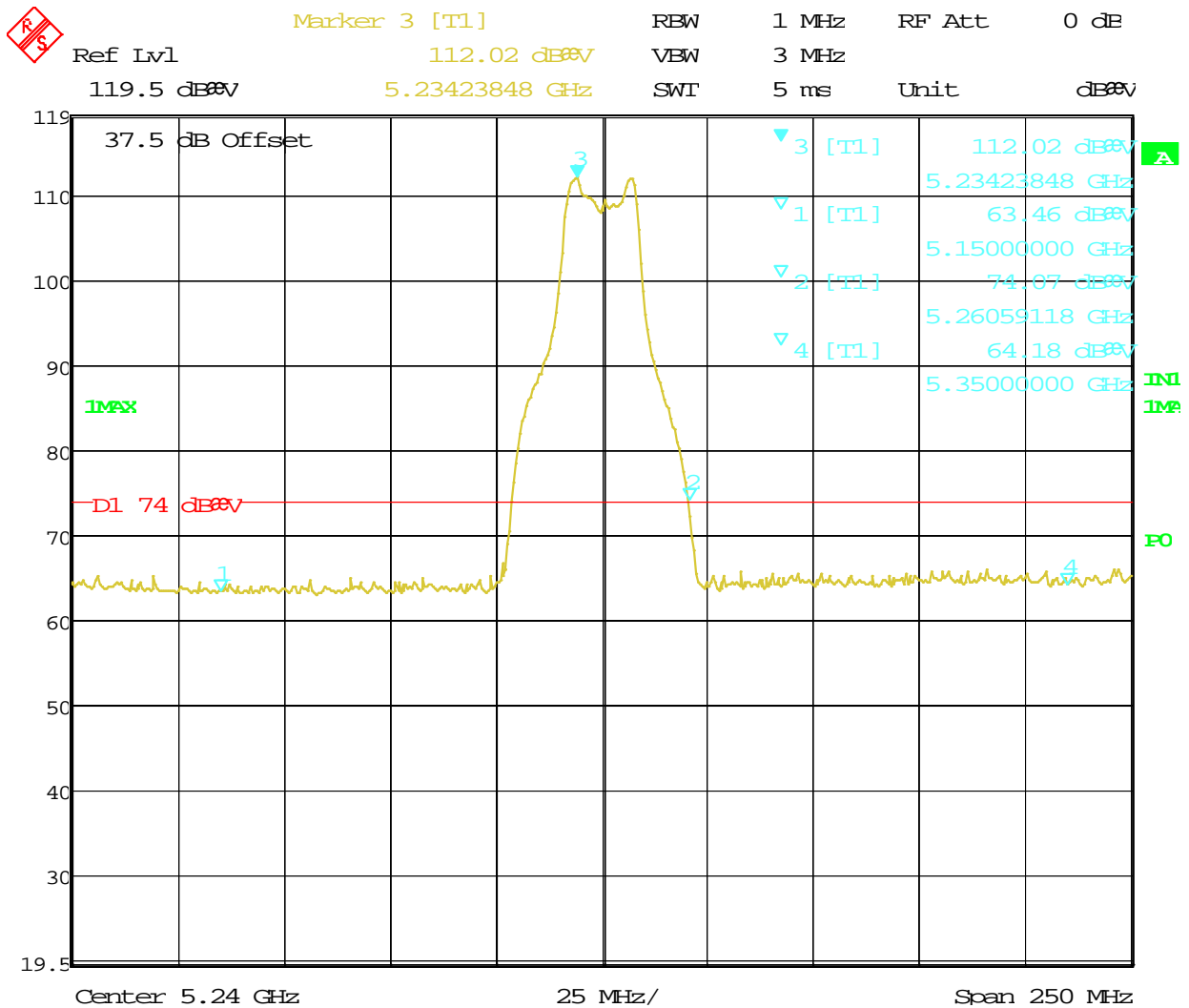

Date: 11.MAR.2013 13:14:11

Figure 90: Radiated Emission at the Edge for Channel 5240 MHz at 6.5Mbps – Vert. (Peak)

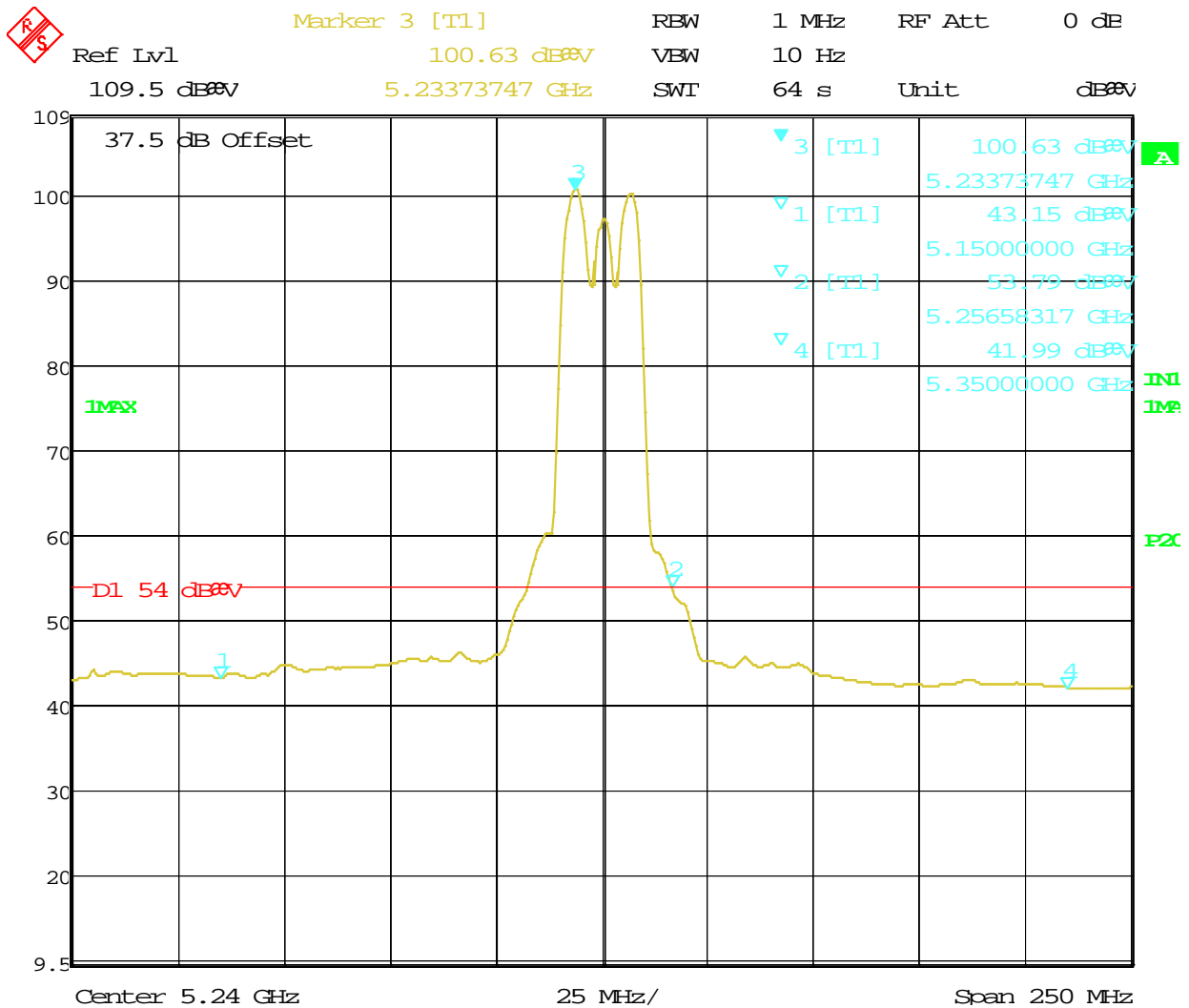

Date: 11.MAR.2013 13:15:40

Figure 91: Radiated Emission at the Edge for Channel 5240 MHz at 6.5Mbps – Vert. (Ave.)

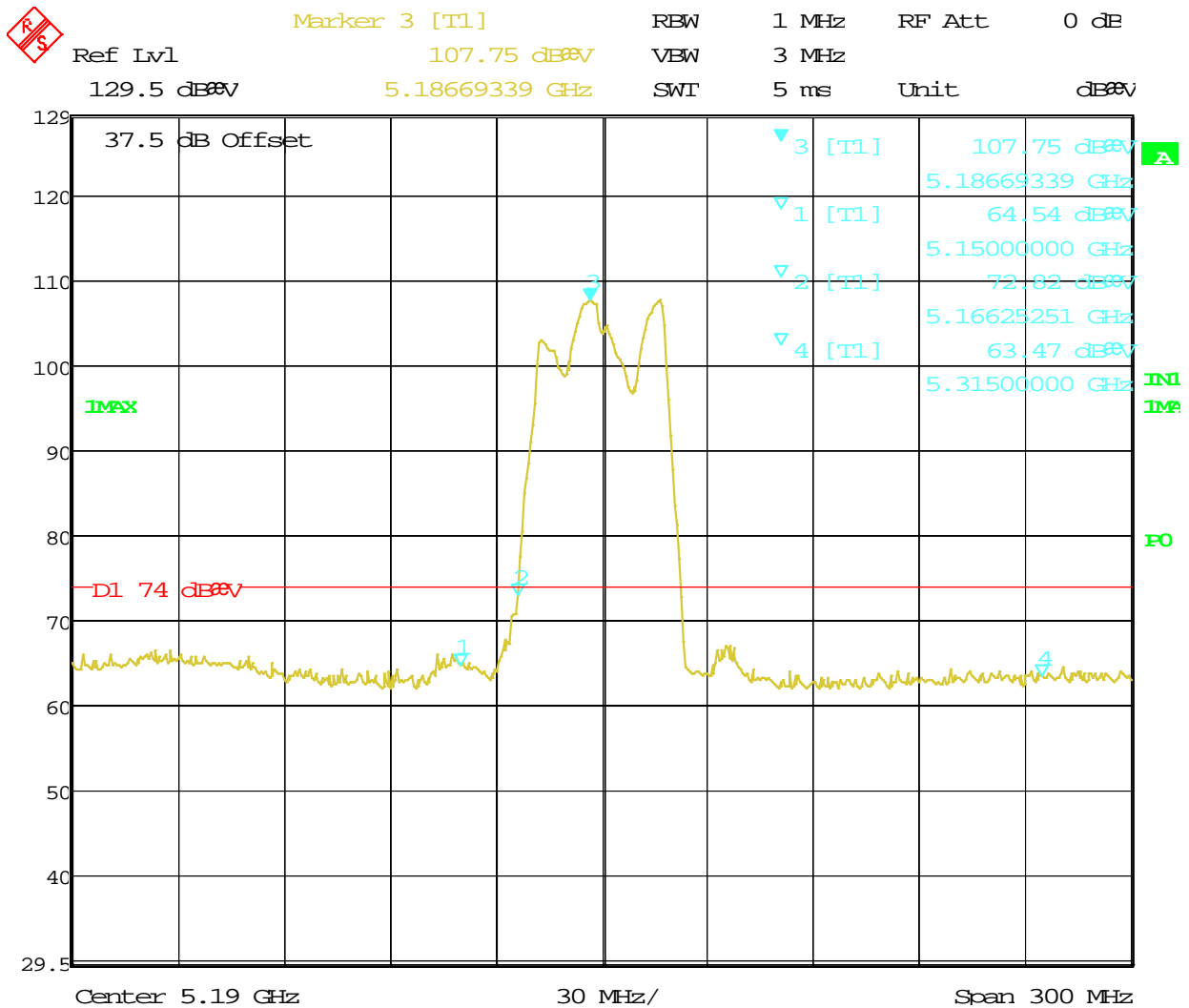

Date: 11.MAR.2013 13:27:45

Figure 92: Radiated Emission at the Edge for Channel 5190 MHz at 13.5Mbps – Horz. (Peak)

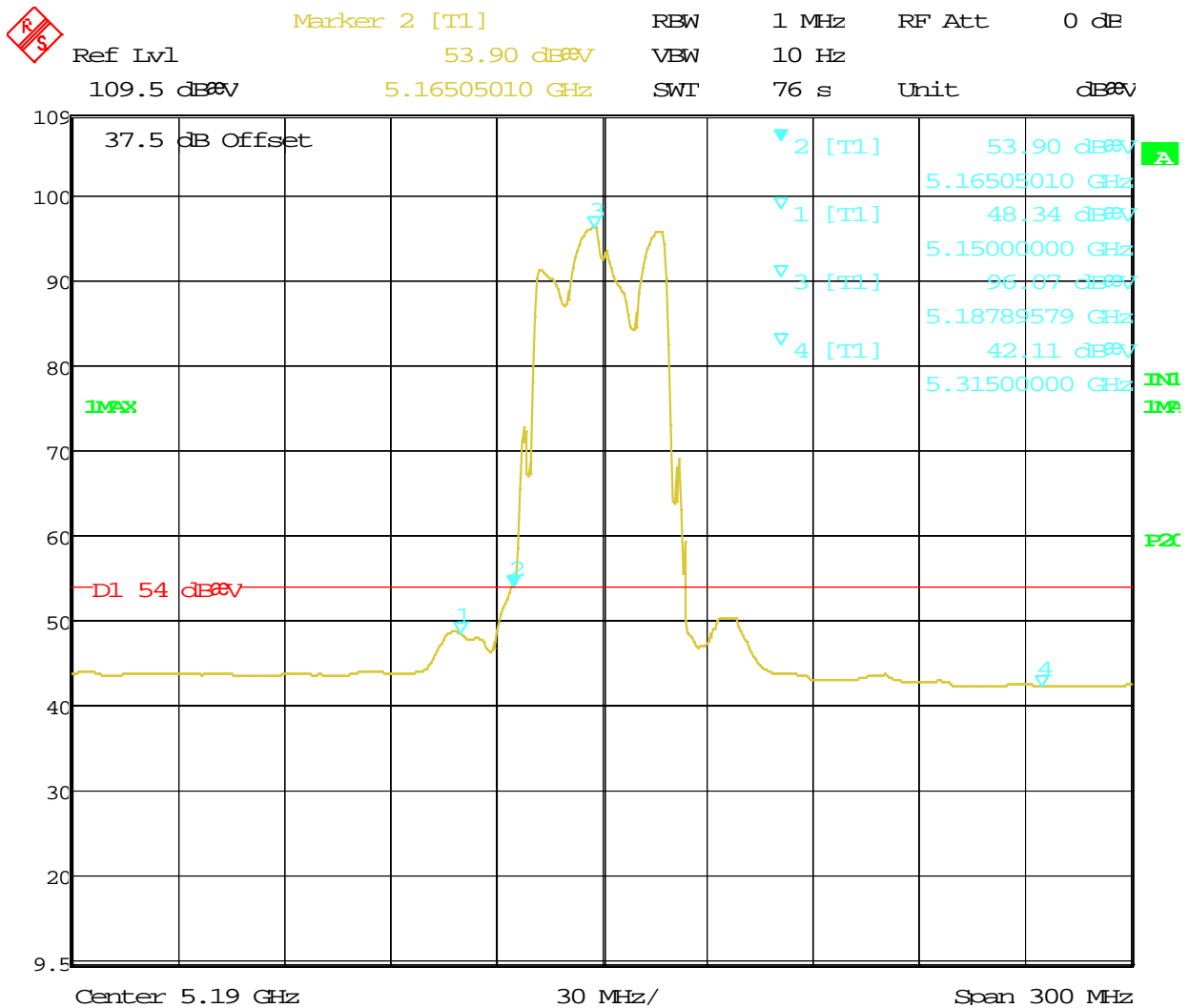

Date: 11.MAR.2013 13:29:19

Figure 93: Radiated Emission at the Edge for Channel 5190 MHz at 13.5Mbps – Horz. (Ave.)

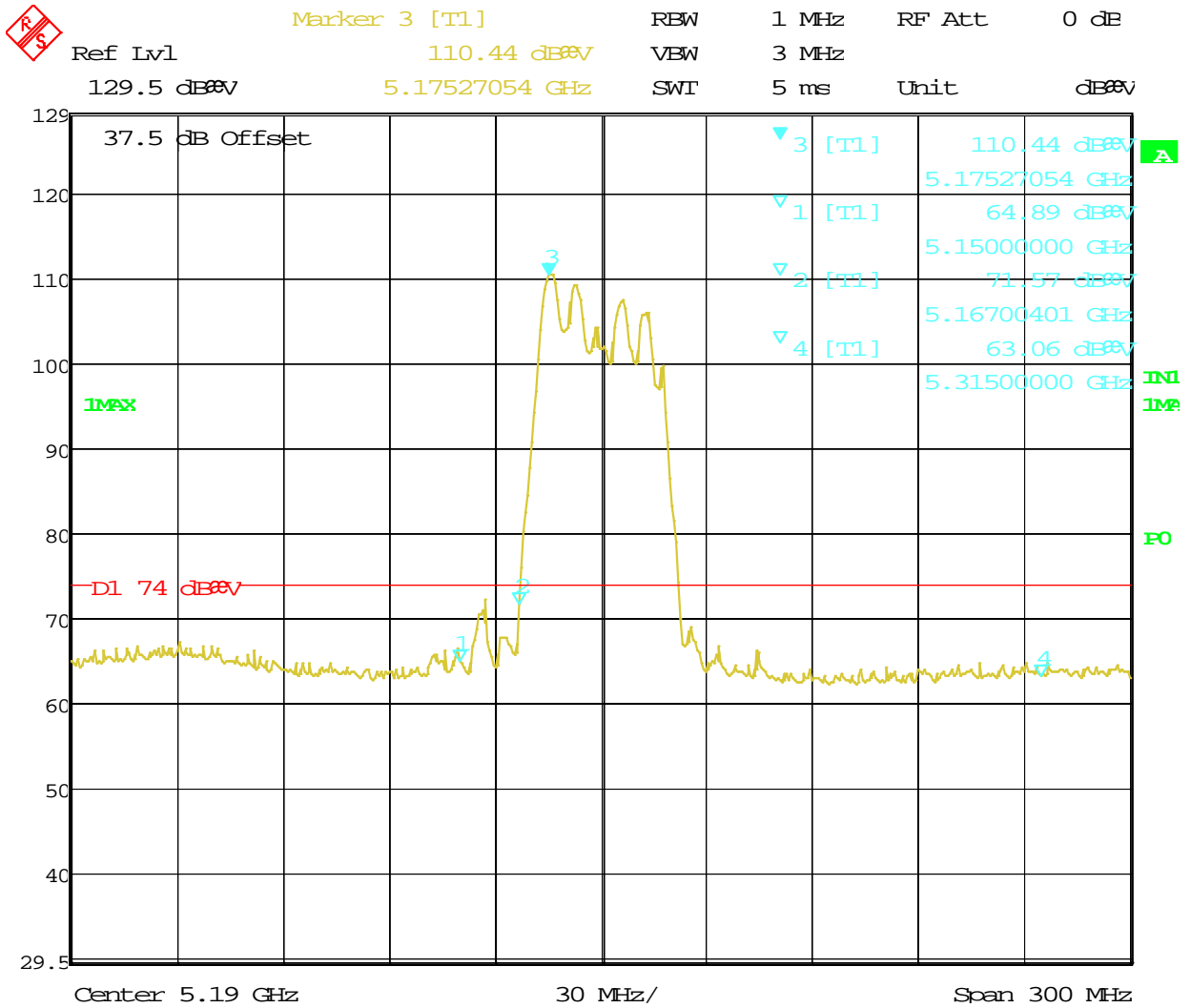

Date: 11.MAR.2013 13:22:14

Figure 94: Radiated Emission at the Edge for Channel 5190 MHz at 13.5Mbps – Vert. (Peak)

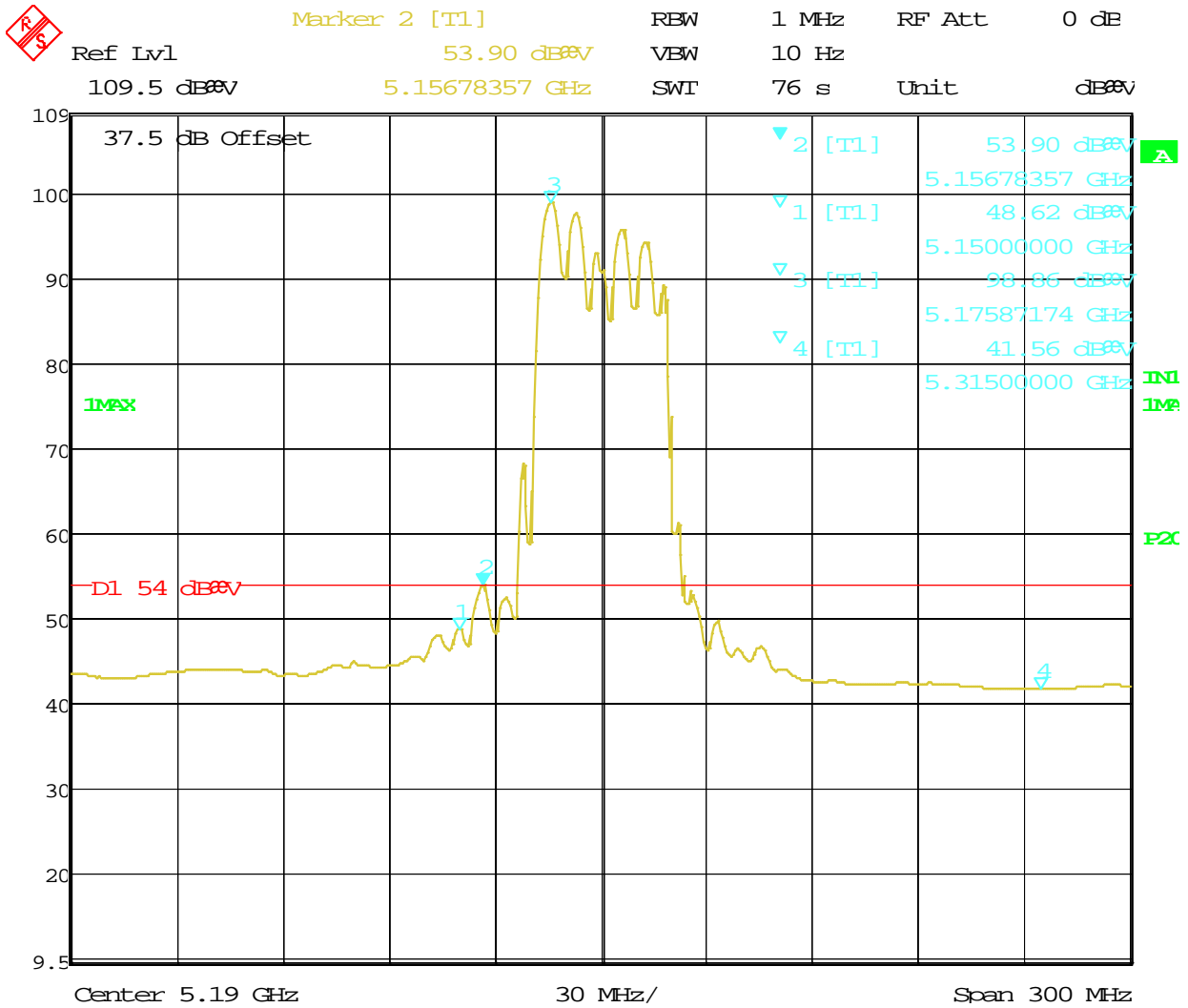

Date: 11.MAR.2013 13:24:17

Figure 95: Radiated Emission at the Edge for Channel 5190 MHz at 13.5Mbps – Vert. (Ave.)

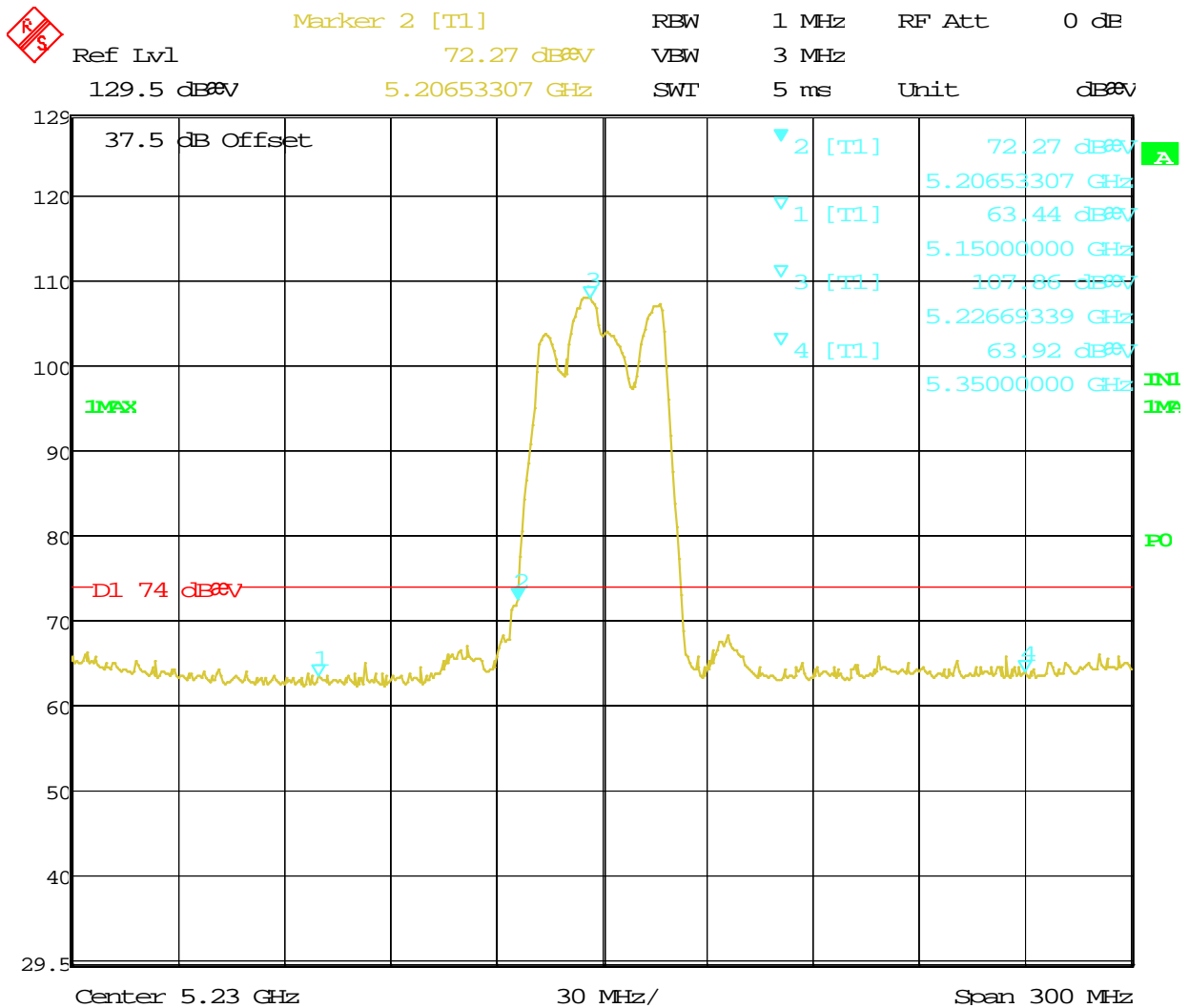

Date: 11.MAR.2013 13:35:56

Figure 96: Radiated Emission at the Edge for Channel 5230 MHz at 13.5Mbps – Horz (Peak)

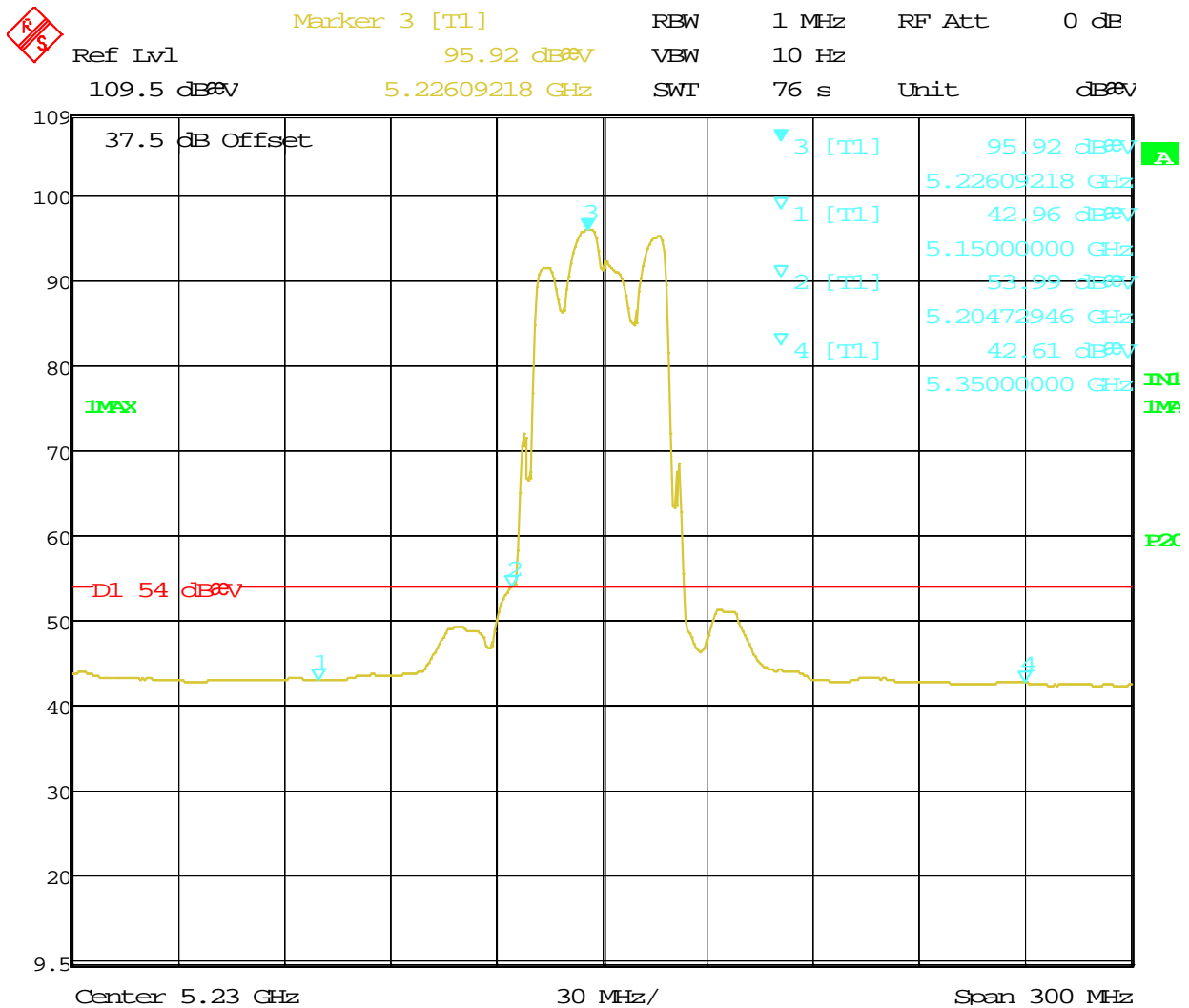

Date: 11.MAR.2013 13:37:34

Figure 97: Radiated Emission at the Edge for Channel 5230 MHz at 13.5Mbps – Horz (Ave.)

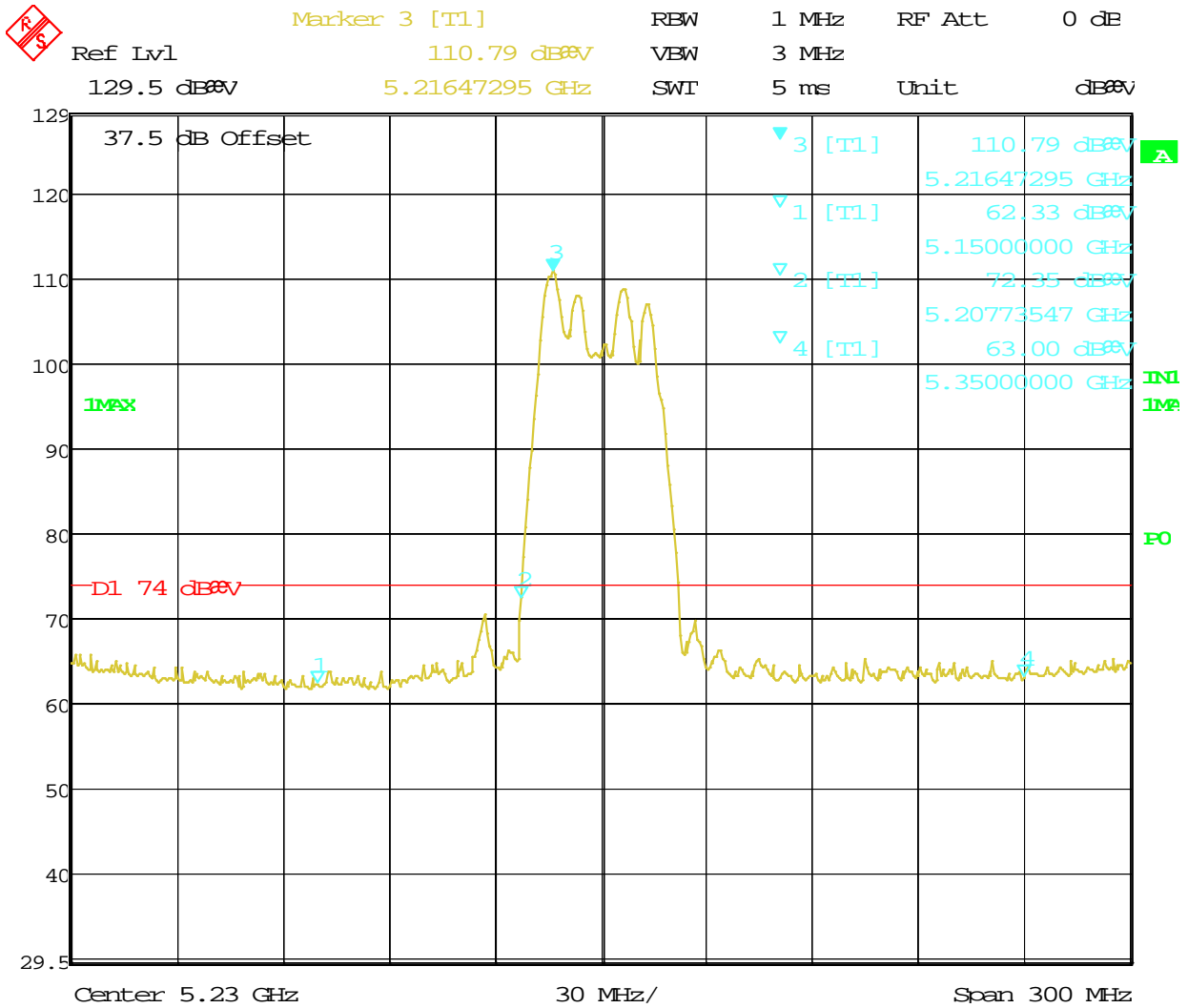

Date: 11.MAR.2013 13:40:40

Figure 98: Radiated Emission at the Edge for Channel 5230 MHz at 13.5Mbps – Vert (Peak)

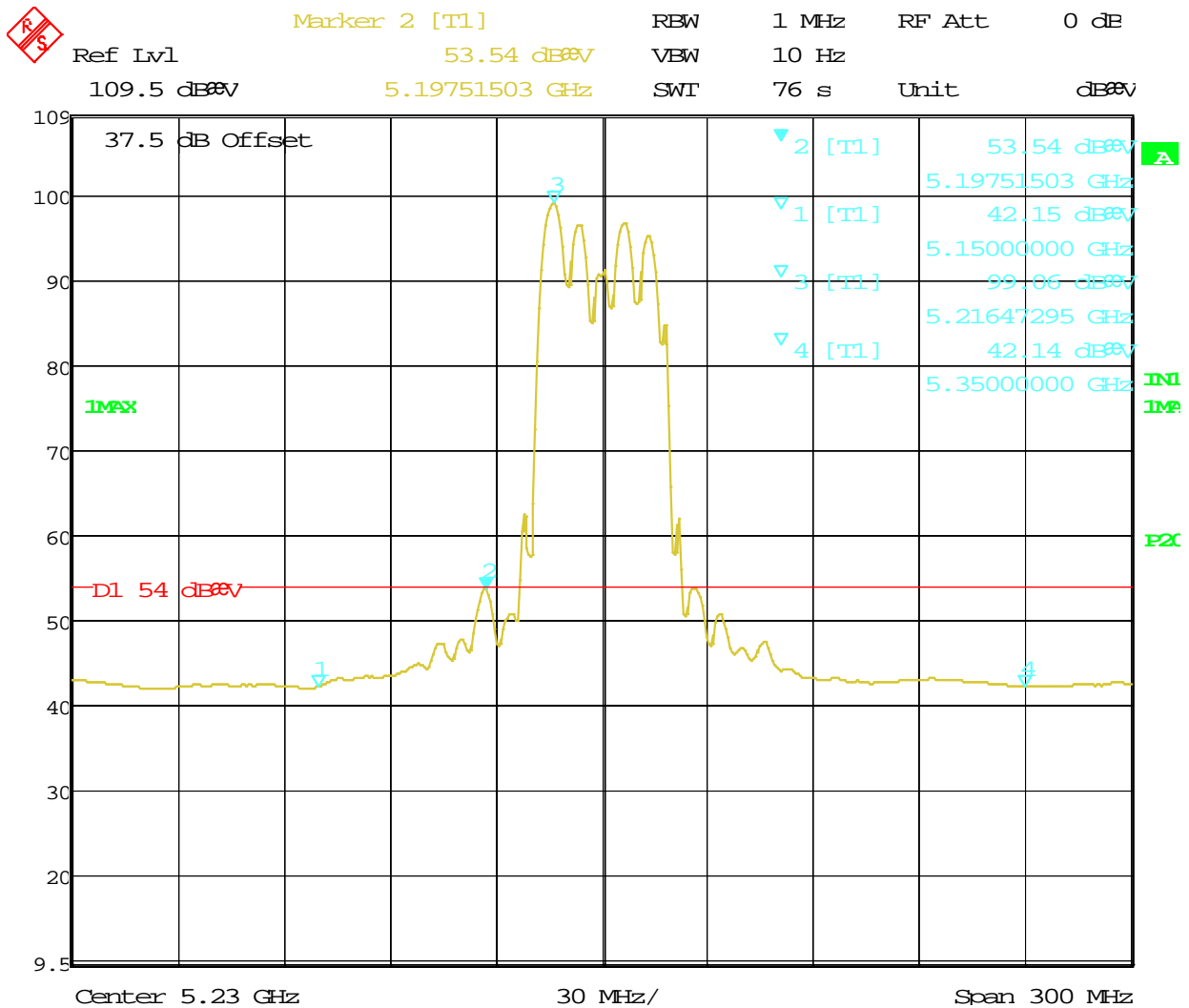

Date: 11.MAR.2013 13:42:29

Figure 99: Radiated Emission at the Edge for Channel 5230 MHz at 13.5Mbps – Vert (Ave.)

SOP 1 Radiated Emissions					Tracking # 31360999.001 Page 1 of 15				
EUT Name		Wireless Video Access Point			Date		April 30, 2013		
EUT Model		405			Temp / Hum in		23° C / 28%rh		
EUT Serial		Prototype			Temp / Hum out		N/A		
EUT Config.		Y-Axis, 802.11n HT20 at 6.5 Mbps/ chain			Line AC / Freq		120Vac/60Hz		
Standard		CFR47 Part 15 Subpart C			RBW / VBW		120 kHz/ 300 kHz		
Dist/Ant Used		3m / JB3			Performed by		Jeremy Luong		
Emission Freq (MHz)	ANT Polar (H/V)	ANT Pos (cm)	Table Pos (deg)	FIM QP (dBuV/m)	Total CF (dBuV)	E-Field Ave (dBuV/m)	Spec Limit (dBuV/m)	Spec Margin (dB)	Type
30 MHz to 1 GHz Transmitted at 802.11n HT20, 5200 MHz 6.5 Mbps/chain									
47.08	V	125	182	49.78	-17.17	32.61	40.00	-7.39	Spurious
70.17	V	99	220	49.87	-18.10	31.77	40.00	-8.23	Spurious
145.07	V	99	226	51.75	-12.89	38.87	43.50	-4.63	Spurious
167.63	V	129	176	49.88	-13.43	36.45	43.50	-7.05	Spurious
206.24	V	102	56	50.07	-13.64	36.44	43.50	-7.06	Spurious
245.53	V	123	60	51.04	-12.69	38.36	46.00	-7.65	Spurious
279.97	V	153	52	48.46	-10.88	37.58	46.00	-8.42	Spurious
320.00	H	99	78	54.67	-10.13	44.54	46.00	-1.46	Spurious
575.02	V	99	264	49.72	-5.84	43.88	46.00	-2.13	Spurious
640.00	V	115	98	46.08	-4.75	41.33	46.00	-4.67	Spurious
Spec Margin = E-Field QP - Limit, E-Field QP = FIM QP+ Total CF ± Uncertainty									
Total CF= Amp Gain + Cable Loss + ANT Factor									
Combined Standard Uncertainty $u_c(y) = \pm 3.2$ dB Expanded Uncertainty $U = k u_c(y)$ $k = 2$ for 95% confidence									
Notes: Worst case was observed on Y-axis at 802.11n HT20, 5200 MHz 6.5 Mbps. All other emissions passed Class B limit.									

SOP 1 Radiated Emissions

Tracking # 31360999.001 Page 2 of 15

EUT Name	Wireless Video Access Point	Date	April 30, 2013
EUT Model	405	Temp / Hum in	23° C / 28%rh
EUT Serial	Prototype	Temp / Hum out	N/A
EUT Config.	Y-Axis, 802.11n HT20 at 6.5 Mbps/ chain	Line AC	120Vac 60Hz
Standard	CFR47 Part 15 Subpart C	RBW / VBW	120 kHz / 300 kHz
Dist/Ant Used	3m – JB3	Performed by	Jeremy Luong

30 MHz to 1 GHz Plots for Transmit Mode at 5300 MHz

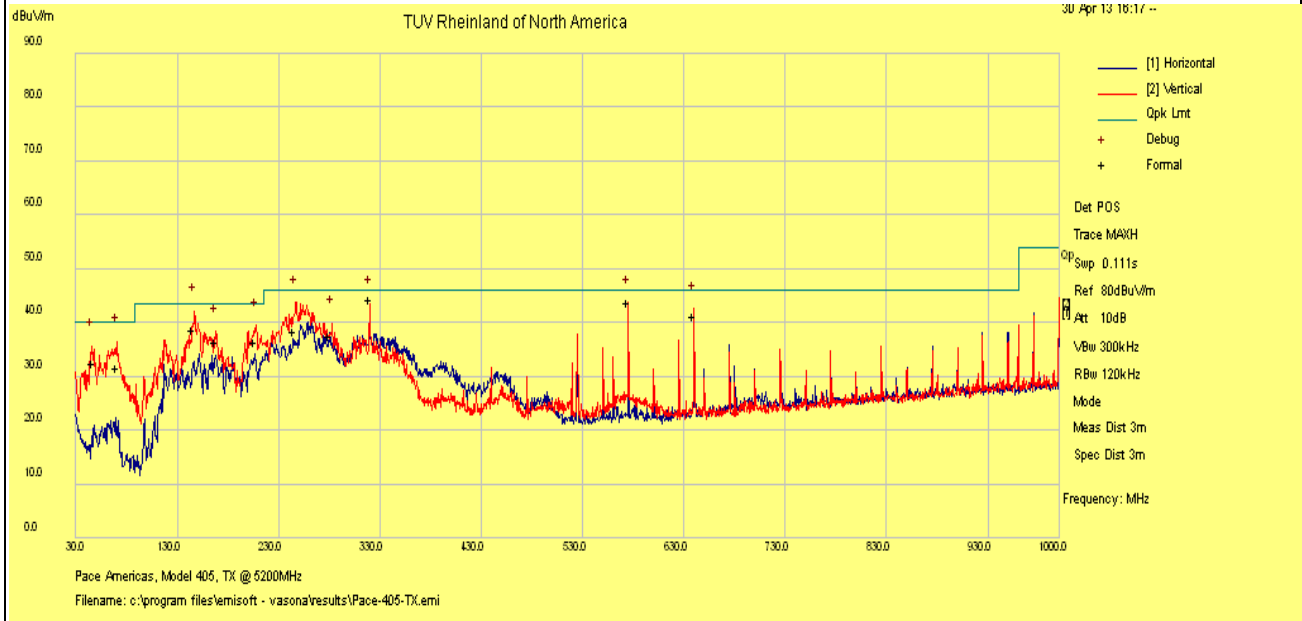

Notes: FCC Class B Limit.

SOP 1 Radiated Emissions					Tracking # 31360999.001 Page 3 of 15			
EUT Name	Wireless Video Access Point			Date	April 10, 2013			
EUT Model	405			Temp / Hum in	23° C / 33%rh			
EUT Serial	Prototype			Temp / Hum out	N/A			
EUT Config.	Y-Axis, 802.11 HT20 at 6.5 Mbps			Line AC / Freq	120Vac/60Hz			
Standard	CFR47 Part 15 Subpart C			RBW / VBW	1 MHz/ 3 MHz			
Dist/Ant Used	3m / EMCO3115 / 1m - RA42-K-F-4B-C			Performed by	Jeremy Luong			
Emission Freq (MHz)	ANT Polar (H/V)	ANT Pos (cm)	Table Pos (deg)	Peak (dBuV/m)	Average (dBuV/m)	Spec Limit (dBuV/m)	Spec Margin (dB)	Type
Transmitted Data at 5180 MHz @ 11 dBm								
1025.02	H	151	277	45.52	43.83	53.98	-10.15	Spurious
1279.94	H	172	42	47.67	43.72	53.98	-10.26	Spurious
4932.66	V	166	-53	53.57	42.60	53.98	-11.38	Spurious
4968.31	H	167	273	51.84	41.82	53.98	-12.16	Spurious
5582.82	V	164	233	53.51	43.19	53.98	-10.79	Spurious
6906.62	V	162	-48	54.14	45.12	53.98	-8.86	Spurious
10278.80	V	205	63	47.56	36.19	53.98	-17.79	Harmonics
20719.90	V	98	101	58.13	56.44	64.00	-7.56	Harmonics
20719.90	H	121	112	63.14	61.98	64.00	-2.02	Harmonics
25899.80	V	127	105	52.05	45.83	64.00	-18.17	Harmonics
25899.90	H	87	124	51.79	47.00	64.00	-17.00	Harmonics
Transmitted Data at 5200 MHz @ 11 dBm								
1024.97	H	274	402	43.53	41.57	53.98	-12.41	Spurious
1279.98	H	177	60	48.98	44.97	53.98	-9.01	Spurious
4952.39	H	333	274	54.25	43.51	53.98	-10.47	Spurious
4959.93	V	239	89	50.61	41.56	53.98	-12.42	Spurious
6933.33	V	318	-83	56.31	44.37	53.98	-9.61	Spurious
10399.80	H	217	131	49.17	40.58	53.98	-13.40	Harmonics
10399.90	V	216	126	49.62	41.59	53.98	-12.39	Harmonics
20799.80	V	101	134	57.73	55.55	64.00	-8.45	Harmonics
20799.90	H	98	422	63.27	61.69	64.00	-2.31	Harmonics
25999.70	H	93	123	51.13	41.29	64.00	-22.71	Harmonics
25999.80	V	95	149	52.86	46.83	64.00	-17.17	Harmonics
Transmitted Data at 5240 MHz @ 11 dBm								
1025.00	H	97	137	42.08	38.98	53.98	-15.00	Spurious
1280.00	H	172	304	47.39	43.38	53.98	-10.60	Spurious
4992.66	V	259	7	54.65	43.80	53.98	-10.18	Spurious
4992.75	H	306	271	57.47	47.11	53.98	-6.87	Spurious
5471.83	V	159	312	59.61	48.53	53.98	-5.45	Spurious
6986.66	V	206	-42	52.60	45.74	53.98	-8.24	Spurious
10479.90	V	101	470	49.76	43.07	53.98	-10.91	Harmonics
10479.90	H	114	51	50.22	43.21	53.98	-10.77	Harmonics

20959.90	V	101	133	56.44	55.24	64.00	-8.76	Harmonics
20959.90	H	93	95	63.58	62.20	64.00	-1.80	Harmonics
Spec Margin = E-Field Average - Limit, E-Field Average = Field Meas.+ Total CF ± Uncertainty								
Total CF= Amp Gain + Cable Loss + ANT Factor								
Combined Standard Uncertainty $u_c(y) = \pm 3.2$ dB Expanded Uncertainty $U = ku_c(y)$ $k = 2$ for 95% confidence								
Notes: Worst case was observed on Y-axis, 6.5 Mbps.								

SOP 1 Radiated Emissions				Tracking # 31360999.001 Page 4 of 15				
EUT Name	Wireless Video Access Point			Date	April 10, 2013			
EUT Model	405			Temp / Hum in	23° C / 33%rh			
EUT Serial	Prototype			Temp / Hum out	N/A			
EUT Config.	Y-Axis, 802.11 HT40 at 13.5 Mbps			Line AC / Freq	120Vac/60Hz			
Standard	CFR47 Part 15 Subpart C			RBW / VBW	1 MHz/ 3 MHz			
Dist/Ant Used	3m / EMCO3115 / 1m - RA42-K-F-4B-C			Performed by	Jeremy Luong			
Emission Freq (MHz)	ANT Polar (H/V)	ANT Pos (cm)	Table Pos (deg)	Peak (dBuV/m)	Average (dBuV/m)	Spec Limit (dBuV/m)	Spec Margin (dB)	Type
Transmitted Data at 5190 MHz @ 11 dBm								
1025.00	H	258	311	44.78	43.32	53.98	-10.66	Spurious
1280.00	H	101	55	49.89	46.17	53.98	-7.81	Spurious
4959.87	V	145	358	51.26	41.77	53.98	-12.21	Spurious
4968.08	H	277	-84	51.93	42.42	53.98	-11.56	Spurious
5531.24	V	185	178	51.19	40.12	53.98	-13.86	Spurious
6926.67	V	246	319	52.67	44.72	53.98	-9.26	Spurious
10389.90	H	159	406	50.39	44.00	53.98	-9.98	Harmonics
10390.00	V	111	104	49.57	40.96	53.98	-13.02	Harmonics
20759.90	V	112	133	59.13	56.96	64.00	-7.04	Harmonics
20759.80	H	111	86	63.98	62.54	64.00	-1.46	Harmonics
25949.80	H	113	130	51.65	45.79	64.00	-18.21	Harmonics
25949.90	V	111	129	52.51	46.45	64.00	-17.55	Harmonics
Transmitted Data at 5230 MHz @ 11 dBm								
1025.00	H	173	215	41.10	37.85	53.98	-16.13	Spurious
1279.98	H	175	44	50.97	47.29	53.98	-6.69	Spurious
4959.95	H	207	276	50.89	40.18	53.98	-13.80	Spurious
4973.66	V	186	301	52.70	41.42	53.98	-12.56	Spurious
5486.84	V	168	123	50.85	39.71	53.98	-14.27	Spurious
6973.22	H	260	220	54.93	39.30	53.98	-14.68	Spurious
6973.24	V	262	241	55.95	40.51	53.98	-13.47	Spurious
10459.90	V	176	63	52.77	41.20	53.98	-12.78	Harmonics
10459.90	H	157	161	49.25	39.95	53.98	-14.03	Harmonics
20919.80	V	112	95	55.68	52.85	64.00	-11.15	Harmonics
20919.80	H	120	63	63.94	62.84	64.00	-1.16	Harmonics
Spec Margin = E-Field Average - Limit, E-Field Average = Field Meas.+ Total CF ± Uncertainty								
Total CF= Amp Gain + Cable Loss + ANT Factor								
Combined Standard Uncertainty $u_c(y) = \pm 3.2$ dB Expanded Uncertainty $U = ku_c(y)$ $k = 2$ for 95% confidence								
Notes: Worst case was observed on Y-axis, 13.5 Mbps.								

SOP 1 Radiated Emissions

Tracking # 31360999.001 Page 6 of 15

EUT Name	Wireless Video Access Point	Date	April 10, 2013
EUT Model	405	Temp / Hum in	23° C / 33%rh
EUT Serial	Prototype	Temp / Hum out	N/A
EUT Config.	Y-Axis, 802.11n HT20 at 6.5 Mbps	Line AC	120Vac 60Hz
Standard	CFR47 Part 15 Subpart C	RBW / VBW	1 MHz / 3 MHz
Dist/Ant Used	3m - EMCO3115 / 1m - RA42-K-F-4B-C	Performed by	Jeremy Luong

Above 1 GHz Plots for Transmit Mode at 5180 MHz

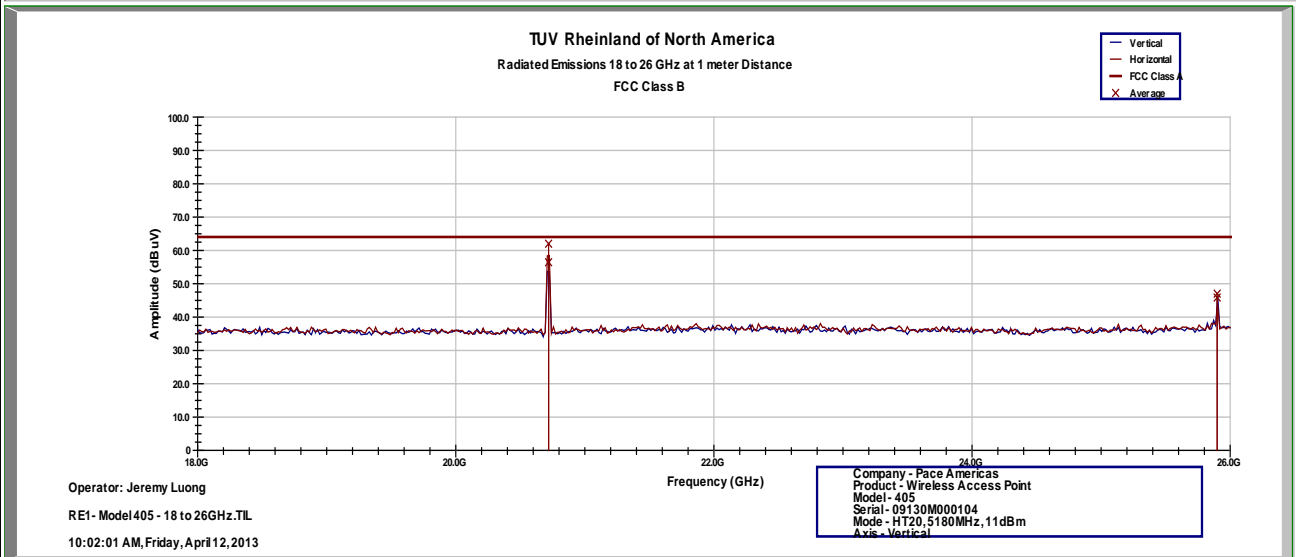
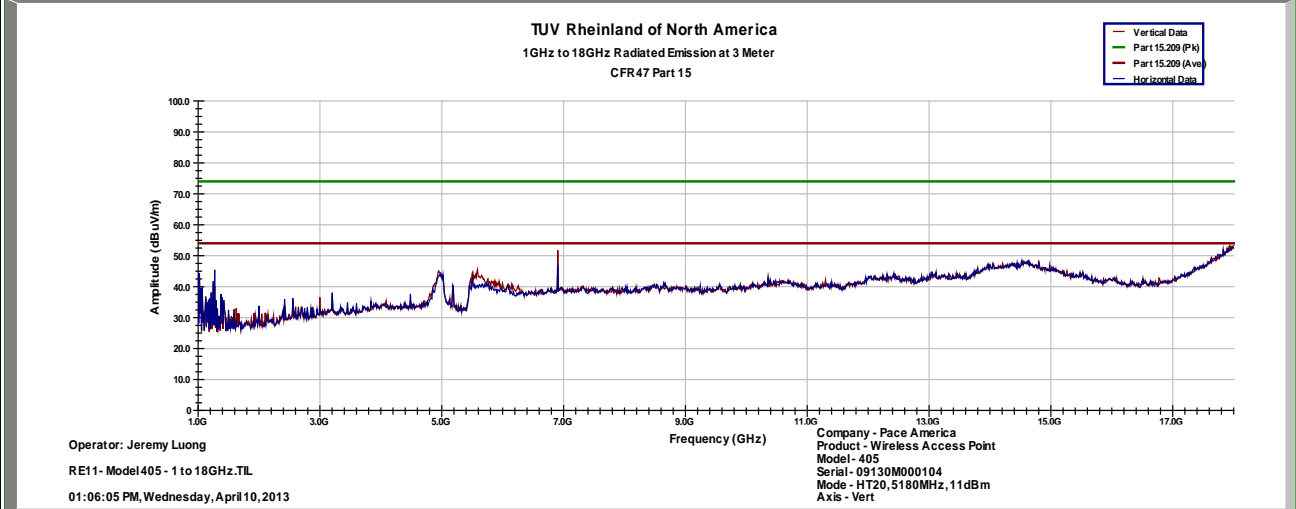

Notes: Limit was extrapolated to 1m distance for 18 GHz – 40 GHz range.

SOP 1 Radiated Emissions

Tracking # 31360999.001 Page 7 of 15

EUT Name	Wireless Video Access Point	Date	April 10, 2013
EUT Model	405	Temp / Hum in	23° C / 33%rh
EUT Serial	Prototype	Temp / Hum out	N/A
EUT Config.	Y-Axis, 802.11n HT20 at 6.5 Mbps	Line AC	120Vac 60Hz
Standard	CFR47 Part 15 Subpart C	RBW / VBW	1 MHz / 3 MHz
Dist/Ant Used	1m - RA42-K-F-4B-C	Performed by	Jeremy Luong

Above 1 GHz Plots for Transmit Mode at 5180 MHz

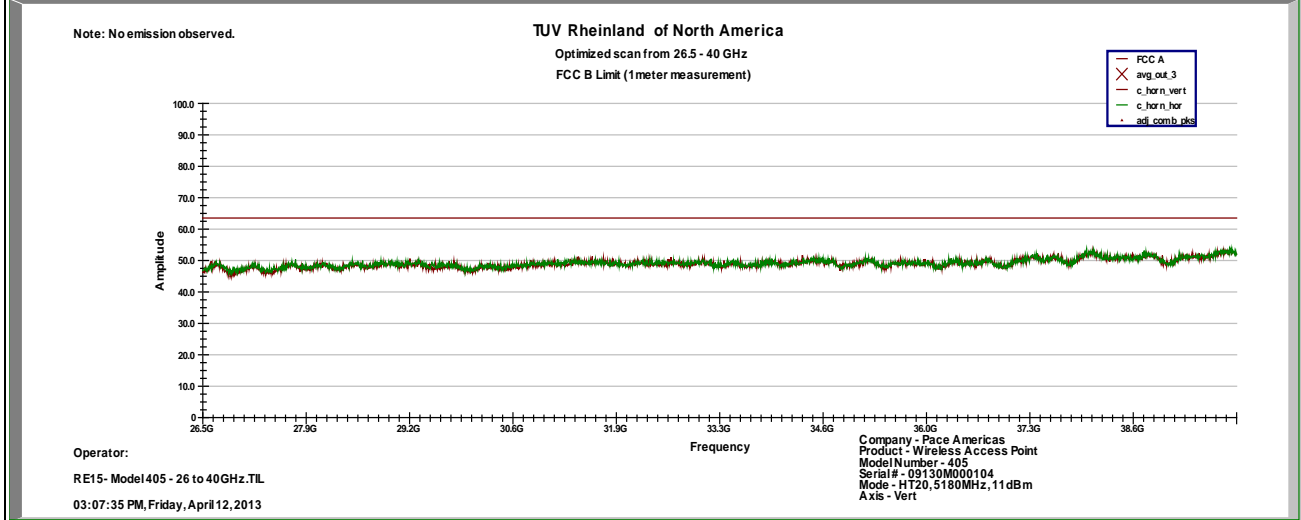

Notes: Limit was extrapolated to 1m distance for 18 GHz – 40 GHz range.

SOP 1 Radiated Emissions

Tracking # 31360999.001 Page 8 of 15

EUT Name	Wireless Video Access Point	Date	April 10, 2013
EUT Model	405	Temp / Hum in	23° C / 33%rh
EUT Serial	Prototype	Temp / Hum out	N/A
EUT Config.	Y-Axis, 802.11n HT20 at 6.5 Mbps	Line AC	120Vac 60Hz
Standard	CFR47 Part 15 Subpart C	RBW / VBW	1 MHz / 3 MHz
Dist/Ant Used	3m - EMCO3115 / 1m - RA42-K-F-4B-C	Performed by	Jeremy Luong

Above 1 GHz Plots for Transmit Mode at 5200 MHz

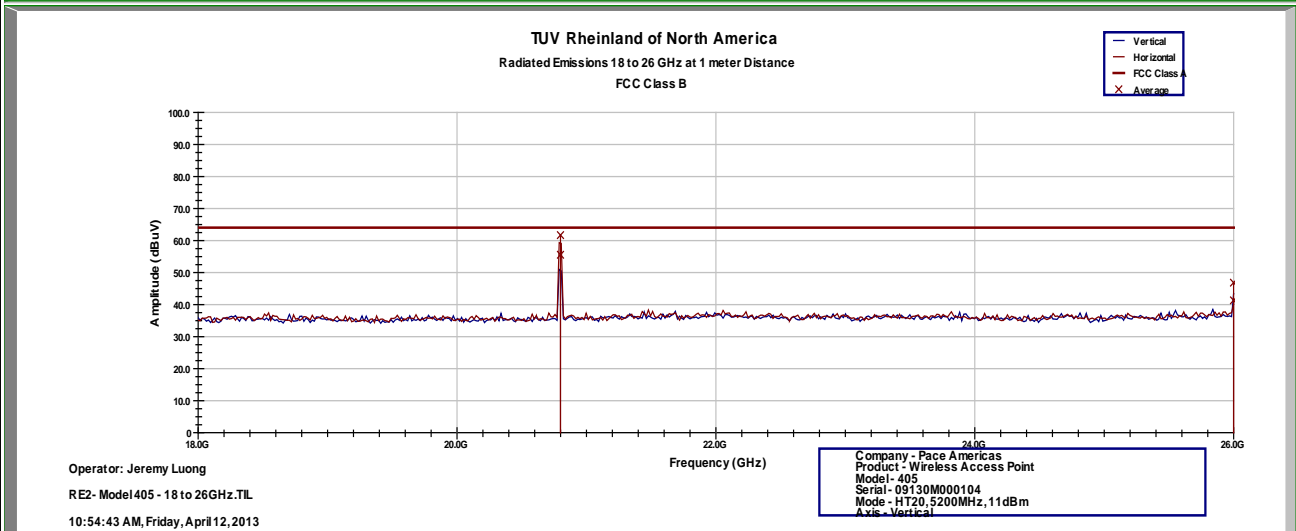
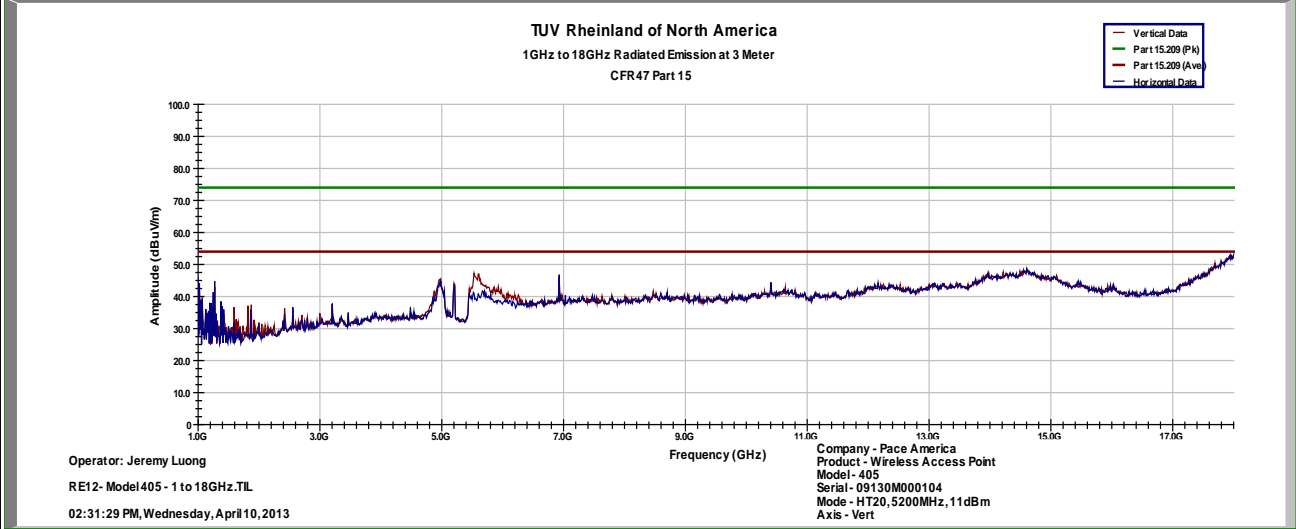

Notes: Limit was extrapolated to 1m distance for 18 GHz – 40 GHz range.

SOP 1 Radiated Emissions

Tracking # 31360999.001 Page 9 of 15

EUT Name	Wireless Video Access Point	Date	April 10, 2013
EUT Model	405	Temp / Hum in	23° C / 33%rh
EUT Serial	Prototype	Temp / Hum out	N/A
EUT Config.	Y-Axis, 802.11n HT20 at 6.5 Mbps	Line AC	120Vac 60Hz
Standard	CFR47 Part 15 Subpart C	RBW / VBW	1 MHz / 3 MHz
Dist/Ant Used	1m - RA42-K-F-4B-C	Performed by	Jeremy Luong

Above 1 GHz Plots for Transmit Mode at 5200 MHz

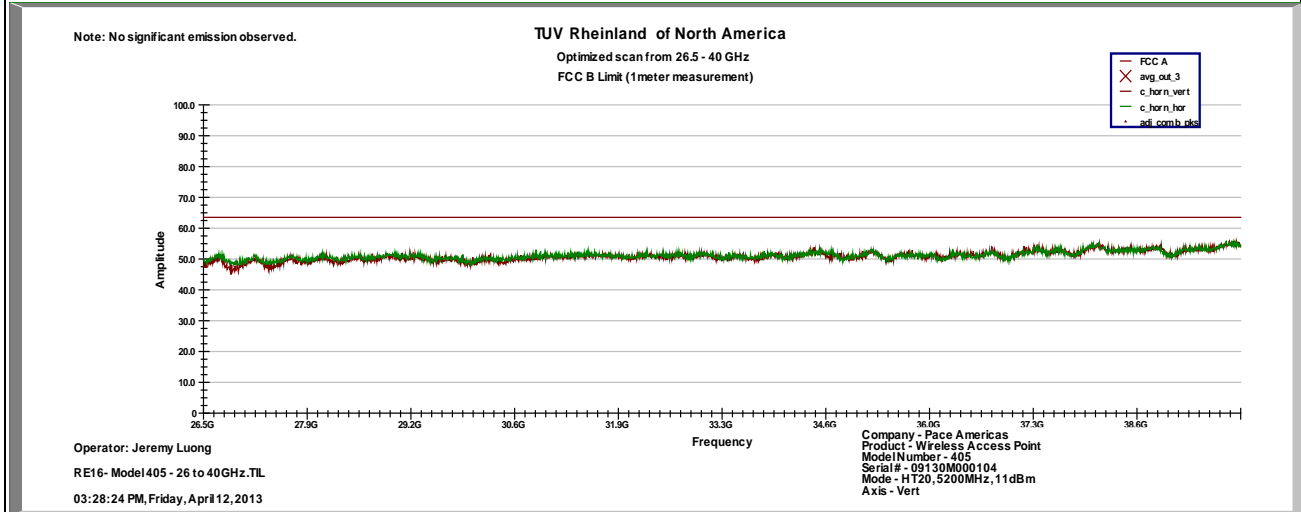

Notes: Limit was extrapolated to 1m distance for 18 GHz – 40 GHz range.

SOP 1 Radiated Emissions

Tracking # 31360999.001 Page 10 of 15

EUT Name	Wireless Video Access Point	Date	April 10, 2013
EUT Model	405	Temp / Hum in	23° C / 33%rh
EUT Serial	Prototype	Temp / Hum out	N/A
EUT Config.	Y-Axis, 802.11n HT20 at 6.5 Mbps	Line AC	120Vac 60Hz
Standard	CFR47 Part 15 Subpart C	RBW / VBW	1 MHz / 3 MHz
Dist/Ant Used	3m - EMCO3115 / 1m - RA42-K-F-4B-C	Performed by	Jeremy Luong

Above 1 GHz Plots for Transmit Mode at 5240 MHz

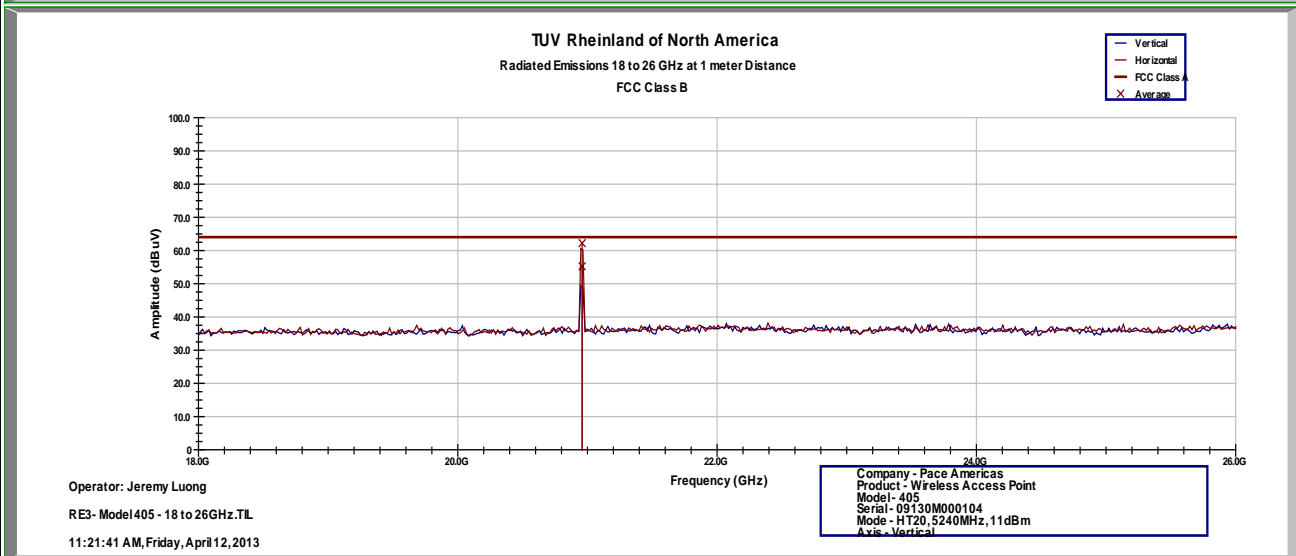
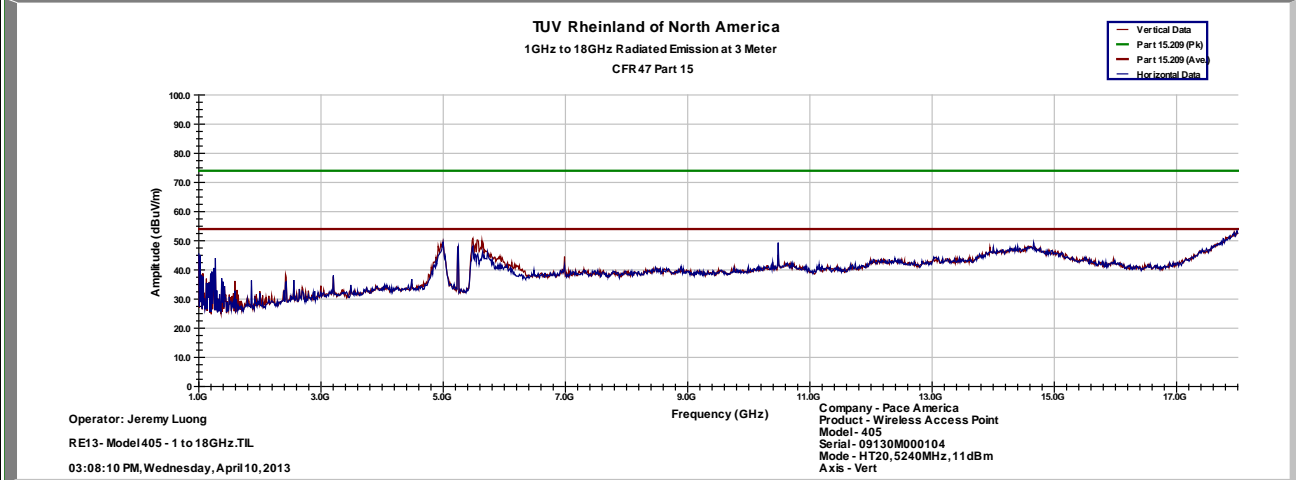

Notes: Limit was extrapolated to 1m distance for 18 GHz – 40 GHz range.

SOP 1 Radiated Emissions

Tracking # 31360999.001 Page 11 of 15

EUT Name	Wireless Video Access Point	Date	April 10, 2013
EUT Model	405	Temp / Hum in	23° C / 33%rh
EUT Serial	Prototype	Temp / Hum out	N/A
EUT Config.	Y-Axis, 802.11n HT20 at 6.5 Mbps	Line AC	120Vac 60Hz
Standard	CFR47 Part 15 Subpart C	RBW / VBW	1 MHz / 3 MHz
Dist/Ant Used	1m - RA42-K-F-4B-C	Performed by	Jeremy Luong

Above 1 GHz Plots for Transmit Mode at 5240 MHz

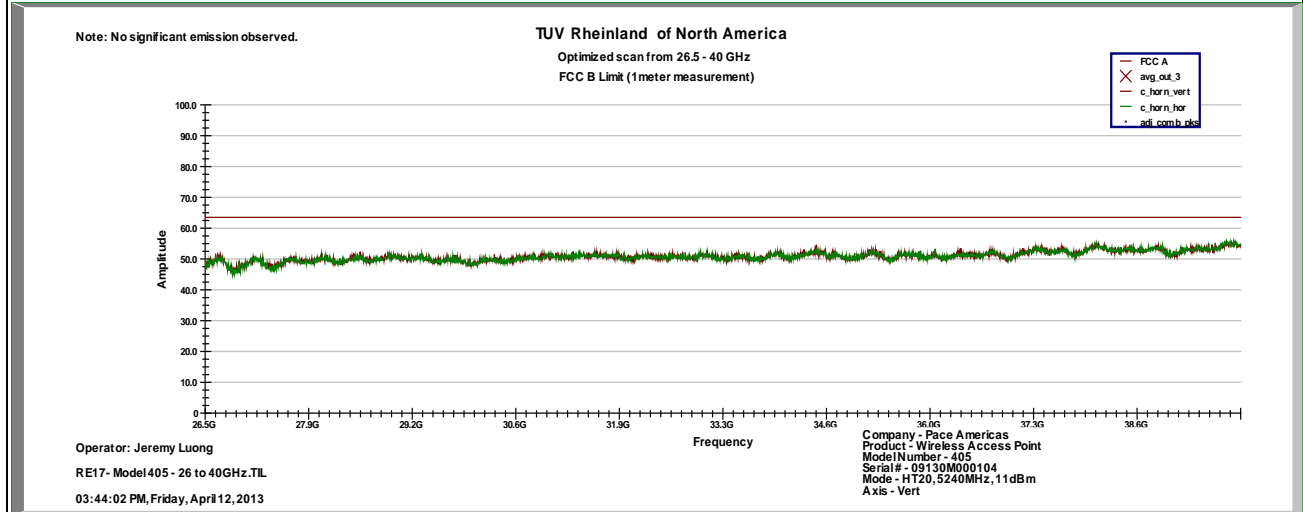

Notes: Limit was extrapolated to 1m distance for 18 GHz – 40 GHz range.

SOP 1 Radiated Emissions

Tracking # 31360999.001 Page 12 of 15

EUT Name	Wireless Video Access Point	Date	April 10, 2013
EUT Model	405	Temp / Hum in	23° C / 33%rh
EUT Serial	Prototype	Temp / Hum out	N/A
EUT Config.	Y-Axis, 802.11 HT40 at 13.5 Mbps	Line AC	120Vac 60Hz
Standard	CFR47 Part 15 Subpart C	RBW / VBW	1 MHz / 3 MHz
Dist/Ant Used	3m - EMCO3115 / 1m - RA42-K-F-4B-C	Performed by	Jeremy Luong

Above 1 GHz Plots for Transmit Mode at 5190 MHz

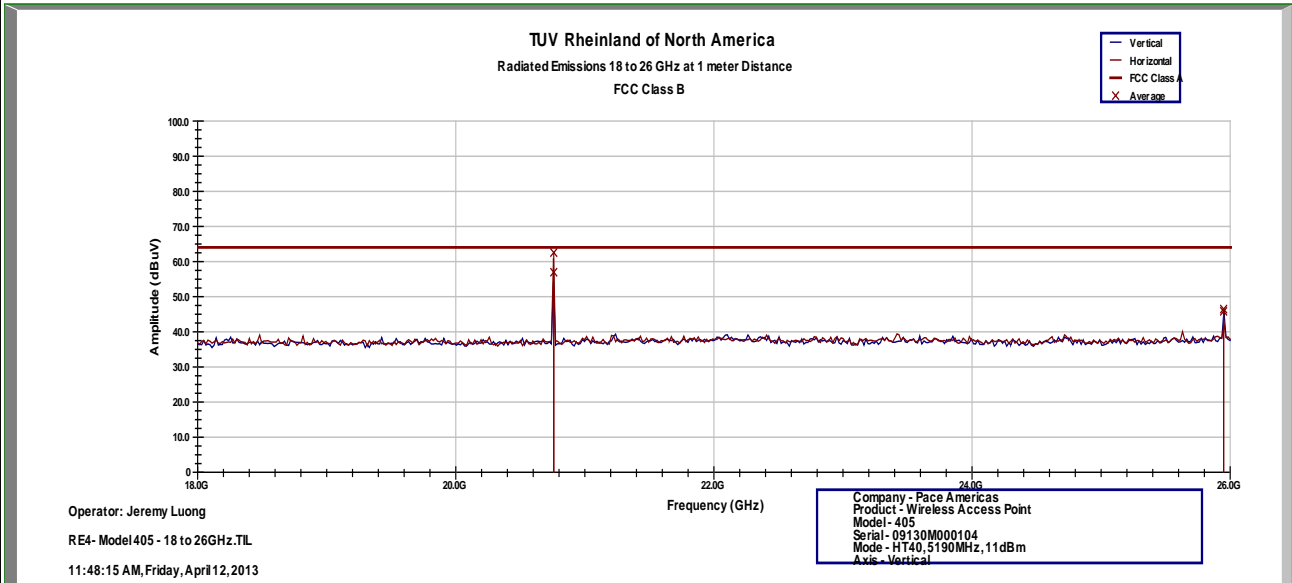
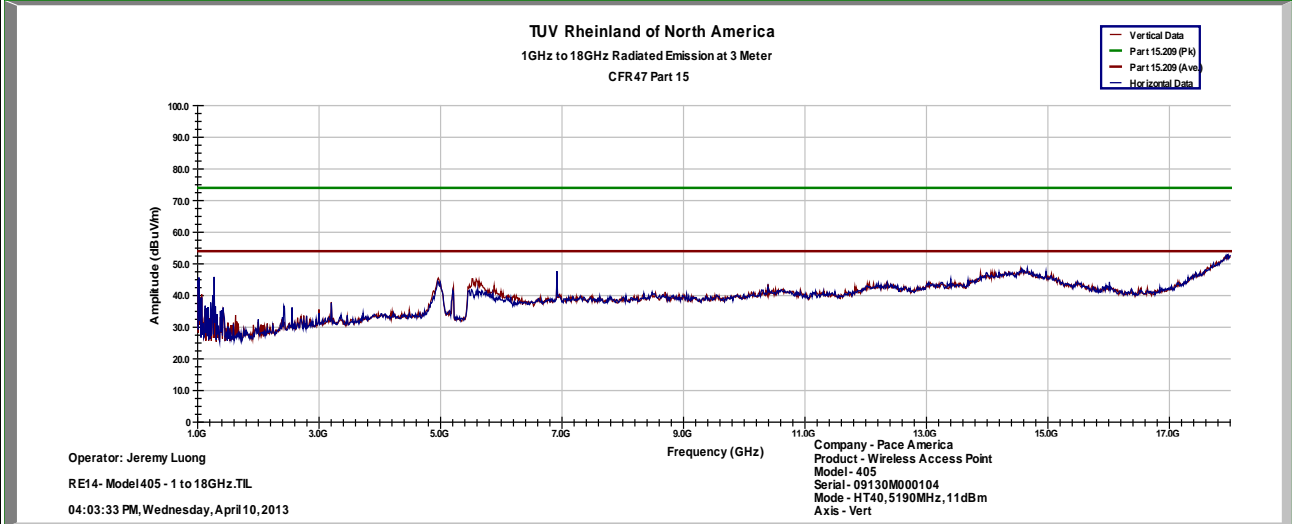

Notes: Limit was extrapolated to 1m distance for 18 GHz – 40 GHz range.

SOP 1 Radiated Emissions

Tracking # 31360999.001 Page 13 of 15

EUT Name	Wireless Video Access Point	Date	April 10, 2013
EUT Model	405	Temp / Hum in	23° C / 33%rh
EUT Serial	Prototype	Temp / Hum out	N/A
EUT Config.	Y-Axis, 802.11 HT40 at 13.5 Mbps	Line AC	120Vac 60Hz
Standard	CFR47 Part 15 Subpart C	RBW / VBW	1 MHz / 3 MHz
Dist/Ant Used	1m - RA42-K-F-4B-C	Performed by	Jeremy Luong

Above 1 GHz Plots for Transmit Mode at 5190 MHz

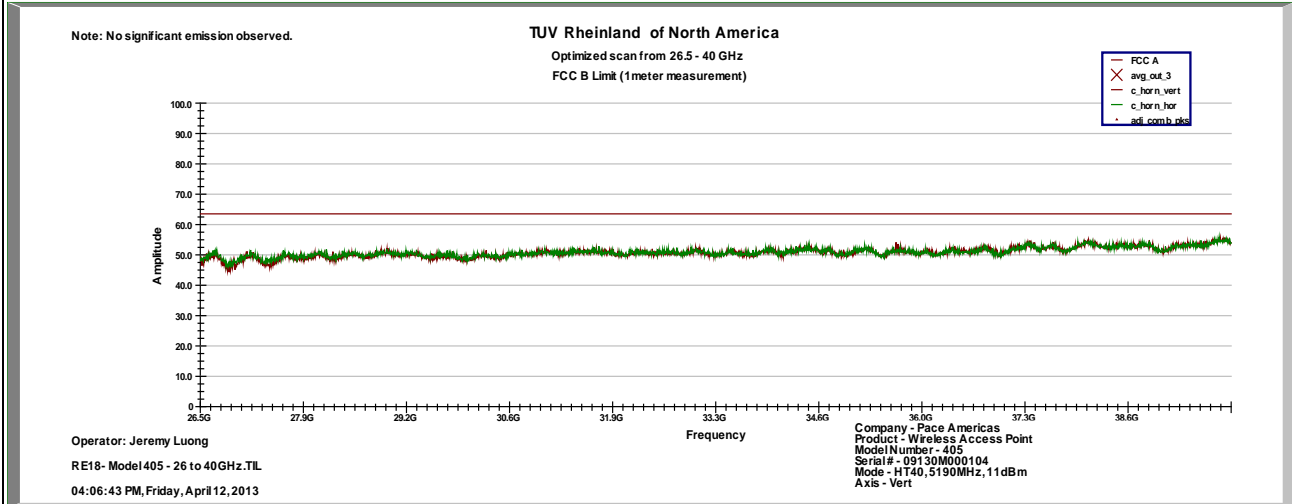

Notes: Limit was extrapolated to 1m distance for 18 GHz – 40 GHz range.

SOP 1 Radiated Emissions

Tracking # 31360999.001 Page 14 of 15

EUT Name	Wireless Video Access Point	Date	April 10, 2013
EUT Model	405	Temp / Hum in	23° C / 33%rh
EUT Serial	Prototype	Temp / Hum out	N/A
EUT Config.	Y-Axis, 802.11 HT40 at 13.5 Mbps	Line AC	120Vac 60Hz
Standard	CFR47 Part 15 Subpart C	RBW / VBW	1 MHz / 3 MHz
Dist/Ant Used	3m - EMCO3115 / 1m - RA42-K-F-4B-C	Performed by	Jeremy Luong

Above 1 GHz Plots for Transmit Mode at 5230 MHz

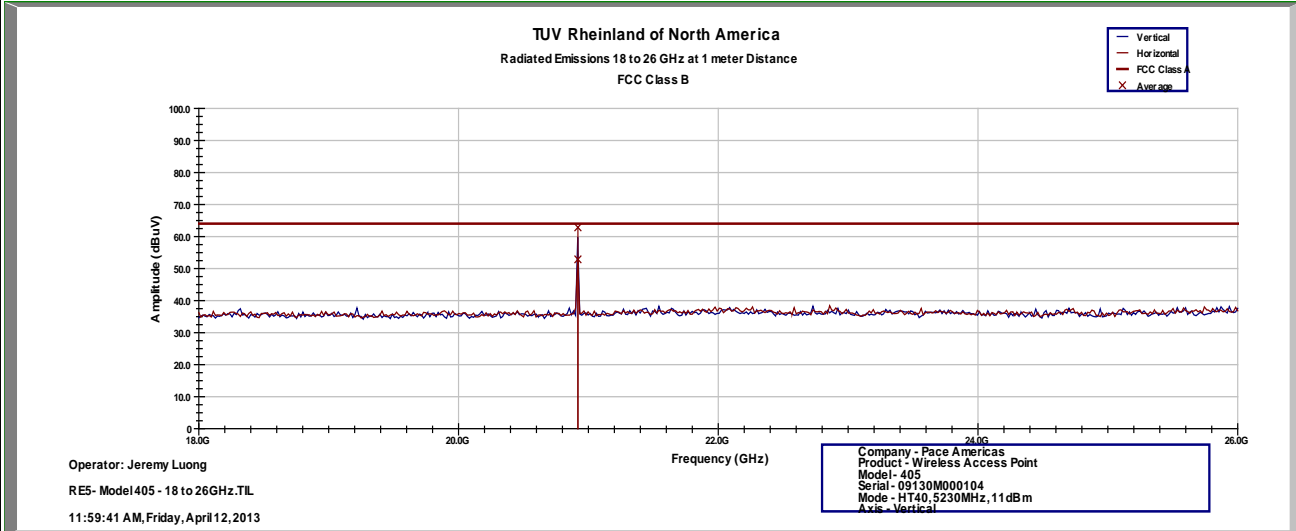
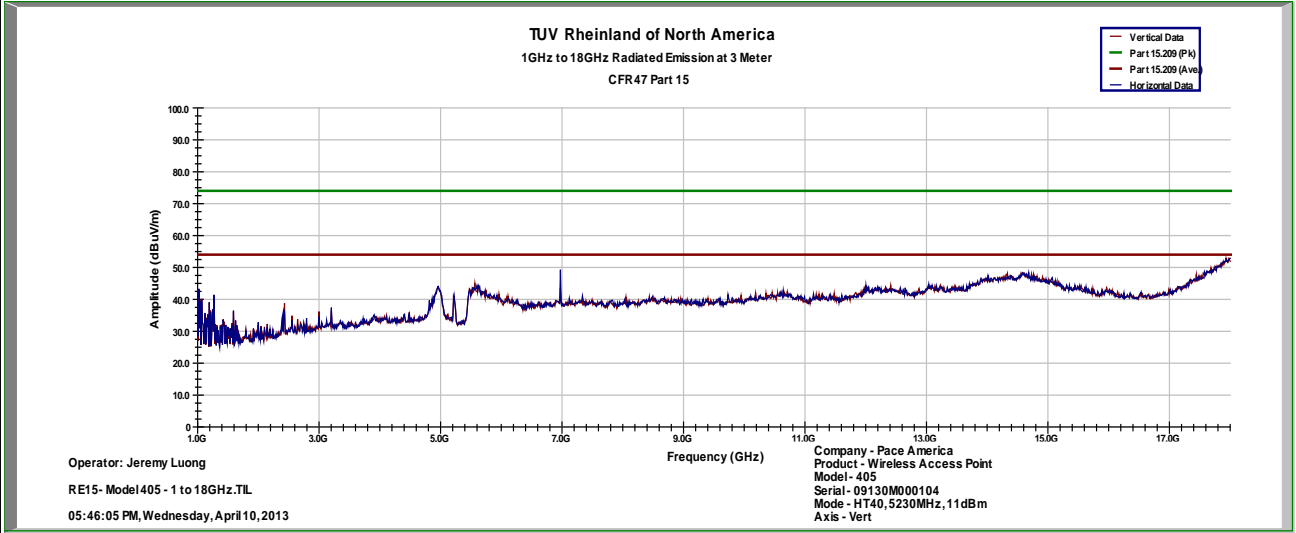

Notes: Limit was extrapolated to 1m distance for 18 GHz – 40 GHz range.
 1 GHz – 25 GHz Setting: RBW = 1 MHz/ VBW = 3 MHz

SOP 1 Radiated Emissions

Tracking # 31360999.001 Page 15 of 15

EUT Name	Wireless Video Access Point	Date	April 10, 2013
EUT Model	405	Temp / Hum in	23° C / 33%rh
EUT Serial	Prototype	Temp / Hum out	N/A
EUT Config.	Y-Axis, 802.11 HT40 at 13.5 Mbps	Line AC	120Vac 60Hz
Standard	CFR47 Part 15 Subpart C	RBW / VBW	1 MHz / 3 MHz
Dist/Ant Used	3m - EMCO3115 / 1m - RA42-K-F-4B-C	Performed by	Jeremy Luong

Above 1 GHz Plots for Transmit Mode at 5230 MHz

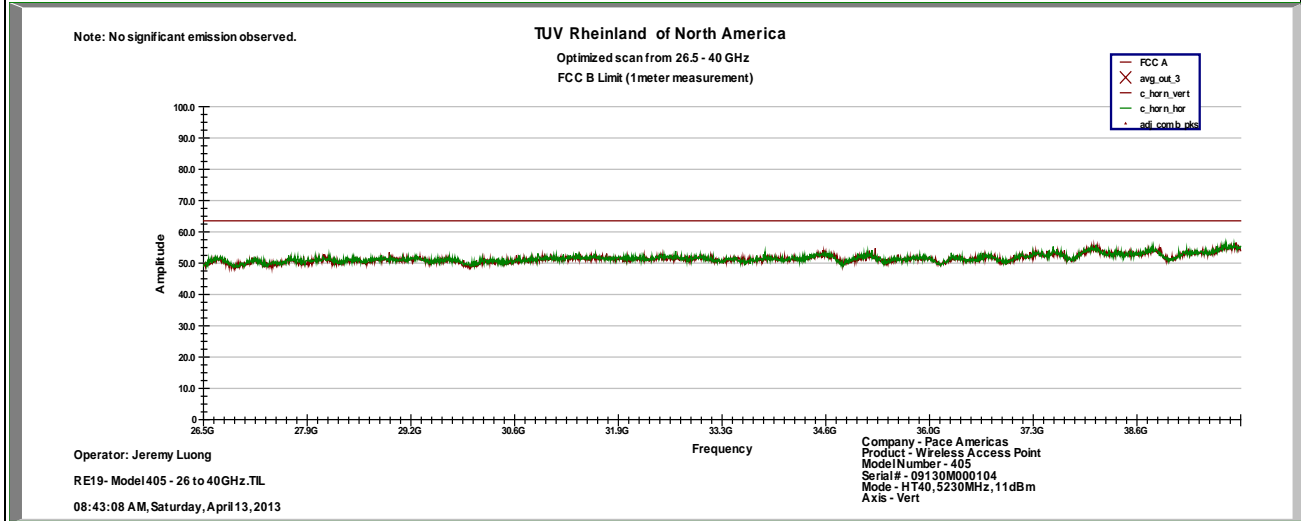

Notes: Limit was extrapolated to 1m distance for 18 GHz – 40 GHz range.

4.5.4 Sample Calculation

The field strength is calculated by subtracting the Amplifier Gain and adding the Cable Loss and Antenna Correction Factor to the measured reading. The basic equation is as follows:

$$\text{Field Strength (dB}\mu\text{V/m)} = \text{FIM} - \text{AMP} + \text{CBL} + \text{ACF}$$

- Where: FIM = Field Intensity Meter (dBμV)
- AMP = Amplifier Gain (dB)
- CBL = Cable Loss (dB)
- ACF = Antenna Correction Factor (dB/m)

$$\mu\text{V/m} = 10^{\frac{\text{dB}\mu\text{V} / \text{m}}{20}}$$

4.6 AC Conducted Emissions

Testing was performed in accordance with ANSI C63.4: 2010. These test methods are listed under the laboratory's A2LA Scope of Accreditation.

This test measures the levels emanating from the EUT's AC input port, thus evaluating the potential for the EUT to cause radio frequency interference to other electronic devices.

The AC conducted emissions of equipment under test shall not exceed the values in CFR47 Part 15.207: 2012 and RSS 210: 2010.

4.6.1 Test Methodology

A test program that controls instrumentation and data logging was used to automate the AC Power Line Conducted emission test procedure. The frequency range of interest was divided into sub-ranges such as to yield a frequency resolution of 9 kHz. Each phase and neutral of the AC power line were measured with respect to ground. Measurements were performed using a set of 50µH / 50Ω LISNs.

Testing is either performed in Lab 2. The setup photographs clearly identify which site was used. The vertical ground plane used in the semi-anechoic chamber is a 2m x 2m solid aluminum frame and panel, and it is bonded to the horizontal ground plane.

In the case of tabletop equipment, the EUT is placed on a 1.0m x 1.5m non-conductive table 80cm above the ground plane and 40cm from a vertical ground reference plane. The rear of the EUT was positioned flush with the backside of the table and directly over the LISNs. The power and I/O cables were routed over the edge of the table and bundled approximately 40cm from the ground plane. Support equipment was powered from a separate LISN.

4.6.1.1 Deviations

There were no deviations from this test methodology.

4.6.2 Test Results

As originally tested, the EUT was found to be compliant to the requirements of the test standard(s).

Table 8: AC Conducted Emissions – Test Results

Test Conditions: Conducted Measurement at Normal Conditions only		
Antenna Type: Attached		Power Level: See Test Plan
AC Power: 120 Vac/60 Hz		Configuration: Tabletop
Ambient Temperature: 22° C		Relative Humidity: 37% RH
Configuration	Frequency Range	Test Result
Line 1 (Hot)	0.15 to 30 MHz	Pass
Line 2 (Neutral)	0.15 to 30 MHz	Pass

SOP 2 Conducted Emissions						Tracking # 31360999.001 Page 1 of 4			
EUT Name	Wireless Video Access Point					Date	April 20, 2013		
EUT Model	405					Temp / Hum in	23° C / 34% rh		
EUT Serial	Prototype					Temp / Hum out	N/A		
EUT Config.	Attached Antenna					Line AC / Freq	120Vac/60Hz		
Standard	CFR47 Part 15.207					RBW / VBW	9 kHz / 30 kHz		
Lab/LISN	Lab #2 /Com-Power, Line 1					Performed by	Jeremy Luong		
Frequency	Raw	Limiter	Ins. Loss	Level	Detector	Line	Limit	Margin	Result
MHz	dBuV	dB	dB	dBuV		Line	dBuV	dB	
0.150	38.68	10.12	-0.72	48.08	QP	Live	66.00	-17.92	Pass
0.150	23.81	10.12	-0.72	33.21	Ave	Live	56.00	-22.79	Pass
0.151	38.19	10.12	-0.72	47.60	QP	Live	65.96	-18.36	Pass
0.151	22.88	10.12	-0.72	32.29	Ave	Live	55.96	-23.67	Pass
0.175	33.92	10.12	-0.64	43.40	QP	Live	64.72	-21.32	Pass
0.175	18.79	10.12	-0.64	28.27	Ave	Live	54.72	-26.45	Pass
0.495	23.54	10.17	-0.31	33.39	QP	Live	56.09	-22.70	Pass
0.495	15.47	10.17	-0.31	25.32	Ave	Live	46.09	-20.77	Pass
5.480	21.80	10.28	-0.13	31.95	QP	Live	60.00	-28.05	Pass
5.480	15.99	10.28	-0.13	26.14	Ave	Live	50.00	-23.86	Pass
7.263	21.19	10.34	-0.12	31.41	QP	Live	60.00	-28.59	Pass
7.263	15.59	10.34	-0.12	25.81	Ave	Live	50.00	-24.19	Pass
11.586	21.80	10.46	-0.08	32.17	QP	Live	60.00	-27.83	Pass
11.586	15.51	10.46	-0.08	25.88	Ave	Live	50.00	-24.12	Pass
13.479	21.85	10.47	-0.07	32.25	QP	Live	60.00	-27.75	Pass
13.479	15.64	10.47	-0.07	26.04	Ave	Live	50.00	-23.96	Pass
16.228	22.80	10.53	-0.04	33.30	QP	Live	60.00	-26.70	Pass
16.228	18.11	10.53	-0.04	28.61	Ave	Live	50.00	-21.39	Pass
Spec Margin = QP./Ave. - Limit, ± Uncertainty									
Combined Standard Uncertainty $u_c(y) = \pm 1.2$ dB Expanded Uncertainty $U = ku_c(y)$ $k = 2$ for 95% confidence									
Notes: EUT was setup as table top equipment and transmitted at 5200 MHz in HT20 at 6.5 Mbps									

SOP 2 Conducted Emissions

Tracking # 31360999.001 Page 2 of 4

EUT Name	Wireless Video Access Point	Date	April 20, 2013
EUT Model	405	Temp / Hum in	23° C / 34% rh
EUT Serial	Prototype	Temp / Hum out	N/A
EUT Config.	Attached Antenna	Line AC	120Vac/60Hz
Standard	CFR47 Part 15.207	RBW / VBW	9 kHz / 30 kHz
Lab/LISN	Lab #2 /Com-Power, Line 1	Performed by	Jeremy Luong

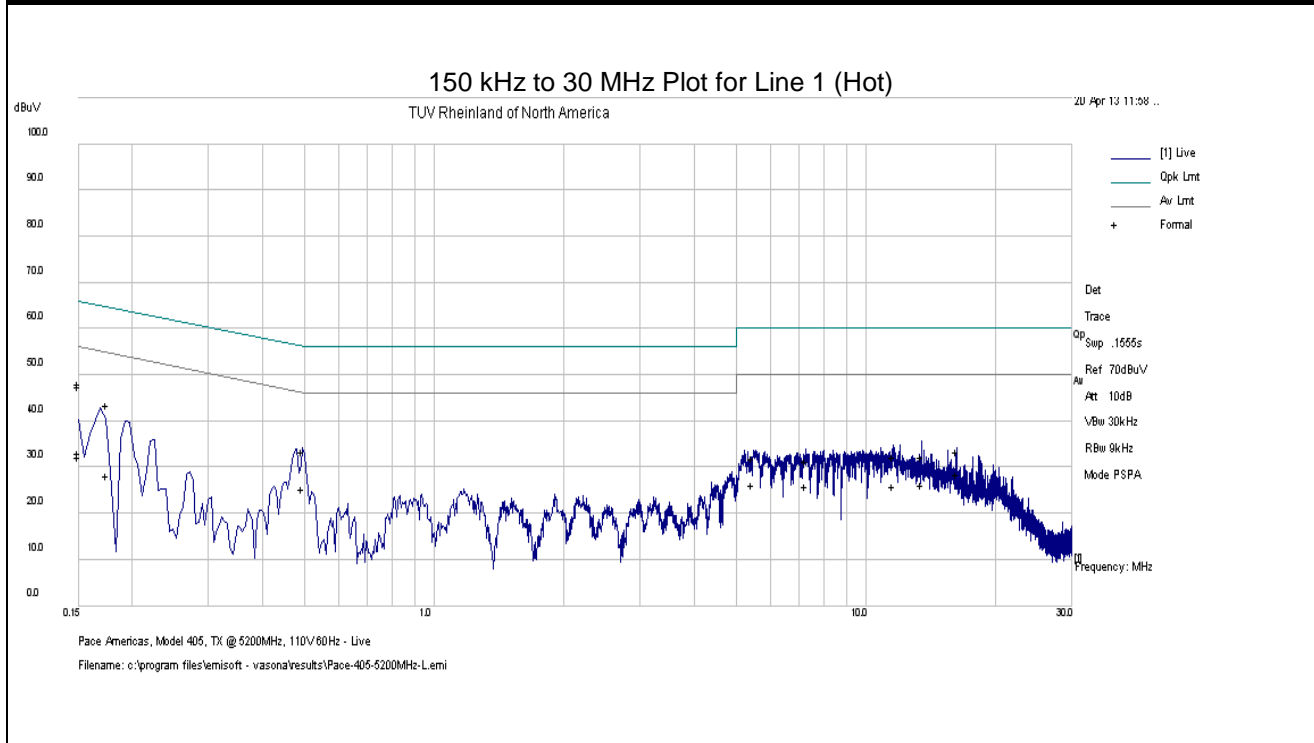

Notes: Meet FCC Class B limit.

SOP 2 Conducted Emissions						Tracking # 31360999.001 Page 3 of 4				
EUT Name	Wireless Video Access Point					Date	April 20, 2013			
EUT Model	405					Temp / Hum in	23° C / 34% rh			
EUT Serial	Prototype					Temp / Hum out	N/A			
EUT Config.	Attached Antenna					Line AC / Freq	120Vac/60Hz			
Standard	CFR47 Part 15.207					RBW / VBW	9 kHz / 30 kHz			
Lab/LISN	Lab #2 /Com-Power, Line 2					Performed by	Jeremy Luong			
Frequency	Raw	Limiter	Ins. Loss	Level	Detector	Line	Limit	Margin	Result	
MHz	dBuV	dB	dB	dBuV		Line	dBuV	dB		
0.150	37.27	10.12	-0.72	46.67	QP	Neutral	65.99	-19.32	Pass	
0.150	22.84	10.12	-0.72	32.24	Ave	Neutral	55.99	-23.75	Pass	
0.151	36.48	10.12	-0.72	45.89	QP	Neutral	65.95	-20.06	Pass	
0.151	21.16	10.12	-0.72	30.57	Ave	Neutral	55.95	-25.38	Pass	
0.482	26.44	10.17	-0.32	36.29	QP	Neutral	56.30	-20.01	Pass	
0.482	16.54	10.17	-0.32	26.39	Ave	Neutral	46.30	-19.91	Pass	
6.850	21.25	10.33	-0.12	31.46	QP	Neutral	60.00	-28.54	Pass	
6.850	15.11	10.33	-0.12	25.32	Ave	Neutral	50.00	-24.68	Pass	
7.901	21.06	10.37	-0.11	31.32	QP	Neutral	60.00	-28.68	Pass	
7.901	15.19	10.37	-0.11	25.45	Ave	Neutral	50.00	-24.55	Pass	
8.227	21.04	10.38	-0.11	31.31	QP	Neutral	60.00	-28.69	Pass	
8.227	15.13	10.38	-0.11	25.40	Ave	Neutral	50.00	-24.60	Pass	
9.938	21.96	10.42	-0.10	32.28	QP	Neutral	60.00	-27.72	Pass	
9.938	15.85	10.42	-0.10	26.17	Ave	Neutral	50.00	-23.83	Pass	
11.592	20.55	10.46	-0.08	30.92	QP	Neutral	60.00	-29.08	Pass	
11.592	14.29	10.46	-0.08	24.66	Ave	Neutral	50.00	-25.34	Pass	
16.227	22.17	10.53	-0.04	32.67	QP	Neutral	60.00	-27.33	Pass	
16.227	17.39	10.53	-0.04	27.89	Ave	Neutral	50.00	-22.11	Pass	
Spec Margin = QP./Ave. - Limit, ± Uncertainty										
Combined Standard Uncertainty $u_c(y) = \pm 1.2$ dB Expanded Uncertainty $U = k u_c(y)$ $k = 2$ for 95% confidence										
Notes: EUT was setup as table top equipment and transmitted at 5200 MHz in HT20 at 6.5 Mbps										

SOP 2 Conducted Emissions

Tracking # 31360999.001 Page 4 of 4

EUT Name	Wireless Video Access Point	Date	April 20, 2013
EUT Model	405	Temp / Hum in	23° C / 34% rh
EUT Serial	Prototype	Temp / Hum out	N/A
EUT Config.	Attached Antenna	Line AC	120Vac/60Hz
Standard	CFR47 Part 15.107	RBW / VBW	9 kHz / 30 kHz
Lab/LISN	Lab #2 /Com-Power, Line 2	Performed by	Jeremy Luong

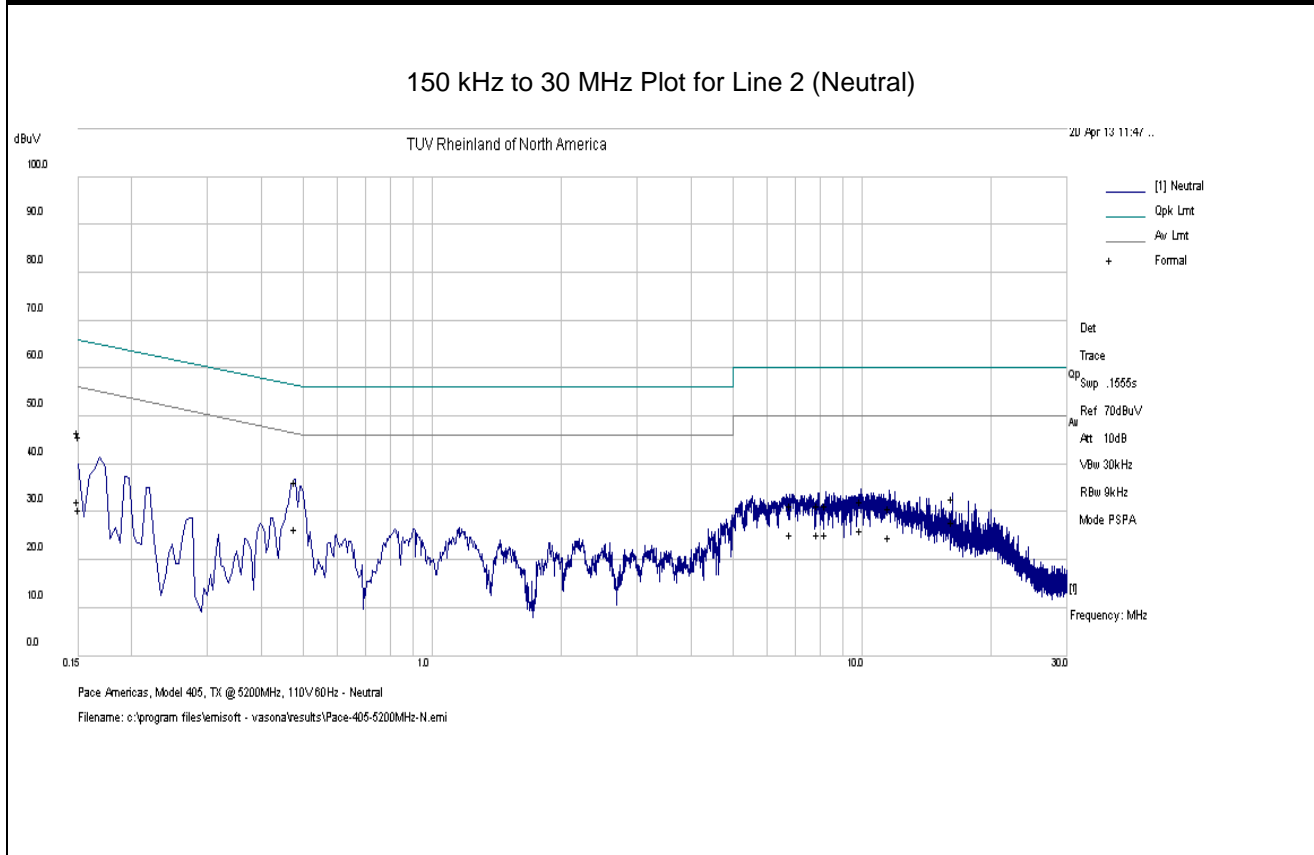

Note: Meet FCC Class B Limit.

4.7 Frequency Stability

In accordance with 47 CFR Part 15.407(g) the frequency stability of U-NII devices must be such that an emission is maintained within the band of operation under all conditions of normal operation as specified in the user's manual. The Manufacturer calls out operating temperature ranges of +0° to +40° C

4.7.1 Test Methodology

The manufacturer of the equipment is responsible for ensuring that the frequency stability is such that emissions are always maintained within the band of operation under all conditions. This test performs according to ANSI C63.10-2009 Section 6.8

4.7.2 Manufacturer Declaration

The frequency stability of the reference oscillator sets the frequency stability of the RF transceiver signals. Therefore all of the RF signal should have ± 20 ppm stability.

This stability accounts for room temp tolerance of the crystal oscillator circuit, frequency variation across temperature, and crystal ageing.

Worst case:

5.200 GHz - ± 20 ppm/104 kHz

± 20 ppm at 5 GHz translates to a maximum frequency shift of ± 103 kHz. As the edge of the channels are at least one MHz from either of the band edges, ± 103 kHz is more than sufficient to guarantee that the intentional emission will remain in the band over the entire operating range of the radio.

4.7.3 Limit

CFR47 Part 407(g) - Manufacturers of U-NII devices are responsible for ensuring frequency stability such that an emission is maintained within the band of operation under all conditions of normal operation as specified in the user's manual.

4.7.4 Test results

As originally tested, the EUT was found to be compliant to the requirements of the test standard(s) since the maximum frequency drift was 6.84 ppm.

Table 9: Frequency Stability – Test Results

Temperature	Time	-6 dB Lower Edge (MHz)	+6 dB Upper Edge (MHz)	Center Frequency (MHz)	PPM
40° C	Start	5198.93220	5201.01530	5199.97375	5.05
	2 Min.	5198.94570	5200.98520	5199.96545	6.64
	5 Min	5198.88210	5201.04680	5199.96445	6.84
	10 min	5198.88210	5201.04930	5199.96570	6.60
30° C	Start	5198.93220	5201.04080	5199.98650	2.60
	2 Min.	5198.93070	5201.01830	5199.97450	4.90
	5 Min	5198.93220	5201.01080	5199.97150	5.48
	10 min	5198.93220	5201.00780	5199.97000	5.77
20° C	Start	5198.93970	5201.06180	5200.00075	0.14
	2 Min.	5198.93670	5201.03780	5199.98725	2.45
	5 Min	5198.93520	5201.03180	5199.98350	3.17
	10 min	5198.93520	5201.02880	5199.98200	3.46
10° C	Start	5198.94420	5201.08130	5200.01275	2.45
	2 Min.	5198.93820	5201.06030	5199.99925	0.14
	5 Min	5198.93670	5201.05580	5199.99625	0.72
	10 min	5198.93670	5201.05430	5199.99550	0.87
0° C	Start	5198.94420	5201.09030	5200.01725	3.32
	2 Min.	5198.94420	5201.08130	5200.01275	2.45
	5 Min	5198.94420	5201.07680	5200.01050	2.02
	10 min	5198.94420	5201.07680	5200.01050	2.02

Note: All frequency drifts were less than ±20 ppm. The worst frequency drift was 6.84 ppm/ 35.55 kHz.

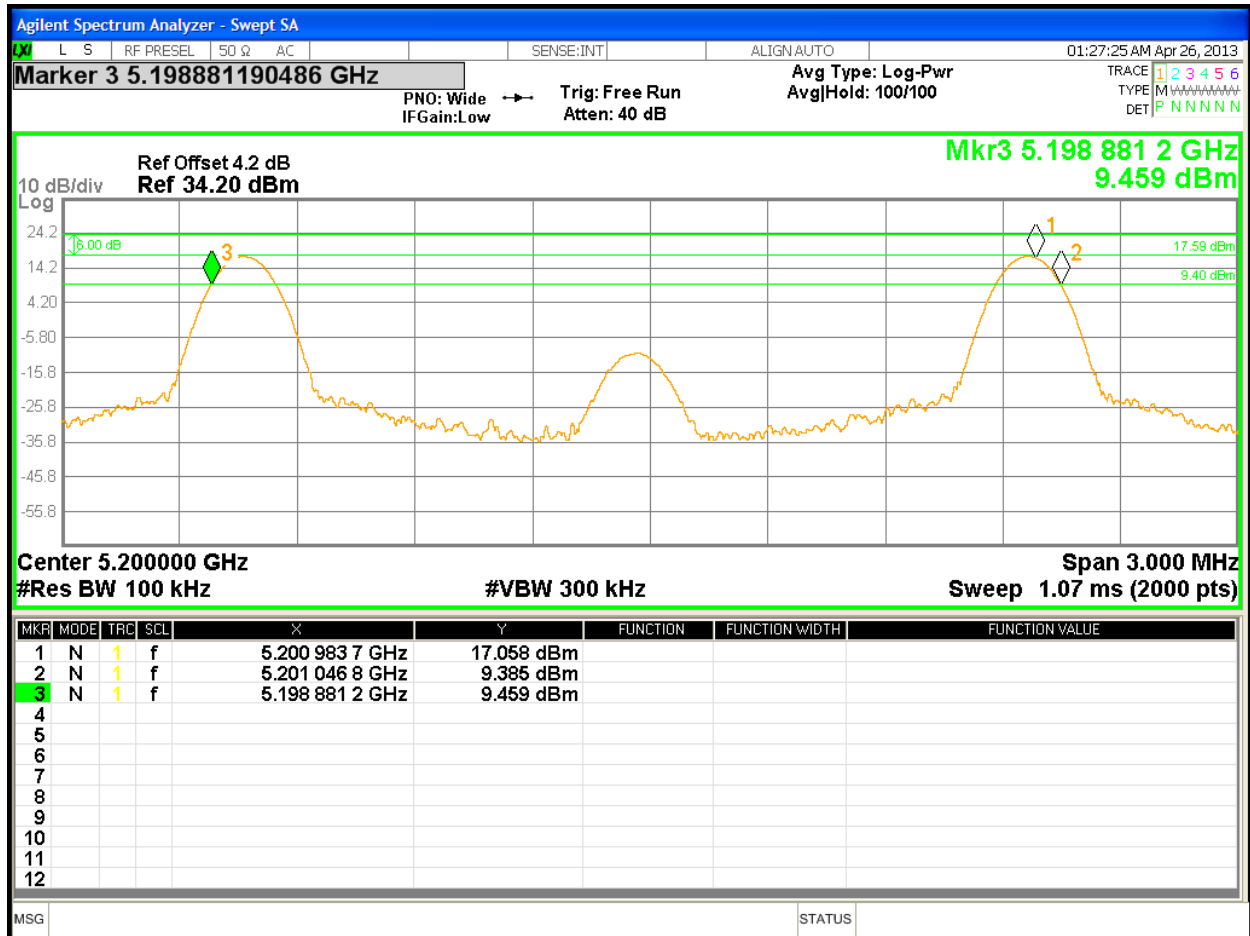

Figure 100: Frequency Stability – Worst Case

4.8 Voltage Variation

In accordance with 47 CFR Part 15.31 (e) intentional radiators, measurements of the variation of the input power or the radiated signal level of the fundamental frequency component of the emission, as appropriate, shall be performed with the supply voltage varied between 85% and 115% of the nominal rated supply voltage. For battery operated equipment, the equipment tests shall be performed using a new battery.

4.8.1 Test Methodology

The ac supply voltage was varied between 85% and 115% of the nominal rated supply voltage. The fundamental frequency was observed during the variation. The access point was powered 120V/60Hz by programmable power supply. The voltage was varied from 102Vac to 138Vac mean while the fundamental frequencies were observed and record for the maximum drift in ppm; part per millions.

4.8.2 Test results

As originally tested, the EUT was found to be compliant to the requirements of the test standard(s). The fundamental frequencies drifted less than ± 20 ppm.

Table 10: Voltage Variation – Test Results

Frequency MHz	Nominal (120Vac) MHz	Lo Voltage (102Vac) MHz	Hi Voltage (138Vac) MHz	Max Drift ppm
5180	5179.96475	5179.96550	5179.96475	6.81
5200	5199.96650	5199.96575	5199.96350	7.02
5240	5239.96325	5239.96250	5239.96775	7.16

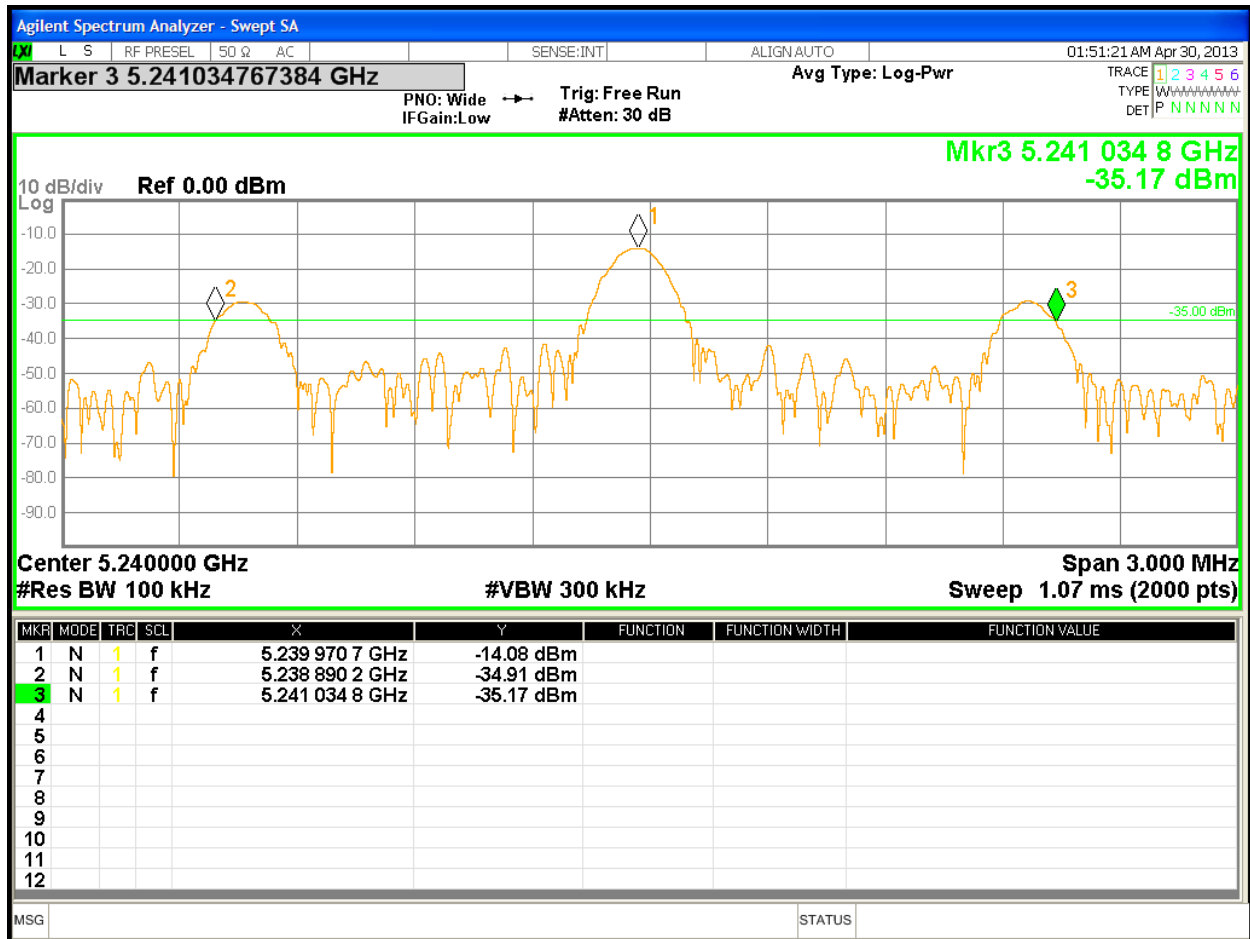

Figure 101: Voltage Variation – Worst Case

4.9 Maximum Permissible Exposure

4.9.1 Test Methodology

In this document, we try to prove the safety of radiation harmfulness to the human body for our product. The limit for Maximum Permissible Exposure (MPE) specified in FCC 1.1310 is followed. The Gain of the antenna used in this calculation is declared by the manufacturer, and the maximum total power input to the antenna is measured. Through the Friis transmission formula and the maximum gain of the antenna, we can calculate the distance, away from the product, where the limit of MPE is reached.

Although the Friis transmission formula is a far field assumption, the calculated result of that is an over-prediction for near field power density. We will take that as the worst case to specify the safety range.

4.9.2 RF Exposure Limit

According to FCC 1.1310 table 1: The criteria listed in the following table shall be used to evaluate the environmental impact of human exposure to radio-frequency (RF) radiation as specified in 1.1307(b)

LIMITS FOR MAXIMUM PERMISSIBLE EXPOSURE (MPE)

Frequency Range (MHz)	Electric Field Strength (V/m)	Magnetic Field Strength (A/m)	Power Density (mW/cm ²)	Average Time (minutes)
(A)Limits For Occupational / Control Exposures				
0.3–3.0	614	1.63	*(100)	6
3.0–30	1842/f	4.89/f	*(900/f ²)	6
30–300	1.0	6
300 - 1500	f/300	6
1500 - 100,000	5	6
(B)Limits For General Population / Uncontrolled Exposure				
0.3–1.34	614	1.63	*(100)	30
1.34-30	824/f	2.19/f	*(180/ f ²)	30
30–300	27.5	0.037	0.2	30
300 - 1500	f/1500	30
1500 - 100,000	1.0	30

F = Frequency in MHz

* = Plane-wave equivalent power density

4.9.3 EUT Operating Condition

The software provided by Manufacturer enabled the EUT to transmit data at lowest, middle and highest channel individually.

4.9.4 Classification

The antenna of the product, under normal use condition, is at least 20cm away from the body of the user. Warning statement to the user for keeping at least 20cm or more separation distance with the antenna should be included in user's manual. So, this device is classified as a **Mobile Device**.

4.9.5 Test Results

4.9.5.1 Antenna Gain

The transmitting antenna was integrated. The directional antenna gain was +8.00 dBi or 6.31 (numeric).

4.9.5.2 Output Power into Antenna & RF Exposure value at distance 20cm:

Calculations for this report are based on highest power measurement.

Limit for MPE (from FCC part 1.1310 table1) is 1.0 mW/cm²

The highest measured total power is +14.87 dBm or 30.690mW

Using the Friss transmission formula, the EIRP is Pout*G, and R is 20cm.

$Pd = (30.690 * 6.31) / (1600\pi) = 0.0385 \text{ mW/cm}^2$, which is 0.9615 mW/cm² below to the limit.

As originally tested, the EUT was found to be compliant to the requirements of the test standard(s).

4.9.6 Sample Calculation

The Friss transmission formula: $Pd = (Pout * G) / (4 * \pi * R^2)$

Where;

Pd = power density in mW/cm²

Pout = output power to antenna in mW

G = gain of antenna in linear scale

$\pi \approx 3.1416$

R = distance between observation point and center of the radiator in cm

Ref. : David K. Cheng, *Field and Wave Electromagnetics*, Second Edition, Page 640, Eq. (11-133).

5 Test Equipment List

5.1 Equipment List

Equipment	Manufacturer	Model #	Serial/Inst #	Last Cal mm/dd/yy	Next Cal mm/dd/yy
Bilog Antenna	Sunol Sciences	JB3	A102606	05/15/2012	05/15/2014
Horn Antenna	Sunol Sciences	DRH-118	A040806	11/05/2012	11/05/2014
Antenna (18-26GHz)	CMT	RA42-K-F-4B-C	020131-004	03/05/2013	03/05/2014
Antenna (26-40 GHz)	CMT	RA28-K-F-4B-C	011469R-003	11/20/2012	11/20/2014
EMI Receiver	Hewlett Packard	8546A	3807A00445	01/18/2013	01/18/2014
Preselector	Hewlett Packard	85460A	3704A00407	01/18/2013	01/18/2014
Amplifier	Hewlett Packard	8447D	2944A07996	01/16/2013	01/16/2014
Spectrum Analyzer	Rhode Schwarz	ESIB	832427/002	01/16/2013	01/16/2014
Amplifier	Rohde & Schwarz	TS-PR18	3545.7008.03	01/16/2013	01/16/2014
Amplifier	Rohde & Schwarz	TS-PR26	100011	03/05/2013	03/05/2014
Amplifier	Rohde & Schwarz	TS-PR40	100012	11/20/2012	11/20/2014
Signal Generator	Anritsu	MG3694A	42803	01/19/2013	01/19/2014
Notch Filter	Micro-Tronics	BRM50702	37	01/16/2013	01/16/2014
Notch Filter	Micro-Tronics	BRC50703	11	01/16/2013	01/16/2014
Notch Filter	Micro-Tronics	BRC50704	8	01/16/2013	01/16/2014
Notch Filter	Micro-Tronics	BRC50705	9	01/16/2013	01/16/2014
High Pass Filter (3.5 GHz)	Hewlett Packard	84300-80038	820004	01/16/2013	01/16/2014
High Pass Filter (8.5 GHz)	Micro-Tronics	HPM50107	4	01/16/2013	01/16/2014
Power Supplier	Kikosui	PCR8000W	CM000912	01/17/2013	01/17/2014
Digital Multimeter	Fluke	177	92780314	01/17/2013	01/17/2014
Power Meter	Agilent	E4418B	MY45103902	01/19/2013	01/19/2014
Power Sensor	Hewlett Packard	8482A	55-5131	01/19/2013	01/19/2014
EMI Receiver	Hewlett Packard	8546A	3942A00514	07/02/2012	07/02/2013
Preselector	Hewlett Packard	85460A	3704A00485	07/02/2012	07/02/2013
LISN	Com-Power	LI-215	12100	01/16/2013	01/16/2014
Transient Limiter	Com-Power	LIT-930	531582	01/16/2013	01/16/2014
Thermometer	Fluke	52II	88650033	07/26/2012	07/26/2013
Thermo Chamber	Espec	BTZ-133	0613436	03/11/2013	03/11/2014
Spectrum Analyzer	Rohde & Schwarz	FSL6	100169	02/07/2013	02/07/2014
Spectrum Analyzer	Agilent	N9038A	MY51210195	01/19/2013	01/19/2014
Vector Signal Generator	Rohde & Schwarz	SMU 200A	1141.2005.02	11/24/2011	11/24/2013
Amplifier	Hewlett Packard	8449B	30008A01014	01/17/2013	01/17/2014

* Calibration of equipment past due for re-calibration will be performed expeditiously. If any equipment is found to be out of tolerance at that time, affected customers will be notified accordingly.

6 EMC Test Plan

6.1 Introduction

This section provides a description of the Equipment Under Test (EUT), configurations, operating conditions, and performance acceptance criteria. It is an overview of information provided by the manufacturer so that the test laboratory may perform the requested testing.

6.2 Customer

Table 11: Customer Information

Company Name	Pace Americas
Address	310 Providence Mine Road, Ste. 200
City, State, Zip	Nevada City, CA 95959
Country	USA
Phone	(530) 274 5440
Fax	(530) 273 6340

Table 12: Technical Contact Information

Name	Mark Rieger
E-mail	Mark.Rieger@pace.com
Phone	(530) 274 5440
Fax	(530) 273 6340

6.3 Equipment Under Test (EUT)

Table 13: EUT Specifications

EUT Specifications	
Dimensions	6.0" x 5.6" x 1.3"
AC Adapter (Pace M/N:T018WA1225, S/N:810611302000003156)	Input Voltage: 120Vac 50-60Hz Input Current: 680mA Output Voltage: 12VDC Output Current: 1.5A
Environment	Indoor and Outdoor
Operating Temperature Range:	0 to 40 degrees C
Multiple Feeds:	<input type="checkbox"/> Yes and how many <input checked="" type="checkbox"/> No
Hardware Version	Rev. A1C
Part Number	297T1001700
RF Software Version	Busy Box V1.10.3
802.11-radio modules	
Operating Mode	802.11n HT20 and HT40
Transmitter Frequency Band	5.15 GHz to 5.25 GHz (Indoor Use) 5.725 GHz to 5.85 GHz
Max. Rated Power Output	See Channel Planning Table.
Power Setting @ Operating Channel	See Channel Planning Table.
Antenna Type	3 integrated PCB Antennas and 1 stamped metal loop antenna
Antenna Gain	+2 dBi per antenna. (Same for both antenna type) +8 dBi directional gain.
Modulation Type	<input type="checkbox"/> AM <input type="checkbox"/> FM <input checked="" type="checkbox"/> DSSS <input checked="" type="checkbox"/> OFDM <input type="checkbox"/> Other describe:
Data Rate	802.11n HT20: 4 Spatial Streams: 26, 52, 78, 104, 156, 208, 234, 260 Mbps 802.11n HT40: 4 Spatial Streams: 54, 108, 162, 216, 324, 432, 486, 540 Mbps
TX/RX Chain (s)	MIMO (4x4)
Directional Gain Type	<input checked="" type="checkbox"/> Correlated <input checked="" type="checkbox"/> Beam-Forming <input type="checkbox"/> Other describe:
Type of Equipment	<input checked="" type="checkbox"/> Table Top <input type="checkbox"/> Wall-mount <input type="checkbox"/> Floor standing cabinet <input type="checkbox"/> Other

EUT Specifications

Note: 1. All four chains will be on / transmitted at all time.
2. This report only documents the radio characteristics for 5150 – 5250 MHz band

Table 14: EUT Channel Power Specifications

No.	Frequency (MHz)	Target Power Value				
		802.11b	802.11g	802.11a	802.11n HT20	802.11n HT40
36	5180				10.0	11
40	5200				9.0	
44	5220				9.0	11
48	5240				9.0	
52	5260					
56	5280					
60	5300					
64	5320					
100	5500					
104	5520					
108	5540					
112	5560					
116	5580					
120	5600					
124	5620					
128	5640					
132	5660					
136	5680					
140	5700					
149	5745				22.0	22.0
153	5765				22.0	
157	5785				22.0	22.0
159	5795				22.0	
161	5805				22.0	
165	5825				22.0	

Note: 1. The center operating frequency is shifted upward by 10 MHz for HT40.
 2. The adjusted power target values are updated at the evaluated frequencies.

Table 15: Interface Specifications

Interface Type	Cabled with what type of cable?	Is the cable shielded?	Maximum potential length of the cable?	Metallic (M), Coax (C), Fiber (F), or Not Applicable?
RJ45	CAT-5 Ethernet	<input type="checkbox"/> No	<input checked="" type="checkbox"/> Metric: 10 m	<input checked="" type="checkbox"/> M

Table 16: Supported Equipment

Equipment	Manufacturer	Model	Serial	Used for
Laptop	Dell	PP23LB	9271001233	Setup EUT operating channel
Note: None.				

Table 17: Description of Sample used for Testing

Device	Serial	RF Connection	CFR47 Part 15.247
405	09130M000104	Integrated Antenna	TX Emission, AC Conducted Emission
		Direct via Murada Connection	Peak Transmit Power, Peak Power Spectral Density, Peak Excursion Ratio Occupied Bandwidth Frequency Stability Voltage Variation

Table 18: Description of Test Configuration used for Radiated Measurement.

Device	Antenna	Mode	Setup Photo (X-Axis)	Setup Photo (Y-Axis)	Setup Photo (Z-Axis)
405	Integrated	Transmit	EUT laid flat.	EUT stood upright	N/A
Note: Pre-scans were performed in 2 supporting axis, and Y-axis was worst.					

Table 19: Final Test Mode for 5150 - 5250 Bands

Test	802.11a	802.11n HT20	802.11n HT40
Occupied Bandwidth FCC Part 15.407(a)		Band 1: 5180, 5220, 5240 MHz 4 Streams – 6.5 Mbps/ stream	Band 1: 5190, 5230 MHz 4 Streams – 13.5 Mbps/ stream
Output Power FCC Part 15.407(a)(1-2)		Band 1: 5180, 5220, 5240 MHz 4 Streams – 6.5 Mbps/ stream	Band 1: 5190, 5230 MHz 4 Streams – 13.5 Mbps/ stream
Peak Excursion Ratio FCC Part 15.407(a)(6)		Band 1: 5180, 5220, 5240 MHz 4 Streams – 6.5 Mbps/ stream	Band 1: 5190, 5230 MHz 4 Streams – 13.5 Mbps/ stream

Test	802.11a	802.11n HT20	802.11n HT40
Peak Power Spectral Density FCC Part 15.407(a)		Band 1: 5180, 5220, 5240 MHz 4 Streams – 6.5 Mbps/ stream	Band 1: 5190, 5230 MHz 4 Streams – 13.5 Mbps/ stream
Band-Edge (Radiated) FCC Part 15.205, 15.209, 15.407(b)		Band 1: 5180, 5220, 5240 MHz 4 Streams – 6.5 Mbps/ stream (Y-Axis)	Band 1: 5190, 5230 MHz 4 Streams – 13.5 Mbps/ stream (Y-Axis)
Transmitted Spurious Emission (30 MHz – 1 GHz) FCC Part 15.205, 15.209, 15.407(b)		Worst Case: 5200 MHz 4 Streams – 6.5 Mbps/ stream (Y-Axis)	
Transmitted Spurious Emission (Above 1 GHz) FCC Part 15.205, 15.209, 15.407(b)		Band 1: 5180, 5220, 5240 MHz 4 Streams – 6.5 Mbps/ stream (Y-Axis)	Band 1: 5190, 5230 MHz 4 Streams – 13.5 Mbps/ stream (Y-Axis)
Conducted Spurious Emission (antenna port). FCC Part 15.407 (b)	According to CFR47 15.407 (b) EIPR shall not exceed -27 dBm/MHz. This is equivalent to the field strength of 68.2dBuV/m at 3 meter distance. The EUT is satisfied the requirement by meeting the limit under CFR47 Part 15.209.		
AC Conducted Emission FCC Part 15.207		5200 MHz at 4 Data Stream: 6.5 Mbp	
Frequency Stability FCC Part 15.407 (g)	CW Tone at 5200 MHz, (Send_cw_signal 40 0 0 3 1 0).		
Voltage Variation FCC Part 15.31 (e)	Continuous wave at 5180, 5200, 5240,MHz, (Send_cw_signal 40 0 0 3 1 0)		
Dynamic Frequency Selection FCC Part 15.407 (h)	5150 – 5250 MHz band does not support DFS.		
Note: <ol style="list-style-type: none"> 1. Band 1: 5150 MHz – 5250 MHz does not support 802.11a. 2. All radiated emission performed on Y-Axis. 3. All four chains will be on at all time. 4. All tests were pre-scanned for worst case before final testing. 			

6.4 Test Specifications

Testing requirements

Table 20: Test Specifications

Emissions and Immunity	
Standard	Requirement
CFR 47 Part 15.407: 2012	All
RSS 210 Issue 8, 2010	All

END OF REPORT