

Emissions Test Report

EUT Name: Wireless uDSL Residential Gateway

Model No.: 5168NV

CFR 47 Part 15.247:2010 and RSS 210:2010

Prepared for:

Mark Rieger
Pace Americas
310 Providence Mine Road
Nevada City, CA 95959
Tel: (530) 274-5440
Fax: (530) 273-6340

Prepared by:

TUV Rheinland of North America, Inc.
1279 Quarry Lane
Pleasanton, CA 94566
Tel: (925) 249-9123
Fax: (925) 249-9124
<http://www.tuv.com/>

Report/Issue Date: November 8, 2011

Report Number: 31153119.001

Statement of Compliance

Manufacturer: Pace Americas
310 Providence Mine Road
Nevada City, CA 95959
(530) 274-5440

Requester / Applicant: Mark Rieger
Name of Equipment: Wireless uDSL Residential Gateway
Model No. 5168NV
Type of Equipment: Intentional Radiator
Application of Regulations: CFR 47 Part 15.247:2010 and RSS 210:2010
Test Dates: 23 September 2011 to 8 November 2011

Guidance Documents:

Emissions: ANSI C63.10: 2009

Test Methods:

Emissions: ANSI C63.10: 2009

The electromagnetic compatibility test and documented data described in this report has been performed and recorded by TUV Rheinland, in accordance with the standards and procedures listed herein. As the responsible authorized agent of the EMC laboratory, I hereby declare that the equipment described above has been shown to be compliant with the EMC requirements of the stated regulations and standards based on these results. If any special accessories and/or modifications were required for compliance, they are listed in the Executive Summary of this report.

This report must not be used to claim product endorsement by NVLAP or any agency of the U.S. Government. This report contains data that are not covered by NVLAP accreditation. This report shall not be reproduced except in full, without the written authorization of TUV Rheinland of North America.



Jeremy Luong 8 November 2011

Test Engineer Date

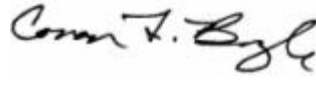

Conan Boyle 8 November 2011

NVLAP Signatory Date



NVLAPCODE 500011-0



US5254

Industry Canada

2932M-1

Table of Contents

1	Executive Summary	6
1.1	Scope	6
1.2	Purpose	6
1.3	Summary of Test Results	6
1.4	Special Accessories	6
1.5	Equipment Modifications	6
2	Laboratory Information	7
2.1	Accreditations & Endorsements	7
2.1.1	US Federal Communications Commission	7
2.1.2	NIST / NVLAP	7
2.1.3	Canada – Industry Canada	7
2.1.4	Japan – VCCI	7
2.1.5	Acceptance by Mutual Recognition Arrangement	7
2.2	Test Facilities	8
2.2.1	Emission Test Facility	8
2.2.2	Immunity Test Facility	8
2.3	Measurement Uncertainty	8
2.3.1	Sample Calculation – radiated & conducted emissions	9
2.3.2	Measurement Uncertainties	9
2.4	Calibration Traceability	10
3	Product Information	11
3.1	Product Description	11
3.2	Equipment Configuration	12
3.3	Operating Mode	12
3.4	Unique Antenna Connector	13
3.4.1	Results	13
4	Emissions	14
4.1	Output Power Requirements	14
4.1.1	Test Method	14
4.1.2	Results	15
4.2	Occupied Bandwidth	43
4.2.1	Test Method	43
4.2.2	Results	44
4.3	Out-of-Band Emissions	58
4.3.1	Test Method	58
4.3.2	Test Result	59

Table of Contents

4.4	Peak Power Spectral Density	97
4.4.1	Test Method	97
4.4.2	Results	98
4.5	Maximum Permissible Exposure	124
4.5.1	Test Methodology	124
4.5.2	RF Exposure Limit	124
4.5.3	EUT Operating Condition	124
4.5.4	Classification	125
4.5.5	Test Results	125
4.5.6	Sample Calculation	125
4.6	Transmitter Spurious Emissions	126
4.6.1	Test Methodology	126
4.6.2	Transmitter Spurious Emission Limit	127
4.6.3	Test Results	127
4.6.4	Sample Calculation	150
4.7	Receiver Spurious Emissions	151
4.7.1	Test Methodology	151
4.7.2	Receiver Spurious Emission Limit	152
4.7.3	Test Results	152
4.8	AC Conducted Emissions	157
4.8.1	Test Methodology	157
4.8.2	Test Results	157
5	<i>Test Equipment List</i>	162
5.1	Equipment List	162
6	<i>EMC Test Plan</i>	163
6.1	Introduction	163
6.2	Customer	163
6.3	Equipment Under Test (EUT)	164
6.4	Test Specifications	168

Index of Tables

Table 1: Summary of Test Results.....	6
Table 2: Summary of Uncertainties	9
Table 3: RF Output Power at the Antenna Port – Test Results.....	15
Table 4: Average Output Power at the Antenna Port – Reference Use Only	17
Table 5: Occupied Bandwidth – Test Results	44
Table 6: Emissions at the Band-Edge – Test Results.....	59
Table 7: Out of band Conducted Emission – Test Results.....	60
Table 8: Peak Power Spectral Density – Test Results	98
Table 9: Transmit Spurious Emission at Band-Edge Requirements	128
Table 10: AC Conducted Emissions – Test Results.....	157
Table 11: Customer Information	163
Table 12: Technical Contact Information	163
Table 13: EUT Specifications	164
Table 14: EUT Channel Power Specifications.....	165
Table 15: Interface Specifications.....	165
Table 16: Supported Equipment.....	165
Table 17: Description of Sample used for Testing.....	166
Table 18: Description of Test Configuration used for Radiated Measurement.	166
Table 19: Final Test Mode for 2400 MHz to 2483.5MHz Band.....	167
Table 20: Test Specifications.....	168

1 Executive Summary

1.1 Scope

This report is intended to document the status of conformance with the requirements of the CFR 47 Part 15.247:2010 and RSS 210:2010 based on the results of testing performed on 23 September 2011 through 8 November 2011 on the Wireless uDSL Residential Gateway Model 5168NV manufactured by Pace Americas. This report only applies to the specific samples tested under the stated test conditions. It is the responsibility of the manufacturer to assure that additional production units of this model are manufactured with identical or EMI equivalent electrical and mechanical components. This report is further intended to document changes and modifications to the EUT throughout its life cycle. All documentation will be included as a supplement.

1.2 Purpose

Testing was performed to evaluate the EMC performance of the EUT in accordance with the applicable requirements, procedures, and criteria defined in the application of regulations and application of standards listed in this report.

1.3 Summary of Test Results

Table 1: Summary of Test Results

Test	Test Method ANSI C63.4	Test Parameters (from Standard)	Result
Spurious Emission in Received Mode	CFR47 15.109, RSS-GEN Sect.7.2.3	Class B	Complied
Spurious Emission in Transmitted Mode	CFR47 15.209, RSS-GEN Sect.7.2.3	Class B	Complied
Restricted Bands of Operation	CFR47 15.205, RSS 210 Sect.2.6	Class B	Complied
AC Power Conducted Emission	CFR47 15.207, RSS-GEN Sect.7.2.2	Class B	Complied
Occupied Bandwidth	CFR47 15.247 (a2), RSS GEN Sect.4.4.1	500 kHz Minimum	Complied
Maximum Transmitted Power	CFR47 15.247 (b3), RSS 210 Sect. A.8.4	30 dBm w/ 6 dBi antenna	Complied
Peak Power Spectral Density	CFR47 15.247 (e), RSS 210 Sect. A.8.2	8 dBm/ 3 kHz.	Complied
Band Edge Measurement	CFR47 15.247 (d), RSS 210 Sect. A.8.5	30 dBr	Complied
RF Exposure	CFR47 15.247 (i), 2.1091	General Population	Complied

1.4 Special Accessories

No special accessories were necessary in order to achieve compliance.

1.5 Equipment Modifications

None.

2 Laboratory Information

2.1 Accreditations & Endorsements

2.1.1 US Federal Communications Commission



TUV Rheinland of North America at 1279 Quarry Lane, Ste. A., Pleasanton, CA 94566, is recognized by the commission for performing testing services for the general public on a fee basis. These laboratory test facilities have been fully described in reports submitted to and accepted by the FCC (FRN # US5254). The laboratory scope of accreditation includes: Title 47 CFR Parts 15, 18, and 90. The accreditation is updated every 3 years.

2.1.2 NIST / NVLAP



TUV Rheinland of North America is accredited by the National Voluntary Laboratory Accreditation Program, which is administered under the auspices of the National Institute of Standards and Technology. The laboratory has been assessed and accredited in accordance with ISO Guide 17025:2005 and ISO 9002 (Lab Code 500011-0). The scope of laboratory accreditation includes emission and immunity testing. The accreditation is updated annually.

2.1.3 Canada – Industry Canada

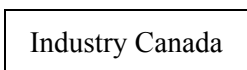

TUV Rheinland of North America at the 1279 Quarry Ln, Pleasanton, CA 94566 address is accredited by Industry Canada for performing testing services for the general public on a fee basis. This laboratory test facilities have been fully described in reports submitted to and accepted by Industry Canada (File Number 2932M-1). This reference number is the indication to the Industry Canada Certification Officers that the site meets the requirements of RSS 212, Issue 1 (Provisional). The accreditation is updated every 3 years.

2.1.4 Japan – VCCI



The Voluntary Control Council for Interference by Information Technology Equipment (VCCI) is a group that consists of Information Technology Equipment (ITE) manufacturers and EMC test laboratories. The purpose of the Council is to take voluntary control measures against electromagnetic interference from Information Technology Equipment, and thereby contribute to the development of a socially beneficial and responsible state of affairs in the realm of Information Technology Equipment in Japan. TUV Rheinland of North America at 1279 Quarry Lane, Pleasanton, CA 94566 has been assessed and approved in accordance with the Regulations for Voluntary Control Measures. ((Registration Nos. R-3701, G-447, C-4144, T-1176, C-4145, T-1177).

2.1.5 Acceptance by Mutual Recognition Arrangement



The United States has an established agreement with specific countries under the Asia Pacific Laboratory Accreditation Corporation (APLAC) Mutual Recognition Arrangement. Under this agreement, all TUV Rheinland at 1279 Quarry Lane, Pleasanton, CA 94566 test results and test reports within the scope of the laboratory NIST / NVLAP accreditation will be accepted by each member country.

2.2 Test Facilities

All of the test facilities are located at 1279 Quarry Lane, Ste. A, Pleasanton, California 94566, USA. The 2305 Mission College, Santa Clara, 95054, USA location is considered a Pleasanton annex.

2.2.1 Emission Test Facility

The Semi-Anechoic chamber and AC Line Conducted measurement facility used to collect the radiated and conducted data has been constructed in accordance with ANSI C63.7:1992. The site has been measured in accordance with and verified to comply with the theoretical normalized site attenuation requirements of ANSI C63.4:2003, at test distances of 3 and 5 meters. The site is listed with the FCC and accredited by NVLAP (Lab Code 500011-0). The 3/5-meter semi-anechoic chamber used to collect the radiated data has been verified to comply with the theoretical normalized site attenuation requirements of ANSI C63.4:2003, at test distances of 3 meters and 5 meters. A report detailing this site can be obtained from TUV Rheinland of North America.

2.2.2 Immunity Test Facility

ESD, EFT, Surge, PQF: These tests are performed in an environmentally controlled room with a 3.7 m x 4.8 m x 3.175 mm thick aluminum floor connected to PE ground.

For ESD testing, tabletop equipment is placed on an insulated mat with a surface resistivity of 10^9 Ohms/square on a 1.6 m x 0.8 m x 0.8 m high non-conductive table with a 3.175 mm aluminum top (Horizontal Coupling Plane). The HCP is connected to the main ground plane via a low impedance ground strap through two 470-k Ω resistors. The Vertical Coupling Plane consists of an aluminum plate 50 cm x 50 cm x 3.175 mm thick. The VCP is connected to the main ground plane via a low impedance ground strap through two 470-k Ω resistors.

For EFT, Surge, PQF, the HCP and VCP are removed.

RF Field Immunity testing is performed in a 7.3m x 4.3m x 4.1m anechoic chamber.

RF Conducted and Magnetic Field Immunity testing is performed on a 4.8m x 3.7m x 3.175mm thick aluminum ground plane.

All test areas allow a minimum distance of 1 meter from the EUT to walls or conducting objects.

2.3 Measurement Uncertainty

Two types of measurement uncertainty are expressed in this report, per *ISO Guide To The Expression Of Uncertainty In Measurement*, 1st Edition, 1995.

The Combined Standard Uncertainty is the standard uncertainty of the result of a measurement when that result is obtained from the values of a number of other quantities; it is equal to the positive square root of the sum of the variances or co-variances of these other quantities, weighted according to how the measurement result varies with changes in these quantities. The term *standard uncertainty* is the result of a measurement expressed as a standard deviation.

The *Expanded Uncertainty* defines an interval about the result of a measurement that may be expected to encompass a large fraction of the distribution of values that could reasonably be attributed to the measurand. The fraction may be viewed as the coverage probability or level of confidence of the interval.

2.3.1 Sample Calculation – radiated & conducted emissions

The field strength is calculated by subtracting the Amplifier Gain and adding the Cable Loss and Antenna Correction Factor to the measured reading. The basic equation is as follows:

$$\text{Field Strength (dB}\mu\text{V/m)} = \text{RAW} - \text{AMP} + \text{CBL} + \text{ACF}$$

Where: RAW = Measured level before correction (dBμV)

AMP = Amplifier Gain (dB)

CBL = Cable Loss (dB)

ACF = Antenna Correction Factor (dB/m)

$$\mu\text{V/m} = 10^{\frac{\text{dB}\mu\text{V/m}}{20}}$$

Sample radiated emissions calculation @ 30 MHz

Measurement +Antenna Factor–Amplifier Gain+Cable loss=Radiated Emissions (dBuV/m)

$$25 \text{ dBuV/m} + 17.5 \text{ dB} - 20 \text{ dB} + 1.0 \text{ dB} = 23.5 \text{ dBuV/m}$$

2.3.2 Measurement Uncertainties

Table 2: Summary of Uncertainties

	U_{lab}	U_{cispr}
Radiated Disturbance		
30 MHz – 25,000 MHz	3.2 dB	5.2 dB
Conducted Disturbance @ Mains Terminals		
150 kHz – 30 MHz	2.4 dB	3.6 dB
Disturbance Power		
30 MHz – 300 MHz	3.92 dB	4.5 dB

Note: U_{lab} is the calculated Combined Standard Uncertainty
 U_{cispr} is the measurement uncertainty requirement per CISPR 16.

Measurement Uncertainty Immunity

The estimated combined standard uncertainty for ESD immunity measurements is $\pm 4.1\%$.
The estimated combined standard uncertainty for radiated immunity measurements is $\pm 2.7\text{dB}$.
The estimated combined standard uncertainty for conducted immunity measurements is $\pm 1.4\text{dB}$.
The estimated combined standard uncertainty for damped oscillatory wave immunity measurements is $\pm 8.8\%$.
The estimated combined standard uncertainty for harmonic current and flicker measurements is $\pm 0.45\%$.

Measurement Uncertainty – Radio Testing

The estimated combined standard uncertainty for frequency error measurements is $\pm 3.88\text{ Hz}$
The estimated combined standard uncertainty for carrier power measurements is $\pm 1.59\text{ dB}$.
The estimated combined standard uncertainty for adjacent channel power measurements is $\pm 1.47\text{ dB}$.
The estimated combined standard uncertainty for modulation frequency response measurements is $\pm 0.46\text{ dB}$.
The estimated combined standard uncertainty for transmitter conducted emission measurements is $\pm 4.01\text{ dB}$

The expanded uncertainty at a level of 95% confidence is obtained by multiplying the combined standard uncertainty by a coverage factor of 2. Compliance criteria are not based on measurement uncertainty.

2.4 Calibration Traceability

All measurement instrumentation is traceable to the National Institute of Standards and Technology (NIST). Measurement method complies with ANSI/NCSL Z540-1-1994 and ISO Guide 17025:2005.

3 Product Information

3.1 Product Description

Pace Americas 5168NV is a residential gateway that provides an 802.11b/g/n Wi-Fi access point and ethernet switch function for connecting personal computers and other in-home networked devices to the service provider's network. The 5168NV features:

- 1-DSL (RJ-11) Broadband Modem Port
- 4-Ethernet Ports/
- 1 Ethernet/ Broadband Port
- 1-2line RJ14 FXS (VoIP) port
- 1 USB Home Network
- 1 Cable Modem
- 802.11b/g/n Wireless Access Point

The 5168NV was chosen to represent the product family, including Model 5168N, 5138N, 5138NV, 5133N, 5133NV, 5108N, and 5108NV.

Model Differences:

Model Number	Broadband Interface	HPNA	Ethernet ports	Wireless	VoIP	USB
5168NV	Bonded uDSL (TP or Coaxial) Optional WAN 10/100/1000	HPNA (Coaxial)	4 x 10/100/1000	802.11N (2x2)	2 x FXS	Optional USB Host ports (2)
5168N	Bonded uDSL (TP or Coaxial) Optional WAN 10/100/1000	HPNA (Coaxial)	4 x 10/100/1000	802.11N (2x2)		Optional USB Host ports (2)
5138NV	uDSL (TP or Coaxial) Optional WAN 10/100/1000	HPNA (Coaxial)	4 x 10/100/1000	802.11N (2x2)	2 x FXS	Optional USB Host ports (2)
5138N	uDSL (TP or Coaxial) Optional WAN 10/100/1000	HPNA (Coaxial)	4 x 10/100/1000	802.11N (2x2)		Optional USB Host ports (2)
5133NV	uDSL (TP or Coaxial) Optional WAN 10/100/1000	HPNA (Coaxial)	4 x 10/100/1000	802.11N (2x2)	2 x FXS	Optional USB Host ports (2)
5133N	uDSL (TP or Coaxial) Optional WAN 10/100/1000	HPNA (Coaxial)	4 x 10/100/1000	802.11N (2x2)		Optional USB Host ports (2)
5108NV	WAN - 10/100/1000	HPNA (Coaxial)	4 x 10/100/1000	802.11N (2x2)	2 x FXS	Optional USB Host ports (2)
5108N	WAN - 10/100/1000	HPNA (Coaxial)	4 x 10/100/1000	802.11N (2x2)		Optional USB Host ports (2)

* Bonded implies 2 lines for increased bandwidth.

* uDSL supports either a ADSL or VDSL connection

3.2 Equipment Configuration

A description of the equipment configuration is given in Test Plan Section. The EUT was tested as called for in the test standard and was configured and operated in a manner consistent with its intended use. The EUT was connected to rated power and allowed to reach intended operating conditions. The placement of the EUT system components was guided by the test standard and selected to represent typical installation conditions.

In the case of an EUT that can operate in more than one configuration, preliminary testing was performed to determine the configuration that produced maximum radiation.

The final configuration was selected to produce the worst case radiation for emissions testing and to place the EUT in the most susceptible state for immunity testing.

3.3 Operating Mode

A description of the operation mode is given in Test Plan Section. In the case of an EUT that can operate in more than one state, preliminary testing was performed to determine the operating mode that produced maximum radiation.

The final operating mode was selected to produce the worst case radiation for emissions testing and to place the EUT in the most susceptible state for immunity testing.

3.4 Unique Antenna Connector

An intentional radiator shall be designed to ensure that no antenna other than that furnished by the responsible party shall be used with the device. The use of a permanently attached antenna or of an antenna that uses a unique coupling to the intentional radiator shall be considered sufficient to comply with the provisions of this section. The manufacturer may design the unit so that a broken antenna can be replaced by the user, but the use of a standard antenna jack or electrical connector is prohibited. This requirement does not apply to carrier current devices or to devices operated under the provisions of CFR47 Parts 15.211, 15.213, 15.217, 15.219, or 15.221.

3.4.1 Results

The 5168NV uses the permanently attached antennas inside the device. See EUT Photo for details.

4 Emissions

Testing was performed in accordance with CFR 47 Part 15.247:2010 and RSS 210 Annex 8:2010. These test methods are listed under the laboratory's NVLAP Scope of Accreditation. This test measures the levels emanating from the EUT, thus evaluating the potential for the EUT to cause radio frequency interference to other electronic devices. Procedures described in ANSI C63.10: 2009 were used.

4.1 Output Power Requirements

The maximum peak output power requirement is the maximum equivalent isotropic radiated power delivering at the transmitting antenna under specified conditions of measurements in the presence of modulation.

The maximum output power and harmonics shall not exceed CFR47 Part 15.247 (b3):2010 and RSS 210 A.8.4: 2010

The maximum transmitted power is +30 dBm or 1 Watt.

4.1.1 Test Method

The conducted method was used to measure the channel power output according to ANSI C63.10:2009 Section 6.10.3.1. The measurement was performed with modulation per CFR47 Part15.247 (b3):2010 and RSS 210 A.8.4: 2010. This test was conducted on 3 channels of Sample, S/N 31104000521. The worst mode result indicated below.

Test Setup:

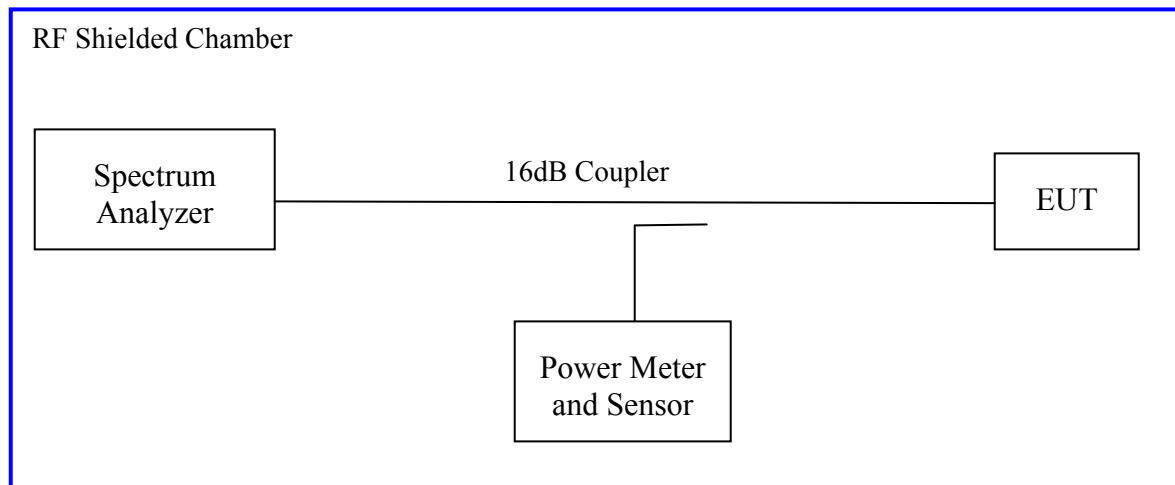

Method #1 of "Measurement of Digital Transmission Systems Operating under Section 15.247" applies since the 5168NV continuously transmit; where T, Transmission Duration Pulse, is greater than analyzer sweep time. Sample detector was used.

4.1.2 Results

As originally tested, the EUT was found to be compliant to the requirements of the test standard(s).

Table 3: RF Output Power at the Antenna Port – Test Results

Test Conditions: Conducted Measurement, Normal Temperature					
Antenna Type: Integrated			Power Setting: See test plan		
Max. Antenna Gain: +3.0 dBi			Signal State: Modulated		
Ambient Temp.: 22 °C			Relative Humidity: 41%		
802.11b Mode					
Frequency	Limit [dBm]	Chain 0 [dBm]	Chain 1 [dBm]	Total Power [dBm]	Margin [dB]
2412MHz	+30.00	+22.79			-7.21
2437MHz	+30.00	+24.45			-5.55
2462MHz	+30.00	+22.53			-7.47
Note: The highest output power was observed at 1Mbps. Only one chain would be active in this mode. The highest EIRP for 801.11b is 0.556 Watt					
802.11g Mode					
Frequency	Limit [dBm]	Chain 0 [dBm]	Chain 1 [dBm]	Total Power [dBm]	Margin [dB]
2412MHz	+30.00	+18.52			-11.48
2437MHz	+30.00	+23.92			-6.08
2462MHz	+30.00	+18.94			-11.06
Note: The highest output power was observed at 6 Mbps. Only one chain would be active in this mode. The highest EIRP for 802.11g is 0.492 Watt.					
802.11n (HT20) Mode, 1x2					
Frequency	Limit [dBm]	Chain 0 [dBm]	Chain 1 [dBm]	Total Power [dBm]	Margin [dB]
2412MHz	+30.00	+19.31			-10.69
2437MHz	+30.00	+24.35			-5.65
2462MHz	+30.00	+19.25			-10.75
Note: The highest output power was observed at HT20 6.5 Mbps, 1 Data Stream. Only one chain would be active in this mode. The highest for 802.11 HT20 in 1x2 is 0.543 Watt					

802.11n (HT20) Mode, 2x2					
Frequency	Limit [dBm]	Chain 0 [dBm]	Chain 1 [dBm]	Total Power [dBm]	Margin [dB]
2412MHz	+30.00	+15.87	+14.26	+18.15	-11.85
2437MHz	+30.00	+21.59	+20.70	+24.18	-5.82
2462MHz	+30.00	+15.80	+14.02	+18.01	-11.99
Note: The highest output power was observed at HT20 13 Mbps, 2 Data Stream. The total highest for 802.11 HT20 in 2x2 is 0.522 Watt					
802.11n (HT40) Mode, 1x2					
Frequency	Limit [dBm]	Chain 0 [dBm]	Chain 1 [dBm]	Total Power [dBm]	Margin [dB]
2422MHz	+30.00	+16.19			-13.81
2437MHz	+30.00	+19.09			-10.91
2452MHz	+30.00	+15.33			-14.67
Note: The highest output power was observed at HT40 13.5 Mbps, 1 Data Stream. The highest for 802.11 HT20 in 1x2 is 0.543 Watt					
802.11n (HT40) Mode, 2x2					
Frequency	Limit [dBm]	Chain 0 [dBm]	Chain 1 [dBm]	Total Power [dBm]	Margin [dB]
2422MHz	+30.00	+15.31	+14.63	+17.99	-12.01
2437MHz	+30.00	+18.43	+18.55	+21.50	-8.50
2452MHz	+30.00	+16.17	+16.03	+19.11	-10.89
Note: The highest output power was observed at HT40 27 Mbps, 2 Data Stream. The highest for 802.11 HT20 in 2x2 is 0.282 Watt.					

Table 4: Average Output Power at the Antenna Port – Reference Use Only

Test Conditions: Conducted Measurement, Normal Temperature					
Antenna Type: Integrated			Power Setting: See test plan		
Max. Antenna Gain: +3.0 dBi			Signal State: Modulated		
Ambient Temp.: 22 °C			Relative Humidity: 41%		
802.11b Mode					
Frequency	Limit [dBm]	Chain 0 [dBm]	Chain 1 [dBm]	Total Power [dBm]	Margin [dB]
2412MHz	Na	+23.41			
2437MHz	Na	+25.41			
2462MHz	Na	+23.58			
Note: The highest output power was observed at 1Mbps. Only one chain would be active in this mode.					
802.11g Mode					
Frequency	Limit [dBm]	Chain 0 [dBm]	Chain 1 [dBm]	Total Power [dBm]	Margin [dB]
2412MHz	Na	+19.37			
2437MHz	Na	+24.92			
2462MHz	Na	+19.36			
Note: The highest output power was observed at 6 Mbps. Only one chain would be active in this mode.					
802.11n (HT20) Mode, 1x2					
Frequency	Limit [dBm]	Chain 0 [dBm]	Chain 1 [dBm]	Total Power [dBm]	Margin [dB]
2412MHz	Na	+18.96			
2437MHz	Na	+24.95			
2462MHz	Na	+19.58			
Note: The highest output power was observed at HT20 6.5 Mbps, 1 Data Stream. Only one chain would be active in this mode.					
802.11n (HT20) Mode, 2x2					
Frequency	Limit [dBm]	Chain 0 [dBm]	Chain 1 [dBm]	Total Power [dBm]	Margin [dB]
2412MHz	Na	+17.96	+16.68	+20.38	
2437MHz	Na	+22.42	+21.50	+24.99	

2462MHz	Na	+17.70	+16.73	+20.25	
Note: The highest output power was observed at HT20 13 Mbps, 2 Data Stream.					
802.11n (HT40) Mode, 1x2					
Frequency	Limit [dBm]	Chain 0 [dBm]	Chain 1 [dBm]	Total Power [dBm]	Margin [dB]
2422MHz	Na	+15.63			
2437MHz	Na	+19.50			
2452MHz	Na	+15.70			
Note: The highest output power was observed at HT40 13.5 Mbps, 1 Data Stream.					
802.11n (HT40) Mode, 2x2					
Frequency	Limit [dBm]	Chain 0 [dBm]	Chain 1 [dBm]	Total Power [dBm]	Margin [dB]
2422MHz	Na	+16.80	+16.67	+19.75	
2437MHz	Na	+19.02	+19.25	+22.15	
2452MHz	Na	+16.83	+16.58	+19.72	
Note: The highest output power was observed at HT40 27 Mbps, 2 Data Stream.					

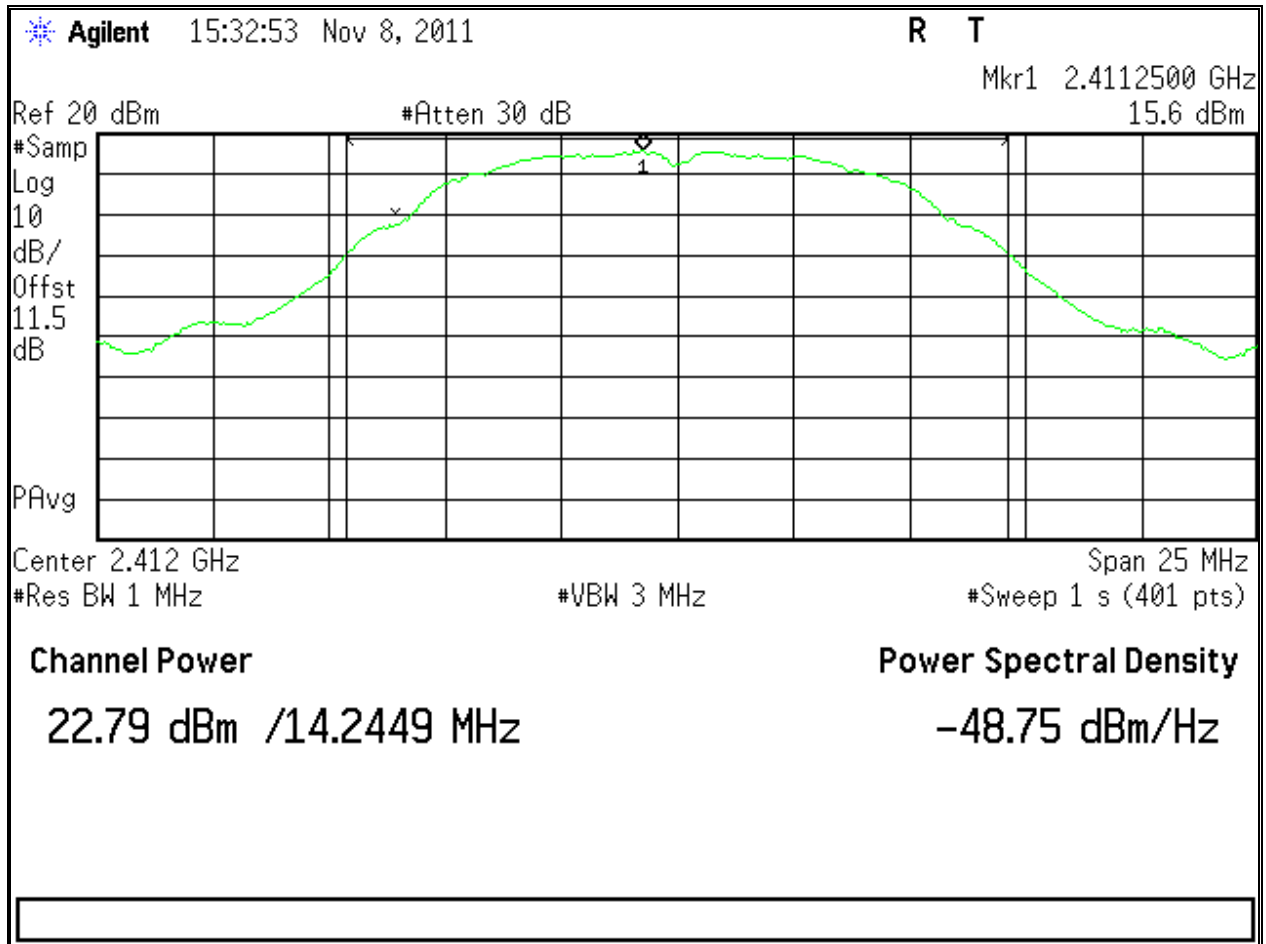

Figure 1: Maximum Transmitted Power, 2412 MHz of 802.11b 1Mbps

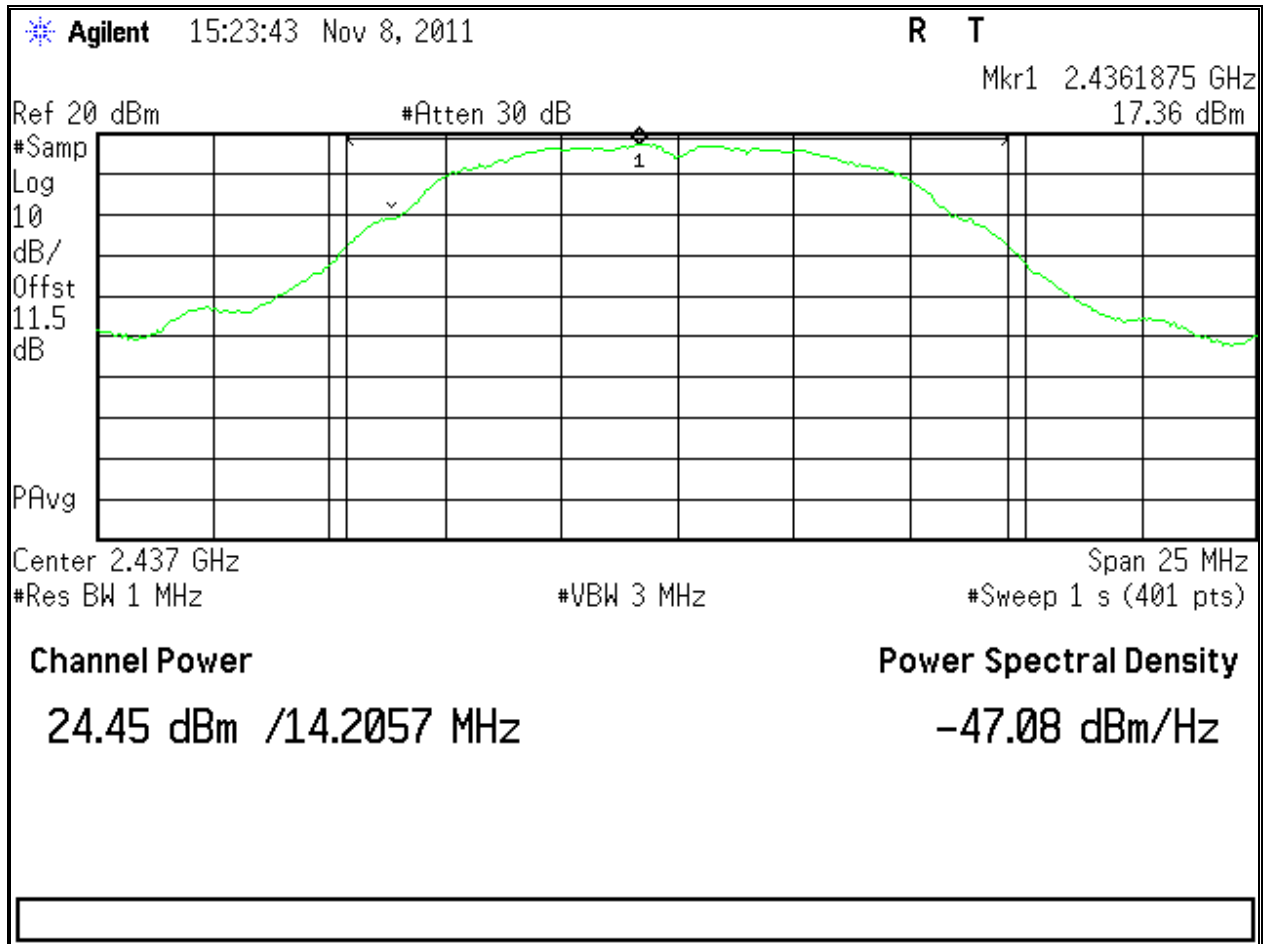

Figure 2: Maximum Transmitted Power, 2437 MHz of 802.11b 1Mbps

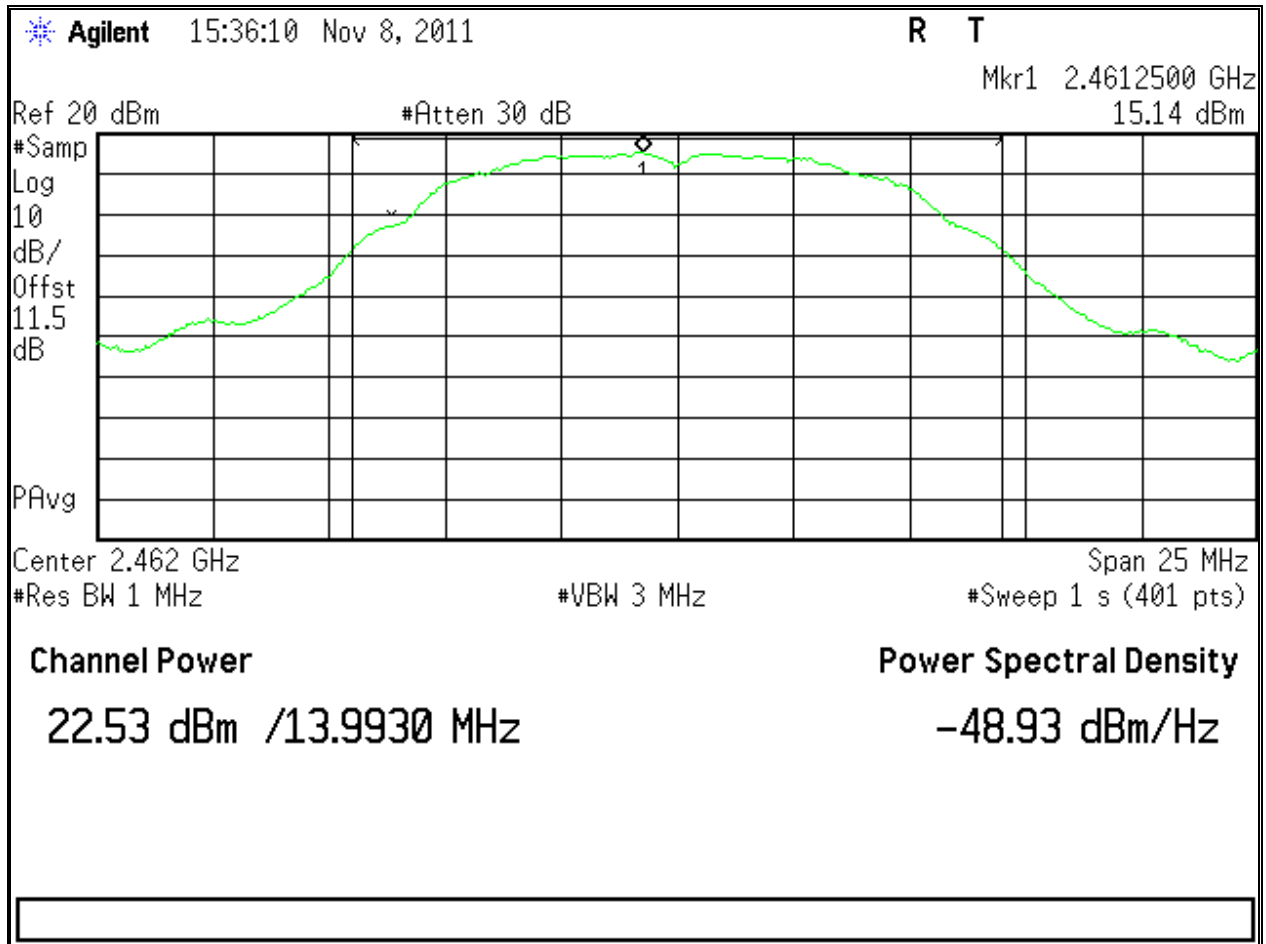

Figure 3: Maximum Transmitted Power, 2462 MHz of 802.11b 1Mbps

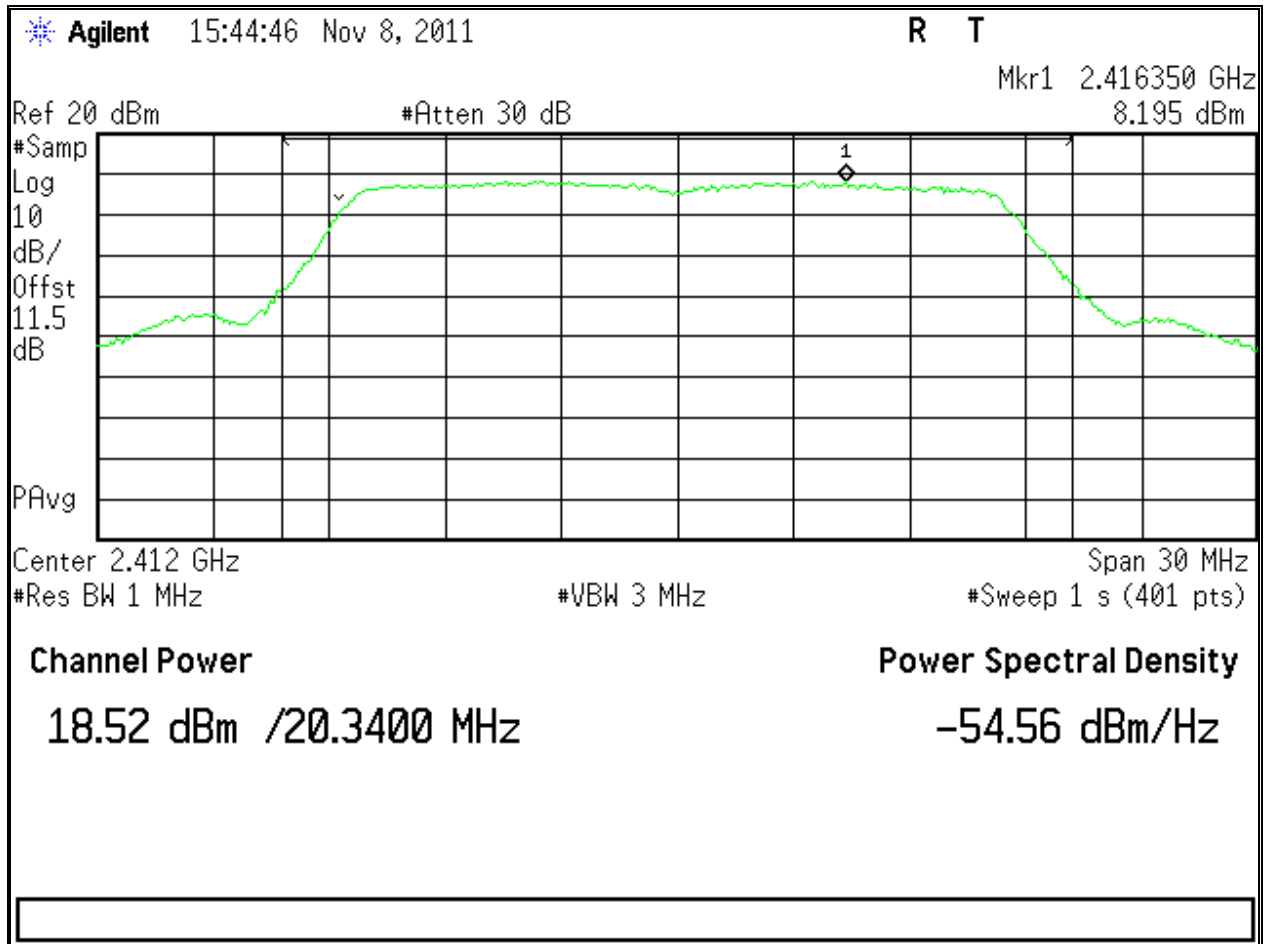

Figure 4: Maximum Transmitted Power, 2412 MHz of 802.11g 6Mbps

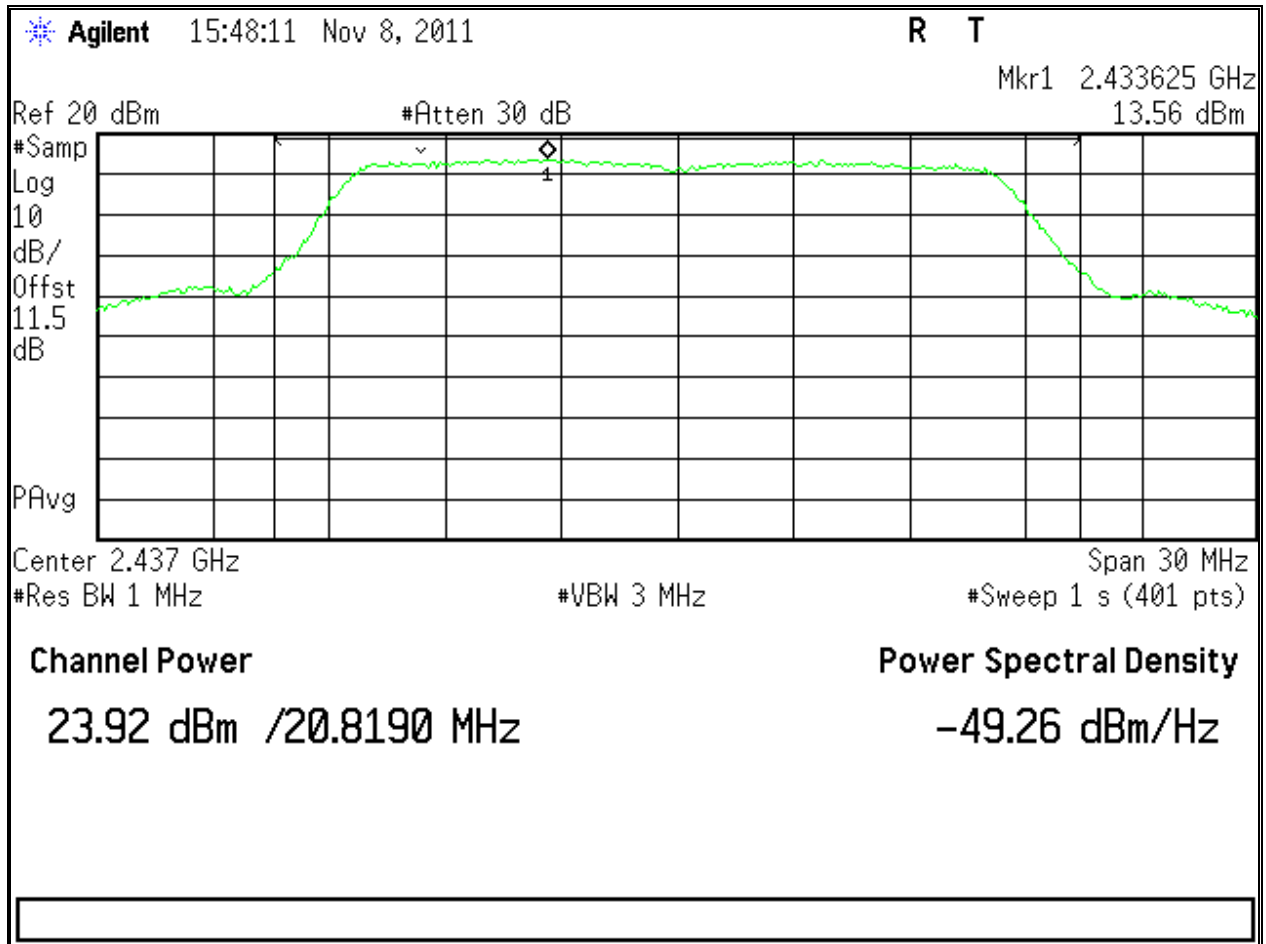

Figure 5: Maximum Transmitted Power, 2437 MHz of 802.11g 6Mbps

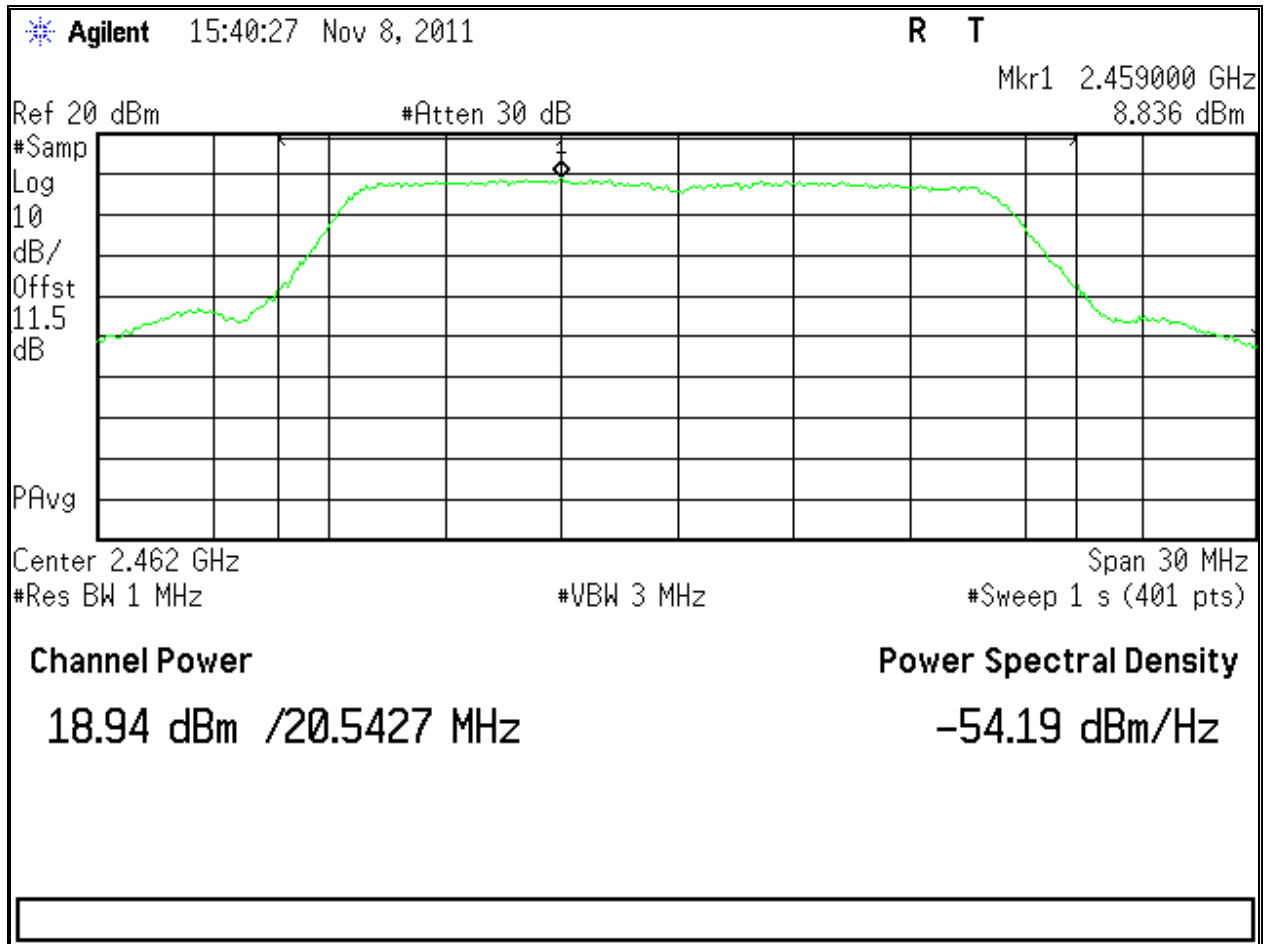

Figure 6: Maximum Transmitted Power, 2462 MHz of 802.11g 6Mbps

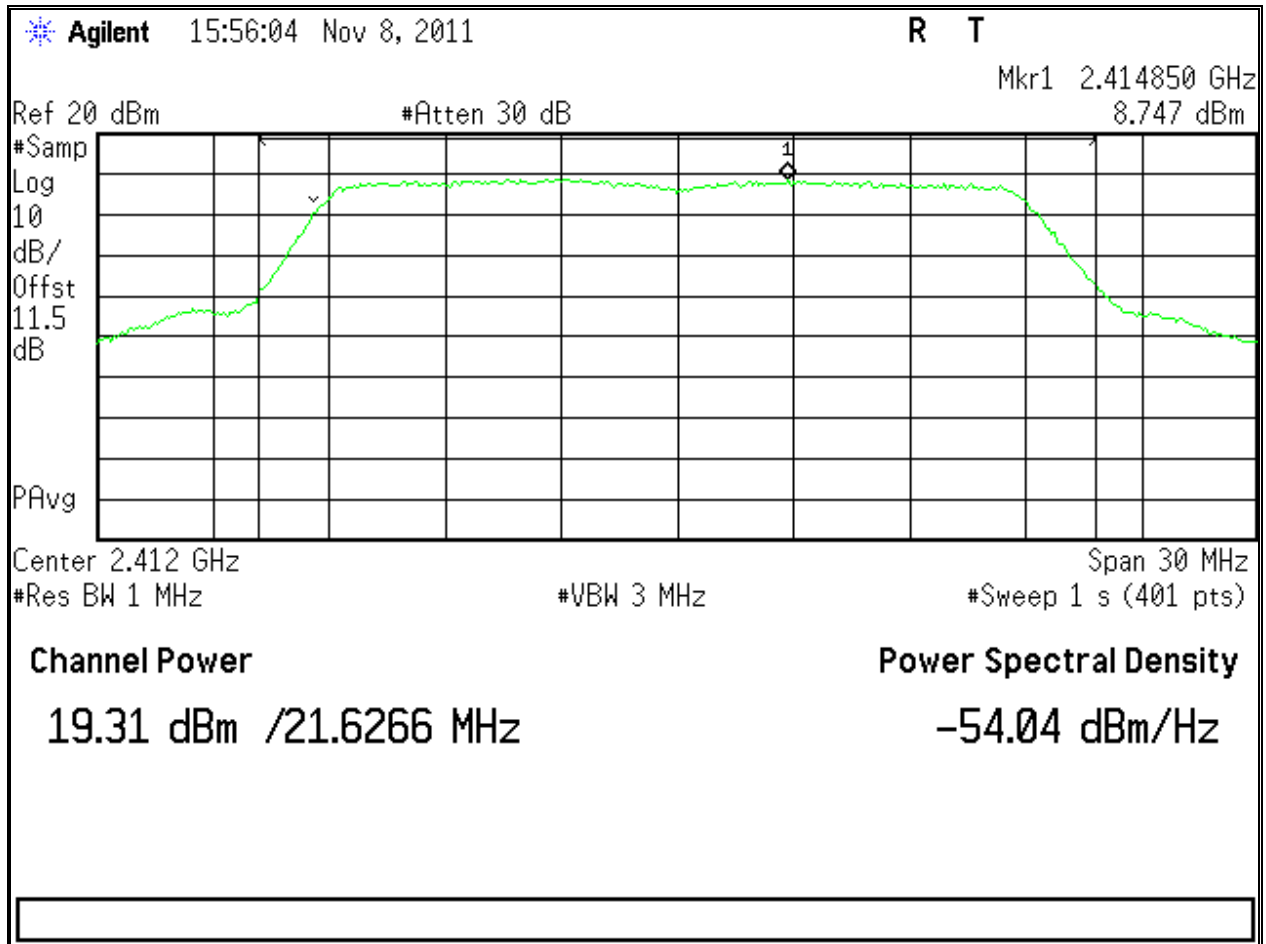

Figure 7: Maximum Transmitted Power, 2412 MHz at HT20 1x2 6.5Mbps

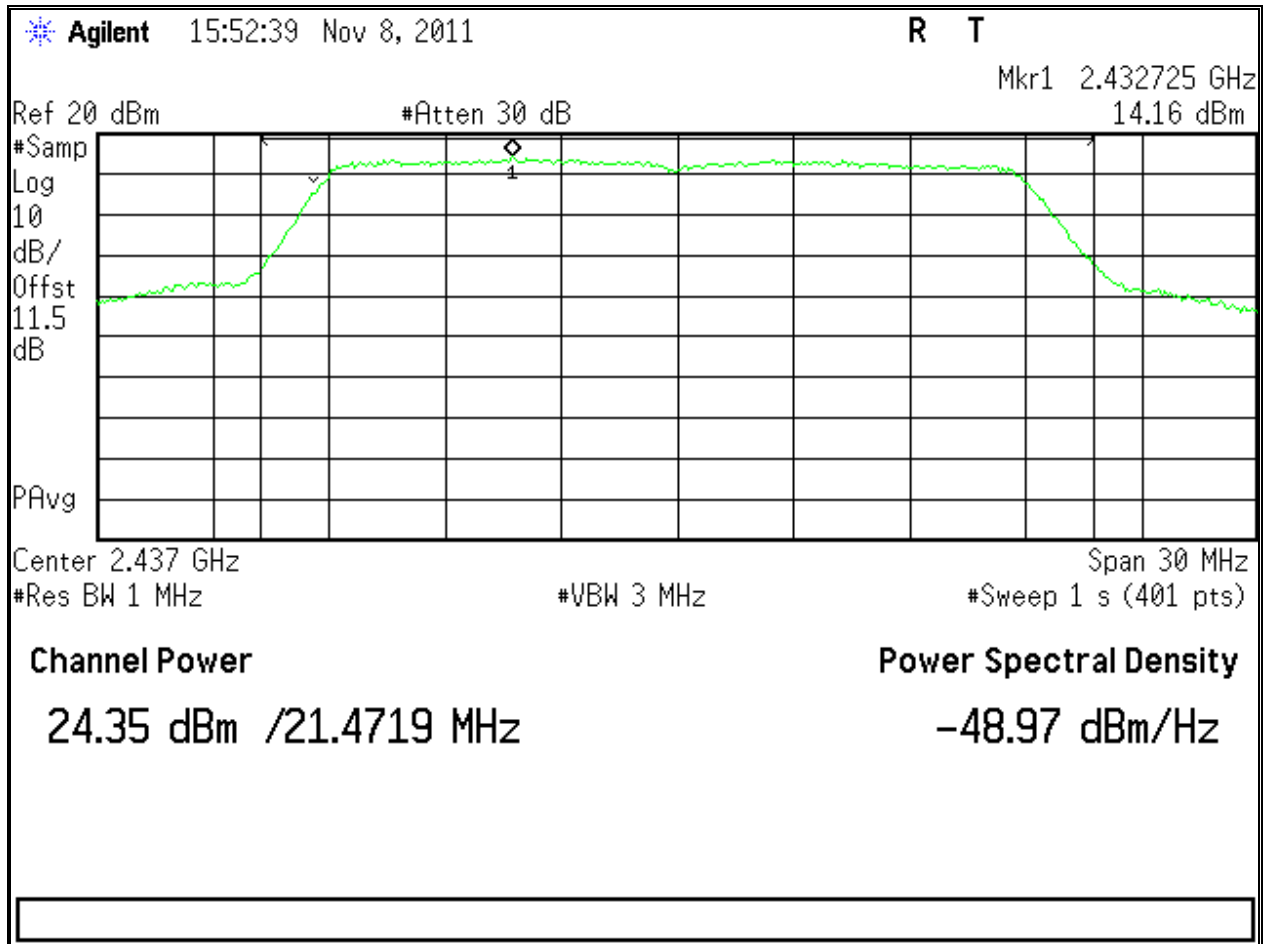

Figure 8: Maximum Transmitted Power, 2437 MHz at HT20 1x2 6.5Mbps

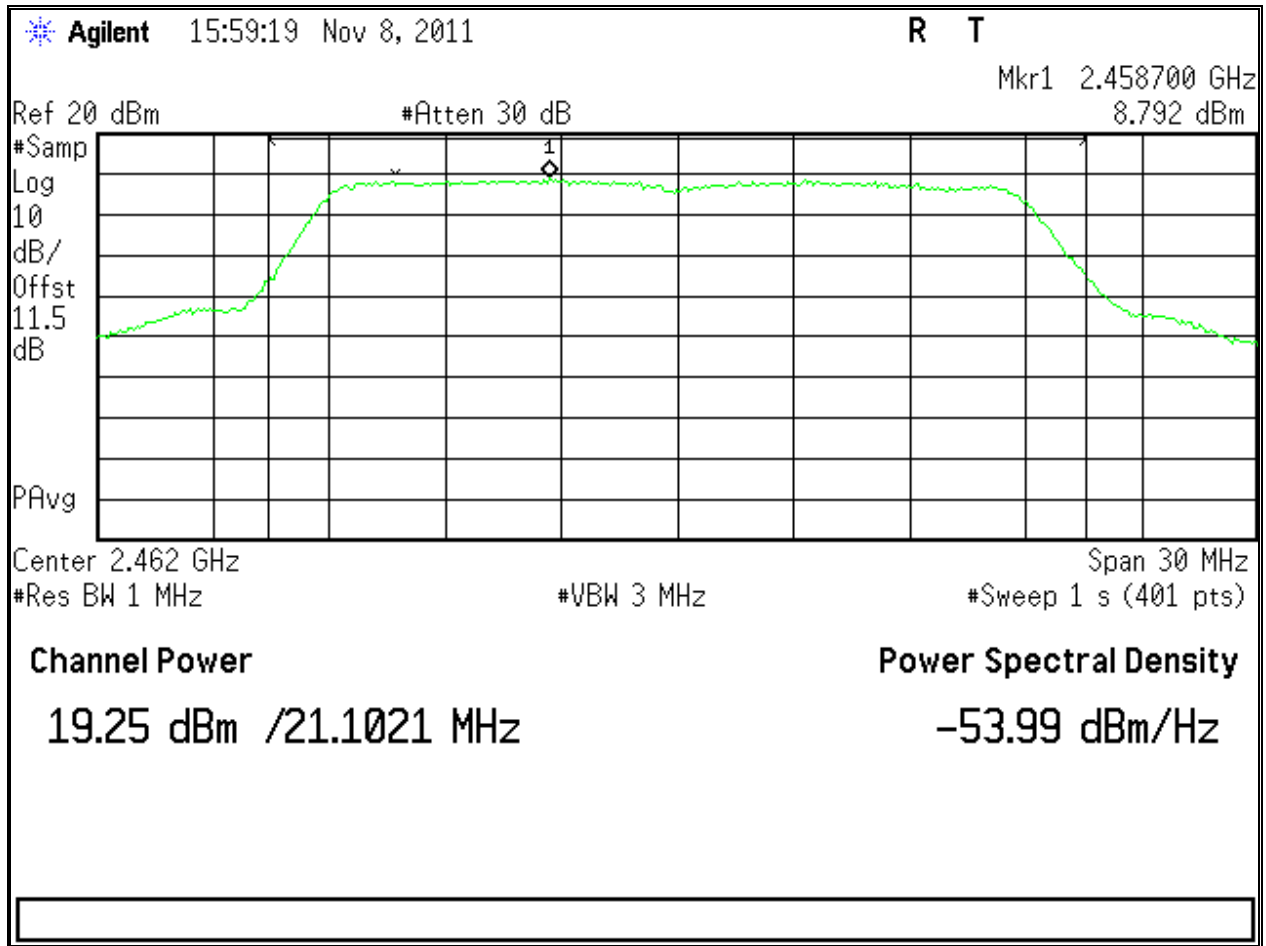

Figure 9: Maximum Transmitted Power, 2462 MHz at HT20 1x2 6.5Mbps

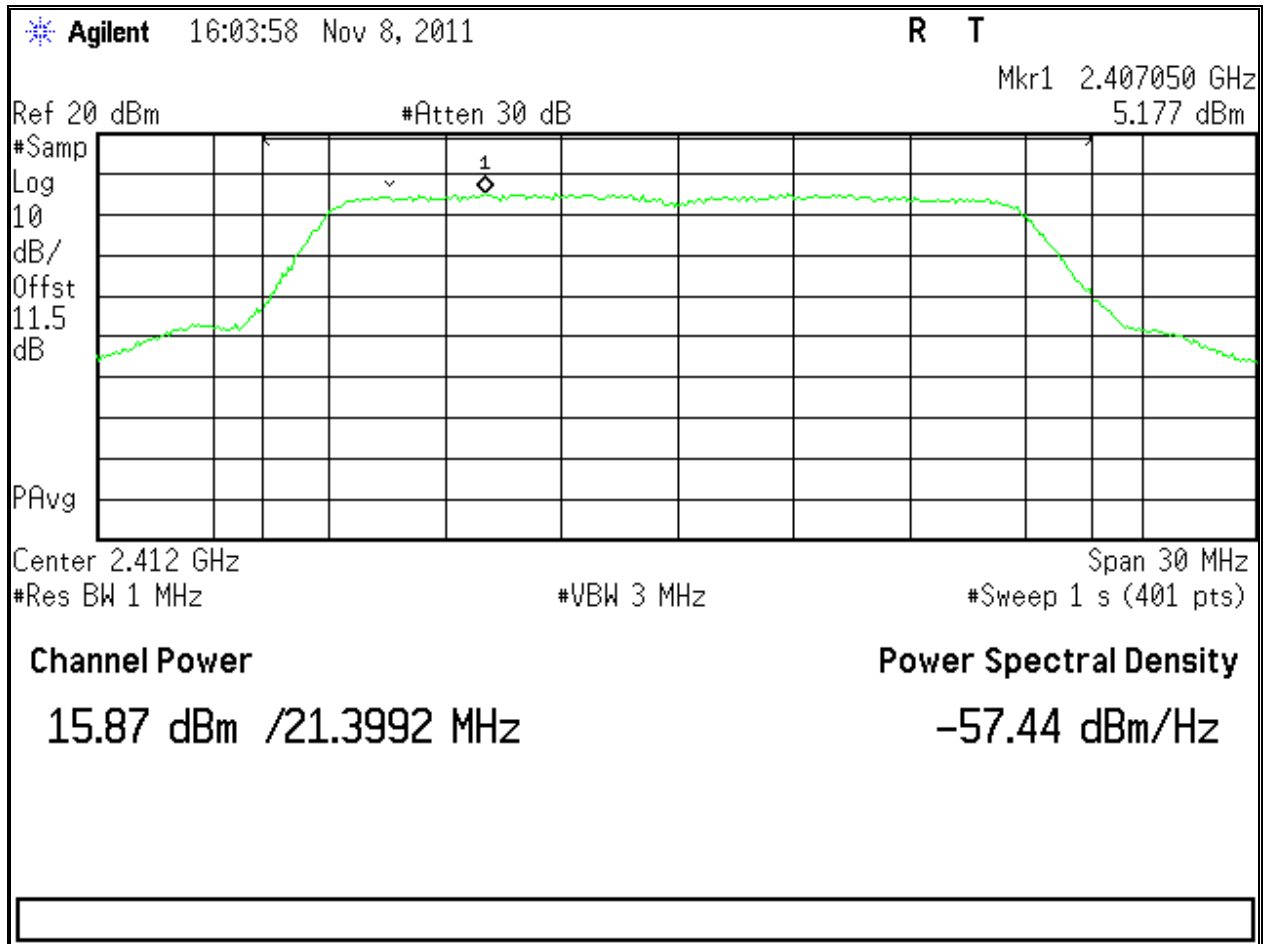

Figure 10: Maximum Transmitted Power, 2412 MHz at HT20 2x2 ch0 13Mbps

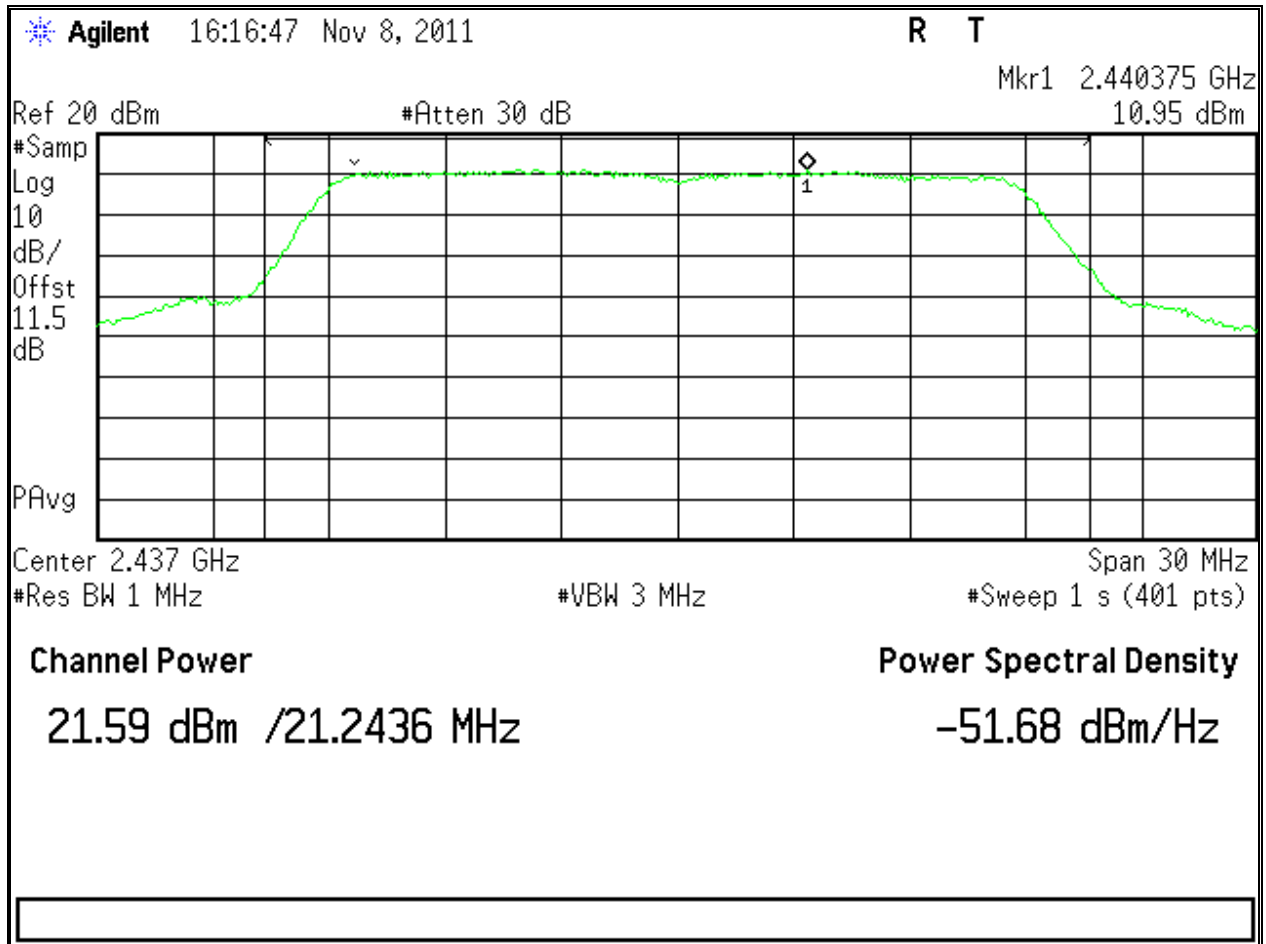

Figure 11: Maximum Transmitted Power, 2437 MHz at HT20 2x2 ch0 13Mbps

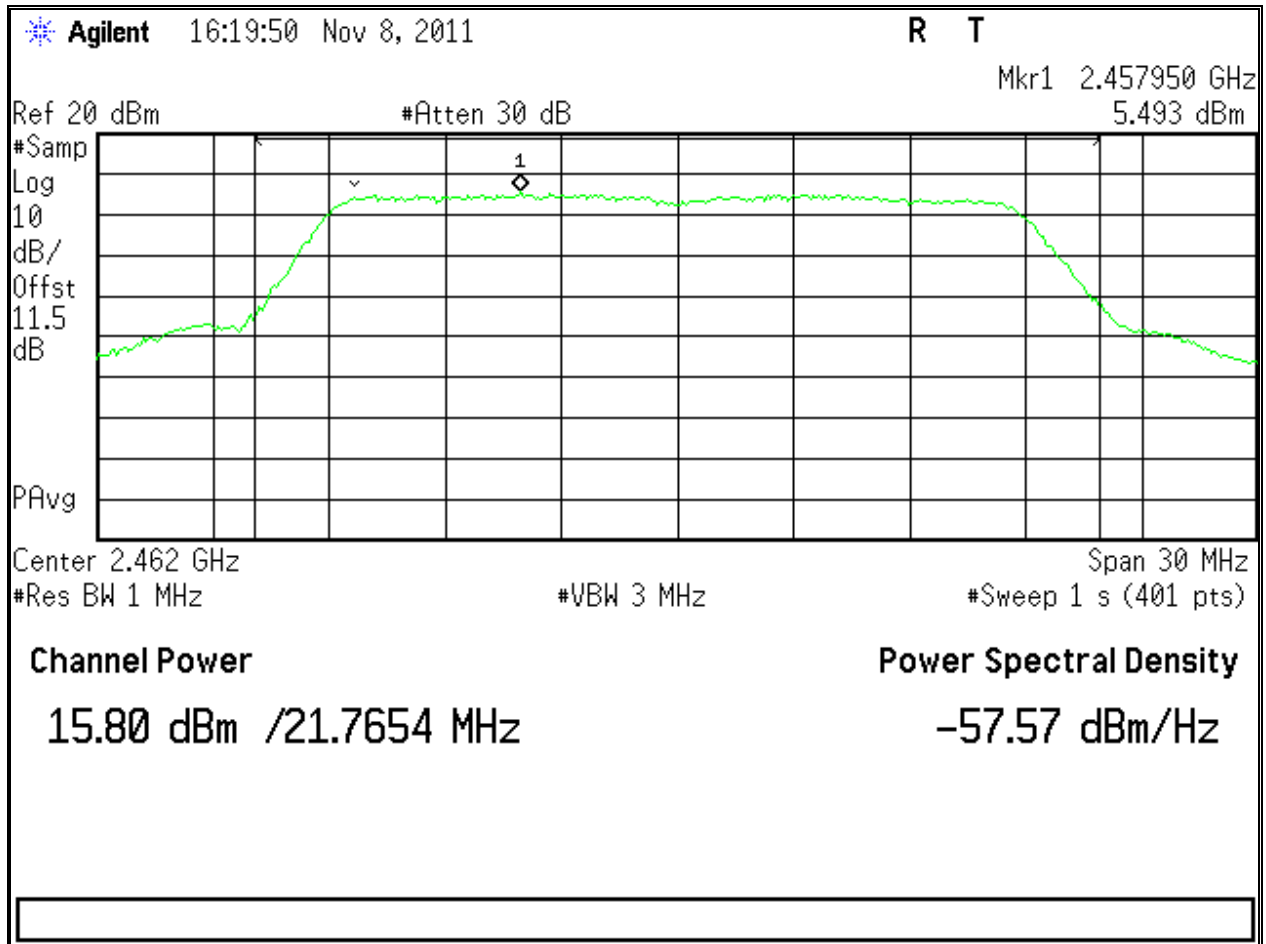

Figure 12: Maximum Transmitted Power, 2462 MHz at HT20 2x2 ch0 13Mbps

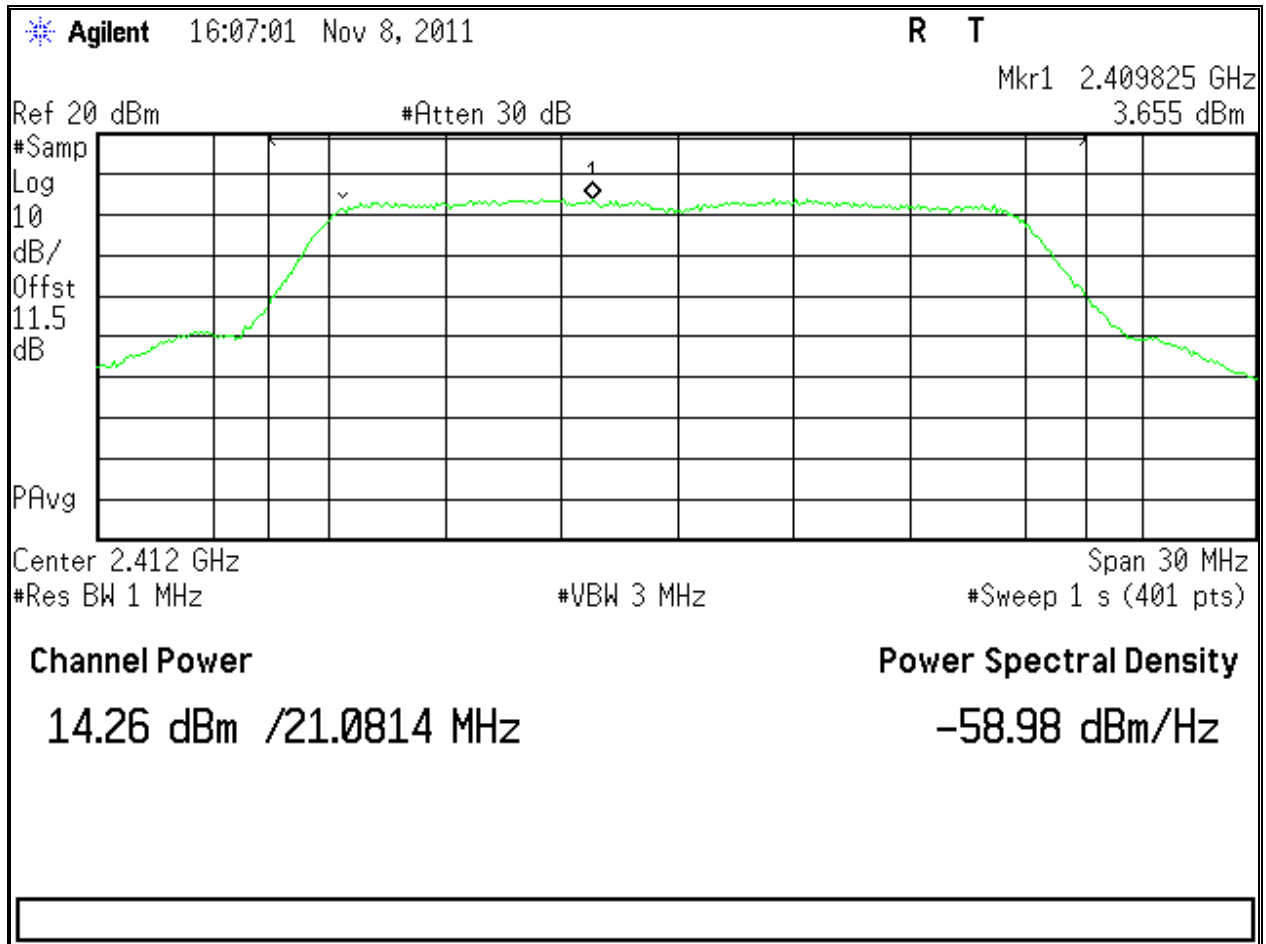

Figure 13: Maximum Transmitted Power, 2412 MHz at HT20 2x2 ch1 13Mbps

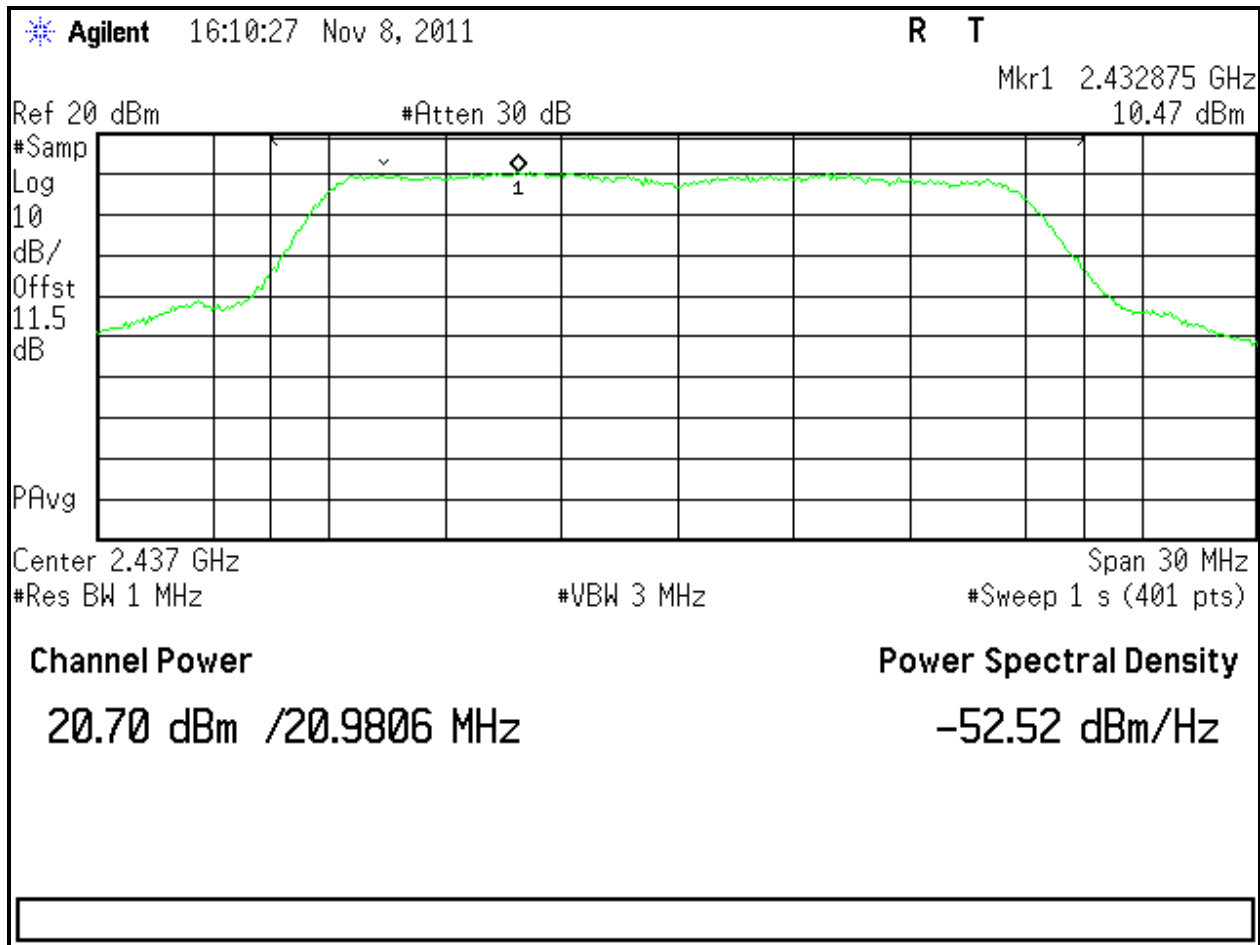

Figure 14: Maximum Transmitted Power, 2437 MHz at HT20 2x2 ch1 13Mbps

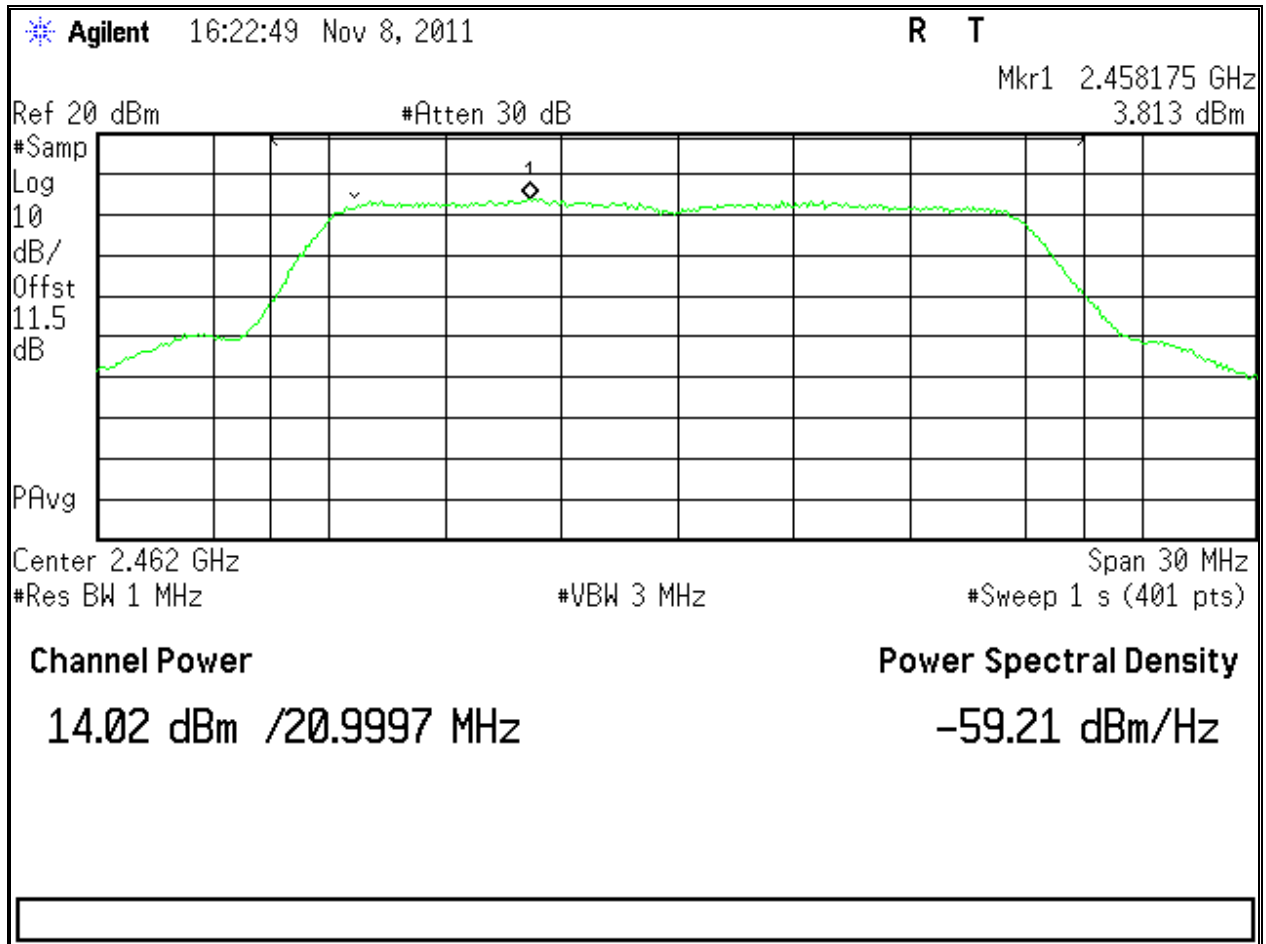

Figure 15: Maximum Transmitted Power, 2462 MHz at HT20 2x2 ch1 13Mbps

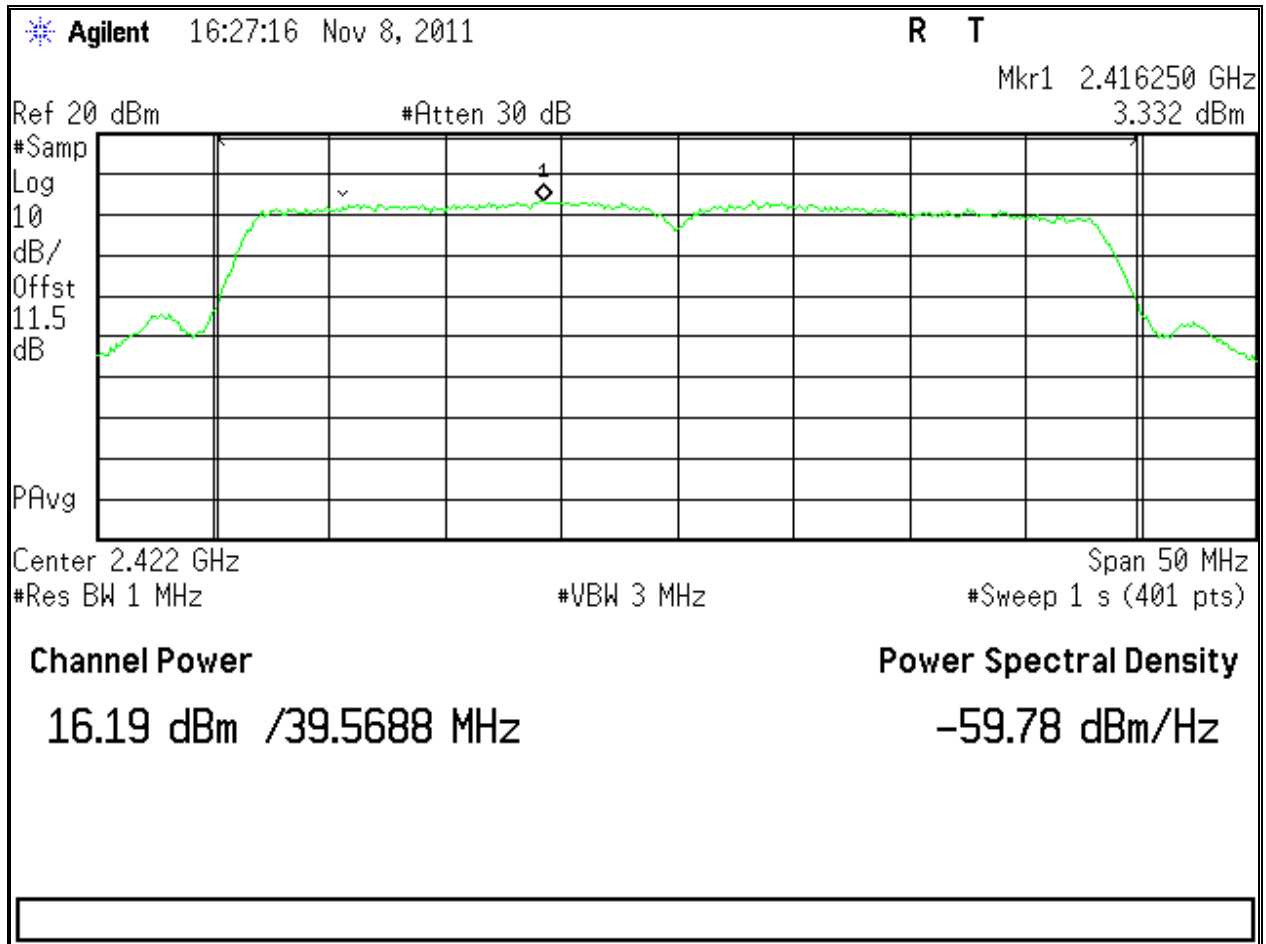

Figure 16: Maximum Transmitted Power, 2422 MHz at HT40 1x2 ch0 13.5Mbps

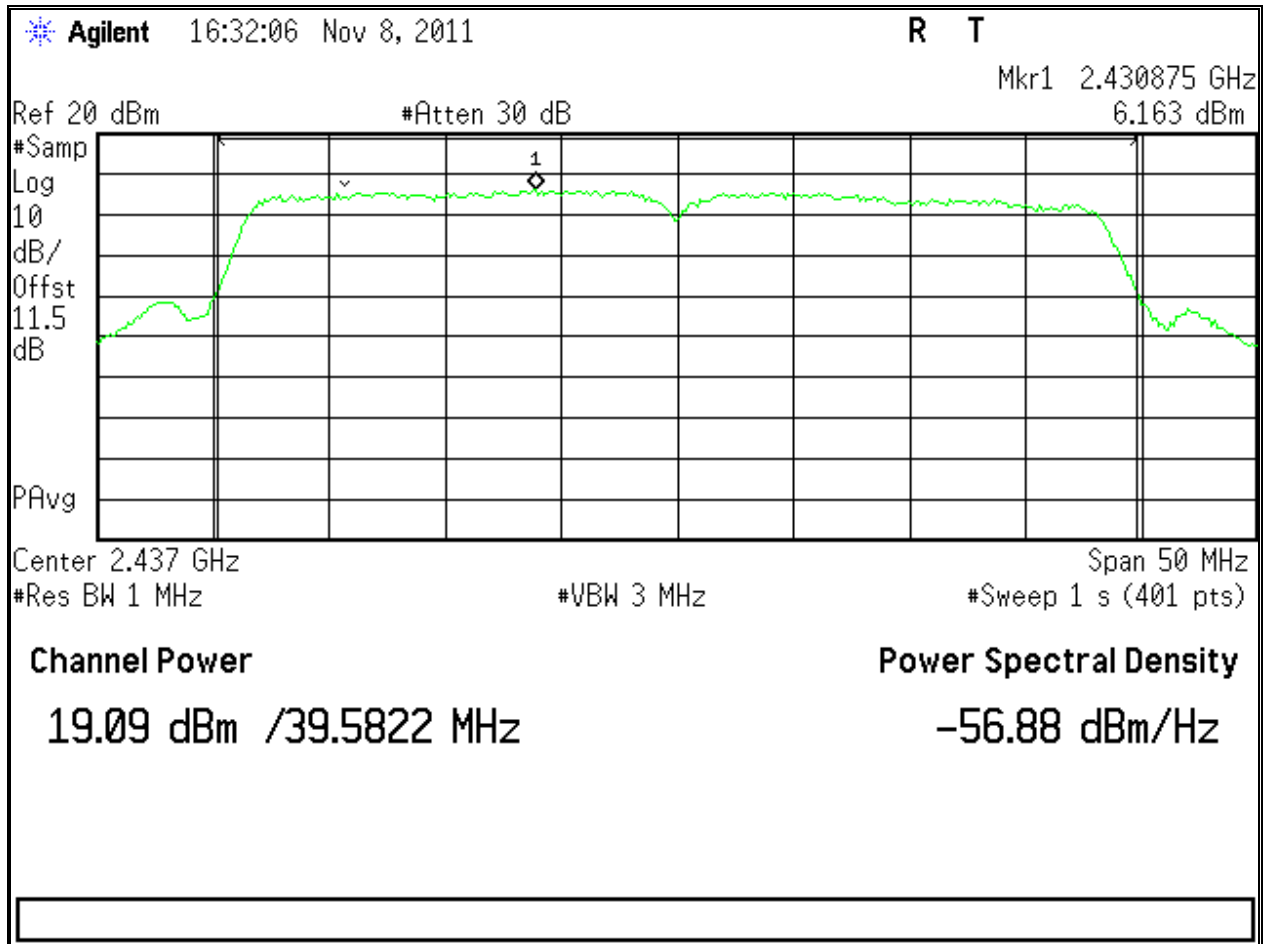

Figure 17: Maximum Transmitted Power, 2437 MHz at HT40 1x2 ch0 13.5Mbps

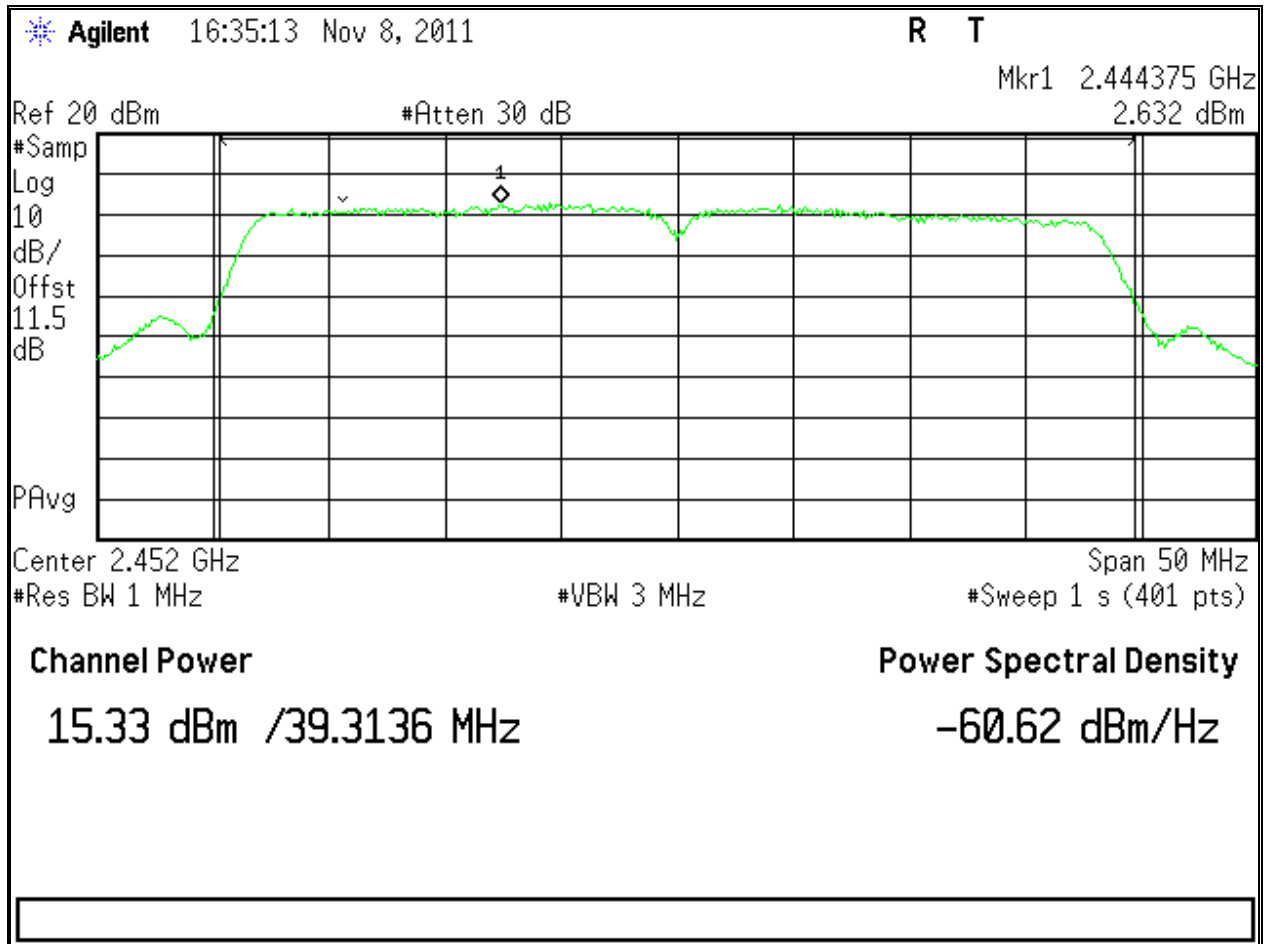

Figure 18: Maximum Transmitted Power, 2452 MHz at HT40 1x2 ch0 13.5Mbps

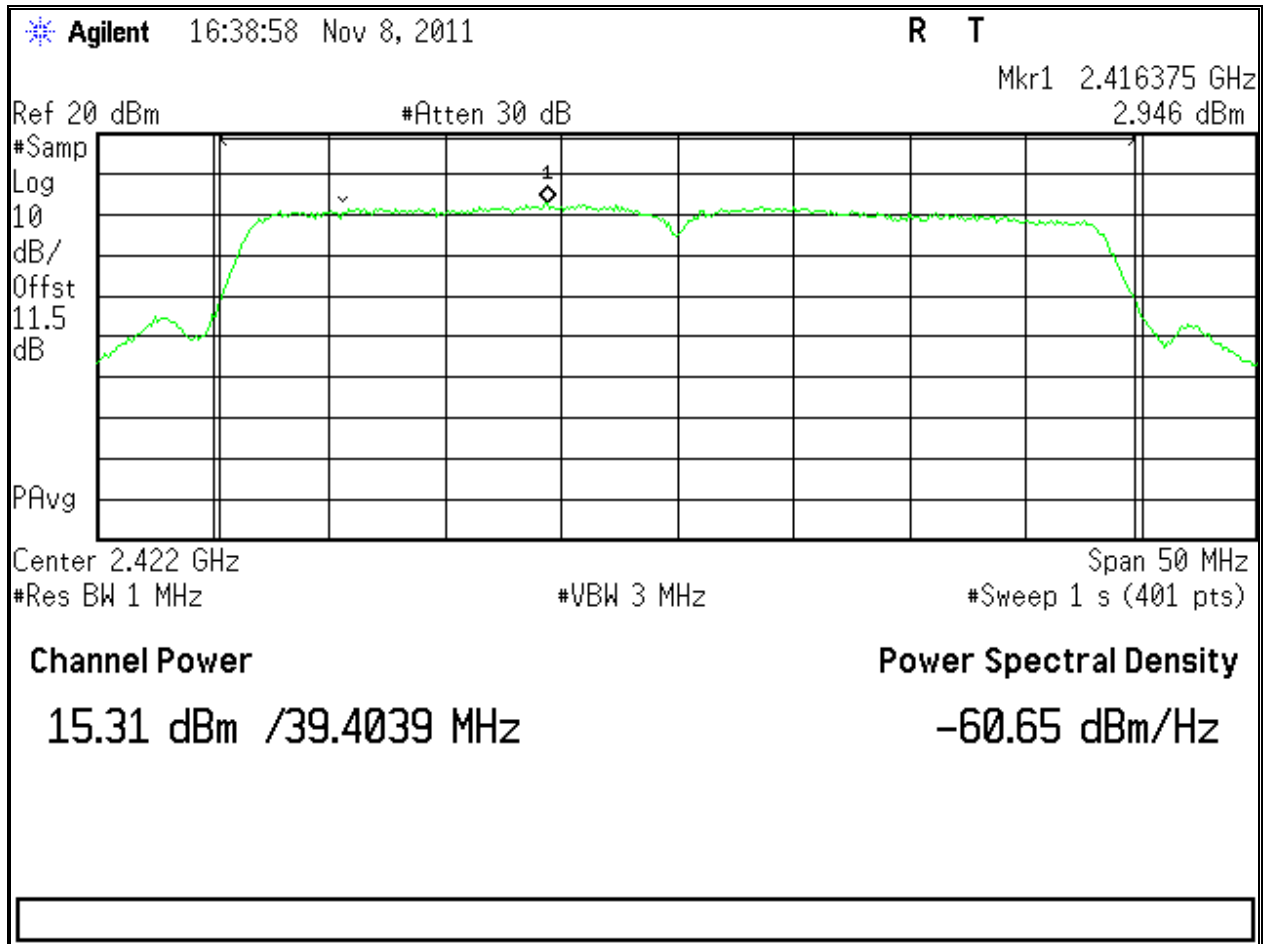

Figure 19: Maximum Transmitted Power, 2422 MHz at HT40 2x2 ch0 27Mbps

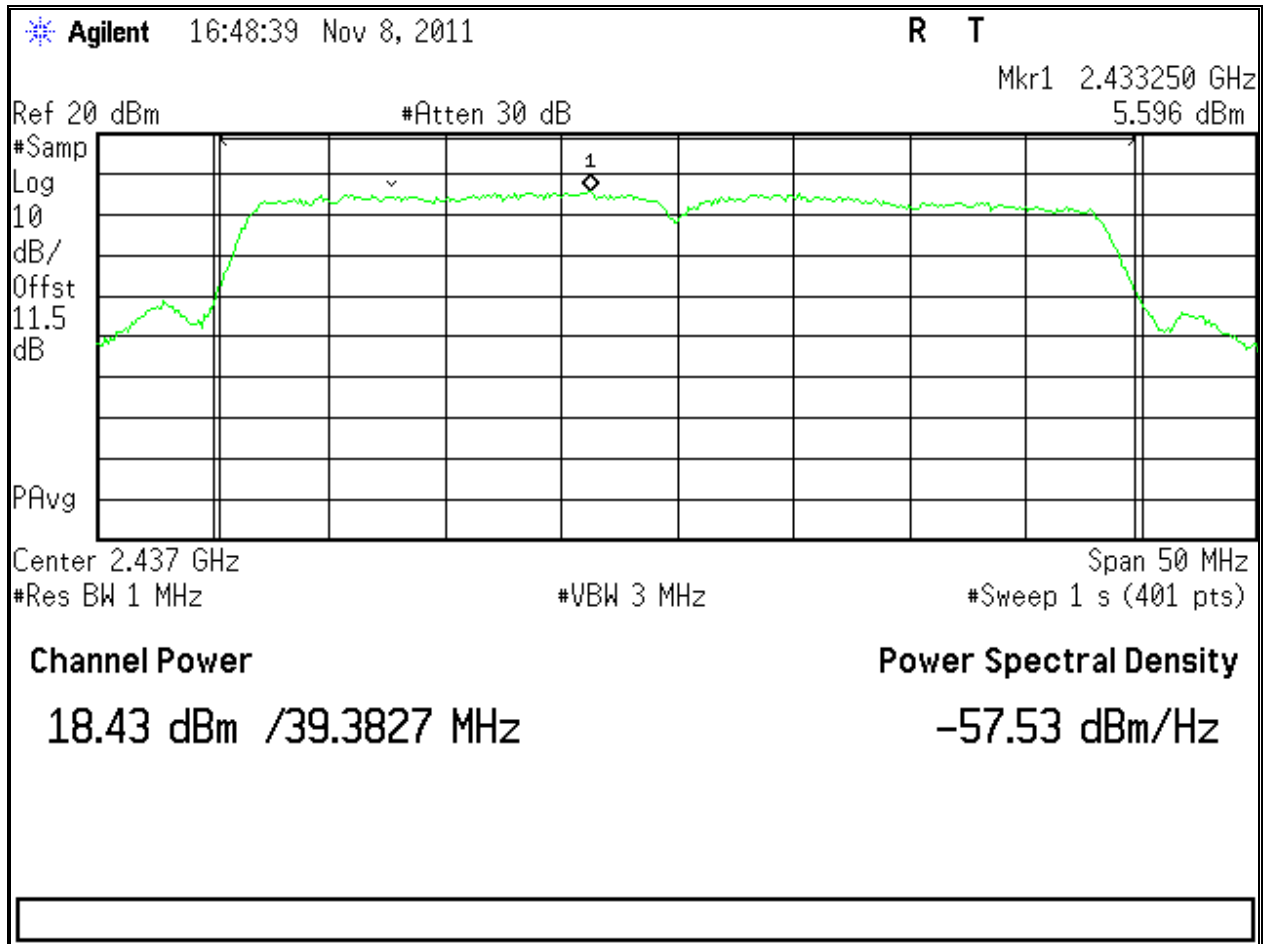

Figure 20: Maximum Transmitted Power, 2437 MHz at HT40 2x2 ch0 27Mbps

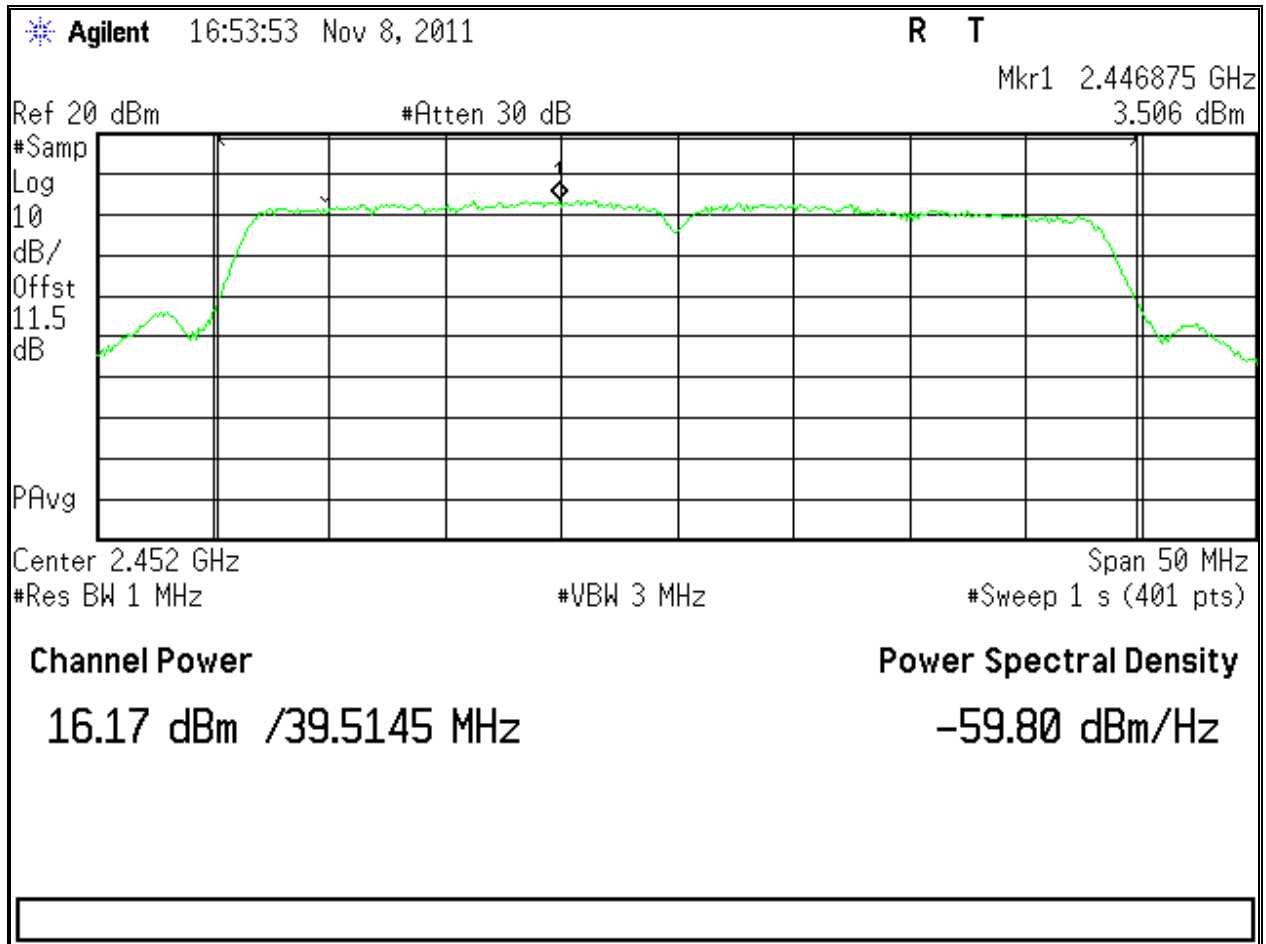

Figure 21: Maximum Transmitted Power, 2452 MHz at HT40 2x2 ch0 27Mbps

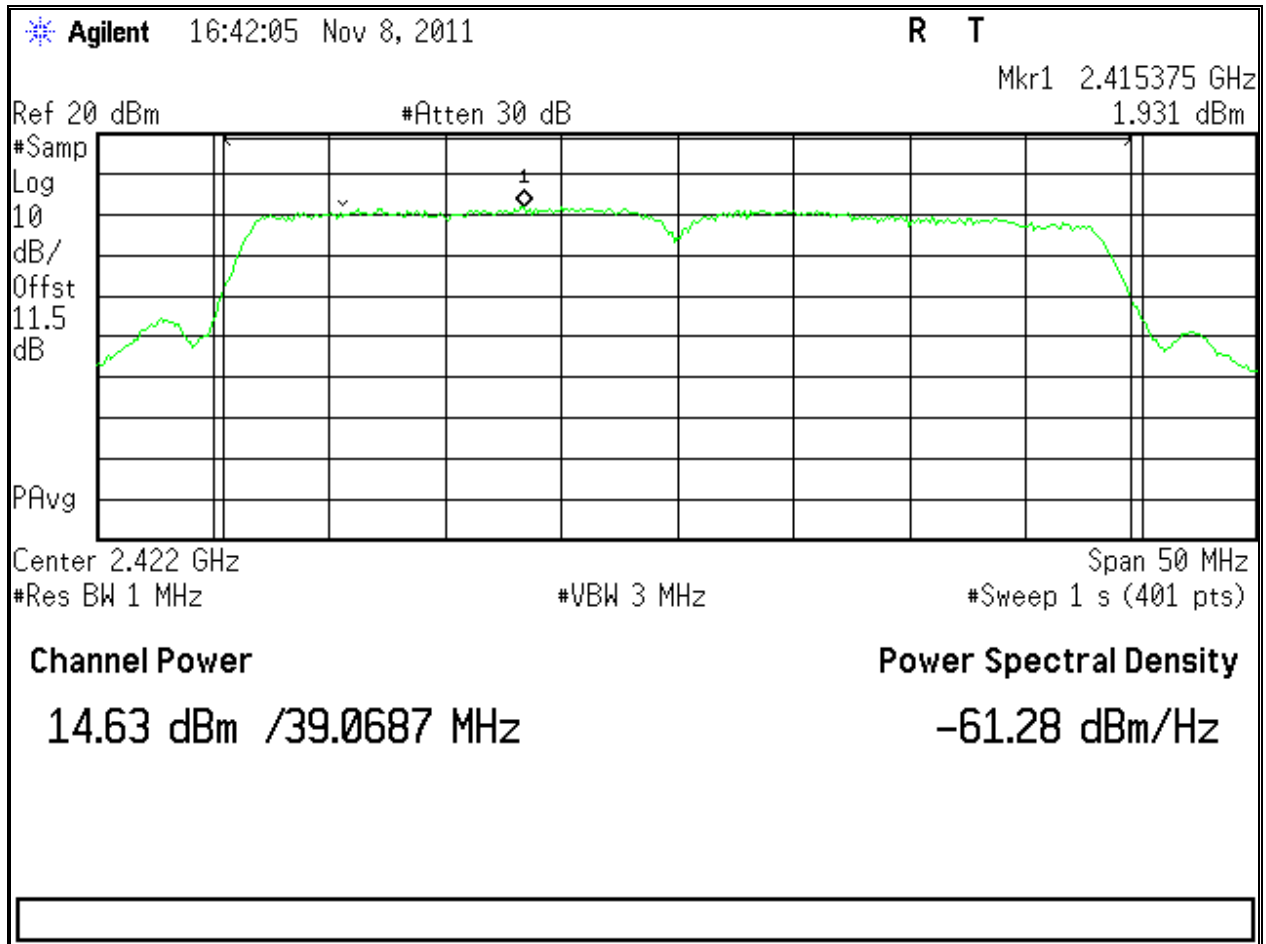

Figure 22: Maximum Transmitted Power, 2422 MHz at HT40 2x2 ch1 27Mbps

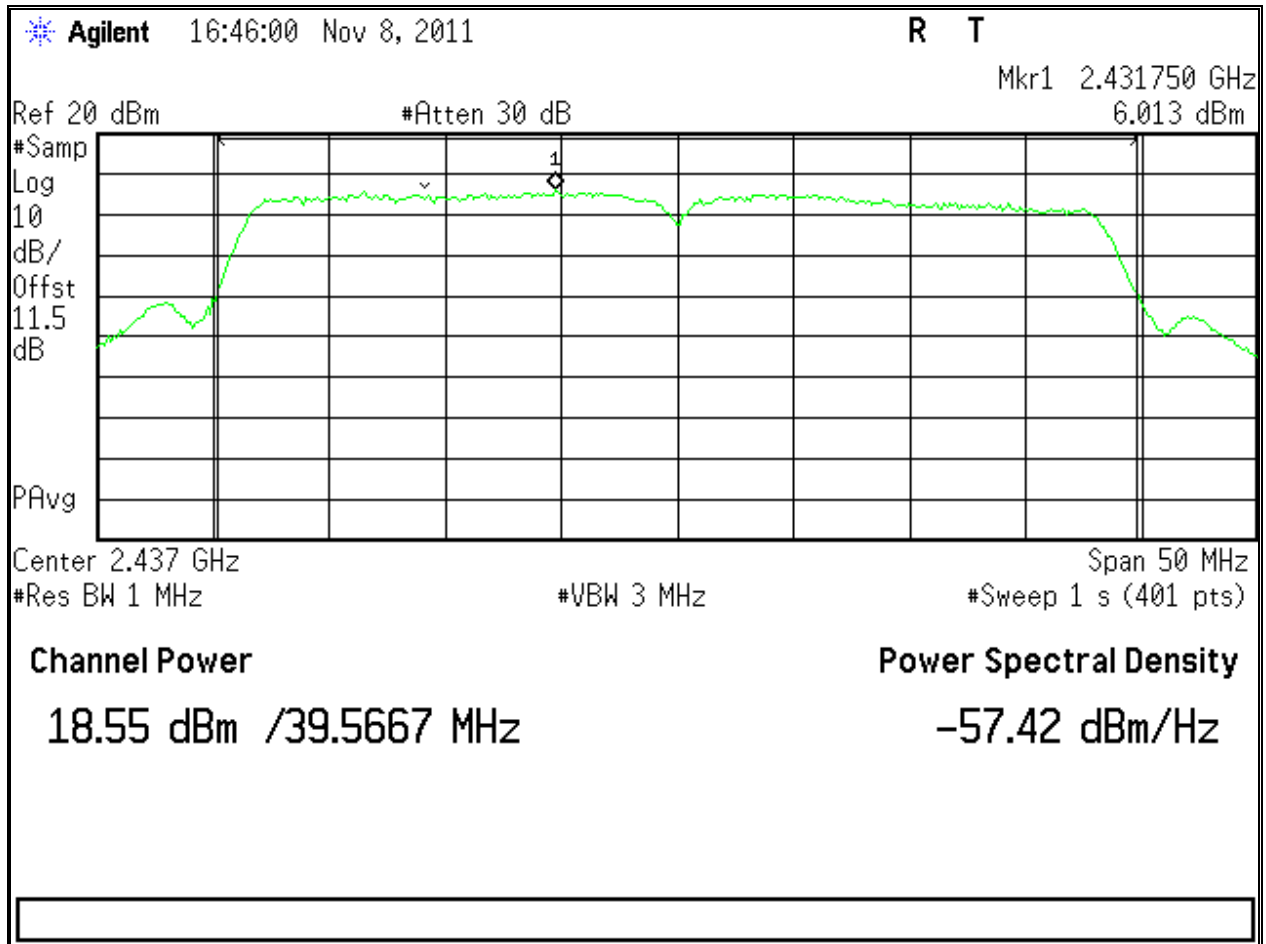

Figure 23: Maximum Transmitted Power, 2437 MHz at HT40 2x2 ch1 27Mbps

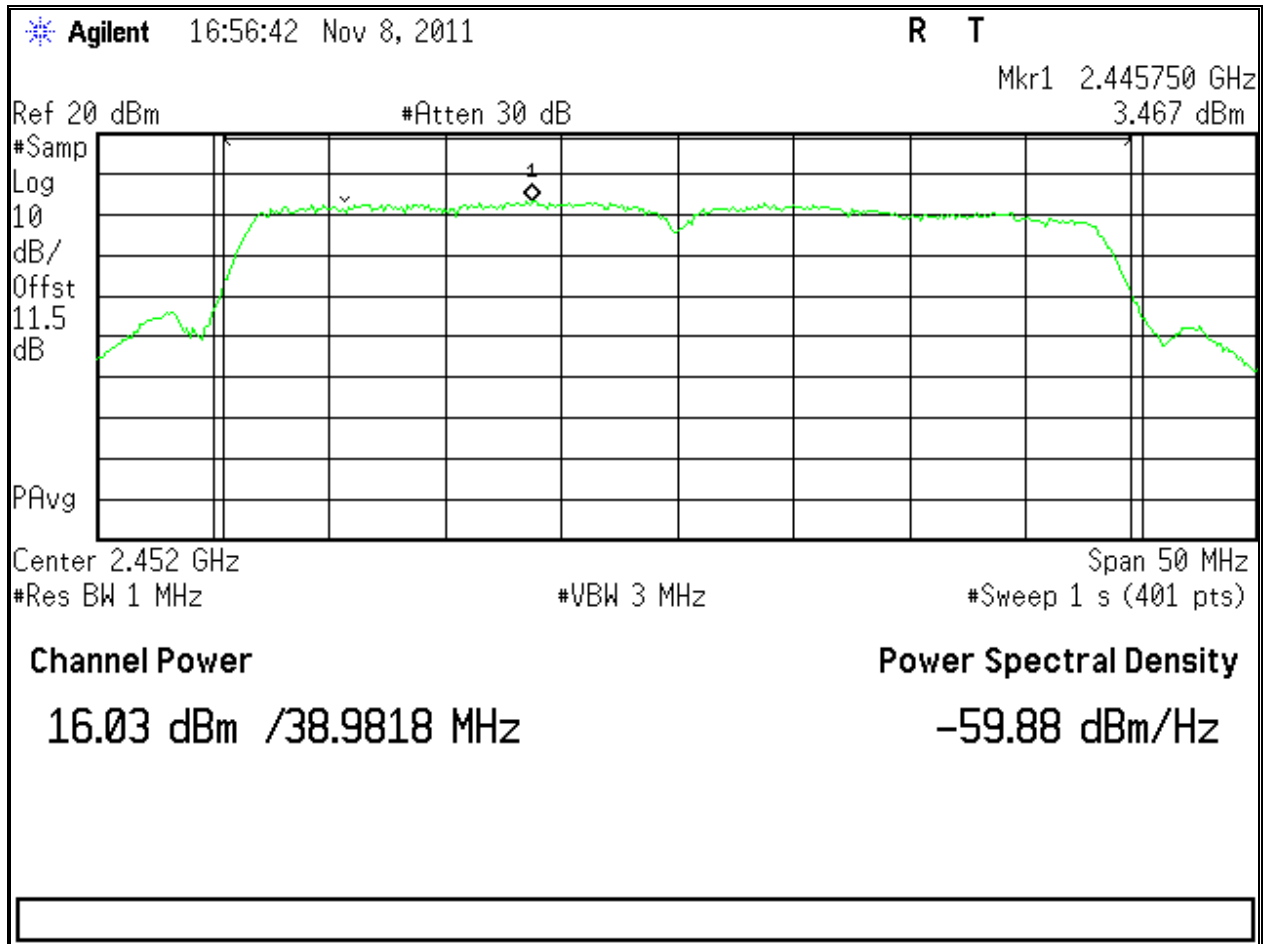

Figure 24: Maximum Transmitted Power, 2452 MHz at HT40 2x2 ch1 27Mbps

4.2 Occupied Bandwidth

The occupied bandwidth is measured at an amplitude level reduced from the reference level by a specified ratio. The reference level is the level of the highest amplitude signal observed from the transmitter at the fundamental frequency.

The 99% bandwidth is the bandwidth in which 99% of the transmitted power occupied.

The 6dB bandwidth is defined the bandwidth of 6dBr from highest transmitted level of the fundamental frequency.

The bandwidth shall be at least 500 kHz per Section CFR47 15.247(a2) 2010 and RSS Gen Sect. 4.4.1: 2010.

4.2.1 Test Method

The conducted method was used to measure the occupied bandwidth according to ANSI C63.10:2009 Section 6.9.1. The measurement was performed with modulation per CFR47 15.247(a2) 2010 and RSS Gen Sect. 4.4.1:2010. This test was conducted on 3 channels of Sample SN 31104000521. The worst sample result indicated below.

Test Setup:

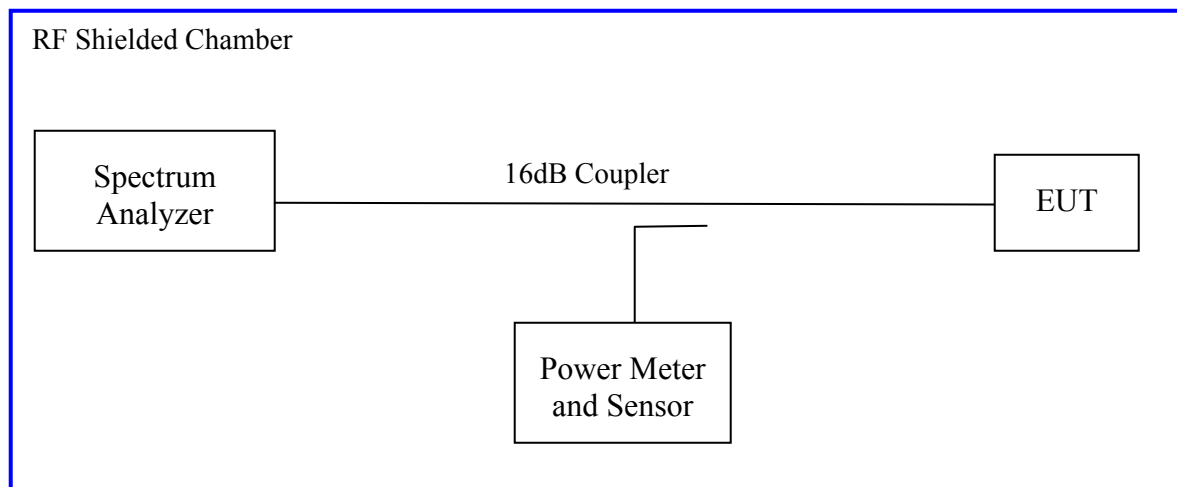

4.2.2 Results

As originally tested, the EUT was found to be compliant to the requirements of the test standard(s).

Table 5: Occupied Bandwidth – Test Results

Test Conditions: Conducted Measurement, Normal Temperature and Voltage only				
Antenna Type: Integrated		Power Setting: See test plan		
Max. Antenna Gain: +3.0 dBi		Signal State: Modulated		
Ambient Temp.: 22 °C		Relative Humidity: 41%		
Bandwidth (MHz) for 802.11b				
Frequency (MHz)	Limit (kHz)	Ch 0 99% BW	Ch 0 6 dB BW	Results
2412	500	10.391	8.236	Pass
2437	500	10.426	8.240	Pass
2462	500	10.393	8.246	Pass
Note: The bandwidth was measured at 1Mbps for 802.11b mode.				
Bandwidth (MHz) for 802.11g				
Frequency (MHz)	Limit (kHz)	Ch 0 99% BW	Ch 0 6 dB BW	Results
2412	500	17.092	16.508	Pass
2437	500	17.097	16.546	Pass
2462	500	17.115	16.492	Pass
Note: The bandwidth was measured at 6Mbps for 802.11g mode.				
Bandwidth (MHz) for 802.11n HT20				
Frequency (MHz)	Limit (kHz)	Ch 0 99% BW	Ch 0 6 dB BW	Results
2412	500	17.995	17.713	Pass
2437	500	18.066	17.743	Pass
2462	500	17.996	17.760	Pass
Note: The bandwidth was measured at 6.5Mbps at 1 data stream				

Bandwidth (MHz) for 802.11n HT40				
Frequency (MHz)	Limit (kHz)	Ch 0 99% BW	Ch 0 6 dB BW	Results
2422	500	36.466	35.828	Pass
2437	500	36.505	36.093	Pass
2452	500	36.529	35.992	Pass

Note: The bandwidth was observed at 13.5Mbps at 1 data stream

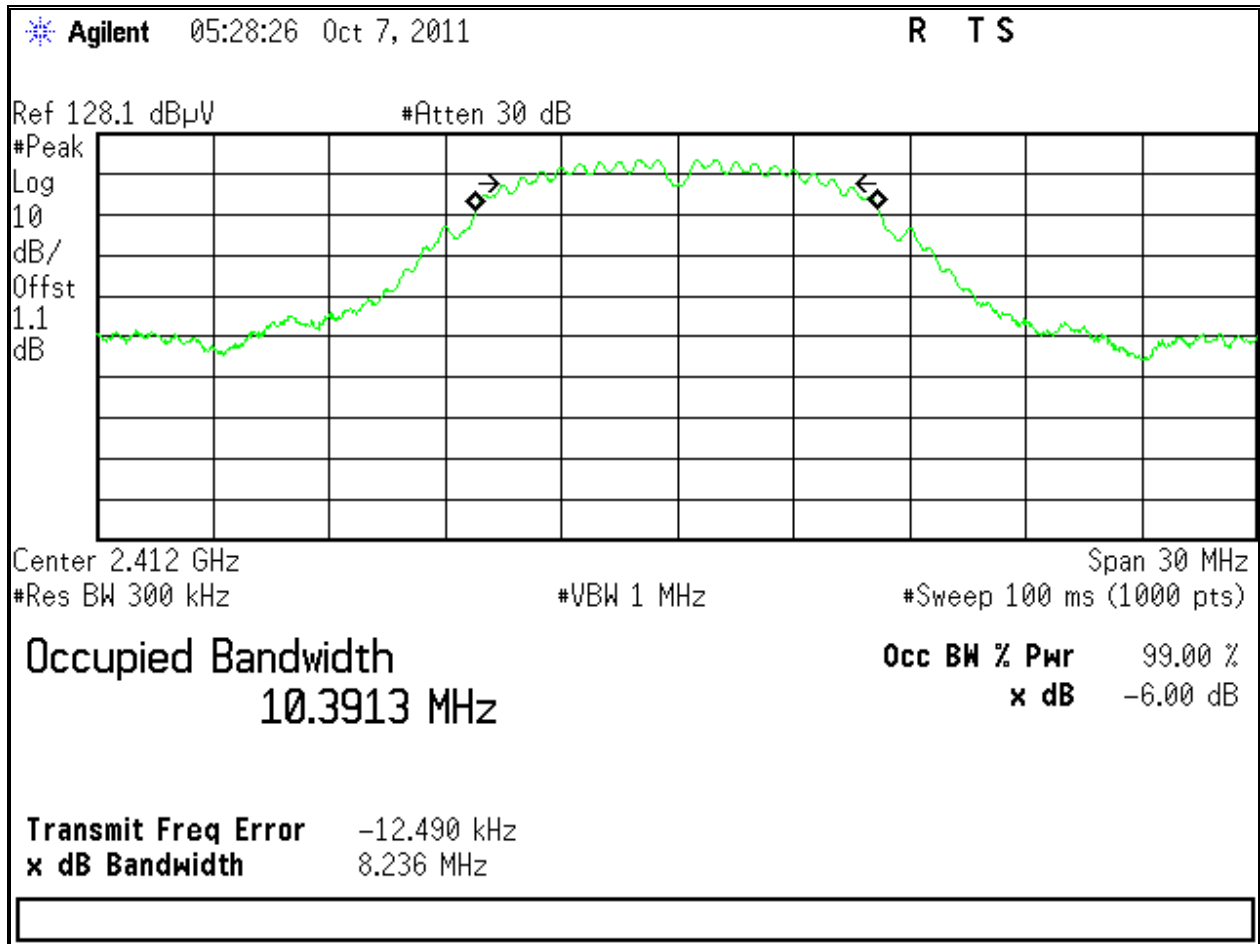

Figure 25: Occupied Bandwidth, 2412MHz at 802.11b, 1x2 ch0, 1Mbps

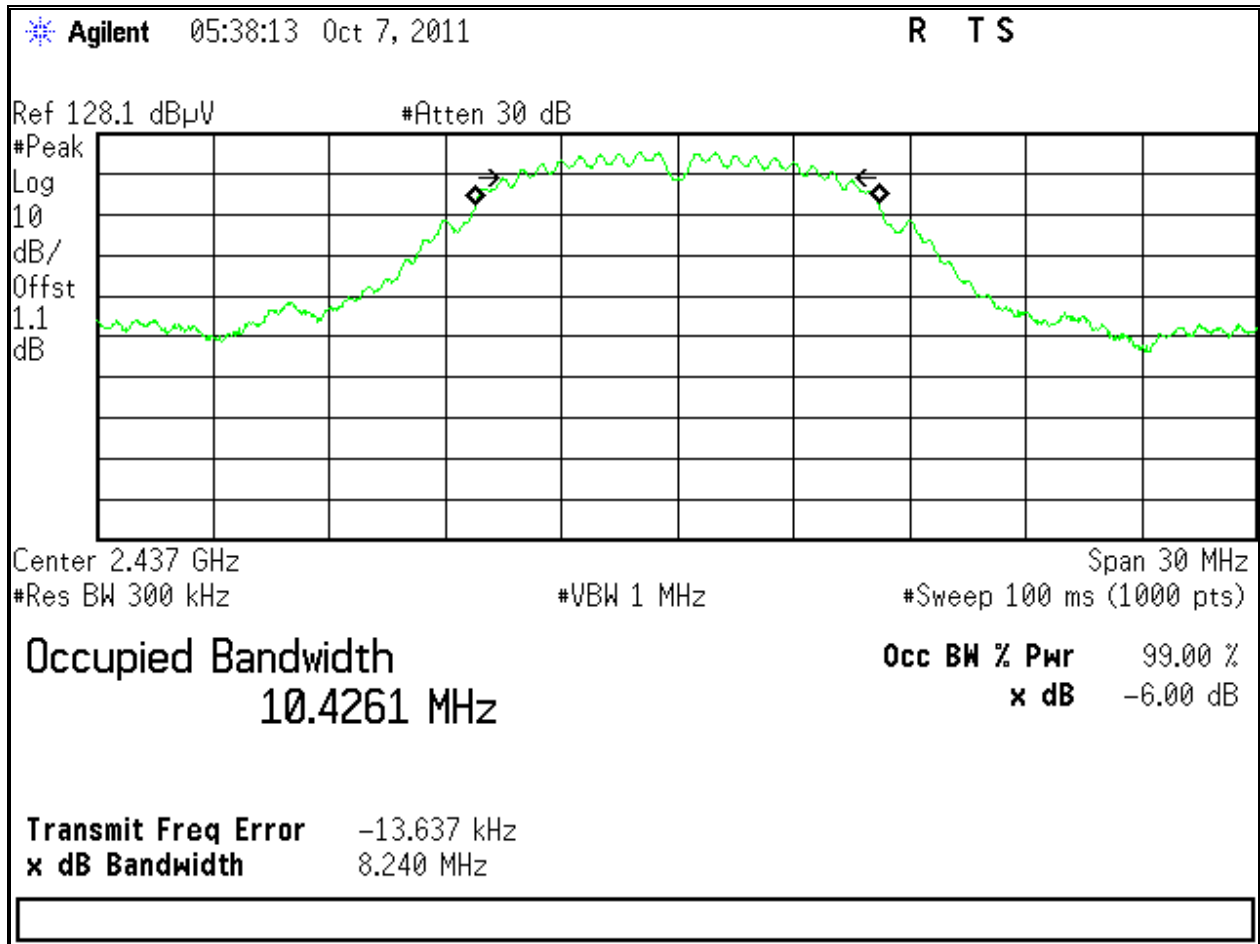

Figure 26: Occupied Bandwidth, 2437MHz at 802.11b, 1x2 ch0, 1Mbps

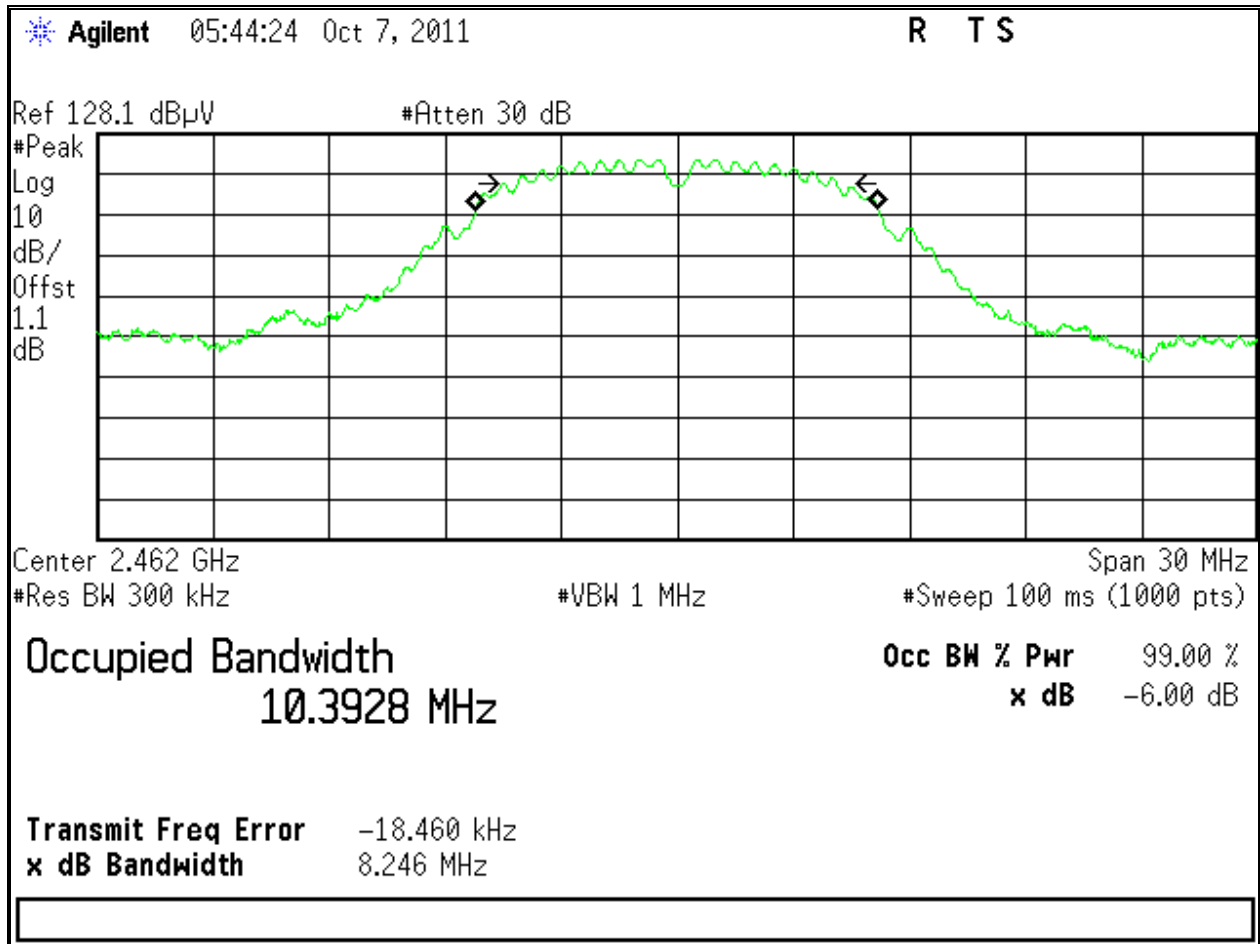

Figure 27: Occupied Bandwidth, 2462MHz at 802.11b, 1x2 ch0, 1Mbps

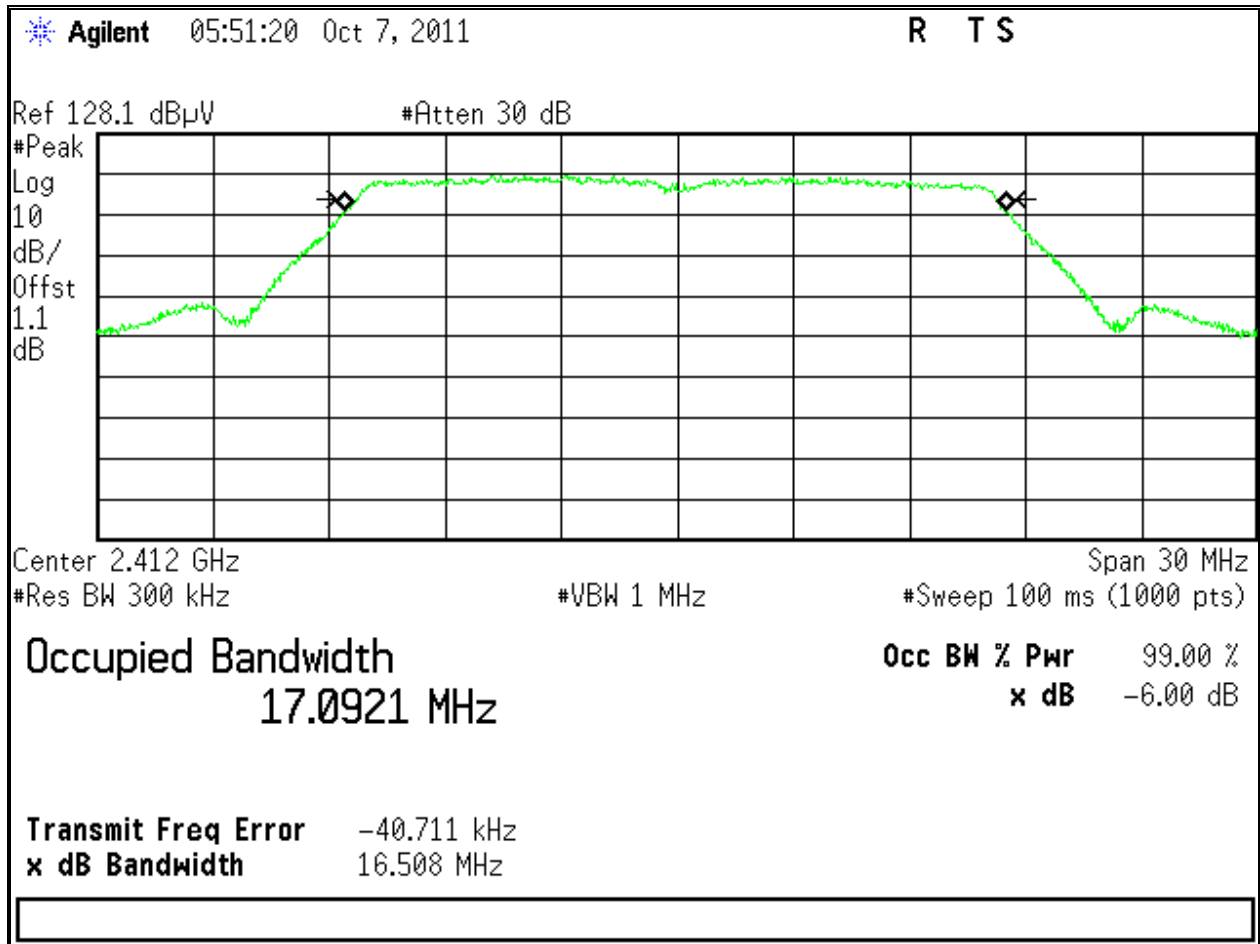

Figure 28: Occupied Bandwidth, 2412MHz at 802.11g, 1x2 ch0, 6Mbps

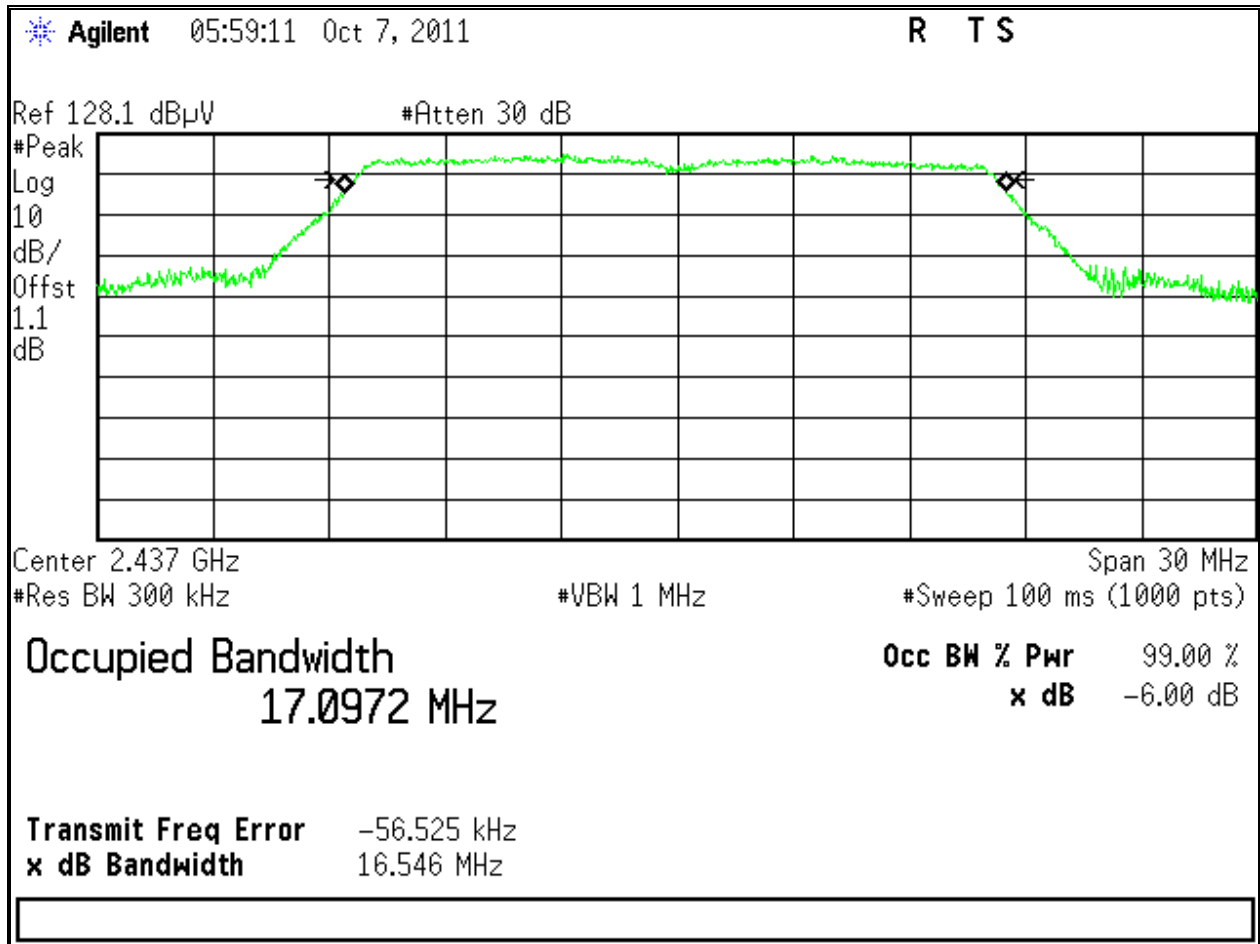

Figure 29: Occupied Bandwidth, 2437MHz at 802.11g, 1x2 ch0, 6Mbps

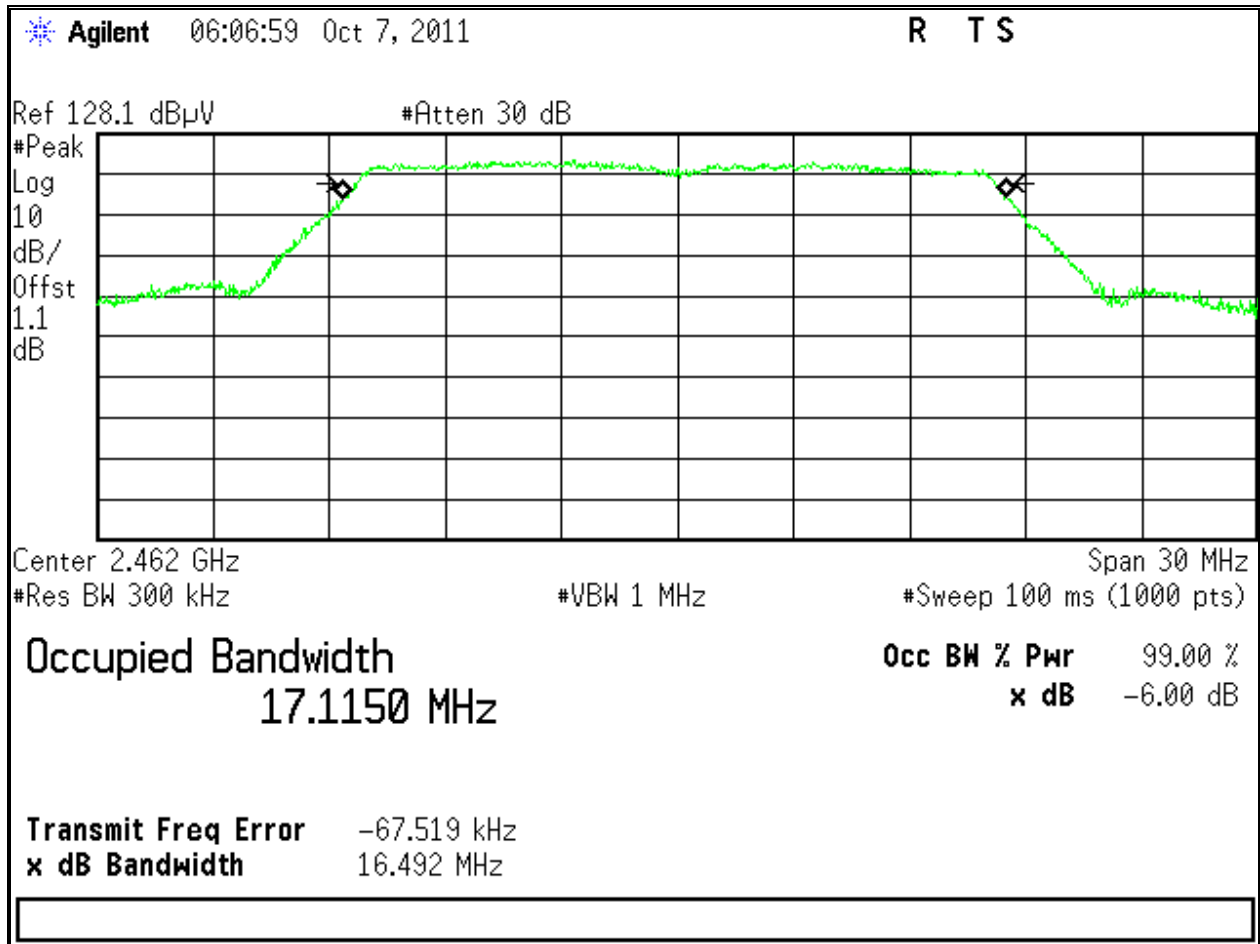

Figure 30: Occupied Bandwidth, 2462MHz at 802.11g, 1x2 ch0, 6Mbps

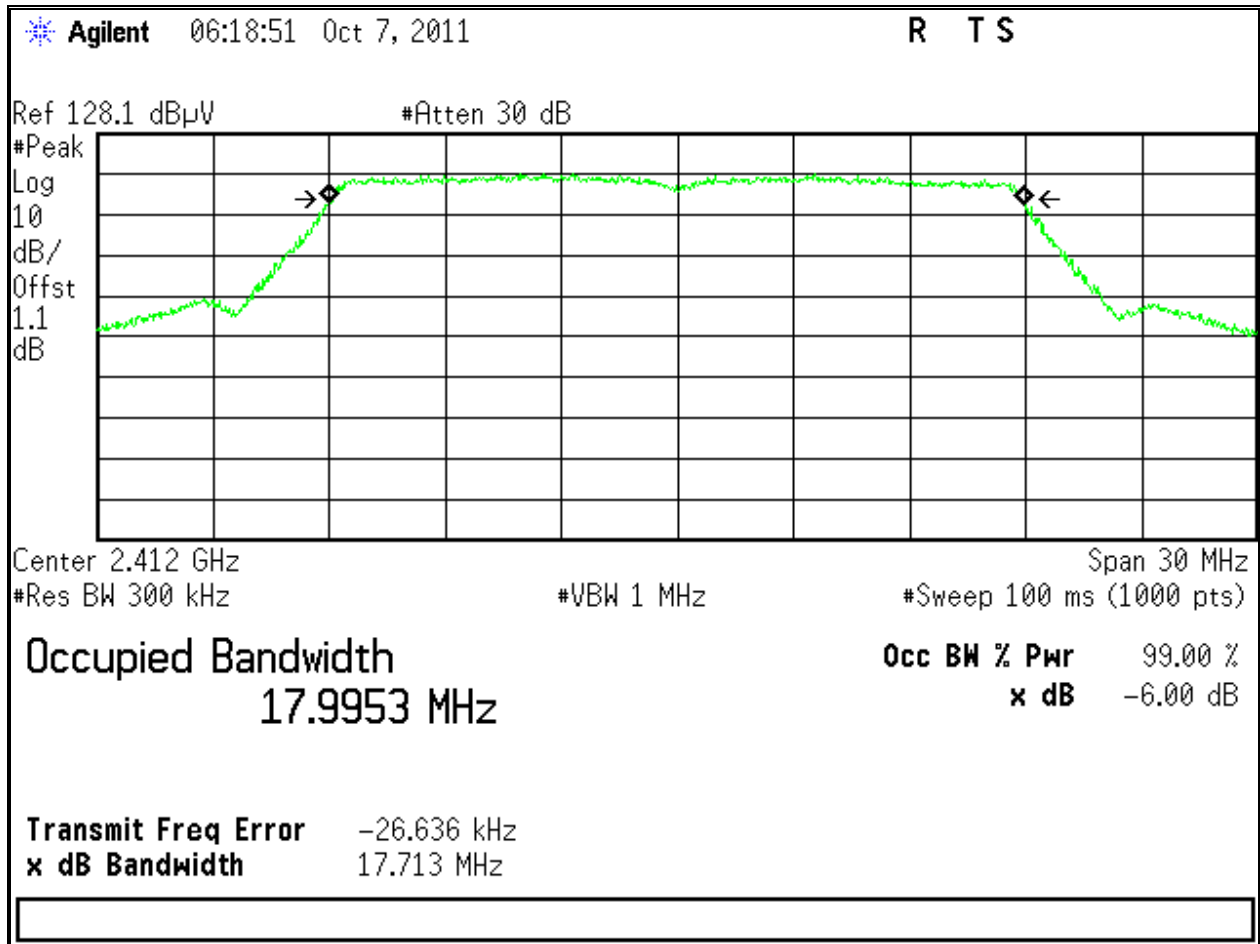

Figure 31: Occupied Bandwidth, 2412MHz at HT20, 1x2 ch0, 6.5Mbps

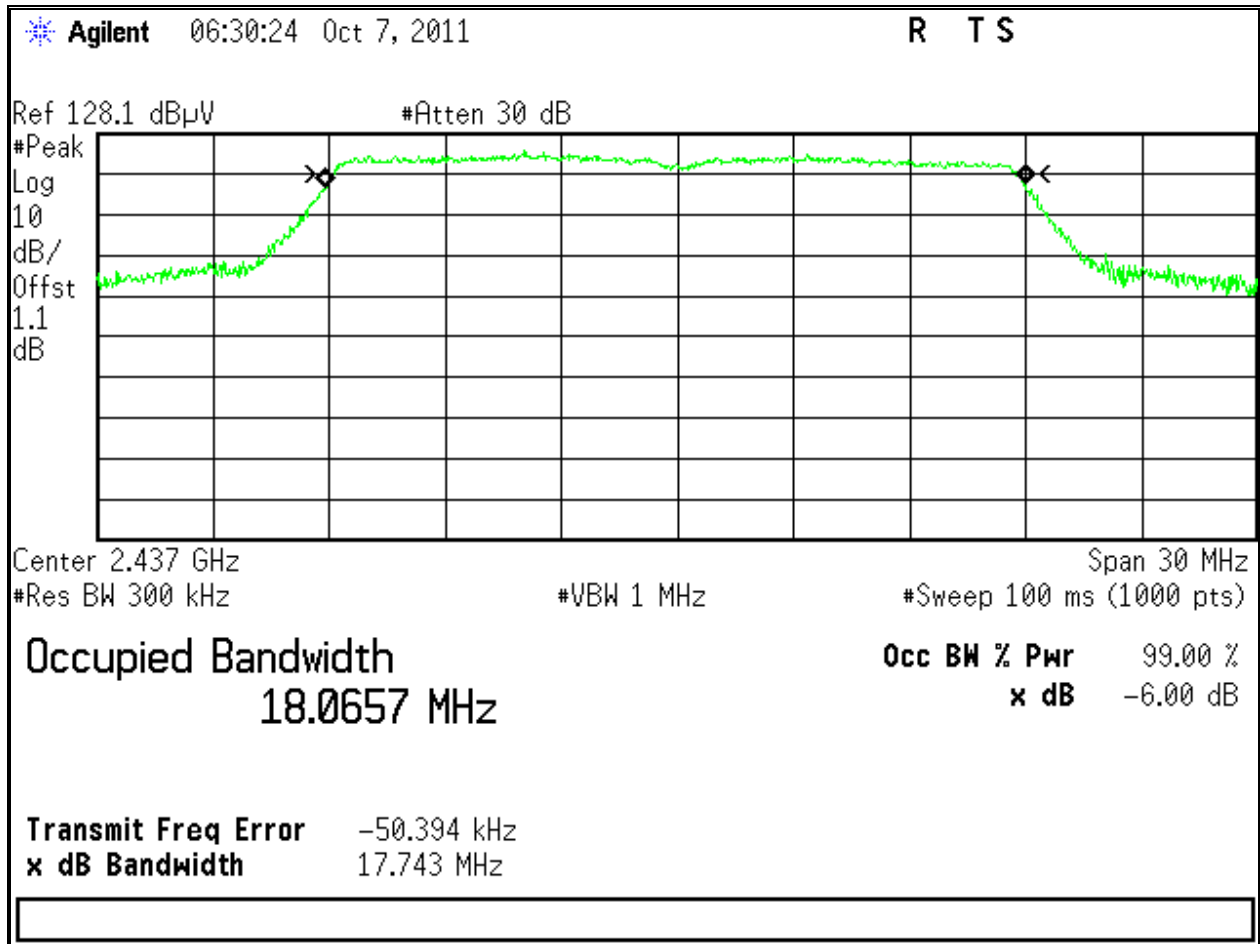

Figure 32: Occupied Bandwidth, 2437MHz at HT20, 1x2 ch0, 6.5Mbps

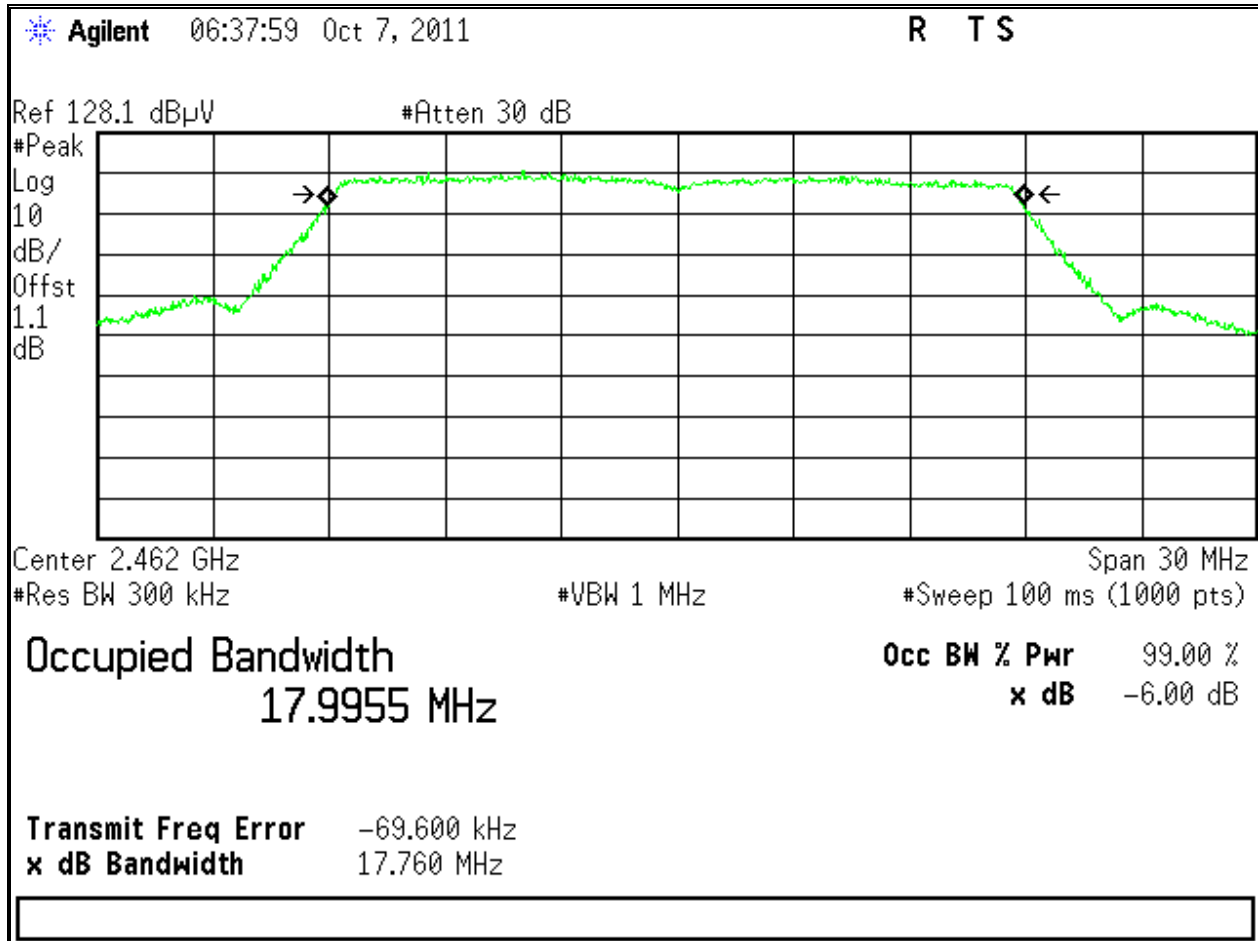

Figure 33: Occupied Bandwidth, 2462MHz at HT20, 1x2 ch0, 6.5Mbps

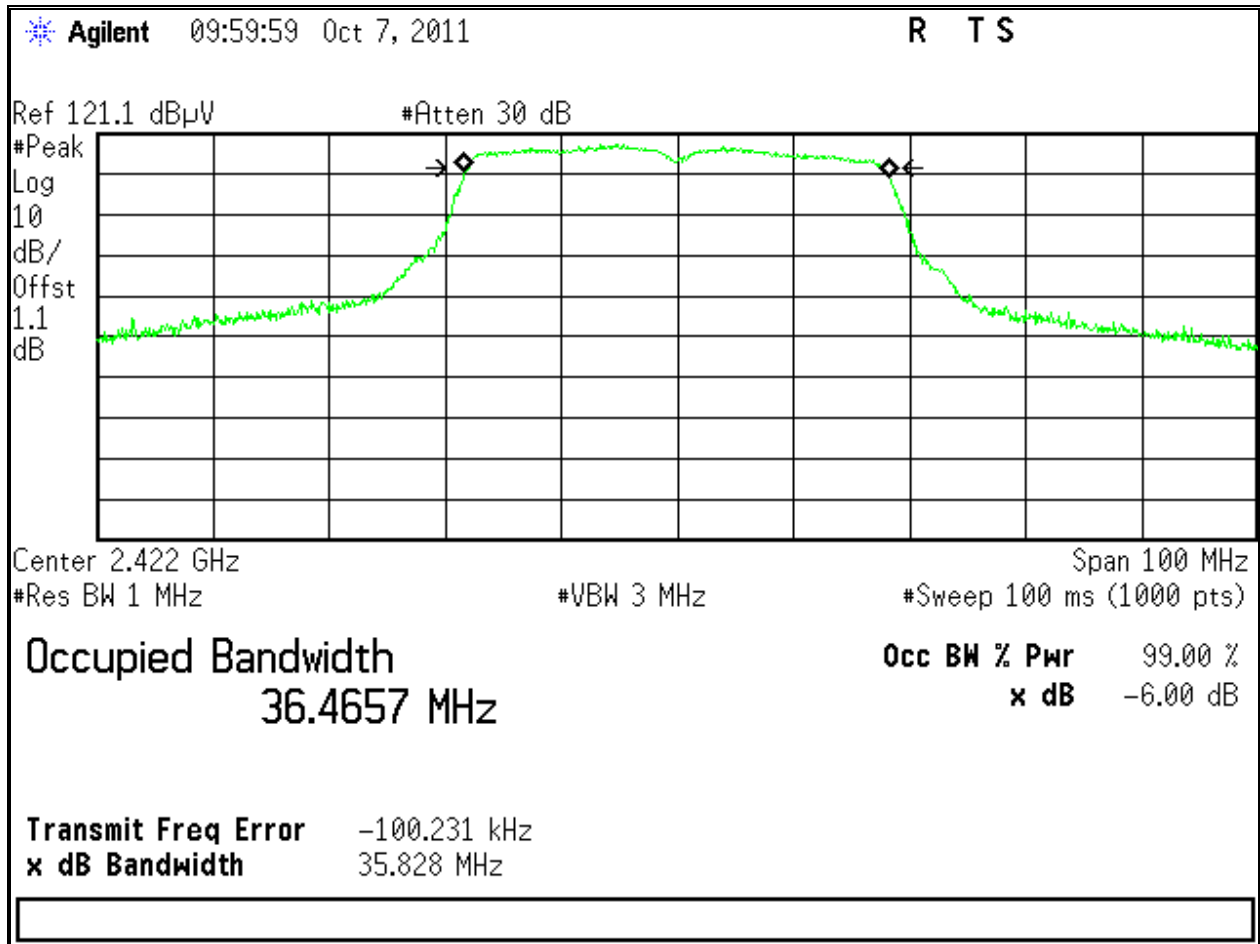

Figure 34: Occupied Bandwidth, 2422MHz at HT40, 1x2 ch0, 13.5Mbps

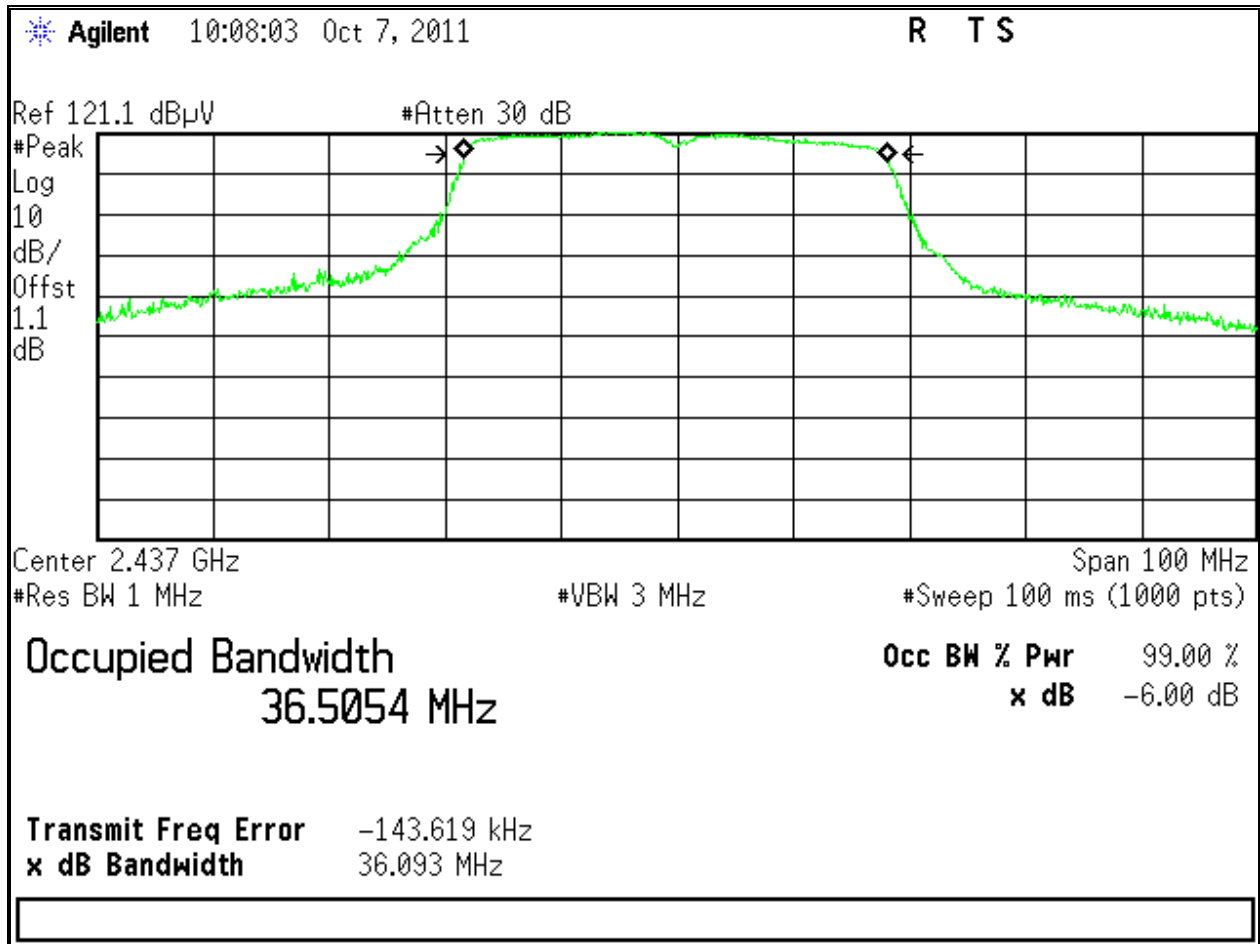

Figure 35: Occupied Bandwidth, 2437MHz at HT40, 1x2 ch0, 13.5Mbps

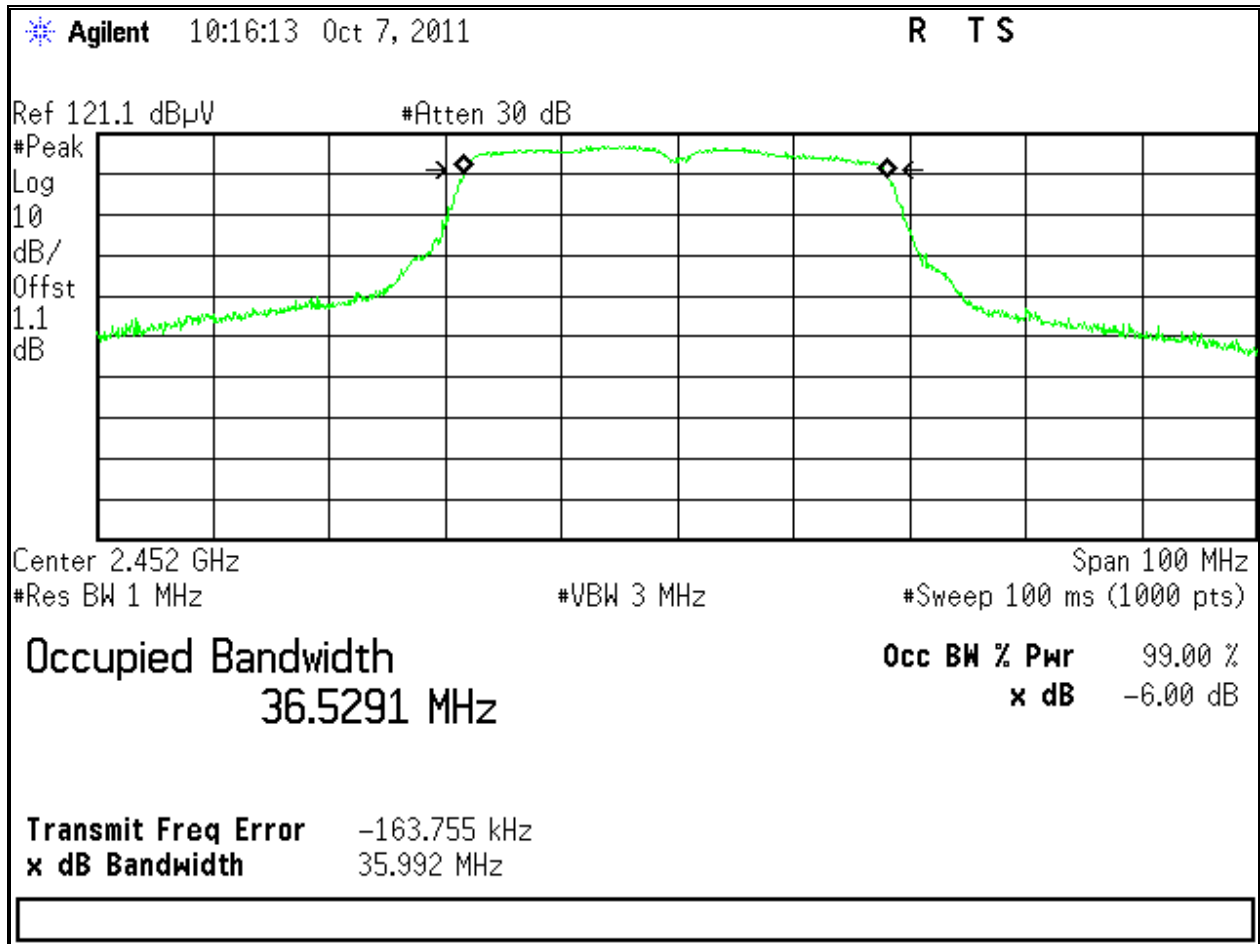

Figure 36: Occupied Bandwidth, 2452MHz at HT40, 1x2 ch0, 13.5Mbps

4.3 Out-of-Band Emissions

The setup was identical to RF output power measurement. Intentional radiators operating under the alternative provisions to the general emission limits, must be designed to ensure that the 20 dB or 30 dB bandwidth of the emission, or whatever bandwidth may otherwise be specified in the specific rule section under which the equipment operates, is contained within the frequency band designated in the rule section under which the equipment is operated. The requirement to contain the designated bandwidth of the emission within the specified frequency band includes the effects from frequency sweeping, frequency hopping and other modulation techniques that may be employed as well as the frequency stability of the transmitter over expected variations in temperature and supply voltage. If the frequency stability is not specified in the regulations, it is recommended that the fundamental emission be kept within at least the central 80% of the permitted band in order to minimize the possibility of out-of-band operation.

Since the transmitter complies with the conducted power limits base on the use of RMS averaging per CFR47 Part 15.247(b)(3), any frequency outside the band of 2400MHz to 2483.5MHz, the power output level must be below 30db from the in-band transmitting signal; CFR 47 Part 15.215, 15.247(d) and RSS 210 A8.5

4.3.1 Test Method

The conducted method was used to measure the out-of-band emission requirement. The measurement was performed with modulation per CFR47 15.247(4)(d) 2010 and RSS 210 A8.5: 2010. This test was conducted on 3 channels of Sample SN 31104000521. The worst sample result indicated below.

Test Setup:

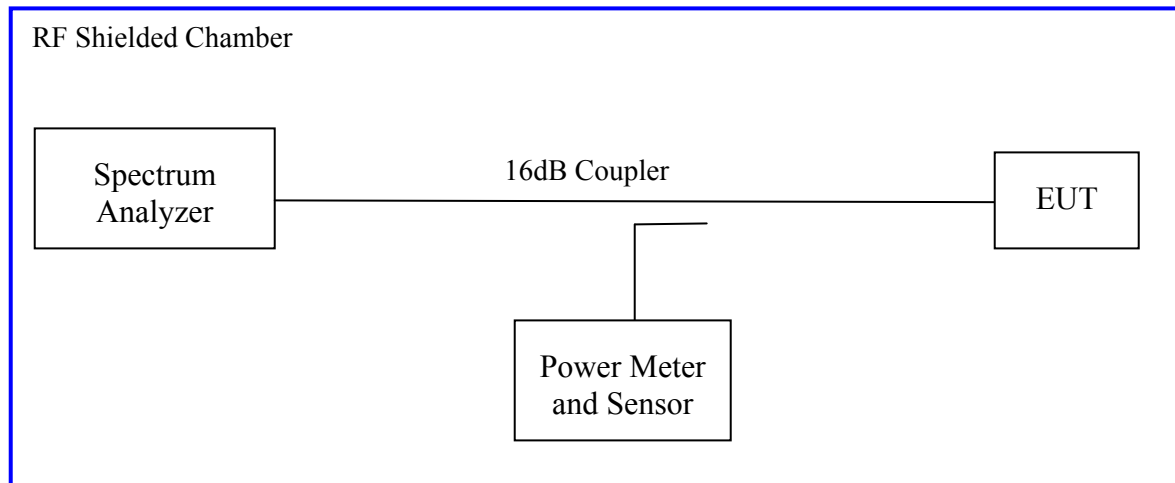

4.3.2 Test Result

As originally tested, the EUT was found to be compliant to the requirements of the test standard(s).

Table 6: Emissions at the Band-Edge – Test Results

Test Conditions: Conducted Measurement, Normal Temperature and Voltage only				
Antenna Type: Integrated		Power Setting: See test plan		
Max. Antenna Gain: +3.0 dBi		Signal State: Modulated		
Ambient Temp.: 23 °C		Relative Humidity: 41%		
Band-Edge Results				
Operating Channel	Mode	Band-edge Level (dBm)	20/30 dBr Level (dBm)	Margin (dB)
2412 MHz	1Mbps	-35.24	-16.2	-19.04
2437 MHz	1Mbps	-39.42	-14.1	-25.32
2462 MHz	1Mbps	-40.50	-15.9	-24.6
2412 MHz	6 Mbps	-26.29	-23.3	-2.99
2437 MHz	6 Mbps	-39.53	-18.0	-21.53
2462 MHz	6 Mbps	-34.15	-19.5	-14.65
2412 MHz	6.5 Mbps	-25.74	-22.5	-3.24
2437 MHz	6.5 Mbps	-38.97	-17.4	-21.57
2462 MHz	6.5 Mbps	-38.31	-22.9	-15.41
2422 MHz*	13.5 Mbps	-24.99	-17.3	-7.69
2437 MHz	13.5 Mbps	-36.06	-24.5	-11.56
2452 MHz	13.5 Mbps	-41.53	-28.4	-13.13
<p>Note: The band-edge level must lower than the 20/ 30dBr level. The maximum out of band emission on each individual output put is at least 20/ 30 dB below the maximum in-band PSD on that output. (*) This channel met peak channel power. -20dBr band-edge level was used.</p>				

Table 7: Out of band Conducted Emission – Test Results

Test Conditions: Conducted Measurement, Normal Temperature and Voltage only			
Antenna Type: Integrated		Power Setting: See test plan	
Max. Antenna Gain: +3.0 dBi		Signal State: Modulated	
Ambient Temp.: 22 °C		Relative Humidity: 41%	
Output of Band Results			
Operating Channel	Mode	Band 30MHz- 26GHz	Result
2412 MHz	1Mbps	Figure 38, 39	Pass
2437 MHz	1Mbps	Figure 41, 42	Pass
2462 MHz	1Mbps	Figure 44, 45	Pass
2412 MHz	6 Mbps	Figure 47, 48	Pass
2437 MHz	6 Mbps	Figure 50, 51	Pass
2462 MHz	6 Mbps	Figure 53, 54	Pass
2412 MHz	6.5 Mbps	Figure 56, 57	Pass
2437 MHz	6.5 Mbps	Figure 59, 60	Pass
2462 MHz	6.5 Mbps	Figure 62, 63	Pass
2422 MHz	13.5 Mbps	Figure 65, 66	Pass
2437 MHz	13.5 Mbps	Figure 68, 69	Pass
2452 MHz	13.5 Mbps	Figure 71, 72	Pass

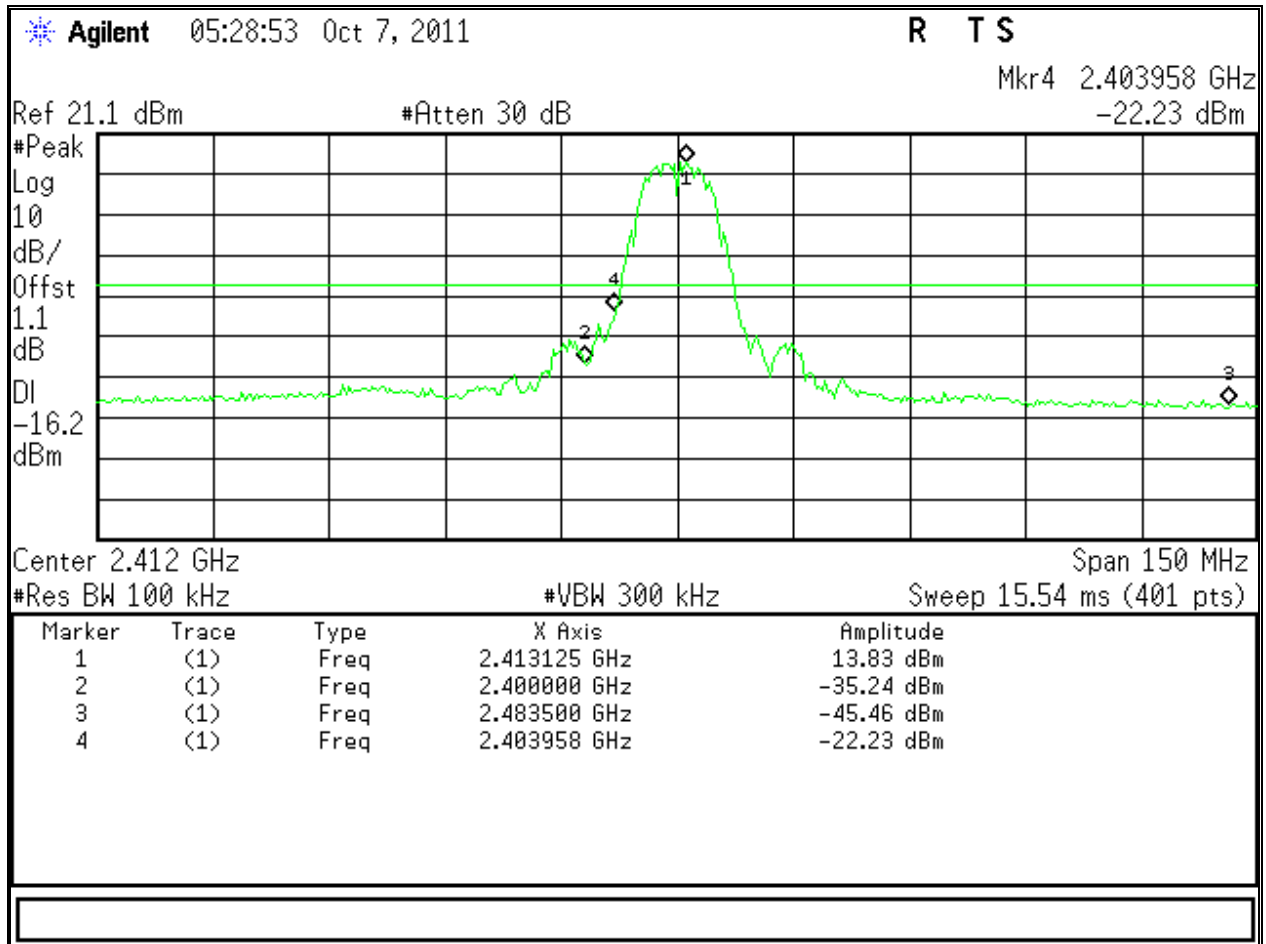

Figure 37: Band-edge Requirement at Operating Channel 2412 MHz, 1MBit/s

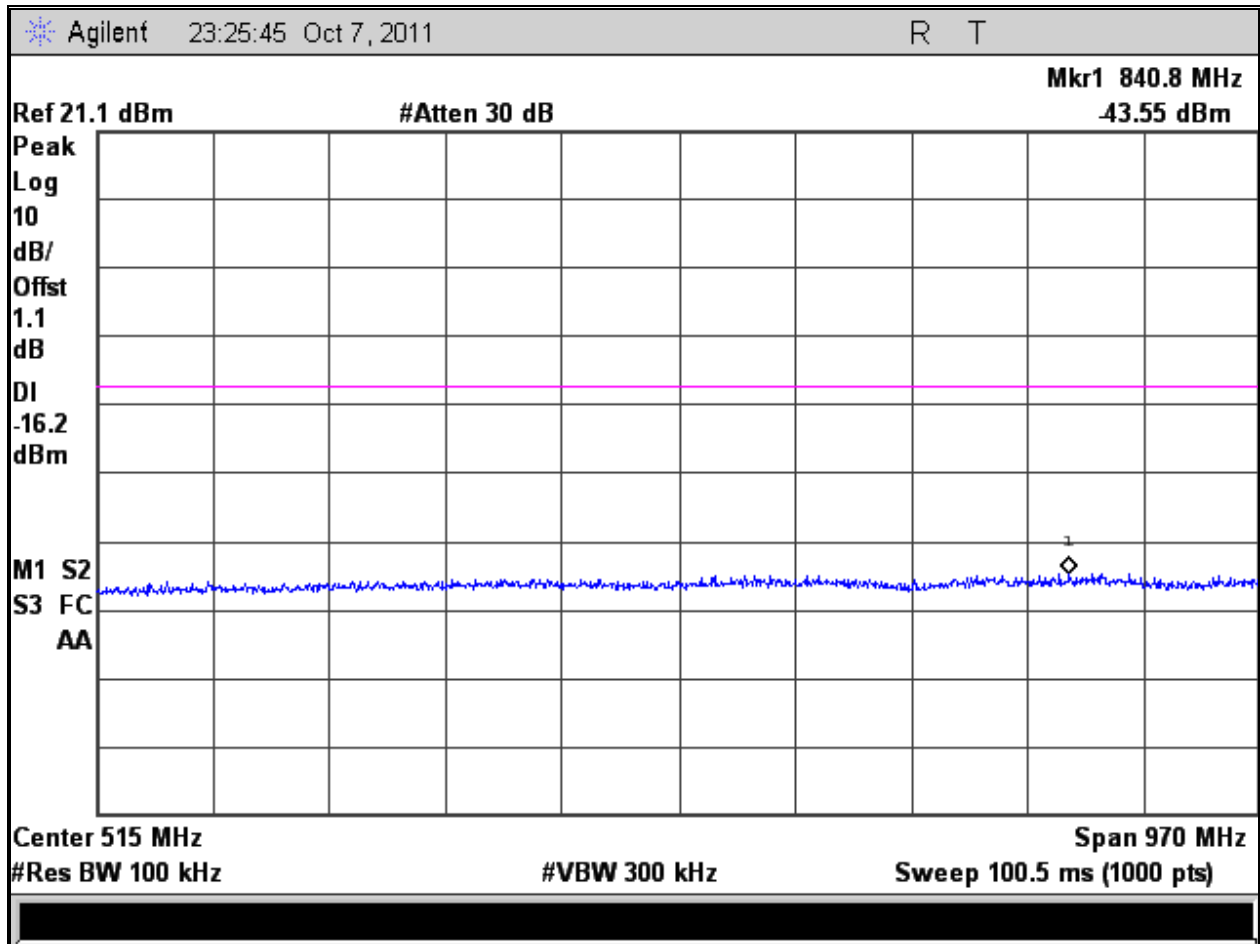

Figure 38: Out of Band Emission for Channel 2412 MHz at 1Mbit/s – Range 1

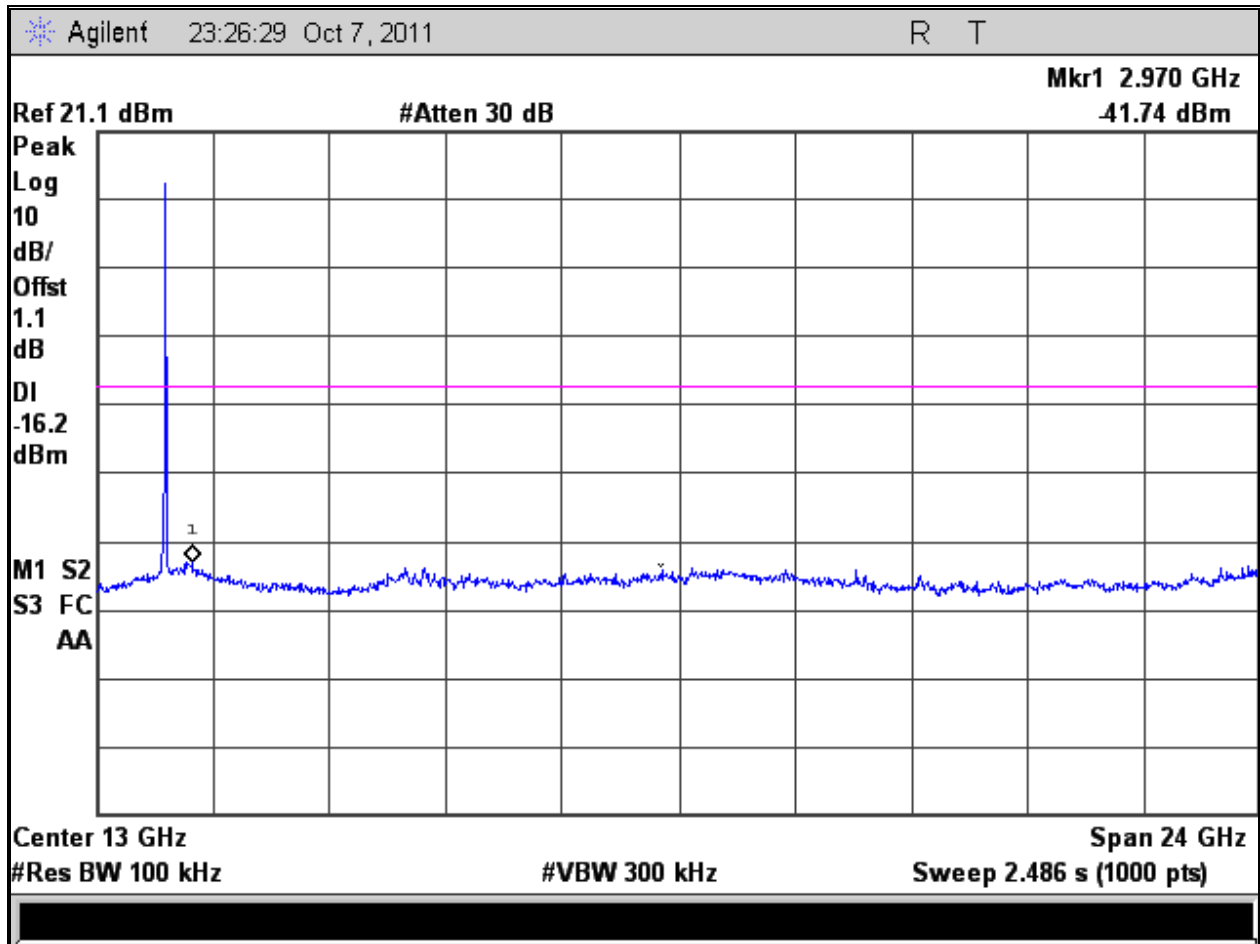

Figure 39: Out of Band Emission for Channel 2412 MHz at 1Mbit/s – Range 2

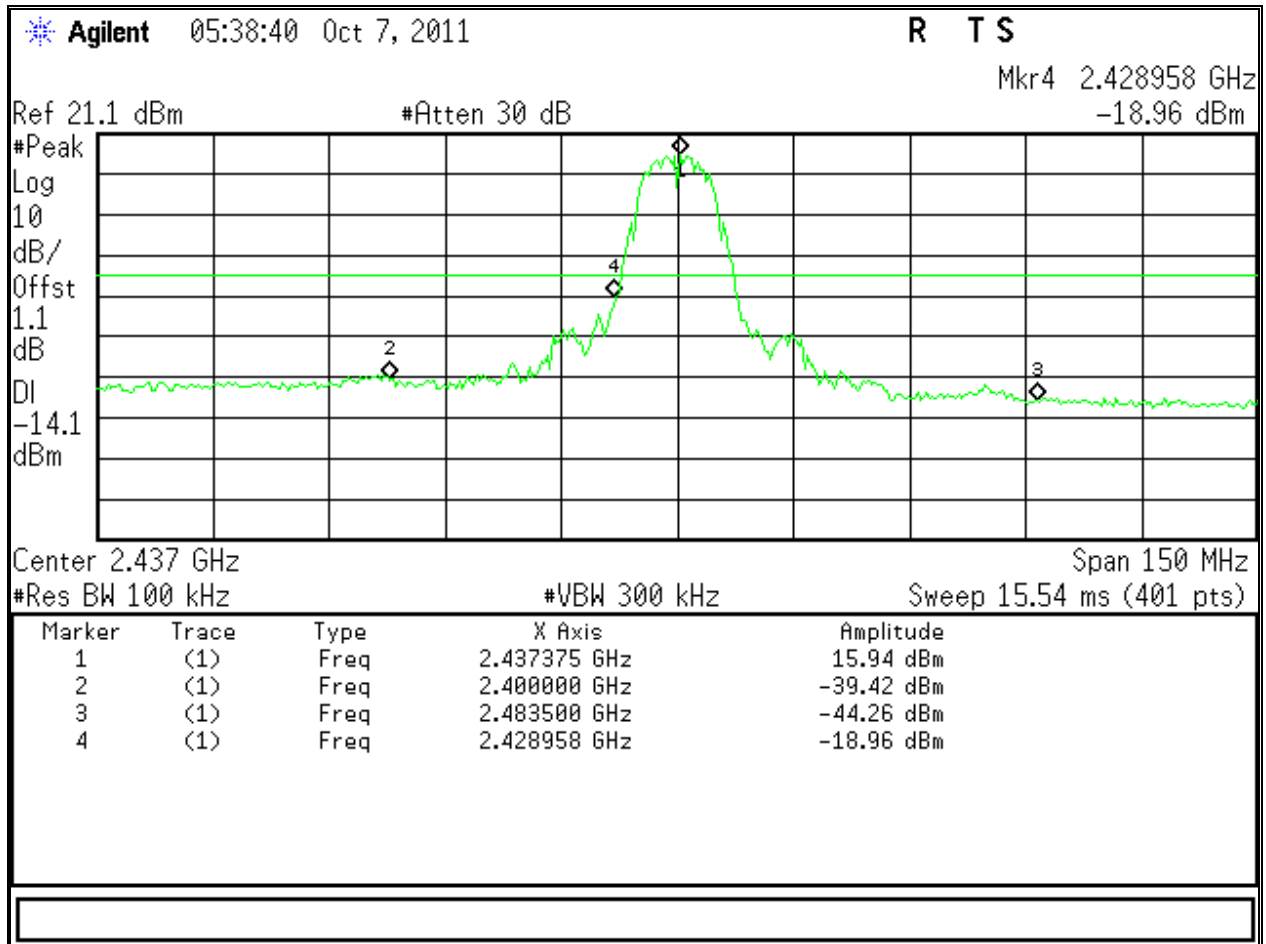

Figure 40: Band-edge Requirement at Operating Channel 2437 MHz, 1MBit/s

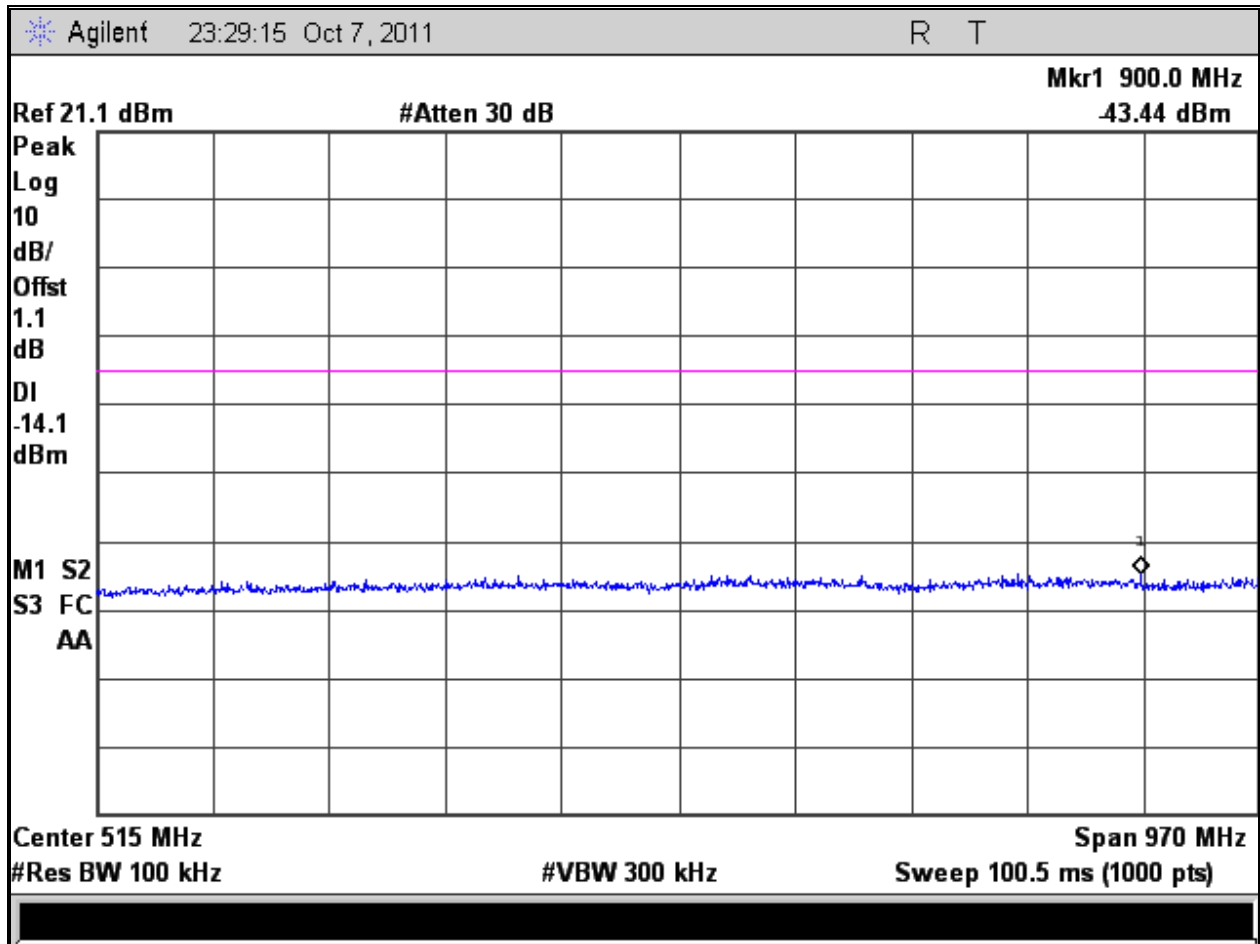

Figure 41: Out of Band Emission for Channel 2437 MHz at 1Mbit/s – Range 1

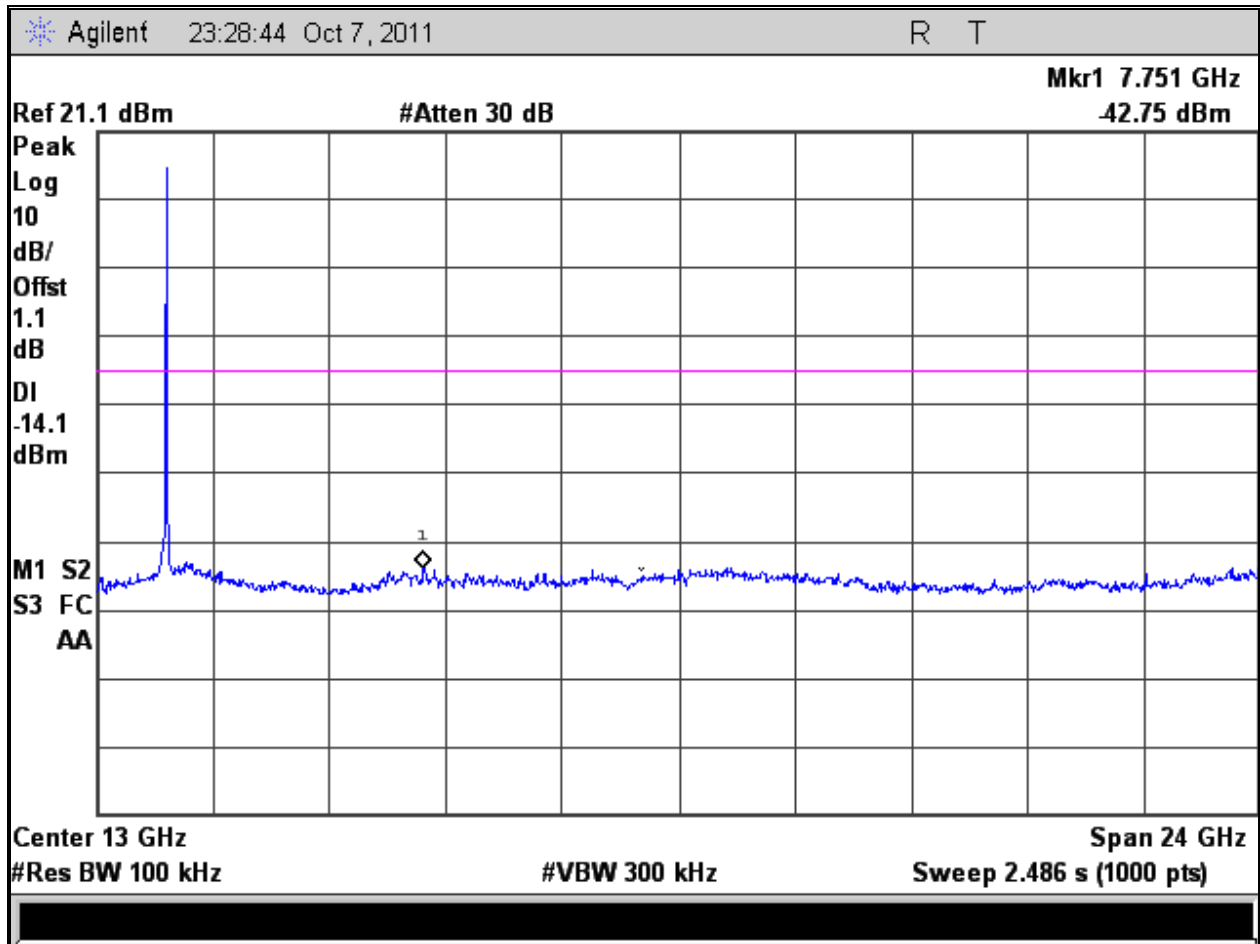

Figure 42: Out of Band Emission for Channel 2437 MHz at 1Mbit/s – Range 2

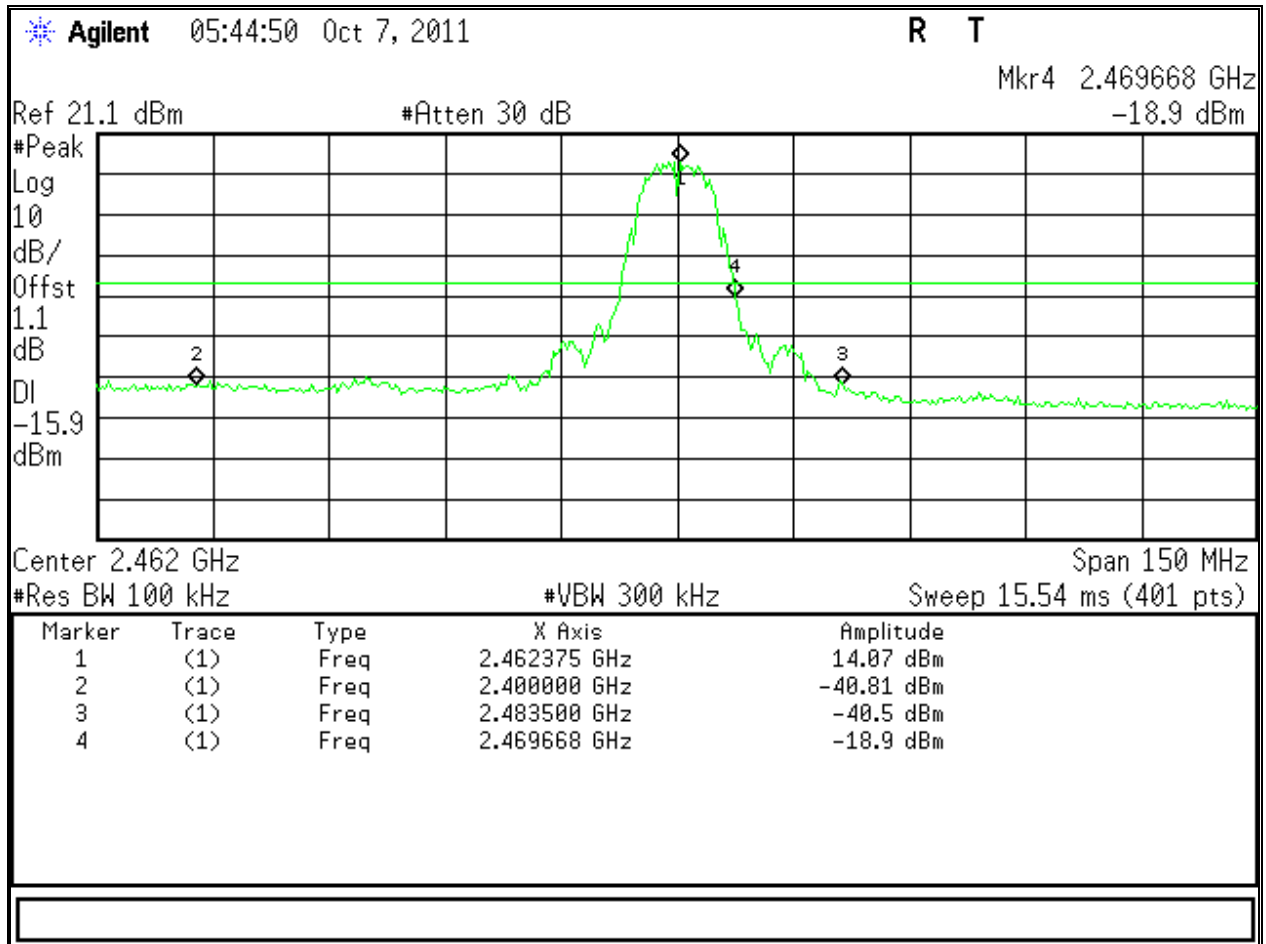

Figure 43: Band-edge Requirement at Operating Channel 2462 MHz, 1MBit/s

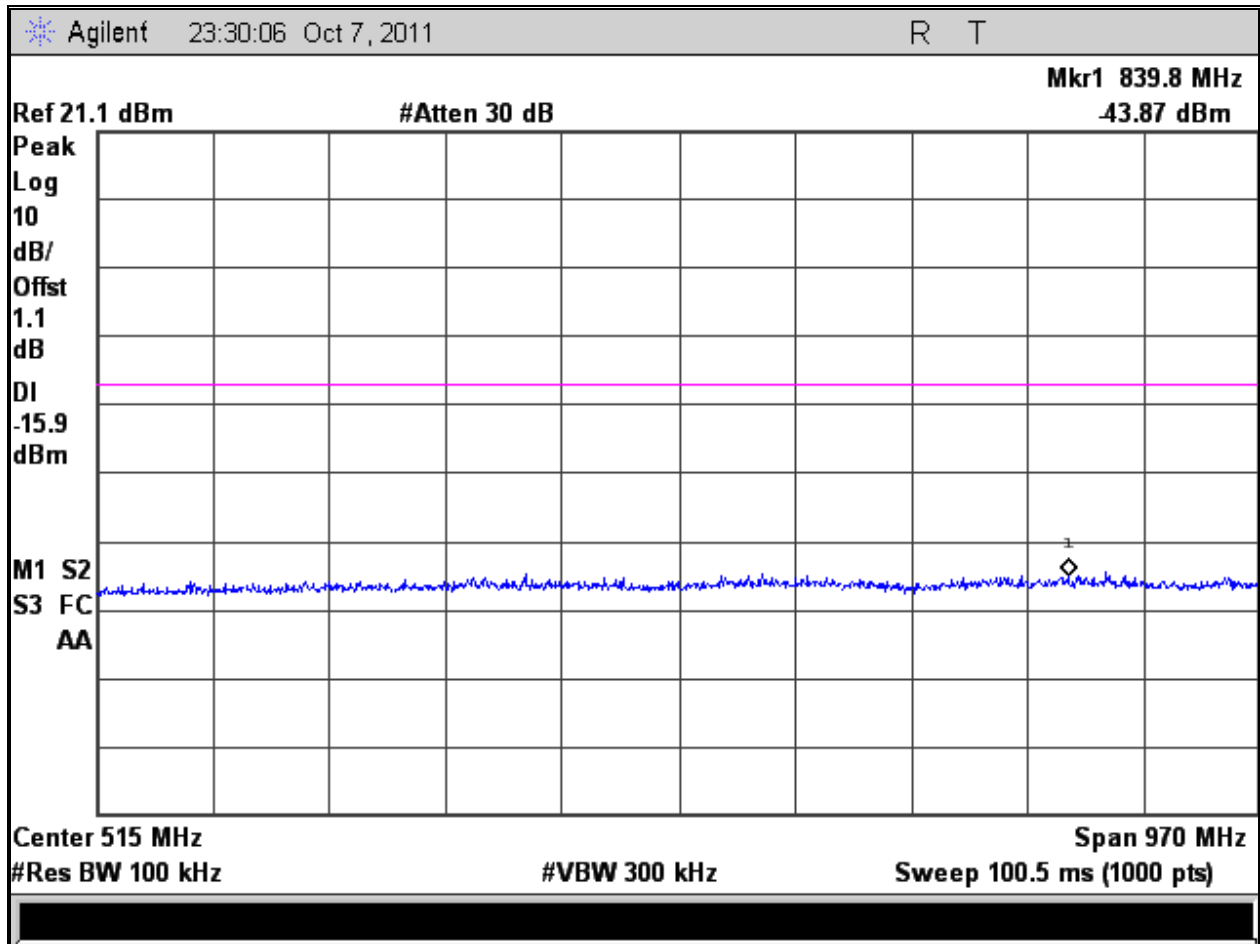

Figure 44: Out of Band Emission for Channel 2462 MHz at 1Mbit/s – Range 1

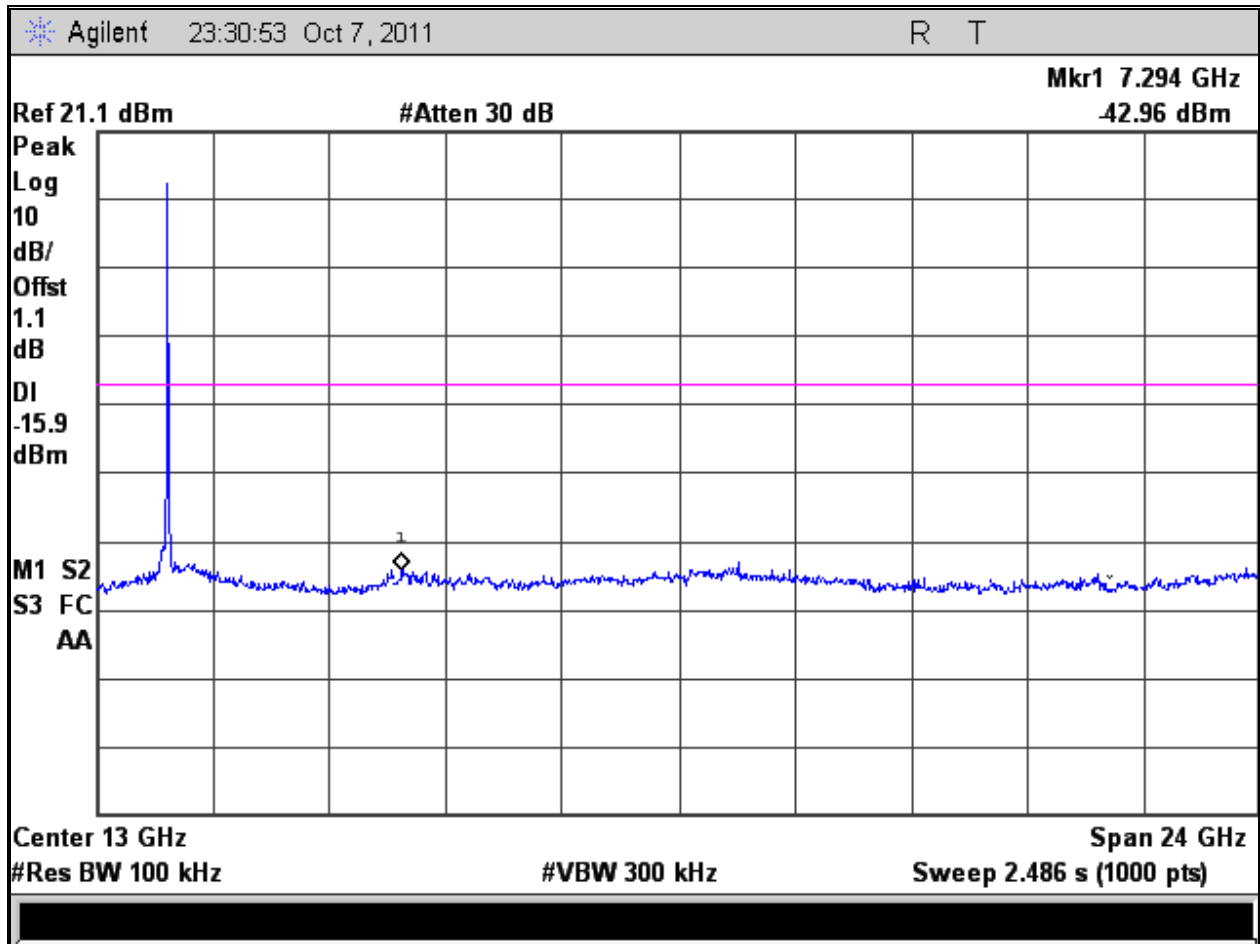

Figure 45: Out of Band Emission for Channel 2462 MHz at 1Mbit/s – Range 2

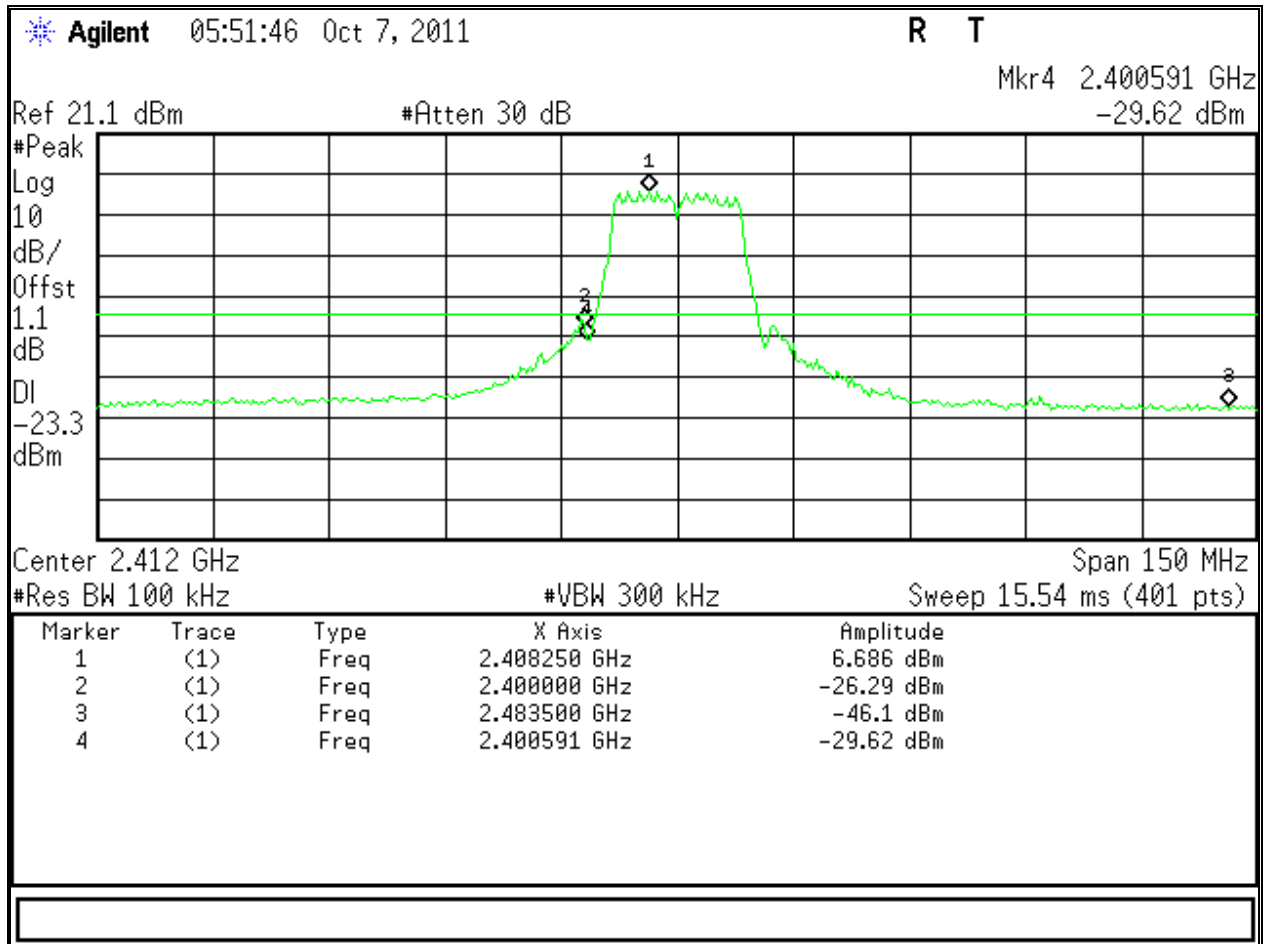

Figure 46: Band-edge Requirement at Operating Channel 2412 MHz, 6MBit/s

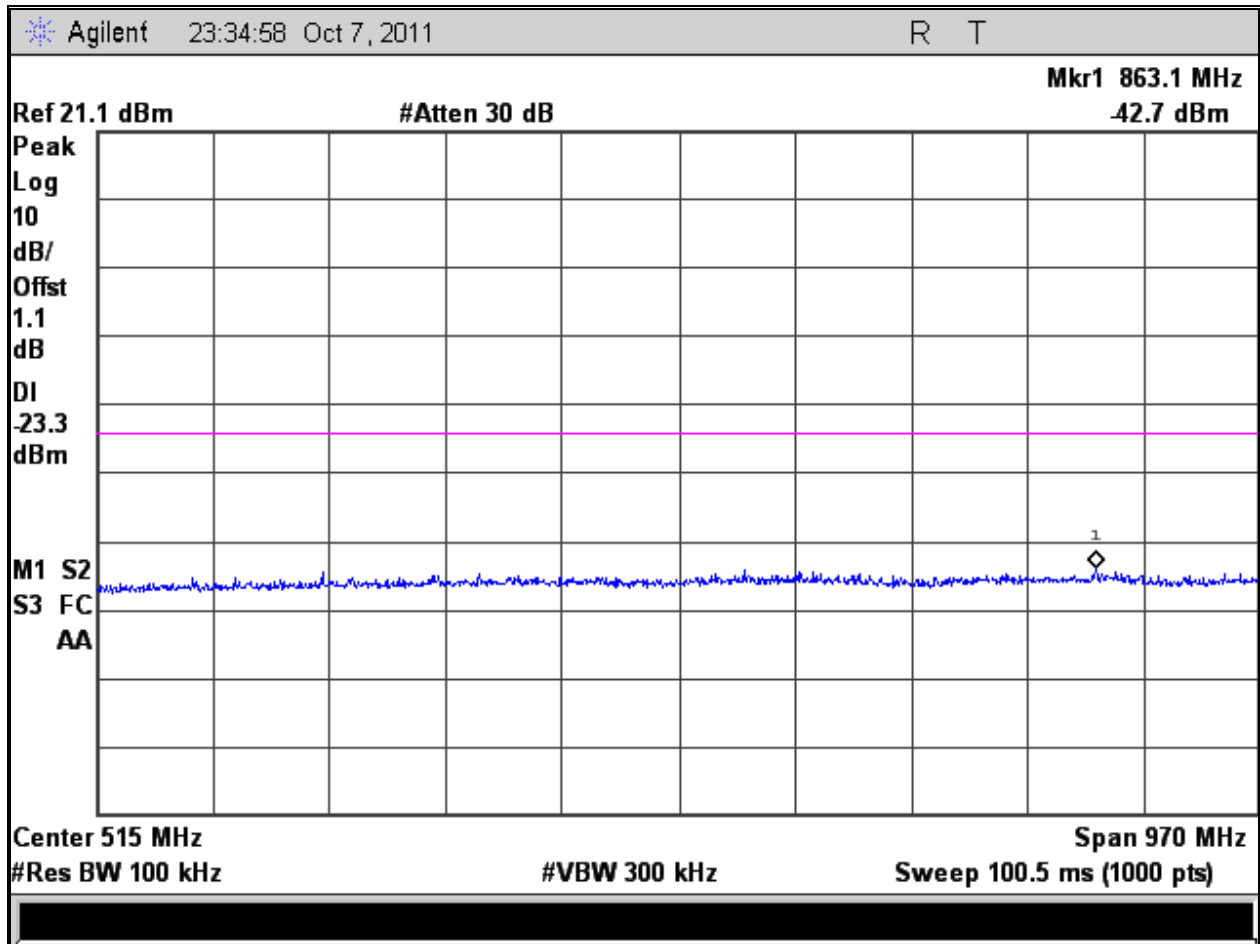

Figure 47: Out of Band Emission for Channel 2412 MHz at 6Mbit/s – Range 1

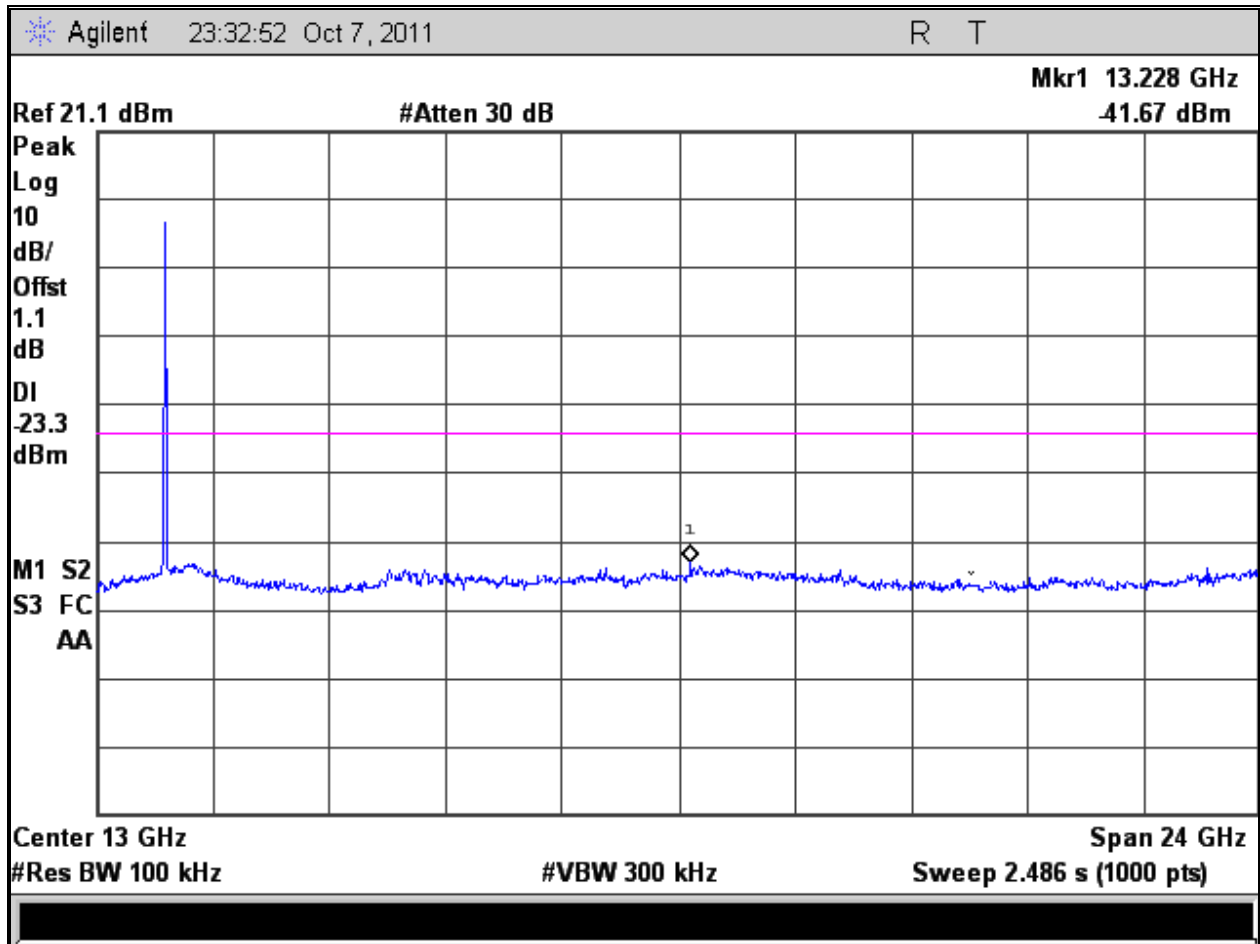

Figure 48: Out of Band Emission for Channel 2412 MHz at 6Mbit/s – Range 2

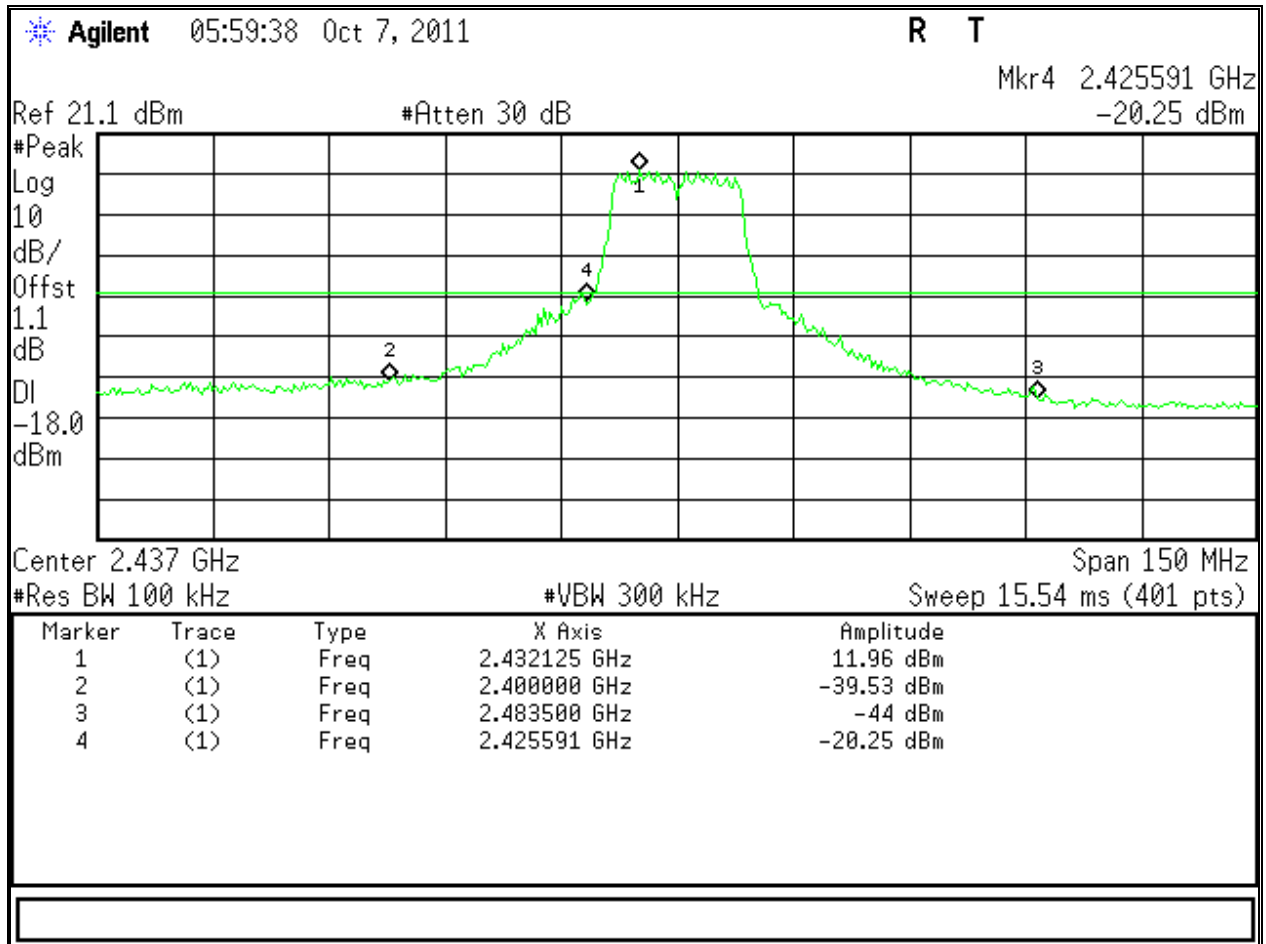

Figure 49: Band-edge Requirement at Operating Channel 2437 MHz, 6MBit/s

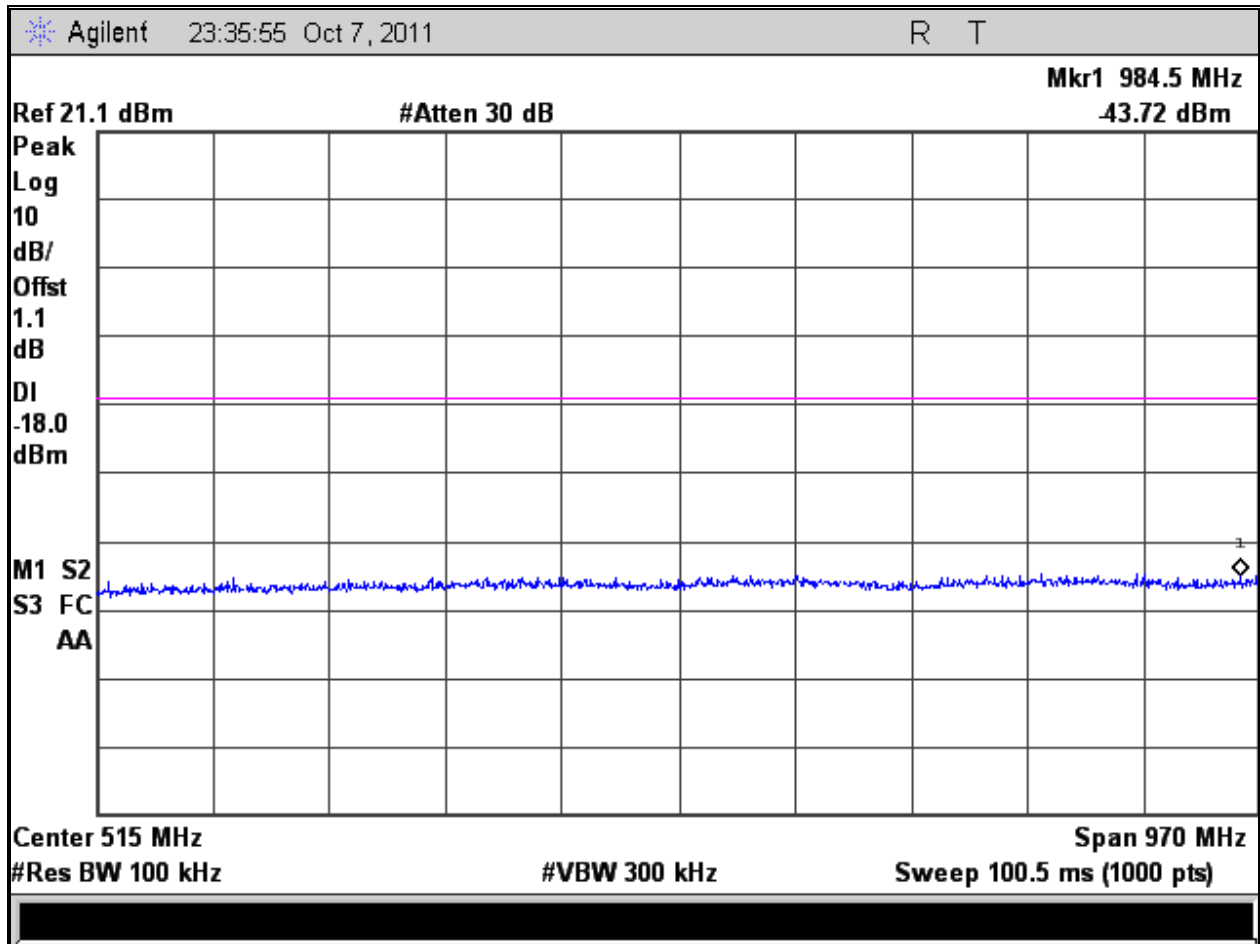

Figure 50: Out of Band Emission for Channel 2437 MHz at 6Mbit/s – Range 1

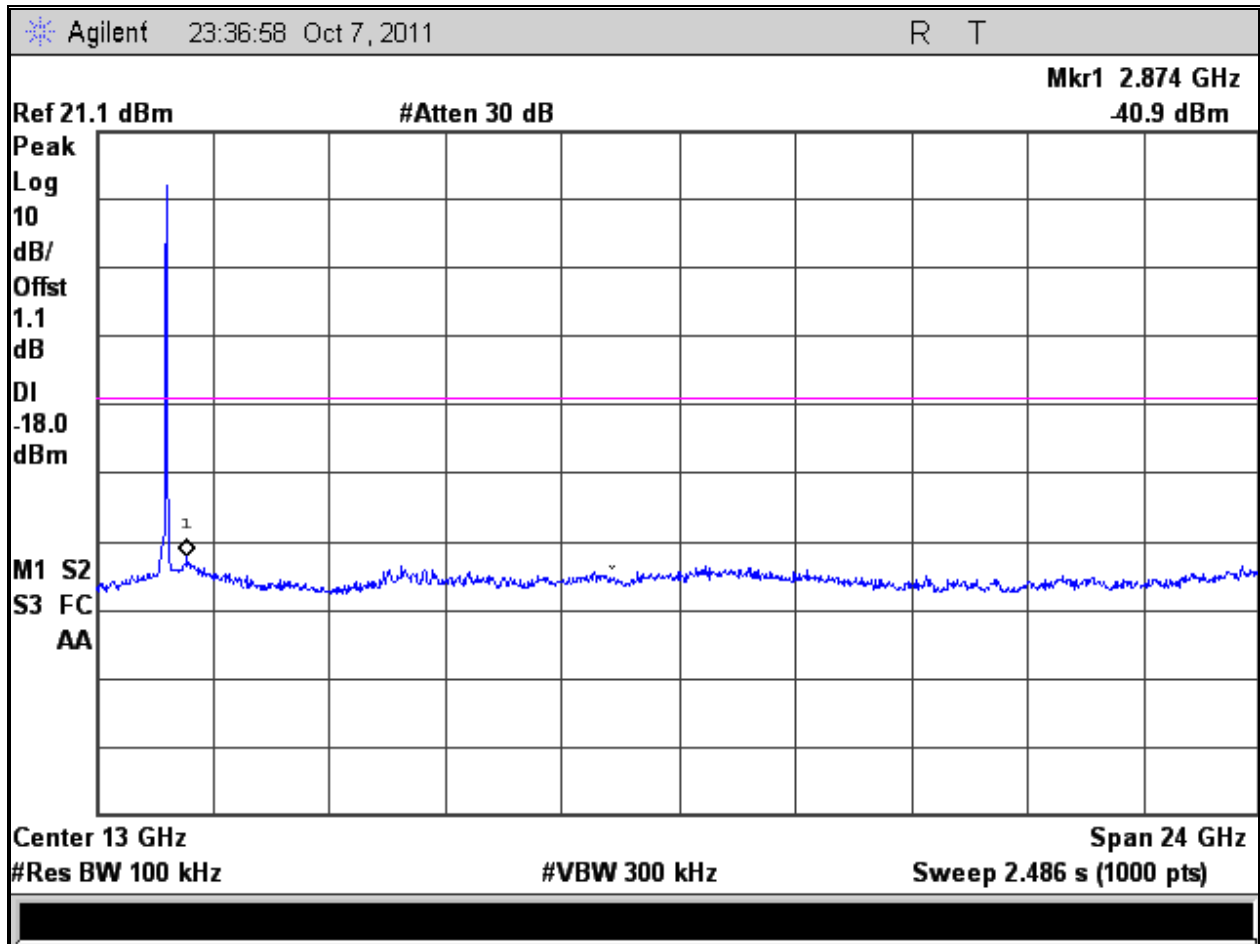

Figure 51: Out of Band Emission for Channel 2437 MHz at 6Mbit/s – Range 2

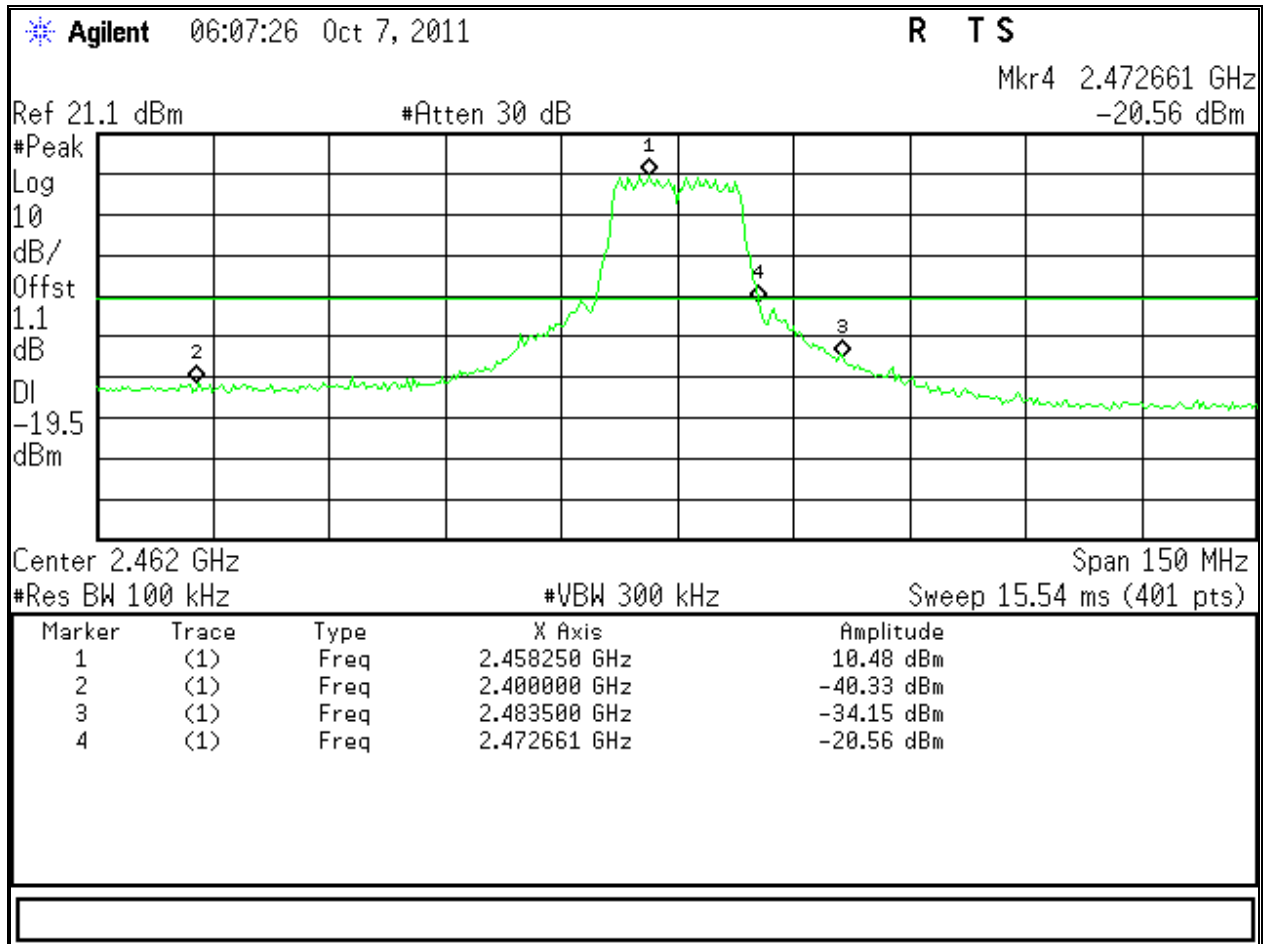

Figure 52: Band-edge Requirement at Operating Channel 2462 MHz, 6MBit/s

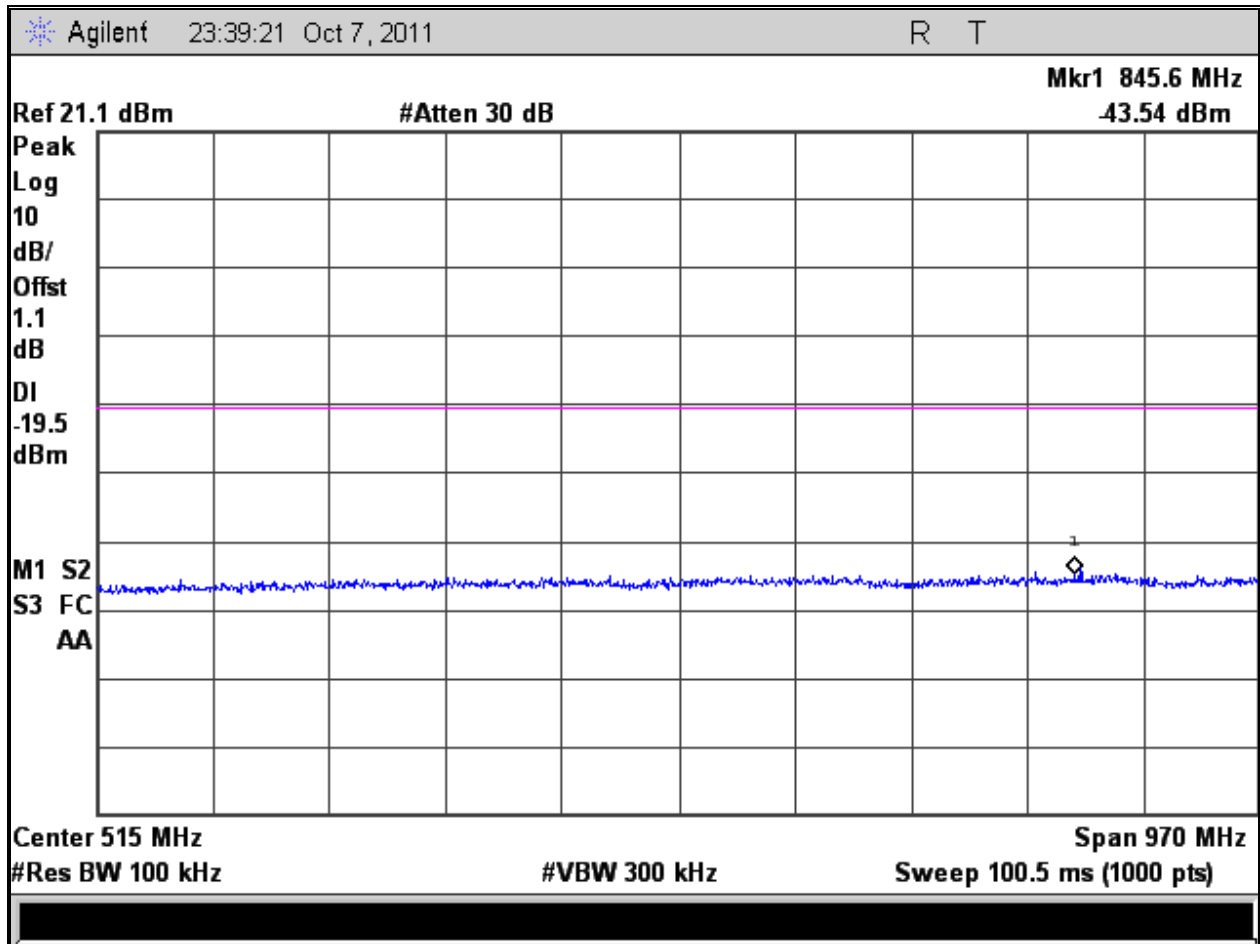

Figure 53: Out of Band Emission for Channel 2462 MHz at 6Mbit/s – Range 1

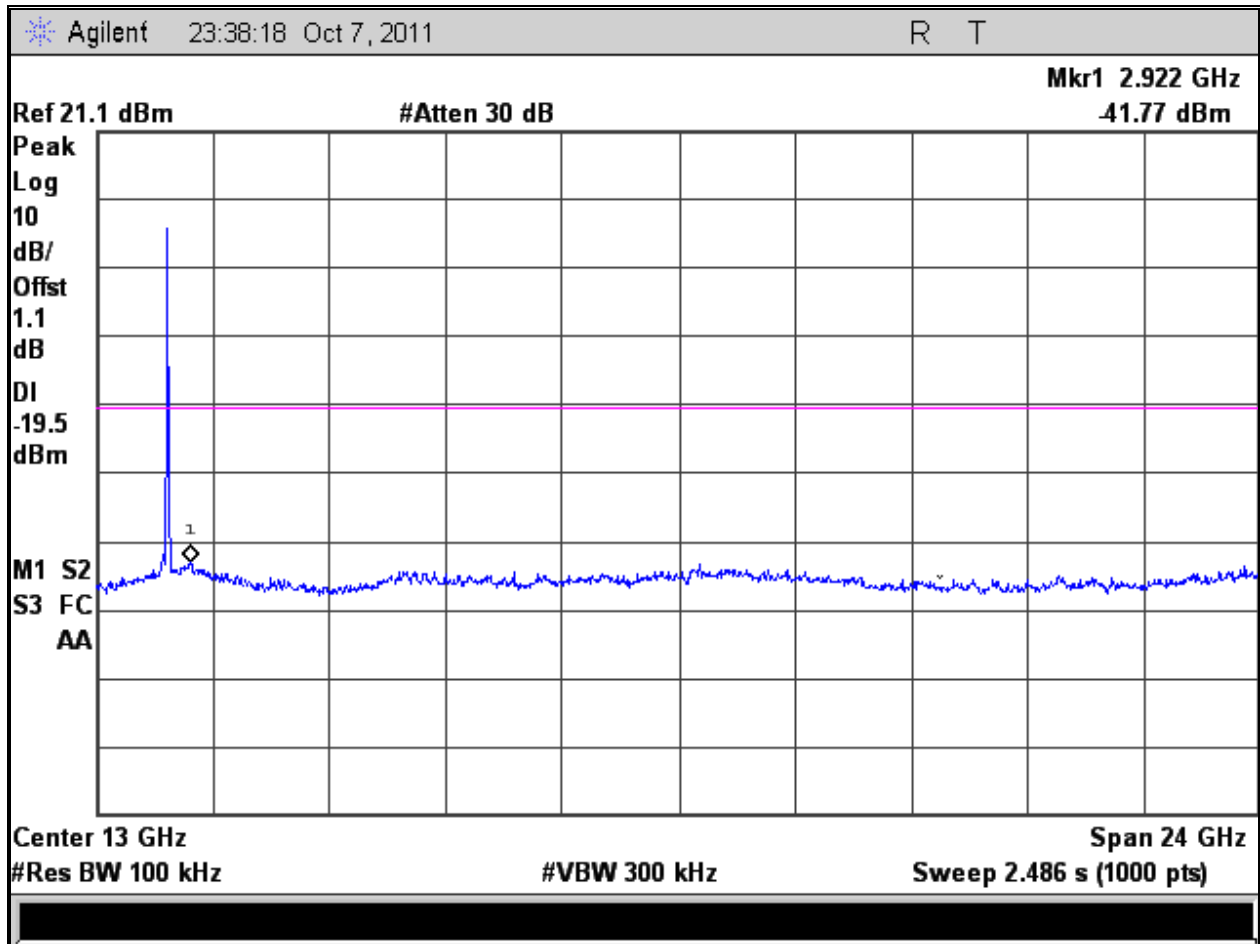

Figure 54: Out of Band Emission for Channel 2462 MHz at 6Mbit/s – Range 2

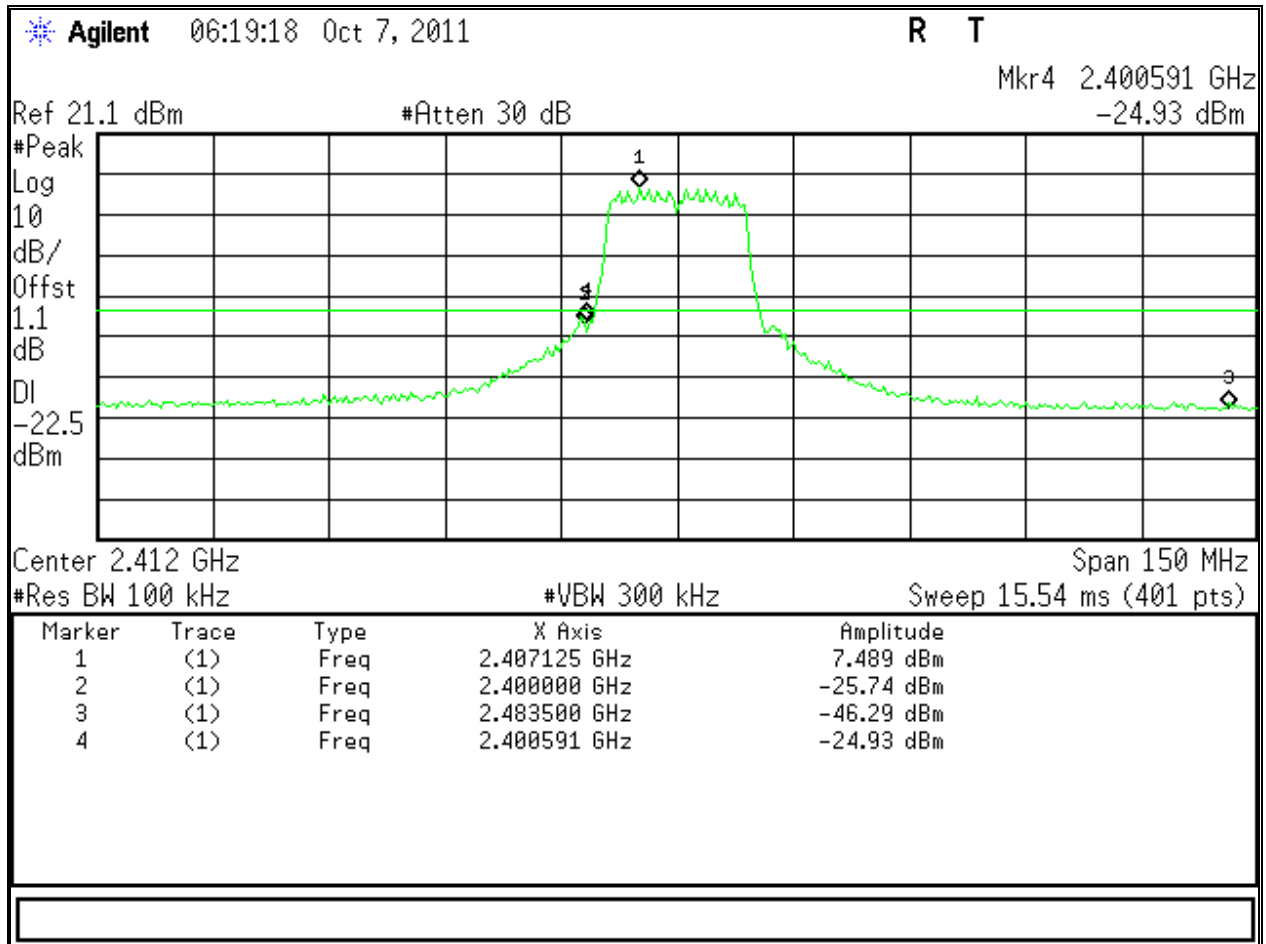

Figure 55: Band-edge Requirement at Operating Channel 2412 MHz, 6.5MBit/s

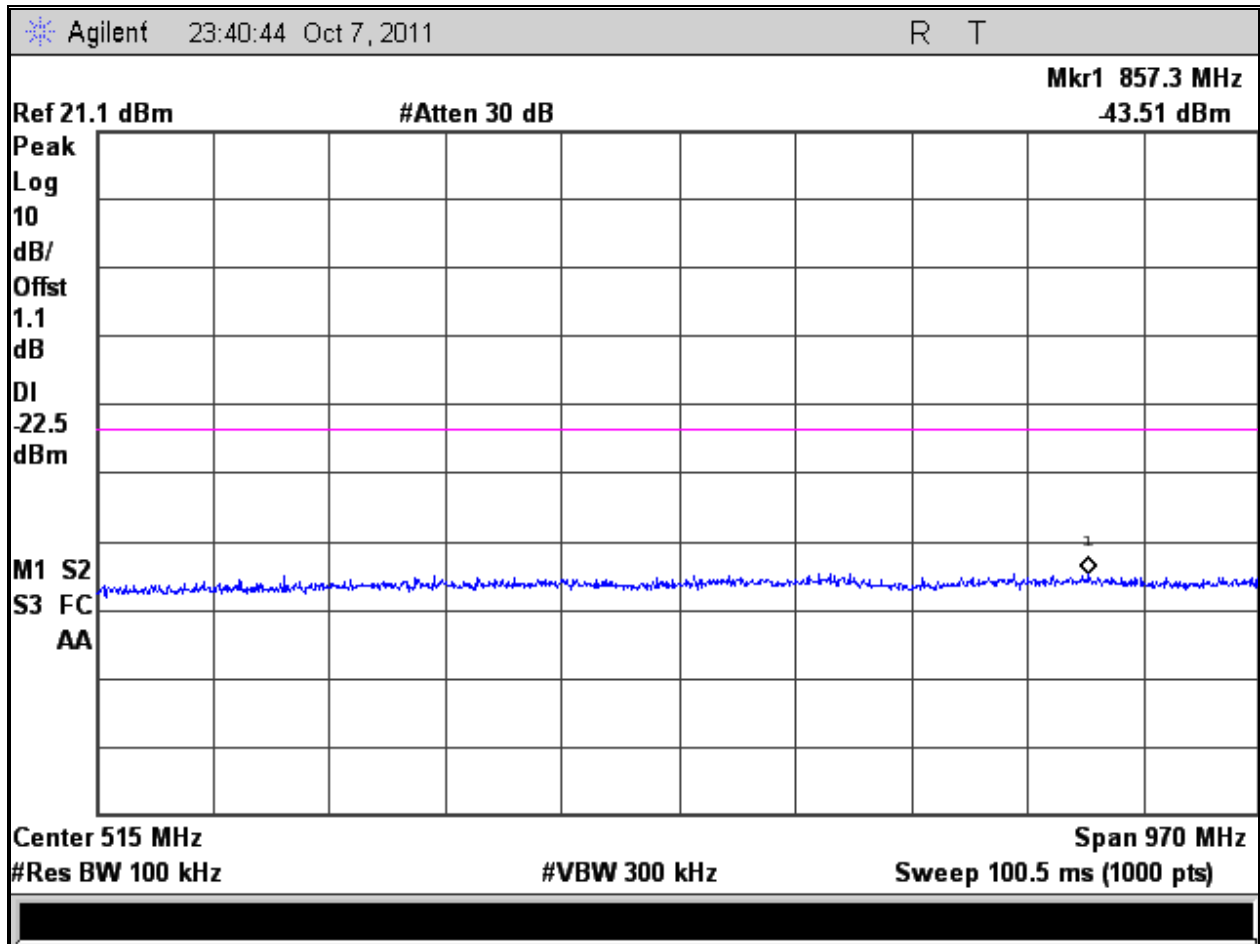

Figure 56: Out of Band Emission for Channel 2412 MHz at 6.5Mbit/s –Range 1

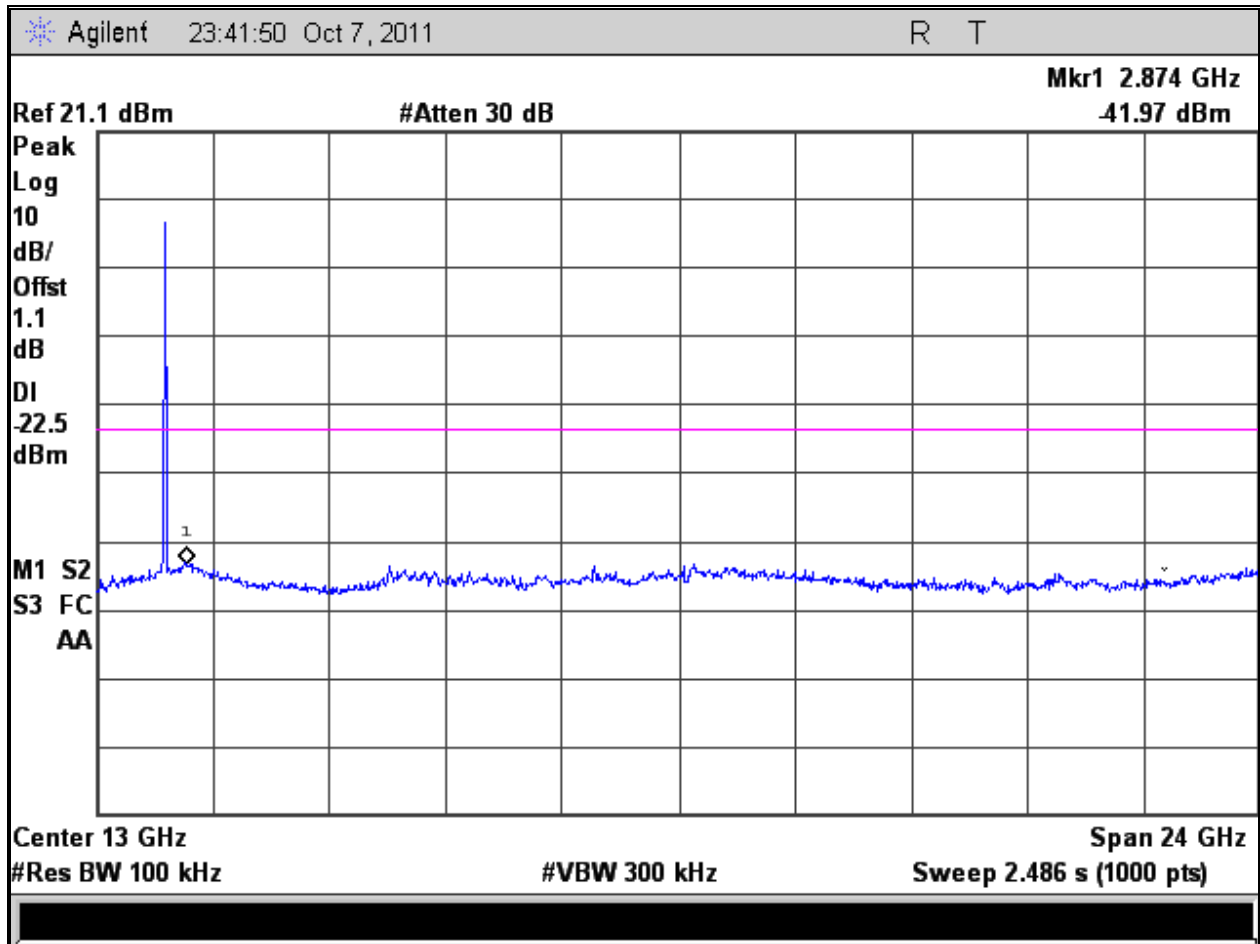

Figure 57: Out of Band Emission for Channel 2412 MHz at 6.5Mbit/s –Range 2

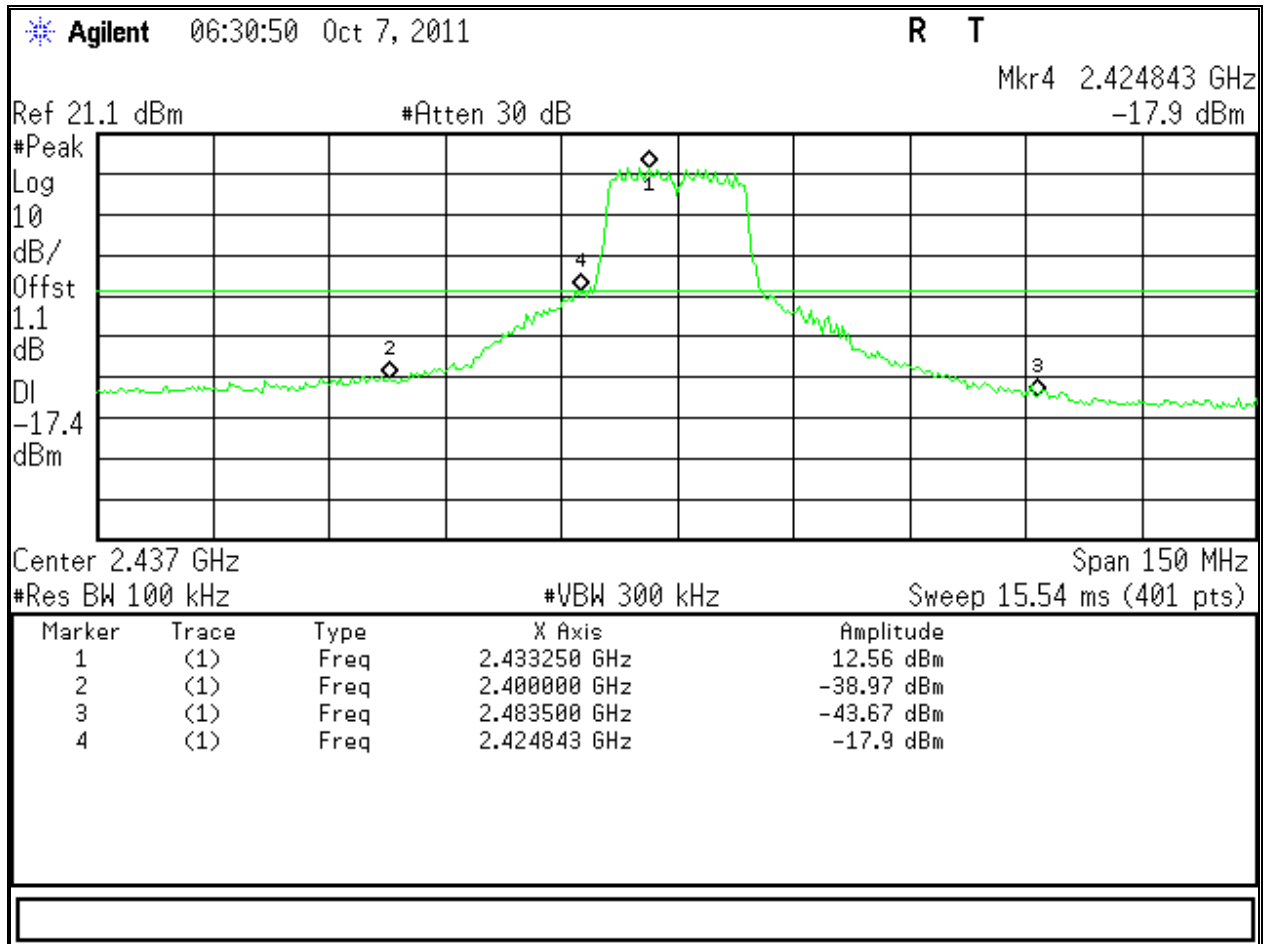

Figure 58: Band-edge Requirement at Operating Channel 2437 MHz, 6.5MBit/s

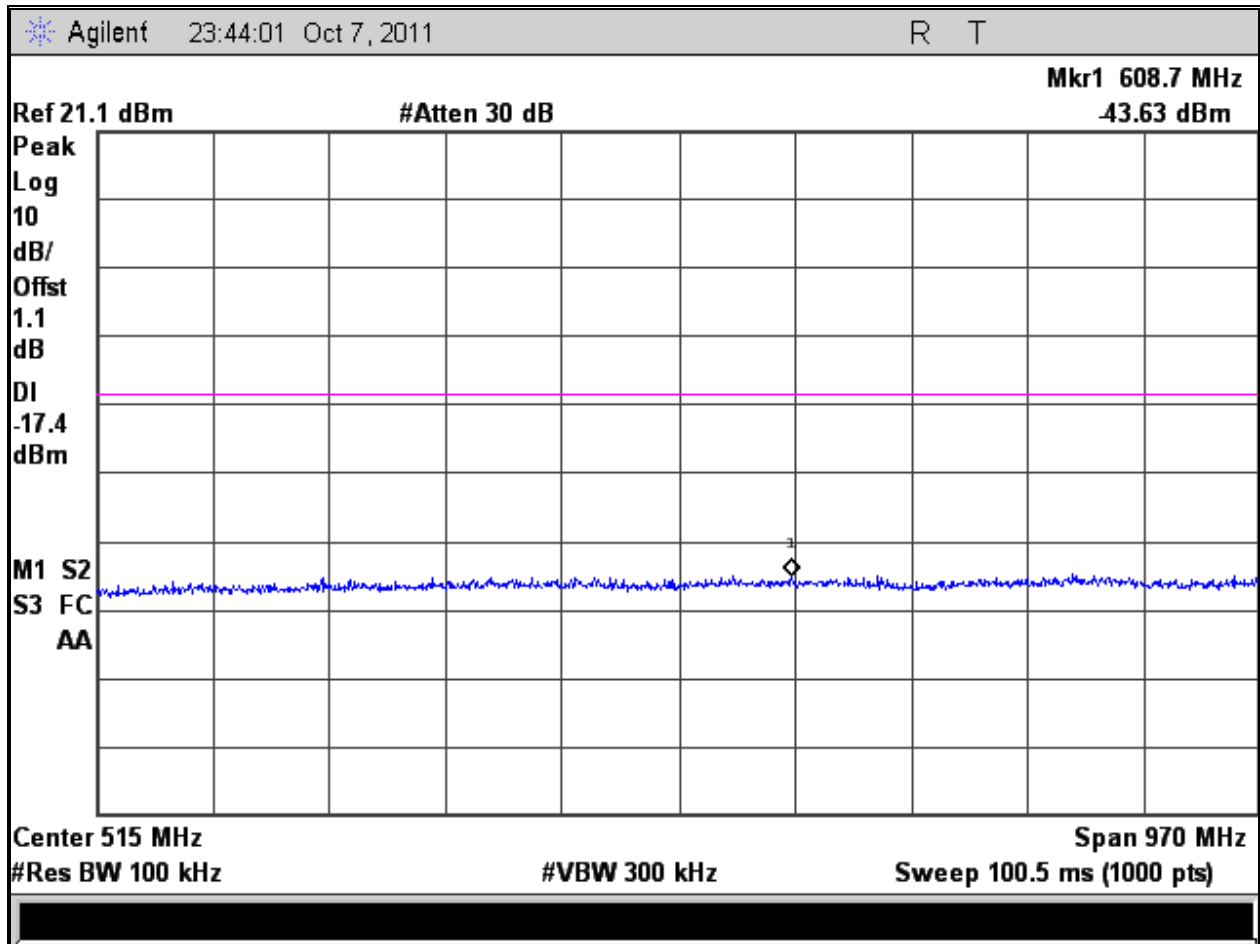

Figure 59: Out of Band Emission for Channel 2437 MHz at 6.5Mbit/s – Range 1

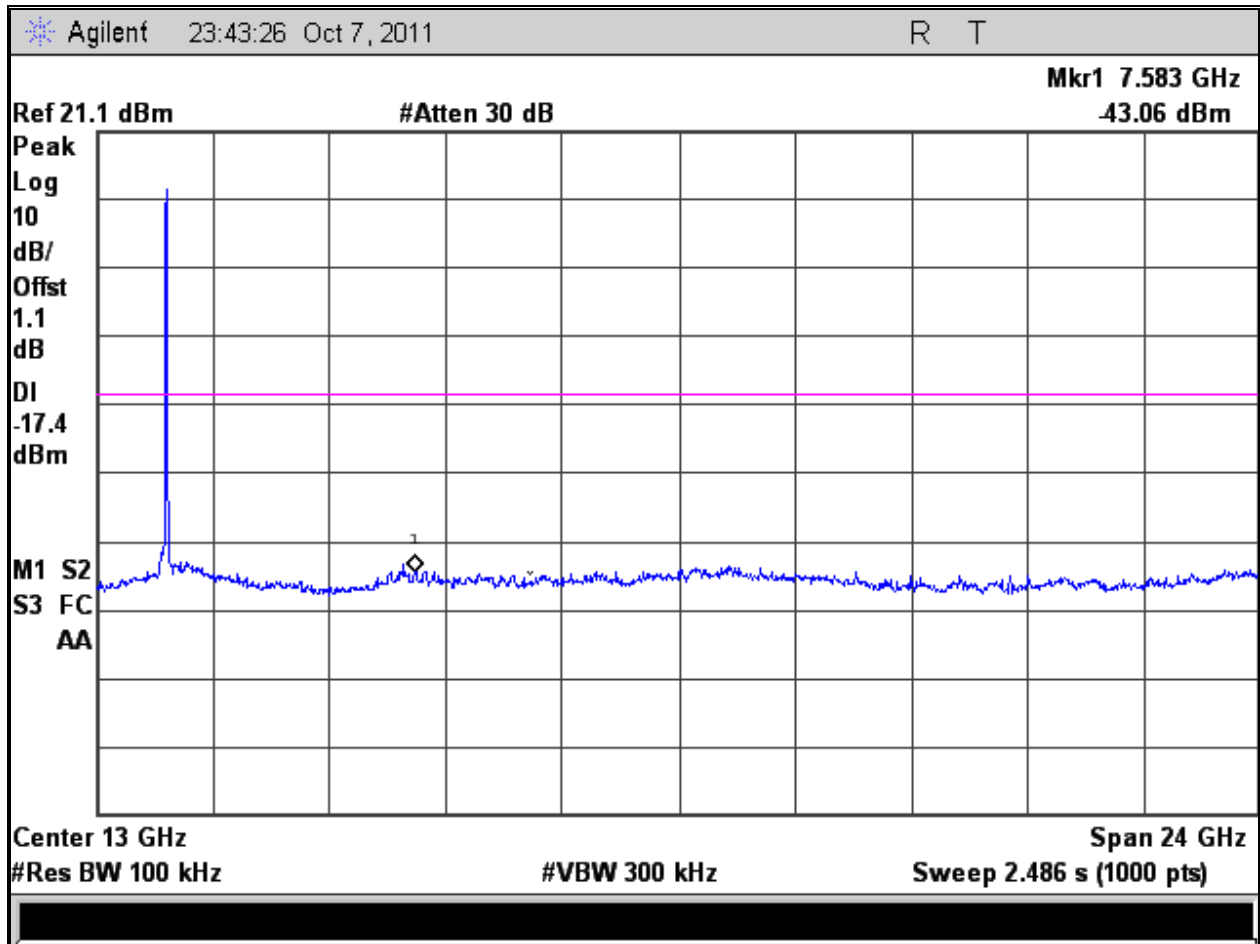

Figure 60: Out of Band Emission for Channel 2437 MHz at 6.5Mbit/s – Range 2

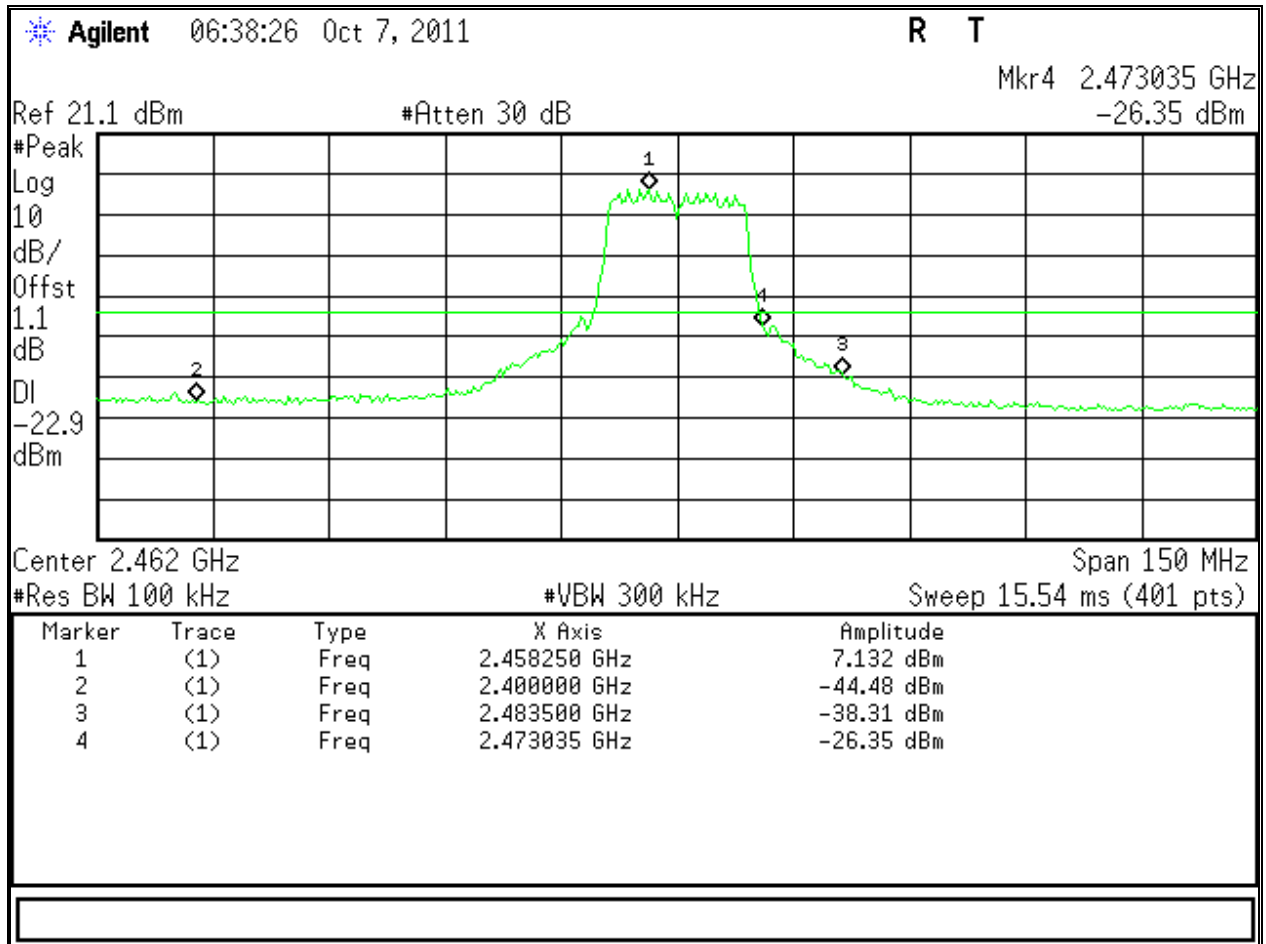

Figure 61: Band-edge Requirement at Operating Channel 2462 MHz, 6.5MBit/s

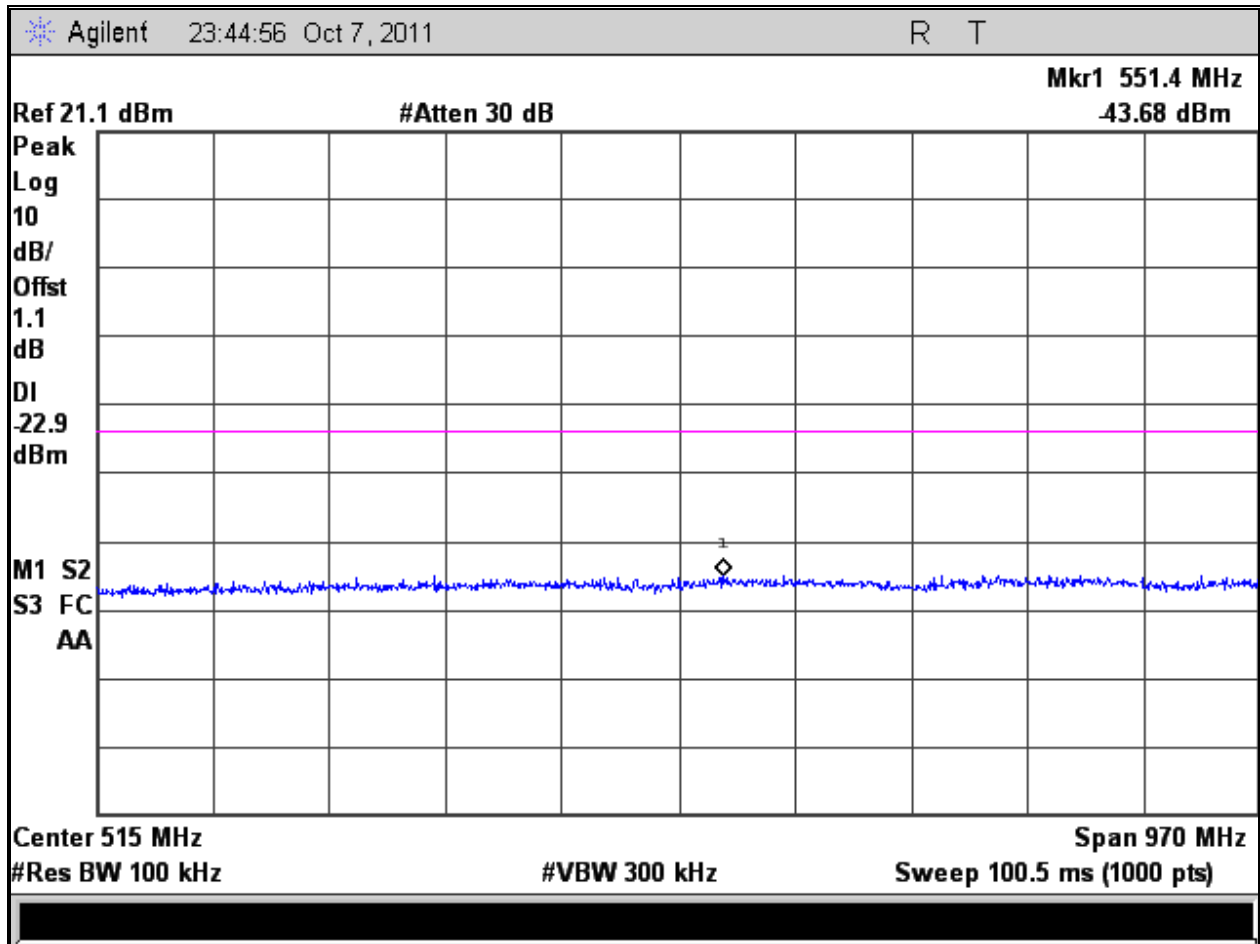

Figure 62: Out of Band Emission for Channel 2462 MHz at 6.5Mbit/s – Range 1

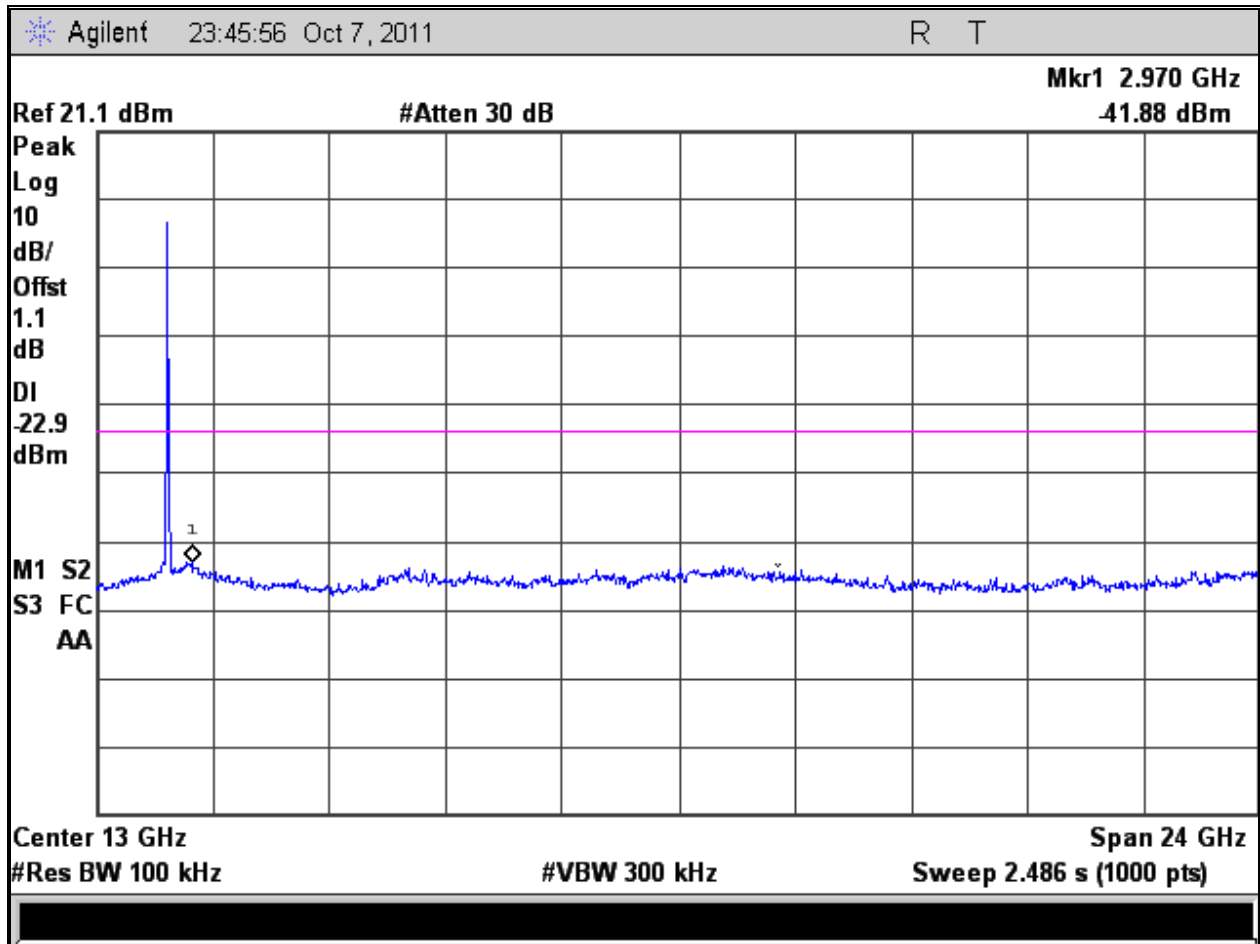

Figure 63: Out of Band Emission for Channel 2462 MHz at 6.5Mbit/s – Range 2

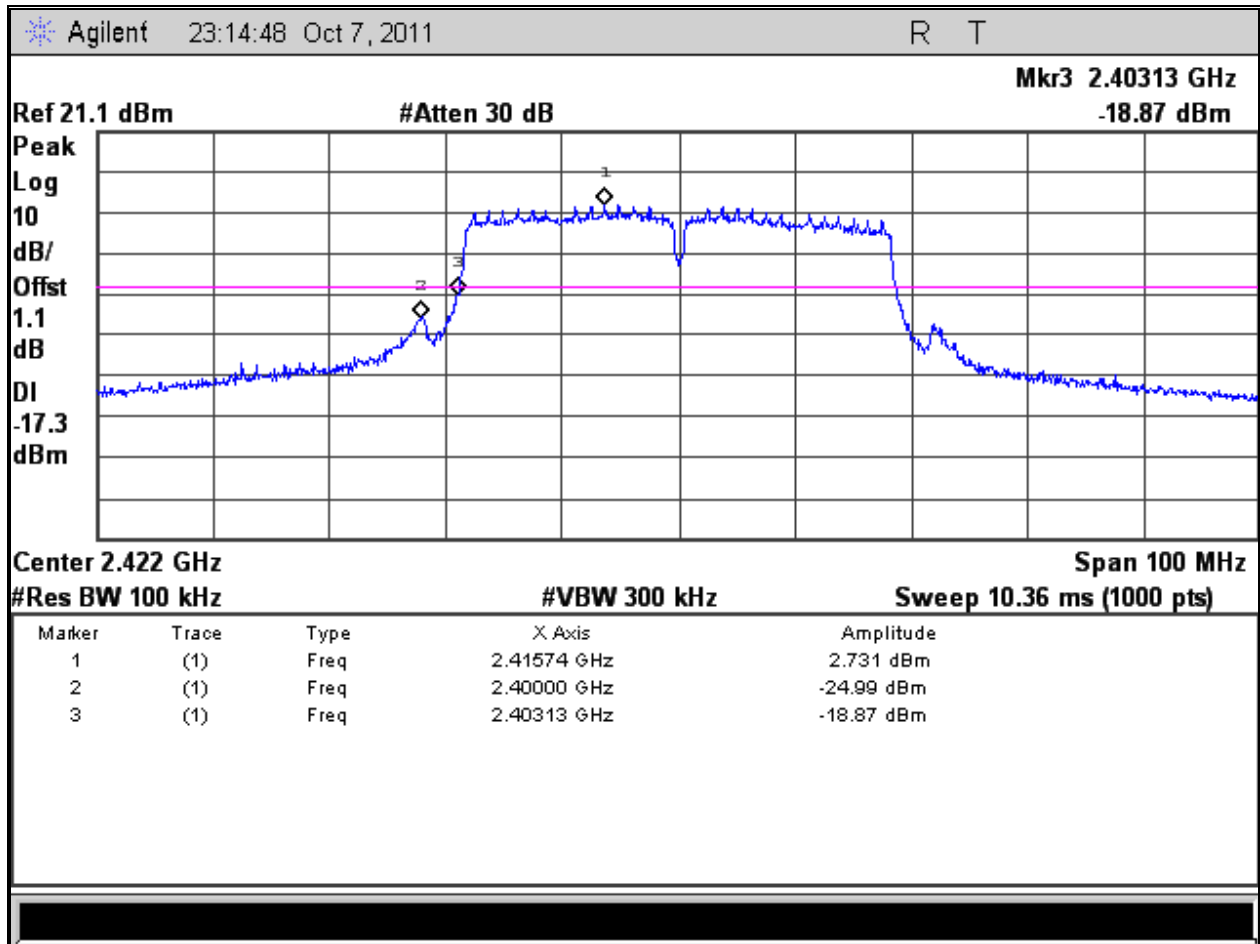

Figure 64: Band-edge Requirement at Operating Channel 2422 MHz, 13.5MBit/s

Note: The 2422 MHz channel met peak channel power; therefore, -20dBr band-edge level was used.

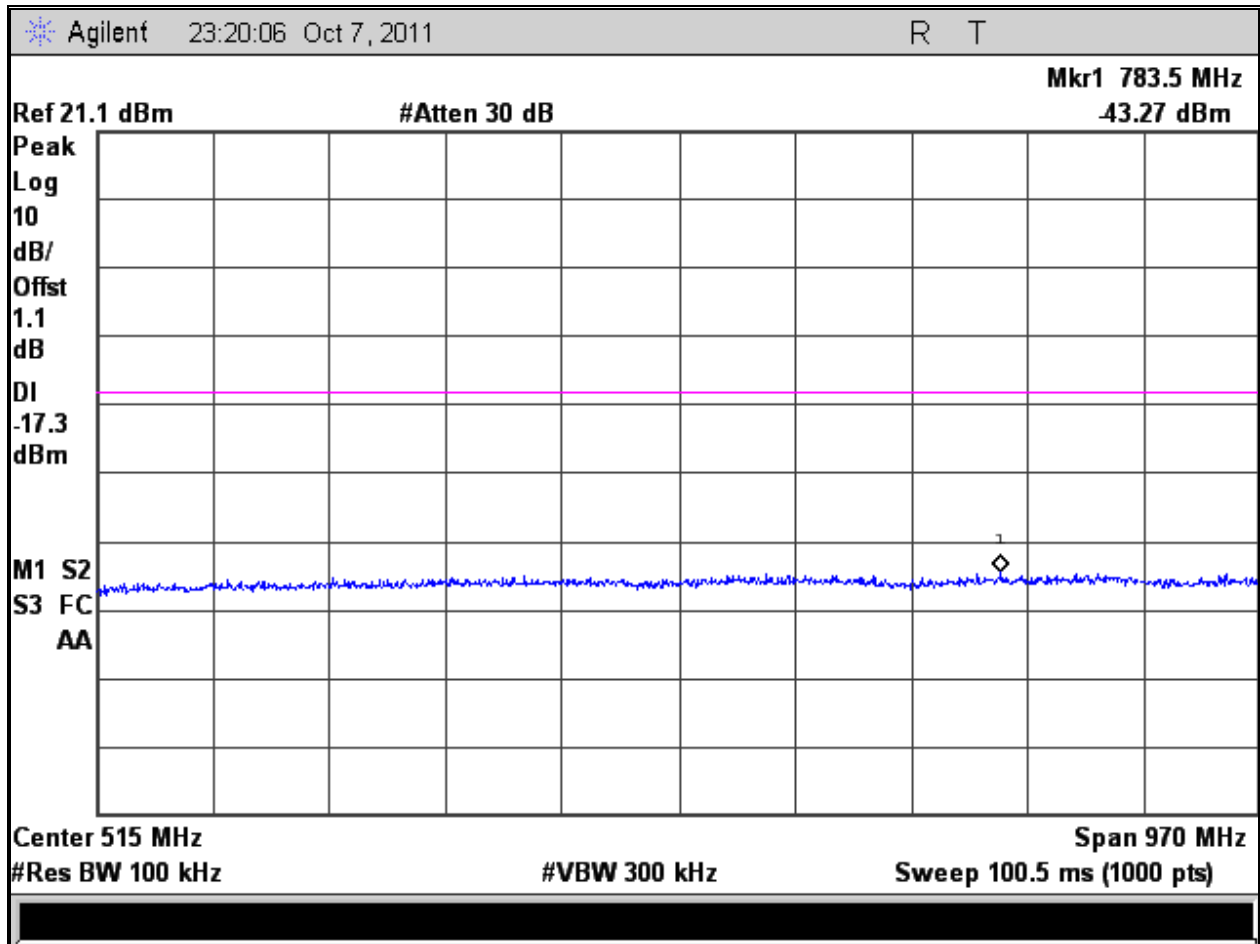

Figure 65: Out of Band Emission for Channel 2422 MHz at 13.5Mbit/s – Range 1

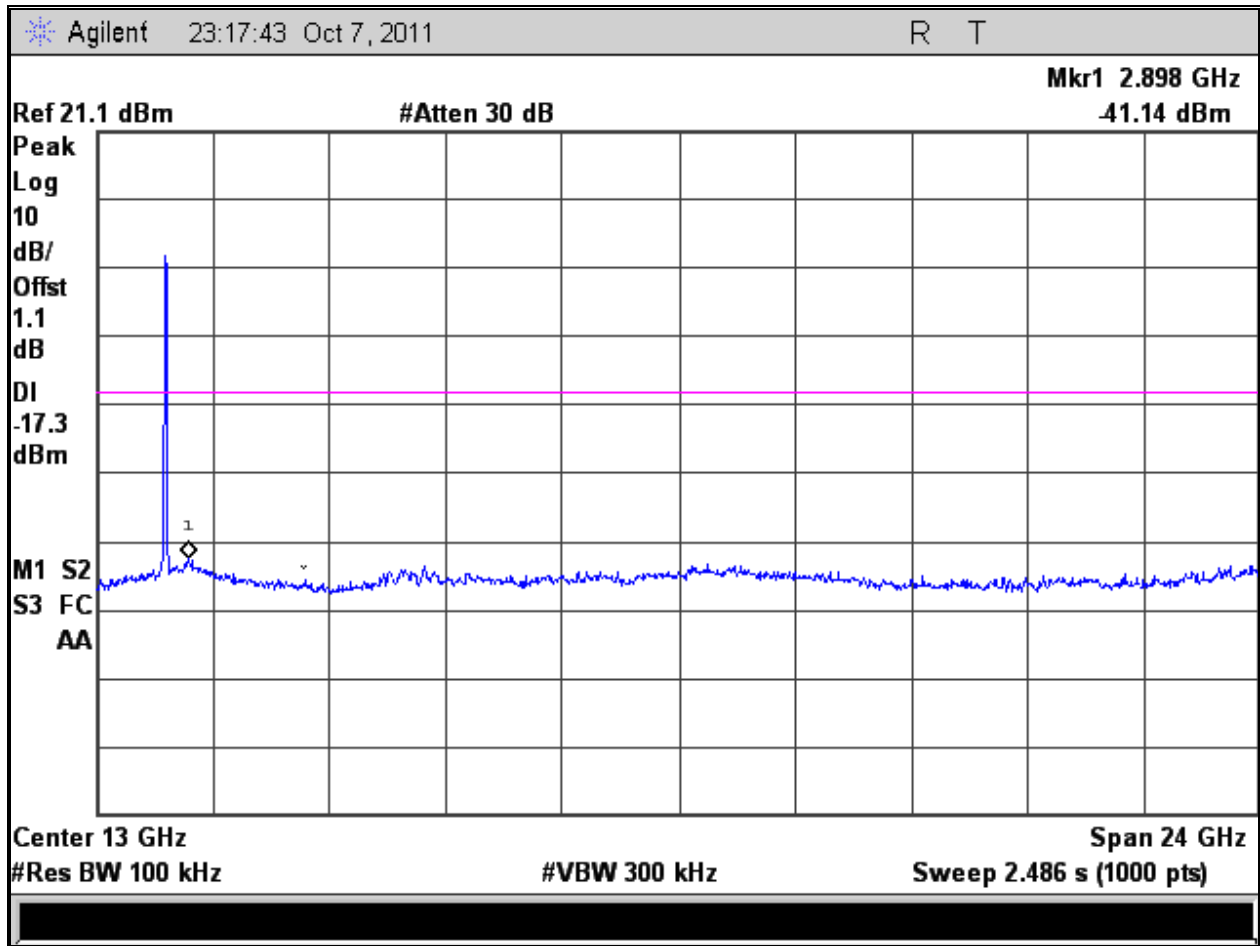

Figure 66: Out of Band Emission for Channel 2422 MHz at 13.5Mbit/s – Range 2

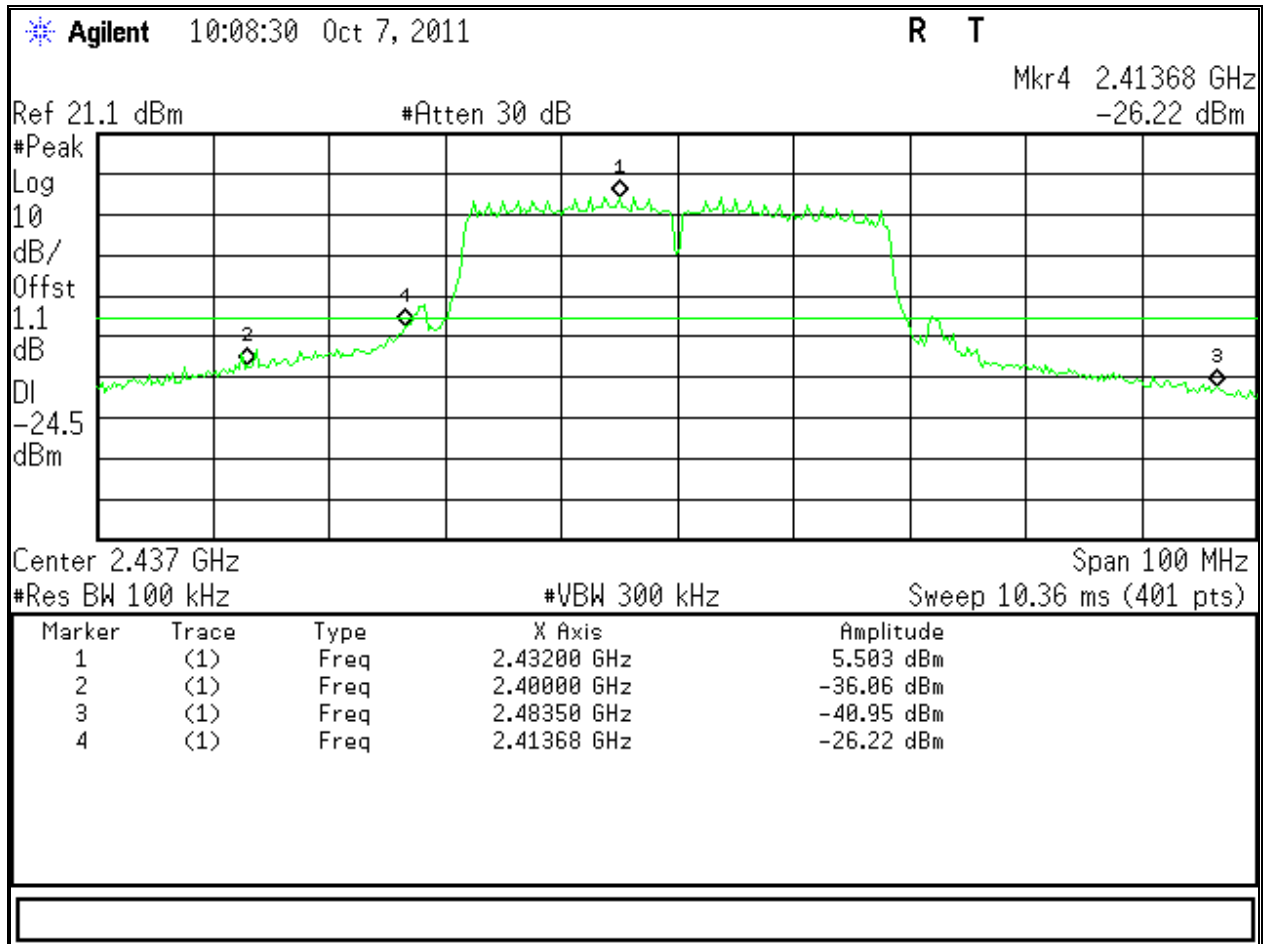

Figure 67: Band-edge Requirement at Operating Channel 2437 MHz, 13.5MBit/s

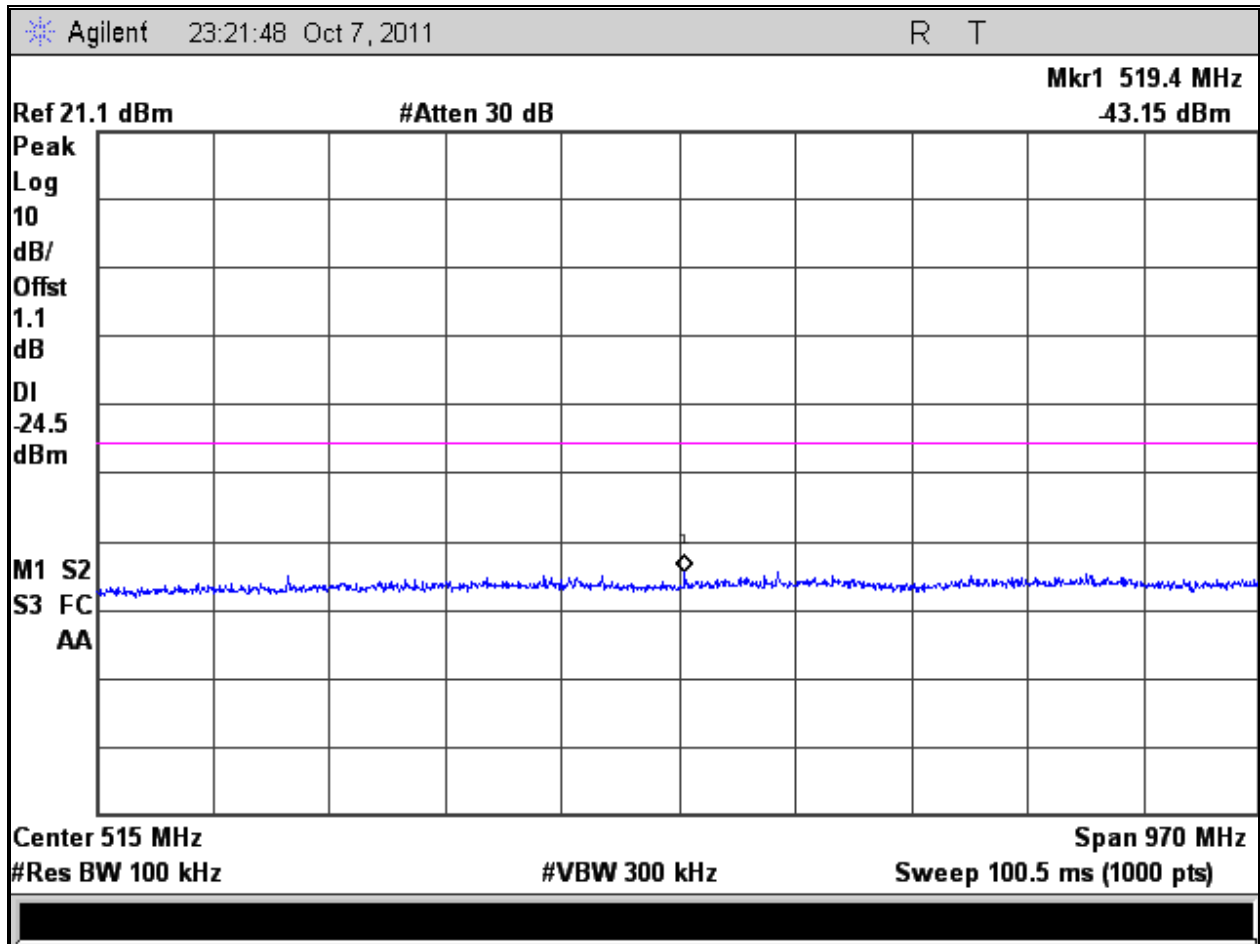

Figure 68: Out of Band Emission for Channel 2437 MHz at 13.5Mbit/s – Range 1

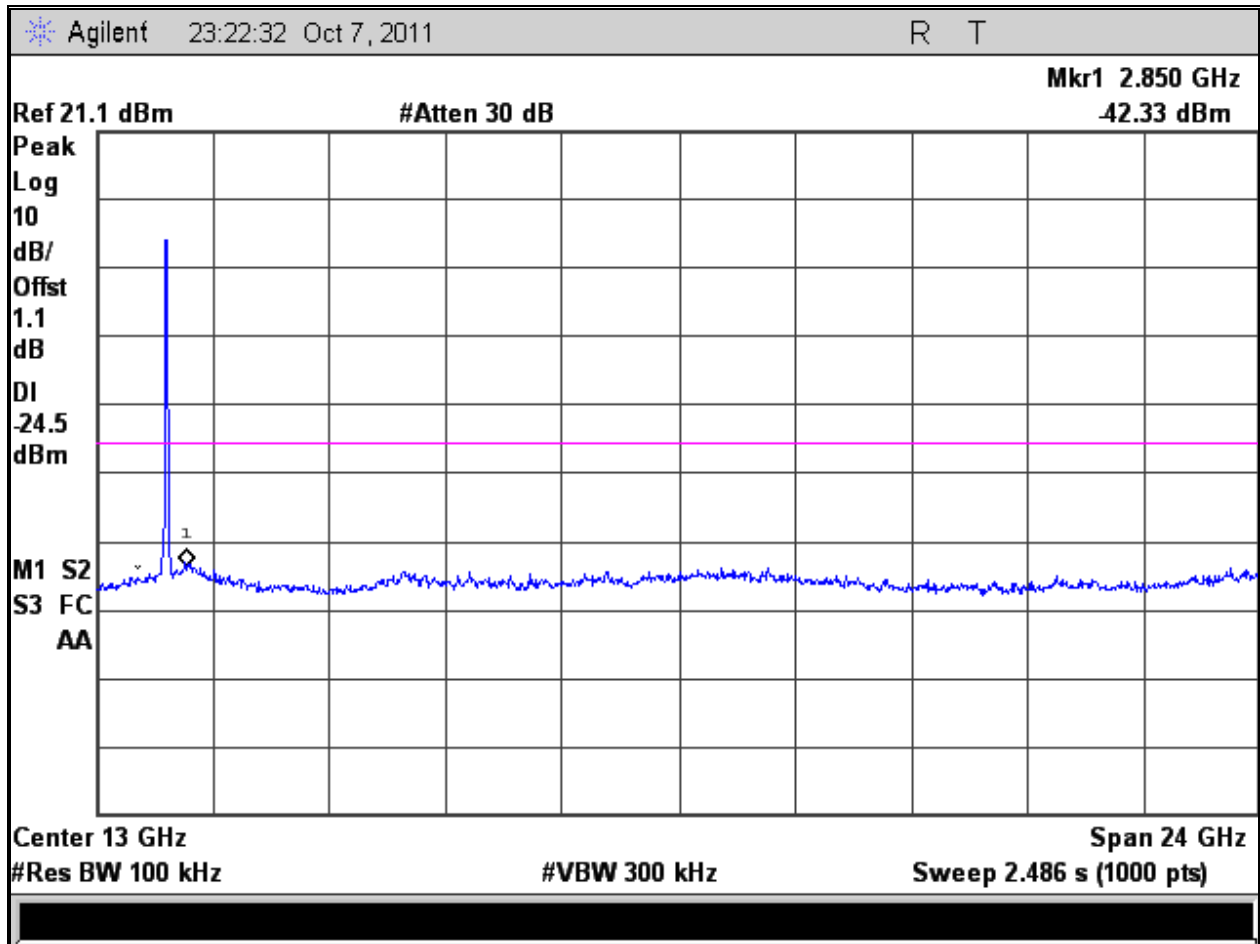

Figure 69: Out of Band Emission for Channel 2437 MHz at 13.5Mbit/s – Range 2

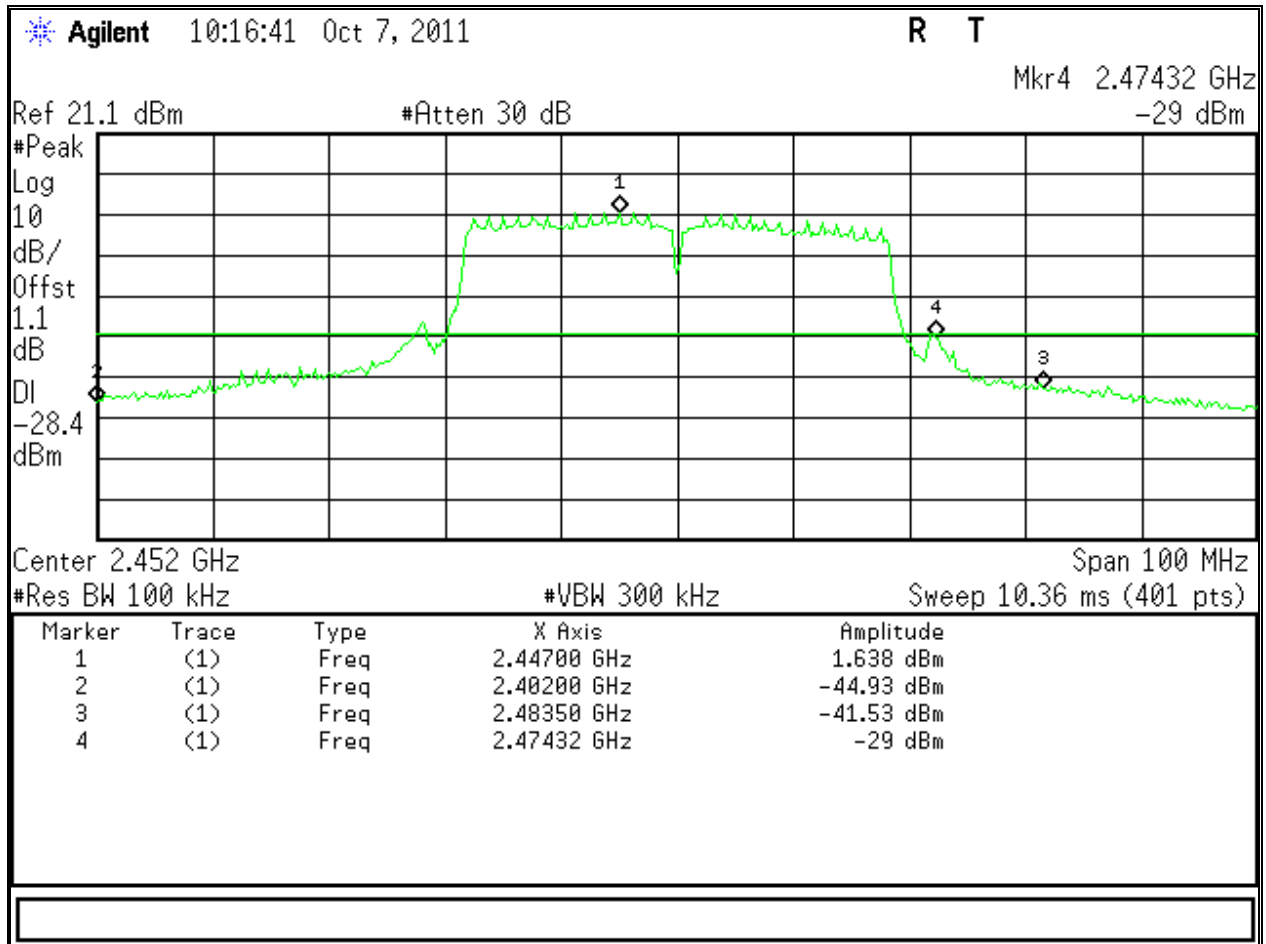

Figure 70: Band-edge Requirement at Operating Channel 2452 MHz, 13.5MBit/s

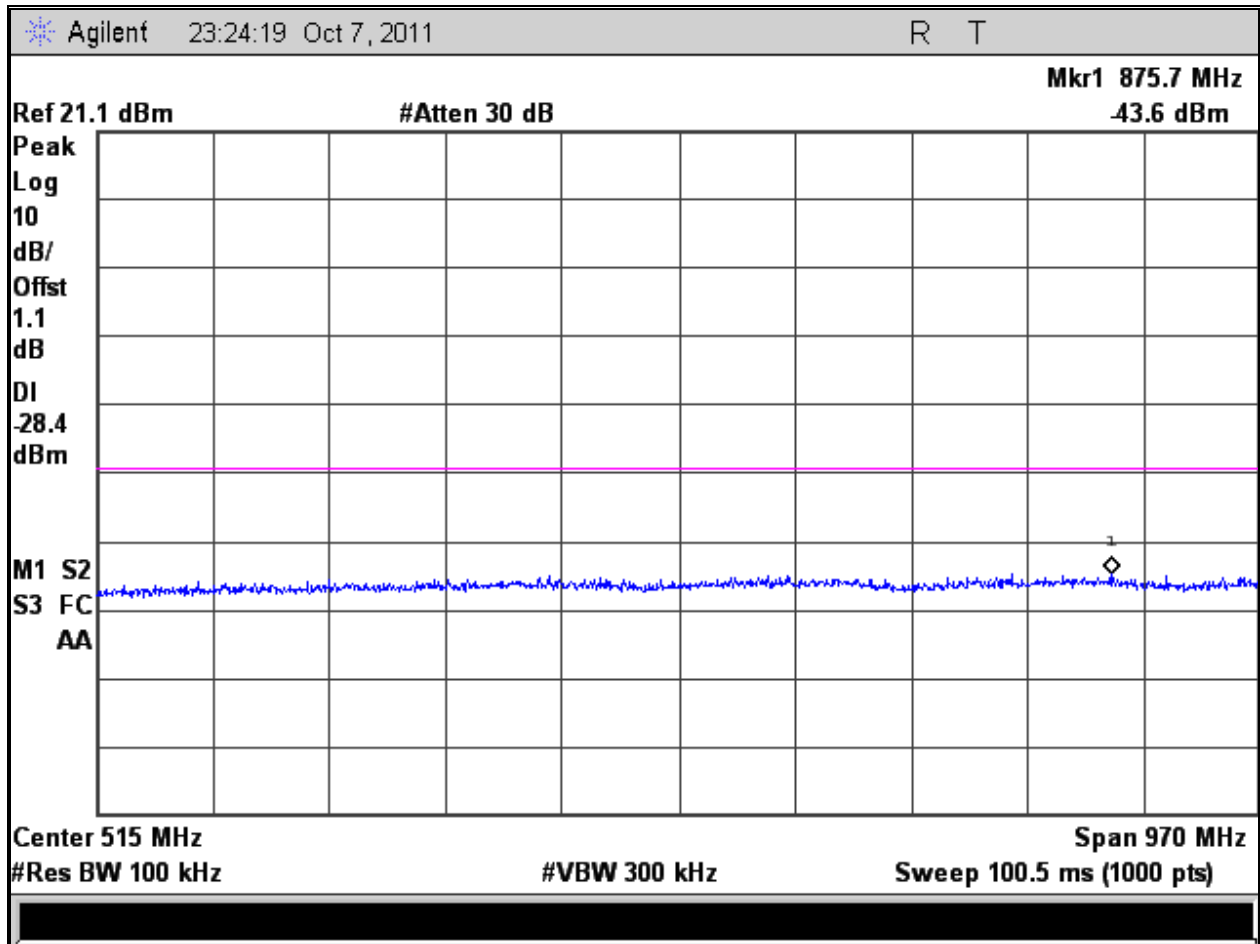

Figure 71: Out of Band Emission for Channel 2452 MHz at 13.5Mbit/s – Range 1

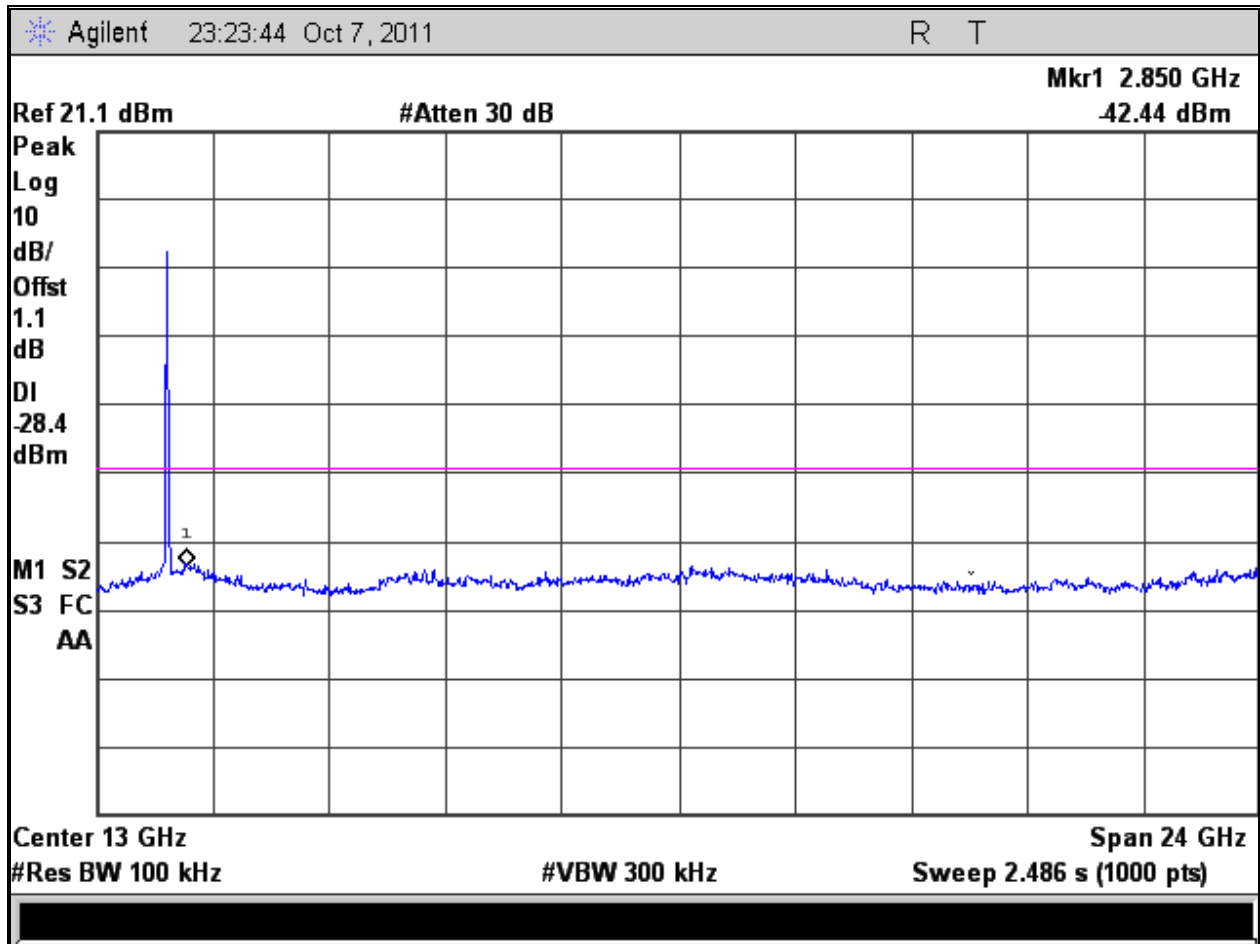

Figure 72: Out of Band Emission for Channel 2452 MHz at 13.5Mbit/s – Range 2

4.4 Peak Power Spectral Density

According to the CFR47 Part 15.247 (e) and RSS 210 (A8.2), the spectral power density output of the antenna port shall be less than 8dBm in any 3kHz band during any time interval of continuous transmission.

4.4.1 Test Method

The conducted method was used to measure the channel power output per ANSI C63.10:2009 Section 6.11.2. The measurement was performed with modulation per CFR47 Part 15.247 (e) and RSS 210 (A8.2). This test was conducted on 3 channels of Sample SN 31104000521. The worst sample result indicated below.

Test Setup:

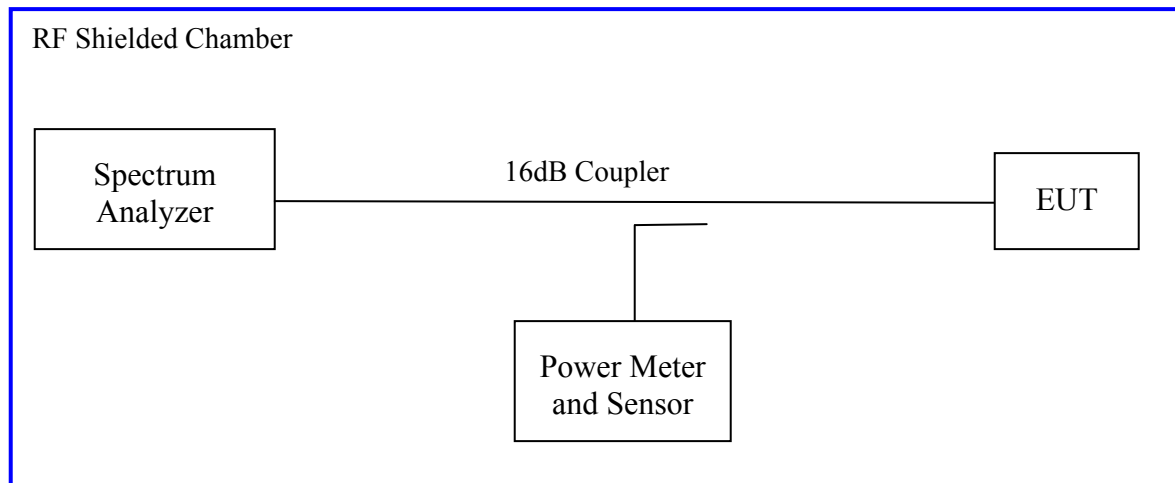

4.4.2 Results

As originally tested, the EUT was found to be compliant to the requirements of the test standard(s).

Table 8: Peak Power Spectral Density – Test Results

Test Conditions: Conducted Measurement, Normal Temperature and Voltage only							
Antenna Type: Integrated				Power Setting: See test plan			
Max. Antenna Gain: + 2.6dBi				Signal State: Modulated			
Ambient Temp.: 21 °C				Relative Humidity: 39%			
Peak Power Spectral Density							
Freq. (MHz)	Mode	Chain 0 [dBm]	Chain 1 [dBm]	CF [dB]	Max. PPSD [dBm]	Limit [dBm]	Margin [dB]
2412	1Mbps	1.459				8.00	-6.54
2437	1Mbps	3.813				8.00	-4.19
2462	1Mbps	2.194				8.00	-5.81
2412	6 Mbps	-5.908				8.00	-13.91
2437	6 Mbps	-1.011				8.00	-9.01
2462	6 Mbps	-6.616				8.00	-14.62
2412	HT20 6.5 Mbps	-6.531				8.00	-14.53
2437	HT20 6.5 Mbps	-0.628				8.00	-8.63
2462	HT20 6.5 Mbps	-6.428				8.00	-14.43
2412	HT20 13 Mbps	-8.373	-9.48	3.01	-2.87	8.00	-10.87
2437	HT20 13 Mbps	-3.910	-6.005	3.01	1.19	8.00	-6.81

2462	HT20 13 Mbps	-8.983	-10.000	3.01	-3.44	8.00	-11.44
2422	HT40 13.5 Mbps	-12.050				8.00	-20.05
2437	HT40 13.5 Mbps	-8.815				8.00	-16.82
2452	HT40 13.5 Mbps	-11.870				8.00	-19.87
2422	HT40 27 Mbps	-10.650	-11.69	3.01	-5.12	8.00	-13.12
2437	HT40 27 Mbps	-10.100	-8.655	3.01	-3.30	8.00	-11.30
2452	HT40 27 Mbps	-10.380	-11.42	3.01	-4.85	8.00	-12.85
<p>Note: CF was accounted for the number of data streams being used, $10 \cdot \log(N)$ per KDB 662911; where N is number of outputs.</p>							

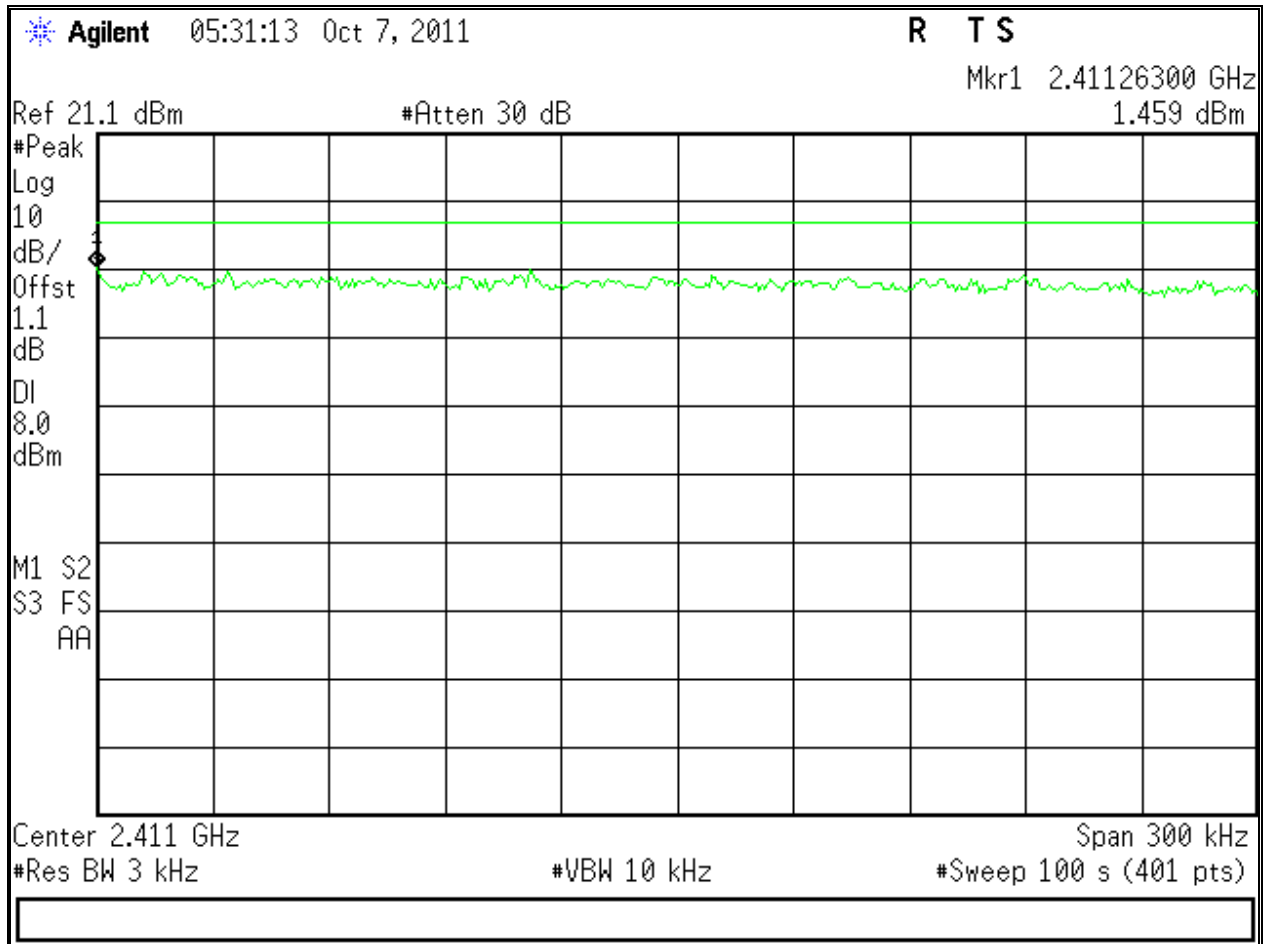

Figure 73: Peak Power Spectral Density for Operating Channel 2412MHz, Ch 0 – 1Mbps

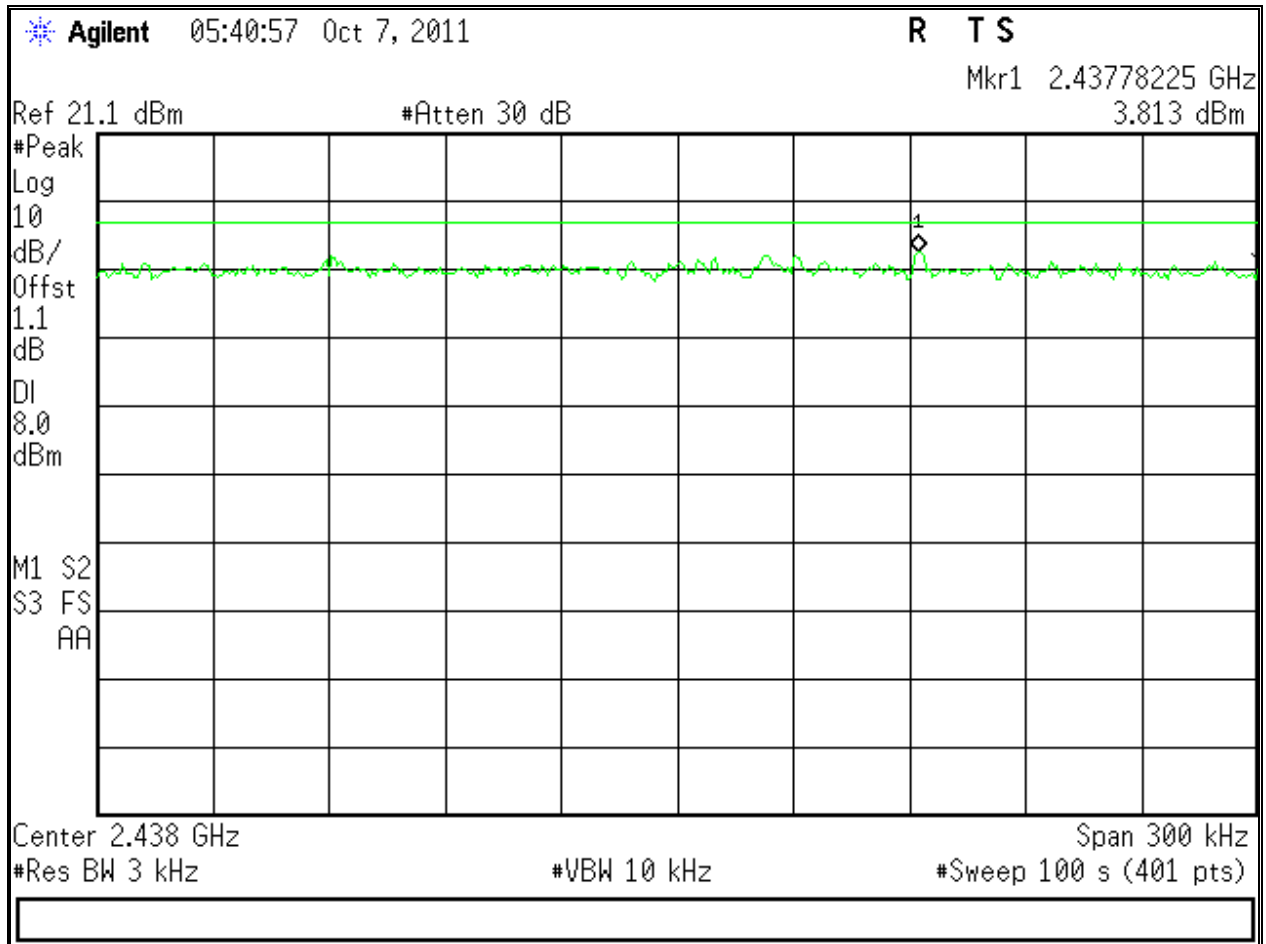

Figure 74: Peak Power Spectral Density for Operating Channel 2437MHz, Ch 0 – 1Mbps

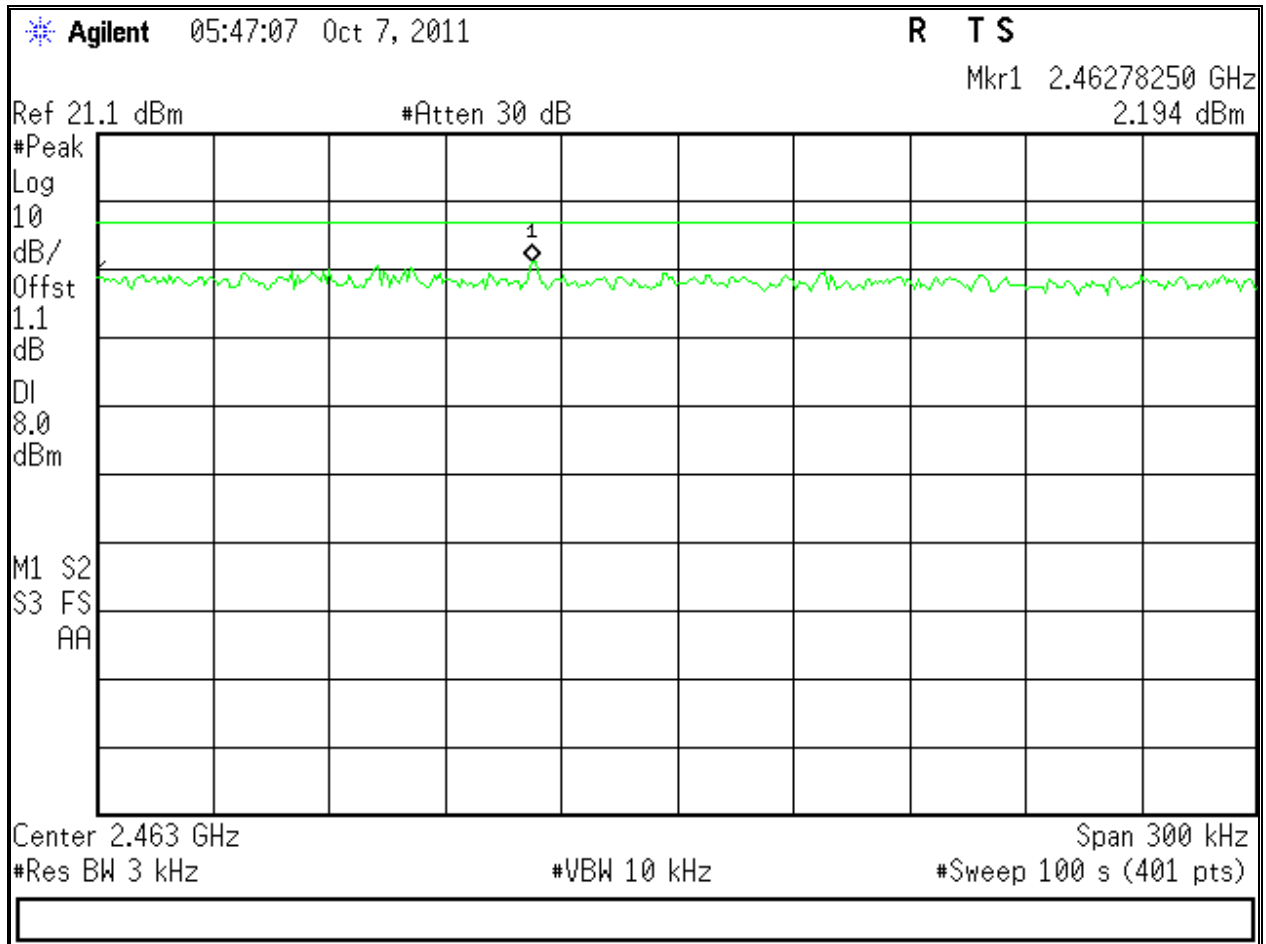

Figure 75: Peak Power Spectral Density for Operating Channel 2462MHz, Ch 0 – 1Mbps

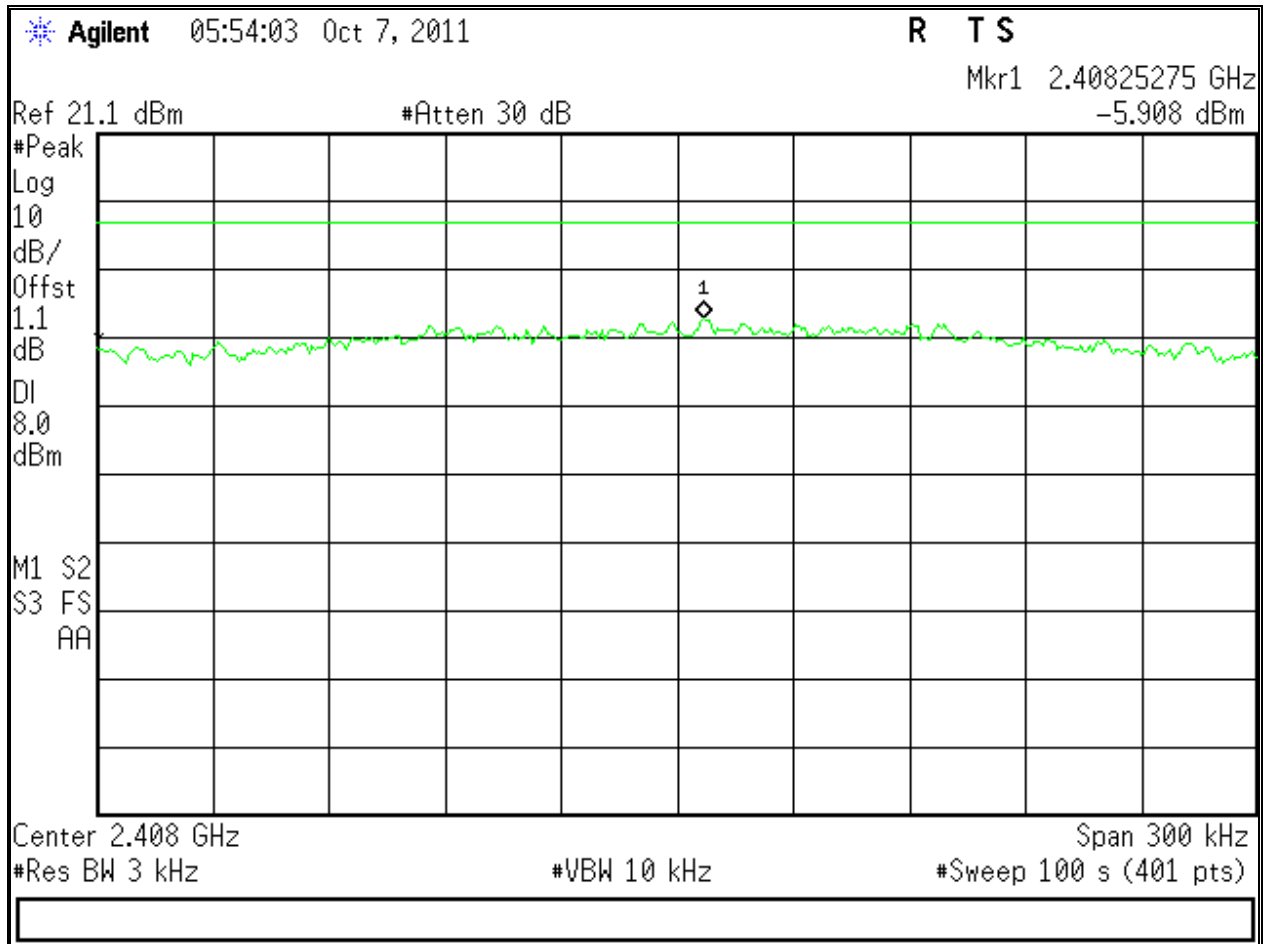

Figure 76: Peak Power Spectral Density for Operating Channel 2412MHz, Ch 0 – 6Mbps

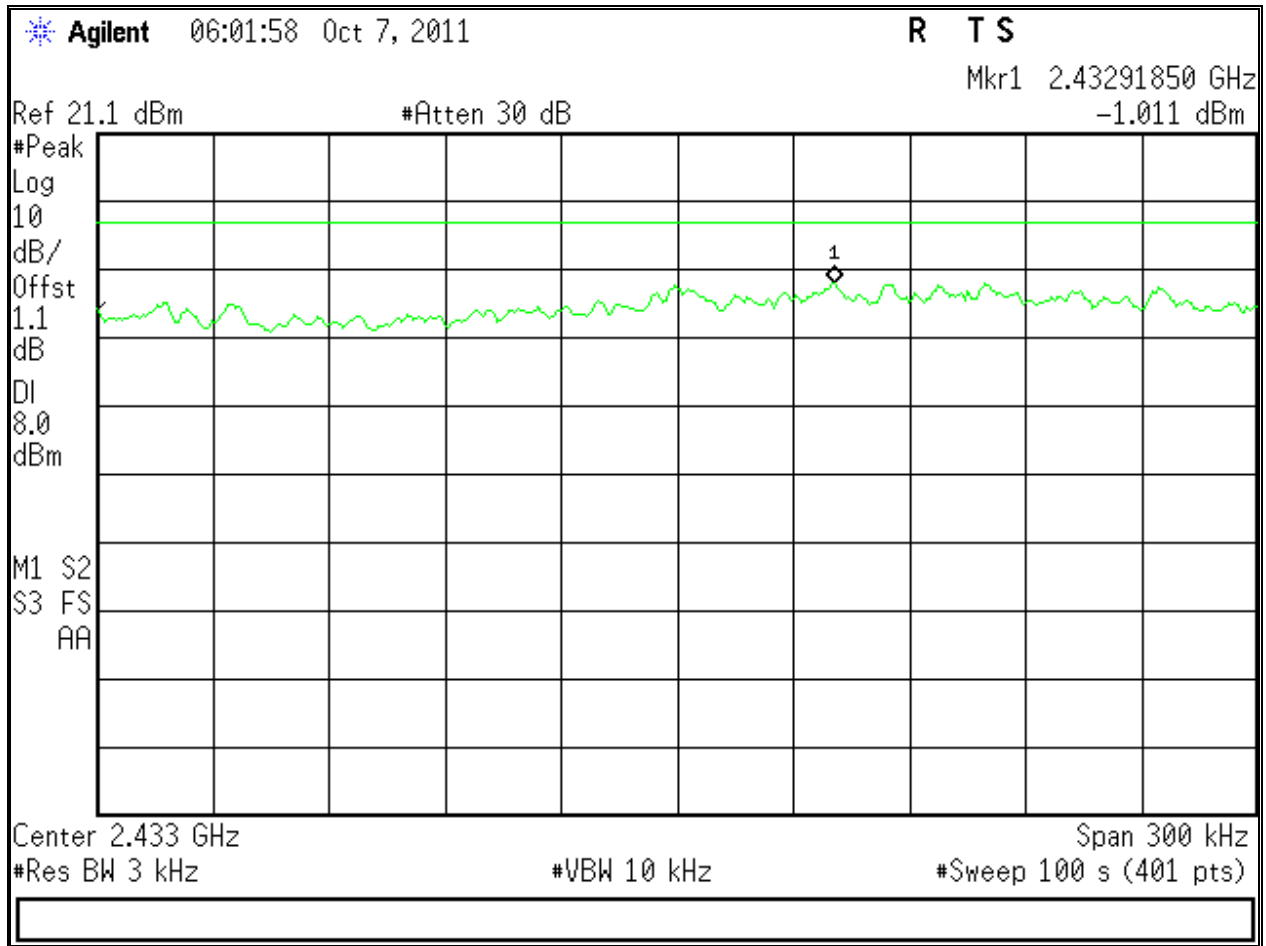

Figure 77: Peak Power Spectral Density for Operating Channel 2437MHz, Ch 0 – 6Mbps

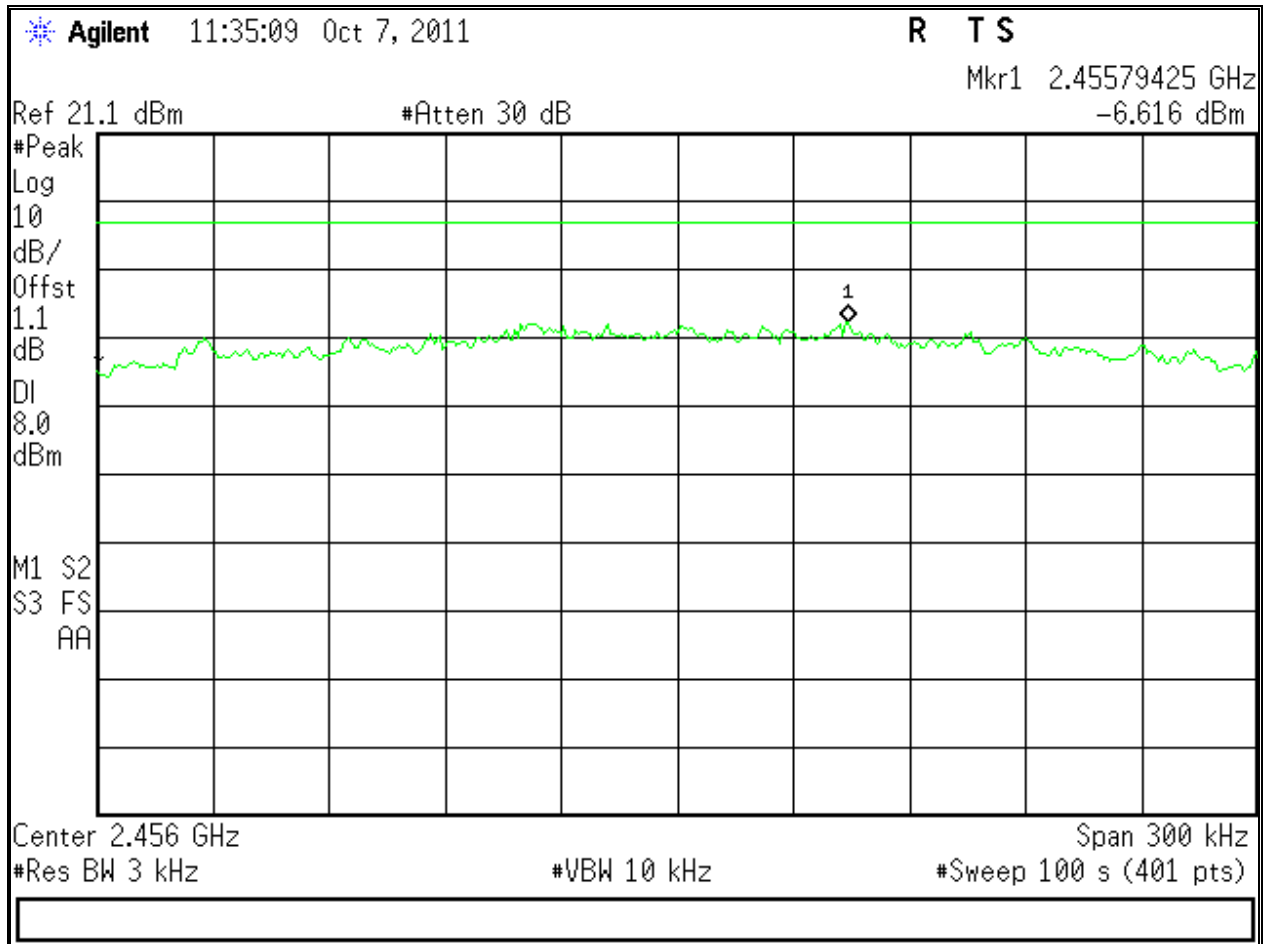

Figure 78: Peak Power Spectral Density for Operating Channel 2462MHz, Ch 0 – 6Mbps

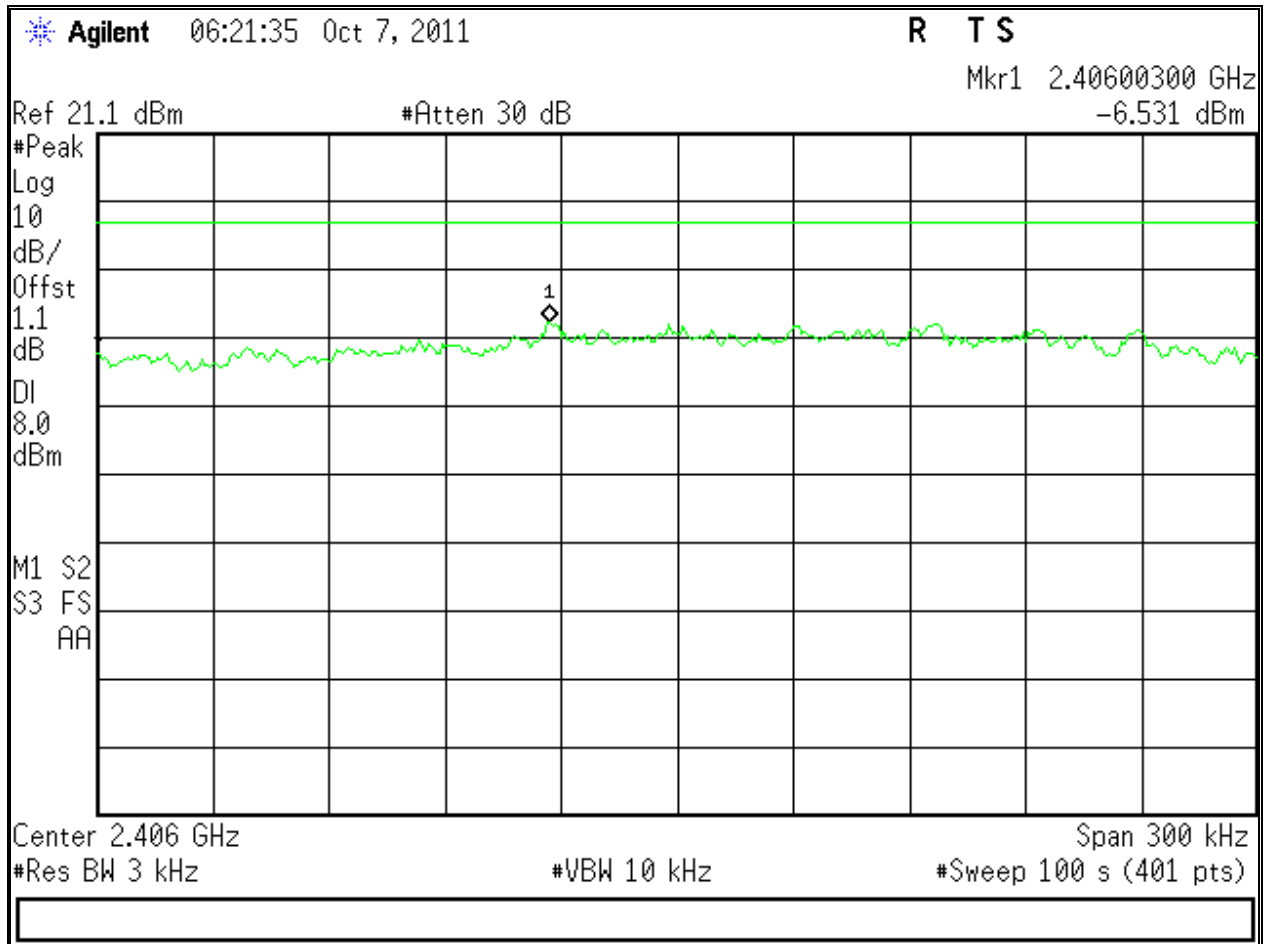

Figure 79: Peak Power Spectral Density for Operating Channel 2412MHz, Ch 0 – 6.5Mbps

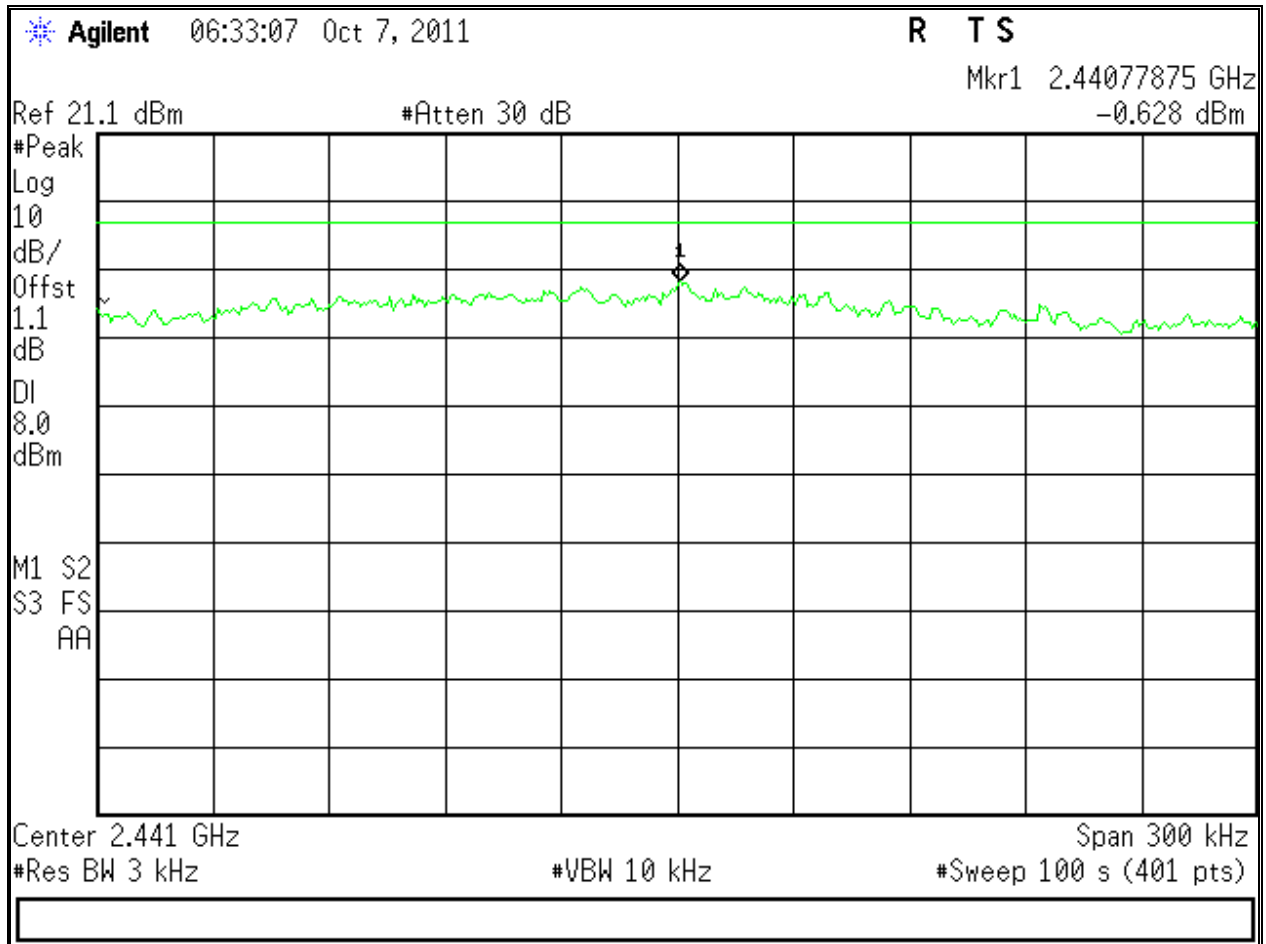

Figure 80: Peak Power Spectral Density for Operating Channel 2437MHz, Ch 0 – 6.5Mbps

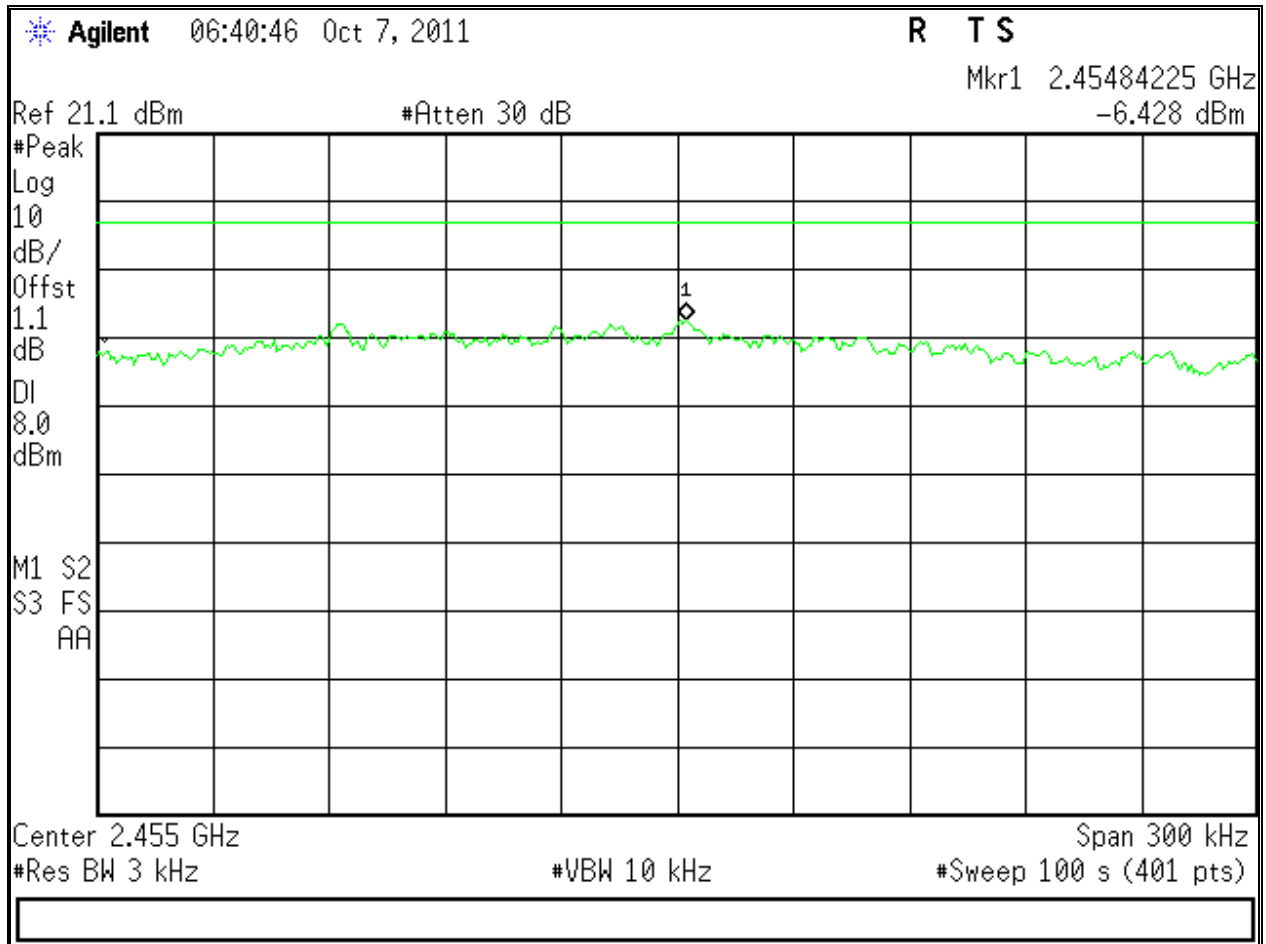

Figure 81: Peak Power Spectral Density for Operating Channel 2462MHz, Ch 0 – 6.5Mbps

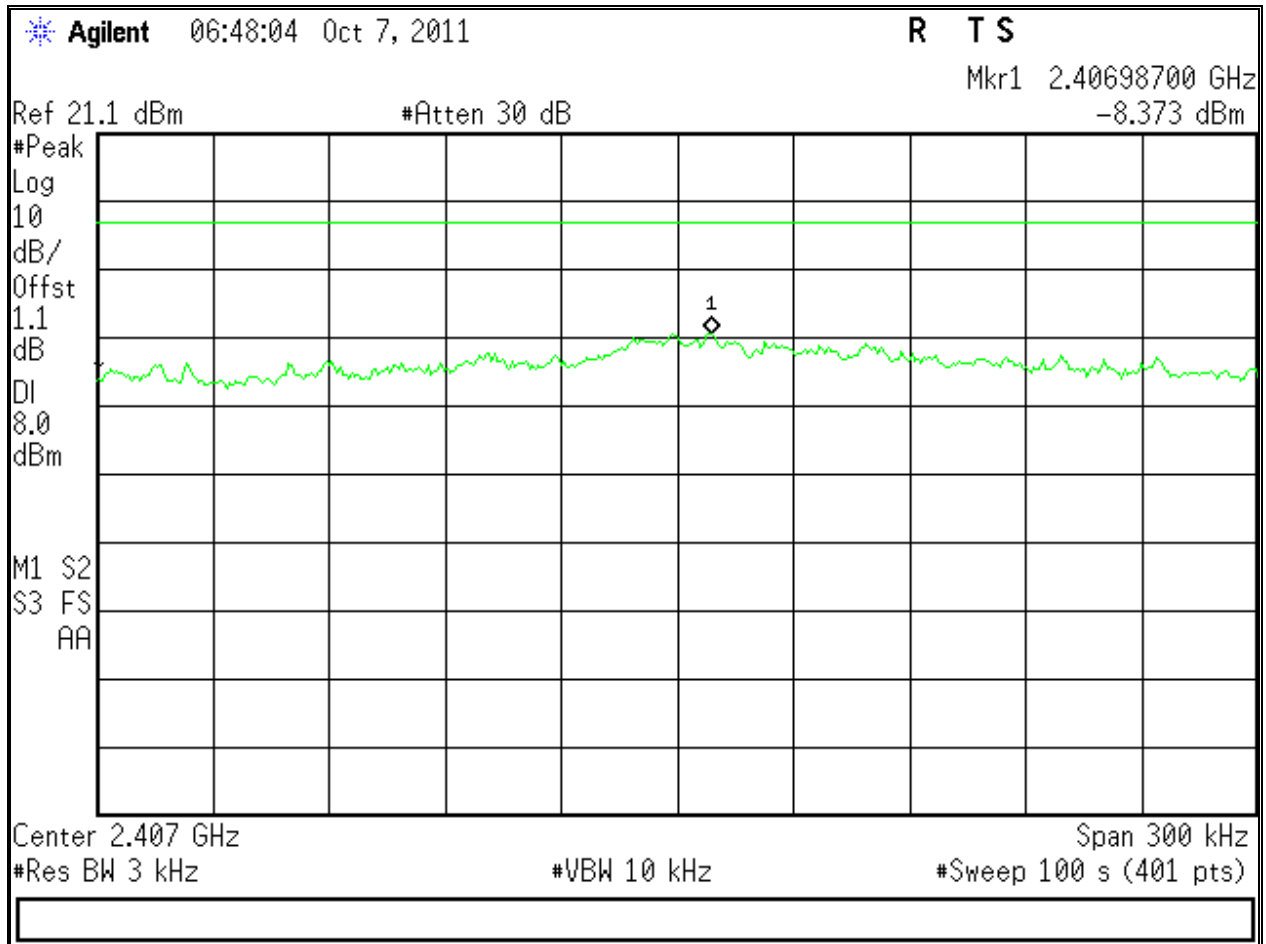

Figure 82: Peak Power Spectral Density for Operating Channel 2412MHz, Ch 0 – 13Mbps

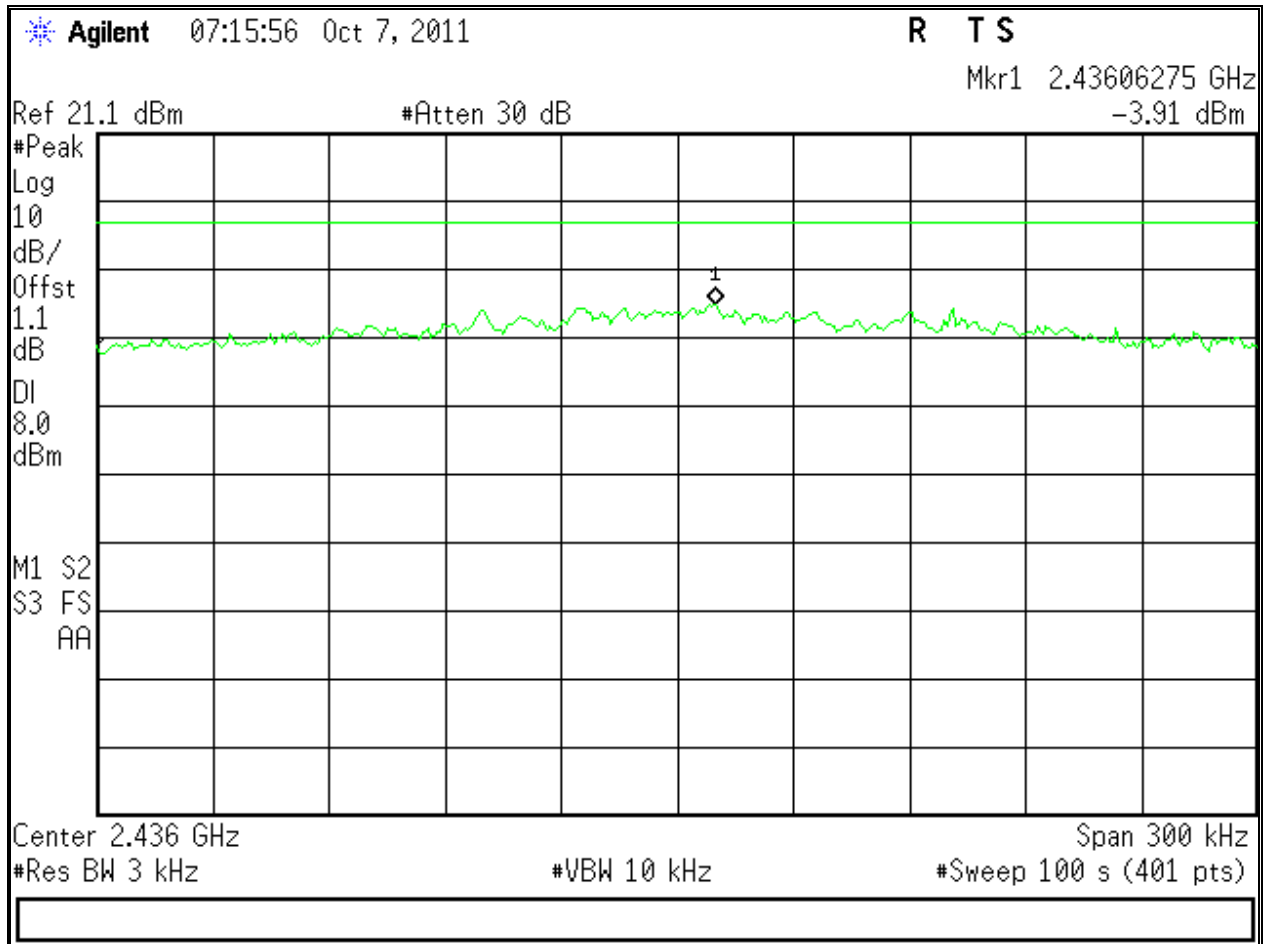

Figure 83: Peak Power Spectral Density for Operating Channel 2437MHz, Ch 0 – 13Mbps

Agilent 07:58:14 Oct 7, 2011

R T S

Mkr1 2.45888025 GHz
-8.983 dBm

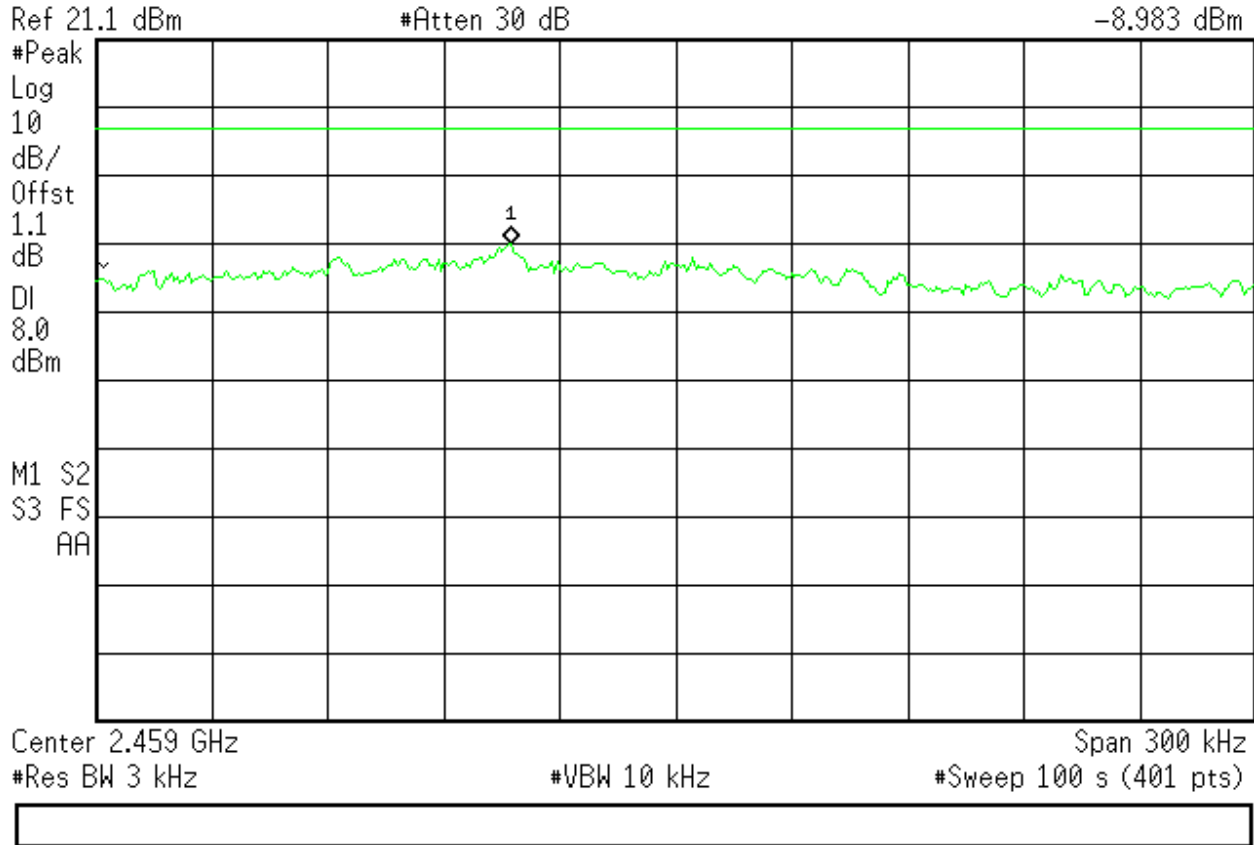

Figure 84: Peak Power Spectral Density for Operating Channel 2462MHz, Ch 0 – 13Mbps

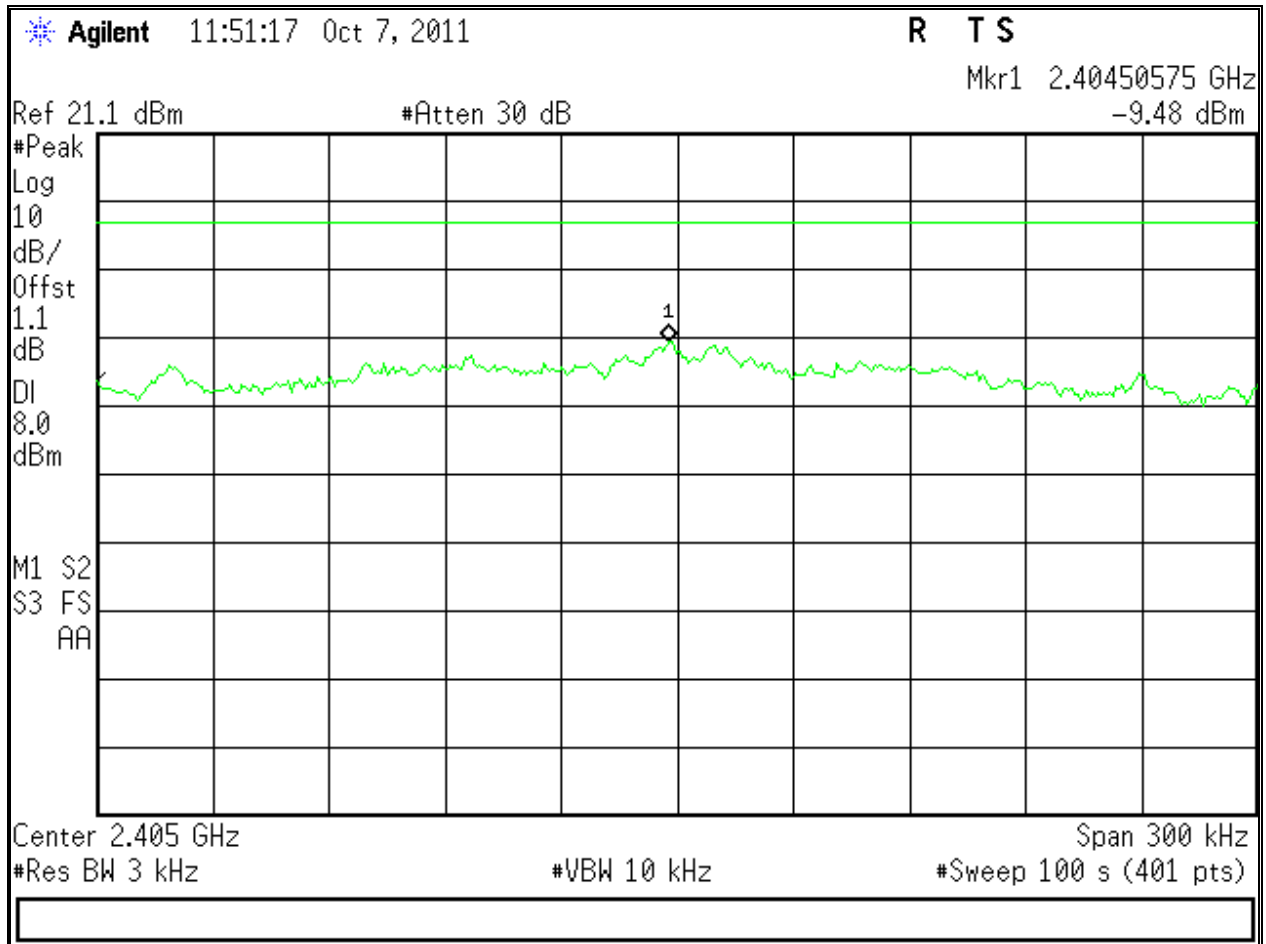

Figure 85: Peak Power Spectral Density for Operating Channel 2412MHz, Ch 1 – 13Mbps

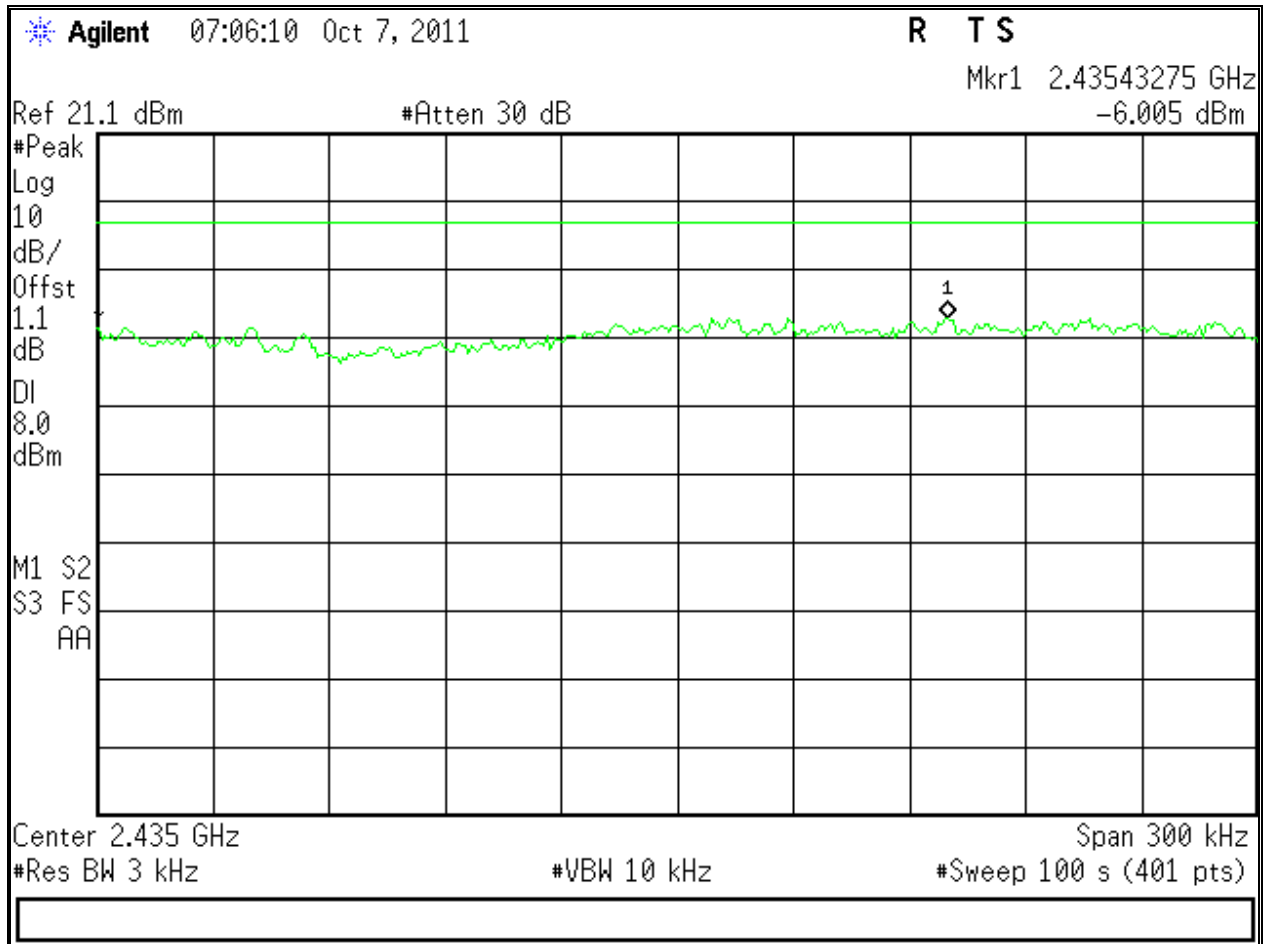

Figure 86: Peak Power Spectral Density for Operating Channel 2437MHz, Ch 1 – 13Mbps

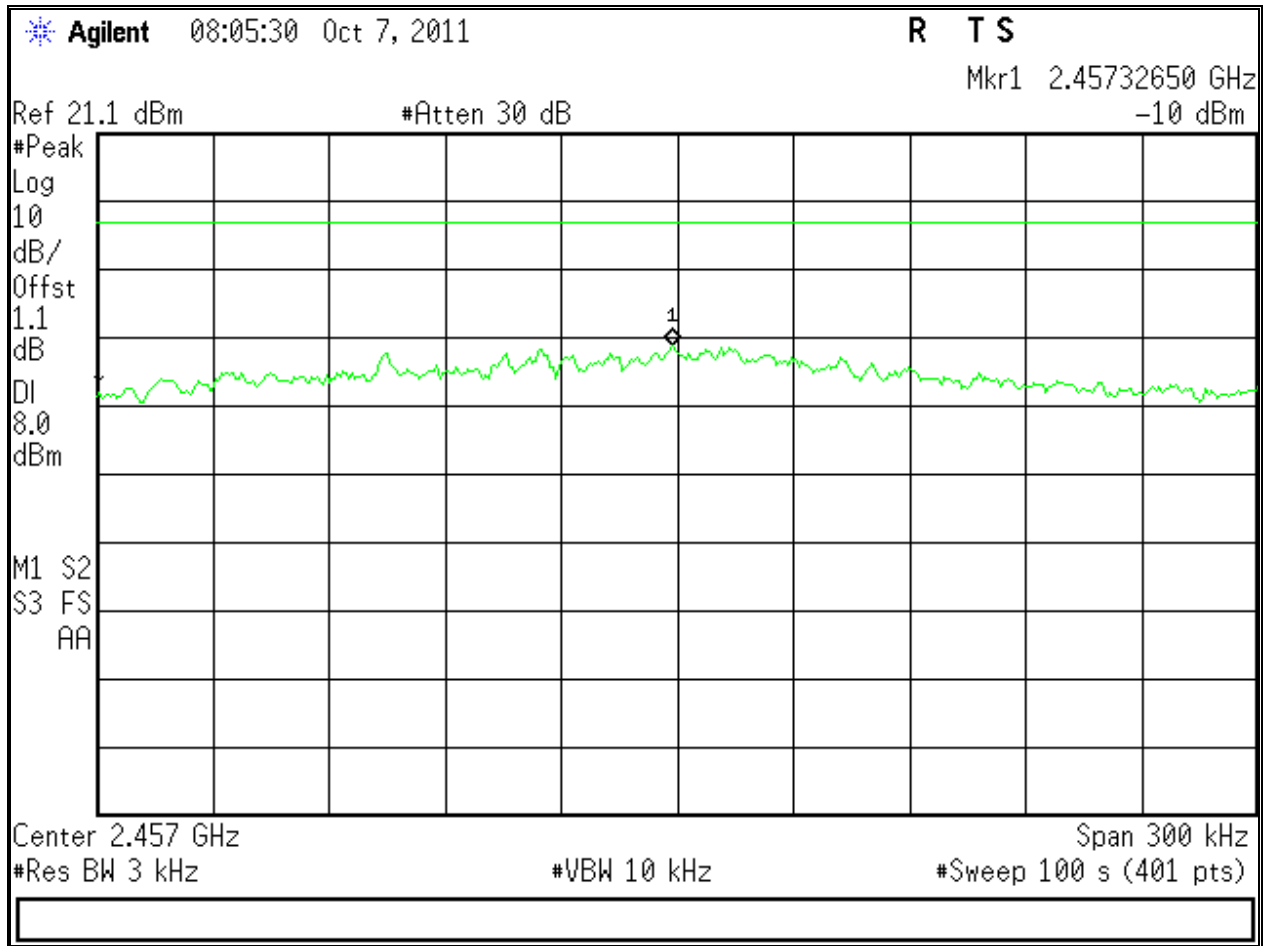

Figure 87: Peak Power Spectral Density for Operating Channel 2462MHz, Ch 1 – 13Mbps

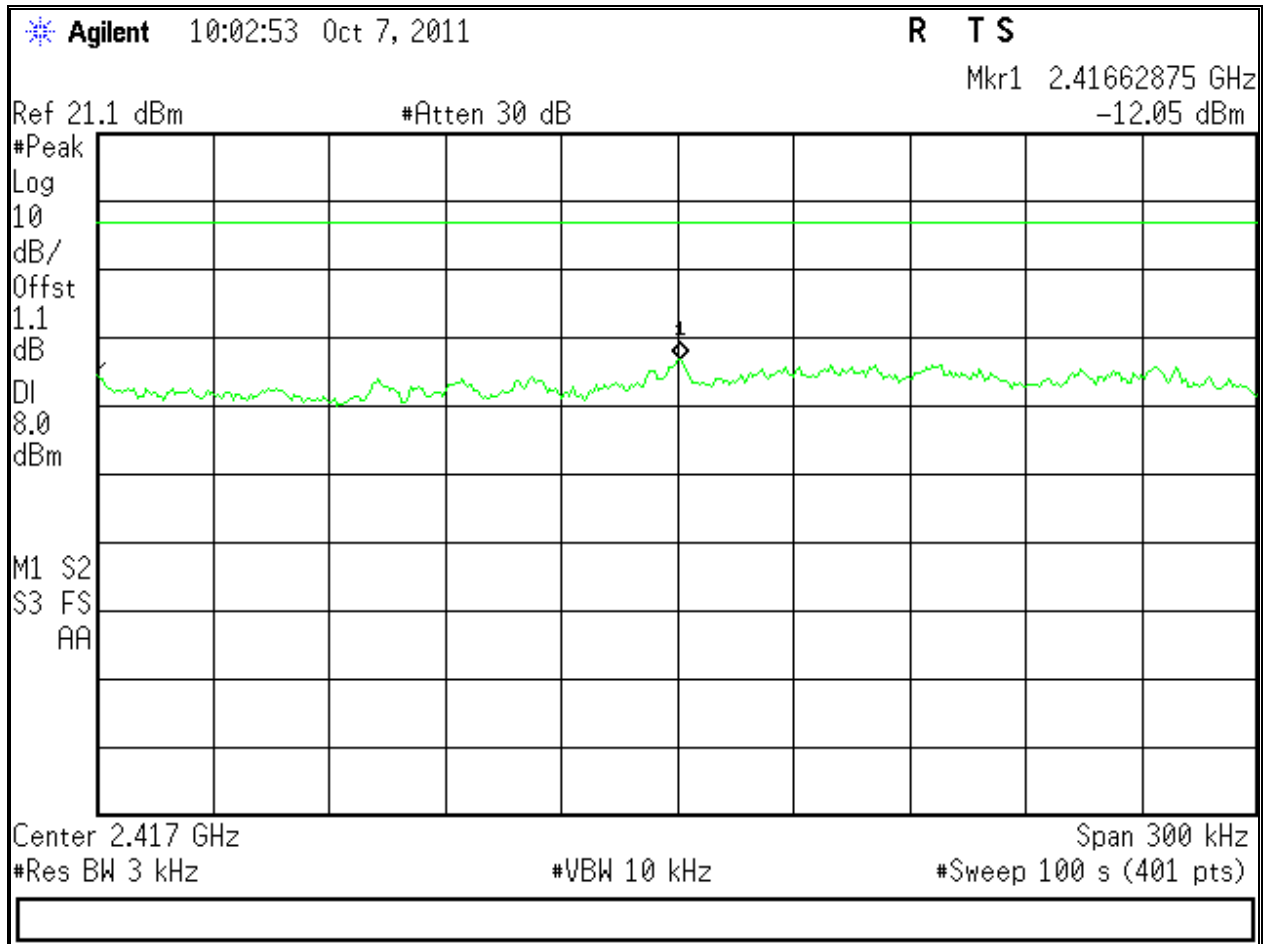

Figure 88: Peak Power Spectral Density for Operating Channel 2422MHz, Ch 0 – 13.5Mbps

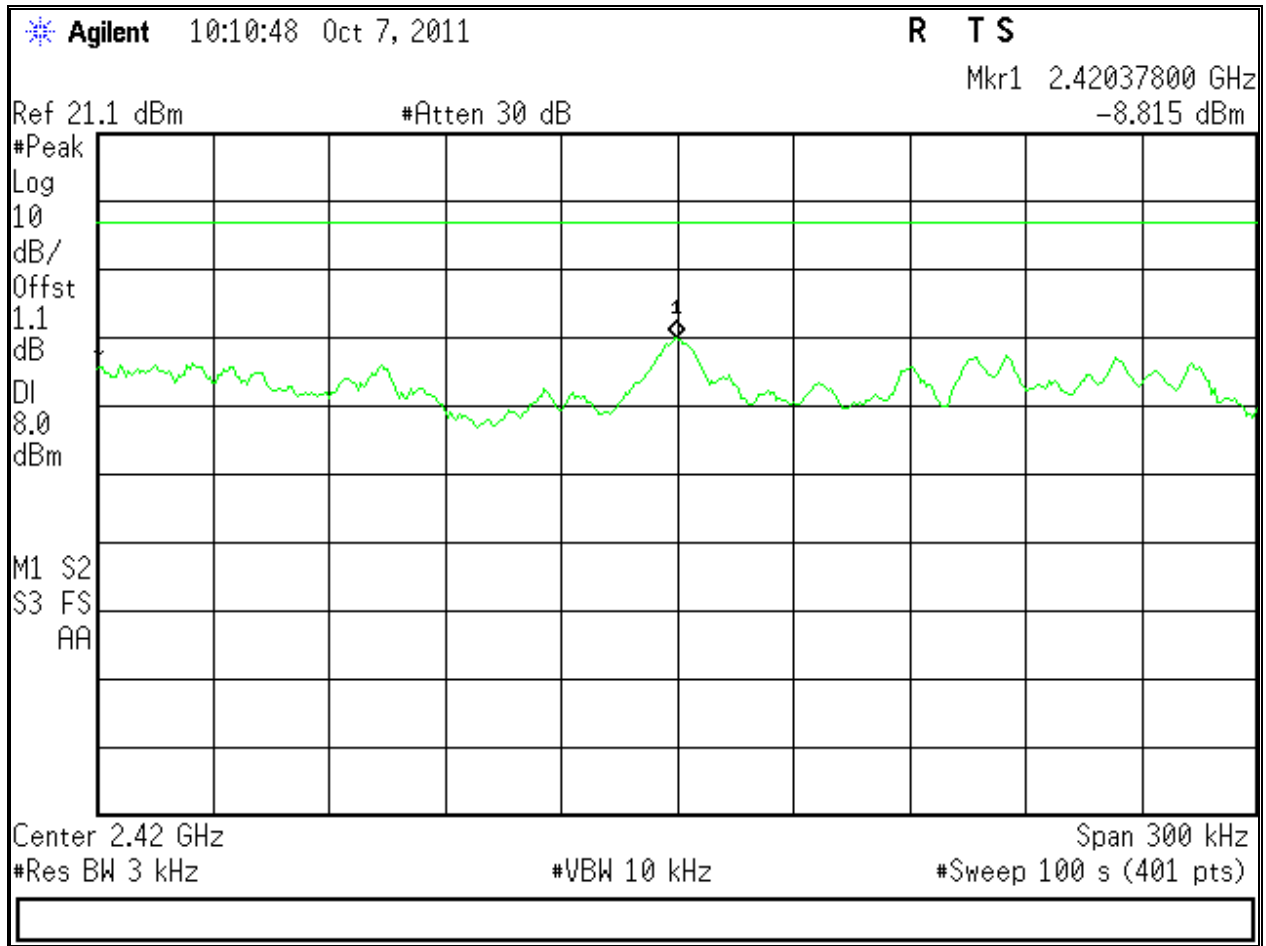

Figure 89: Peak Power Spectral Density for Operating Channel 2437MHz, Ch 0 – 13.5Mbps

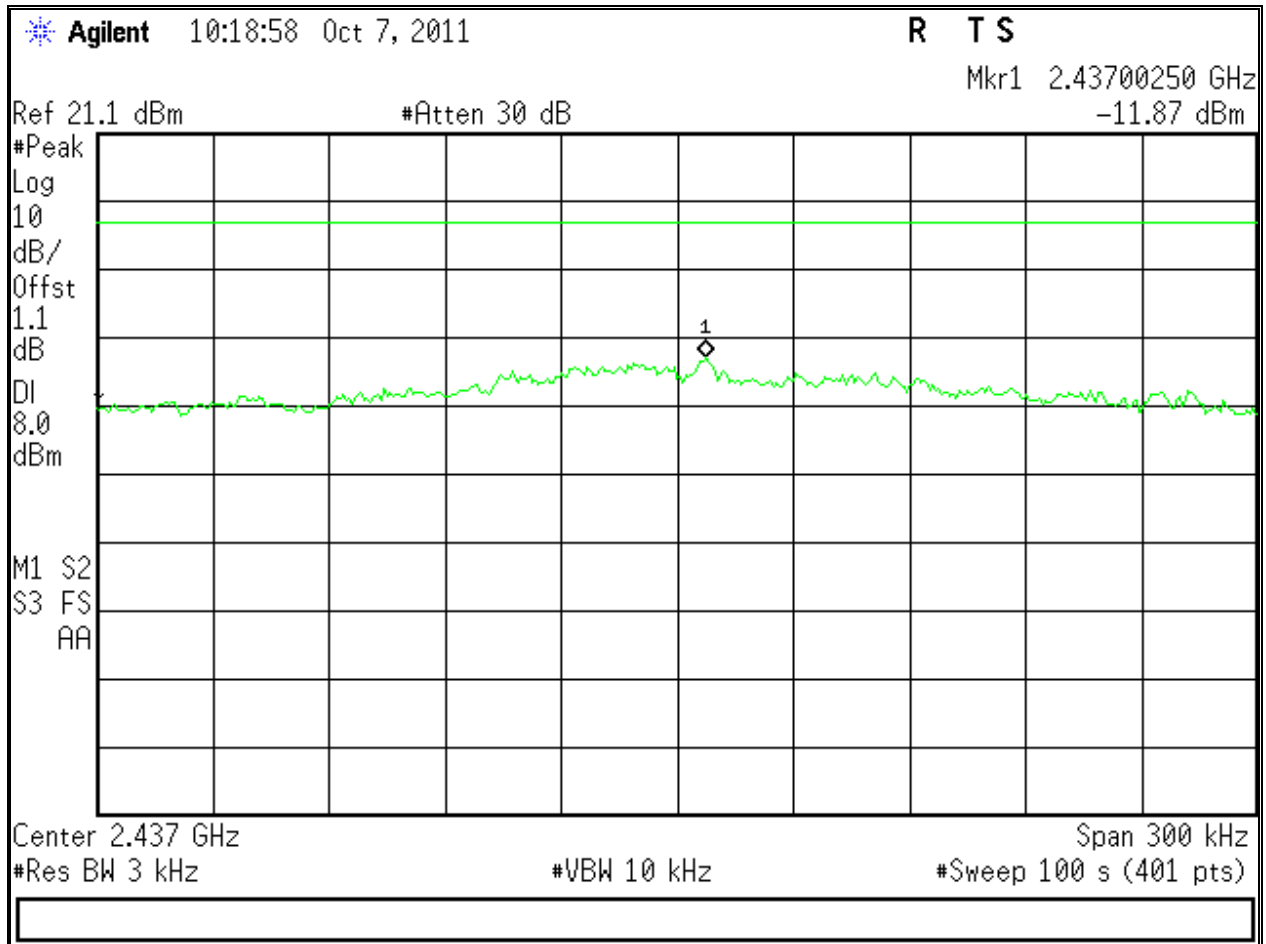

Figure 90: Peak Power Spectral Density for Operating Channel 2452MHz, Ch 0 – 13.5Mbps

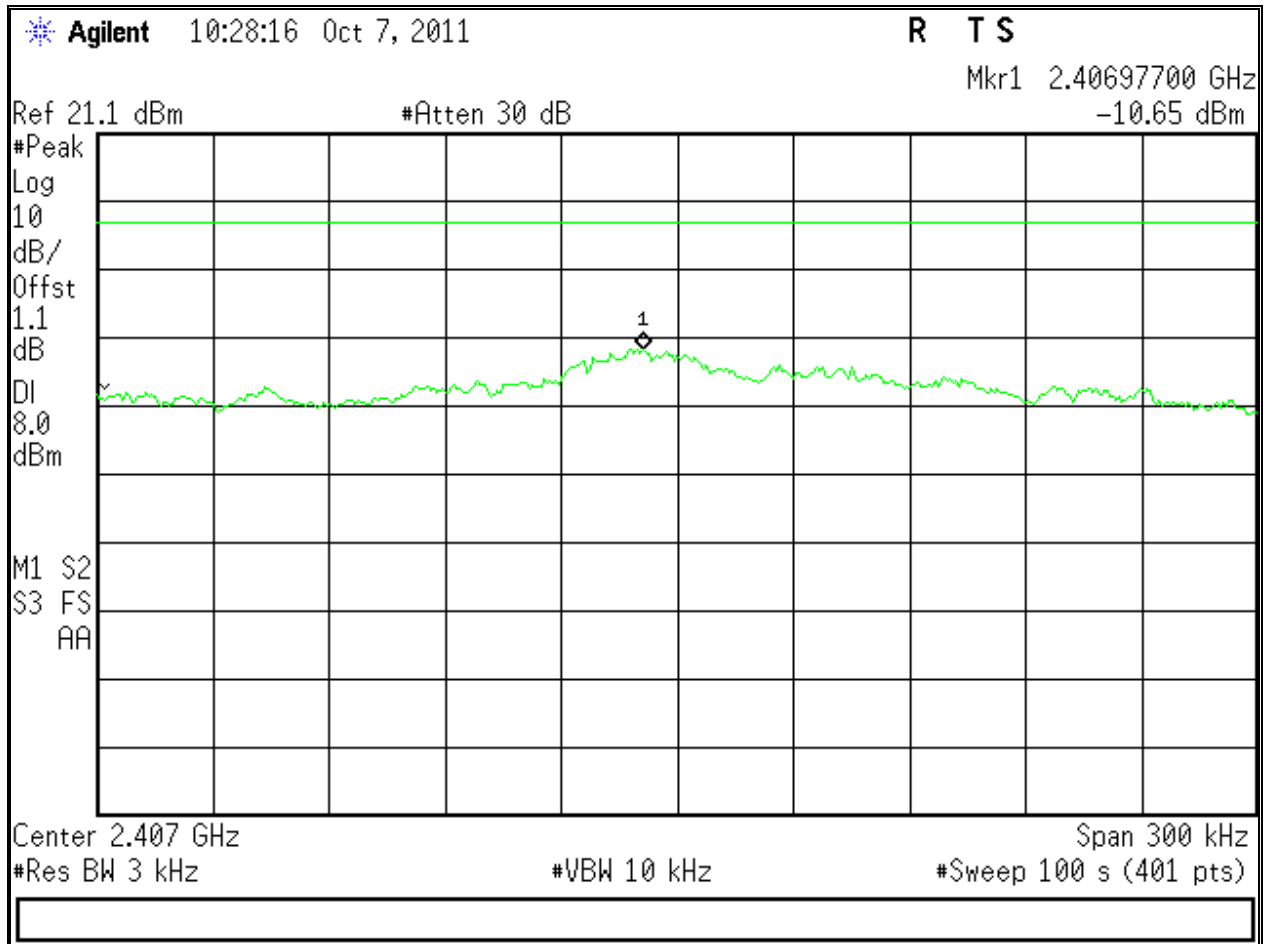

Figure 91: Peak Power Spectral Density for Operating Channel 2422MHz, Ch 0 – 27Mbps

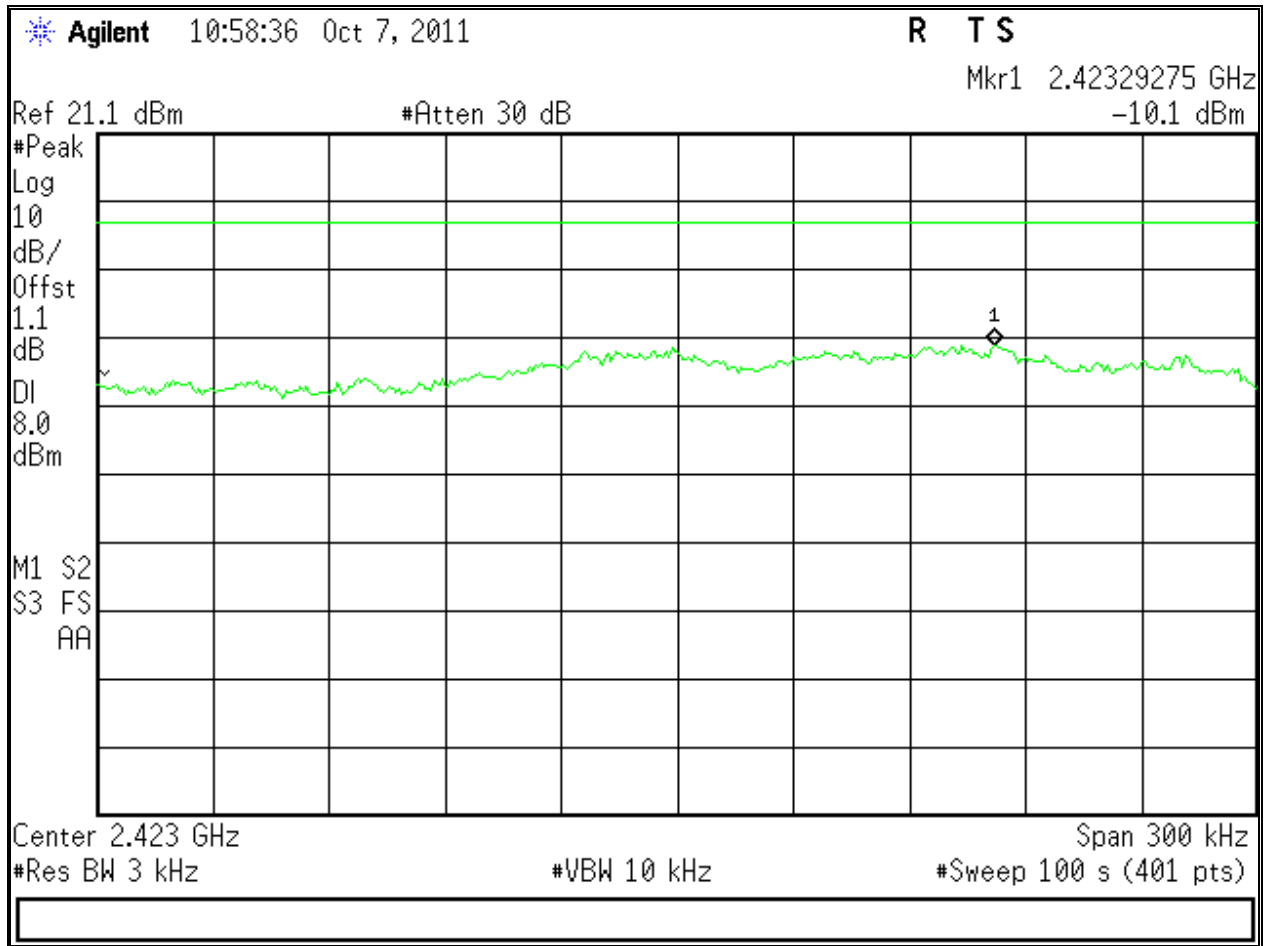

Figure 92: Peak Power Spectral Density for Operating Channel 2437MHz, Ch 0 – 27Mbps

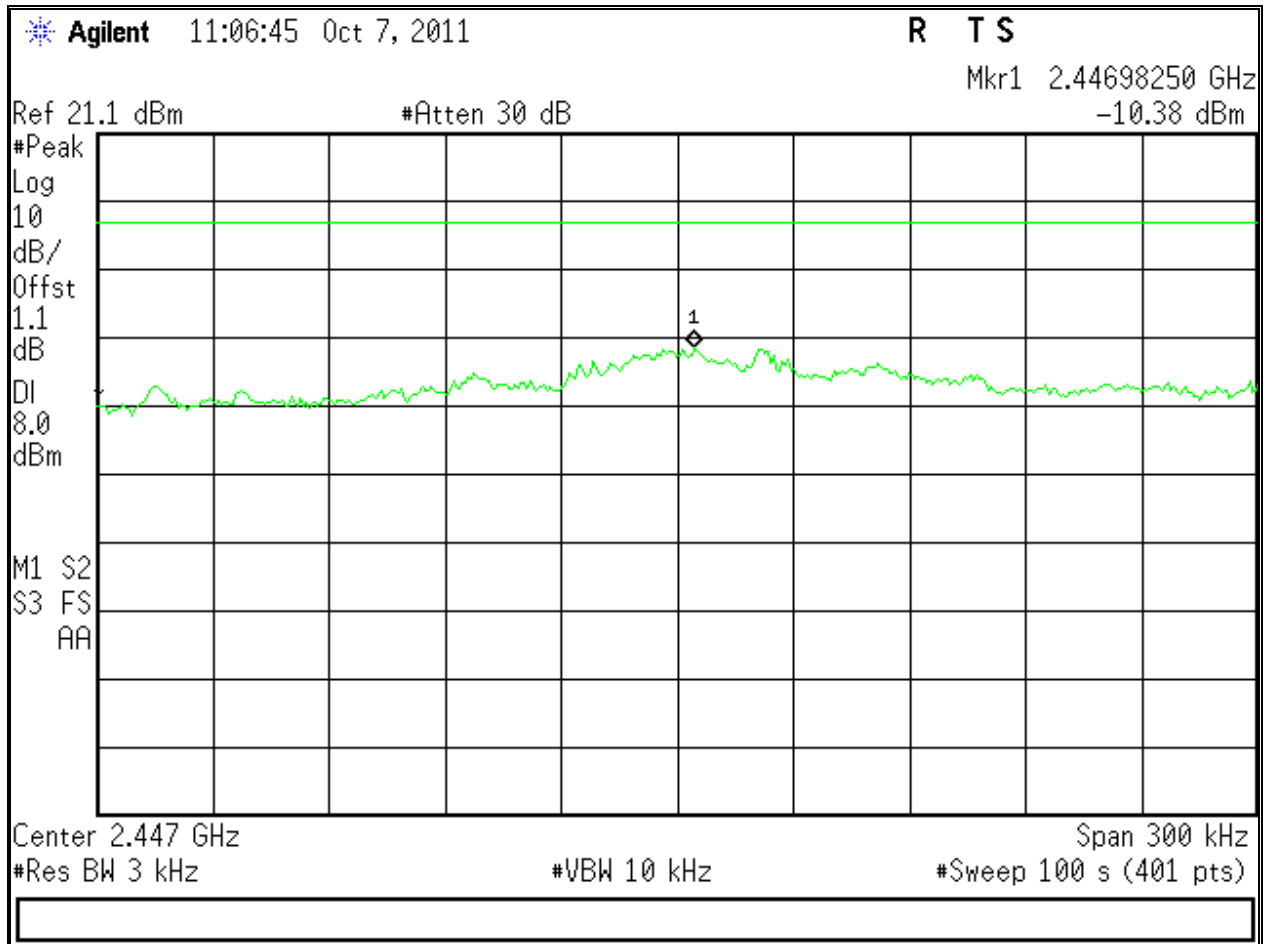

Figure 93: Peak Power Spectral Density for Operating Channel 2452MHz, Ch 0 – 27Mbps

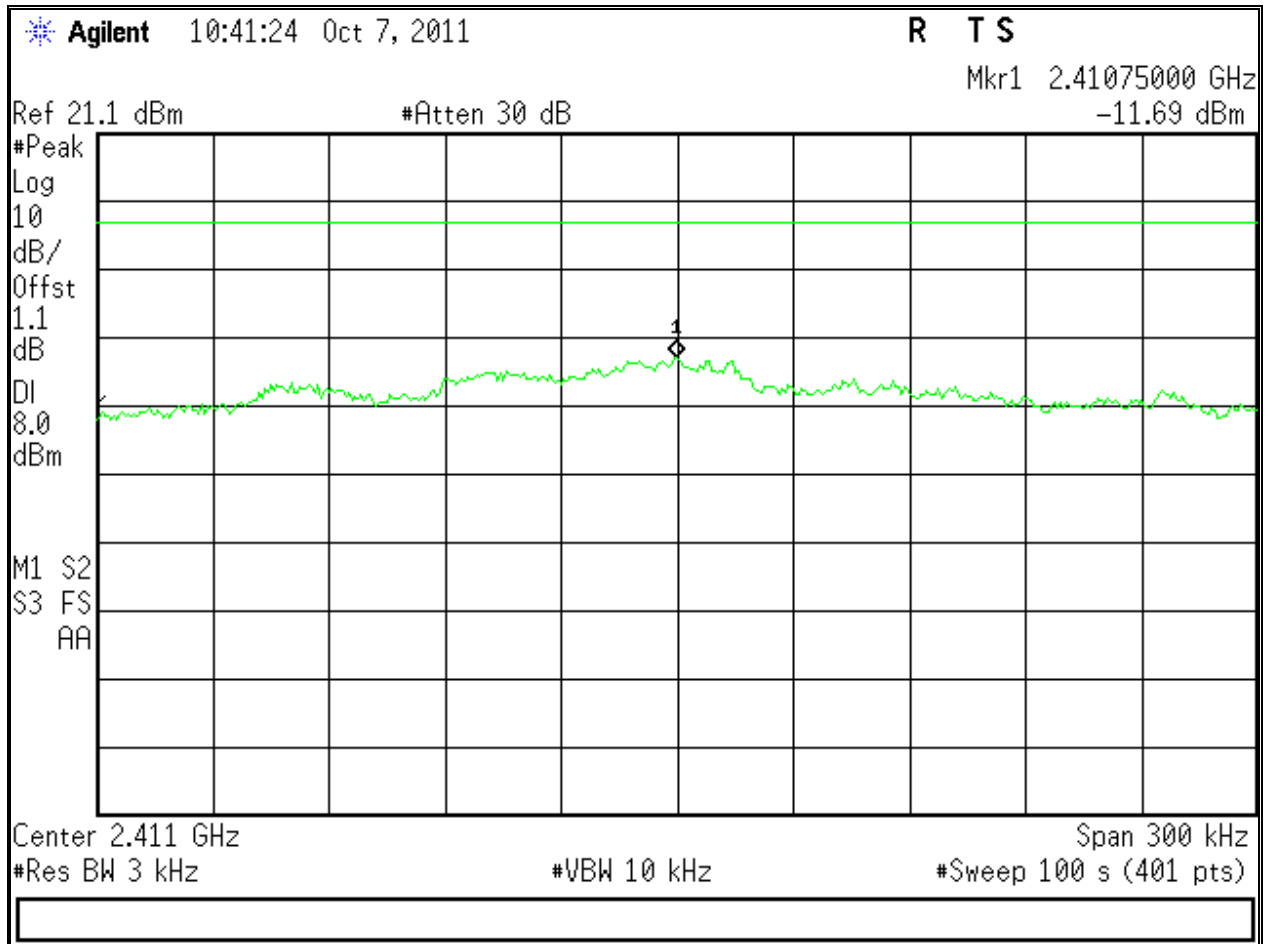

Figure 94: Peak Power Spectral Density for Operating Channel 2422MHz, Ch 1 – 27Mbps

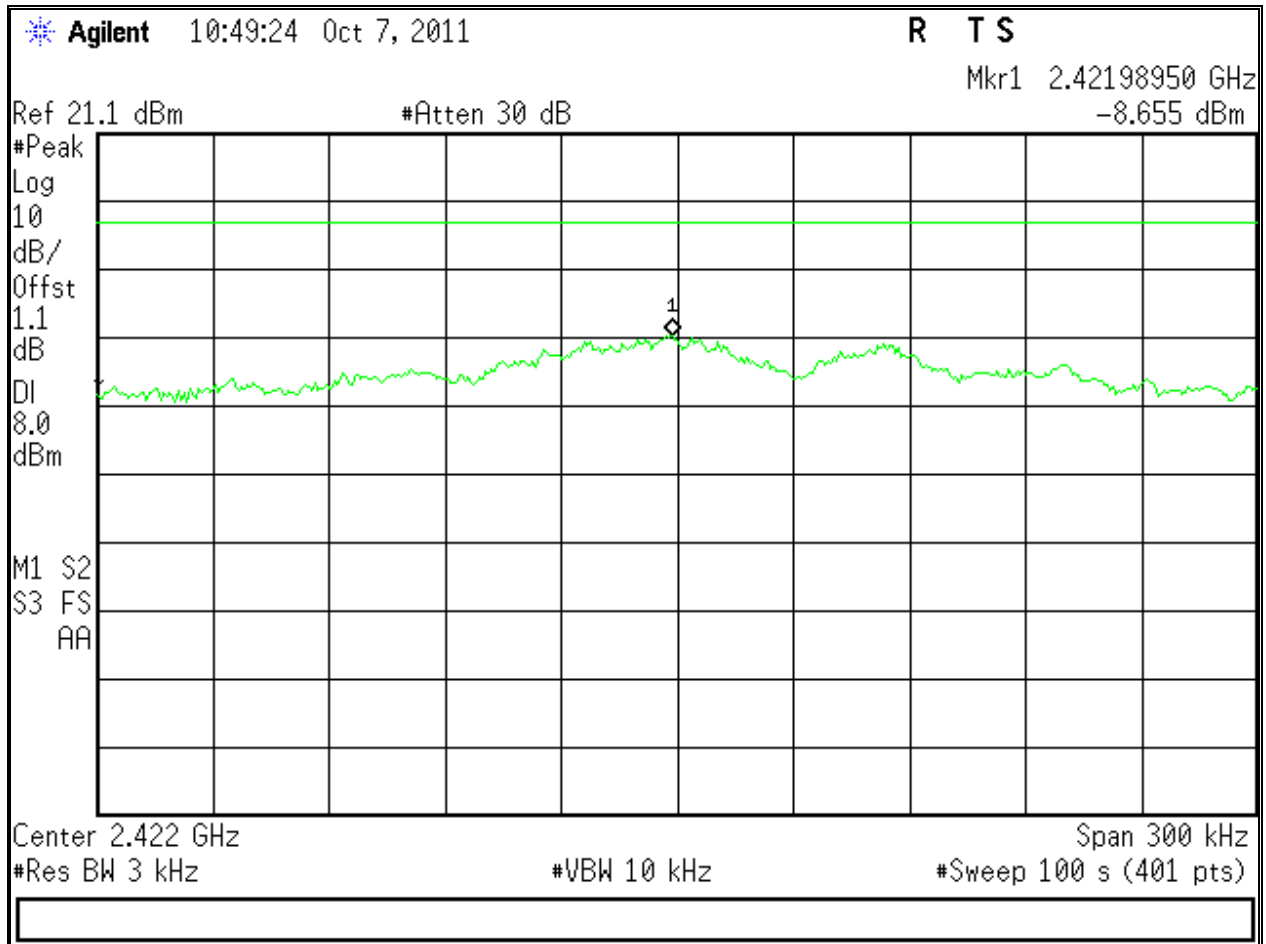

Figure 95: Peak Power Spectral Density for Operating Channel 2437MHz, Ch 1 – 27Mbps

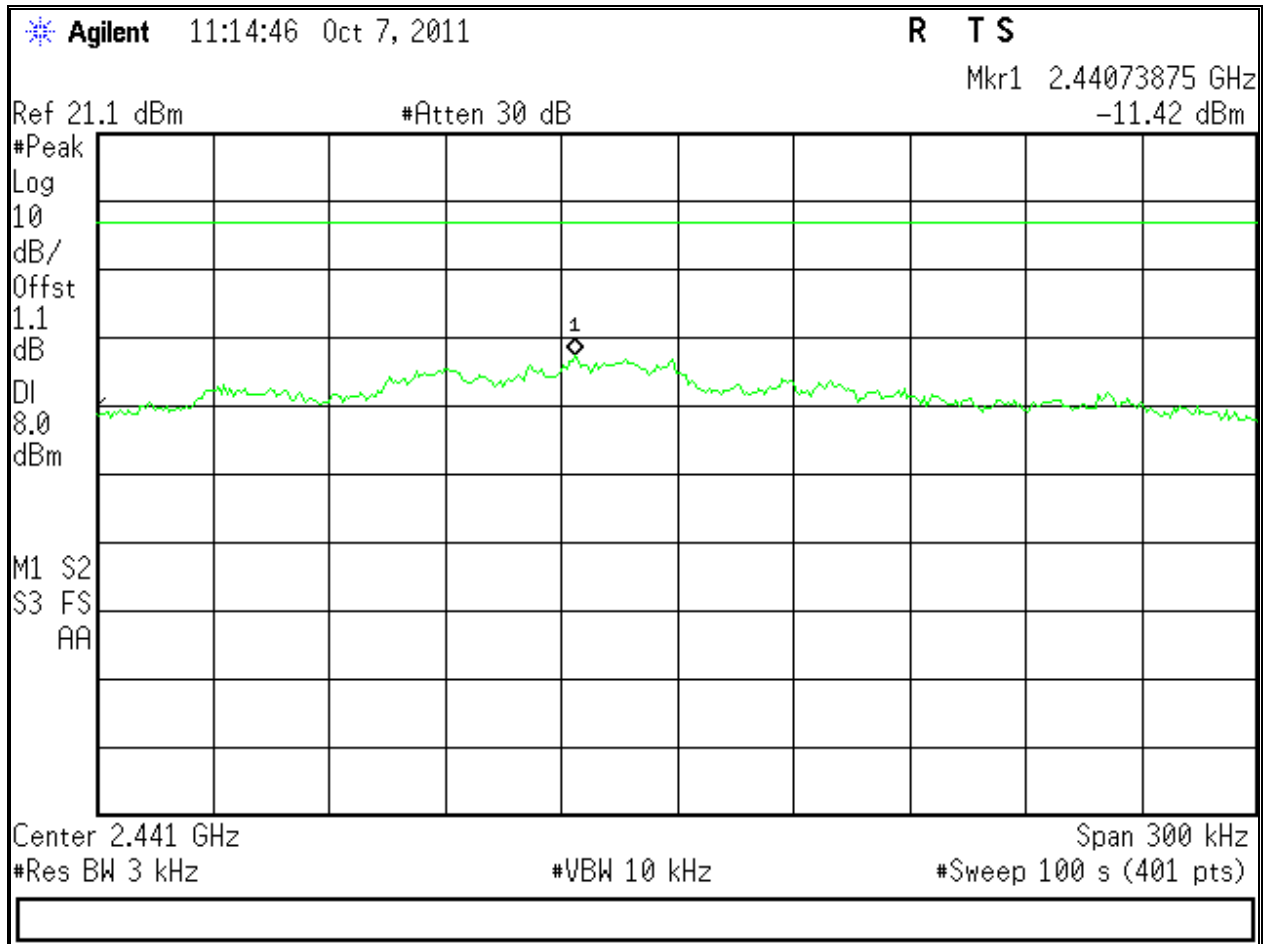

Figure 96: Peak Power Spectral Density for Operating Channel 2452MHz, Ch 1 – 27Mbps

4.5 Maximum Permissible Exposure

4.5.1 Test Methodology

In this document, we try to prove the safety of radiation harmfulness to the human body for our product. The limit for Maximum Permissible Exposure (MPE) specified in FCC 1.1310 is followed. The Gain of the antenna used in this product is measured in a Semi-Anechoic Chamber, and also the maximum total power input to the antenna is measured. Through the Friis transmission formula and the maximum gain of the antenna, we can calculate the distance, away from the product, where the limit of MPE is reached.

Although the Friis transmission formula is a far field assumption, the calculated result of that is an over-prediction for near field power density. We will take that as the worst case to specify the safety range.

4.5.2 RF Exposure Limit

According to FCC 1.1310 table 1: The criteria listed in the following table shall be used to evaluate the environmental impact of human exposure to radio-frequency (RF) radiation as specified in 1.1307(b)

LIMITS FOR MAXIMUM PERMISSIBLE EXPOSURE (MPE)

Frequency Range (MHz)	Electric Field Strength (V/m)	Magnetic Field Strength (A/m)	Power Density (mW/cm ²)	Average Time (minutes)
(A)Limits For Occupational / Control Exposures				
300 - 1500	F/300	6
1500 - 100,000	5	6
(B)Limits For General Population / Uncontrolled Exposure				
300 - 1500	F/1500	6
1500 - 100,000	1.0	30

F = Frequency in MHz

4.5.3 EUT Operating Condition

The software provided by Manufacturer enabled the EUT to transmit data at lowest, middle and highest channel individually.

4.5.4 Classification

The antenna of the product, under normal use condition, is at least 20cm away from the body of the user. Warning statement to the user for keeping at least 20cm or more separation distance with the antenna should be included in user's manual. So, this device is classified as a **Mobile Device**.

4.5.5 Test Results

4.5.5.1 Antenna Gain

The transmitting antenna was integrated. The antenna gain was +3.0 dBi or 2.0 (numeric).

4.5.5.2 Output Power into Antenna & RF Exposure value at distance 20cm:

Calculations for this report are based on highest power measurement.

Limit for MPE (from FCC part 1.1310 table1) is 1.0 mW/cm²

The highest measured power is +25.41 dBm or 347.536 mW; average power.

Using the Friss transmission formula, the EIRP is Pout*G, and R is 20cm.

$P_d = (347.536 * 2.0) / (1600\pi) = 0.1384 \text{ mW/cm}^2$, which is 0.8616 mW/cm² below to the limit.

As originally tested, the EUT was found to be compliant to the requirements of the test standard(s).

4.5.6 Sample Calculation

The Friss transmission formula: $P_d = (P_{out} * G) / (4 * \pi * R^2)$

Where;

Pd = power density in mW/cm²

Pout = output power to antenna in mW

G = gain of antenna in linear scale

$\pi \approx 3.1416$

R = distance between observation point and center of the radiator in cm

Ref. : David K. Cheng, *Field and Wave Electromagnetics*, Second Edition, Page 640, Eq. (11-133).

4.6 Transmitter Spurious Emissions

Transmitter spurious emissions are emissions outside the frequency range of the equipment when the equipment is in transmit mode; per requirement of CFR47 15.205, 15.209, 15.247(d), RSS 210 Sect. A.8.5

4.6.1 Test Methodology

4.6.1.1 Preliminary Test

A test program that controls instrumentation and data logging was used to automate the preliminary RF emission test procedure. The frequency range of interest was divided into sub-ranges to yield a frequency resolution of approximately 120 kHz and provide a reading at each frequency for no more than 12° of turntable rotation. For each frequency sub-range the turntable was rotated 360° while peak emission data was recorded and plotted over the frequency range of interest in horizontal and vertical antenna polarization's.

Preliminary emission profile testing was performed inside the anechoic chamber. The EUT was placed on a 1.0m x 1.5m non-conductive table 80cm above the floor. The EUT was positioned as shown in the setup photographs. The receiving antenna was placed at a distance of 3m at a fixed height of 1m. Measurement equipment was located outside of the chamber. A video camera was placed inside the chamber to view the EUT.

4.6.1.2 Final Test

For each frequency measured, the peak emission was maximized by manipulating the receiving antenna from 1 to 4 meters above the ground plane and placing it at the position that produced the maximum signal strength reading. The turntable was then rotated through 360° while observing the peak signal and placing the EUT at the position that produced maximum radiation. The six highest emissions relative to the limit were measured unless such emissions were more than 20 dB below the limit. If less than six emissions are within 20 dB of the limit, then the noise level of the receiver is measured at frequencies where emissions are expected. Multiples of all oscillator and microprocessor frequencies were also checked.

Final testing was performed on an NSA compliant test site. The EUT was placed on a 1.0m x 1.5m non-conductive table 80cm above the ground plane. The placement of EUT and cables were the same as for preliminary testing and is shown in the setup photographs.

The final scans performed on the worst axis, Y-Axis, for three operating channels;

2412MHz, 2437MHz, and 2462MHz at 1Mbit/s for 802.11b mode,

2412MHz, 2437MHz, and 2462MHz at 6Mbit/s for 802.11g mode,

2412MHz, 2437MHz, and 2462MHz at 6.5Mbit/s for 802.11n HT20 mode, and

2422MHz, 2437MHz, and 2452MHz at 13.5Mbit/s for 802.11n HT40 mode.

4.6.1.3 Deviations

None.

4.6.2 Transmitter Spurious Emission Limit

The spurious emissions of the transmitter shall not exceed the values in CFR47 Part 15.205, 15.209: 2010 and RSS 210 A1.1.2 2010.

Frequency (MHz)	Field strength (microvolts/meter)	Measurement distance (meters)
0.009-0.490	2400/F(kHz)	300
0.490-1.705	24000/F(kHz)	30
1.705-30.0	30	30
30-88	100 **	3
88-216	150 **	3
216-960	200 **	3
Above 960	500	3

All harmonics and spurious emission which are outside of the restricted band shall be 20dB below the in-band emission.

4.6.3 Test Results

The final measurement data was taken under the worst case operating modes, configurations, and/or cable positions. It also reflects the results including any modifications and/or special accessories listed in Sections 1.4 and Test Plan.

As originally tested, the EUT was found to be compliant to the requirements of the test standard(s).

Table 9: Transmit Spurious Emission at Band-Edge Requirements

Test Conditions: Radiated Measurement, Normal Temperature and Voltage only									
Antenna Type: Integrated					Power Setting: See Test Plan				
Max. Antenna Gain: +3.0 dBi					Signal State: Modulated				
Ambient Temp.: 23 °C					Relative Humidity: 37%				
Band-Edge Results									
Center Freq.	Mode	Edge Freq.	Pol.	Ant.	Table	Det.	Level	Limit	Margin
MHz		MHz	V/H	cm	Deg.	Pk/Avg	dBuV/m	dBuV/m	dB
2412	11b, 1Mbps, 24dBm	2390	V	294	77	Pk	65.01	74.00	-8.99
2412	11b, 1Mbps, 24dBm	2390	V	294	77	Ave	52.84	54.00	-1.16
2412	11b, 1Mbps, 24dBm	2390	H	125	41	Pk	66.32	74.00	-7.68
2412	11b, 1Mbps, 24dBm	2390	H	125	41	Ave	53.62	54.00	-0.38
2417	11b, 1Mbps, 25dBm	2390	H	125	36	Pk	64.44	74.00	-9.56
2417	11b, 1Mbps, 25dBm	2390	H	125	36	Ave	52.13	54.00	-1.87
2417	11b, 1Mbps, 25dBm	2390	V	148	272	Pk	63.30	74.00	-10.70
2417	11b, 1Mbps, 25dBm	2390	V	148	272	Ave	50.62	54.00	-3.38
2422	11b, 1Mbps, 26dBm	2390	V	149	266	Pk	63.14	74.00	-10.86
2422	11b, 1Mbps, 26dBm	2390	V	149	266	Ave	50.19	54.00	-3.81
2422	11b, 1Mbps, 26dBm	2390	H	94	24	Pk	64.49	74.00	-9.51
2422	11b, 1Mbps, 26dBm	2390	H	94	24	Ave	51.39	54.00	-3.0
2452	11b, 1Mbps, 26dBm	2483.5	H	120	375	Pk	60.89	74.00	-13.11
2452	11b, 1Mbps, 26dBm	2483.5	H	120	375	Ave	47.96	54.00	-6.04
2452	11b, 1Mbps, 26dBm	2483.5	V	141	272	Pk	60.31	74.00	-13.69
2452	11b, 1Mbps, 26dBm	2483.5	V	141	272	Ave	47.89	54.00	-6.11
2457	11b, 1Mbps, 25dBm	2483.5	V	146	266	Pk	61.63	74.00	-12.37
2457	11b, 1Mbps, 25dBm	2483.5	V	146	266	Ave	48.85	54.00	-5.15
2457	11b, 1Mbps, 25dBm	2483.5	H	120	28	Pk	60.64	74.00	-13.36
2457	11b, 1Mbps, 25dBm	2483.5	H	120	28	Ave	48.75	54.00	-5.25
2462	11b, 1Mbps, 24dBm	2483.5	H	121	31	Pk	62.82	74.00	-11.18
2462	11b, 1Mbps, 24dBm	2483.5	H	121	31	Ave	50.09	54.00	-3.91
2462	11b, 1Mbps, 24dBm	2483.5	V	146	264	Pk	61.77	74.00	-12.23
2462	11b, 1Mbps, 24dBm	2483.5	V	146	264	Ave	50.19	54.00	-3.81
2412	11g at 6mbps, 20dBm	2390	H	141	189	Pk	67.49	74.00	-6.51
2412	11g at 6mbps, 20dBm	2390	H	141	189	Ave	52.78	54.00	-1.22

2412	11g at 6mbps, 20dBm	2390	V	228	269	Pk	64.08	74.00	-9.92
2412	11g at 6mbps, 20dBm	2390	V	228	269	Ave	49.44	54.00	-4.56
2417	11g at 6mbps, 24dBm	2390	H	171	183	Pk	67.19	74.00	-6.81
2417	11g at 6mbps, 24dBm	2390	H	171	183	Ave	52.15	54.00	-1.85
2417	11g at 6mbps, 24dBm	2390	V	300	117	Pk	65.81	74.00	-8.19
2417	11g at 6mbps, 24dBm	2390	V	300	117	Ave	52.10	54.00	-1.90
2422	11g at 6mbps, 26dBm	2390	V	248	125	Pk	66.86	74.00	-7.14
2422	11g at 6mbps, 26dBm	2390	V	248	125	Ave	52.53	54.00	-1.47
2422	11g at 6mbps, 26dBm	2390	H	169	191	Pk	68.93	74.00	-5.07
2422	11g at 6mbps, 26dBm	2390	H	169	191	Ave	52.15	54.00	-1.85
2452	11g at 6mbps, 26dBm	2483.5	H	129	195	Pk	68.17	74.00	-5.83
2452	11g at 6mbps, 26dBm	2483.5	H	129	195	Ave	51.50	54.00	-2.50
2452	11g at 6mbps, 26dBm	2483.5	V	139	277	Pk	64.51	74.00	-9.49
2452	11g at 6mbps, 26dBm	2483.5	V	139	277	Ave	50.28	54.00	-3.72
2457	11g at 6mbps, 24dBm	2483.5	H	206	184	Pk	67.15	74.00	-6.85
2457	11g at 6mbps, 24dBm	2483.5	H	206	184	Ave	50.25	54.00	-3.75
2457	11g at 6mbps, 24dBm	2483.5	V	290	124	Pk	65.85	74.00	-8.15
2457	11g at 6mbps, 24dBm	2483.5	V	290	124	Ave	51.42	54.00	-2.58
2462	11g at 6mbps, 20dBm	2483.5	H	224	48	Pk	62.74	74.00	-11.26
2462	11g at 6mbps, 20dBm	2483.5	H	224	48	Ave	49.03	54.00	-4.97
2462	11g at 6mbps, 20dBm	2483.5	V	236	99	Pk	63.48	74.00	-10.52
2462	11g at 6mbps, 20dBm	2483.5	V	236	99	Ave	48.74	54.00	-5.26
2412	HT20, MCS0, 20dBm	2390	V	243	92	Pk	67.68	74.00	-6.32
2412	HT20, MCS0, 20dBm	2390	V	243	92	Ave	52.74	54.00	-1.26
2412	HT20, MCS0, 20dBm	2390	H	124	53	Pk	70.23	74.00	-3.77
2412	HT20, MCS0, 20dBm	2390	H	124	53	Ave	53.36	54.00	-0.64
2417	HT20, MCS0, 23dBm	2390	H	125	34	Ave	52.62	54.00	-1.38
2417	HT20, MCS0, 23dBm	2390	H	125	34	Pk	66.62	74.00	-7.38
2417	HT20, MCS0, 23dBm	2390	V	297	237	Pk	64.32	74.00	-9.68
2417	HT20, MCS0, 23dBm	2390	V	297	237	Ave	50.37	54.00	-3.63
2422	HT20, MCS0, 26dBm	2390	V	247	107	Pk	72.48	74.00	-1.52
2422	HT20, MCS0, 26dBm	2390	V	247	107	Ave	53.51	54.00	-0.49
2422	HT20, MCS0, 26dBm	2390	H	125	29	Pk	69.74	74.00	-4.26
2422	HT20, MCS0, 26dBm	2390	H	125	29	Ave	53.64	54.00	-0.36
2452	HT20, MCS0, 26dBm	2483.5	H	120	37	Pk	71.31	74.00	-2.69
2452	HT20, MCS0, 26dBm	2483.5	H	120	37	Ave	51.52	54.00	-2.48
2452	HT20, MCS0, 26dBm	2483.5	V	294	233	Pk	63.71	74.00	-10.29
2452	HT20, MCS0, 26dBm	2483.5	V	294	233	Ave	49.92	54.00	-4.08
2457	HT20, MCS0, 23dBm	2483.5	V	290	113	Pk	65.41	74.00	-8.59

2457	HT20, MCS0, 23dBm	2483.5	V	290	113	Ave	50.98	54.00	-3.02
2457	HT20, MCS0, 23dBm	2483.5	H	99	184	Pk	64.57	74.00	-9.43
2457	HT20, MCS0, 23dBm	2483.5	H	99	184	Ave	50.60	54.00	-3.40
2462	HT20, MCS0, 20dBm	2483.5	H	128	187	Pk	66.07	74.00	-7.93
2462	HT20, MCS0, 20dBm	2483.5	H	128	187	Ave	51.73	54.00	-2.27
2462	HT20, MCS0, 20dBm	2483.5	V	285	205	Pk	61.58	74.00	-12.42
2462	HT20, MCS0, 20dBm	2483.5	V	285	205	Ave	48.79	54.00	-5.21
2412	HT20, MCS8, 17dBm	2390	V	150	271	Pk	64.94	74.00	-9.06
2412	HT20, MCS8, 17dBm	2390	V	150	271	Ave	49.88	54.00	-4.12
2412	HT20, MCS8, 17dBm	2390	H	283	55	Pk	66.48	74.00	-7.52
2412	HT20, MCS8, 17dBm	2390	H	283	55	Ave	50.71	54.00	-3.29
2417	HT20, MCS8, 23dBm	2390	H	95	51	Pk	69.33	74.00	-4.67
2417	HT20, MCS8, 23dBm	2390	H	95	51	Ave	53.72	54.00	-0.28
2417	HT20, MCS8, 23dBm	2390	V	100	197	Pk	62.99	74.00	-11.01
2417	HT20, MCS8, 23dBm	2390	V	100	197	Ave	48.97	54.00	-5.03
2452	HT20, MCS8, 23dBm	2483.5	V	283	193	Pk	61.68	74.00	-12.32
2452	HT20, MCS8, 23dBm	2483.5	V	283	193	Ave	48.33	54.00	-5.67
2452	HT20, MCS8, 23dBm	2483.5	H	118	35	Pk	64.91	74.00	-9.09
2452	HT20, MCS8, 23dBm	2483.5	H	118	35	Ave	50.41	54.00	-3.59
2462	HT20, MCS8, 17dBm	2483.5	H	119	37	Pk	61.84	74.00	-12.16
2462	HT20, MCS8, 17dBm	2483.5	H	119	37	Ave	48.37	54.00	-5.63
2462	HT20, MCS8, 17dBm	2483.5	V	231	257	Pk	64.02	74.00	-9.98
2462	HT20, MCS8, 17dBm	2483.5	V	231	257	Ave	48.32	54.00	-5.68
2422	HT40, MCS0, 17dBm	2390	H	126	41	Ave	53.94	54.00	-0.1
2422	HT40, MCS0, 17dBm	2390	H	126	41	Pk	66.62	74.00	-7.38
2422	HT40, MCS0, 17dBm	2390	V	251	229	Pk	64.13	74.00	-9.87
2422	HT40, MCS0, 17dBm	2390	V	251	229	Ave	50.60	54.00	-3.40
2437	HT40, MCS0, 21dBm	2390	H	95	51	Ave	53.32	54.00	-0.68
2437	HT40, MCS0, 21dBm	2390	H	95	51	Pk	66.21	74.00	-7.79
2437	HT40, MCS0, 21dBm	2390	V	98	193	Pk	64.00	74.00	-10.00
2437	HT40, MCS0, 21dBm	2390	V	98	193	Ave	49.49	54.00	-4.51
2452	HT40, MCS0, 17dBm	2483.5	V	196	120	Pk	61.57	74.00	-12.43
2452	HT40, MCS0, 17dBm	2483.5	V	196	120	Ave	48.94	54.00	-5.06
2452	HT40, MCS0, 17dBm	2483.5	H	120	-6	Pk	62.25	74.00	-11.75
2452	HT40, MCS0, 17dBm	2483.5	H	120	-6	Ave	49.00	54.00	-5.00
2422	HT40, MCS8, 17dBm	2390	H	125	41	Pk	66.38	74.00	-7.62
2422	HT40, MCS8, 17dBm	2390	H	125	41	Ave	52.44	54.00	-1.56
2422	HT40, MCS8, 17dBm	2390	V	242	20	Pk	61.49	74.00	-12.51
2422	HT40, MCS8, 17dBm	2390	V	242	20	Ave	48.99	54.00	-5.01

2437	HT40, MCS8, 20dBm	2483.5	V	243	98	Pk	64.44	74.00	-9.56
2437	HT40, MCS8, 20dBm	2483.5	V	243	98	Ave	50.38	54.00	-3.62
2437	HT40, MCS8, 20dBm	2390	H	95	44	Pk	66.02	74.00	-7.98
2437	HT40, MCS8, 20dBm	2390	H	95	44	Ave	51.52	54.00	-2.48
2452	HT40, MCS8, 17dBm	2483.5	V	240	103	Pk	63.14	74.00	-10.86
2452	HT40, MCS8, 17dBm	2483.5	V	240	103	Ave	49.98	54.00	-4.02
2452	HT40, MCS8, 17dBm	2483.5	H	240	42	Pk	61.65	74.00	-12.35
2452	HT40, MCS8, 17dBm	2483.5	H	240	42	Ave	48.25	54.00	-5.75

SOP 1 Radiated Emissions						Tracking # 31153119.001 Page 1 of 18					
EUT Name	Wireless uDSL Residential Gateway					Date	October 5, 2011				
EUT Model	5168NV					Temp / Hum in	23°C / 45%rh				
EUT Serial	31104000521					Temp / Hum out	N/A				
EUT Config.	802.11b, 1Mbps at Y-Axis (30MHz-1GHz)					Line AC / Freq	120Vac/60Hz				
Standard	CFR47 Part 15 Subpart C					RBW / VBW	120 kHz/ 300 kHz				
Dist/Ant Used	3m / JB3					Performed by	Jeremy Luong				
Emission Freq (MHz)	ANT Polar (H/V)	ANT Pos (cm)	Table Pos (deg)	FIM (Pk) (dBuV/m)	FIM QP (dBuV/m)	Total CF (dBuV)	E-Field QP (dBuV/m)	Spec Limit (dBuV/m)	Spec Margin (dB)	Type	
Transmitted Data at 2437MHz											
320.00	H	111	119	49.00	48.15	-10.05	38.10	46.02	-7.92	Spurious	
499.98	H	167	134	50.97	49.07	-7.17	41.90	46.02	-4.12	Spurious	
639.99	H	122	150	46.05	45.67	-4.87	40.80	46.02	-5.22	Spurious	
800.00	H	103	119	45.66	45.27	-2.42	42.85	46.02	-3.17	Spurious	
874.87	H	141	165	37.68	36.26	-1.44	34.82	46.02	-11.20	Spurious	
100.00	V	109	299	51.12	49.73	-15.71	34.02	43.52	-9.50	Spurious	
400.00	V	122	290	50.14	49.37	-9.15	40.22	46.02	-5.80	Spurious	
480.01	V	119	321	48.51	48.45	-7.61	40.84	46.02	-5.18	Spurious	
500.02	V	106	160	47.02	46.20	-7.57	38.63	46.02	-7.39	Spurious	
559.98	V	105	273	46.44	46.68	-6.73	39.95	46.02	-6.07	Spurious	
Spec Margin = E-Field QP - Limit, E-Field QP = FIM QP+ Total CF ± Uncertainty											
Total CF= Amp Gain + Cable Loss + ANT Factor											
Combined Standard Uncertainty $u_c(y) = \pm 3.2$ dB Expanded Uncertainty $U = ku_c(y)$ $k = 2$ for 95% confidence											
Note: The worst case was observed at 802.11b, 1Mbps at Channel 2437 MHz.											

SOP 1 Radiated Emissions							Tracking # 31153119.001 Page 2 of 18			
EUT Name	Wireless uDSL Residential Gateway					Date	October 4, 2011			
EUT Model	5168NV					Temp / Hum in	23°C / 49%rh			
EUT Serial	31104000521					Temp / Hum out	N/A			
EUT Config.	802.11b, 1Mbps at Y-Axis (above 1GHz)					Line AC / Freq	120Vac/60Hz			
Standard	CFR47 Part 15 Subpart C					RBW / VBW	1MHz / 3MHz			
Dist/Ant Used	3m / DRH-118, 1m / RA42-K-F-4B-C					Performed by	Jeremy Luong			
Emission Freq (MHz)	ANT Polar (H/V)	ANT Pos (cm)	Table Pos (deg)	FIM (Pk) (dBuV/m)	FIM Ave. (dBuV/m)	Total CF (dBuV)	E-Field Pk/Ave. (dBuV/m)	Spec Limit (dBuV/m)	Spec Margin (dB)	Type
Transmitted Data at 2412MHz at 802.11b, 1Mbit/s										
3216.04	H	202	157	43.35	38.76	0.03	38.79	53.98	-15.19	Unrestricted
3216.06	V	269	89	44.40	39.87	0.03	39.90	53.98	-14.08	Unrestricted
3840.10	H	133	402	44.15	40.03	1.76	41.79	53.98	-12.19	Restricted
4824.04	V	178	419	42.56	35.88	2.42	38.30	53.98	-15.68	Restricted
4824.13	H	313	57	43.23	37.25	2.42	39.67	53.98	-14.31	Restricted
5200.12	H	104	25	40.62	33.52	3.70	37.22	53.98	-16.76	Unrestricted
6000.08	H	219	413	43.66	39.38	5.14	44.52	53.98	-9.46	Unrestricted
19296.10	V	101	160	35.81	31.86	11.36	43.22	63.98	-20.76	Restricted
Transmitted Data at 2437MHz at 802.11b, 1Mbit/s										
1374.83	H	101	111	54.40	49.27	-7.54	41.73	53.98	-12.25	Restricted
3249.41	V	124	81	41.89	37.46	0.11	37.57	53.98	-16.41	Unrestricted
4874.04	H	193	404	44.64	39.24	2.52	41.76	53.98	-12.22	Restricted
4874.04	V	331	105	42.78	37.60	2.52	40.12	53.98	-13.86	Restricted
6000.07	H	145	408	41.55	36.70	5.14	41.84	53.98	-12.14	Unrestricted
19496.10	V	105	158	36.25	32.38	11.55	43.93	63.98	-20.05	Restricted
Transmitted Data at 2462MHz at 802.11b, 1Mbit/s										
1374.88	V	246	140	48.63	42.26	-7.54	34.72	53.98	-19.26	Restricted
1374.88	H	101	116	53.79	48.10	-7.54	40.56	53.98	-13.42	Restricted
3200.08	H	139	466	44.05	38.17	-0.01	38.16	53.98	-15.82	Unrestricted
3840.07	H	156	422	44.27	40.44	1.76	42.20	53.98	-11.78	Restricted
4924.06	V	154	399	40.22	31.74	2.60	34.34	53.98	-19.64	Unrestricted
4924.12	H	229	13	43.49	37.99	2.60	40.59	53.98	-13.39	Restricted
5200.09	H	154	28	40.97	33.98	3.70	37.68	53.98	-16.30	Unrestricted
6000.08	H	154	415	43.51	39.65	5.14	44.79	53.98	-9.19	Unrestricted
7800.10	H	129	47	38.49	25.07	8.60	33.67	53.98	-20.31	Unrestricted
9848.04	H	119	23	35.26	25.04	11.13	36.17	53.98	-17.81	Unrestricted
Spec Margin = E-Field Ave. - Limit, E-Field Ave. = FIM Ave. + Total CF ± Uncertainty										
Total CF= Amp Gain + Cable Loss + ANT Factor										
Combined Standard Uncertainty $u_c(y) = \pm 3.2\text{dB}$ Expanded Uncertainty $U = ku_c(y)$ $k = 2$ for 95% confidence										
Notes: All emissions passed the spurious emission limit.										

SOP 1 Radiated Emissions

Tracking # 31153119.001 Page 3 of 18

EUT Name	Wireless uDSL Residential Gateway	Date	October 5, 2011
EUT Model	5168NV	Temp / Hum in	23°C / 45%rh
EUT Serial	31104000521	Temp / Hum out	N/A
EUT Config.	802.11b, 1Mbps at Y-Axis (30MHz-1GHz)	Line AC / Freq	120Vac/60Hz
Standard	CFR47 Part 15 Subpart C	RBW / VBW	120 kHz/ 300 kHz
EUT Name	Wireless uDSL Residential Gateway	Date	October 5, 2011

30MHz to 1000MHz Plot for Transmit 802.11b, 1Mbit/s Mode at 2437MHz

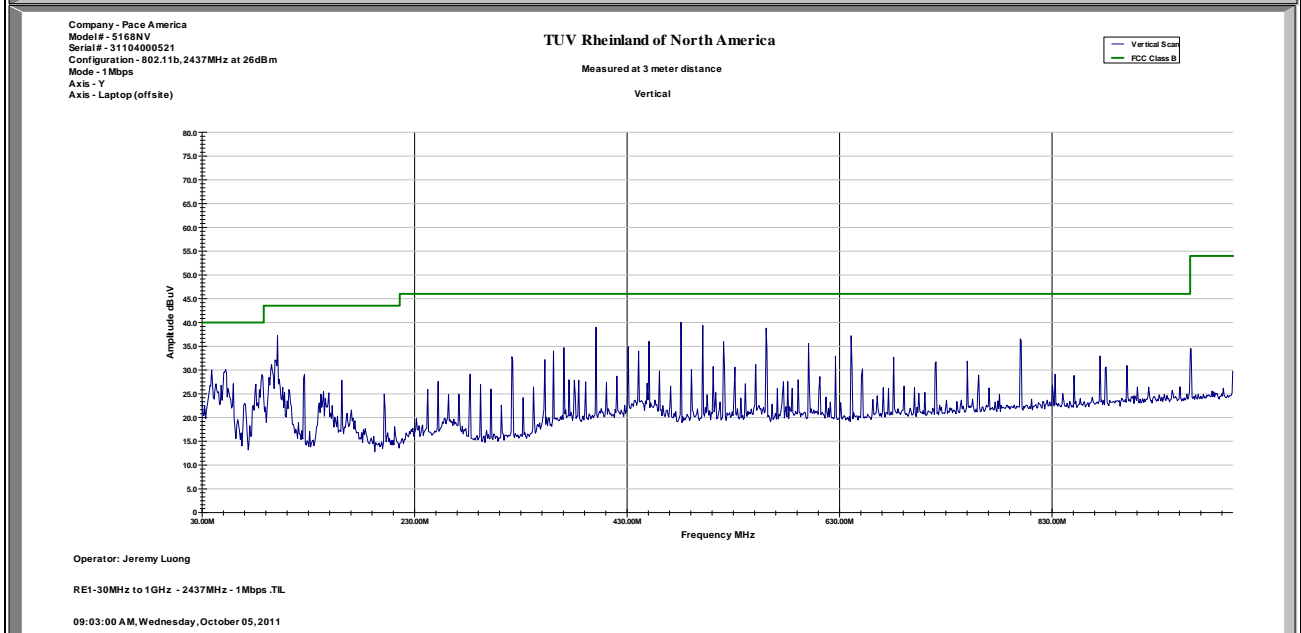
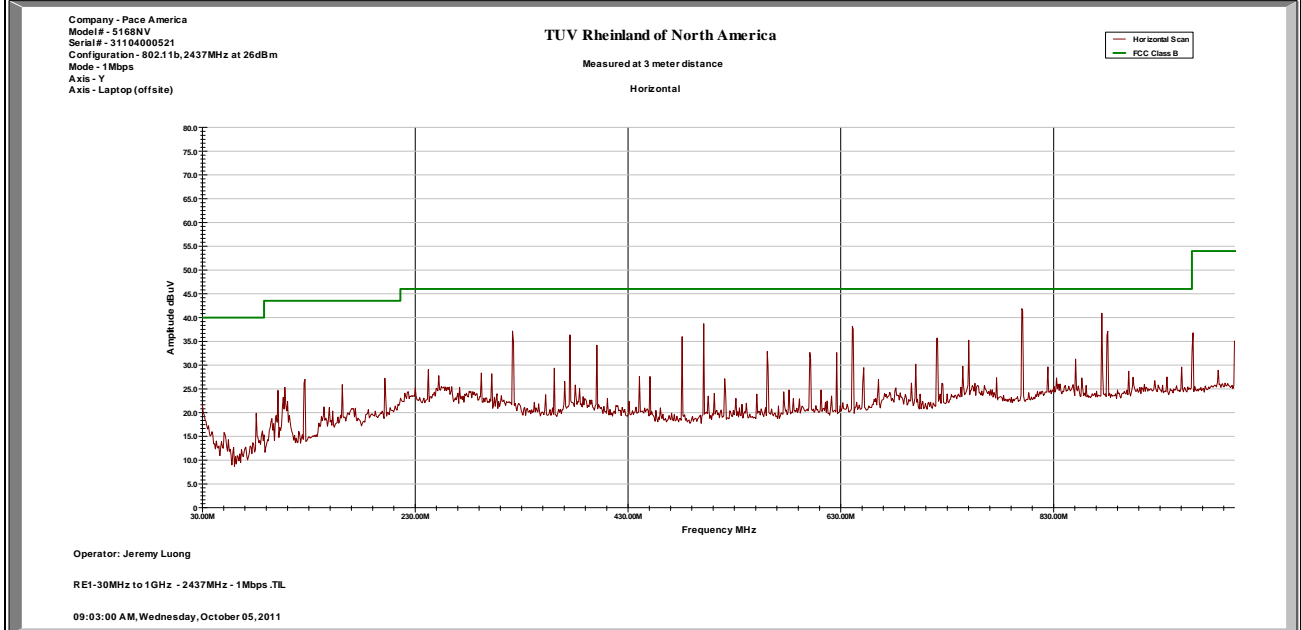

Notes: None.

SOP 1 Radiated Emissions

Tracking # 31153119.001 Page 4 of 18

EUT Name	Wireless uDSL Residential Gateway	Date	October 4, 2011
EUT Model	5168NV	Temp / Hum in	23°C / 49%rh
EUT Serial	31104000521	Temp / Hum out	N/A
EUT Config.	802.11b, 1Mbps at Y-Axis (above 1GHz)	Line AC / Freq	120Vac/60Hz
Standard	CFR47 Part 15 Subpart C	RBW / VBW	1MHz / 3MHz
Dist/Ant Used	3m / DRH-118, 1m / RA42-K-F-4B-C	Performed by	Jeremy Luong

Above 1GHz Plots for Transmit Mode at 2412MHz, 802.11b 1Mbit/s

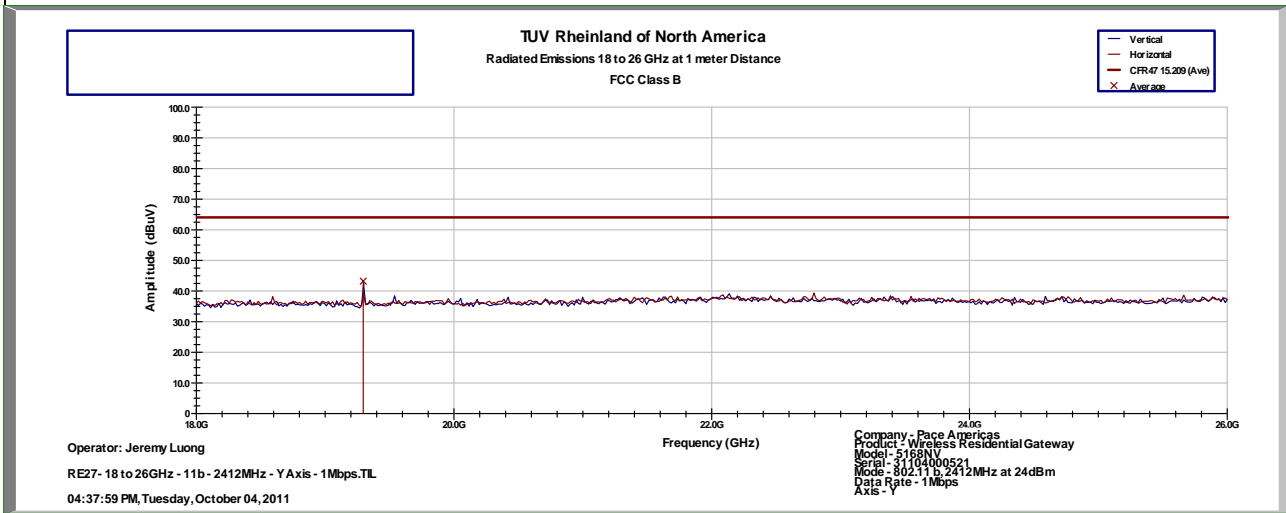
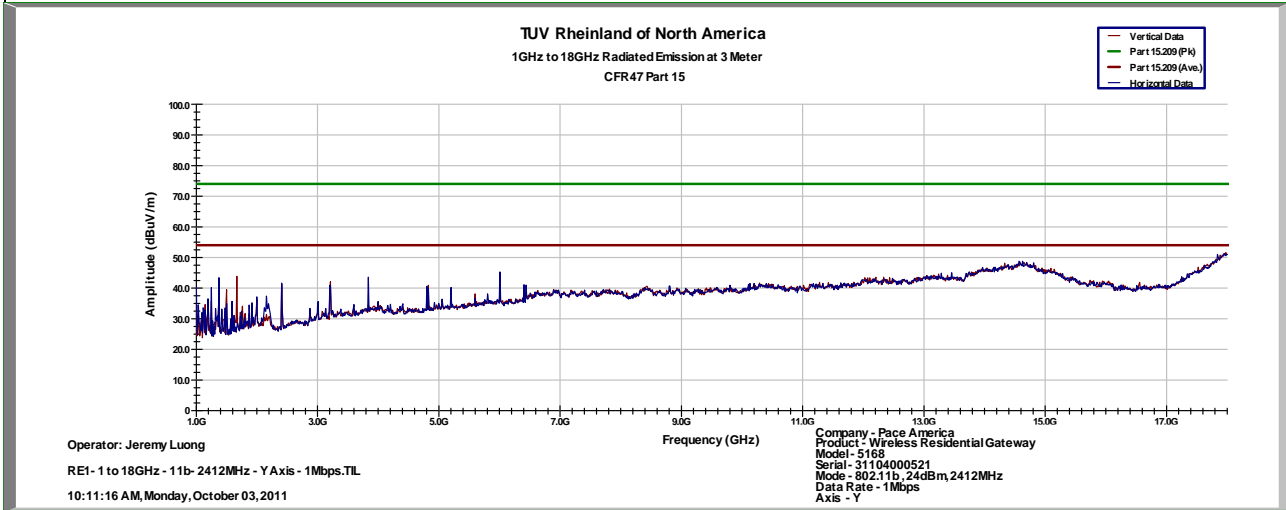

Notes: Limit was extrapolated to 1m distance for 18GHz – 25GHz range.
 1GHz – 25GHz Setting: RBW = 1MHz/ VBW = 3MHz

SOP 1 Radiated Emissions

Tracking # 31153119.001 Page 5 of 18

EUT Name	Wireless uDSL Residential Gateway	Date	October 4, 2011
EUT Model	5168NV	Temp / Hum in	23°C / 49%rh
EUT Serial	31104000521	Temp / Hum out	N/A
EUT Config.	802.11b, 1Mbps at Y-Axis (above 1GHz)	Line AC / Freq	120Vac/60Hz
Standard	CFR47 Part 15 Subpart C	RBW / VBW	1MHz / 3MHz
Dist/Ant Used	3m / DRH-118, 1m / RA42-K-F-4B-C	Performed by	Jeremy Luong

Above 1GHz Plots for Transmit Mode at 2437MHz, 802.11b 1Mbit/s

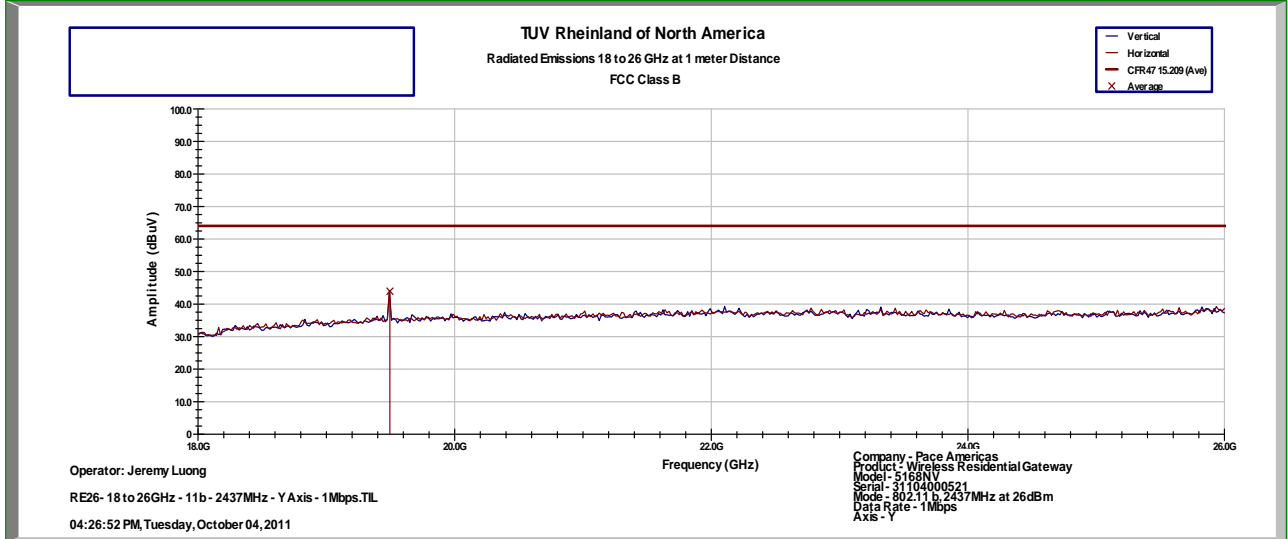
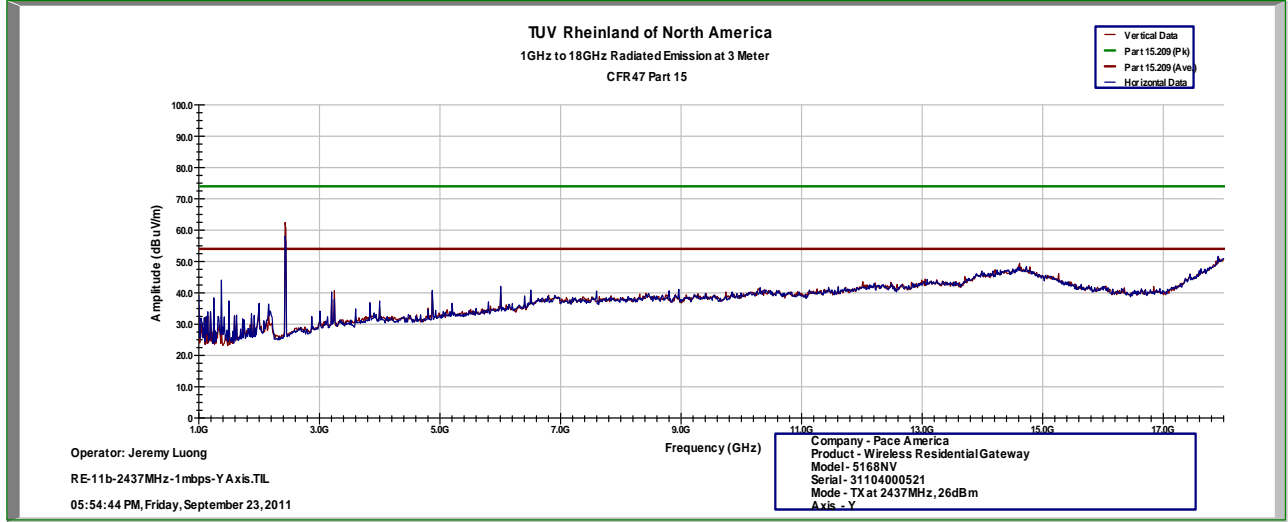

Notes: Limit was extrapolated to 1m distance for 18GHz – 25GHz range.
 1GHz – 25GHz Setting: RBW = 1MHz/ VBW = 3MHz.

SOP 1 Radiated Emissions

Tracking # 31153119.001 Page 6 of 18

EUT Name	Wireless uDSL Residential Gateway	Date	October 4, 2011
EUT Model	5168NV	Temp / Hum in	23°C / 49%rh
EUT Serial	31104000521	Temp / Hum out	N/A
EUT Config.	802.11b, 1Mbps at Y-Axis (above 1GHz)	Line AC / Freq	120Vac/60Hz
Standard	CFR47 Part 15 Subpart C	RBW / VBW	1MHz / 3MHz
Dist/Ant Used	3m / DRH-118, 1m / RA42-K-F-4B-C	Performed by	Jeremy Luong

Above 1GHz Plots for Transmit Mode at 2462MHz, 802.11b 1Mbit/s

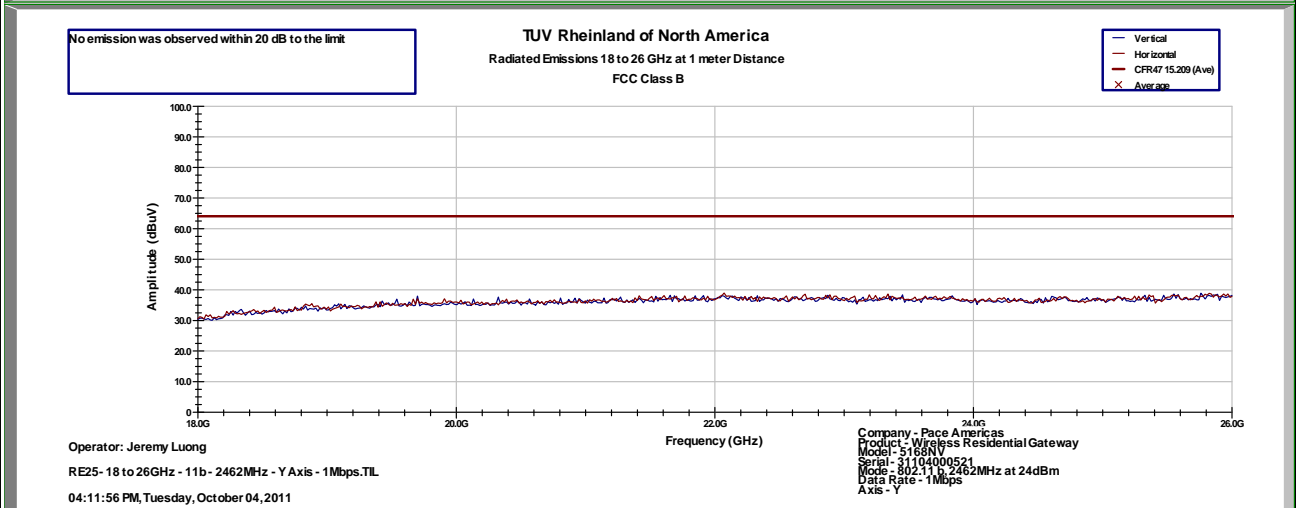
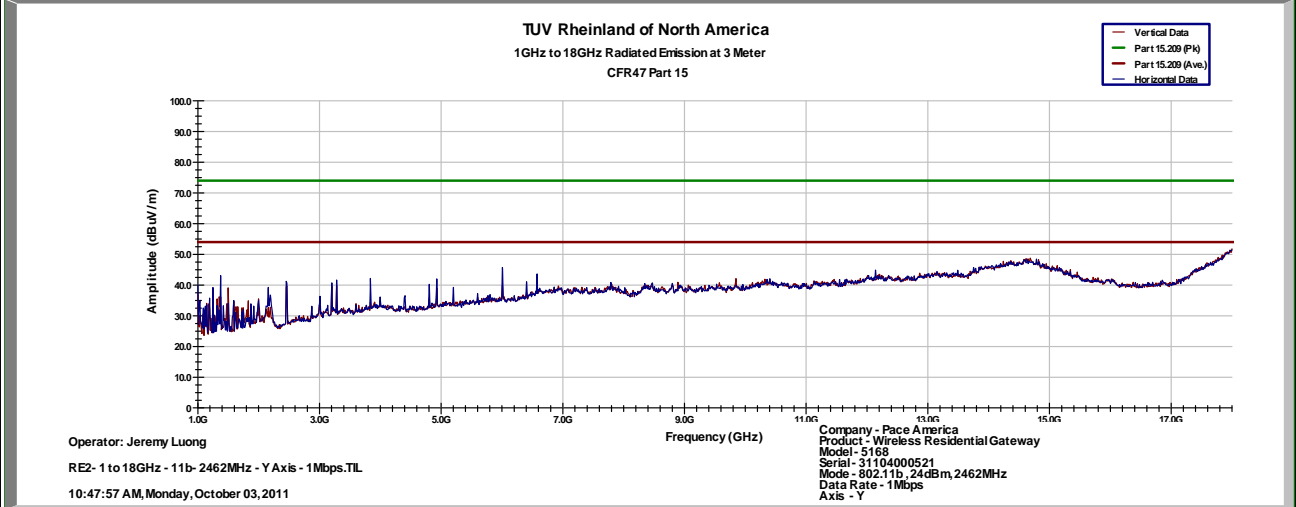

Notes: Limit was extrapolated to 1m distance for 18GHz – 25GHz range.
 1GHz – 25GHz Setting: RBW = 1MHz/ VBW = 3MHz

SOP 1 Radiated Emissions							Tracking # 31153119.001 Page 7 of 18			
EUT Name	Wireless uDSL Residential Gateway					Date	October 4, 2011			
EUT Model	5168NV					Temp / Hum in	23°C / 49%rh			
EUT Serial	31104000521					Temp / Hum out	N/A			
EUT Config.	802.11g, 6Mbps at Y-Axis (above 1GHz)					Line AC / Freq	120Vac/60Hz			
Standard	CFR47 Part 15 Subpart C					RBW / VBW	1MHz / 3MHz			
Dist/Ant Used	3m / DRH-118, 1m / RA42-K-F-4B-C					Performed by	Jeremy Luong			
Emission Freq (MHz)	ANT Polar (H/V)	ANT Pos (cm)	Table Pos (deg)	FIM (Pk) (dBuV/m)	FIM Ave. (dBuV/m)	Total CF (dBuV)	E-Field Pk/Ave. (dBuV/m)	Spec Limit (dBuV/m)	Spec Margin (dB)	Type
Transmitted Data at 2412MHz at 802.11g, 6Mbit/s										
1374.87	H	96	117	53.99	48.68	-7.54	41.14	53.98	-12.84	Restricted
3200.00	V	123	30	39.51	31.16	-0.01	31.15	53.98	-22.83	Unrestricted
3200.13	H	143	494	45.02	39.51	-0.01	39.50	53.98	-14.48	Restricted
3840.08	H	156	405	44.24	40.43	1.76	42.19	53.98	-11.79	Restricted
4824.06	H	102	30	38.34	26.09	2.42	28.51	53.98	-25.47	Restricted
5200.12	H	155	391	41.04	33.48	3.70	37.18	53.98	-16.80	Unrestricted
6000.06	H	201	56	43.01	39.04	5.14	44.18	53.98	-9.80	Unrestricted
19296.10	V	99	155	34.75	30.69	11.36	42.05	63.98	-21.93	Restricted
Transmitted Data at 2437MHz at 802.11g, 6Mbit/s										
1374.87	H	97	117	54.36	48.75	-7.54	41.21	53.98	-12.77	Restricted
3200.14	H	202	490	44.54	38.79	-0.01	38.78	53.98	-15.20	Unrestricted
3840.08	H	130	46	42.71	39.69	1.76	41.45	53.98	-12.53	Restricted
4874.22	V	153	159	41.75	26.54	2.52	29.06	53.98	-24.92	Restricted
4874.80	H	132	413	52.51	32.56	2.52	35.08	53.98	-18.90	Restricted
6000.06	H	153	411	42.90	38.87	5.14	44.01	53.98	-9.97	Unrestricted
19496.10	V	101	73	34.19	28.87	11.55	40.42	63.98	-23.56	Restricted
Transmitted Data at 2462MHz at 802.11g, 6Mbit/s										
1374.89	H	100	478	53.80	48.03	-7.54	40.49	53.98	-13.49	Restricted
3282.77	H	243	418	43.46	39.92	0.23	40.15	53.98	-13.83	Restricted
3840.07	H	268	61	43.16	38.42	1.76	40.18	53.98	-13.80	Restricted
4923.97	V	210	411	41.78	25.27	2.60	27.87	53.98	-26.11	Restricted
4924.18	H	99	136	46.20	25.26	2.60	27.86	53.98	-26.12	Restricted
6000.05	H	155	46	42.18	37.57	5.14	42.71	53.98	-11.27	Unrestricted
Spec Margin = E-Field Ave. - Limit, E-Field Ave. = FIM Ave. + Total CF ± Uncertainty										
Total CF= Amp Gain + Cable Loss + ANT Factor										
Combined Standard Uncertainty $u_c(y) = \pm 3.2\text{dB}$ Expanded Uncertainty $U = ku_c(y)$ $k = 2$ for 95% confidence										
Notes: All emissions passed the spurious emission limit.										

SOP 1 Radiated Emissions

Tracking # 31153119.001 Page 8 of 18

EUT Name	Wireless uDSL Residential Gateway	Date	October 4, 2011
EUT Model	5168NV	Temp / Hum in	23°C / 49%rh
EUT Serial	31104000521	Temp / Hum out	N/A
EUT Config.	802.11g, 6Mbps at Y-Axis (above 1GHz)	Line AC / Freq	120Vac/60Hz
Standard	CFR47 Part 15 Subpart C	RBW / VBW	1MHz / 3MHz
Dist/Ant Used	3m / DRH-118, 1m / RA42-K-F-4B-C	Performed by	Jeremy Luong

Above 1GHz Plots for Transmit Mode at 2412MHz, 802.11g 6Mbit/s

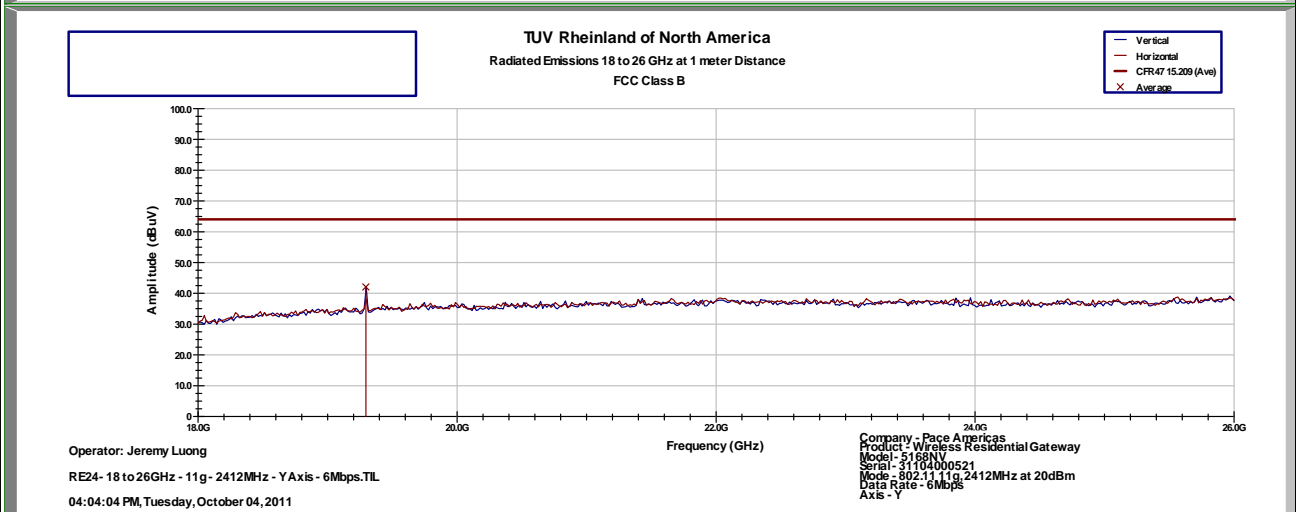
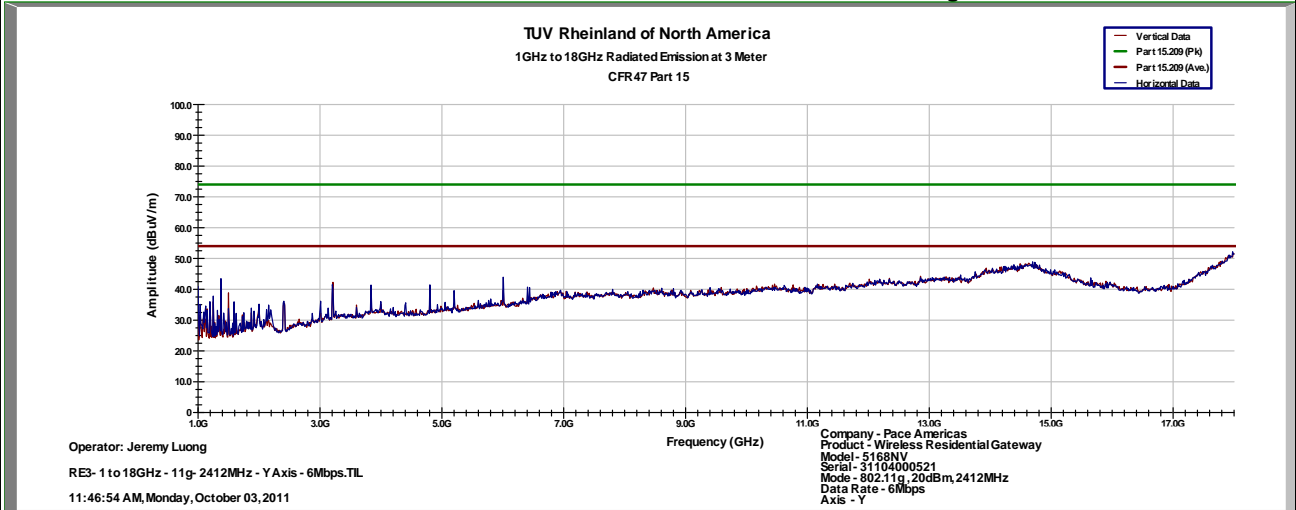

Notes: Limit was extrapolated to 1m distance for 18GHz – 25GHz range.
 1GHz – 25GHz Setting: RBW = 1MHz/ VBW = 3MHz

SOP 1 Radiated Emissions

Tracking # 31153119.001 Page 9 of 18

EUT Name	Wireless uDSL Residential Gateway	Date	October 4, 2011
EUT Model	5168NV	Temp / Hum in	23°C / 49%rh
EUT Serial	31104000521	Temp / Hum out	N/A
EUT Config.	802.11g, 6Mbps at Y-Axis (above 1GHz)	Line AC / Freq	120Vac/60Hz
Standard	CFR47 Part 15 Subpart C	RBW / VBW	1MHz / 3MHz
Dist/Ant Used	3m / DRH-118, 1m / RA42-K-F-4B-C	Performed by	Jeremy Luong

Above 1GHz Plots for Transmit Mode at 2437MHz, 802.11g 6Mbit/s

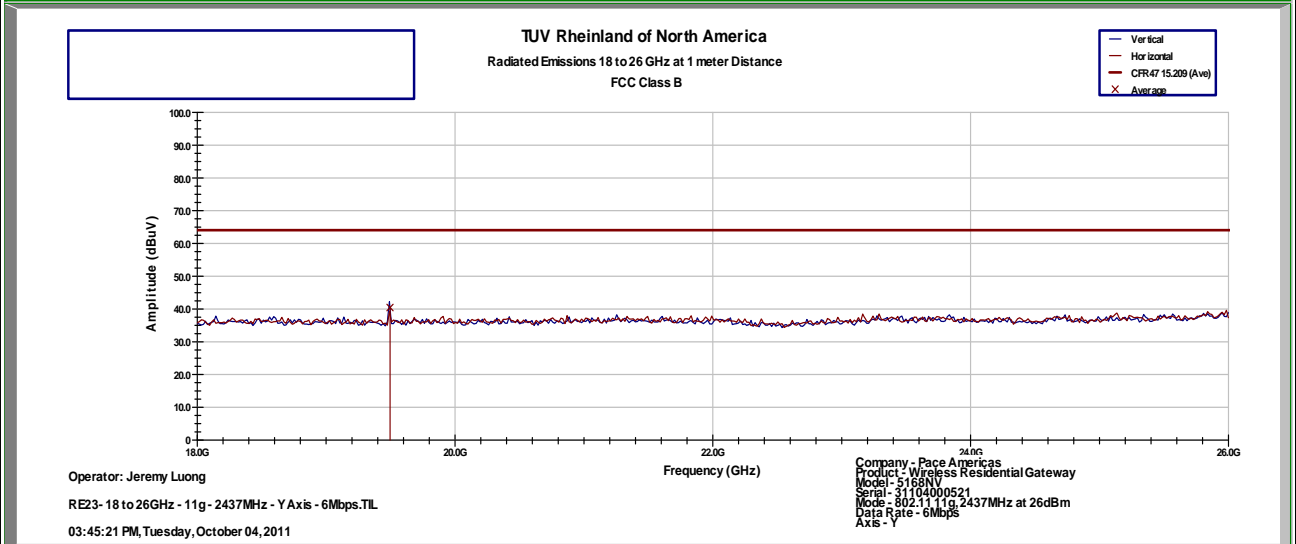
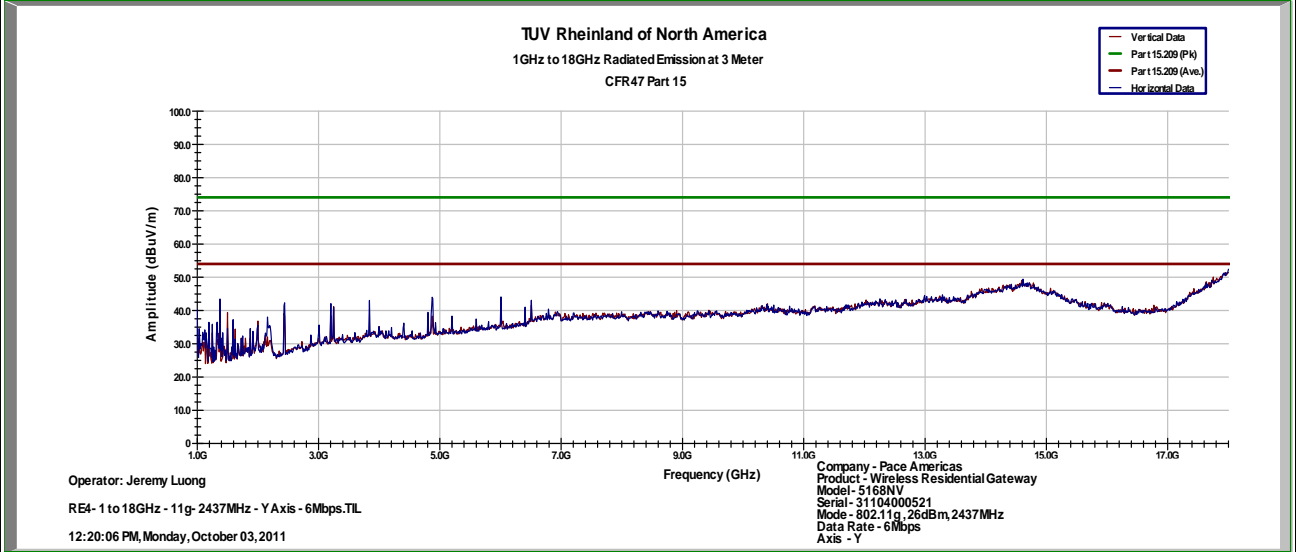

Notes: Limit was extrapolated to 1m distance for 18GHz – 25GHz range.
 1GHz – 25GHz Setting: RBW = 1MHz/ VBW = 3MHz

SOP 1 Radiated Emissions

Tracking # 31153119.001 Page 10 of 18

EUT Name	Wireless uDSL Residential Gateway	Date	October 4, 2011
EUT Model	5168NV	Temp / Hum in	23°C / 49%rh
EUT Serial	31104000521	Temp / Hum out	N/A
EUT Config.	802.11g, 6Mbps at Y-Axis (above 1GHz)	Line AC / Freq	120Vac/60Hz
Standard	CFR47 Part 15 Subpart C	RBW / VBW	1MHz / 3MHz
Dist/Ant Used	3m / DRH-118, 1m / RA42-K-F-4B-C	Performed by	Jeremy Luong

Above 1GHz Plots for Transmit Mode at 2462MHz, 802.11g 6Mbit/s

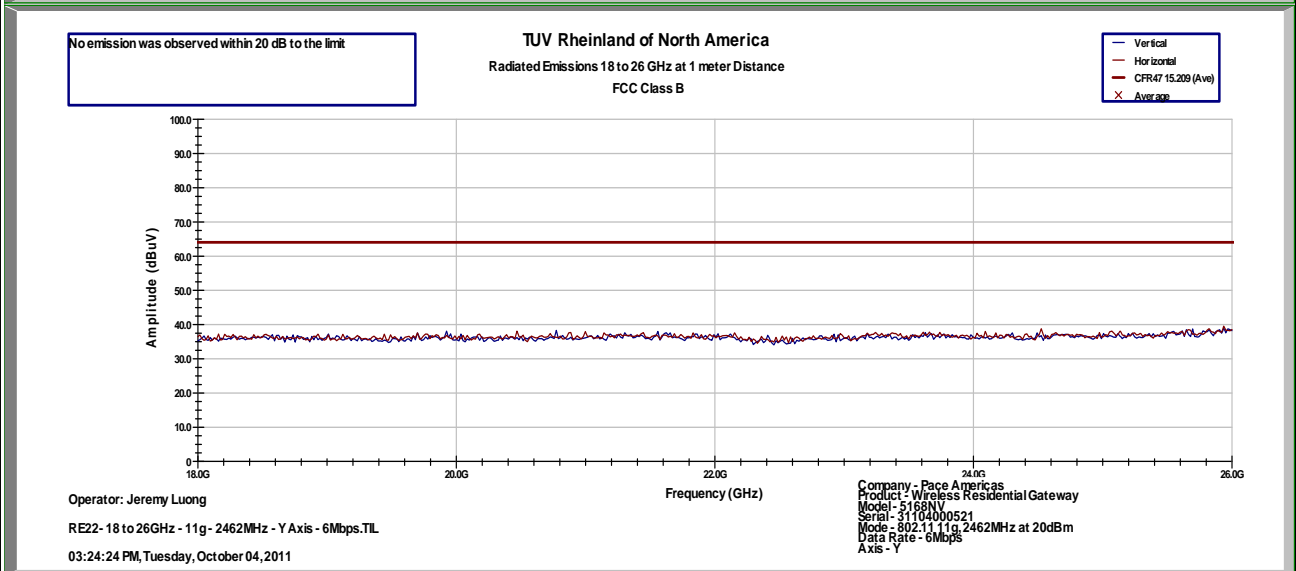
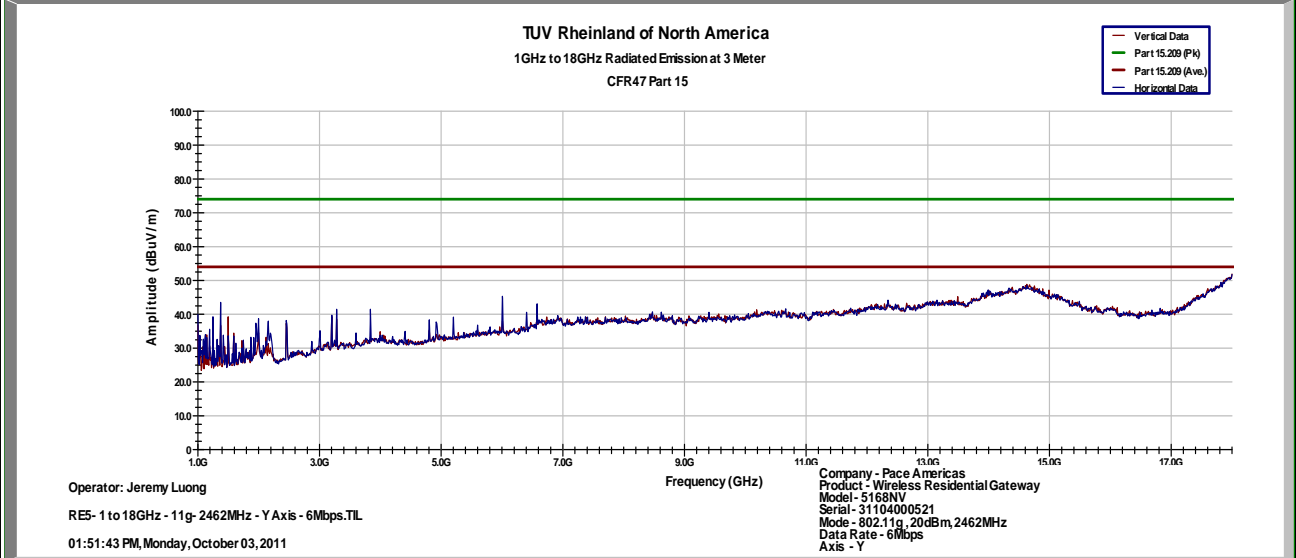

Notes: Limit was extrapolated to 1m distance for 18GHz – 25GHz range.
 1GHz – 25GHz Setting: RBW = 1MHz/ VBW = 3MHz

SOP 1 Radiated Emissions							Tracking # 31153119.001 Page 11 of 18			
EUT Name	Wireless uDSL Residential Gateway					Date	October 4, 2011			
EUT Model	5168NV					Temp / Hum in	23°C / 49%rh			
EUT Serial	31104000521					Temp / Hum out	N/A			
EUT Config.	802.11 HT20, 6.5Mbps at Y-Axis (above 1GHz)					Line AC / Freq	120Vac/60Hz			
Standard	CFR47 Part 15 Subpart C					RBW / VBW	1MHz / 3MHz			
Dist/Ant Used	3m / DRH-118, 1m / RA42-K-F-4B-C					Performed by	Jeremy Luong			
Emission Freq (MHz)	ANT Polar (H/V)	ANT Pos (cm)	Table Pos (deg)	FIM (Pk) (dBuV/m)	FIM Ave. (dBuV/m)	Total CF (dBuV)	E-Field Pk/Ave. (dBuV/m)	Spec Limit (dBuV/m)	Spec Margin (dB)	Type
Transmitted Data at 2412MHz at 802.11n HT20, 6.5Mbit/s										
1374.87	H	97	112	54.19	48.21	-7.54	40.67	53.98	-13.31	Unrestricted
3200.05	H	171	140	44.04	38.10	-0.01	38.09	53.98	-15.89	Restricted
3216.10	V	222	99	45.07	41.35	0.03	41.38	53.98	-12.60	Restricted
3840.08	H	110	412	43.90	40.01	1.76	41.77	53.98	-12.21	Restricted
4823.79	H	121	68	37.57	23.88	2.42	26.30	53.98	-27.68	Restricted
6000.11	H	155	52	42.96	38.95	5.14	44.09	53.98	-9.89	
19296.10	V	99	162	40.48	32.34	11.36	43.70	63.98	-20.28	
Transmitted Data at 2437MHz at 802.11n HT20, 6.5Mbit/s										
1374.88	H	100	115	53.72	47.87	-7.54	40.33	53.98	-13.65	Unrestricted
3249.43	H	214	415	44.65	40.92	0.11	41.03	53.98	-12.95	Restricted
3249.43	V	174	98	44.70	39.80	0.11	39.91	53.98	-14.07	Restricted
3840.08	H	110	403	42.73	39.08	1.76	40.84	53.98	-13.14	Restricted
4873.71	H	115	58	50.14	33.33	2.52	35.85	53.98	-18.13	Restricted
4874.16	V	193	155	41.24	27.44	2.52	29.96	53.98	-24.02	Unrestricted
6000.07	H	185	47	42.68	38.55	5.14	43.69	53.98	-10.29	Restricted
19496.10	H	108	464	35.63	28.94	11.55	40.49	63.98	-23.49	Restricted
19496.10	H	107	156	36.00	31.83	11.55	43.38	63.98	-20.60	Restricted
Transmitted Data at 2462MHz at 802.11n HT20, 6.5Mbit/s										
1374.87	H	235	126	52.69	47.41	-7.54	39.87	53.98	-14.11	Restricted
3200.08	H	144	491	43.75	39.58	-0.01	39.57	53.98	-14.41	Unrestricted
3282.74	H	129	401	43.21	39.69	0.23	39.92	53.98	-14.06	Restricted
3840.11	H	181	50	43.74	39.61	1.76	41.37	53.98	-12.61	Restricted
4928.09	H	97	381	38.92	29.53	2.62	32.15	53.98	-21.83	Restricted
6000.12	H	219	53	42.52	37.92	5.14	43.06	53.98	-10.92	Restricted
Spec Margin = E-Field Ave. - Limit, E-Field Ave. = FIM Ave. + Total CF ± Uncertainty										
Total CF= Amp Gain + Cable Loss + ANT Factor										
Combined Standard Uncertainty $u_c(y) = \pm 3.2\text{dB}$ Expanded Uncertainty $U = ku_c(y)$ $k = 2$ for 95% confidence										
Notes: All emissions passed the spurious emission limit.										

SOP 1 Radiated Emissions

Tracking # 31153119.001 Page 12 of 18

EUT Name	Wireless uDSL Residential Gateway	Date	October 4, 2011
EUT Model	5168NV	Temp / Hum in	23°C / 49%rh
EUT Serial	31104000521	Temp / Hum out	N/A
EUT Config.	802.11 HT20, 6.5Mbps at Y-Axis (above 1GHz)	Line AC / Freq	120Vac/60Hz
Standard	CFR47 Part 15 Subpart C	RBW / VBW	1MHz / 3MHz
Dist/Ant Used	3m / DRH-118, 1m / RA42-K-F-4B-C	Performed by	Jeremy Luong

Above 1GHz Plots for Transmit Mode at 2412MHz, 802.11n HT20, 6.5Mbit/s

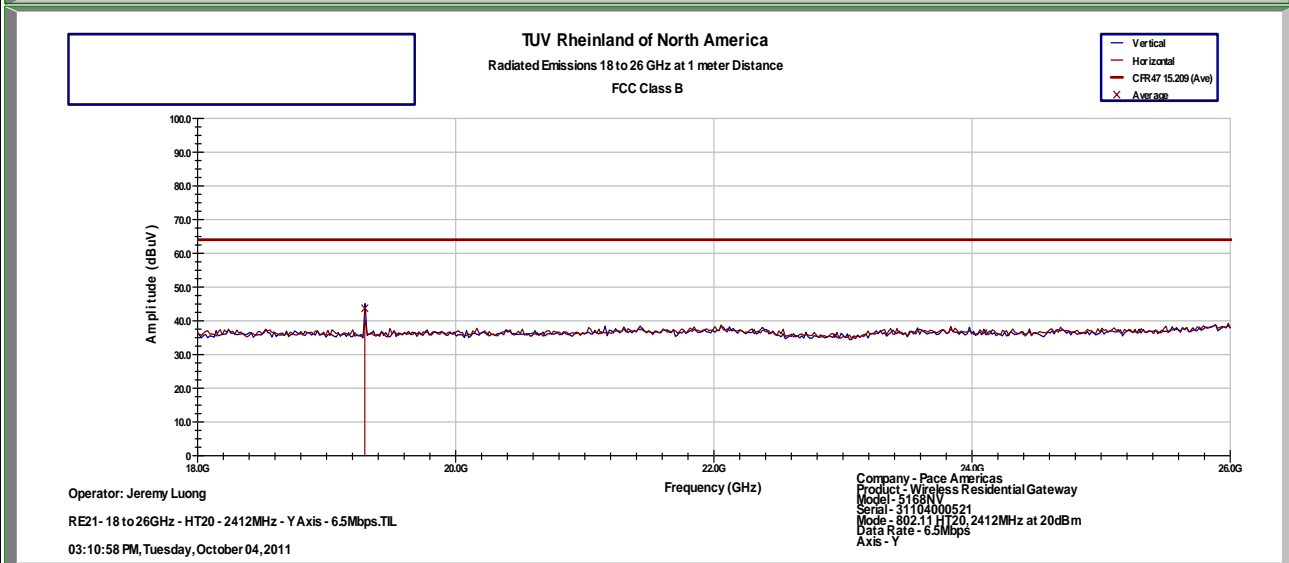
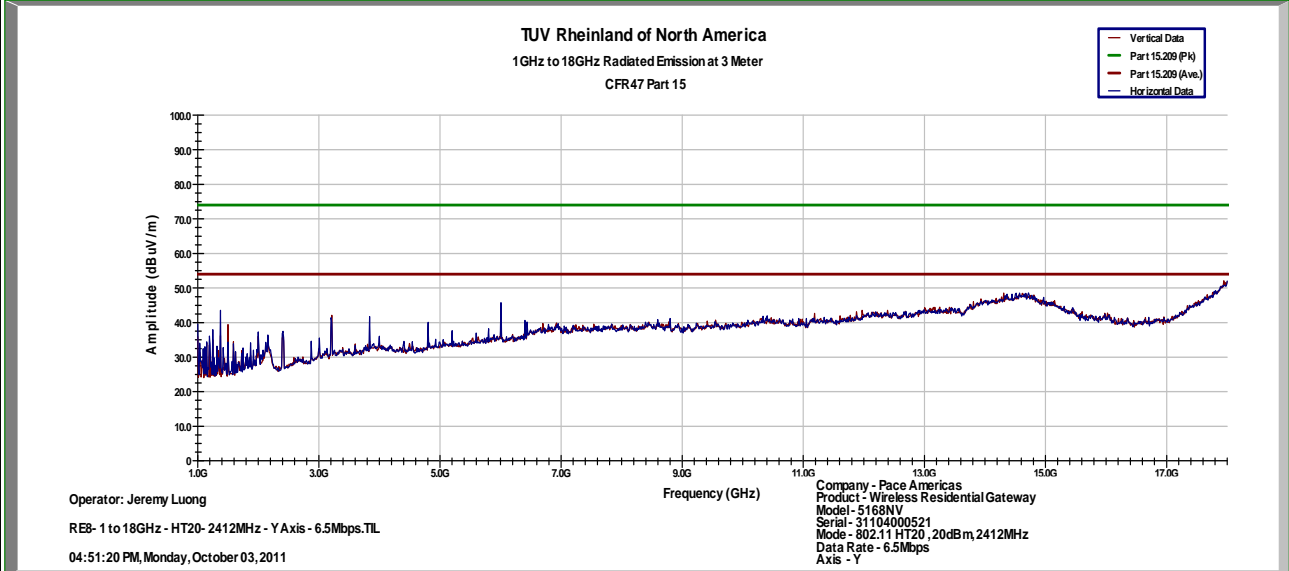

Notes: Limit was extrapolated to 1m distance for 18GHz – 25GHz range.
 1GHz – 25GHz Setting: RBW = 1MHz/ VBW = 3MHz

SOP 1 Radiated Emissions

Tracking # 31153119.001 Page 13 of 18

EUT Name	Wireless uDSL Residential Gateway	Date	October 4, 2011
EUT Model	5168NV	Temp / Hum in	23°C / 49%rh
EUT Serial	31104000521	Temp / Hum out	N/A
EUT Config.	802.11 HT20, 6.5Mbps at Y-Axis (above 1GHz)	Line AC / Freq	120Vac/60Hz
Standard	CFR47 Part 15 Subpart C	RBW / VBW	1MHz / 3MHz
Dist/Ant Used	3m / DRH-118, 1m / RA42-K-F-4B-C	Performed by	Jeremy Luong

Above 1GHz Plots for Transmit Mode at 2437MHz, 802.11n HT20, 6.5Mbit/s

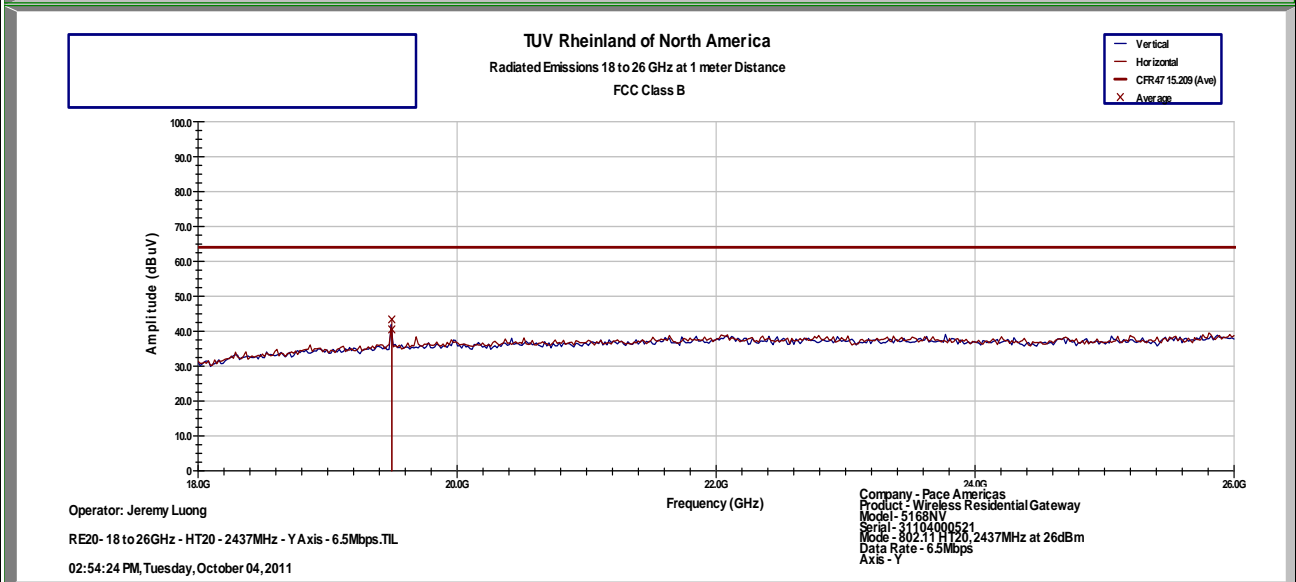
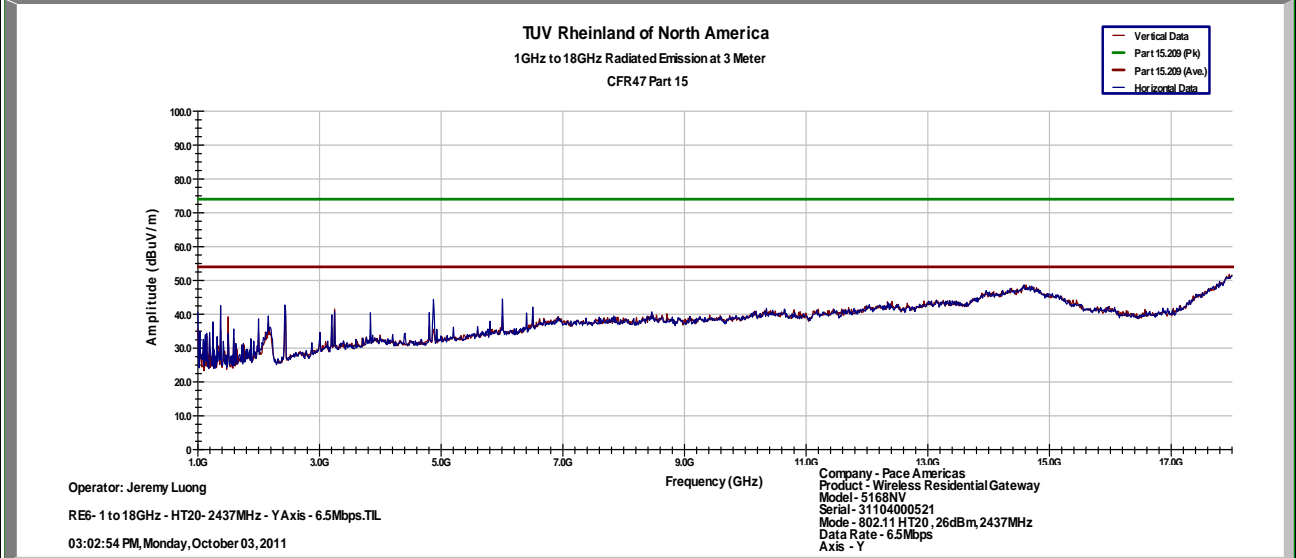

Notes: Limit was extrapolated to 1m distance for 18GHz – 25GHz range.
 1GHz – 25GHz Setting: RBW = 1MHz/ VBW = 3MHz

SOP 1 Radiated Emissions

Tracking # 31153119.001 Page 14 of 18

EUT Name	Wireless uDSL Residential Gateway	Date	October 4, 2011
EUT Model	5168NV	Temp / Hum in	23°C / 49%rh
EUT Serial	31104000521	Temp / Hum out	N/A
EUT Config.	802.11 HT20, 6.5Mbps at Y-Axis (above 1GHz)	Line AC / Freq	120Vac/60Hz
Standard	CFR47 Part 15 Subpart C	RBW / VBW	1MHz / 3MHz
Dist/Ant Used	3m / DRH-118, 1m / RA42-K-F-4B-C	Performed by	Jeremy Luong

Above 1GHz Plots for Transmit Mode at 2462MHz, 802.11n HT20, 6.5Mbit/s

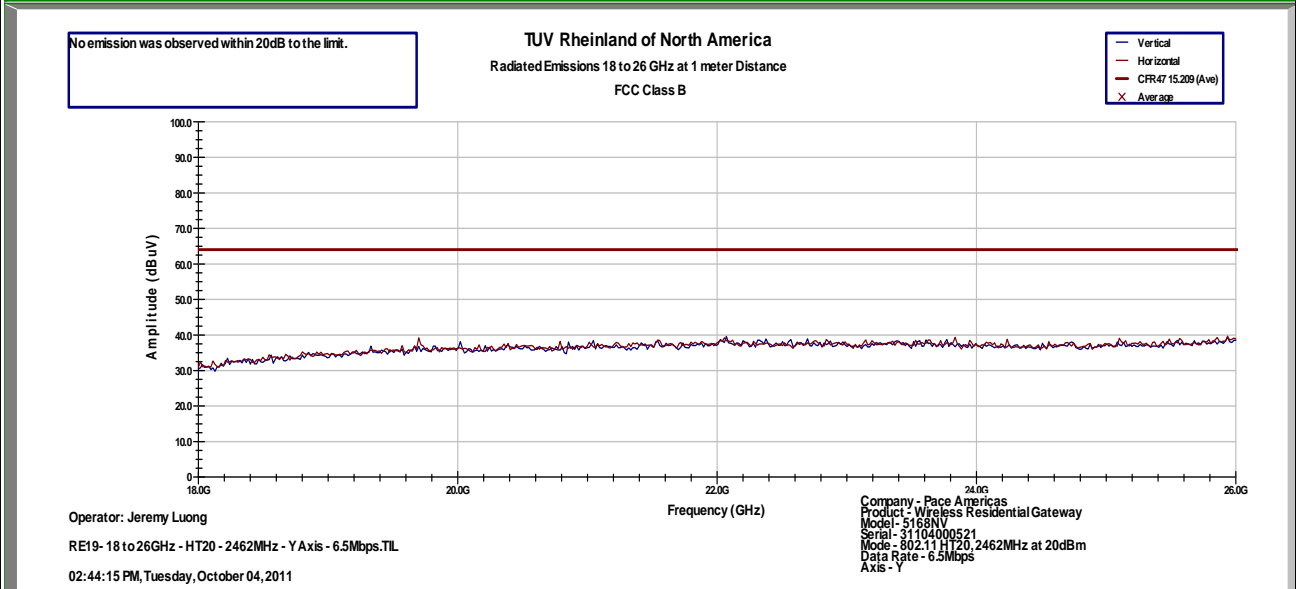
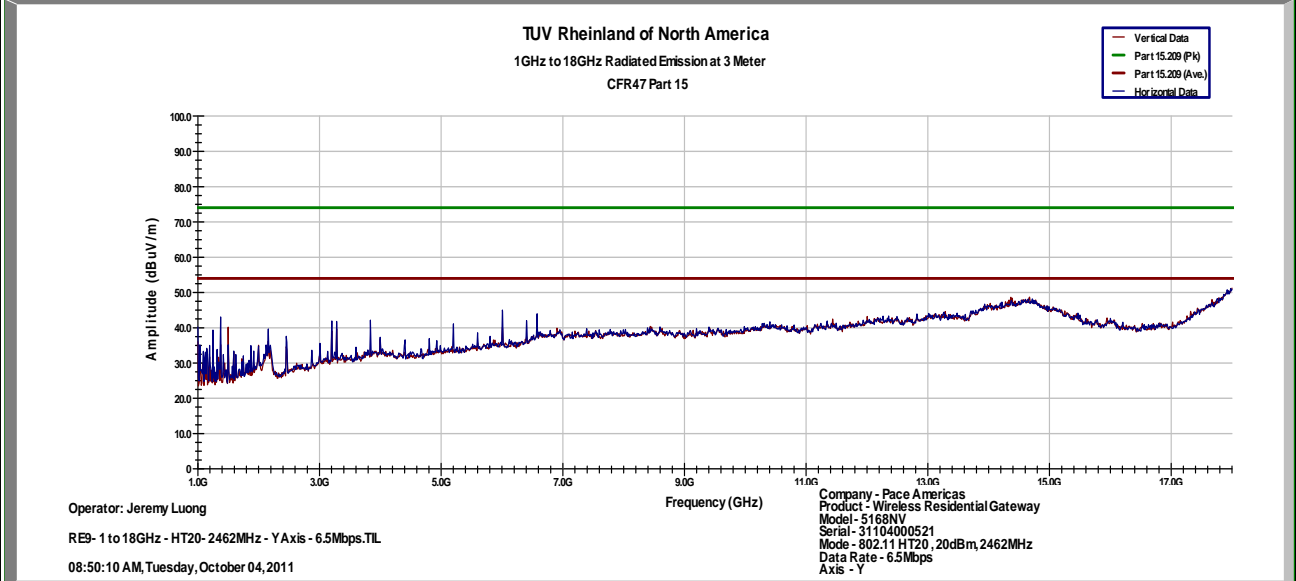

Notes: Limit was extrapolated to 1m distance for 18GHz – 25GHz range.
 1GHz – 25GHz Setting: RBW = 1MHz/ VBW = 3MHz

SOP 1 Radiated Emissions							Tracking # 31153119.001 Page 15 of 18			
EUT Name	Wireless uDSL Residential Gateway					Date	October 4, 2011			
EUT Model	5168NV					Temp / Hum in	23°C / 49%rh			
EUT Serial	31104000521					Temp / Hum out	N/A			
EUT Config.	802.11 HT40, 13.5Mbps at Y-Axis (above 1GHz)					Line AC / Freq	120Vac/60Hz			
Standard	CFR47 Part 15 Subpart C					RBW / VBW	1MHz / 3MHz			
Dist/Ant Used	3m / DRH-118, 1m / RA42-K-F-4B-C					Performed by	Jeremy Luong			
Emission Freq (MHz)	ANT Polar (H/V)	ANT Pos (cm)	Table Pos (deg)	FIM (Pk) (dBuV/m)	FIM Ave. (dBuV/m)	Total CF (dBuV)	E-Field Pk/Ave. (dBuV/m)	Spec Limit (dBuV/m)	Spec Margin (dB)	Type
Transmitted Data at 2422MHz at 802.11n HT40, 13.5Mbit/s , 1 Streams										
1374.89	H	160	115	49.72	43.58	-7.54	36.04	53.98	-17.94	Restricted
2080.08	H	196	441	45.08	36.62	-4.59	32.03	53.98	-21.95	Unrestricted
3200.04	H	110	131	40.79	34.74	-0.01	34.73	53.98	-19.25	Unrestricted
3229.42	H	106	65	43.94	40.47	0.06	40.53	53.98	-13.45	Unrestricted
3229.43	V	256	453	43.92	41.03	0.06	41.08	53.98	-12.90	Unrestricted
3840.08	H	130	50	42.03	38.45	1.76	40.21	53.98	-13.77	Restricted
4835.24	V	107	309	36.84	22.58	2.47	25.05	53.98	-28.93	Unrestricted
6000.06	H	220	52	41.30	37.35	5.14	42.49	53.98	-11.49	Unrestricted
19376.10	V	108	156	38.75	32.61	11.32	43.93	63.98	-20.05	Restricted
Transmitted Data at 2437MHz at 802.11n HT40, 13.5Mbit/s , 1 Streams										
1374.90	H	159	113	53.57	48.13	-7.54	40.59	53.98	-13.39	Restricted
2080.11	H	149	439	50.31	43.00	-4.59	38.41	53.98	-15.57	Unrestricted
3199.99	H	173	139	44.07	38.76	-0.01	38.75	53.98	-15.23	Unrestricted
3249.38	H	183	41	44.11	40.93	0.11	41.04	53.98	-12.94	Unrestricted
3249.43	V	224	92	43.95	39.73	0.11	39.84	53.98	-14.14	Unrestricted
4874.13	H	138	326	36.84	22.94	2.52	25.46	53.98	-28.52	Restricted
6000.06	H	171	54	42.27	37.50	5.14	42.64	53.98	-11.34	Unrestricted
19496.10	H	107	464	34.99	28.83	11.55	40.38	63.98	-23.60	Restricted
19496.10	V	107	160	36.59	32.38	11.55	43.93	63.98	-20.05	Restricted
Transmitted Data at 2452MHz at 802.11n HT40, 13.5Mbit/s , 1 Streams										
1374.89	H	93	119	49.90	44.22	-7.54	36.68	53.98	-17.30	Restricted
2080.06	H	110	442	45.55	37.33	-4.59	32.74	53.98	-21.24	Unrestricted
3200.12	H	114	96	41.22	35.26	-0.01	35.25	53.98	-18.73	Unrestricted
3269.43	H	214	74	40.67	36.71	0.18	36.89	53.98	-17.09	Restricted
3840.11	H	109	46	40.66	37.04	1.76	38.80	53.98	-15.18	Restricted
4904.09	H	117	470	35.82	22.48	2.50	24.98	53.98	-29.00	Restricted
6000.08	H	202	412	41.17	37.06	5.14	42.20	53.98	-11.78	Unrestricted
Spec Margin = E-Field Ave. - Limit, E-Field Ave. = FIM Ave. + Total CF ± Uncertainty Total CF= Amp Gain + Cable Loss + ANT Factor										
Combined Standard Uncertainty $u_c(y) = \pm 3.2\text{dB}$ Expanded Uncertainty $U = ku_c(y)$ $k = 2$ for 95% confidence										
Notes: All emissions passed the spurious emission limit.										

SOP 1 Radiated Emissions

Tracking # 31153119.001 Page 16 of 18

EUT Name	Wireless uDSL Residential Gateway	Date	October 4, 2011
EUT Model	5168NV	Temp / Hum in	23°C / 49%rh
EUT Serial	31104000521	Temp / Hum out	N/A
EUT Config.	802.11 HT40, 13.5Mbps at Y-Axis (above 1GHz)	Line AC / Freq	120Vac/60Hz
Standard	CFR47 Part 15 Subpart C	RBW / VBW	1MHz / 3MHz
Dist/Ant Used	3m / DRH-118, 1m / RA42-K-F-4B-C	Performed by	Jeremy Luong

Above 1GHz Plots for Transmit Mode at 2422MHz, 802.11n HT40, 13.5Mbit/s

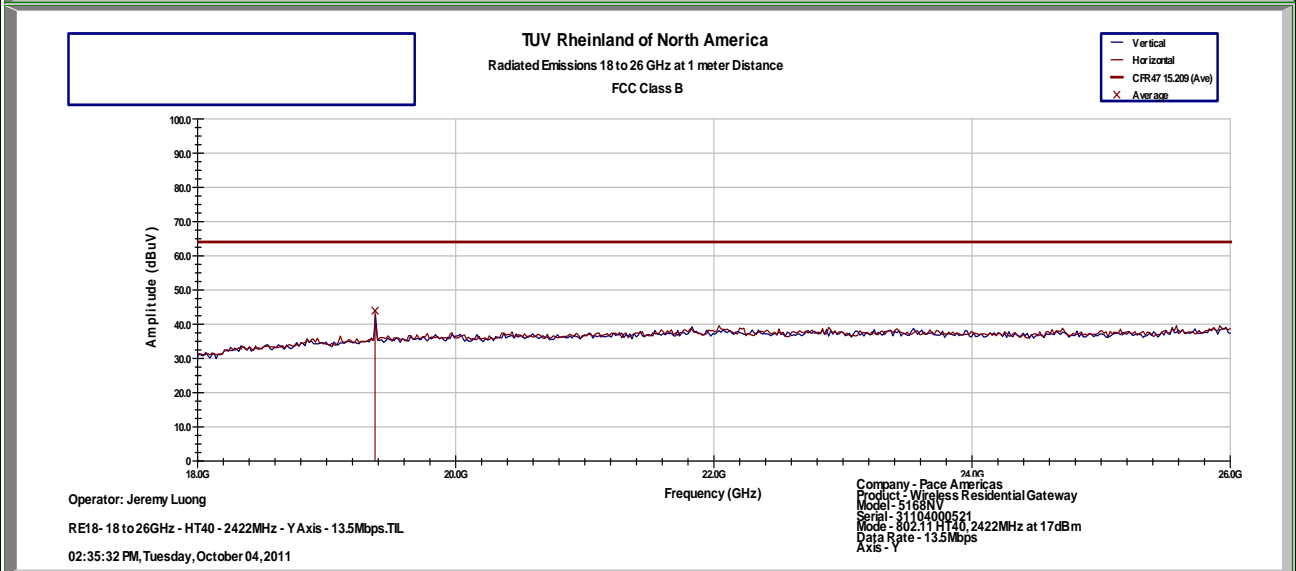
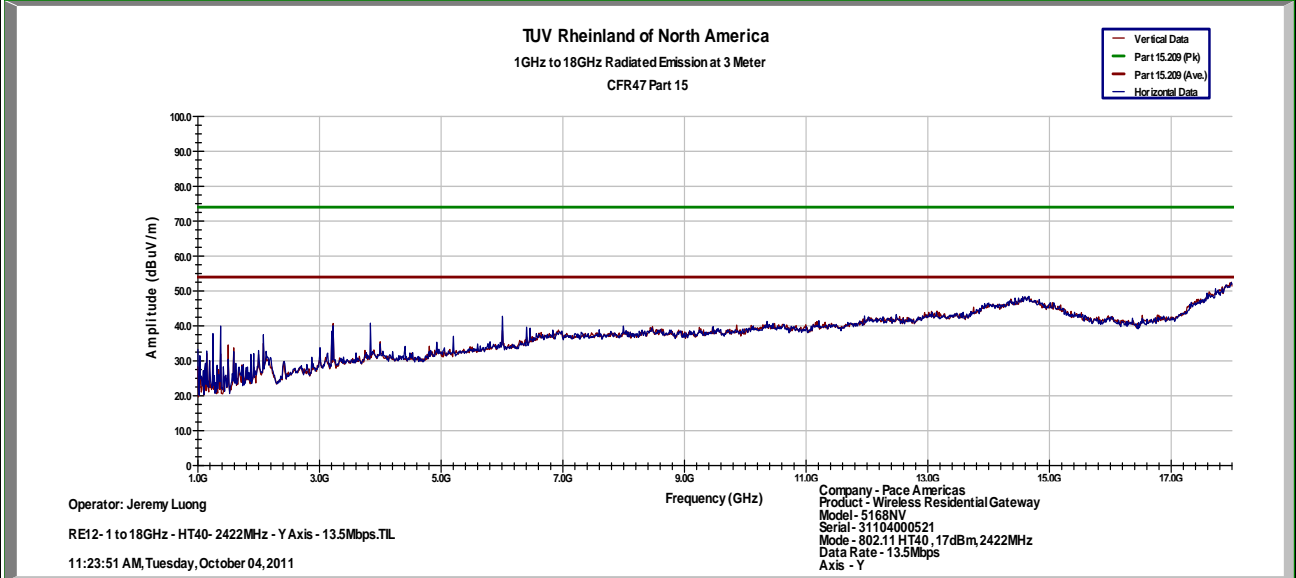

Notes: Limit was extrapolated to 1m distance for 18GHz – 25GHz range.
 1GHz – 25GHz Setting: RBW = 1MHz/ VBW = 3MHz

SOP 1 Radiated Emissions

Tracking # 31153119.001 Page 17 of 18

EUT Name	Wireless uDSL Residential Gateway	Date	October 4, 2011
EUT Model	5168NV	Temp / Hum in	23°C / 49%rh
EUT Serial	31104000521	Temp / Hum out	N/A
EUT Config.	802.11 HT40, 13.5Mbps at Y-Axis (above 1GHz)	Line AC / Freq	120Vac/60Hz
Standard	CFR47 Part 15 Subpart C	RBW / VBW	1MHz / 3MHz
Dist/Ant Used	3m / DRH-118, 1m / RA42-K-F-4B-C	Performed by	Jeremy Luong

Above 1GHz Plots for Transmit Mode at 2437MHz, 802.11n HT40, 13.5Mbit/s

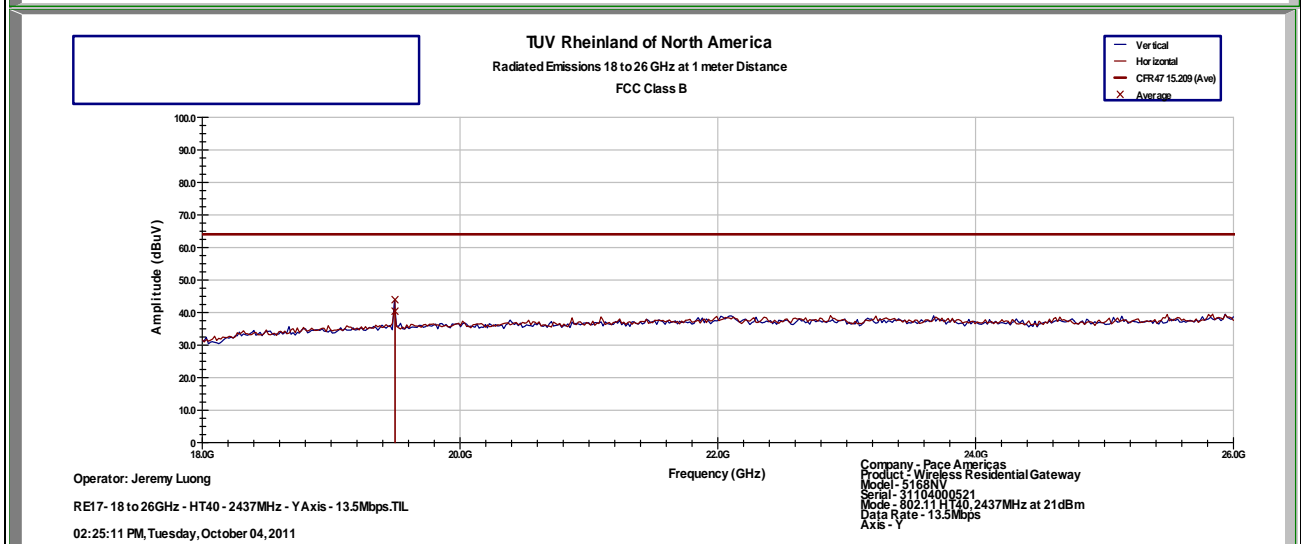
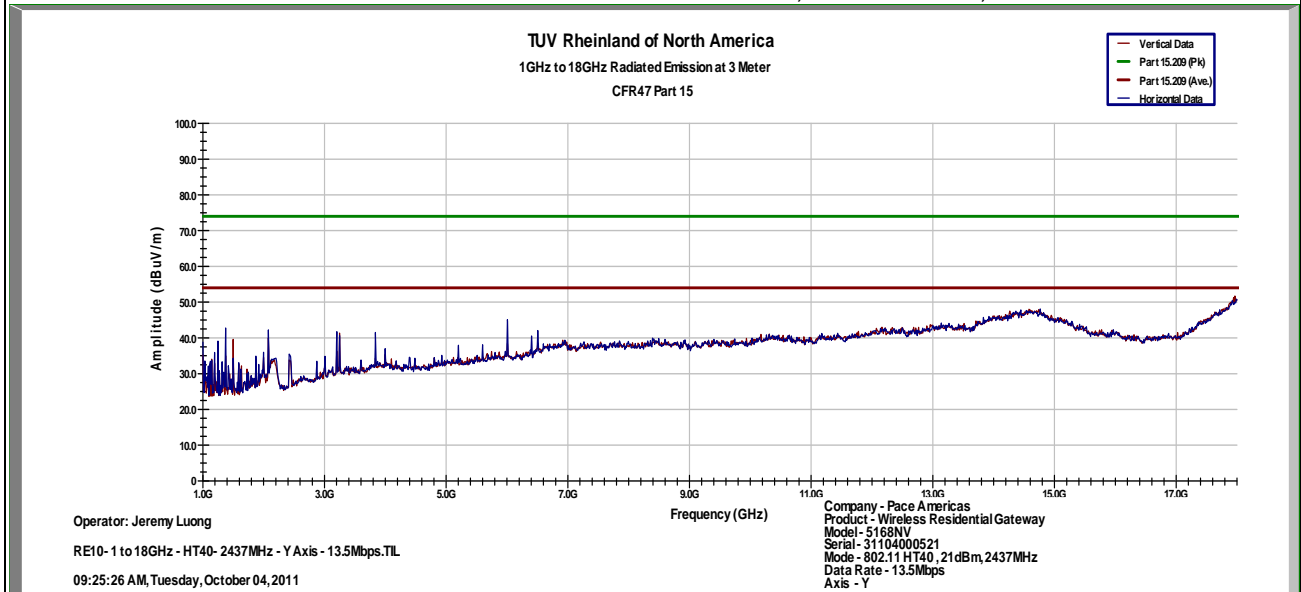

Notes: Limit was extrapolated to 1m distance for 18GHz – 25GHz range.
 1GHz – 25GHz Setting: RBW = 1MHz/ VBW = 3MHz

SOP 1 Radiated Emissions

Tracking # 31153119.001 Page 18 of 18

EUT Name	Wireless uDSL Residential Gateway	Date	October 4, 2011
EUT Model	5168NV	Temp / Hum in	23°C / 49%rh
EUT Serial	31104000521	Temp / Hum out	N/A
EUT Config.	802.11 HT40, 13.5Mbps at Y-Axis (above 1GHz)	Line AC / Freq	120Vac/60Hz
Standard	CFR47 Part 15 Subpart C	RBW / VBW	1MHz / 3MHz
Dist/Ant Used	3m / DRH-118, 1m / RA42-K-F-4B-C	Performed by	Jeremy Luong

Above 1GHz Plots for Transmit Mode at 2452MHz, 802.11n HT40, 13.5Mbit/s

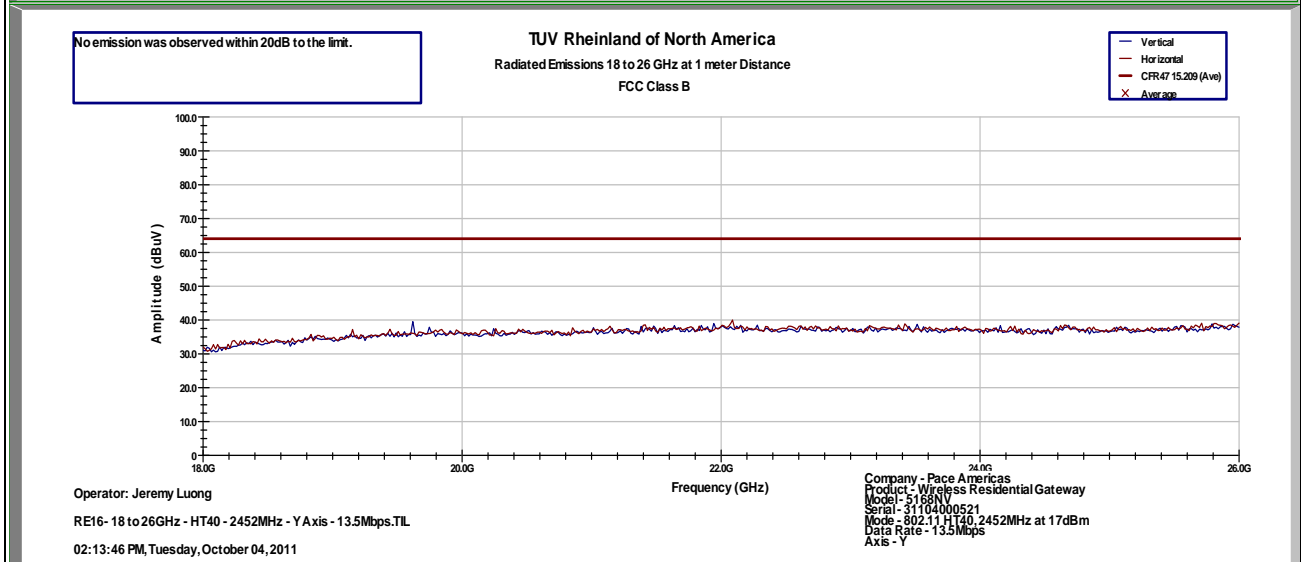
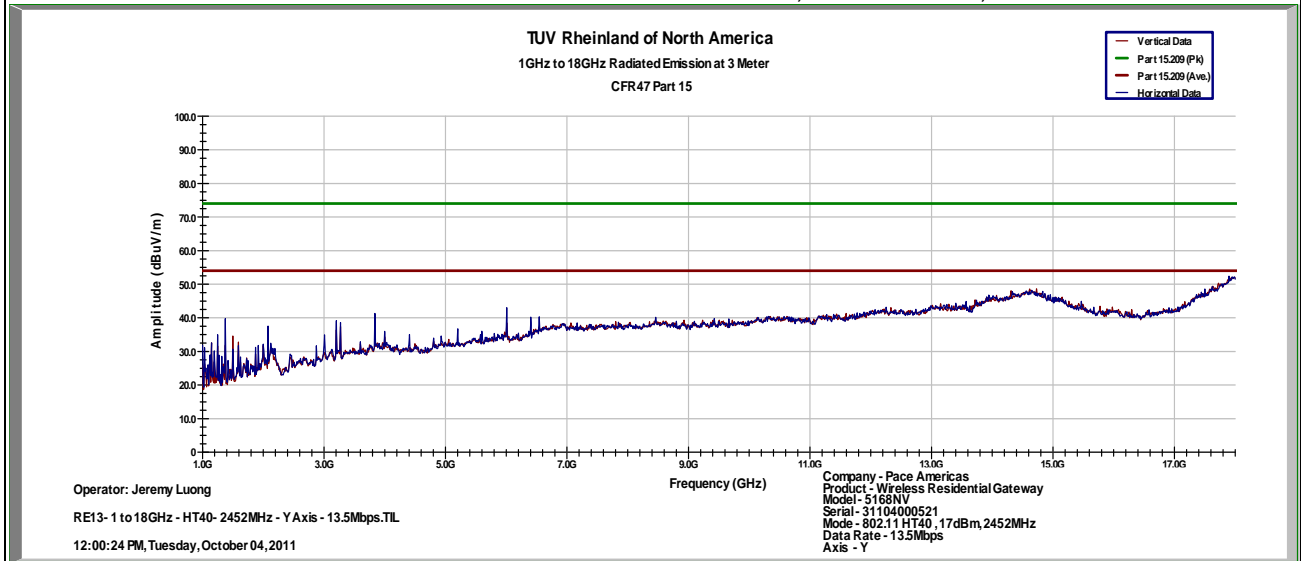

Notes: Limit was extrapolated to 1m distance for 18GHz – 25GHz range.
 1GHz – 25GHz Setting: RBW = 1MHz/ VBW = 3MHz

4.6.4 Sample Calculation

The field strength is calculated by subtracting the Amplifier Gain and adding the Cable Loss and Antenna Correction Factor to the measured reading. The basic equation is as follows:

$$\text{Field Strength (dB}\mu\text{V/m)} = \text{FIM} - \text{AMP} + \text{CBL} + \text{ACF}$$

Where: FIM = Field Intensity Meter (dB μ V)
AMP = Amplifier Gain (dB)
CBL = Cable Loss (dB)
ACF = Antenna Correction Factor (dB/m)

$$\mu\text{V/m} = 10^{\frac{\text{dB}\mu\text{V/m}}{20}}$$

4.7 Receiver Spurious Emissions

Receiver spurious emissions are emissions at any frequency when the equipment is in receive mode.

The spurious emissions of the receiver shall not exceed the values in CFR47 Part 15.109 and RSS 210 Sect 2.7.

4.7.1 Test Methodology

4.7.1.1 Preliminary Test

A test program that controls instrumentation and data logging was used to automate the preliminary RF emission test procedure. The frequency range of interest was divided into sub-ranges to yield a frequency resolution of approximately 120 kHz and provide a reading at each frequency for no more than 12° of turntable rotation. For each frequency sub-range the turntable was rotated 360° while peak emission data was recorded and plotted over the frequency range of interest in horizontal and vertical antenna polarization's.

Preliminary emission profile testing was performed inside the anechoic chamber. The EUT was placed on a 1.0m x 1.5m non-conductive table 80cm above the floor. The EUT was positioned as shown in the setup photographs. The receiving antenna was placed at a distance of 3m at a fixed height of 1m. Measurement equipment was located outside of the chamber. A video camera was placed inside the chamber to view the EUT.

Preliminary scans performed with EUT positioned horizontal and vertically. Horizontal position was worse.

4.7.1.2 Final Test

For each frequency measured, the peak emission was maximized by manipulating the receiving antenna from 1 to 4 meters above the ground plane and placing it at the position that produced the maximum signal strength reading. The turntable was then rotated through 360° while observing the peak signal and placing the EUT at the position that produced maximum radiation. The six highest emissions relative to the limit were measured unless such emissions were more than 20 dB below the limit. If less than six emissions are within 20 dB of the limit, than the noise level of the receiver is measured at frequencies where emissions are expected. Multiples of all oscillator and microprocessor frequencies were also checked.

Final testing was performed on an NSA compliant test site. The EUT was placed on a 1.0m x 1.5m non-conductive table 80cm above the ground plane. The placement of EUT and cables were the same as for preliminary testing and is shown in the setup photographs.

The final scans performed on Channel 6; 2437 MHz with EUT positioned Vertically.

4.7.1.3 Deviations

None.

4.7.2 Receiver Spurious Emission Limit

The spurious emissions of the receiver shall not exceed the values in CFR47 Part 15.205, 15.209: 2010 and RSS 210 A1.1.2 2010.

Frequency (MHz)	Field strength (microvolts/meter)	Measurement distance (meters)
0.009-0.490.....	2400/F(kHz)	300
0.490-1.705.....	24000/F(kHz)	30
1.705-30.0.....	30	30
30-88.....	100 **	3
88-216.....	150 **	3
216-960.....	200 **	3
Above 960.....	500	3

4.7.3 Test Results

The final measurement data indicates the worst case operating modes, configurations, and/or cable positions. It also reflects the results including any modifications and/or special accessories listed in Sections 1.4 and 1.5.

As originally tested, the EUT was found to be compliant to the requirements of the test standard(s).

4.7.3.1 Final Data

The data recorded in this section contains the final results under the worst-case conditions and without any modifications or special accessories implemented as the manufacturer intends.

SOP 1 Radiated Emissions											Tracking # 31153119.001 Page 1 of 4	
EUT Name	Wireless uDSL Residential Gateway						Date	October 5, 2011				
EUT Model	5168NV						Temp / Hum in	22° C / 42% rh				
EUT Serial	31104000521						Temp / Hum out	N/A				
EUT Config.	RX on Y-Axis						Line AC / Freq	120Vac 60Hz				
Standard	CFR47 Part 15 Subpart C						RBW / VBW	120kHz / 300kHz				
Dist/Ant Used	3m / JB3						Performed by	Jeremy Luong				
Emission Freq (MHz)	ANT Polar (H/V)	ANT Pos (cm)	Table Pos (Deg)	FIM (Pk) Pk (dBuV/m)	FIM QP (dBuV/m)	Total CF (dBuV)	E-Field QP (dBuV/m)	Spec Limit (dBuV/m)	Spec Margin (dB)	Type		
Receive Mode at 2437 MHz												
319.97	H	116	114	47.82	47.49	-10.05	37.44	46.02	-8.58	Spurious		
500.01	H	169	136	48.89	48.68	-7.17	41.51	46.02	-4.51	Spurious		
720.01	H	102	124	42.45	42.06	-3.56	38.50	46.02	-7.52	Spurious		
800.00	H	102	113	45.74	45.18	-2.42	42.76	46.02	-3.26	Spurious		
874.87	H	143	159	37.53	36.58	-1.44	35.14	46.02	-10.88	Spurious		
99.99	V	110	291	52.11	51.09	-15.71	35.38	43.52	-8.14	Spurious		
439.98	V	113	95	50.01	48.93	-8.47	40.46	46.02	-5.56	Spurious		
480.03	V	111	321	50.01	49.07	-7.61	41.46	46.02	-4.56	Spurious		
500.00	V	115	88	48.02	47.98	-7.57	40.41	46.02	-5.61	Spurious		
560.01	V	106	280	48.08	47.92	-6.73	41.19	46.02	-4.83	Spurious		
640.00	V	107	322	45.30	45.08	-5.47	39.61	46.02	-6.41	Spurious		
Spec Margin = E-Field QP - Limit, E-Field QP = FIM QP+ Total CF ± Uncertainty												
Total CF= Amp Gain + Cable Loss + ANT Factor												
Combined Standard Uncertainty $u_c(y) = \pm 1.6\text{dB}$ Expanded Uncertainty $U = ku_c(y)$ $k = 2$ for 95% confidence												
Notes: RX mode at 2437MHz												

SOP 1 Radiated Emissions											Tracking # 31153119.001 Page 2 of 4	
EUT Name	Wireless uDSL Residential Gateway						Date	October 4, 2011				
EUT Model	5168NV						Temp / Hum in	22° C / 49% rh				
EUT Serial	31104000521						Temp / Hum out	N/A				
EUT Config.	RX on Y-Axis						Line AC / Freq	120Vac/60Hz				
Standard	Wireless uDSL Residential Gateway						RBW / VBW	1MHz / 3MHz				
Dist/Ant Used	3m / DRH-118, 1m / RA42-K-F-4B-C						Performed by	Jeremy Luong				
Emission Freq (MHz)	ANT Polar (H/V)	ANT Pos (cm)	Table Pos (Deg)	FIM (Pk) (dBuV/m)	FIM Ave (dBuV/m)	Total CF (dBuV)	E-Field Ave (dBuV/m)	Spec Limit (dBuV/m)	Spec Margin (dB)	Type		
Transmitted Data at 2437 MHz												
2400.12	H	191	106	50.07	39.37	-2.94	36.43	53.98	-17.55	Spurious		
3200.11	H	166	468	41.11	35.51	-0.01	35.50	53.98	-18.48	Spurious		
3840.05	H	156	40	42.30	38.82	1.75	40.57	53.98	-13.41	Spurious		
5200.06	H	153	388	38.87	31.99	3.70	35.69	53.98	-18.29	Spurious		
6000.11	H	138	55	40.90	36.74	5.14	41.88	53.98	-12.10	Spurious		
6538.79	H	151	394	38.45	32.40	6.24	38.64	53.98	-15.34	Spurious		
Spec Margin = E-Field Ave - Limit, E-Field Ave = FIM Ave+ Total CF ± Uncertainty												
Total CF= Amp Gain + Cable Loss + ANT Factor												
Combined Standard Uncertainty $u_c(y) = \pm 1.6$ dB Expanded Uncertainty $U = k u_c(y)$ $k = 2$ for 95% confidence												
Notes RX mode at 2437MHz												

SOP 1 Radiated Emissions

Tracking # 31153119.001 Page 3 of 4

EUT Name	Wireless uDSL Residential Gateway	Date	October 5, 2011
EUT Model	5168NV	Temp / Hum in	22° C / 41% rh
EUT Serial	31104000521	Temp / Hum out	N/A
EUT Config.	RX on Y-Axis	Line AC / Freq	120Vac 60Hz
Standard	CFR47 Part 15 Subpart C	RBW / VBW	120kHz / 300kHz
Dist/Ant Used	3m / JB3	Performed by	Jeremy Luong

30 MHz to 1000 MHz Plot for Receive Mode at 2437 MHz

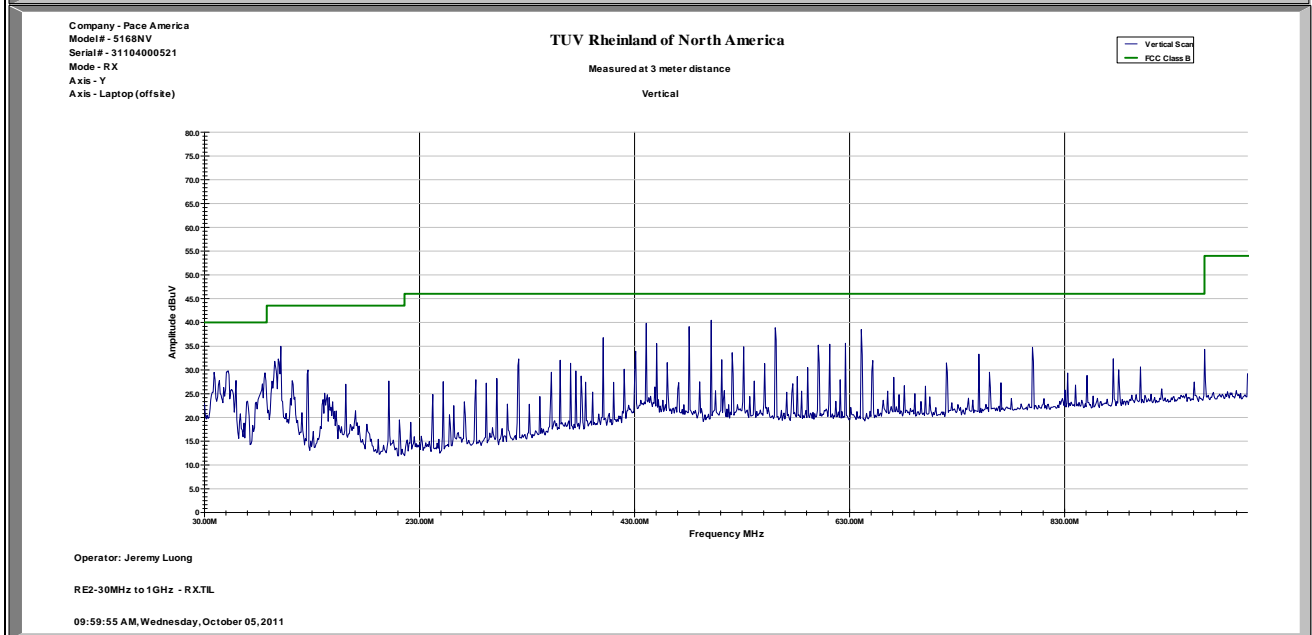
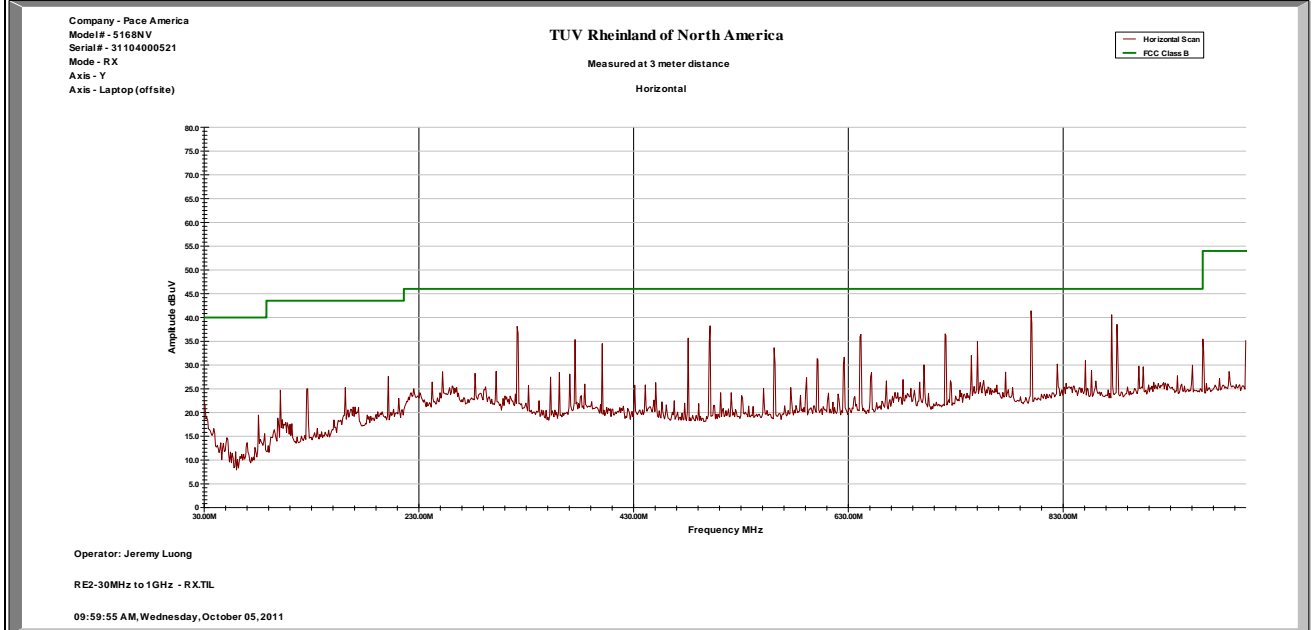

Notes: None.

SOP 1 Radiated Emissions

Tracking # 31153119.001 Page 4 of 4

EUT Name	Wireless uDSL Residential Gateway	Date	October 4, 2011
EUT Model	5168NV	Temp / Hum in	22° C / 49% rh
EUT Serial	31104000521	Temp / Hum out	N/A
EUT Config.	RX on Y-Axis	Line AC / Freq	120Vac/60Hz
Standard	Wireless uDSL Residential Gateway	RBW / VBW	1MHz / 3MHz
Dist/Ant Used	3m / DRH-118, 1m / RA42-K-F-4B-C	Performed by	Jeremy Luong

1 GHz to 25 GHz Plot for Receive Mode at 2437 MHz

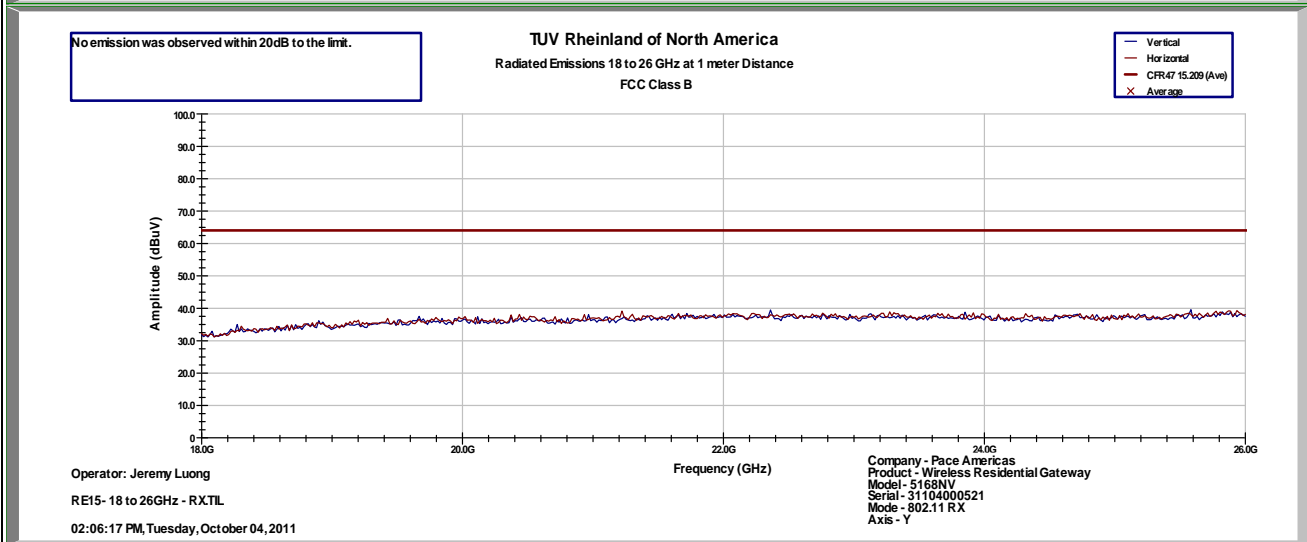
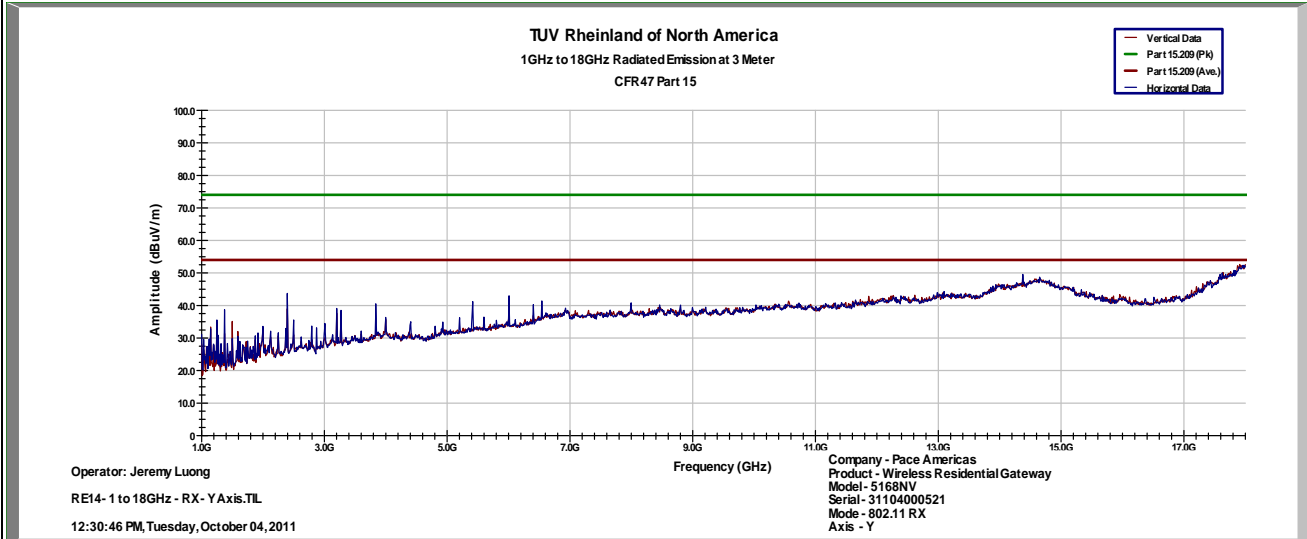

Notes: None

4.8 AC Conducted Emissions

Testing was performed in accordance with ANSI C63.4: 2009. These test methods are listed under the laboratory's NVLAP Scope of Accreditation.

This test measures the levels emanating from the EUT's AC input port, thus evaluating the potential for the EUT to cause radio frequency interference to other electronic devices.

The AC conducted emissions of equipment under test shall not exceed the values in CFR47 Part 15.207: 2010 and RSS 210: 2010.

4.8.1 Test Methodology

A test program that controls instrumentation and data logging was used to automate the AC Power Line Conducted emission test procedure. The frequency range of interest was divided into sub-ranges such as to yield a frequency resolution of 9 kHz. Each phase and neutral of the AC power line were measured with respect to ground. Measurements were performed using a set of 50 μ H / 50 Ω LISNs.

Testing is either performed in 5m Chamber. The setup photographs clearly identify which site was used. The vertical ground plane used in the semi-anechoic chamber is a 2m x 2m solid aluminum frame and panel, and it is bonded to the horizontal ground plane.

In the case of tabletop equipment, the EUT is placed on a 1.0m x 1.5m non-conductive table 80cm above the ground plane and 40cm from a vertical ground reference plane. The rear of the EUT was positioned flush with the backside of the table and directly over the LISNs. The power and I/O cables were routed over the edge of the table and bundled approximately 40cm from the ground plane. Support equipment was powered from a separate LISN.

4.8.1.1 Deviations

There were no deviations from this test methodology.

4.8.2 Test Results

As originally tested, the EUT was found to be compliant to the requirements of the test standard(s).

Table 10: AC Conducted Emissions – Test Results

Test Conditions: Conducted Measurement at Normal Conditions only		
Antenna Type: Attached	Power Level: +26dBm at 2437MHz	
AC Power: 120 Vac/60 Hz	Configuration: Tabletop	
Ambient Temperature: 23° C	Relative Humidity: 45% RH	
Configuration	Frequency Range	Test Result
Line 1 (Hot)	0.15 to 30 MHz	Pass
Line 2 (Neutral)	0.15 to 30 MHz	Pass

SOP 2 Conducted Emissions				Tracking # 31153119.001 Page 1 of 4		
EUT Name	Wireless uDSL Residential Gateway			Date	October 5, 2011	
EUT Model	5168NV			Temp / Hum in	23° C / 45% rh	
EUT Serial	31104000521			Temp / Hum out	N/A	
EUT Config.	Attached Antenna			Line AC / Freq	120Vac/60Hz	
Standard	CFR47 Part 15.207			RBW / VBW	9kHz / 30kHz	
Lab/LISN	5m Chamber / L1-200, Line 1			Performed by	Jeremy Luong	
Frequency MHz	Quasi-Peak dBuV	QP Limit dBuV	QP Margin dB	Average dBuV	Ave Limit dBuV	Ave Margin dB
0.1506	45.26	26.53	65.98	55.98	-20.72	-29.45
0.1530	44.78	27.75	65.91	55.91	-21.13	-28.17
0.1820	35.88	24.10	65.09	55.09	-29.21	-30.99
0.2650	30.11	25.74	62.71	52.71	-32.60	-26.97
0.3367	35.81	28.51	60.67	50.67	-24.86	-22.16
0.4135	37.39	31.95	58.47	48.47	-21.08	-16.52
0.5191	30.47	19.21	56.00	46.00	-25.53	-26.79
3.9704	28.91	18.87	56.00	46.00	-27.09	-27.13
4.1234	29.44	19.74	56.00	46.00	-26.56	-26.26
19.7071	28.22	27.63	60.00	50.00	-31.78	-22.37
29.2318	29.16	28.56	60.00	50.00	-30.84	-21.44
Spec Margin = QP./Ave. - Limit, ± Uncertainty						
Combined Standard Uncertainty $u_c(y) = \pm 1.2$ dB Expanded Uncertainty $U = k u_c(y)$ $k = 2$ for 95% confidence						
Notes: EUT was setup as table top equipment.						

SOP 2 Conducted Emissions

Tracking # 31153119.001 Page 2 of 4

EUT Name	Wireless uDSL Residential Gateway	Date	October 5, 2011
EUT Model	5168NV	Temp / Hum in	23° C / 45% rh
EUT Serial	31104000521	Temp / Hum out	N/A
EUT Config.	Attached Antenna	Line AC / Freq	120Vac/60Hz
Standard	CFR47 Part 15.207	RBW / VBW	9kHz / 30kHz
Lab/LISN	5m Chamber / L1-200, Line 1	Performed by	Jeremy Luong

150kHz to 30 MHz Plot for Line 1 (Hot)

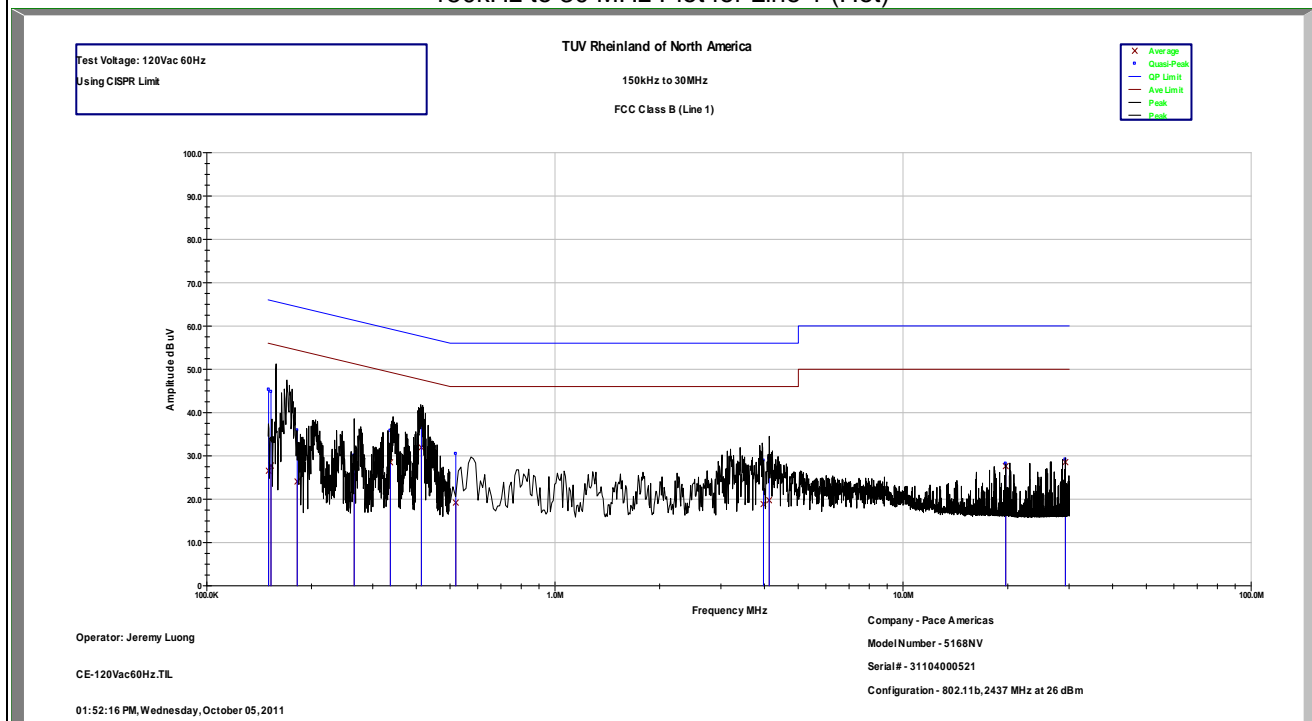

Notes: Meet FCC Class B limit.

SOP 2 Conducted Emissions				Tracking # 31153119.001 Page 3 of 4		
EUT Name	Wireless uDSL Residential Gateway			Date	October 5, 2011	
EUT Model	5168NV			Temp / Hum in	23° C / 45% rh	
EUT Serial	31104000521			Temp / Hum out	N/A	
EUT Config.	Attached Antenna			Line AC / Freq	120Vac/60Hz	
Standard	CFR47 Part 15.207			RBW / VBW	9kHz / 30kHz	
Lab/LISN	5m Chamber / L1-200, Line 2			Performed by	Jeremy Luong	
Frequency MHz	Quasi-Peak dBuV	QP Limit dBuV	QP Margin dB	Average dBuV	Ave Limit dBuV	Ave Margin dB
0.1501	46.78	28.27	66.00	56.00	-19.22	-27.73
0.1628	47.02	39.36	65.64	55.64	-18.62	-16.28
0.1630	47.54	41.30	65.63	55.63	-18.09	-14.33
0.1796	34.81	25.76	65.16	55.16	-30.35	-29.40
0.3368	34.99	27.12	60.66	50.66	-25.67	-23.55
0.4091	38.73	30.66	58.60	48.60	-19.87	-17.94
0.5160	28.65	21.17	56.00	46.00	-27.35	-24.83
1.7470	27.78	20.76	56.00	46.00	-28.22	-25.25
4.2304	26.60	18.12	56.00	46.00	-29.40	-27.88
29.2313	29.64	29.10	60.00	50.00	-30.36	-20.90
Spec Margin = QP./Ave. - Limit, ± Uncertainty						
Combined Standard Uncertainty $u_c(y) = \pm 1.2$ dB Expanded Uncertainty $U = k u_c(y)$ $k = 2$ for 95% confidence						
Notes: EUT was setup as table top equipment.						

SOP 2 Conducted Emissions

Tracking # 31153119.001 Page 4 of 4

EUT Name	Wireless uDSL Residential Gateway	Date	October 5, 2011
EUT Model	5168NV	Temp / Hum in	23° C / 45% rh
EUT Serial	31104000521	Temp / Hum out	N/A
EUT Config.	Attached Antenna	Line AC / Freq	120Vac/60Hz
Standard	CFR47 Part 15.207	RBW / VBW	9kHz / 30kHz
Lab/LISN	5m Chamber / L1-200, Line 2	Performed by	Jeremy Luong

150 kHz to 30 MHz Plot for Line 2 (Neutral)

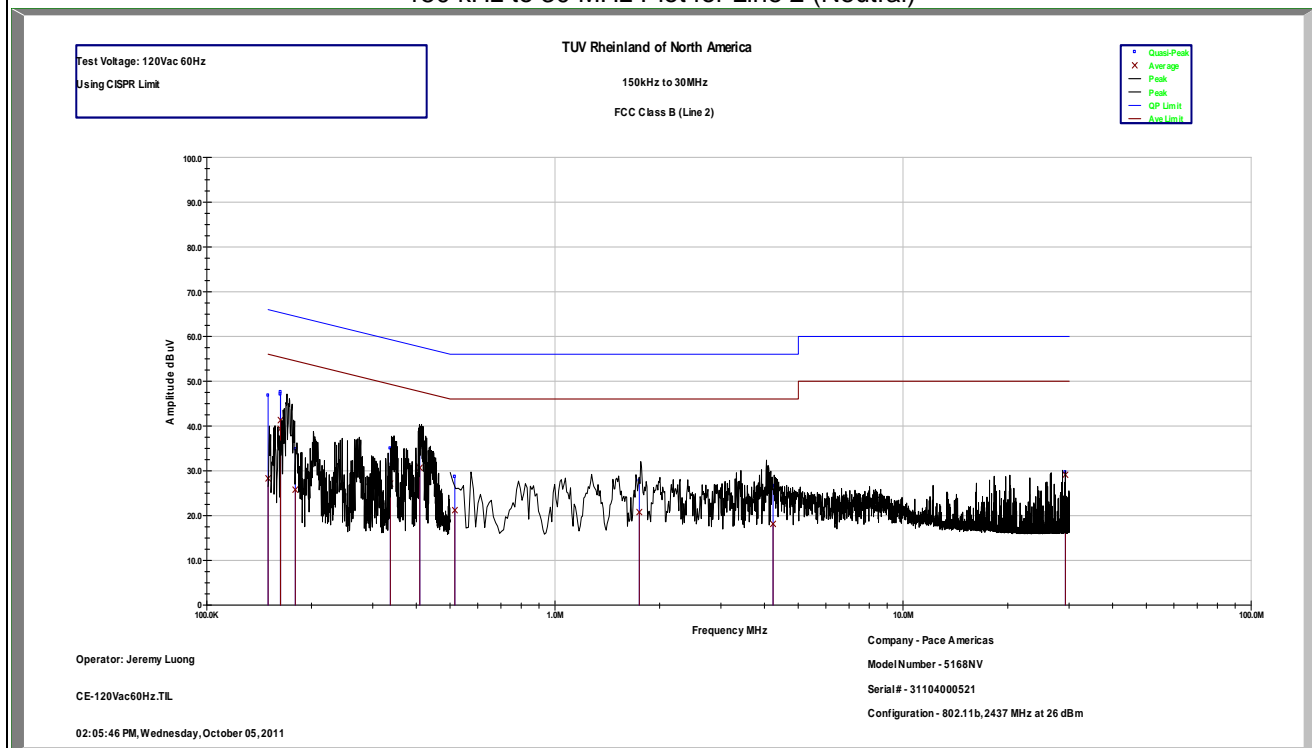

Note: Meet FCC Class B Limit.

5 Test Equipment List

5.1 Equipment List

Equipment	Manufacturer	Model #	Serial/Inst #	Last Cal dd/mm/yy	Next Cal dd/mm/yy
Bilog Antenna	Sunol Science	JB3	A102606	2/18/2010	2/18/2012
Tuned Dipole Antenna	A.H Systems, Inc.	TDS-200/535-1	154	11/10/2010	11/10/2011
Tuned Dipole Antenna	A.H Systems, Inc.	TDS-200/535-2	154	11/10/2010	11/10/2011
Tuned Dipole Antenna	A.H Systems, Inc.	TDS-200/535-3	154	11/10/2010	11/10/2011
Tuned Dipole Antenna	A.H Systems, Inc.	TDS-200/535-4	154	11/10/2010	11/10/2011
Horn Antenna	Sunol Science	DRH-118	A040806	9/29/2010	9/29/2012
Antenna (18-26GHz)	CMT	RA42-K-F-4B-C	020131-004	10/15/2010	10/15/2011
EMI Receiver	Hewlett Packard	8546A	3807A00445	2/5/2011	2/5/2012
Preselector	Hewlett Packard	85460A	3704A00407	2/5/2011	2/5/2012
Amplifier	Hewlett Packard	8447D	2944A07996	1/17/2011	1/17/2012
Spectrum Analyzer	Agilent	E4407B	SG43330468	10/5/2011	10/5/2012
Spectrum Analyzer	Rhode&Schwarz	ESIB	832427/002	1/18/2011	1/18/2012
Amplifier	Rhode&Schwarz	TS-PR18	3545.7008.03	9/29/2010	9/29/2012
Amplifier	Rhode&Schwarz	TS-PR26	100011	10/15/2010	10/15/2011
Signal Generator	Anritsu	MG3694A	42803	1/26/2011	1/26/2012
Notch Filter	Micro-Tronics	BRM50702	37	1/19/2011	1/19/2012
High Pass Filter (3.5 GHz)	Hewlett Packard	84300-80038	820004	1/19/2011	1/19/2012
High Pass Filter (8.5 GHz)	Micro-Tronics	HPM50107	4	1/19/2011	1/19/2012
Power Supplier	Kikosui	PCR8000W	CM000912	1/19/2011	1/19/2012
Digital Multimeter	Fluke	177	92780314	1/18/2011	1/18/2012
Power Meter	Agilent	E4418B	MY45103902	1/18/2011	1/18/2012
Power Sensor	Hewlett Packard	8482A	55-5131	10/27/2010	10/27/2011
EMI Receiver	Hewlett Packard	8546A	3942A00514	11/22/2010	11/22/2011
Preselector	Hewlett Packard	85460A	3704A00485	11/22/2010	11/22/2011
LISN	Com Power	L1-200	12111	5/10/2011	5/10/2012

* Calibration of equipment past due for re-calibration will be performed expeditiously. If any equipment is found to be out of tolerance at that time, affected customers will be notified accordingly.

6 EMC Test Plan

6.1 Introduction

This section provides a description of the Equipment Under Test (EUT), configurations, operating conditions, and performance acceptance criteria. It is an overview of information provided by the manufacturer so that the test laboratory may perform the requested testing.

6.2 Customer

Table 11: Customer Information

Company Name	Pace Americas
Address	310 Providence Mine Road
City, State, Zip	Nevada City, CA 95959
Country	USA
Phone	(530) 274-5440
Fax	(530) 273-6340

Table 12: Technical Contact Information

Name	Mark Rieger
E-mail	mrieger@pace.com
Phone	(530) 274-5440
Fax	(530) 273-6340

6.3 Equipment Under Test (EUT)

Table 13: EUT Specifications

EUT Specification	
Dimensions	3.1" x 9.6" x 9.7" (7.8 cm x 24.3 cm x 24.5 cm)
AC Adapter (M/N:EADP-36FB A)	Input Voltage: 100 – 240 Vac Input Current: 800 mA Output Voltage: 12 Vdc Output Current: 3.0 A
Environment	Indoor
Operating Temperature Range:	0 to 40 degrees C
Multiple Feeds:	<input type="checkbox"/> Yes and how many <input checked="" type="checkbox"/> No
Hardware Version	2701-000834-003 Ver 3 PCA (w/ XP17, XP18, XP19, XP20)
Part Number	4201-001159-000
RF Software Version	4.12L.02RC1
Operating Mode	802.11b, g, HT20, and HT40
Transmitter Frequency Band	2.412 GHz to 2.462 GHz (DSSS)
Max. Rated Power Output	See Channel Planning Table.
Power Setting @ Operating Channel	See Channel Planning Table.
Antenna Type	Attached on board
Modulation Type	<input type="checkbox"/> AM <input type="checkbox"/> FM <input checked="" type="checkbox"/> DSSS <input checked="" type="checkbox"/> OFDM <input type="checkbox"/> Other describe:
Date Rate	802.11b: 1, 2, 5.5, 11 Mbps at 1 Spatial Stream 802.11g: 6, 9, 12, 18, 24, 36, 48, 54 Mbps at 1 Spatial Stream 802.11n HT20: 1 Spatial Stream: 6.5, 13, 19.5, 26, 39, 52, 58.5, 65 Mbps 2 Spatial Streams: 13, 26, 39, 58, 78, 104, 117, 130 Mbps 802.11n HT40: 1 Spatial Stream: 13.5, 27, 40.5, 54, 81, 108, 121.5, 135 Mbps 2 Spatial Streams: 27, 54, 81, 108, 162, 216, 243, 270 Mbps
TX/RX Chain (s)	MIMO (2x2)
Directional Gain Type	<input checked="" type="checkbox"/> Uncorrelated <input checked="" type="checkbox"/> No Beam-Forming <input type="checkbox"/> Other describe:
Type of Equipment	<input checked="" type="checkbox"/> Table Top <input type="checkbox"/> Wall-mount <input type="checkbox"/> Floor standing cabinet <input type="checkbox"/> Other <i>describe</i>
Note: Chain 0 is the default antenna output when there is a only one chain active.	

Table 14: EUT Channel Power Specifications

No.	Frequency (MHz)	Target Power Value (dBm)					
		802.11b	802.11g	802.11n HT20		802.11n HT40	
				1 Stream	2 Stream	1 Stream	2 Stream
1	2412	24	20	20	17		
2	2417	25	24	23	23		
3	2422	26	26	26	23	17	17
4	2427	26	26	26	23	21	20
5	2432	26	26	26	23	21	20
6	2437	26	26	26	23	21	20
7	2442	26	26	26	23	21	20
8	2447	26	26	26	23	21	20
9	2452	26	26	26	23	17	17
10	2457	25	24	23	23		
11	2462	24	20	20	17		

Table 15: Interface Specifications

Interface Type	Cabled with what type of cable?	Is the cable shielded?	Maximum potential length of the cable?	Metallic (M), Coax (C), Fiber (F), or Not Applicable?
Ethernet	Terminated	<input checked="" type="checkbox"/> No	<input type="checkbox"/> Metric: 30m	<input checked="" type="checkbox"/> M
Ethernet (x3)	Unterminated	<input checked="" type="checkbox"/> No	<input type="checkbox"/> Metric: 30m	<input checked="" type="checkbox"/> M
DSL	Unterminated	<input checked="" type="checkbox"/> No	<input type="checkbox"/> Metric: 30 m	<input checked="" type="checkbox"/> M
Broadband	Unterminated	<input checked="" type="checkbox"/> No	<input type="checkbox"/> Metric: 30 m	<input checked="" type="checkbox"/> M
Telephone	Unterminated	<input checked="" type="checkbox"/> No	<input type="checkbox"/> Metric: 30m	<input checked="" type="checkbox"/> M
USB	Unterminated	<input checked="" type="checkbox"/> No	<input type="checkbox"/> Metric: 2.8 m	<input checked="" type="checkbox"/> M
Cable	Unterminated	<input checked="" type="checkbox"/> No	<input type="checkbox"/> Metric: 30m	<input checked="" type="checkbox"/> M

Table 16: Supported Equipment

Equipment	Manufacturer	Model	Serial	Used for
Laptop	Dell Computer	PP23LB	20336311441	Set test mode

Table 17: Description of Sample used for Testing

Device	Serial Number	Configuration	Used For
5168NV	31104000521	Radiated Sample	Radiated Emission. AC Conducted Emission
5168NV	31104000521	Conducted Sample	Output Power, Occupied Bandwidth, Conducted Spurious Emission, Peak Power Spectral Density
Note: None			

Table 18: Description of Test Configuration used for Radiated Measurement.

Device	Antenna	Mode	Setup Description
5168NV	Attached	Transmit & Receive	Tabletop. 5168NV positioned horizontally.
5168NV	Attached	Transmit & Receive	Tabletop. 5168NV positioned vertically.
Note: Test configuration was used in the preliminary testing.			

Table 19: Final Test Mode for 2400 MHz to 2483.5MHz Band

Test	802.11b	802.11g	802.11n HT20	802.11n HT40
Occupied Bandwidth	2412, 2437, 2462 MHz @ 1Mbps	2412, 2437, 2462 MHz @ 6Mbps	2412, 2437, 2462 MHz @ 1 Stream – 6.5Mbps	2422, 2437, 2452 MHz @ 1 Stream – 13.5Mbps
Output Power	2412, 2437, 2462 MHz @ 1Mbps	2412, 2437, 2462 MHz @ 6Mbps	2412, 2437, 2462 MHz @ 1 Stream – 6.5Mbps 2 Streams – 13Mbps	2422, 2437, 2452 MHz @ 1 Stream – 13.5Mbps 2 Streams – 27Mbps
Peak Power Spectral Density	2412, 2437, 2462 MHz @ 1Mbps	2412, 2437, 2462 MHz @ 6Mbps	2412, 2437, 2462 MHz @ 1 Stream – 6.5Mbps 2 Streams – 13Mbps	2422, 2437, 2452 MHz @ 1 Stream – 13.5Mbps 2 Streams – 27Mbps
Out-of-Band (-30 dBr)	2412, 2437, 2462 MHz @ 1Mbps	2412, 2437, 2462 MHz @ 6Mbps	2412, 2437, 2462 MHz @ 1 Stream – 6.5Mbps	2422, 2437, 2452 MHz @ 1 Stream – 13.5Mbps
Band-Edge (Radiated)	2412, 2417, 2437, 2457, 2462 MHz @ 1Mbps	2412, 2417, 2437, 2457, 2462 MHz @ 6Mbps	2412, 2417, 2437, 2457, 2462 MHz @ 1 Stream – 6.5Mbps 2412, 2437, 2462 MHz @ 2 Streams – 13Mbps	2422, 2437, 2452 MHz @ 1 Stream – 13.5Mbps 2 Streams – 27Mbps
Transmitted Spurious Emission	2412, 2437, 2462 MHz @ 1Mbps	2412, 2437, 2462 MHz @ 6Mbps	2412, 2437, 2462 MHz @ 1 Stream – 6.5Mbps	2422, 2437, 2457 MHz @ 1 Stream – 13.5Mbps
Received Spurious Emission	2437 MHz			
AC Conducted Emission	2437MHz @ 1Mbps			
Note:	1. All tests were pre-scanned for worst case before final testing. 2. All radiated emission performed on Y-Axis. 3. Receive Mode was tested with “wl out” command.			

6.4 Test Specifications

Testing requirements

Table 20: Test Specifications

Emissions and Immunity	
Standard	Requirement
CFR 47 Part 15.247: 2010	All
RSS 210 Iss. 8 2010	All